

AMERICAN AUDIO

MCD-110™ CD/Mp3 PLAYER



Operating Instructions



American Audio®
4295 Charter Street
Los Angeles Ca. 90058
3/05

CONTENTS

MAIN FEATURES.....	2
SAFETY PRECAUTIONS.....	3
ELECTRICAL SAFETY PRECAUTIONS.....	4
PRODUCT INFORMATION.....	5
CUSTOMER SUPPORT.....	6
SET-UP.....	7
FUNCTIONS AND CONTROLS.....	8
BASIC OPERATION	
LOADING/EJECTING DISC.....	12
SELECTING TRACKS.....	12
STARTING/STOPPING PLAYBACK.....	13
FRAME SEARCH.....	14
ADJUSTING TIME DISPLAY.....	15
MAKING PITCH CHANGES	15
CREATING LOOPS.....	17
SHUT DOWN PROCEDURES.....	18
HANDLING COMPACT DISC.....	18
WARRANTY.....	19
SPECIFICATIONS.....	20

FOR BEST CD-R DISC PLAYBACK RESULTS IN THIS CD PLAYER PLEASE FOLLOW THESE GUIDELINES:

- 1. High quality CD-R Audio discs (should conform to the standards of the Orange Book 2).**
- 2. Use a high quality bit rate when recording discs. (At least 160kbps)**
- 3. Record discs in the slowest speed possible. (i.e. 2x or 4x speed)**

MAIN FEATURES

- 8 times over sampling 1 bit D/A converter
- Auto cue
- Front Loading CD System
- Pitch Control and Bend (+/-4%, +/-8%, or +/-16%)
- +10 & -10 Track Skip Search
- Single Rackmount unit
- 1/75th second frame search
- Jog Wheel for frame search in Pause Mode and Pitch Bend in Play Mode
- 8 different speed scan (4 Forward/4 Reverse)
- Digital RCA coaxial output
- Large bright Digital Screen
- Loop
- Pitch Percentage Display
- Instant Start within 10 ms (sound is produced immediately when the PLAY button is pressed)

SAFETY PRECAUTIONS

NOTE: This CD player uses a semiconductor laser. It is recommended for use in a room at the following temperature: 41°F - 95°F / 5°C - 35°C

CAUTION:

1. Handle the power supply cord carefully. Do not damage or deform; it may cause electric shock or malfunction when used. Hold plug attachment when removing from wall outlet. Do not pull on the cord.
2. To avoid electric shock, do not open the top cover when the unit is plugged in. If problems occur with the unit, call your local American Audio® dealer.
3. Do not place metal objects or spill liquid inside the CD player. Electric shock or malfunction may occur.

The serial and model number for this unit is located on the rear panel. Please write down the numbers here and retain for future reference.

Model No. _____

Serial No. _____

NOTE: This product satisfies FCC regulations when shielded cables and connectors are used to connect the unit to other equipment. To prevent electromagnetic interference with electrical appliances such as radios and televisions, use shielded cables and connectors for connections.

CAUTION:

USE OF CONTROLS OR ADJUSTMENTS OTHER THAN THOSE SPECIFIED HEREIN MAY RESULT IN HAZARDOUS RADIATION EXPOSURE

THE COMPACT DISC PLAYER SHOULD NOT BE ADJUSTED OR REPAIRED BY ANYONE EXCEPT PROPERLY QUALIFIED SERVICE PERSONNEL.

CAUTION: TO PREVENT ELECTRIC SHOCK DO NOT USE THIS (POLARIZED) PLUG WITH AN EXTENSION CORD, RECEPTACLE, OR OTHER OUTLET UNLESS THE BLADES CAN BE CAREFULLY INSERTED TO PREVENT BLADE EXPOSURE

ATTENTION: POUR PREVENIR LES CHOCS ELECTRIQUES NE PAS UTILISER CETTE FICHE POLARISEE AVEC UN PROLONGATEUR, UNE PRISE DE COURANT OU UNE AUTRE SORTIE DE COURANT, SAUF SI LES LAMES PEUVENT ETRE INSEREES A FOND SANS EN LAISSER AUCUNE PARTIE A DECOUVERT.

WARNING: TO PREVENT FIRE OR SHOCK HAZARD, DO NOT EXPOSE THIS UNIT TO WATER OR MOISTURE

This equipment has been tested and found to comply with the limits for a Class B digital device, pursuant to Part 15 of the FCC Rules. These limits are designed to provide reasonable protection against harmful interference in a residential installation. This equipment generates, uses, and can radiate radio frequency energy and, if not installed and used in accordance with the instructions, may cause harmful interference to radio communications. However, there is no guarantee that interference will not occur in a particular installation. If this equipment does cause harmful interference to radio or television reception, which can be determined by turning the equipment off and on, the user is encouraged to try to correct the interference by one or more of the following measures:

- Reorient or relocate the receiving antenna.
- Increase the separation between the equipment and receiver.
- Connect the unit into an electrical outlet on a circuit different from that to which the receiver is connected.
- Consult the dealer or an experienced radio/TV technician for help.

ELECTRICAL SAFETY PRECAUTIONS

ELECTRICAL PRECAUTIONS



The lightning flash with arrowhead symbol, within an equilateral triangle, is intended to alert the user to the presence of uninsulated "dangerous voltage" within the product's enclosure that may be of sufficient magnitude to constitute a risk of electric shock to persons.



CAUTION: TO REDUCE THE RISK OF ELECTRIC SHOCK, DO NOT REMOVE THE COVER (OR BACK). THERE ARE NO USER SERVICEABLE PARTS INSIDE. REFER SERVICE TO YOUR AUTHORIZED AMERICAN AUDIO® SERVICE TECHNICIAN.



The exclamation point within an equilateral triangle is intended to alert the user to the presence of important operating and maintenance (servicing) instructions in the literature accompanying the appliance.

IMPORTANT SAFETY INSTRUCTIONS

READ INSTRUCTIONS — All the safety and operating instructions should be read before the product is operated.

RETAIN INSTRUCTIONS — The safety and operating instructions should be retained for future reference.

HEED WARNINGS — All warnings on the product and in the operating instructions should be adhered to.

FOLLOW INSTRUCTIONS — All operating and use instructions should be followed.

CLEANING — The product should be cleaned only with a polishing cloth or a soft dry cloth. Never clean with furniture wax, benzene, insecticides or other volatile liquids since they may corrode the cabinet.

ATTACHMENTS — Do not use attachments not recommended by the product manufacturer as they may cause hazards.

WATER AND MOISTURE — Do not use this product near water — for example, near a bathtub, wash bowl, kitchen sink, or laundry tub; in a wet basement; or near a swimming pool; and the like.

ACCESSORIES — Do not place this product on an unstable cart, stand, tripod, bracket, or table. The product may fall, causing serious injury to a child or adult, and serious damage to the product. Use only with a cart, stand, tripod, bracket, or table recommended by the manufacturer, or sold with the product. Any mounting of the product should follow the manufacturer's instructions, and should use a mounting accessory recommended by the manufacturer.

CART — A product and cart combination should be moved with care. Quick stops, excessive force, and uneven surfaces may cause the product and cart combination to overturn.



VENTILATION — Slots and openings in the cabinet are provided for ventilation and to ensure reliable operation of the product and to protect it from overheating, and these openings must not be blocked or covered. The openings should never be blocked by placing the product on a bed, sofa, rug, or other similar surface. This product should not be placed in a built-in installation such as a bookcase or rack unless proper ventilation is provided or the manufacturer's instructions have been adhered to.

POWER SOURCES — This product should be operated only from the type of power source indicated on the marking label. If you are not sure of the type of power supply to your home, consult your product dealer or local power company.

LOCATION — The appliance should be installed in a stable location.

NONUSE PERIODS — The power cord of the appliance should be unplugged from the outlet when left unused for a long period of time.

GROUNDING OR POLARIZATION

- If this product is equipped with a polarized alternating current line plug (a plug having one blade wider than the other), it will fit into the outlet only one way. This is a safety feature. If you are unable to insert the plug fully into the outlet, try reversing the plug. If the plug should still fail to fit, contact your electrician to replace your obsolete outlet. Do not defeat the safety purpose of the polarized plug.

- If this product is equipped with a three-wire grounding type plug, a plug having a third (grounding) pin, it will only fit into a grounding type power outlet. This is a safety feature. If you are unable to insert the plug into the outlet, contact your electrician to replace your obsolete outlet. Do not defeat the safety purpose of the grounding type plug.

POWER-CORD PROTECTION - Power-supply cords should be routed so that they are not likely to be walked on or pinched by items placed upon or against them, paying particular attention to cords at plugs, convenience receptacles, and the point where they exit from the product.

OUTDOOR ANTENNA GROUNDING — If an outside antenna or cable system is connected to the product, be sure the antenna or cable system is grounded so as to provide some protection against voltage surges and built-up static charges. Article 810 of the National Electrical Code, ANSI/NFPA 70, provides information with regard to proper grounding of the mast and supporting structure, grounding of the lead-in wire to an antenna discharge unit, size of grounding conductors, location of antenna-discharge unit, connection to grounding electrodes, and requirements for the grounding electrode. See Figure A.

LIGHTNING — For added protection for this product during a lightning storm, or when it is left unattended and unused for long periods of time, unplug it from the wall outlet and disconnect the antenna or cable system. This will prevent damage to the product due to lightning and power-line surges.

POWER LINES — An outside antenna system should not be located in the vicinity of overhead power lines or other electric light or power circuits, or where it can fall into such power lines or circuits. When installing an outside antenna system, extreme care should be taken to keep from touching such power lines or circuits as contact with them might be fatal.

OVERLOADING — Do not overload wall outlets, extension cords, or integral convenience receptacles as this can result in a risk of fire or electric shock.

OBJECT AND LIQUID ENTRY - Never push objects of any kind into this product through openings as they may touch dangerous voltage points or short-out parts that could result in a fire or electric shock. Never spill liquid of any kind on the product.

SERVICING — Do not attempt to service this product yourself as opening or removing covers may expose you to dangerous voltage or other hazards. Refer all servicing to qualified service personnel.

DAMAGE REQUIRING SERVICE - Unplug this product from the wall outlet and refer servicing to qualified service personnel under the following conditions:

- When the power-supply cord or plug is damaged.
- If liquid has been spilled, or objects have fallen into the product.
- If the product has been exposed to rain or water.
- If the product does not operate normally by following the operating instructions. Adjust only those controls that are covered by the operating instructions as an improper adjustment of other controls may result in damage and will often require extensive work by a qualified technician to restore the product to its normal operation.
- If the product has been dropped or damaged in any way.
- When the product exhibits a distinct change in performance — this indicates a need for service.

REPLACEMENT PARTS — When replacement parts are required, be sure the service technician has used replacement parts specified by the manufacturer or have the same characteristics as the original part. Unauthorized substitutions may result in fire, electric shock, or other hazards.

SAFETY CHECK - Upon completion of any service or repairs to this product, ask the service technician to perform safety checks to determine that the product is in proper operating condition.

WALL OR CEILING MOUNTING — The product should not be mounted to a wall or ceiling.

HEAT — The product should be situated away from heat sources such as radiators, heat registers, stoves, or other products (including amplifiers) that produce heat.

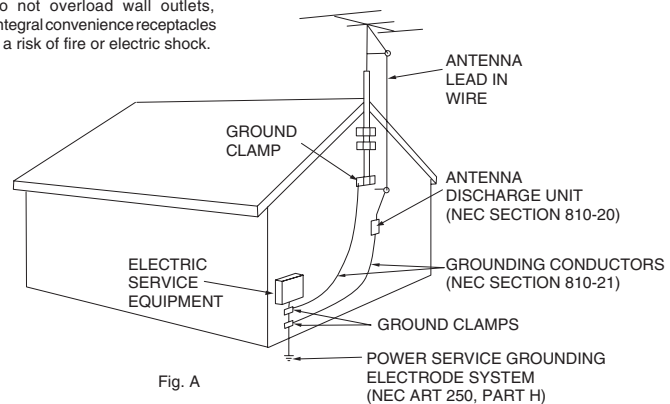

Fig. A

NEC — NATIONAL ELECTRICAL CODE

PRODUCT INFORMATION

1. Read Instructions - All the safety and operating instructions should be read before the CD Player is operated. The safety and operating instructions should be saved for future reference.
2. Heed Warnings - All warnings on the CD Player and in the operating instructions should be adhered to.
3. Water and Moisture - The player should not be used near water - for example, near a bath tub, kitchen sink, laundry tub, in a wet basement or near a swimming pool, etc.
4. Ventilation - The CD Player should be situated so that its location or position does not interfere with its proper ventilation. For example, the CD player should not be situated on a bed, sofa, rug, or similar surface that may block the ventilation openings; or, placed in a built-in installation, such as a bookcase or cabinet that may impede the flow of air through the ventilation openings.
5. Heat - The CD player should be situated away from heat sources such as radiators, heat registers, stoves, or other appliances (including amplifiers) that produce heat.
6. Power Sources - The CD player should be connected to a power supply only of the type described in the operating instructions or as marked on the CD Player.
7. Servicing - The user should not attempt to service the CD Player beyond that described in the operating instructions. All other servicing should be referred to qualified service personnel. The Player should be serviced by qualified service personnel when:
 - A. The power-supply cord or the plug has been damaged.
 - B. Objects have fallen, or liquid has been spilled into the CD Player.
 - C. The CD Player has been exposed to rain or water.
 - D. The CD Player does not appear to operate normally or exhibits a marked change in performance.

LINE VOLTAGE SELECTION

- The MCD-110 is designed to operate in either a 120 volts or 220 volts environment.
- Before changing the operating voltage be sure main power is disconnected.
- The desired voltage may be set with the VOLTAGE SELECTOR switch on the rear panel (using a flat head screw driver).
- Do not force the VOLTAGE SELECTOR switch as this may cause damage
- If the VOLTAGE SELECTOR switch does not move smoothly, please contact a qualified service technician.

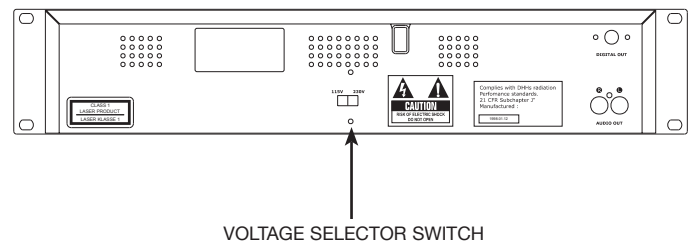

WARRANTY INFORMATION

The MCD-110™ carries a ONE year (365 days) limited warranty. This warranty covers parts and labor. Please fill out the enclosed warranty card to validate your purchase. All returned service items whether under warranty or not, must be freight pre-paid and accompany a return authorization (R.A.) number. The R.A. number must be clearly written on the outside of the return package. A brief description of the problem as well as the R.A. number must also be written down on a piece of paper and included in the shipping container. If the unit is under warranty, you must provide a copy of your proof of purchase invoice. You may obtain a R.A. number by contacting customer support at (800) 322-6337.

UNPACKING

Every MCD-110™ has been thoroughly tested and has been shipped in perfect operating condition. Carefully check the shipping carton for damage that may have occurred during shipping. If the carton appears to be damaged, carefully inspect your CD player for any damage and be sure all equipment necessary to operate the CD player has arrived intact. In the event damage has been found or parts are missing, please contact our toll free customer support number for further instructions. Please do not return the CD player to your dealer without first contacting customer support.

INTRODUCTION

Introduction:

Congratulations and thank you for purchasing the American Audio® MCD-110™ CD player. This CD player is a representation of American Audio's continuing commitment to produce the best and highest quality audio products possible at an affordable price. Please read and understand this manual completely before attempting to operate your new CD player. This booklet contains important information concerning the proper and safe operation of your new CD player.

Customer Support:

American Audio® provides a toll free customer support line, to provide set up help and answer any question should you encounter problems during your initial set up or operation. You may also visit us on the web at www.americanaudio.com for any comments or suggestions. Service Hours are Monday through Friday 9:00 a.m. to 5:30 p.m. Pacific Standard Time.

Voice: (800) 322-6337
Fax: (323) 582-2610
E-mail: support@americandj.com

To purchase parts online visit <http://parts.americandj.com>

Caution! There are no user serviceable parts inside this CD player. Do not attempt any repairs yourself, without being instructed to do so by an authorized American Audio service technician. Doing so will void your manufacturer's warranty. In the unlikely event your CD player may require service, please contact American Audio® customer support.

Do not discard the packing carton in the trash. Please recycle when ever possible.

SET-UP PRECAUTIONS

Please be sure to make any connections before plugging the CD player in to an electrical outlet. All fader and volume controls should be set to zero or minimum position, before the CD player is switched on. If the CD player has been exposed to drastic temperature fluctuation (e.g. after transportation), do not switch on the CD player immediately. The arising condensation of water might damage your device. Leave the device switched off until it has reached room temperature.

Operating Determinations:

- When installing this CD player, please make sure that the device is not exposed or will not be exposed to extreme heat, moisture or dust!
- Do not operate the CD player in extremely hot (more than 30°/100°F) or extremely cold (less than 5°C/40°F) surroundings.
- Keep the unit out of direct sunlight and away from heaters.
- Operate the CD player only after becoming familiar with its' functions. Do not permit operation by persons not qualified for operating the unit. Most damages are the result of unprofessional operation.

SET-UP

1. Checking the Contents

Be sure your MCD-110™ package was shipped with the following:

- 1) MCD-110™ Professional Rackmount Single CD Player
- 2) User Manual (this booklet)
- 3) Stereo Pair of RCA Cables
- 4) Warranty Card

2. Installing the Units

- 1) The MCD-110 is designed to be placed on a flat level surface or installed into a standard 19" rack mount case or enclosure. When mounting the MCD-110 in a 19" rack be sure to support the unit by all four screw slots on the face of the unit.
- 2) Be sure the player is mounted in a well ventilated area where it will not be exposed to direct sunlight, high temperatures, or high humidity.
- 3) Try to place the unit as far as possible from TV's and tuners, as the unit may cause undesirable interference with such devices.

3. Connections

- 1) Be sure the power is disconnected.
- 2) Connect the included RCA cable from your MCD-110™ outputs to the inputs on your mixer.
- 3) Use the Digital Output to connect to MiniDisc, DAT machines, or other device that accepts digital inputs.

CAUTION:

To avoid severe damage to the unit, be sure the power is off when making connections to the unit.

CAUTION:

- The player will work normally when the main unit is mounted with the front panel within 15 degrees of the vertical plane. If the unit is tilted excessively, disks may not be loaded or unloaded properly. (Figure 1)

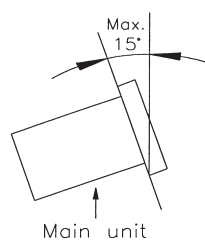

Figure 1

CAUTION:

- The LCD is designed to be clearly visible within the angles shown in Figure 2. Mount the control unit so that the visual angle is within this range.

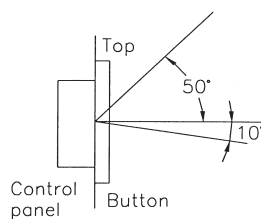
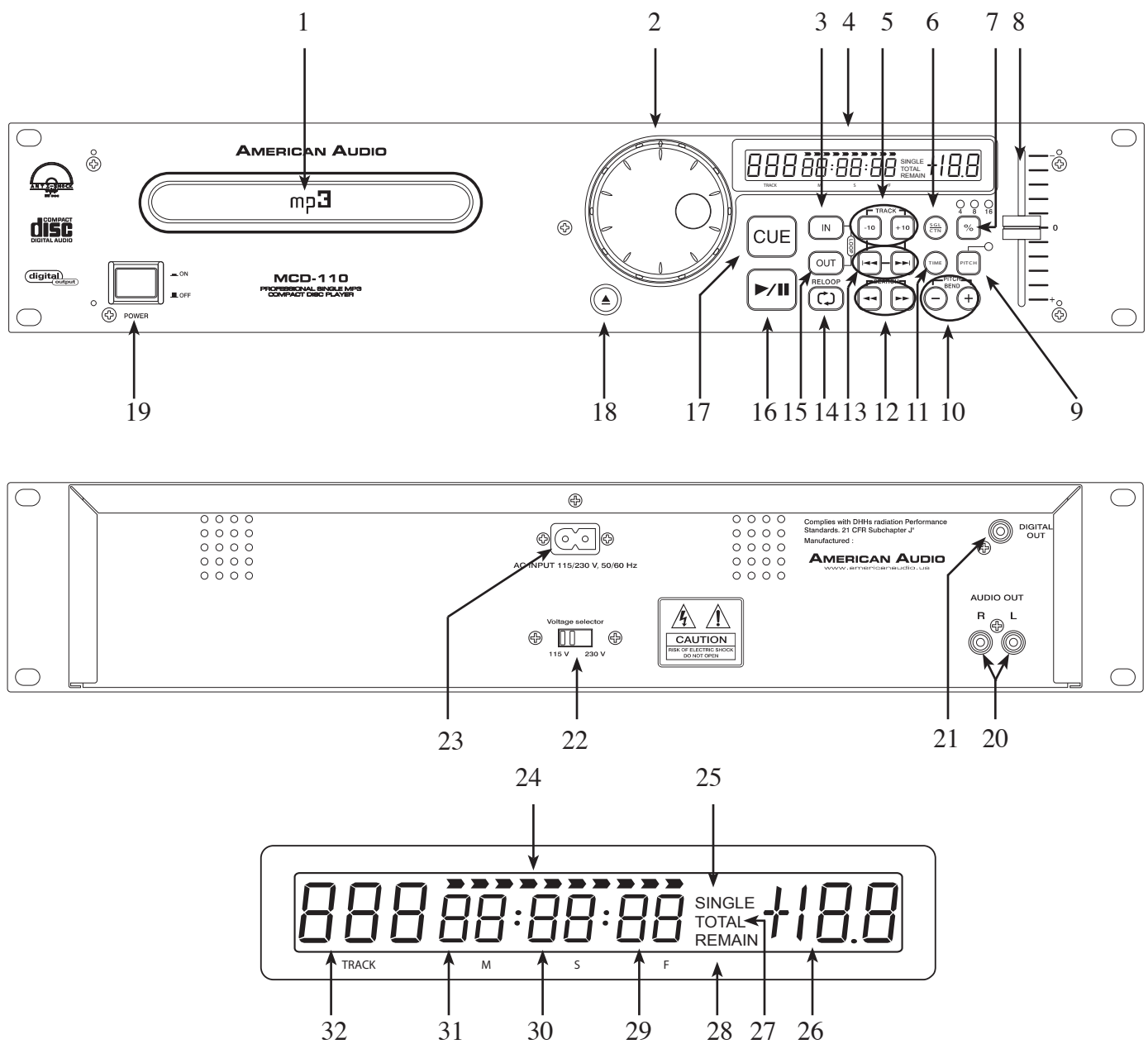

Figure 2

FUNCTIONS AND CONTROLS



A. FRONT CONTROLS (FIGURE 3)

1. TRANSPORT TRAY - This tray is used to load and unload compact disc's into the drive mechanism. The tray is opened and closed by pressing the *OPEN/CLOSE BUTTON (18)*. Never attempt to force the transport tray open or closed when the power is turned off.

2. JOG WHEEL - The jog wheel serves two functions depending on the current operating mode:

A. The jog wheel will act as a slow frame search control when the unit is in pause or

cue mode allowing you to set a specific cue point or find a particular starting point.

B. The wheel also works as a momentary pitch bend during playback. Turning the wheel clockwise will increase the pitch percentage up to 16%, and turning the wheel in the counterclockwise direction will decrease the pitch percentage up to -16%. The pitch bend will be determined on how fast you turn the wheel.

FUNCTIONS AND CONTROLS

3. LOOP IN BUTTON - “CUE ON THE FLY” - This function allows you to set a CUE POINT (see CUE POINT page 18) without music interruption (“on the fly”).

4. LIQUID CRYSTAL DISPLAY (LCD) - This high quality LCD Indicates all the unit functions (play, pause, cue, etc.), as they occur as well as displaying the time and track values. This display is viewable at several comfortable angles as described on page 6.

5. + 10 - This button instantly advances the track selection by 10. For example if the unit is cued on track one, pressing this button will instantly advance to and cue track 11. If the button is pressed once more the unit will advance to and cue track 21.

- 10 - This button instantly rewinds the track selection by 10. For example if the unit is cued on track 11, pressing this button will instantly rewind to and cue track 1.

6. SGL/CTN - This button allows the unit's play mode to change between Single and Continuous. In single mode the unit will play a single track and return to cue mode. In continuous mode the unit continues to play track by track and returns to cue mode after all tracks have played. This function also operates in program modes. In program mode the continuous function will play all tracks in a program, than return to cue mode on the first track in the program.

7. PITCH PERCENTAGE SELECTOR - Choose from pitch percentages of 4%, 8%, and 16%. See page 28 for more details.

8. PITCH SLIDER - This slider is used to adjust the playback pitch percentage when the *PITCH* (9) function is activated. The slider is a set adjustment and will remain set until the pitch slider is moved or the *PITCH* (9) function has been turned off. This adjustment can be made with or without a CD in the drive. The pitch adjustment will remain even if a disc has been remove, and will reflect on any other disc loaded into the unit. That is to say, if you set a +2% pitch on one disc, remove that disc and insert another, that disc too will have a +2% pitch. The amount of pitch being

applied will be displayed in the *LCD* (4). Use this slider to match the BPM's of this unit to that of another music source. By changing the pitch of one disc with respect to the other in this way, the beats can be matched.

9. PITCH BUTTON - This button is used to turn the pitch function on and off. The pitch functions of the *PITCH SLIDER* (8), *PITCH BEND BUTTONS* (10) and *JOG WHEEL* (2) will not function without this function being activated. The LED will glow when the pitch function is activated. See *PITCH* on page 16.

10. PITCH BEND BUTTONS -

(-) PITCH BEND - The (-) pitch bend function creates a momentary “Slow Down” in the CD's pitch speed (Beats per minute - BPM) when the *PITCH* (9) function is activated. This functions allows the beats between two CD's or any other music source to match. This is a momentary function. When the button is depressed the pitch speed will automatically return to *PITCH SLIDER'S* (8) selected pitch. Holding down this button will give a maximum of -16% pitch. Be sure to remember that this function is a momentary pitch adjustment, for a more precise adjustment use the *PITCH SLIDER'S* (8) to match the BPM's with another playing music source.

(+) PITCH BEND - The (+) pitch bend function creates a momentary “BUMP” in the CD's pitch speed (Beats per minute - BPM) when the *PITCH* (9) function is activated. This functions allows the beats between two CD's or any other music source to match. This is a momentary function. When the button is depressed the pitch speed will automatically return to *PITCH SLIDER'S* (8) selected pitch. Holding down this button will give a maximum of +16% pitch. Be sure to remember that this function is a momentary pitch adjustment, for a more precise adjustment use the *PITCH SLIDER'S* (8) to match the BPM's with another playing music source.

11. TIME - The time button is used to changed the way the time values are displayed in the *LCD* (4). The time value can be displayed as elapsed track time or remaining track time.

FUNCTIONS AND CONTROLS

12. SEARCH BUTTONS -

◀◀ This search button allows you to quickly scan backwards through a track.

▶▶ This search button allows you to quickly scan forwards through a track.

13. TRACK BUTTONS -

◀◀ This button is used to select a track. Tapping this button will back-skip to the previous track, holding down this button will rapidly back-skip through the tracks on a CD.

▶▶ This button is used to select your desired track. Tapping this button will forward skip to the next track, holding down this button will rapidly forward skip through the tracks on your CD.

14. RELOOP BUTTON - If a LOOP has been made (see setting a LOOP on page 17), but the CD Player is not actively in LOOP mode (a loop is not playing), pressing the RELOOP BUTTON will instantly reactivate the LOOP. To exit loop, press the *OUT BUTTON* (15). LOOP and RELOOP will appear in the *LCD DISPLAY* (4) when the RELOOP function is available.

15. LOOP OUT BUTTON - This button is used to set the ending point of a loop. A loop is started by pressing the *IN BUTTON* (3), pressing the *OUT BUTTON* set the loop ending point. The loop will continue to play until the *OUT BUTTON* is pressed once again.

16. PLAY/PAUSE BUTTON - Each press of the PLAY/PAUSE Button causes the operation to change from play to pause or from pause to play. While in play mode the green play LED will glow, and while in pause mode the green play LED will flash.

17. CUE - Pressing the CUE button during playback immediately pauses playback and returns the track to the last set cue point (see setting a CUE POINT, page 18).

18. OPEN/CLOSE (TRANSPORT TRAY OPEN/CLOSE) - This button is used to open and close the transport tray. *NOTE: The TRANSPORT TRAY (1) will not open when a CD is already inserted, unless the drive mechanism is in "Pause" or*

"Cue" mode to prevent accidentally stopping the music during playback.

19. POWER SWITCH - This switch is used to control the unit's main power.

20. AUDIO OUT R & L - These jacks are used to send a left and right output signal. Use these jacks to send an audio signal to a mixer or receiver. The red colored jack represents the right channel output and white jack represents the left channels output. Used together these signal reproduce a stereo signal.

21. DIGITAL OUT - This jack sends a digital stereo out signal. Use this connection to create near perfect copies of your disc to a Mini disc, CD-R, or any other recording device with a digital input.

22. VOLTAGE SELECTOR - Because power supplies vary from location to location a voltage selector switch has been incorporated in the unit's design. This switch can select a voltage input of 115v or 230v to accommodate the two major power source. Always be sure to disconnect the power plug before changing the voltage.

***Only dual voltage units have this switch.**

23. POWER CONNECTION - This is the main power connection. Only use the supplied polarized power cord. Use of any power cord may result in severe damage to the unit. Be sure the local power source matches the units' required power.

24. TIME BAR INDICATOR - This bar visually details the time defined in the *TIME METER* (29, 30, & 31). As with the *TIME METER* (29, 30, & 31), this bar is also dependent on the selected time function *REMAIN OR TOTAL*. This bar will begin to flash when 15 seconds of a track remain and will begin to rapidly flash when three seconds of a track remain. The flashing bar is a great visual reminder a track is about to end. The flashing bar will function regardless of which time mode the unit is in.

25. SINGLE INDICATOR - This indicates the unit is in single play mode, the unit will play a single track and return to CUE mode. If the *SINGLE*

FUNCTIONS AND CONTROLS

indicator is not displayed the unit is in continuous mode.

26. PITCH METER - This meter displays the pitch percentage being applied to playback by the *PITCH SLIDER* (8). If this meter displays zero and the *PITCH SLIDER'S* (8) is not set to the zero position, the *PITCH* (9) function is not activated.

27. TOTAL INDICATOR - When *TOTAL* is indicated in the *LCD DISPLAY* (4) the *TIME DESCRIBED* (29, 30, & 31) in the *LCD* (4) will define the total disc remaining time.

28. REMAIN INDICATOR - This indicator is in direct reference to the *TIME METER* (29, 30, & 31). When the *REMAIN* indicator is displayed in the *LCD* (4), the time defined will refer to a single track's remaining time. The time mode is changed by tapping on *TIME BUTTON* (11).

29. FRAME METER - This meter will display the elapse, or frames. The displayed frames will be indirect reference to the current time mode.

30. SECONDS METER - This meter will display the elapse, or remaining time in seconds. The display time will be indirect reference to the current time mode.

31. MINUTES METER - This meter will display the elapse, or remaining time in minutes. The display time will be indirect reference to the current time mode.

32. TRACK INDICATOR - This double digit indicator details a current track. The number displayed in the track indicator is a direct reference to a track being selected for programming or a track in play, pause, or cue mode.

BASIC OPERATION

1. OPENING AND CLOSING THE DISC TRAY

This is an electronic operation and can only work when the power is on. Press the *OPEN/CLOSE BUTTON (19)* to open or close the disc tray. Pressing the *PLAY/PAUSE BUTTON (16)*, will also automatically close the tray if it is open and immediately cue any CD that is in it. If the transport tray is left open for more than 60 seconds it will close automatically to prevent accidental damage to the transport. Again if a CD is left in the transport tray it will immediately cue to the first song. The disc trays cannot be opened during playback to prevent playback from being interrupted if the *OPEN/CLOSE BUTTON (19)* is pressed accidentally. Stop playback, then press the *OPEN/CLOSE BUTTON (19)*.

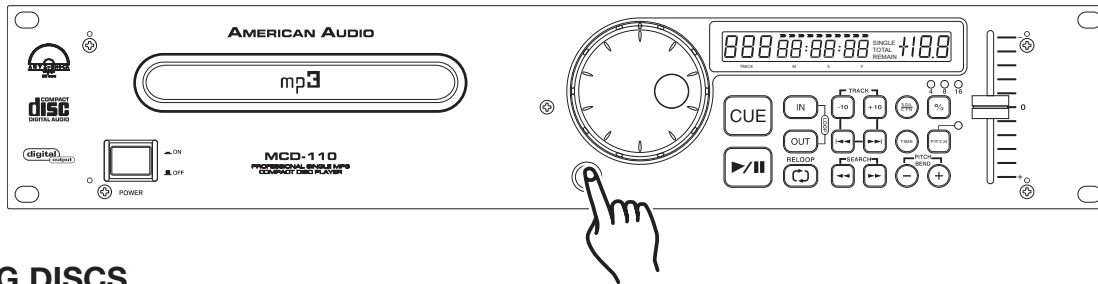

2. LOADING DISCS

The MCD-110 can play both 3 inch (8 cm) and 5 inch (12 cm) compact discs (CD's). Odd shaped and oval CD's are not compatible. When loading a CD into the unit always hold the disc by its' edges and place it in the disc tray. Never touch the signal surface (the glossy side). When using 5 inch/12 cm discs, place the disc in the outer tray guides (figure 7), and when using 3 inch/8 cm discs, place them securely in the inner guides (figure 8).

CAUTION:

- NEVER insert any foreign objects in the disc tray.
- NEVER attempt to insert more than one disc in the disc tray at a time. Doing so may result in severe damage to the unit.
- NEVER force the transport tray open or closed when the power is off, as this may result in malfunction and damage the transport system.

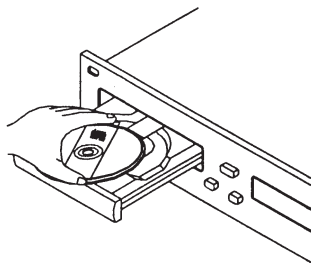

Figure 7 - 5 in. / 12cm disc

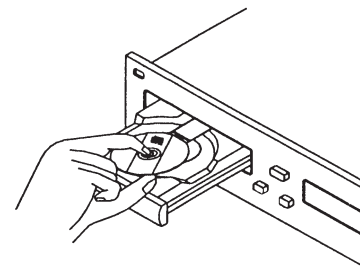

Figure 8 - 3 in. / 8cm disc

3. SELECTING TRACKS

Select a desired track by using either of the two *TRACK BUTTONS (13)*. Tapping the *TRACK BUTTONS (113)* once will select either a higher or lower track. You may hold down the *TRACK BUTTONS (13)* to change tracks continuously at a higher speed. If you are using the *TRACK BUTTONS (13)* to select a new track during playback (a track already playing) the new track you selected will immediately begin playback as soon as the search operation is completed.

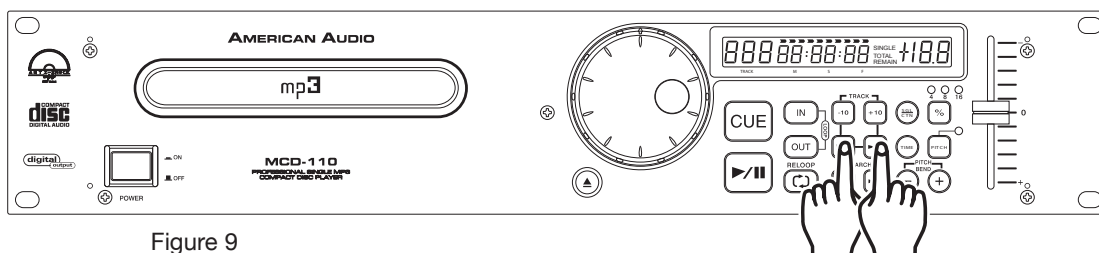

Figure 9

BASIC OPERATION

4. STARTING PLAYBACK

Insert an audio CD as describe on the previous page (*LOADING DISCS*). Pressing the *PLAY/PAUSE BUTTON* (18) with an audio CD inserted will immediately start playback. The point at which playback starts (cue point) will automatically be stored in the memory as the cue point. The unit will return to this cue point (the point at which playback started) when the *CUE BUTTON* (17) is pressed.

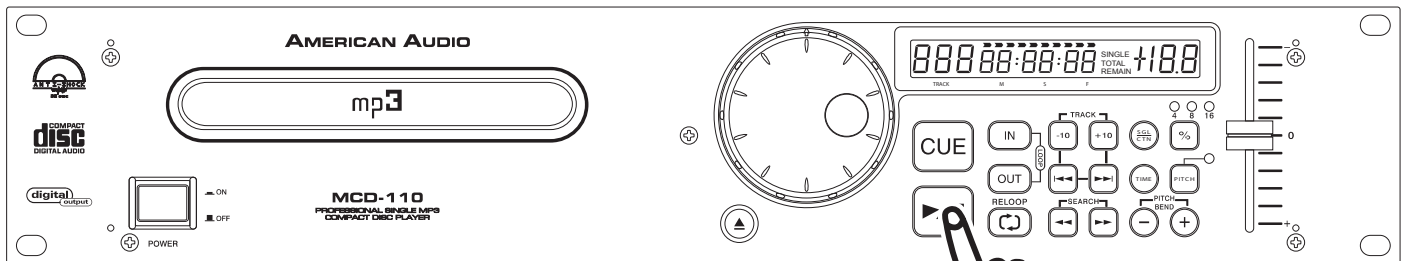

Figure 10

5. STOPPING PLAYBACK

Stopping playback will not stop the drive mechanism, but merely pause or cue the track. There are two ways to stop playback:

6. PAUSING

Pausing temporarily stops playback. Pressing the *PLAY/PAUSE BUTTON* (16) changes the operating mode between play and pause. The *PLAY/PAUSE BUTTON LED* will flash repeatedly when pause mode is activated or when a track is in cue mode.

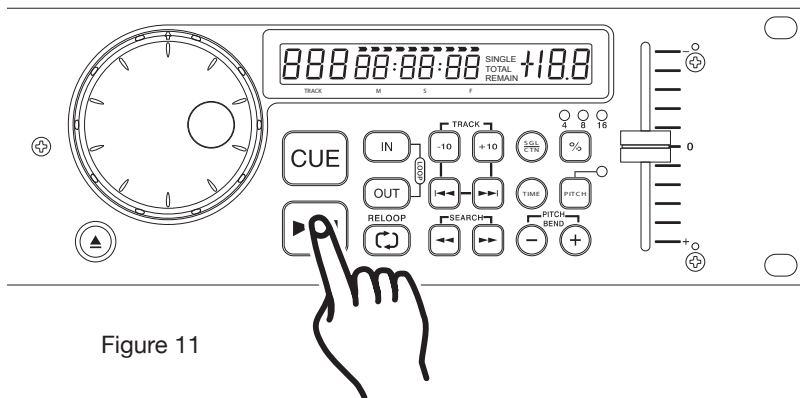

Figure 11

1) Press the *PLAY/PAUSE BUTTON* (16) during playback to pause at that point.

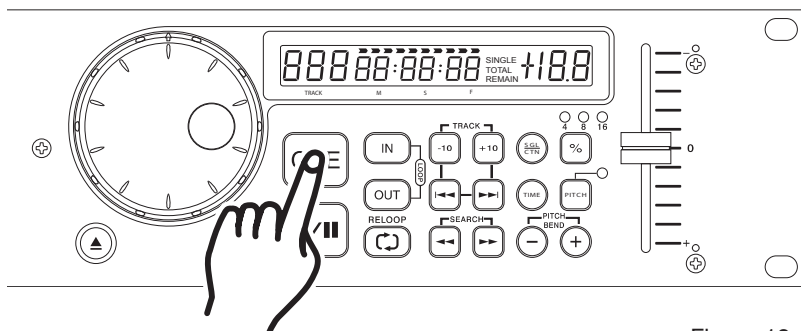

Figure 12

2) Press the *CUE BUTTON* (17) during playback to return the track to it's last cue point.

BASIC OPERATION

7. AUTO CUE

"Cueing" is the action of preparing for playback. The unit is designed to automatically cue at the first audible signal on the first of a disc when a disc is inserted. If a track is selected before a disc is inserted, the unit will automatically cue to the first audible signal for the selected track.

8. SETTING CUE POINTS

A cue point is the exact point playback will begin when the PLAY/PAUSE BUTTON (16) is pressed. A cue point may be created anywhere on a disc or in a track.

Use the *JOG WHEEL* (2) to set a cue point by frame. While the disc is in pause or cue mode, use the *JOG WHEEL* (2) to scroll through a track to find your desired starting point. Once you have found your desired cue point press the *PLAY BUTTON* (16) to enter this point in to the unit's memory. At this point when ever the *CUE BUTTON* (17) is pressed it will return the track to this exact point.

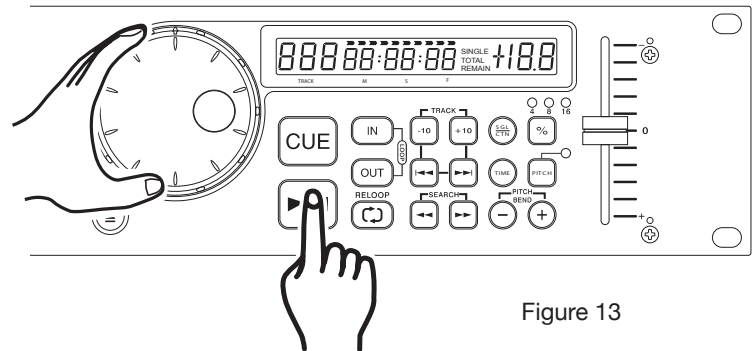

Figure 13

9. FRAME SEARCH

This feature allows you to scroll through a track to set a cue, or loop point. To use the scroll function you must first be in Pause Mode or Cue Mode. Once you are in Pause or Cue mode, use your finger tip or hand to turn the *JOG WHEEL* (2) to scroll through the track (figure 13). Turning the wheel in a clockwise direction will advance the frame search and turning the wheel in a counter-clockwise direction rewinds the frame search. When you use the *JOG WHEEL* (2) the monitor (headphone level) of a mixer allows you to here what you are scrolling through. Once you reach your desired starting point you can set a cue (starting) point by pressing the *PLAY/PAUSE BUTTON* (16) as in figure 13. Pressing the *CUE BUTTON* (17) will return the disc to the cue point just set.

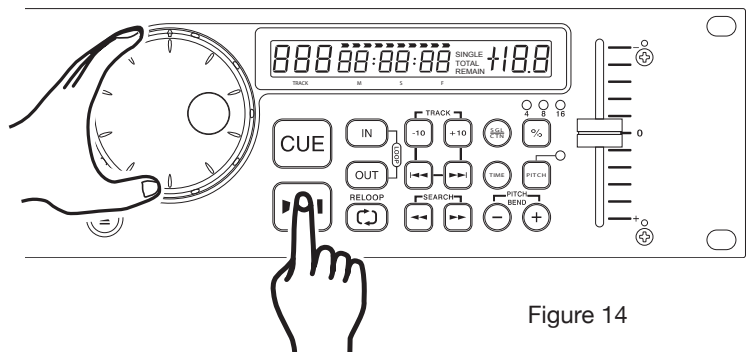

Figure 14

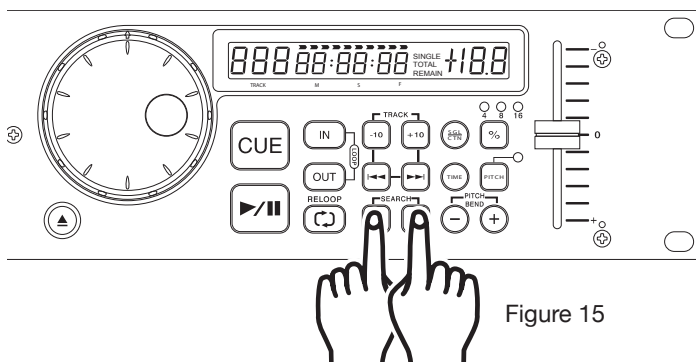

Figure 15

10. FRAME SEARCH (FORWARD / REVERSE)

This function lets you a frame search through a track. To do this press either the forward or reverse *SEARCH BUTTONS* (12).

BASIC OPERATION

11. CHANGING THE TIME DISPLAY (29, 30, & 31)/TIME BAR (24):

The time may be displayed in three different modes; Total Remain, Remain, and Elapsed. During normal playback, pressing the *TIME BUTTON* (11) as in figure 15, will change the time display information (29, 30, & 31) in the LCD. The following is a break down of the time settings and their definitions:

- 1) TOTAL REMAIN (27) - This details the time in the LCD (29, 30, & 31) as the current cds' total remaining time.
- 2) REMAIN (28) - This details the time in the LCD (29, 30, & 31) as the current tracks' remaining running time.
- 3) ELAPSED - This details the time in the LCD (29, 30, & 31) as the current tracks' elapsed running time.

The unit will indicate the ELAPSED time when neither the TOTAL REMAIN OR REMAIN indicators are showing. Note: When playing a Mp3 disc the TOTAL REMAIN time of a disc cannot be shown. Only the REMAIN time and ELAPSED time of the track.

TIME BAR INDICATOR - The time bar in the LCD visually details the time defined in the *TIME METER* (29, 30, & 31). This bar is also dependent on the selected time function; *REMAIN* (28) or *TOTAL REMAIN* (27). This bar will begin to flash when 15 seconds of a track remain and will begin to rapidly flash when three seconds of a track remain. The flashing bar is a great visual reminder a track is about to end. The flashing bar will function regardless of which time mode the unit is in.

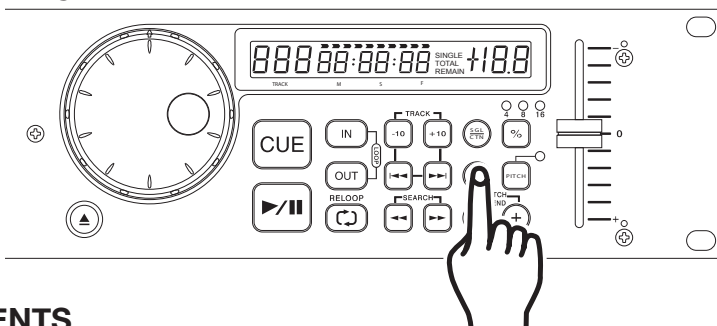

Figure 16

12. PITCH ADJUSTMENTS

This function will increase or decrease the playback speed or "PITCH," of a track. The maximum pitch bend percentage allowed is +/-16%. The *PITCH SLIDER* (8) is used to decrease or increase the playback pitch. If the slider is move up (towards the top of the unit) the pitch will decrease, if the slider is moved down (towards the bottom of the unit) the pitch will increase.

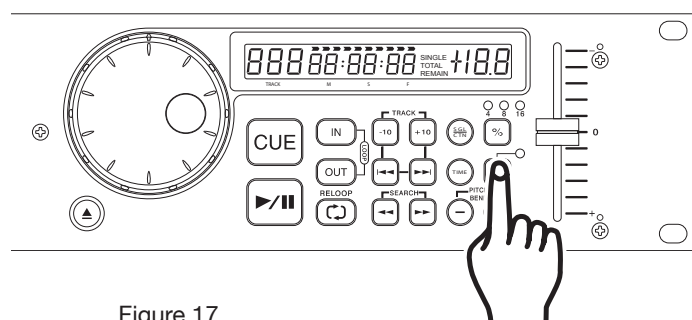

Figure 17

Activating the Pitch Slider (8):

To activate the *PITCH SLIDER* (8), you must turn the pitch function on. Press the *PITCH BUTTON* (9) to turn on the pitch function, when the pitch function is activated the *PITCH LED* (9) will begin to glow. If the pitch function is not activated the *PITCH SLIDER* (8) will not function.

Using the Pitch Slider (8): To use the *PITCH SLIDER* (8) slide the slider up and down. Down will increase the pitch and up will decrease the pitch. When the slider is in the center position, there is zero pitch being applied to a track.

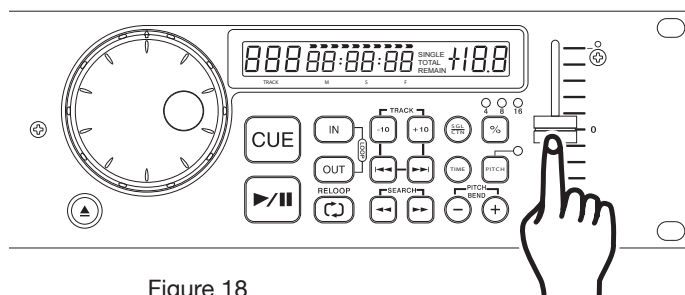

Figure 18

BASIC OPERATION

13. PITCH BEND

This function will *momentarily* increase or decrease a tracks playback speed using the (-) & (+) *PITCH BUTTONS (10)*. The maximum pitch bend percentage allowed is +/-16%. The pitch bend function will work in conjunction with the *PITCH SLIDER (8)* pitch setting. For example, if the *PITCH SLIDER (8)* is set to a 2% pitch gain the pitch bending process will begin at 0% and will continue to the maximum of +/-16%.

PITCH BEND BUTTONS (10)

The (+) *PITCH BEND BUTTON (10)* will provide a speed bump and the (-) *PITCH BEND BUTTON (10)* will provide a slow down. The extent to which the speed changes is proportionate to the amount of time the button is pressed. For example, if the (+) *PITCH BEND BUTTON (10)* is held down continuously, the disc speed will increase and will continue to increase until it reaches a maximum of 16% speed gain. When you release the (+) *PITCH BEND BUTTON (10)* the disc speed will automatically return to it's previous speed.

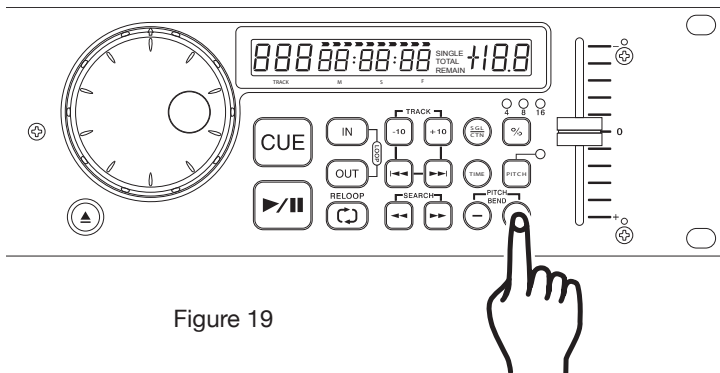

Figure 19

Holding down or tapping on the (+) *PITCH BEND BUTTON (10)* will provide a speed bump in the playback pitch.

Holding down or tapping on the (-) *PITCH BEND BUTTON (10)* will provide a slow down in the playback pitch.

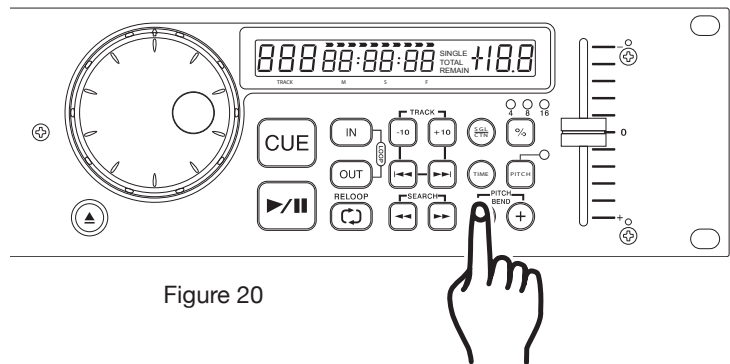

Figure 20

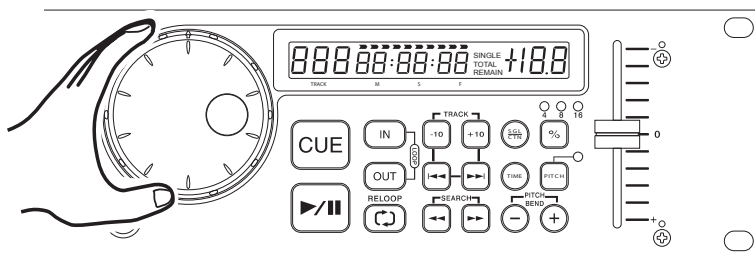

Figure 21

JOG WHEEL (2)

The *JOG WHEEL (2)* will temporarily bend the pitch if a track is in play mode. Turning the wheel in a clockwise direction will increase your track pitch and turning the wheel in a counter-clockwise direction will slow your track pitch. The speed you rotate the *JOG WHEEL (2)* will determine pitch bend percentage, to a maximum of +/-16%.

BASIC OPERATION

14. CREATING AND PLAYING A LOOP

A loop is a sound loop that plays continuously. You can use this loop to create dramatic effect in your mixing. This loop has no time limit and you could actually loop the entire length of disc. You create a loop between two continuous points of a disc.

1) Press PLAY/PAUSE BUTTON (16) to activate playback mode.

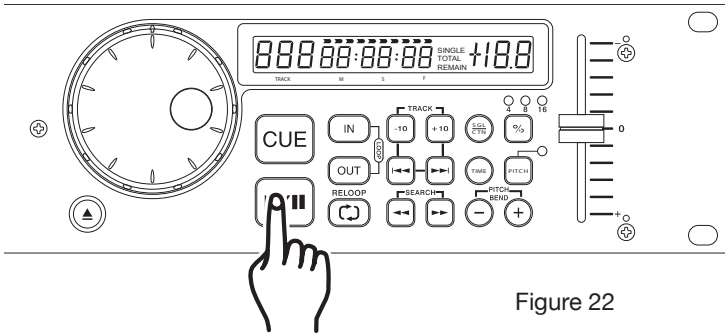

Figure 22

2) Press the IN BUTTON (3). This will set the starting point of the Loop (figure 23). The IN BUTTON (3) will blink.

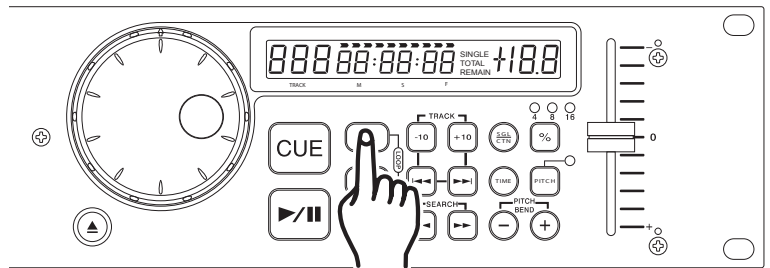

Figure 23

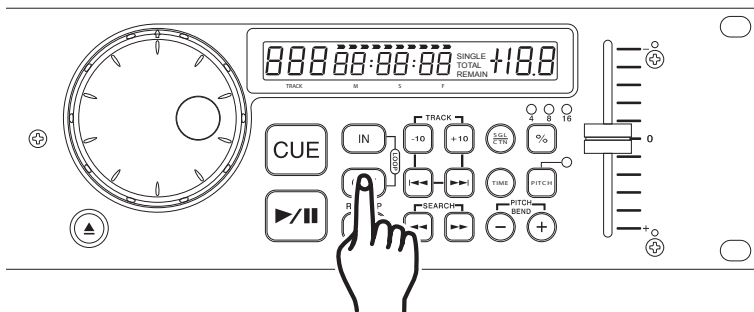

Figure 24

3) Press the OUT BUTTON (15) to set the ending point for your Loop (Figure 24). The OUT and IN BUTTON'S will stay lit indicating a Loop is playing. Press the OUT BUTTON again to stop the Loop.

4) Press the RELOOP BUTTON (14) to reactivate the loop. Press the OUT BUTTON (15) to deactivate the loop.

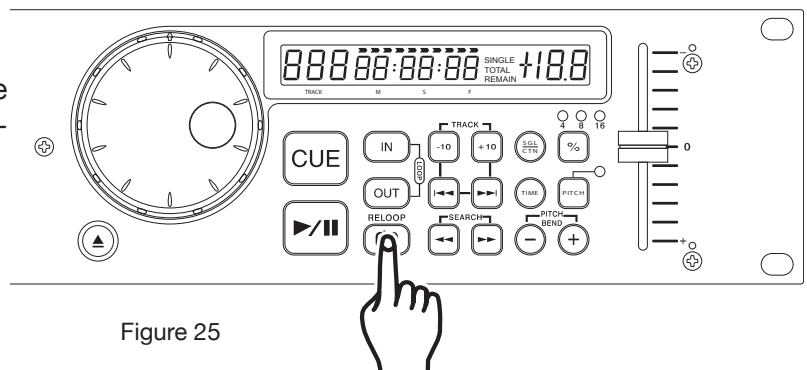
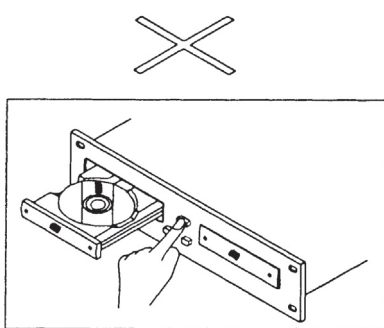

Figure 25

POWER DOWN

- When you have finished using the CD unit, and before switching off the power, be sure that the disc holder has been closed with the *OPEN/CLOSE BUTTON*.
- TRAY PROTECTION: If tray is not closed after 60 seconds, it will close automatically and pause.

CAUTION: DO NOT forcibly close the disc holder when the power is off.



Do not switch off the power when the disc holder is open.

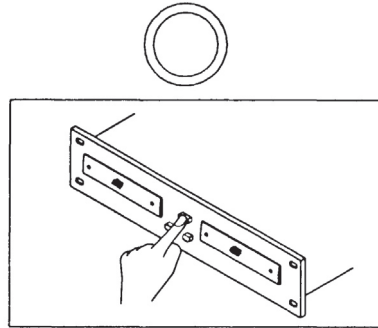

Switch off the power after the disc holder has been closed with the *OPEN/CLOSE BUTTON*.

DO NOT switch off the power when the disc holder is open. Switch off the power after the disc holder has been closed with the *OPEN/CLOSE BUTTON*.

COMPACT DISC

1. PRECAUTIONS ON HANDLING COMPACT DISCS

Compact disc are constructed of the same types of plastic record are. To avoid severe damage to you valuable disc please observe the following guide lines. Following the these guide lines will ensure long disc life.

- Do not allow fingerprints, oil or dust to get on the surface of the disc. If the disc is dirty, wipe it off with a soft dry cloth.
- Do not use benzene, thinner, water, record spray, electrostatic-proof chemicals, or silicone-treated cloths to clean discs.
- Always handle discs carefully to prevent damaging the surface; in particular when removing a disc from its edges.
- Do not bend the disc.
- Do not apply heat.
- Do not enlarge the hole in the center of the disc.
- Do not write on the label (printed side) with a hard tipped implement such as a pencil or ball point pen.
- Condensation will form if a disc is brought into a warm area from a colder one, such as outdoors in winter. Do not attempt to dry the disc with a hair dryer, etc.

2. PRECAUTION ON STORAGE

- After playing a disc, always unload it from the unit.
- Always store the compact disc in the jewel case, protecting from dirt or damage.
- Do not place discs in the following areas:
 - a) Areas exposed to direct sunlight for a considerable time.
 - b) Areas subject to accumulation of dust or high humidity.
 - c) Areas affected by heat from indoor heaters, etc.

WARRANTY

1-YEAR LIMITED WARRANTY

- A. American Audio® hereby warrants, to the original purchaser, American Audio® products to be free of manufacturing defects in material and workmanship for a period of 1 Year (365 days) from the date of purchase. This warranty shall be valid only if the product is purchased within the United States of America, including possessions and territories. It is the owner's responsibility to establish the date and place of purchase by acceptable evidence, at the time service is sought.
- B. For warranty service, send the product only to the American Audio® factory. All shipping charges must be pre-paid. If the requested repairs or service (including parts replacement) are within the terms of this warranty, American Audio® will pay return shipping charges only to a designated point within the United States. If the entire instrument is sent, it must be shipped in its original package. No accessories should be shipped with the product. If any accessories are shipped with the product, American Audio® shall have no liability whatsoever for loss of or damage to any such accessories, nor for the safe return thereof.
- C. This warranty is void if the serial number has been altered or removed; if the product is modified in any manner which American Audio® concludes, after inspection, affects the reliability of the product; if the product has been repaired or serviced by anyone other than the American Audio® factory unless prior written authorization was issued to purchaser by American Audio®; if the product is damaged because not properly maintained as set forth in the instruction manual.
- D. This is not a service contract, and this warranty does not include maintenance, cleaning or periodic check-up. During the period specified above, American Audio® will replace defective parts at its expense, and will absorb all expenses for warranty service and repair labor by reason of defects in material or workmanship. The sole responsibility of American Audio® under this warranty shall be limited to the repair of the product, or replacement thereof, including parts, at the sole discretion of American Audio®. All products covered by this warranty were manufactured after January 1, 1990, and bear identifying marks to that effect.
- E. American Audio® reserves the right to make changes in design and/or improvements upon its products without any obligation to include these changes in any products theretofore manufactured.
- F. No warranty, whether expressed or implied, is given or made with respect to any accessory supplied with products described above. Except to the extent prohibited by applicable law, all implied warranties made by American Audio® in connection with this product, including warranties of merchantability or fitness, are limited in duration to the warranty period set forth above. And no warranties, whether expressed or implied, including warranties of merchantability or fitness, shall apply to this product after said period has expired. The consumer's and or Dealer's sole remedy shall be such repair or replacement as is expressly provided above; and under no circumstances shall American Audio® be liable for any loss or damage, direct or consequential, arising out of the use of, or inability to use, this product.
- G. This warranty is the only written warranty applicable to American Audio® Products and supersedes all prior warranties and written descriptions of warranty terms and conditions heretofore published.

SPECIFICATIONS

GENERAL	Model: American Audio® MCD-110™ - Professional Compact Disc Player
System:	Single Tray Front Loading, Digital Compact Disc/Mp3 Audio Player.
Disc type:	Standard compact discs (5 in / 12cm and 3in/8cm discs)
Dimensions:	3.5" H x 19" W x 9.84" L / 482W x 88.8H x 250D mm
Installation:	Place on flat surface or mount in flat case
Weight:	9 Lbs. / 4.06 kgs
Power supply:	AC 115v/230v, 50/60Hz
Power consumption:	14W
Pitch control range:	+/-4%, +/-8%, +/-16%
Pitch bend:	+/-16%
Pitch accuracy:	+/- 0.1%
Environmental conditions:	Operational temperature: 5 to 35°C (41 to 95°F) Operational humidity: 25 to 85% RH (non-condensation) Storage temperature: -20 to 60°C (4 to 140°F)
Accessories:	Dual RCA Cable (for left and right channels)

AUDIO SECTION:

Quantization:	16 bit linear per channel
Sampling rate:	44.1 kHz at normal pitch
Over sampling rate:	8 times over sampling 1 bit D/A converter
D/A conversion	16 bit
Frequency response:	+/-0.4 dB 20 Hz to 20,000 KHz
Output level:	2.0V +/- 0.5dB
Load impedance:	47k ohm or more
Digital Output Level:	0.5V +/-1 p-p (Load = 75ohms)

AUDIO CHARACTERISTICS (TEST DISC: TCD-782, LOAD=47Kohm):

ITEM	NOMINAL	LIMIT	CONDITION
Output level	2Vrms +/-0.5dB	2Vrms +/-1dB	1KHz,0dB
Channel balance	Within 0.1dB	Within 1dB	1KHz,0dB
Frequency response	+/-0.4dB	+/-1dB	20Hz-20KHz,0dB OUTPUT
De-emphasis response	+2.4/-0dB	+3/-0dB	16KHz, -20dB
Channel separation (*2)	100dB	90dB	1KHz,0dB
T.H.D. + NOISE (*1)	0.006%	0.01%	1KHz,0dB
S/N ratio (IHF-A) (*2)	101dB	90dB	1KHz.0dB

NOTE: (*1) With 20KHz low pass filter. (*2) With 20KHz low pass filter and "IHF-A Weighted.

SEARCHING TIME (TEST DISC: TCD-792):

ITEM	NOMINAL	LIMITS	CONDITION
Short access time	2 sec	4 sec	Play next track
Long access time	4 sec	6 sec	Track 1 ->Track 20 / Track 20 ->Track 1

PLAYABILITY:

ITEM	NOMINAL	LIMIT	CONDITION
Interruption	1mm	0.7mm	TCD-725
Black dot	1mm	0.6mm	TCD-725
Finger prints	75um	65um	TCD-725
Eccentricity	140um	140um	TCD-712, W/O TRACK JUMP
Vertical deviation	1mm	0.5mm	TCD-731R

PICK-UP (Sony KSM-213VCS):

System	Object lens drive system optical pick-up
Object lens drive system	2 dimensional parallel drive
Tracking detection	3 spot beam detection
Optical source	Semiconductor laser
Wave length	780nm

NOTES:

The specifications are subject to change to any improvement by negotiations in advance.
The parts are subject to change to any improvement within the range of the specifications.



©American Audio
A Division of the American DJ Group of Companies
4295 Charter Street
Los Angeles, CA 90058 USA
Tel: 323-582-2650 Fax: 323-582-2610
Web: www.americanaudio.com E-mail: info@americanaudio.com

Free Manuals Download Website

<http://myh66.com>

<http://usermanuals.us>

<http://www.somanuals.com>

<http://www.4manuals.cc>

<http://www.manual-lib.com>

<http://www.404manual.com>

<http://www.luxmanual.com>

<http://aubethermostatmanual.com>

Golf course search by state

<http://golfingnear.com>

Email search by domain

<http://emailbydomain.com>

Auto manuals search

<http://auto.somanuals.com>

TV manuals search

<http://tv.somanuals.com>