



XM Compact Sound System
User Guide

About XM

XM is America's number one satellite radio company. Broadcasting live daily from studios in Washington, DC, New York City, Chicago, the Country Music Hall of Fame in Nashville, Toronto and Montreal, XM's lineup includes more than 170 digital channels of choice from coast to coast: commercial-free music, premier sports, news, talk radio, comedy, children's and entertainment programming; and the most advanced traffic and weather information.

XM is the leader in satellite-delivered entertainment and data services for the automobile market through partnerships with General Motors, Honda, Hyundai, Nissan, Porsche, Subaru, Suzuki and Toyota. XM's industry-leading products are available at consumer electronics retailers nationwide. For more information about XM hardware, programming and partnerships, please visit <http://www.xmradio.com/>.

Table of Contents

Getting Started	4
Step 1: Unpack the XM Compact Sound System	4
Step 2: Choose your Radio-specific dock adapter	5
Step 3: Insert your radio.....	8
Step 4: Connect the antenna	9
Step 5: Connect the power	10
Step 6: Turn it on	10
Step 7: Listen.....	11
Taking Care of Your Sound System	13
Troubleshooting	14
Technical information	15
FCC and IC Statement	16
Warranty	17

Getting Started

Congratulations, you've just expanded the use of your XM Radio!

Now, in addition to listening to the channels you love in the car, you can listen to XM Music, Sports, News, Talk, Comedy & Entertainment in your home, at the office, etc.

Use these instructions to set up your XM Compact Sound System. If you need help, call XM Listener Care at 1-800-XM-RADIO (1-800-967-2346) or contact us at www.xmradio.com.

Step 1: Unpack the XM Compact Sound System



XM home antenna

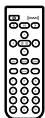

Remote

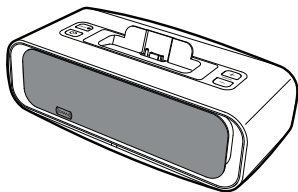

XM Compact sound system

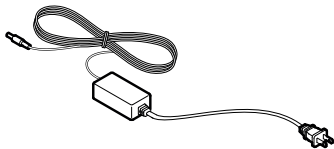

Power supply



Radio-specific Dock adapters

Step 2: Choose your Radio-specific dock adapter

The Xpress dock adapter is already installed in the Compact Sound System. The Xpress dock adapter can be used with the following radios: the Audiovox Xpress, Audiovox Xpress^{EZ}, Audiovox Xpress^R, Audiovox Xpress^{RC}, and Delphi Xpress^{RC} (all radios sold separately).

If you are not using one of the Xpress family of radios, you must replace the Xpress dock adapter with the appropriate one for your XM radio. The name of each dock adapter is molded into the bottom surface of each one; turn the dock adapter over to see the name.

Radio-specific dock adapters

Xpress family

RoadyXT[®]

SKYFi3[®]

inno[™] & Helix[™]

XMp3[™]



Getting Started

- 1 To remove the Xpress dock adapter, lift both sides of the adapter at the same time.
- 2 Insert the dock adapter for your radio.

If your radio is a Pioneer inno™ or a Samsung Helix™, you will also need the *XM2go Boombox Adapter Model: XMPA1* (Sold separately). After installing the dock adapter, plug the special *XM2go Boombox Adapter* into place.

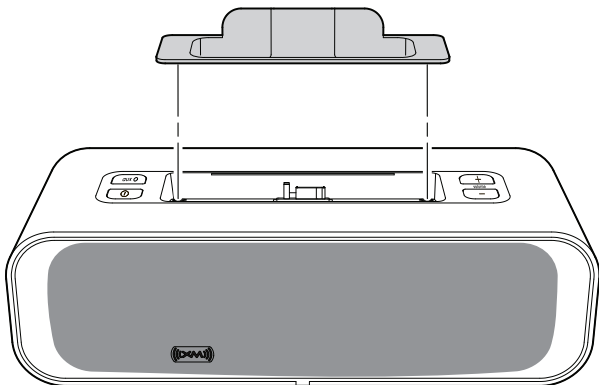

Adapter for the inno™ and Helix™

inno™ / Helix™

XM2go Boombox Adapter
Model: XMPA1
(Sold separately)

Included inno™/Helix™
Dock Adapter

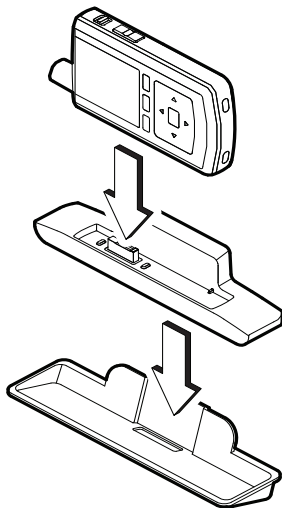

Getting Started

Step 3: Insert your radio

To insert your XM Radio into the Compact Sound System, align the radio's connector with the Sound System's connector, then carefully but firmly press to secure the radio in place.

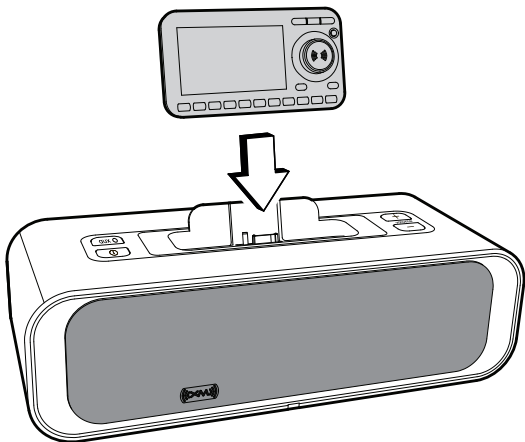

TIP! Although designed to fit snugly, we recommend that you remove the radio before moving the Sound System.

Step 4: Connect the antenna

- 1 Place the antenna:
 - Position the antenna for best reception, most likely near a south-facing window.
- 2 Plug the antenna into the jack labeled Antenna.

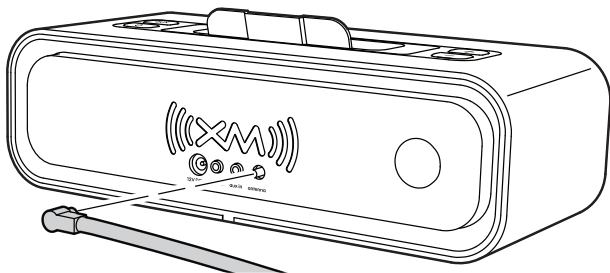

Getting Started

Step 5: Connect the power

- 1 Plug the AC power adapter into the jack labeled 12V DC on the Sound System.
- 2 Plug the other end into any 110 - 120V wall outlet or power source.

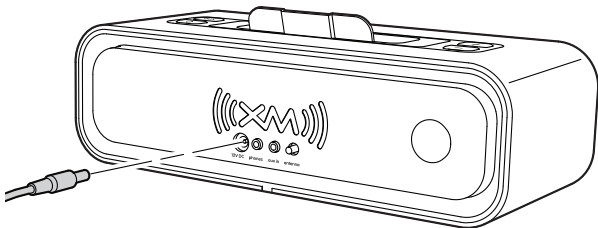

Step 6: Turn it on

- 1 Press the power button on the Sound System.
- 2 Turn on your XM Radio.



TIP! For some radio models, you can enable the Auto-ON feature for ease of use. Refer to your radio's menu settings and User Guide for instructions. The Helix, inno and XMp3 need to be powered down manually.



TIP! The Helix, inno and XMp3 will charge while in the sound system, turn off the sound system if you do not want your Helix, inno or XMp3 to charge.

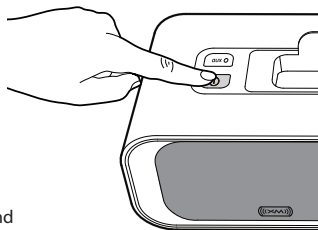

Step 7: Listen

- 1 This Sound System was designed to work with a wide range of XM receivers. You may need to adjust the audio "Line Out Level" in the menu options of your receiver to achieve optimal performance from this sound system. Please see your XM receiver user guide for additional information on this adjustment.
- 2 Use the volume buttons on the Sound System or remote control to adjust the sound level.
- 3 To control both your XM radio and Sound System use the remote that is included with your sound system. (see page 12)

If desired, plug in your headphones to the **phones** jack. Use the volume buttons on the Compact Sound System to control the headphones. The Sound System's speakers are muted when the headphones are in use.

Your Sound System has an **aux in** jack for connecting CD or MP3 players using a mini audio cable (sold separately). Once you have a device plugged in press the **aux** button to switch from XM mode to aux mode. The LED on the button will be on when in aux mode.

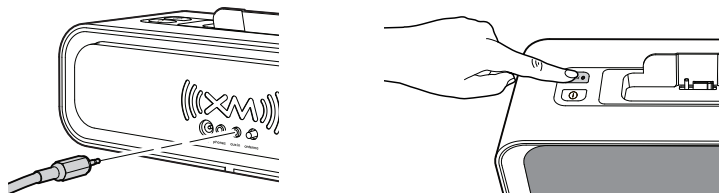

Getting Started

Remote Control functions

Power Button *

60-Minute Replay Buttons

Pause and replay up to 60 minutes of live XM broadcast.

XM Button

Confirms selection for channel and menu items.

info

Displays either your personal stock or info extras information.

Number Keys

Enter a channel directly, select your favorite channels, or access songs saved in SongSaver.

Jump

Switches between current channel and previous channel.

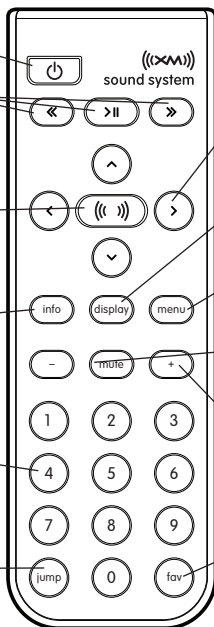

Arrow Buttons

Select menu entries, change channels.

Display

Customize the way you view content on the display.

Menu

Access advanced features and configuration options.

Mute

Silences live, saved songs, and replayed XM content.

+ and - *

Control volume for audio system.

Fav

Choose among direct channel entry, favorite channels, and presets.

*The remote supplied with your XM radio will not control these functions

Taking Care of Your Sound System

Placement

Do not place the Sound System or XM radio near heat sources or in direct sunlight. Do not place the Sound System on an inclined or unstable surface, in areas of excessive dust, or areas prone to mechanical shock. Do not block the speakers or ventilation ports.

Because the speakers contain powerful magnets, keep credit cards, mechanical watches, and other devices that might be affected away from the Sound System.

Cleaning



DANGER! Unplug the AC power adapter during the cleaning to avoid any electrical shock hazard.

Clean the hard surfaces of the Sound System with a soft cloth slightly moistened with a mild detergent solution.

Clean the soft surfaces of the speakers with a dry lint brush.

Do not use any type of abrasive pad, scouring powder, or solvent, such as alcohol or benzene.

Troubleshooting

If this happens	Try this
My XM radio is not receiving a signal.	Use the “antenna aiming” feature on the XM radio and move the antenna to another location.
My XM radio will not turn on.	Check whether the power cord is plugged into the wall. If applicable, make sure Auto-ON is enabled.
I only receive XM channels 0 and 1.	Make sure your radio is activated. Contact XM at www.xmradio.com or 1-800-XM-RADIO.
The radio and Sound System are on and receiving a signal but I can't hear anything.	Remove the radio from the Sound System and re-insert it, then turn the power on. Unplug any headphones. Check the volume control. Make sure mute is not set on the remote if used. Make sure aux mode is off.
I hear noise or interference.	Move away from any cordless telephones or electrical appliances or other devices that may cause interference.
My remote doesn't work.	Make sure that the IR sensors are not obstructed. It may be time to replace the battery in the remote.
The minimum volume level is too loud or the maximum volume is too quiet.	Adjust the line out level on your XM Radio.

Technical Information

Dimensions

XM Compact Sound System	300mm(W) X 93mm(H) X 120mm(D) 11.80 in(W) X 3.66 in(H) X 4.72 in (D)
Adapter	49mm(W) X 78mm(H) X 35mm(D) 1.93 in(W) X 3.07 in(H) X 1.37 in (D)
Remote	40mm (W) X 119mm(H) X 14mm (D) 1.57 in (W) X 4.68 in(H) X 0.55 in (D)

Weight

XM Audio System	2.27 Kg	5.00 lbs
Adapter	0.14 Kg	0.30 lbs
Remote	0.04 Kg	0.08 lbs

Inputs and Outputs

XM antenna input	SMB connector
Aux In	3.5mm diameter mini stereo jack
Headphone output	3.5 mm diameter mini stereo jack

Power

DC	12V ---2amps
Remote power	3V CR2032

Temperature

Operating	-25°C ~ 70°C	-13°F ~ 158°F
Storage	-40°C ~ 70°C	-40°F ~ 158°F

Audio

Power	Minimum power of 15.2 watts RMS at 1% THD at 12 volts 100Hz
Frequency response	100 Hz – 20KHz @ +/- 3db

Suitable Receivers (sold separately)

Audiovox Xpress	Audiovox Xpress ^{EZ}
Audiovox Xpress ^R	Audiovox Xpress ^{RC}
Delphi RoadyXT [®]	Delphi SKYFi3 [®]
Pioneer inno TM (with XM2go Boombox Adapter)	Delphi Xpress ^{RC}
Samsung Helix TM (with XM2go Boombox Adapter)	Pioneer XMP3 TM

FCC Statement

The user is cautioned that changes or modifications not expressly approved by XM Satellite Radio Inc. can void the user's authority to operate this device.

This device has been designed to operate with the antenna provided in the original packaging. Use of antenna other than the antenna provided will result in improper operation, and is strictly prohibited per regulations of Industry Canada.

This device complies with Part 15 of the FCC Rules and is certified to Industry Canada's RSS-210 specification:

1. This device may not cause harmful interference.
2. This device must accept any interference received, including interference that may cause undesired operation.

This equipment has been tested and found to comply with the limits for a Class B digital device, pursuant to Part 15 of the FCC Rules and Industry Canada RSS-210. These limits are designed to provide reasonable protection against harmful interference in a residential installation.

This equipment generates, uses, and can radiate radio frequency energy and, if not installed and used in accordance with the installation instructions, may cause harmful interference to radio communications. However, there is no guarantee that interference will not occur in a particular installation. If this equipment does cause harmful interference to radio or television reception, which can be determined by turning the equipment off and on, the user is encouraged to try to correct the interference by one or more of the following measures:

- Reorient or relocate the receiving antenna of the affected receiver.
- Increase the separation between the XM equipment and the affected receiver.
- Connect the XM equipment into an outlet on a circuit different from that to which the affected receiver is connected.
- Consult the dealer or an experienced radio/TV technician for help.

WARNING! The FCC and FAA have not certified this Satellite Radio Receiver for use in any aircraft (neither portable nor permanent installation). Therefore, XM Satellite Radio cannot support this type of application or installation.

Warranty



AUDIOVOX

12 Month Limited Warranty

AUDIOVOX ELECTRONICS CORPORATION (the Company) warrants to the original retail purchaser of this product that should under normal use and conditions, be proven defective in material or workmanship within 12 months from the date of original purchase, such defect(s) will be repaired or replaced with new or reconditioned product (at the Company's option) without charge for parts and repair labor.

To obtain repair or replacement within the terms of this Warranty, the product is to be delivered with proof of warranty coverage (e.g. dated bill of sale), specification of defect(s), transportation prepaid, to an approved warranty station or the Company at the address shown on the next page.

This Warranty does not extend to the elimination of externally generated static or noise, to costs incurred for installation, removal or reinstallation of the product, damage to speakers from extended play at excessive volumes, malfunction of satellite transmissions, repeater signal or receiver unit.

This Warranty does not apply to any product in the opinion of the Company that has been damaged through alteration, improper installation, mishandling, misuse, neglect, accident, or by removal or defacement of the factory serial number/bar code label(s).

THE EXTENT OF THE COMPANY'S LIABILITY UNDER THIS WARRANTY IS LIMITED TO THE REPAIR OR REPLACEMENT PROVIDED ABOVE AND, IN NO EVENT, SHALL THE COMPANY'S LIABILITY EXCEED THE PURCHASE PRICE PAID BY PURCHASER FOR THE PRODUCT.

This Warranty is in lieu of all other express warranties or liabilities. ANY IMPLIED WARRANTIES, INCLUDING ANY IMPLIED WARRANTY OF MERCHANTABILITY, SHALL BE LIMITED TO THE DURATION OF THIS WRITTEN WARRANTY. ANY ACTION FOR BREACH OF ANY WARRANTY HEREUNDER MUST BE BROUGHT WITHIN A PERIOD OF 24 MONTHS FROM DATE OF ORIGINAL PURCHASE. IN NO CASE SHALL THE COMPANY BE LIABLE FOR ANY CONSEQUENTIAL OR INCIDENTAL DAMAGES FOR BREACH OF THIS OR ANY OTHER WARRANTY. No person or representative is authorized to assume for the Company any liability other than expressed herein in connection with the sale of this product.

Some states do not allow limitations on how long an implied warranty lasts or the exclusion or limitation of incidental or consequential damage so the above limitations or exclusions may not apply to you. This Warranty gives you specific legal rights and you may also have other rights which vary from state to state.

U.S.A. : AUDIOVOX ELECTRONICS CORPORATION, 150 MARCUS BLVD., HAUPPAUGE, NEW YORK 11788 1-800-645-4994

CANADA : CALL 1-800-645-4994 FOR LOCATION OF WARRANTY STATION SERVING YOUR AREA

Notes:



XMAS100

Audiovox Electronics Corporation
150 Marcus Blvd.
Hauppauge, New York 11788
U.S.A.
1 800 645 4994

www.audiovox.com

XM name and related logos are registered trademarks of XM Satellite Radio Inc.
All other trademarks are property of their respective owners.

Free Manuals Download Website

<http://myh66.com>

<http://usermanuals.us>

<http://www.somanuals.com>

<http://www.4manuals.cc>

<http://www.manual-lib.com>

<http://www.404manual.com>

<http://www.luxmanual.com>

<http://aubethermostatmanual.com>

Golf course search by state

<http://golfingnear.com>

Email search by domain

<http://emailbydomain.com>

Auto manuals search

<http://auto.somanuals.com>

TV manuals search

<http://tv.somanuals.com>