



AUDIOVOX®
ELECTRONICS CORP.

Mobile/Home DVD Video Player

MVDVD2 Operating Manual



For Customer Service
Visit Our Website At
www.audiovox.com
Product Information, Photos
FAQ's, Owner's Manuals

Safety Precautions

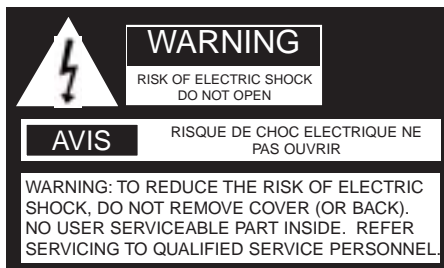

The lightning flash with a arrowhead symbol within an equilateral triangle is intended to alert the user to the presence of uninsulated "dangerous voltage" within the product's enclosure that may be of sufficient magnitude to constitute a risk of electric shock to persons.



The exclamation point within an equilateral triangle is intended to alert the user to the presence of important operating and maintenance (servicing) instructions in the literature accompanying the appliance.

CAUTION: TO PREVENT ELECTRIC SHOCK, MATCH WIDE BLADE OF PLUG TO WIDE SLOT, FULLY INSERT.

ATTENTION: POUR EVITER LES CHOCS ELECTRIQUE, INTRODUIRE LA LAME LA PLUS LARGE DE LA FICHE DANS LA BORNE CORRESPONDANTE DE LA PRISE ET POUSSER JUSQU AU FOND.

CAUTION: This digital video disc player employs a Laser System. To ensure proper use of this product, please read this owner's manual carefully and retain for future reference. Should the unit require maintenance, contact an authorized service location - see warranty. Use of control adjustment or the performance of procedures other than those specified may result in hazardous radiation exposure.

To prevent direct exposure to the laser beam, do not try to open the enclosure.

Visible laser radiation when open and interlocks defeated.

DO NOT STARE INTO THE LASER BEAM.

Safety Precautions

FCC NOTICE: This equipment has been tested and found to comply with the limits for a Class B digital device, pursuant to part 15 of the FCC Rule. These limits are designed to provide reasonable protection against harmful interference in a residential installation.

This equipment generates, uses, and can radiate radio frequency energy and if not installed and used in accordance with the instructions, may cause harmful interference to radio communications. However, there is no guarantee that interference will not occur in a particular installation. If this equipment does cause harmful interference to radio or television reception, which can be determined by turning the equipment off and on, the user is encouraged to try to correct the interference by one or more of the following measures:

- Reorient or relocate the receiving antenna
- Increase the separation between the equipment and receiver.
- Connect the equipment to an outlet on a circuit different from that to which the receiver is connected.
- Consult the dealer or an experienced radio/TV technician for help.

WARNING: Any modifications of the units on factory settings besides setup menu are the responsibility of the user.

In the space provided below, record the Model and Serial No. located on the rear panel of your DVD video player.

Model No. _____ Serial No. _____

Retain this information for future reference.

Important Safety Instructions

CAUTION:

PLEASE READ AND OBSERVE ALL WARNINGS AND INSTRUCTIONS GIVEN IN THIS OWNER'S MANUAL AND THOSE MARKED ON THE UNIT. RETAIN THIS BOOKLET FOR FUTURE REFERENCE.

This set has been designed and manufactured to assure personal safety. Improper use can result in electric shock or fire hazard. The safeguards incorporated in this unit will protect you if you observe the following procedures for installation, use and servicing. This unit is fully transistorized and does not contain any parts that can be repaired by the user.

DO NOT REMOVE THE CABINET COVER, OR YOU MAY BE EXPOSED TO DANGEROUS VOLTAGE. REFER SERVICING TO QUALIFIED SERVICE PERSONNEL ONLY.

1. Read The Owner's Manual After Unpacking This Product.

Read the owner's manual carefully, and follow all the operating and other instructions.

2. Power Source

This product should be operated only from the type or power source indicated on the marketing label. If you are not sure of the type of power supply to your home, consult your product dealer or local power company. For products intended to operate from battery power, or other sources, refer to the operating instructions.

3. Ventilation

Slots and openings in the cabinet are provided for ventilation and to ensure reliable operation of the product and to protect it from over-heating. The openings must not be blocked or covered. The openings should never be blocked by placing the product on a bed, sofa, rug or the similar surface. This product should not be placed in a built-in installation such as a bookcase or rack unless proper ventilation is provided or the manufactured instructions have been adhered to.

Important Safety Instructions

Continued

4. Heat

The product should be situated away from heat sources such as radiators, heat registers, stoves, or other products (including amplifiers) that produce heat.

5. Water and Moisture

Do not use this product near water - for example, near a bath tub, wash bowl, kitchen sink, or laundry tub, in a wet basement, or near a swimming pool.

6. Cleaning

Unplug this product from the wall outlet before cleaning. Do not use liquid cleaners or aerosol cleaners. Use a damp cloth for cleaning.

7. Power-cord Protection

Power-supply cords should be routed so that they are not likely to be walked on or pinched by items placed upon or against them, paying particular attention to cords at plugs, convenience receptacles, and the point where they exit from the product.

8. Overloading

Do not overload wall outlets. Extension cords or integral convenience receptacles such as this can result in a risk of fire or electric shock.

9. Lightning

For added protection for this product during storms, or when it is left unattended and unused for long periods of time, unplug it from the wall outlet. This will prevent damage to the product due to lightning and power-line surges.

10. Object and Liquid Entry

Never push objects of any kind into this product through openings as they may touch dangerous voltage points or short-out parts that could result in a fire or electric shock. Never spill liquid of any kind on the product.

11. Attachments

Do not use attachments not recommended by the product manufacturer as they may cause hazards.

Important Safety Instructions

12. Disc Tray

Keep your fingers well clear of the disc tray as it is closing. It may cause serious personal injury or do damage to the machine.

13. Burden

Do not place a heavy object on or step on the product. The object may fall, causing serious personal injury and serious damage to the product.

14. Safety Check

Upon completion of any service or repairs to this product, ask the service technician to perform safety checks to determine that the product is in the proper operating condition.

15. Disc

Do not use a cracked, deformed, or repaired disc. These discs are easily broken and may cause serious personal injury and product malfunction.

16. Damage Requiring Service

Unplug this product from the power port and refer servicing to qualified service personnel under the following conditions.

- a. When the power-supply cord or plug is damaged.
- b. If liquid has been spilled, or objects have fallen into the product.
- c. If the product has been exposed to rain or water.
- d. If the product does not operate normally by following the operating instructions. Adjust only those controls that are covered by the operating instructions. Improper adjustments of other controls may result in damage and will then require extensive work by a qualified technician to restore the product to its normal operation
- e. When the product exhibits a distinct change in performance a need for service is indicated.

Important Safety Instructions

17. Servicing

Do not attempt to service this product yourself as opening or removing covers may expose you to dangerous voltage or other hazards. Refer all servicing to qualified service personnel

18. Replacement Parts

When replacements parts are required, be sure the service technician has used replacement parts specified by the manufacturer or the same substitutions may results in fire, electric shock, or other hazards.

19. Grounding or Polarization

This product may be equipped with a polarized alternating current line plug (a plug having one blade wider than the other). This plug will fit into the power outlet only one way. This is a safety feature. If you are unable to insert the plug fully into the outlet, try reversing the plug. If the plug should still fail to fit, contact your electrician to replace your obsolete outlet. Do not defeat the safety purpose of the polarized plug.

20. Temperature

If your car was parked in direct sunlight resulting in a considerate rise in temperature inside the car, allow the unit to cool off before operating it.

Precautions

Handling Your DVD

- When Shipping the DVD video player, the original shipping carton and packing materials should be used. For maximum protection, repack the unit as it was originally packed at the factory.
- Do not use volatile liquids, such as insect spray, near the DVD video player. Do not leave rubber or plastic products in contact with the DVD video player for a long time. They will leave marks on the finish.
- The top and rear panels of the DVD video player may become warm after a long period of use. This is not a malfunction.
- When the DVD video player is not in use, be sure to remove the disc and turn off the power.
- If you do not use the DVD video player for a long period of time, the unit may not function properly in the future. Turn on and use the DVD video player occasionally.

Where to Locate Your DVD

When you place this DVD video player near a TV, radio or video cassette recorder (VCR), the playback picture may become poor and the sound may be distorted. In this case, place the DVD video player away from the TV, radio or VCR.

Cleaning Your DVD

Use a soft, dry cloth for cleaning.

- For stubborn dirt, soak the cloth in a weak detergent solution, wring well and wipe. Use a dry cloth to wipe it dry. Do not use any type of solvent, such as thinner or benzine, as they may damage the surface of the DVD video player.
- If you use a chemical saturated cloth to clean the unit, follow that product's instructions.

Precautions

To Obtain a Clear Picture

The DVD video player is a high technology, precision device. If the optical pick-up lens and disc drive parts are dirty or worn down, the picture quality becomes poor. To obtain a clear picture, we recommend regular inspection and maintenance (cleaning or parts replacement) every 1,000 hours of use depending on the operating environment. For details, contact your nearest dealer.

Beware of Moisture Condensation

Moisture condensation damages the DVD video player. Please read the following carefully.

Moisture condensation occurs, for example, when you pour a cold drink into a glass on a warm day. Drops of water form on the outside of the glass. In the same day, moisture may condense on the optical pick-up lens inside this unit, one of the most crucial internal parts of the DVD video player.

- Moisture condensation occurs during the following cases:
 - *When you bring the DVD video player directly from a cold place to a warm place.*
 - *In summer, when you use the DVD video player in a hot and humid place just after you move the unit from an air conditioned room.*
 - *When you use the DVD video player in a humid place.*
- Do not use the DVD video player when moisture condensation may occur.

Table of Content

Introduction	1	Selecting Subtitles	30
Safety Precautions	2 - 3	Using the On-Screen Display	31
Important Safety Instructions	4 - 7	Setting the Parental Lock ...	32 - 33
Precautions	8 - 9	Customizing the Function Settings	34
Identification of Control	11	Notes on Discs	35 - 37
Remote Control	12 - 13	Before Calling Service Personnel	38 - 39
What is MP3 and VCD ?.....	14 - 16	Specifications	40
Playing Back a Disc	17 - 21	Memo	41 - 42
Locating a Specific Title, Chapter or Track	22 - 26	Warranty	43 - 44
Zooming a Picture	27		
Selecting the Camera Angle/ Selecting a Language	28 - 29		

Identification of Control

FRONT PANEL

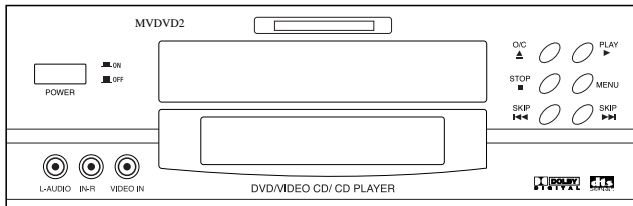

BACK PANEL

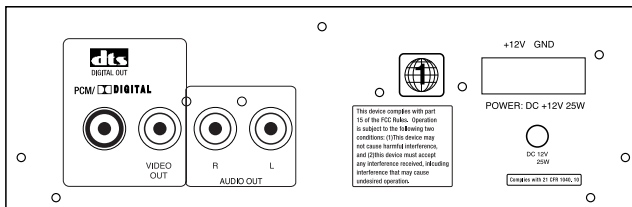

INSTALLATION

MOUNTING

When choosing a mounting location, the DVD unit should be stable and in a position where sufficient cooling is available. Before mounting, attach the supplied brackets and hardware for top or bottom mount.

Plug the supplied cigarette lighter adaptor cord into the back of the DVD unit and run the wire to a accessory power outlet. (Some vehicles do not have accessory power outlets. In this case, the cigarette lighter must be used.) The unit can also be hard wired by connecting wires from the terminal block located on the rear panel of the DVD unit to a 12V DC power source (be sure to observe correct polarity). Plug the supplied yellow video cable into the video output of the DVD unit and plug the other end into the video input of the monitor (not supplied). Repeat this process with the red and white audio cords. You are now ready to turn on the power, check the display, insert a movie and press play to begin DVD operation.

Remote Control

OPERATING WITH THE REMOTE CONTROL

Operating DVD video player with the remote control.

1

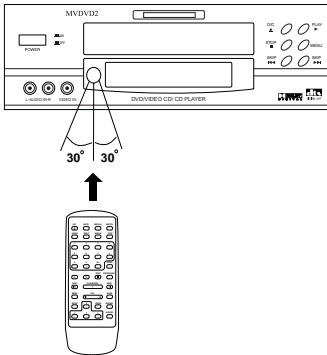

The remote control must be pointed at the remote sensor, in order for the DVD player to function correctly.

Distance: Maximum of 22 feet (7 meters) from the front of the remote sensor.

Angle: Approximately 30° each side of front-and-center.

**Please do not place the remote sensor towards any strong light source such as direct sunlight or illumination. The DVD video player will malfunction if you do so.*

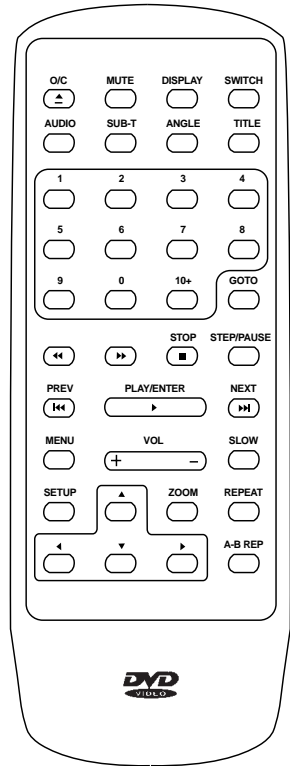

NOTE:

- The remote control should be aimed directly towards the remote sensor of the DVD video player.
- Avoid dropping the remote control.
- Avoid spilling any liquids and/or extreme heat.

Remote Control

PREPARING THE REMOTE CONTROL

To operate the DVD video player, insert the batteries into the remote control as follows:

1

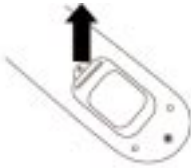

Open the cover.

2

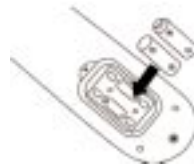

Insert batteries (AA size).

Make sure to match the + and - on the batteries to the marks inside the battery compartment.

3



Close the cover.

NOTE:

Since incorrect use of batteries might cause them to leak or corrode, observe the following precautions:

- Do not install the batteries in the wrong direction.
- It is dangerous to charge/heat/open or short-circuit the batteries.
- Do not leave dead batteries or mix old/new batteries in the remote control.
- When not using the remote control for a long period of time, remove the batteries.
- When difficulties occur with the remote control, or if the operating range becomes reduced, then replace the batteries.
- If leakage from the battery occurs, wipe the battery liquid from the battery compartment, then replace the batteries.

What is MP3 and VCD?

WHAT IS MP3?

MP3 is an audio compression technology. The name MP3 stands for Mpeg1 Audio layer 3 and its compression algorithm is based on a complicated psycho-acoustic model. This model is based on the fact that the human ear can not hear all the audio frequencies. The human hearing range is between 20Hz and 20kHz and is most sensitive between 2kHz and 4 kHz. As a result, the MP3 compression form is destructive, which means that the compression algorithm causes the file to lose some information so that it cannot be restored to its original content.

When compressing an audio file (encoding) using the MP3 algorithm, you can set the desired encoding level to obtain any compression level you want. The larger the compressed file, the better the audio playback quality. The majority of the files available on the internet are encoded in 128 Kbits stereo 44kHz which results in a high-quality file that is 12 times smaller than the original!

WHAT IS VCD?

A VCD is the same size and shape of any regular music CD, and possesses the same digital audio, plus good video capability. It is a new video format that offers exceptional high-end digital picture quality and smoothness, over an hour of playing time, full CD-quality, stereo sound, and more. Using MPEG (Motion Picture Expert Group) compression (1:30), VCD's offer picture quality that is far superior to the Quicktime movies you see on standard VHS tape.

NOTE:

When you play back a video CD, you must turn PBC OFF in order to stop the chapter/scene.

What is MP3 and VCD?

PLAYING IN MP3 FORMAT





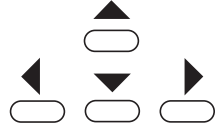

You can play an MP3 CD using a different “PLAY MODE”, such as:





- “FOLDER” (normal playback)
- “FOLDER R” (repeat playback on a specific folder)
- “REP-ONE” (repeat playback on a song)
- “SINGLE” (playback a song only one time)
- “SHUFFLE” (random playback)



1. Insert an MP3 CD, the DVD video player will initialize the disc and the directory (folder) will be shown on the TV screen.

MP3 MENU

	ROOT	0
	BBBBBBBBBBBB	1
	CCCCCCCCCCCC	2
	DDDDDDDDDDDD	3
	EEEEEEEEEEEE	4
	FFFFFFFFFFFF	5

	..	0
<i>MP3</i>	SSSSSSSSSSSS	1
	TTTTTTTTTTTT	2
<i>MP3</i>	VVVVVVVVVVVV	3
	ZZZZZZZZZZZZ	4
	UUUUUUUUUUUU	5

PLAY MODE: FOLDER

2. Press **◀/▶** to select the folder column or MP3 file column or “PLAY MODE” from the menu.

Press **▲/▼** to select a list in the MP3 file folder. In the “PLAY MODE” menu, press **▲/▼** to select the play mode.

What is MP3 and VCD?

PLAYING IN MP3 FORMAT

3. Press **ENTER** to play the MP3 file. Press **▶▶** or **◀◀** during playback to skip the tracks. If you need to return to the main directory (folder), press **STOP** and select the first folder on the upper right column.

NOTE:

- The upper left column is a list showing the name of folder. The upper right column is a list showing the name of song and the sub-folder.
- Fast Forward **◀◀** or Fast Reverse **▶▶** are not available during MP3 playback.
- The “” icon in front of a file name indicates that this is a folder, not an MP3 file.
- An “MP3” designation in front of a file name indicates that this is an MP3 file.
- During MP3 playback, you cannot access the “PLAY MODE” folder or songs.
- You are allowed a maximum of 11 characters for each folder and/or song.
- For “SHUFFLE” playback, you are permitted random playback in a folder only.

Playing Back A Disc

This section shows you the basics on how to play back a disc.

WARNING

Keep your fingers well clear of the disc tray as it closes. Otherwise cause serious personal injury could result.

BASIC PLAYBACK

Preparations

- When you wish to play back DVD video discs, or a VIDEO CD, turn on the TV and select the video input source connected to the DVD video player.
- When you wish to enjoy DVD sound from the audio system, turn on the audio system and select the input source connected to the DVD video player.
- Using the on-screen displays, set the playback picture size according to the aspect ratio of the TV being used.
- If you do not have the necessary equipment to enjoy Dolby Digital Sound, set the "AUDIO OUTPUT" to "ANALOG" using the on-screen displays.

1. Press the **POWER** button on the front panel.

The POWER indicator illuminates as the DVD video player turns on.



POWER

2. Press and release the **OPEN/CLOSE** button.

This will open the disc tray.

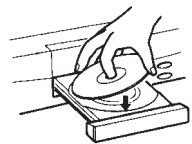

3. Place the disc on the disc tray.

Be sure the playback side is facing down (label side up).

4. Press and release the **OPEN/CLOSE** button; then press **PLAY/ENTER**.

After the disc tray closes, playback will start. As the DVD video player is reading the disc, a menu will appear on screen.



PLAY/ENTER

CAUTION

- To open and close the disc tray, only use the OPEN/CLOSE button on the remote control or DVD video player.
- Do not force or place anything other than a DVD video disc, VIDEO CD, audio CD, or MP3 CD on the disc tray.

Playing Back A Disc

FOR A HIGHER QUALITY PICTURE

Occasionally, some picture noise, not usually present with a normal broadcast may appear on the TV screen while playing back a DVD video disc. This may occur because the high resolution pictures on these discs include a lot of information. While the amount of noise depends on the TV you use with this DVD video player, you should generally reduce the sharpness adjustment on your TV when viewing DVD video discs.

ABOUT DVD VCD CD

The **DVD VCD** or **CD** icons will appear on the heading bar depending on the disc being played back.

DVD: DVD video discs

VCD: VIDEO CDs

CD: Audio CDs

HOW TO START PLAYBACK FROM THE MENU SCREEN

1. Press **▲/▼/◀/▶**, or the number buttons, to select the title.

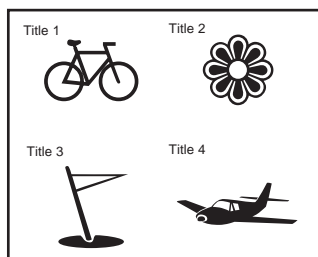
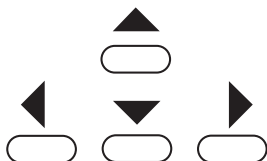

2. Press the **PLAY/ENTER** button.

The DVD video player will start playback from the title selected.

PLAY/ENTER



Playing Back A Disc

Continued

HOW TO STOP PLAYBACK

Press the STOP button.

The DVD video player will stop.

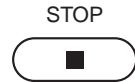

Press the PLAY/ENTER button to replay.

Press STOP again.

The DVD video player returns to chapter 1 or track 1.

HOW TO REMOVE THE DISC

Press and release the OPEN/CLOSE button.

Wait until the disc tray is completely open before removing any disc.

After removing the disc, press the OPEN/CLOSE button to close the disc tray.

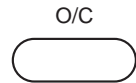

NOTE:

At the completion of each movie, a menu screen will appear. Be aware that the on-screen menu may damage your TV by permanently burning that image onto the screen. To avoid this, press the STOP button at the completion of each movie. You may also decide to setup an imitation of a SCREEN SAVER.

ADVANCED PLAYBACK

The DVD video player allows you to play back discs at various speeds. You may also resume playback from the point at which playback stopped.



Playing Back A Disc

PLAYING AT 2X, 4X, 6X, OR 8X THE NORMAL SPEED

You can play back a disc at 2x, 4x, 6x, or 8x the normal speed.

Press the REW or FWD button during playback.

The playback speed becomes 2x the normal speed.

The playback speed changes each time you press the REW or FWD button.

◀◀ REW: Fast reverse

▶▶ FWD: Fast forward

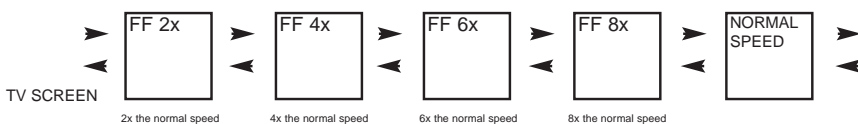

• Video

CD, Audio CD

The reverse or forward playback alternates between 1x, 2x, 3x, 4x speed.

TO RESUME NORMAL PLAYBACK.

Press PLAY/ENTER.

PLAY/ENTER



NOTE:

- The DVD video player will not play back sound and subtitles during reverse scan and forward playback of DVD video discs. During fast forward or fast reverse playback of audio CDs, the DVD video player will also play sound.
- The speeds may vary slightly from disc-to-disc, and the 2x, 4x, 6x, and 8x speeds are approximate speeds only.
- An MP3 CD does not contain this feature.

PLAYING FRAME BY FRAME

Press the STEP button during playback.

The picture will advance one frame each time you press the STEP button.

TO RESUME NORMAL PLAYBACK.

Press PLAY/ENTER.

PLAY/ENTER



PAUSE/STEP

NOTE:

- During frame-by-frame playback, the sound is muted.
- Basic and MP3 CDs do not have this feature.

Playing Back A Disc

PLAYING IN SLOW-MOTION

A disc can also be played back in slow-motion.

TV SCREEN (FORWARD)

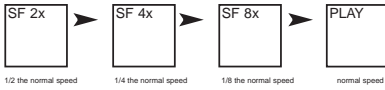

TV SCREEN (REVERSE)

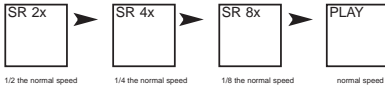

The playback speed becomes 1/2, 1/4, or 1/8 of the normal speed each time you press the SLOW button. (This feature is the same for reverse slow play.)

TO RESUME NORMAL PLAYBACK.
Press PLAY/ENTER.

PLAY/ENTER



NOTE:

- During slow-motion playback, the sound is muted.
- Basic and MP3 CDs do not have this feature.

RESUMING PLAYBACK FROM THE SAME LOCATION

This DVD video player allows you to stop playback and continue playback later from the same location on the disc.

1. Press the STOP button.

This will interrupt the playback and the DVD video player will memorize the location where playback stopped.

STOP



2. Press the PLAY/ENTER button.

The DVD video player will resume playback from the location where playback stopped.

PLAY/ENTER



NOTE:

- The following actions will cancel the RESUME function:
 - Unplugging the DVD video player after you stop playback.
 - Ejecting the disc.
 - Adjusting/changing the parental lock, or selecting a different language setting.
- On occasion, depending on the disc type, you may experience a difference of location where playback resumes.
- Basic and MP3 CDs do not have this feature.
- Using the front AUX A/V inputs.

Locating a Specific Title, Chapter or Track

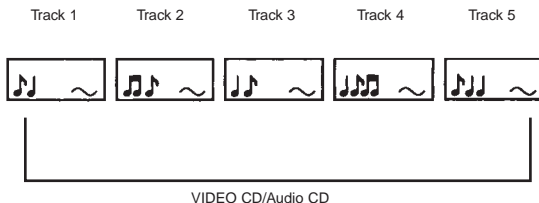

DVD VIDEO DISCS ARE NORMALLY DIVIDED INTO TITLES. THE TITLES ARE SUB-DIVIDED INTO CHAPTERS. MOREOVER, VIDEO, AUDIO and MP3 CDs ARE DIVIDED INTO TRACKS. YOU CAN CONVENIENTLY LOCATE ANY SPECIFIC TITLE, CHAPTER, OR TRACK WITH THIS DVD VIDEO PLAYER.

LOCATING A TITLE USING THE TITLE MENU

You can locate a specific title using the title menu function, if a DVD video disc contains a title menu.

1. Press the **TITLE** button.

On the TV screen, the title menu will appear.



2. Press the **▲/▼/◀/▶** button to select the title you want.

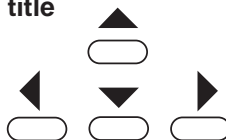

You can also directly locate a specific title by pressing its assigned number with the number buttons.

3. Press the **ENTER** button.

This will cause the DVD video player to start playback from chapter 1 of the title selected.

NOTE:

- You may experience that some discs will not respond to this function.
- If different instructions appear on the TV screen, follow those instructions. The preceding instructions describe the basic procedure; these procedures may vary depending on the contents of the DVD video disc.

Locating a Specific Title, Chapter or Track

Continued

LOCATING A TITLE

If a DVD video disc contains title numbers, you can locate a specific title by directly selecting a title number.

1. Press **GOTO** during playback.

Make sure that the space next to **TITLE** is highlighted.

Example of a title menu.



TITLE: 02 02 CHAPTER: 03/03

2. Press the **▲/▼/◀/▶** buttons to select the title and chapter you want.

3. Press the corresponding number buttons for the title you want.

e.g.: To select title 2

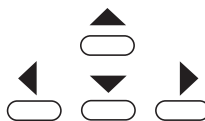

TITLE: 02 02 CHAPTER: 03/03

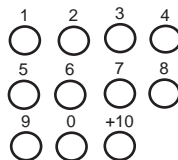

4. Press **PLAY/ENTER**.

The DVD video player starts playback from chapter 3 of selected title 2.

PLAY/ENTER



NOTE:

- You can press GOTO twice to select the time.
- You can shift the highlight between TITLE and CHAPTER by pressing ▲/▼/◀/▶.
- Pressing the CLEAR button resets the TITLE and CHAPTER numbers.

Locating a Specific Title, Chapter or Track

SWITCHING BETWEEN TWO VIDEO SOURCES

The SWITCH button on the remote control is used to switch between the DVD video player display and the external device connected to the A/V inputs on the front panel of the DVD video player.

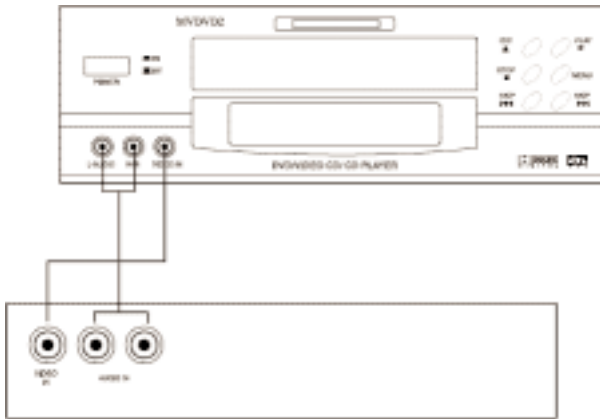
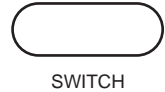

LOCATING A SPECIFIC CHAPTER OR TRACK

This DVD video player allows you to locate consecutive chapters or tracks.

Press the **SKIP**  or  button repeatedly to **display the requested chapter or track.**



The DVD video player starts playback from the selected chapter or track.

How to locate preceding chapters or tracks.

- When you press the **SKIP**  button, the DVD video player starts playback from the beginning of the preceding chapter or track.

How to locate succeeding chapters or tracks.

- When you press the **SKIP**  button, the DVD video player starts playback from the beginning of the succeeding chapter or track.

Note: On some discs the titles may not display the sub-divided chapters.

Repeating a Specific Title, Chapter or Track

Continued

THIS DVD VIDEO PLAYER ALLOWS YOU TO PLAY BACK A SPECIFIC TITLE, CHAPTER, TRACK, OR SEGMENT REPEATEDLY. (TITLE REPEAT, CHAPTER/TRACK REPEAT, A-B REPEAT)

HOW TO REPEAT A TITLE, CHAPTER, OR TRACK

1. Select the title, chapter, or track you want to repeat.

2. Press the REPEAT button.



REPEAT

The repeat mode changes, each time you press the REPEAT button.

DVD video disc

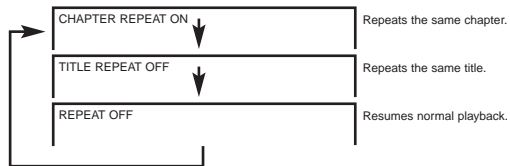

Repeating a Specific Segment

HOW TO REPEAT A SPECIFIC SEGMENT

1. Press the A-B button at the beginning of the segment in which you want to repeat playback. (point A)

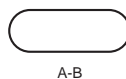

2. Press the A-B button again at the end of the segment. (point B)

The DVD video player will automatically return to point A and start to repeat playback of the selected segment (A-B).

3. Press the A-B button to cancel the A-B repeat function.

The DVD video player will revert to normal playback mode.

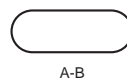
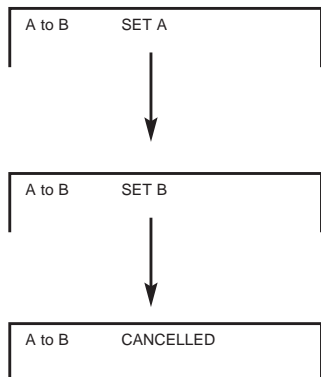

NOTE:

- Depending on the disc, you may experience a difference between point A and the location where playback actually resumes.
- If a segment allows for multiple camera angles, you can not set the A-B repeat function.
- Be aware that some discs will not respond to the A-B repeat function.
- Basic and MP3 CDs do not have this feature.

Zooming a Picture

ZOOMING A PICTURE

You can zoom a picture. You can shift the zoom point as well.

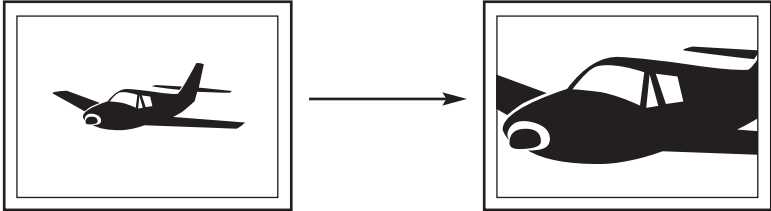

Press ZOOM during normal playback or slow - motion.

The DVD video player magnifies in the center of the picture.

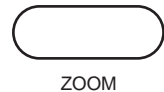
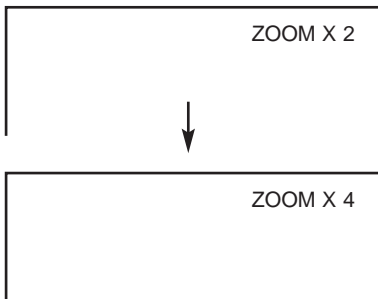

If you press **▲/▼/◀/▶** during zoom playback, the zoom point shifts.

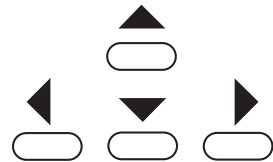

TO RESUME NORMAL PLAYBACK.

Press ZOOM during zoom playback.

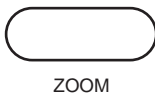

NOTE:

- When the DVD video player is turned off, or if the discs are removed, the program item will be removed.
- Depending on the disc, the program playback may not function.

Selecting the Camera Angle/Selecting a Language

THIS DVD VIDEO PLAYER ALLOWS YOU TO SELECT FROM SEVERAL DIFFERENT ANGLES AND LANGUAGES.

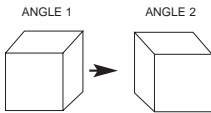

Selecting the camera angle

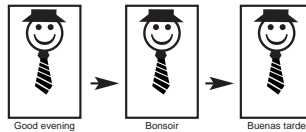

Selecting a language

HOW TO CHANGE THE CAMERA ANGLE

If the DVD video disc was recorded from multiple angles, you have the option of changing the camera viewing angle of the scene you are watching.

1. Press the **ANGLE** button while playing back a scene recorded with multiple angles.

- You may only press the ANGLE button when the angle icon  is flashing on the DVD display.
- Each time you press the ANGLE button, the angle will change.

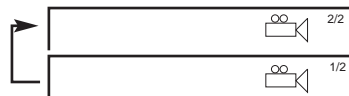
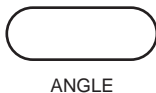

NOTE:

- The angle function will not operate on DVD video discs that do not contain recorded multiple angles.
- During still playback, you are able to change the camera angle. However, when you resume normal playback, the camera angle changes to the new settings.
- The angle icon indicator will illuminate while playing back a title that contains at least one scene recorded from multiple angles.

Selecting the Camera Angle/Selecting a Language

HOW TO SELECT A PLAYBACK AUDIO SETTING

This DVD video player allows you to select a preferred language and sound recording system from those included on the DVD video disc.

1. Press the AUDIO button during playback.

AUDIO

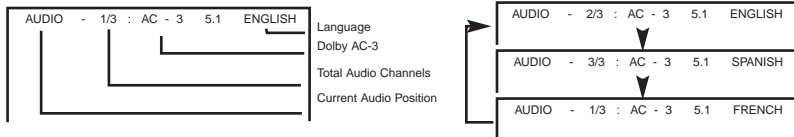

2. Press the AUDIO button again to cycle backwards.

Recording systems

This DVD video player uses the Dolby Digital, MPEG 2, and PCM recording DTS systems. It cannot play back DVD video discs recorded in any other recording system.

NOTE:

- The player returns to the initial default settings when you turn on the DVD video player or replace a disc.
- The DVD video player plays a pre-programmed sound on the disc if you select a sound which is not included on the disc.

Selecting Subtitles

THIS DVD VIDEO PLAYER ALLOWS YOU TO DISPLAY THE DISC SUBTITLES ON YOUR TV SCREEN.



Good evening



Bonsoir



Buenas tardes

HOW TO DISPLAY SUBTITLES

You have the option to select a preferred subtitle from those included on the DVD video disc.

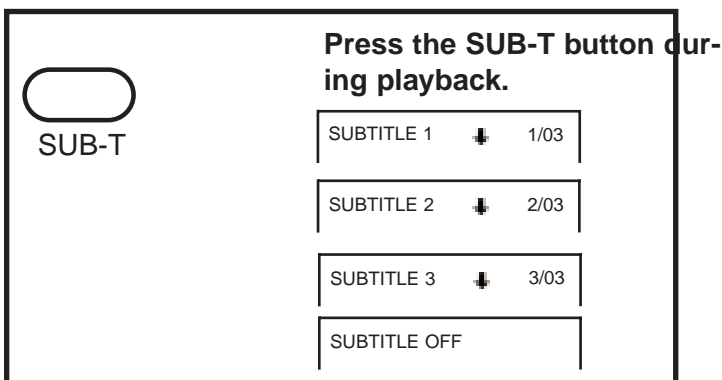

To TURN OFF the subtitles.

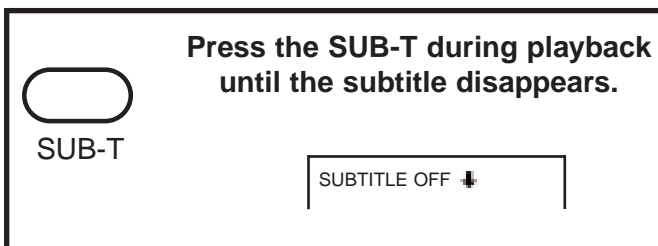

NOTE:

- Due to the nature of some DVD video discs, you may not be able to turn off the subtitles, and they will appear on screen automatically.
- As you press the SUB-T button, the subtitles may not appear immediately during some scenes.
- If the subtitles continue to show on your TV even after the DVD has been turned off, please refer to the TV's close caption settings.

Using the On-Screen Display

YOU CAN VIEW INFORMATION ABOUT A DISC AND ITS OPERATIONAL STATUS ON THE TV SCREEN.

CHECKING THE OPERATIONAL STATUS

You can view the current title number, track number, and total playing time of the disc on the TV screen.

Press **DISPLAY** during playback.

DISPLAY

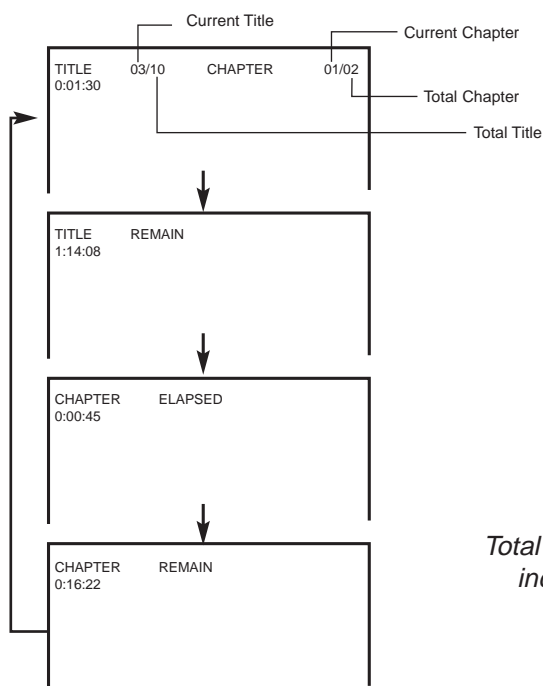

Total playing time of the disc is included in the DVD display.

TO TURN OFF THE ON-SCREEN DISPLAY

Press **DISPLAY** Again.

DISPLAY



Setting the Parental Lock

YOU CAN USE THE PARENTAL LOCK FUNCTION ONLY WITH DVD VIDEO DISCS EQUIPPED WITH THE PARENTAL LOCK FEATURE.

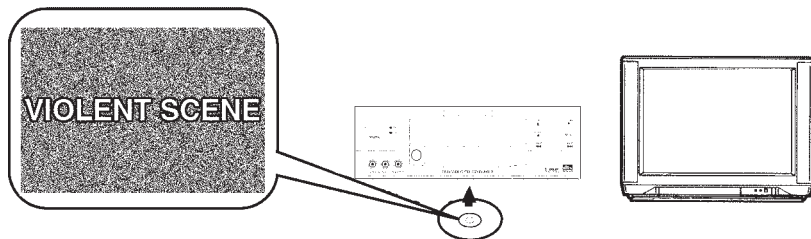

SETTING THE PARENTAL LOCK

DVD video discs equipped with the parental lock function are rated according to their content. The contents allowed by a parental lock level, and the way a DVD video disc can be controlled may vary from disc-to-disc. For example, if permitted on the disc, you could edit out violent scenes unsuitable for children and replace them with more suitable scenes, or lock out playback of the disc all together.

1. Press STOP during playback.

Press STOP once.

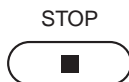

Setting the Parental Lock

2. Press **SETUP**.

The **SETUP MENU** appears on the TV screen.

SETUP

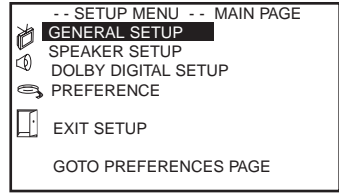
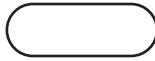

3. Select **PREFERENCE**, press **ENTER**.



PLAY/ENTER

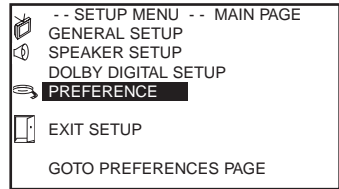

4. Select **PARENTAL**, press **ENTER**.



PLAY/ENTER

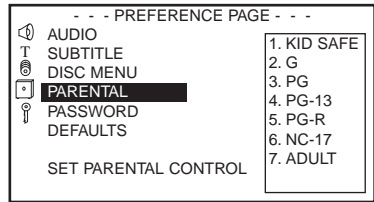

5. Select ratings, press **ENTER**.

6. Enter your password then press **ENTER**.

The pre-set password is **3308**

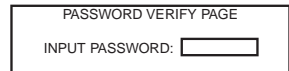

SETUP

7. Press **SETUP** to exit setup, press **PLAY** to start.



TO CHANGE YOUR PASSWORD:

1. Follow step 4 to select password change.
2. Enter old password.
3. Enter new password.
4. Re-enter to confirm your new password.
5. Press **ENTER**.
6. Press **SETUP**.

Customizing the Function Settings

YOU CAN CHANGE THE DEFAULT SETTINGS TO CUSTOMIZE THE PERFORMANCE TO YOUR PREFERENCE.

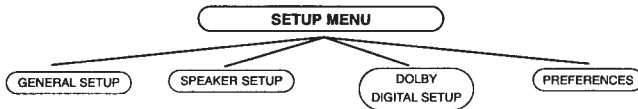

DISPLAYING THE SETUP MENU SCREEN

The SETUP MENU screen asks you to select a setting category from General Setup, Speaker Setup, Dolby Digital Setup, and Preferences. The selected category will provide you the setting details using the succeeding screen.

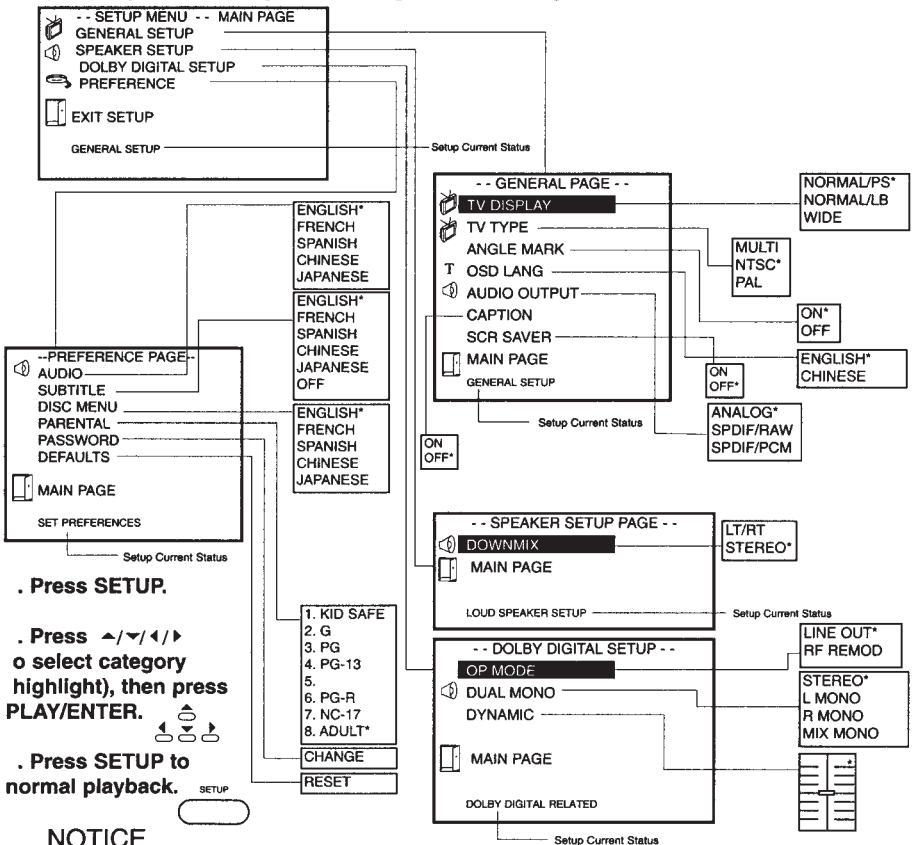

. Press **SETUP**.

. Press **▲/▼/◀/▶** (to select category highlight), then press **PLAY/ENTER**.

. Press **SETUP** to normal playback.

NOTICE

- Preset password is **3308**.
- Highlighted function will be expanded at bottom of the screen.
- The SETUP MENU screen disappears if you press the SETUP button while it is displayed.

• Functions and menu may change without notice.

* Factory defaults

** You must press STOP to set up PREFERENCES.

THIS SECTION SHOWS YOU HOW TO HANDLE, CLEAN, AND STORE DISCS.

ON HANDLING DISCS

- Do not touch the playback side of the disc.
- Do not attach paper or tape to discs.



ON CLEANING DISCS

- Fingerprints and dust on the disc cause picture and sound deterioration. Wipe the disc from the center outward with a soft cloth. Always keep the disc clean.
- If you cannot wipe off the dust with a soft cloth, wipe the disc lightly with a slightly moistened soft cloth and finish with a dry cloth.
- Do not use any type of solvent such as a thinner, benzene, commercially available cleaners or anti-static spray for vinyl LP's. It may damage the disc.



ON STORING DISCS

- Do not store discs in places subject to direct sunlight or near heat sources.
- Do not store discs in places subject to moisture and dust such as a bathroom or near a humidifier.
- Store discs vertically in a case. Stacking or placing objects on discs outside of their case may cause warping.

Notes on Discs

ABOUT THIS OWNER'S MANUAL

This owner's manual explains the basic instructions of this DVD video player. Some DVD video discs are produced in a manner that allows specific or limited operation during playback. As such, the DVD video player may not respond to all operating commands. Refer to the instruction notes of the disc in question.





may appear on TV screen during operation.



means that the DVD video player operation is not permitted, or that the DVD video disc itself will not permit operation.

PLAYABLE DISCS

This DVD video player can play back the following discs.

	Disk Mark	Contains	Disc Size	Maximum playback time
DVD video disc		Audio + Video (moving pictures)	4.72 inches (12 cm)	Approx. 4 hours (double sided disc)
				Approx. 8 hours (double sided disc)
Video CD		Audio + Video (moving pictures)	4.72 inches (12 cm)	Approx. 74 minutes
			3.14 inches (8 cm)	Approx. 20 minutes
Audio CD		Audio	4.72 inches (12 cm)	Approx. 74 minutes
			3.14 inches (8 cm)	Approx. 20 minutes
MP3 CD	MP3	Audio	4.72 inches (12 cm)	Approx. 600+ minutes

Notes on Discs

NOTES ON REGIONAL NUMBERS

The region number of this DVD video player is 1. If region numbers, which stand for their playable area, are printed on your DVD video disc, make sure the disc plays region 1 or ALL. Otherwise, playback will not be allowed by the player (In this case, the DVD video player will display the message - "WRONG REGION".)

NOTES ON COPYRIGHT

This product incorporates copyright protection technology that is protected by method claims of certain U.S. patents and other intellectual property rights owned by Macrovision Corporation and other rights owners. Use of this copyright protection technology must be authorized by Macrovision Corporation, and is intended for home and other limited viewing uses only unless otherwise authorized by Macrovision Corporation. Reverse engineering or disassembly is prohibited.

It is forbidden by law to copy, broadcast, show, broadcast on cable, play in public, and rent copyrighted material without permission. DVD video discs are copy protected, and any recordings made from these discs will be distorted.

Manufactured under license from Dolby Digital Laboratories. 'Dolby' and the Double-D symbol are trademarks of Dolby Laboratories. Confidential unpublished works. ©1992-1997 Dolby Laboratories, Inc. All rights reserved.

DTS and DTS Digital Out are trademarks of Digital Theater System, Inc.

TYPE OF TV SYSTEM

Connect this DVD video player to a TV compatible with a PAL/3.58 NTSC system.

Before Calling Service Personnel

Check the following guide for the possible cause of a problem before contacting service.

SYMPTOMS AND CORRECTION

Symptom	Cause	Correction
No power	<ul style="list-style-type: none"> The power plug is disconnected 	<ul style="list-style-type: none"> Connect the power plug into the power port securely.
No picture	<ul style="list-style-type: none"> The TV is not set to receive DVD output The video cable is not connected securely 	<ul style="list-style-type: none"> Select the appropriate video input mode on the TV so the picture from the DVD video player appears on the TV screen. Connect the video cable into the jacks securely.
No sound	<ul style="list-style-type: none"> The equipment connected with the audio cable is not set to receive DVD signal output. The audio cables are not connected securely. Power to the equipment connected with the audio cable is turned off. The setting of output sound type is not correct. 	<ul style="list-style-type: none"> Select the correct input mode of the audio receiver so you can listen to the sound from the DVD video player. Connect the audio cable into the jacks securely. Turn on the equipment connected with the audio cable. Set the audio setting correctly.
The playback picture has occasional distortion	<ul style="list-style-type: none"> The disc is dirty. It is in fast forward reverse playback. 	<ul style="list-style-type: none"> Eject the disc and clean it. Sometimes a small amount of picture distortion may appear. This is not a malfunction.
Brightness is unstable or noises are produced on playback pictures The DVD video player does not start playback	<ul style="list-style-type: none"> The copy protection's effect. No disc is inserted. 	<ul style="list-style-type: none"> Connect the DVD video player to the TV directly.

Before Calling Service Personnel

The DVD video player does not start playback

- An unplayable disc is inserted.
- The disc is placed upside down.
- The disc is not placed within the guide.
- The disc is dirty.
- A menu is on the TV screen.
- The parental lock function is set.

- Insert a disc. (Check that the DVD or VCD or audio CD indicator in the DVD displays is lit.)
- Insert a playback disc. (Check the disc type and color system).
- Place the disc with the playback side down.
- Place the disc on the disc tray correctly inside the guide.
- Clean the disc.
- Press the SETUP button to turn off the menu screen.
- Cancel the parental lock function or change the parental lock level. (*The Pre-set password is 3308.*)

Buttons do not work

- Power supply fluctuation or other abnormalities such as static electricity may interrupt correct operations.
- The remote control is not pointed at the remote sensor of the DVD video player.

- Turn the power on or off with the POWER button or disconnect the power plug and insert it into the power port again.
- Check each button on the remote, make sure it is in normal position.

The remote control does not work properly

- The remote control is too far from the DVD video player.
- The batteries in the remote control are discharged.

- Point the remote control at the remote sensor of the DVD video player (left side).
- Operate the remote control within approximately 22 feet (7 meters).
- Replace the batteries with new ones.

Specifications

DVD VIDEO PLAYER/OUTPUTS/SUPPLIED ACCESSORIES

DVD VIDEO PLAYER

Power Supply	AC/DC + 12V \pm 1V
Power Consumption	3 AMPS MAX.
Operating Temperature	5° C to 45° C (41° F to 113° F)
Mass	1 kg
External Dimensions	200 x 85 x 300 mm (W/H/D)
Signal System	PAL/NTSC/MULTI
Laser	Semiconductor laser, wavelength 650 nm

OUTPUTS

Video output (Composite video)	1.0 V (p-p), 75 Ω , negative sync., pin jack x 1
Audio output (digital audio)	0.5 V (p-p), 75 Ω , pin jack x 1
Audio output (analog audio)	2.0 V (rms), 330 Ω , pin jack(L,R) x 1

INPUTS

A/V Input (pass through)	1.0 V (p-p), 75 Ω , neg. sync., pin jack x 3
--------------------------	---

SUPPLIED ACCESSORIES

Audio cable (red and white)	1 pair
Video cable (yellow)	1
Remote control	1
Power cord (cigarette lighter adaptor)	1
Batteries (AA)	1 pair
Mounting Brackets	2
Mounting Screws	8

OPTIONAL ACCESSORIES

AC to DC power adaptor	Model #: BPA50112*
*Audiovox Customer Service: 1-800-645-4994	

Design and specifications are subject to change without notice.

DISCS AND OUTPUT SOUNDS

	DVD Video Discs						
Sound recording system	Dolby Digital		MPEG 2		Linear PCM		
					48kHz	96kHz	
Audio setting on the setting screen	SPDIF /RAW	SPDIF /RAW	SPDIF /RAW	SPDIF /PCM	SPDIF /RAW SPDIF /PCM	SPDIF /RAW	SPDIF /PCM
ANALOG AUDIO OUT jacks	—	o	—	o	—	o	o
DIGITAL AUDIO OUT jack	Dolby Digital bitstream	PCM (48kHz)	MPEG 2 bitstream	PCM (48kHz)	PCM (48kHz)	PCM (48kHz)	—

	VCD	CD	MP3 CD
Sound recording system	MPEG/	PCM44.1kHz	MP3
Audio setting on the setting screen	SPDIF /RAW SPDIF /PCM	SPDIF /RAW SPDIF /PCM	SPDIF /RAW SPDIF /PCM
ANALOG AUDIO OUT jacks	—	o	o
DIGITAL AUDIO OUT jack	PCM (44.1kHz)	PCM (44.1kHz)	PCM (44.1kHz)

ON VIDEO CD

This DVD video player supports the VIDEO CD with PBC (Version 2.0) (PBC) which is the abbreviation for Play Back Control.

You can enjoy two kinds of playbacks, depending on types of disc.

TYPE OF DISC	HOW TO ENJOY
VIDEO CD without PBC (VERSION 1.1)	Audio and movie can be played back by operating the unit in the same way as the audio CD.
VIDEO CD with PBC (VERSION 2.0)	In addition to the operation of the VIDEO CD without PBC, you can enjoy a playback with interactive software and software with search function by using the menu displayed on the TV screen (Menu Playback). Some of the functions described in this manual may not work in some discs.

MPEG 1 AUDIO LAYER 3 DISC (MP3)

MP3 Audio Disc Play Back Capable	MP3 audio disc can be played back by operating the unit in the same way as the audio CD.
----------------------------------	--

Warranty



12 MONTH LIMITED WARRANTY

Applies to Audiovox Mobile Video Products

AUDIOVOX CORPORATION (the Company) warrants to the original retail purchaser of this product that should this product or any part thereof, under normal use and conditions, be proven defective in material or workmanship within 12 months from the date of original purchase, such defect(s) will be repaired or replaced with reconditioned product (at the Company's option) without charge for parts and repair labor.

To obtain repair or replacement within the terms of this Warranty, the product is to be delivered with proof of warranty coverage (e.g. dated bill of sale), specification of defect(s), transportation prepaid, to the Company at the address shown below.

This Warranty does not extend to the elimination of externally generated static or noise, to correction of antenna problems, to costs incurred for installation, removal or reinstallation of the product or to damage to tapes, discs, speakers, accessories, or vehicle electrical systems.

This Warranty does not apply to any product or part thereof which, in the opinion of the Company, has suffered or been damaged through alteration, improper installation, mishandling, misuse, neglect, accident or by removal or defacement of the factory serial number/bar code label(s). THE EXTENT OF THE COMPANY'S LIABILITY UNDER THIS WARRANTY IS LIMITED TO THE REPAIR OR REPLACEMENT PROVIDED ABOVE AND, IN NO EVENT, SHALL THE COMPANY'S LIABILITY EXCEED THE PURCHASE PRICE PAID BY PURCHASER FOR THE PRODUCT.

Warranty

Continued

This Warranty is in lieu of all other express warranties or liabilities. ANY IMPLIED WARRANTIES, INCLUDING ANY IMPLIED WARRANTY OF MERCHANTABILITY, SHALL BE LIMITED TO THE DURATION OF THIS WRITTEN WARRANTY. ANY ACTION FOR BREACH OF ANY WARRANTY HEREUNDER INCLUDING ANY IMPLIED WARRANTY OF MERCHANTABILITY MUST BE BROUGHT WITHIN A PERIOD OF 30 MONTHS FROM DATE OF ORIGINAL PURCHASE. IN NO CASE SHALL THE COMPANY BE LIABLE FOR ANY CONSEQUENTIAL OR INCIDENTAL DAMAGES FOR BREACH OF THIS OR ANY OTHER WARRANTY, EXPRESS OR IMPLIED, WHATSOEVER. No person or representative is authorized to assume for the Company any liability other than expressed herein in connection with the sale of this products.

Some states do now allow limitations on how long an implied warranty lasts or the exclusion or limitation of incidental or consequential damage so the above limitations or exclusions may not apply to you. This Warranty gives you specific legal rights and you may also have other rights which vary from state to state.

REMEMBER TO KEEP A RECORD OF YOUR MODEL AND SERIAL NUMBER.

MODEL # _____

SERIAL # _____

WHERE IS SERVICE AVAILABLE?

U.S.A. : AUDIOVOX CORPORATION, 10 MARCUS BLVD.,
HAUPPAUGE, NEW YORK 11788 • 1-800-645-4994

CANADA : CALL 1-800-645-4994 FOR LOCATION OF WARRANTY
STATION SERVING YOUR AREA

Free Manuals Download Website

<http://myh66.com>

<http://usermanuals.us>

<http://www.somanuals.com>

<http://www.4manuals.cc>

<http://www.manual-lib.com>

<http://www.404manual.com>

<http://www.luxmanual.com>

<http://aubethermostatmanual.com>

Golf course search by state

<http://golfingnear.com>

Email search by domain

<http://emailbydomain.com>

Auto manuals search

<http://auto.somanuals.com>

TV manuals search

<http://tv.somanuals.com>