

# AUDIOWOX

## Portable Compact Disc Player with Skip Free Protection

### CE1000X

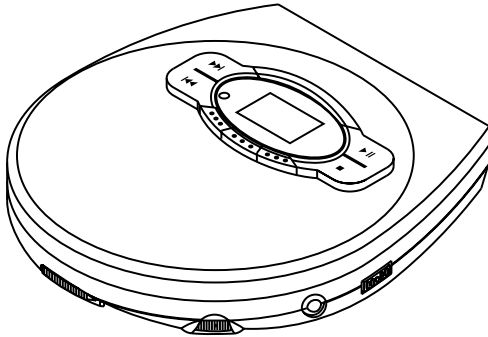

## INSTRUCTION MANUAL

128-6204

Please read this instruction manual carefully before operating the Compact Disc Player.

### WARNING

To prevent fire or shock hazard, do not expose the Compact Disc Player to rain or moisture.

### IMPORTANT

Since the CD circuitry may cause interference to other radio tuners nearby, switch the unit off when not in use or move it away from the affected radio tuner.

This device complies with Part 15 of the FCC Rules, operation is subject to the following two conditions: (1) This device may not cause harmful interference, and (2) this device must accept any interference received, including interference that may cause undesirable operation.

**NOTE:** This equipment has been tested and found to comply within the limits for a Class B digital device, pursuant to Part 15 of the FCC Rules. These limits are designed to provide reasonable protection against harmful interference in a residential installation. This equipment generates, uses and can radiate radio frequency energy and, if not installed and used in accordance with the instructions, may cause harmful interference to radio communications. However, there is no guarantee that interference will not occur in a particular installation. If this equipment does cause harmful interference to radio or television reception, which can be determined by turning the equipment off and on, the user is encouraged to try to correct the interference by one or more of the following measures:

- Reorient or relocate the receiving antenna.
- Increase the distance between the equipment and receiver.
- Connect the equipment into an outlet on a circuit different from that to which the receiver is connected.
- Consult the dealer or an experienced radio / TV technician for help.

### SAFETY CERTIFICATION

This Compact Disc Player is made and tested to meet safety standards of the FCC, requirements and compliance with safety performance of the U.S. Department of Health and Human Services, and also with FDA Radiation Performance Standards 21 CFR Subchapter J.

### DANGER



INVISIBLE LASER RADIATION  
WHEN OPEN AND  
INTERLOCK FAILED OR  
DEFEATED. AVOID DIRECT  
EXPOSURE TO LASER BEAM.

### LASER SAFETY

This unit employs an optical laser beam system in the CD mechanism, designed with built-in safeguards. Do not attempt to disassemble the unit. If the unit requires repair, refer to qualified service personnel. Exposure to this invisible laser light beam may be harmful to the human eye. THIS IS A CLASS-1 LASER PRODUCT. USE OF CONTROLS, ADJUSTMENTS OR PROCEDURES OTHER THAN THOSE SPECIFIED HEREIN, MAY RESULT IN HAZARDOUS LASER LIGHT BEAM EXPOSURE.

### SAFETY PRECAUTIONS

1. Do not open the Compact Disc Player's case. Refer servicing to qualified personnel only.
2. Do not expose to excessive heat, direct sunlight, dust, moisture, vibration or shock.
3. Use ONLY the AC adapter provided. Other adapters may damage your unit. Disconnect the unit from the wall outlet when the unit is not to be used for an extended period of time.
4. When cleaning your unit, use a soft dry cloth, do not use solvents or commercially available cleaners as they may damage or discolor the finish.
5. Do not wear headphones while operating a motor vehicle, this could create a traffic hazard and is illegal in many areas.
6. The headphones supplied with your unit provide superior stereo listening while allowing you to hear outside sounds when listening at a normal low volume level. Listening at extremely high volume levels can damage your hearing and prevents you from hearing outside noise/sounds.
7. If you notice that the sound has become weak or distorted, this is an indication that your batteries are low. Replace the batteries with new or recharged batteries (see "BATTERY OPERATION")

## LOCATION OF CONTROLS

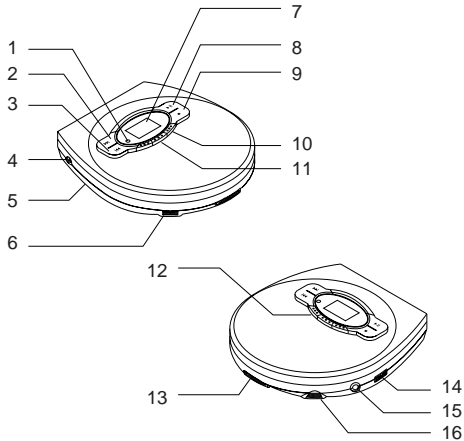

1. Charge Indicator
2. Skip Up Button
3. Skip Down Button
4. DC Input Socket
5. Battery Door
6. Hold Switch
7. LCD Display
8. Play/Pause Button

9. Stop Button
10. Anti-Shock Button
11. Program Button
12. Mode Button
13. Door Open Button
14. Bass Boost Switch
15. Phones Jack
16. Volume Control

## POWER SOURCES NORMAL BATTERIES / AC ADAPTER

### Battery Power Operation

1. Open the battery compartment cover and insert two "AA" alkaline batteries inside the battery compartment. Follow the polarity as indicated in the battery compartment.
2. Close the battery compartment cover.

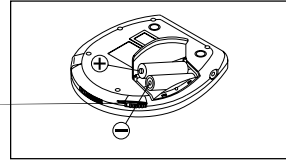

### AC Operation

1. Insert the DC plug, at the end of the AC adapter cord into the DC input jack on the unit.
2. Plug the AC adaptor into a 120V/ 50Hz AC power outlet socket.

**Note:** If the AC plug of this unit does not fit in your AC outlet, a plug adaptor (Not supplied) should be used. Consult your local dealer on the type of plug adaptor required.

### LOW BATTERY ALERT

When the battery indicator (Batt.) appears in the LCD panel, the batteries are becoming discharged. The CD player will not function properly and the batteries must be replaced. If Ni-cd rechargeable batteries are being used follow the instructions on how to recharge the batteries detailed in this manual.

Average Playing Time  
(Continuous Play)

Battery Type	Average Playing Time (Continuous Play)	
	Normal Play Mode	Anti-Skip Play Mode
Alkaline "AA"	Approx. 9 hrs.	Approx. 8 hrs.
Ni-CAD Rechargeable (min specification recommended 1.2V - 650mA)	Approx. 3.5 hrs.	Approx. 2.5 hrs.

**NOTE:** Zinc/Carbon or Zinc/Chloride type batteries are not recommended for this unit as their use will result in extremely short playing times. To economize on batteries, it is recommended that the AC adapter supplied with this unit be used whenever possible.

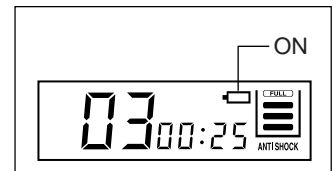
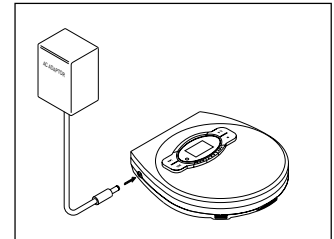

## CHARGING AND USE OF RECHARGEABLE BATTERIES

### Rechargeable Battery Operation

This unit can fully recharge specified rechargeable batteries, in approximately 15 hours. The rechargeable batteries (NOT supplied) should be recharged before they are used for the first time, if they are low in power or they have not been used for a long period (over 60 days).

1. Open the battery compartment cover and insert two of the recommended rechargeable batteries, matching polarity. (1.2V 650mA) **WARNING: BOTH BATTERIES MUST BE OF RECHARGEABLE NICKEL-CADMIUM TYPE, OTHERWISE THE BATTERIES MAY EXPLODE OR LEAK.**
2. If you are using rechargeable batteries that do not have the negative side exposed, you will need to use the rechargeable battery sleeve that is initially packed in the battery compartment as shown in Fig. A. Insert one rechargeable battery into the battery sleeve by sliding the negative terminal of the battery into the sleeve as shown in Fig. B.
3. Insert the two "AA" rechargeable nickel-cadmium batteries (not supplied) into the battery compartment. The battery with the rechargeable battery sleeve should be placed in the slot that holds the charge plate (this is the slot closest to the center of the unit) as shown in Fig. C.
4. Close the battery compartment door.
5. Connect the supplied AC adapter's plug to the AC outlet and insert the DC plug into the DC input jack on the unit. USE ONLY THE AC ADAPTER SUPPLIED WITH THE SET FOR CHARGING. NOTE: The charge indicator will illuminate.
6. After 15 hours, unplug the AC adapter.
7. CAUTION: DO NOT CHARGE CONTINUOUSLY FOR 24 HOURS OR MORE. DOING SO CAN CAUSE THE PERFORMANCE OF THE RECHARGEABLE BATTERY TO DETERIORATE.

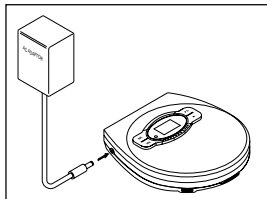
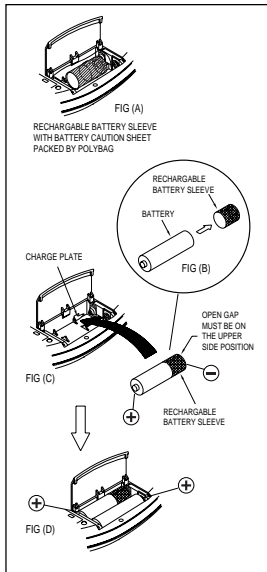

8. If the operating time decreases drastically even when the rechargeable nickel-cadmium batteries are properly recharged, purchase a new set of rechargeable nickel-cadmium batteries.
  9. When charging for the first time or after a long time, playing time may be reduced. In this case, charge and discharge the batteries several times.
- Remark: The battery adapter is used with standard rechargeable batteries. Rechargeable batteries with the negative side exposed do not require this adapter.

### LISTENING WITH HEADPHONES

Connect the plug of the stereo headphones into the PHONES (GREEN) socket.

**WARNING:** To prevent damage to your hearing, avoid excessive volume levels and listening to sound for a long period of time when using headphones.

- Adjust Volume to the desired level.

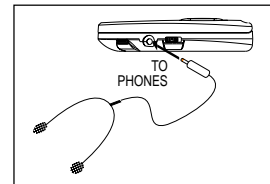

### HANDLING COMPACT DISCS

This unit is designed to play only compact discs bearing the identification logo below.



Other discs may not conform to the CD standard and may not play properly.

- Dirty, scratched or warped discs may cause skipping or noise.
- Handle the disc only by the edges. To keep the disc clean, do not touch its surface.
- Discs should be stored in their cases after use to avoid serious scratches.
- Do not expose disc to direct sunlight, high humidity, high temperatures or dust etc. Prolonged exposure to extreme temperatures can warp the disc.
- Do not stick or write anything on either side of disc. Sharp writing instruments or the inks used in some felt-tip pens, may damage the disc's surface.

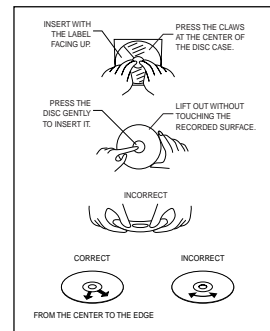

### Remove the disc

Hold the edge and gently press the center pivot as illustrated to pick up the disc.

**CAUTION:** Wait for the disc to stop rotating before pressing the OPEN button.

**NOTE:** This unit can play 3" (8cm) single CDs without an adapter. Do not use a CD single adapter for these discs.

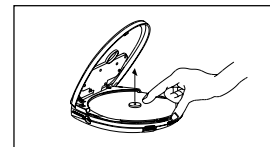

## CLEANING DISCS

- Finger prints should be carefully wiped from the surface of disc with a soft cloth. Unlike conventional records, compact discs have no grooves to collect dust and microscopic debris, so gently wiping them with a soft cloth should remove most particles. Wipe in a straight motion from the center to the edge.
- Never use thinner, benzene, record cleaner or anti-static spray on a compact disc. Such chemicals can damage its plastic surface.

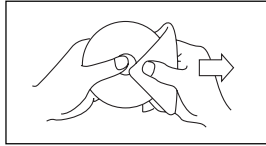

## BASIC DISC PLAY

The Compact Disc Player can play Audio Discs such as CD-Recordables and CD-Rewritables. Do not try to play a CD-ROM, CDi, VCD, DVD or computer CD.

1. Connect the headphones to the PHONES (GREEN) socket.
2. Press the OPEN button to open the CD compartment lid.
3. Adjust the VOLUME to minimum.
4. Insert the disc with the label side facing up.
5. Close the lid securely until a click is heard.
6. Press the PLAY button to start playing.

## Increasing the bass

Set the BASS BOOST switch to the ON position.

NOTE: The bass boost performance will be dependent on the VOLUME control setting.

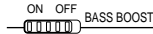

## HOLD Switch

This switch prevents accidental selection of an unwanted function during Playback or Stop mode. In the HOLD "ON" position, no function button on the unit can be operated (except OPEN). Moving the switch to the "OFF" position, returns the unit to normal operation.

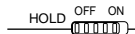

## Turning Power on and off

This unit has no ON/OFF switch. To turn on and off, press the following buttons.

To turn on:

Press **>||** PLAY/PAUSE (playback starts).

To turn off:

Press **■** STOP button once to standby mode.

If press **■** STOP button twice, it will be turn off the power immediately.

## Auto power-off function

When the unit is stopped (standby mode) for approximately 30 seconds, the power is automatically turned off.

## LCD DISPLAY INFORMATION

### When power is applied to the unit

- If disc is in, auto adjustment is started. During adjustment, display shows - - .
- If no disc, then **disc** is displayed. Put the disc and close the lid, then the player starts auto adjustment again.
- If the lid is opened, the display shows **OPEN**. Closing the lid starts auto adjustment.
- If the player can't read the Table of Contents (TOC) then **Er** is displayed.
- When TOC data has been read, the display shows
- Track No. 1 plays automatically. **ANTI-SHOCK** starts flashing.
- If ANTI-SKIP key is pressed, then  disappears.

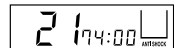
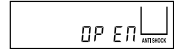
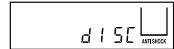

### TO PLAY FROM STOP MODE

- Press PLAY/PAUSE button, then the display changes to 01 00:00 and starts play.
- When the memory is full, **ANTI-SHOCK** stops flashing.

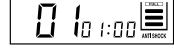

### TO STOP

Press STOP key and the TOC is displayed.

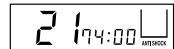

### TO PAUSE

Press PLAY/PAUSE button, then pause on/off alternately. When the player is paused the time display is flashes.



## REPEAT/PLAY MODES

Every time the MODE button is pressed, the corresponding mode appears in the display window.

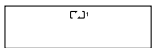
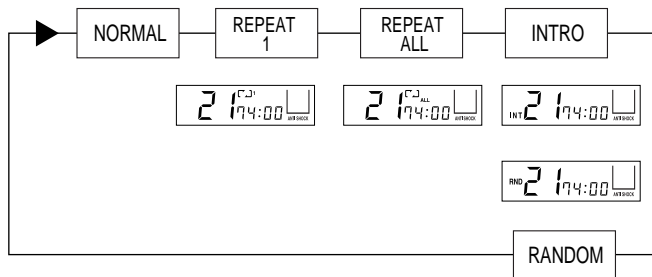
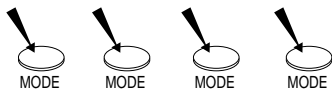

When this is showing on the LCD display. The current track on the disc will be repeated.

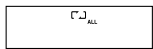
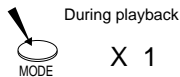

When this is showing on the LCD display. All tracks on the disc will be repeated.

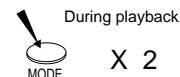

NOTE: In normal mode none of the above symbols show in the display.

## NORMAL PLAYBACK

Plays the entire disc.

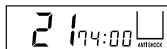

A  indicator appears on the display when the batteries need to be changed.



## INTRO PLAY

1. Press MODE button three times, then **INT** is displayed.
2. Press PLAY / PAUSE button, and starts INTRO play from track no. 01.
3. Select INTRO mode during play, **INT** will flash.
  - Press PLAY/PAUSE button, **INT** stops flashing and INTRO play from track no. 01.
  - Press >>I to hear the INTRO to the next track.
  - Press I<<, to hear the INTRO of the previous track

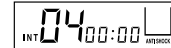
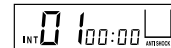
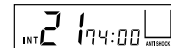

## PROGRAM PLAY

This allows selected tracks on the disc to be played in any order desired.

### To set the program play

- Programs can be set in the STOP mode or normal play mode.

1. Press the PROG button, then **PRG** and starts flash.
2. Press I<< or >>I to select the desired track.
3. When desired track is displayed, press PROG button to register. Then track No. display change to 00 again.
4. Repeat step 2 and 3 to program the order of more tracks. Up to 20 tracks can be programmed into memory.

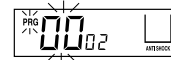
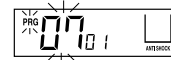
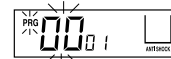

### To complete programming and start play

Press PLAY/PAUSE button, then **PRG** stops flash and starts play soon.



### To clear programming

- Set the first program track to 00 and press the PLAY/PAUSE (>II) button.
- Open the door.
- Power Off

## RANDOM PLAY

Enables all the tracks on a disc to be played in a Random (Shuffle) sequence.

1. Press MODE button four times, then **RND** is displayed.
  2. Press PLAY/PAUSE button, then the track No. is selected at random and starts play.
  3. To select RANDOM mode during play, press the MODE button until **RND** starts to flash.
- Press PLAY/PAUSE button or I<< or >>I, and begin RANDOM play.

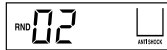

## SKIP AND SEARCH FUNCTION

### Locating a Particular track

To go back to the beginning of the current or a previous track.	Press I<< lightly and repeatedly.
To go to the beginning of following tracks	Press >>I lightly and repeatedly.

### Locating a Particular Point in a track

To search backwards within a track at high speed.	Keep I<< depressed
To search forward within a track at high speed	Keep >>I depressed

Low level audio will be heard during the search process to assist in locating the correct point in the track.

## MAINTENANCE

### Cleaning the Case

Wipe with a soft cloth. If the case is very dirty, dampen the cloth with a weak solution of neutral detergent and water, and then wipe clean.

### Cleaning the Lens

A dirty lens will cause sound skipping and, if the lens is very dirty, the CD may not work. Open the disc cover and clean the lens as described below.

- Dust or Dry Particles

Using a camera lens brush/blower, blow on the lens couple times, then wipe it lightly with the brush to remove dust. Then, blow on the lens once more.

- Fingerprints

If the lens cannot be cleaned by using a brush/blower, use a dry cotton swab starting in the middle and working to the outside edge.

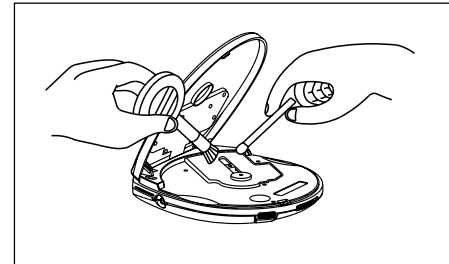

---

## USING ANTI-SHOCK AND SKIP FREE PROTECTION FEATURE

Note the "□" indicator appears on display as being empty when the player is first activated. It immediately begins to store sound data in the memory bank, the indicator appears to be "▣" when the data buffer is full.

When the laser loses tracking due to mechanical shock, the data stream into the memory is interrupted but the data output from the memory buffer continues, so the sound is not interrupted. As the data is read from the memory, the indicator changes from "▣" to "□".

Once the laser locks again on the CD track, the data stream is fed to the memory and joined to the previous data (see indicator changes) at higher speed, this provides higher level shock protection than the traditional one.

### CAUTION

If the unit is subject to excessive and continuous repeated shock, it will cause the sound skip. Also note the "□" indicator will appear empty.

### NOTES

- When the "ANTI-SHOCK" is operating, the battery consumption is higher because the disc rotates faster than normal and also the memory circuitry is activated.
- When the digital anti-skip function is switched "ON" or "OFF", the sound will be interrupted. This is a normal occurrence.
- Remember that conditions such as dirty, scratched or warped discs may cause skipping or noise, thereby affecting performance of the "ANTI-SHOCK" system.

---

## PRODUCT SPECIFICATIONS

### PICK UP

System	Compact disc digital audio system
Laser diode	Material : GaAlAs
Properties	Wavelength: $\lambda = 780\text{nm}$ Emission duration : continuous Laser output: $< 44.6\mu\text{W}$
Error correction	Cross-interleave Reed-solomon code

### AUDIO

D/A conversion	DAC four times oversampling
Frequency response	20-20,000Hz (+1/-3 dB)
Wow and filter	Below measurable limits
No. of channels	2 Channel (stereo)
Output level	Headphones : 20mW (32 $\Omega$ )
Bass boost effect (100Hz)	+8 dB

### GENERAL

Power requirements	- 2 x LR6 "AA" alkaline battery - DC in 6V jack accepts AC power adapter (centre positive)
Power consumption	0.8W (DC 3V) under normal condition
Dimension	Approx. 128 (W) x 28.5 (H) x 137 (D) mm
Weight	Approx. 200g not including battery

## Free Manuals Download Website

<http://myh66.com>

<http://usermanuals.us>

<http://www.somanuals.com>

<http://www.4manuals.cc>

<http://www.manual-lib.com>

<http://www.404manual.com>

<http://www.luxmanual.com>

<http://aubethermostatmanual.com>

Golf course search by state

<http://golfingnear.com>

Email search by domain

<http://emailbydomain.com>

Auto manuals search

<http://auto.somanuals.com>

TV manuals search

<http://tv.somanuals.com>