

Operator: Save these instructions for future use!

**FAILURE TO READ AND FOLLOW ALL INSTRUCTIONS CAREFULLY BEFORE
INSTALLING OR OPERATING THIS CONTROL COULD CAUSE PERSONAL
INJURY AND/OR PROPERTY DAMAGE.**

PREPARATIONS

YOUR THERMOSTAT REPLACES

Description	
Heat Pump (No Aux. or Emergency Heat)	Yes
Heat Pump (with Aux. or Emergency Heat)	Yes
Standard Heat & Cooling Systems	Yes
Two Stage Heat & Two Stage Cool	Yes
Standard Heat Only Systems	Yes
Millivolt Heat Only Systems – Floor or Wall Furnaces	Yes
Standard Central Air Conditioning	Yes
Gas or Oil Heat	Yes
Electric Furnace	Yes
Hydronic (Hot Water) Zone Heat – 2 Wires	Yes
Hydronic (Hot Water) Zone Heat – 3 Wires	No

Assemble tools required as shown below.

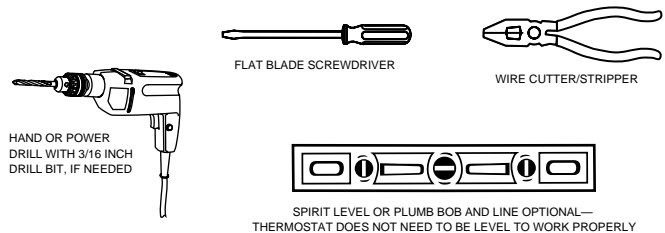

REMOVING OLD THERMOSTAT

⚠ CAUTION

To prevent electrical shock and/or equipment damage, disconnect electric power to system at main fuse or circuit breaker box until installation is complete.

Before removing wires from old thermostat's switching subbase, **label each wire** with the terminal designation it was removed from.

1. Shut off electricity at the main fuse box until installation is complete. Ensure that electrical power is disconnected.
2. **Remove Old Thermostat:** A standard heat/cool thermostat consists of three basic parts:
 - a. The cover, which may be either a snap-on or hinge type.
 - b. The base, which is removed by loosening all captive screws.
 - c. The switching subbase, which is removed by unscrewing the mounting screws that hold it on the wall or adaptor plate.
3. Remove the front cover of the old thermostat. **With wires still attached**, remove wall plate from the wall. If the old thermostat has a wall mounting plate, remove the thermostat and the wall mounting plate as an assembly.
4. Identify each wire attached to the old thermostat.
5. Disconnect the wires from the old thermostat one at a time. **DO NOT LET WIRES FALL BACK INTO THE WALL.**
6. Install new thermostat using the following procedures.

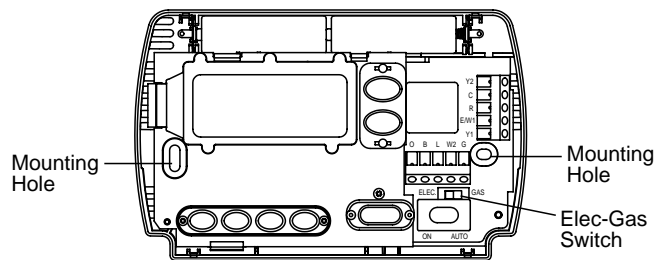

Figure 1 – Thermostat base

ATTENTION! This product does not contain mercury. However, this product may replace a unit which contains mercury.

Do not open mercury cells. If a cell becomes damaged, do **not** touch any spilled mercury. Wearing non-absorbent gloves, clean up the spilled mercury and place into a container which can be sealed. If a cell becomes damaged, the unit should be discarded.

Mercury must not be discarded in household trash. When the unit this product is replacing is to be discarded, place in a suitable container and return to White-Rodgers at 2895 Harrison Street, Batesville, AR 72501 for proper disposal.

MOUNTING AND WIRING

⚠ WARNING

Do not use on circuits exceeding specified voltage. Higher voltage will damage control and could cause shock or fire hazard.

Do not short out terminals on gas valve or primary control to test. Short or incorrect wiring will damage thermostat and could cause personal injury and/or property damage.

Thermostat installation and all components of the system shall conform to Class II circuits per the NEC code.

⚠ CAUTION

Take care when securing and routing wires so they do not short to adjacent terminals or rear of thermostat. Personal injury and/or property damage may occur.

Attach Thermostat Base to Wall

1. Remove the packing material from the thermostat. Gently pull the cover straight off the base. Forcing or prying on the thermostat will cause damage to the unit.
2. Connect wires beneath terminal screws on base using appropriate wiring schematic (see figs. 2 through 4).
3. Place base over hole in wall and mark mounting hole locations on wall using base as a template.
4. Move base out of the way. Drill mounting holes.
5. Fasten base loosely to wall, as shown in fig. 1, using two mounting screws. Place a level against bottom of base, adjust until level, and then tighten screws. (Leveling is for appearance only and will not affect thermostat operation.) If you are using existing mounting holes, or if holes drilled are too large and do not allow you to tighten base snugly, use plastic screw anchors to secure subbase.
6. Push excess wire into wall and plug hole with a fire-resistant material (such as fiberglass insulation) to prevent drafts from affecting thermostat operation.

Electric/Gas Switch (Fan Option)

The ELEC/GAS switch is factory set to the ELEC position. In this position, the thermostat will power the circulator fan on a call for heat. Electric heat systems require the switch to be in the ELEC position.

If your system does not require that the thermostat power the circulator fan, this switch should be set to the GAS position. Typically, gas and oil heating systems do not require the thermostat to power the circulator fan during a call for heat. If your heat is gas or oil, the switch should be set to the GAS position.

When the thermostat is configured for Heat Pump, the thermostat will always power the circulator fan on a call for heat in the HEAT mode. The ELEC/GAS switch must be set to match the type of Auxiliary heat your system uses for proper operation in the EMERGENCY mode.

All wiring diagrams are for typical systems only. Refer to equipment manufacturers' instructions for specific system wiring information.

Battery Location

2 "AA" alkaline batteries are included in the thermostat at the factory with a battery tag to prevent power drainage. You must remove the battery tag to engage the batteries.

If BATT is displayed, the batteries are low and should be replaced with fresh "AA" Energizer® alkaline batteries. To replace batteries, set system to OFF, install the batteries along the top of the base (see Fig. 1). The batteries must be installed with the positive (+) end to the left.

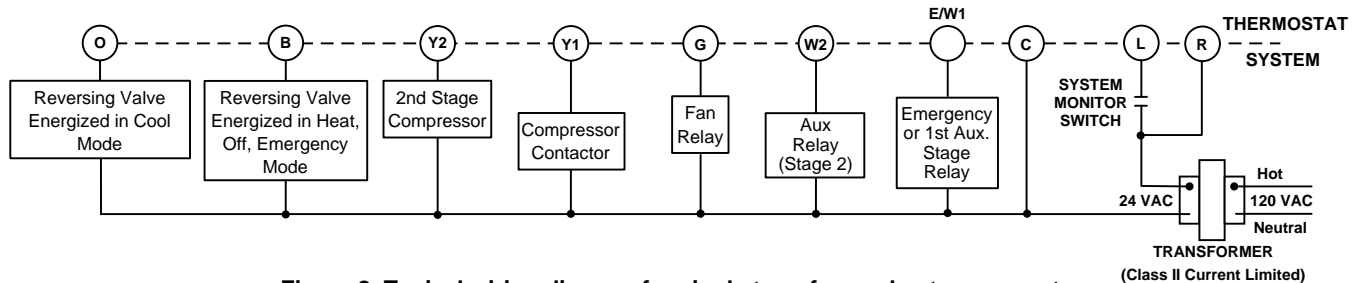

Figure 2. Typical wiring diagram for single transformer heat pump systems

NOTE

If safety circuits are in only one of the systems, remove the transformer of the system with NO safety circuits.

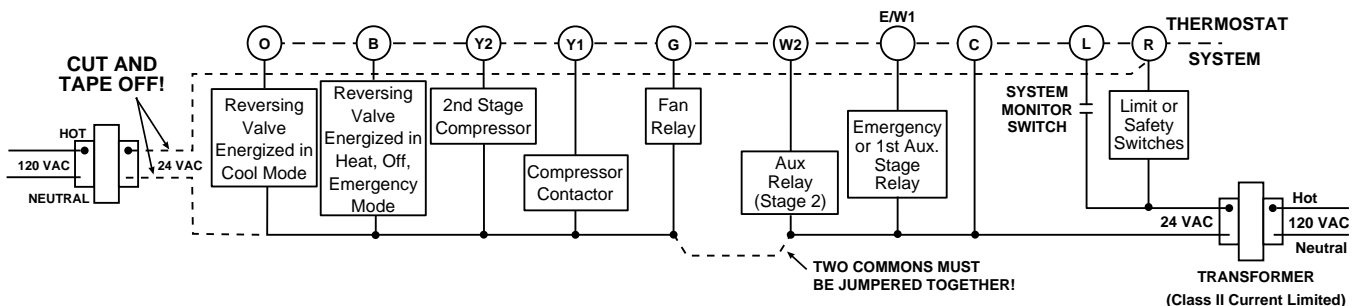

Figure 3. Typical wiring diagram for two transformer heat pump systems with NO safety circuits

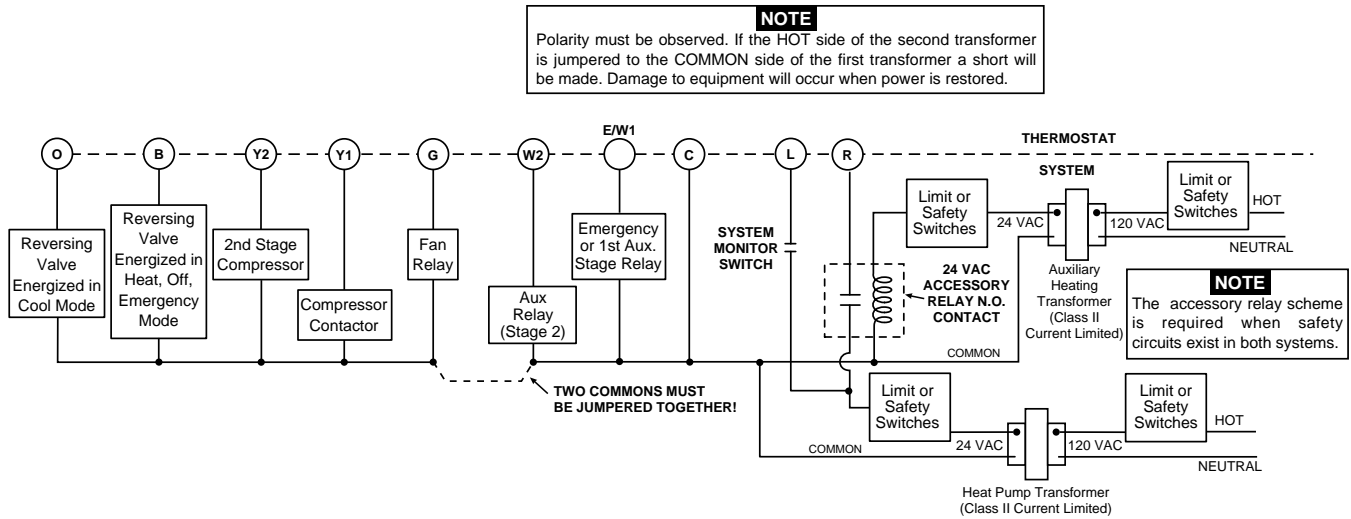

Figure 4. Typical wiring diagram for two transformer heat pump systems with safety circuits in BOTH systems

Heat Pump Terminal Outputs

Refer to equipment manufacturers' instructions for specific system wiring information.

You can configure the thermostat for use with the following heat pump system types:

HEAT PUMP TYPE 1. Single stage compressor system; gas or electric backup.

This thermostat is designed to operate a single-transformer system. If you have a two-transformer system, cut and tape off

one transformer. If transformer safety circuits are in only one of the systems, remove the transformer of the system with NO safety circuits. If required, replace remaining transformer with a 75VA Class II transformer. After disconnecting one transformer, the two commons must be jumpered together.

Use the terminal output information below to help you wire the thermostat properly for your multi-stage system. After wiring, see **CONFIGURATION** section for proper thermostat configuration.

THERMOSTAT TERMINALS (HEAT PUMP)										
SYSTEM	L	C	R	W2	E/W1	Y2	Y1	G	O	B
Heat Pump 1	Malfunction Light	24 Volt (Common)	24 Volt (Hot)	Heat Mode 3rd stage	Heat mode 2nd stage or	No Output	Heat and Cool mode 1st stage (compressor)	Blower/Fan Energized on call for Heat and Cool	Energized in Cool Mode	Energized in Heat OFF Emergency mode
Heat Pump 2				Emergency mode 2nd stage	Emergency Mode 1st stage	2nd stage compressor				

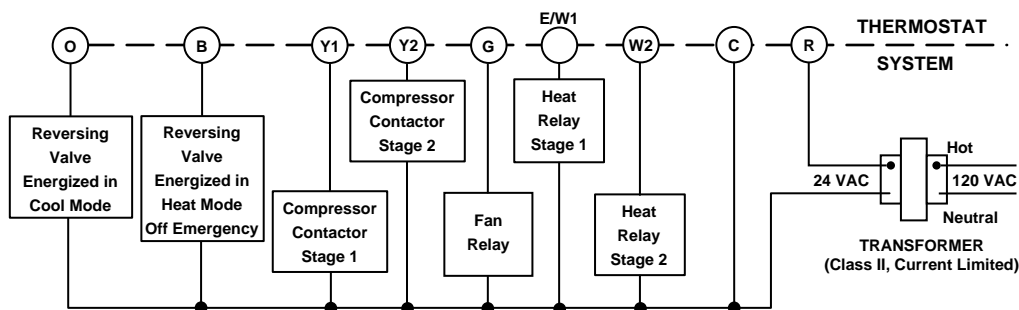

Figure 5. Typical wiring diagram for single transformer multi-stage systems

Multi-Stage Terminal Outputs

Refer to equipment manufacturers' instructions for specific system wiring information.

You can configure the thermostat for use with either multi-stage electric heat systems or multi-stage gas systems. When configured for **electric** heat, the **G** terminal (blower/fan) will be energized on a call for heat.

This thermostat is designed to operate a single-transformer system. If you have a two-transformer system, cut and tape off

one transformer. If transformer safety circuits are in only one of the systems, remove the transformer of the system with NO safety circuits. If required, replace remaining transformer with a 75VA Class II transformer. After disconnecting one transformer, the two commons must be jumpered together.

Use the terminal output information below to help you wire the thermostat properly for your multi-stage system. After wiring, see **CONFIGURATION** section for proper thermostat configuration.

THERMOSTAT TERMINALS (MULTI-STAGE)										
SYSTEM	L	C	R	W2	E/W1	Y2	Y1	G	O	B
Multi-stage	Malfunction Light	24 Volt (Common)	24 Volt (Hot)	Heat Mode 2nd stage	Heat mode 1st stage	Cool Mode 2nd stage	Cool Mode 1st stage	Blower/Fan Energized on call for Cool (and Heat if configured to Electric Heat)	Energized in Cool Mode	Energized in Heat, Off, Emergency Modes

CHECK THERMOSTAT OPERATION

NOTE

To prevent static discharge problems, touch side of thermostat to release static build-up before touching any keys.

If at any time during testing your system does not operate properly, contact a qualified serviceperson.

Fan Operation

If your system does not have a **G** terminal connection, skip to **Heating System**.

1. Turn on power to system.
2. Move fan switch to **ON** position. The blower should begin to operate.
3. Move fan switch to **AUTO** position. The blower should stop immediately.

CAUTION

Do not allow the compressor to run unless the compressor oil heaters have been operational for 6 hours and the system has not been operational for at least 5 minutes.

Heating System

1. Press SYSTEM button to select the **Flame icon** (🔥). If the auxiliary heating system has a standing pilot, be sure to light it.
2. Press ⏴ to adjust thermostat setting to 1° above room temperature. The heat pump system should begin to operate. The display should show STG1. However, if the set point temperature display is flashing, the compressor lockout feature is operating (see Configuration menu, item 5).
3. Adjust temperature setting to 3° above room temperature. If your system configuration is set at MS2, HP2 or HP1, the auxiliary heat system should begin to operate and the display should show STG 1+2.
4. Press ⏴ to adjust the thermostat below room temperature. The heating system should stop operating.

Emergency System

EMER bypasses the Heat Pump to use the heat source wired to terminal E on the thermostat. EMER is typically used when compressor operation is not desired, or you prefer back-up heat only.

1. Press SYSTEM button to select EMER. EMER will flash on the display.
2. Press ⏴ to adjust thermostat setting above room temperature. The Aux. heating system will begin to operate. The display will show STG1 flashing EMER and flame icon (🔥) to indicate that the Aux. system is operating.
3. Adjust temperature setting to 3° above room temperature. The auxiliary heat system should begin to operate and the display should show STG 1+2.
4. Press ⏴ to adjust the thermostat below room temperature. The Aux. heating system should stop operating.

CAUTION

To prevent compressor and/or property damage, if the outdoor temperature is below 50°F, DO NOT operate the cooling system.

Cooling System

1. Press SYSTEM button to select the **Snowflake icon** (❄️).
2. Press ⏴ to adjust thermostat setting below room temperature. The blower should come on immediately on high speed, followed by cold air circulation. The display should show STG1.
3. Adjust temperature setting to 3° below room temperature. The second stage cooling should begin to operate and the display should show STG 1+2.
4. Press ⏴ to adjust the temperature setting above room temperature. The cooling system should stop operating.

Before you begin programming your thermostat, you should be familiar with its features and with the display and the location and operation of the thermostat buttons. Your thermostat consists of two parts: the thermostat cover and the base. To remove the cover, pull it straight out from the base. To replace the cover, line up the cover with the base and press until the cover snaps onto the base.

The Thermostat Buttons and Switches

- ① Raises temperature setting
- ② Lowers temperature setting.
- ③ FAN switch (**ON**, **AUTO**)
- ④ SYSTEM button (**COOL**, **AUTO**, **HEAT**, **EMER**, **OFF**)

The Display

- ⑤ **Flame icon** (🔥) is displayed when the system is in **HEAT** mode. **Snowflake icon** (❄️) is displayed when the system is in **COOL** mode. **Flame icon** (🔥) and **Snowflake icon** (❄️) are displayed simultaneously when thermostat is in **AUTO** mode.
- ⑥ Displays **BATT** when the 2 "AA" batteries are low and should be replaced. Only **BATT** and **LO** are displayed when batteries are low with no system power.
- ⑦ Displays current temperature or **LO** when batteries are low.
- ⑧ Displays currently programmed set temperature (this is blank when SYSTEM is OFF).
- ⑨ Displays **FLTR** when the system has run for the programmed filter time period as a reminder to change or clean your filter.
- ⑩ Display (🔒) when in keypad lockout mode.

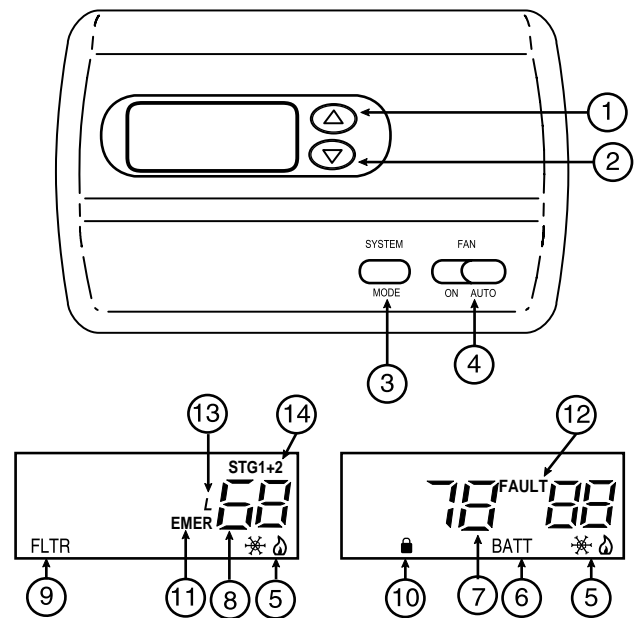

Figure 6 – Thermostat display, buttons and switches

- ⑪ **EMER** is displayed flashing when the system is in EMER mode.
- ⑫ Indicates a fault in the heating/cooling system. It does not indicate a fault in the thermostat.
- ⑬ Display (L) when limited range is activated.
- ⑭ **Stage1 & 2** indicators: The thermostat shall indicate when the first and second stage is energized except in emergency mode. The icon is **STG 1** for the first stage energized. The icons for the first and second stage energized are **STG1+2** located in the upper right side of the display.

CONFIGURATION MENU

The configuration menu allows you to set certain thermostat operating characteristics to your system or personal requirements.

Set **SYSTEM** button to **OFF**, then simultaneously press \ominus and \ominus to enter configuration menu. The display will show the first item in the configuration menu.

The configuration menu table summarizes the configuration options. An explanation of each option follows.

Press **SYSTEM** to change to the next menu item. To exit the menu and return to the program operation, press **RUN**. If no keys are pressed within fifteen minutes, the thermostat will revert to normal operation.



- 1) **Single Stage, Multi-stage or Heat Pump System Configuration** – This control can be configured for Heat Pump or two stage heat/two stage cool multi-stage operation. The display indicates **MS 2** (default for multi-stage mode) in the display. The Multi-stage configuration can be toggled to **SS1**, **HP2**, or **HP1** by pressing the **Temperature Up** or **Temperature Down** key. In Multi-stage configuration, system button will not have **EMER**gency mode.

- 2) **Fast or Slow Cycle Selection** – The factory default setting is fast cycle, which cycles 1st stage at approximately 1.2°F and 2nd stage 0.75°F. If you prefer slow cycle, press the temperature key to change to SL. The 1st stage and 2nd stage would be 1.5°F and 1.2°F respectively.
- 3) **Select Compressor Lockout CL OFF or ON** – Selecting CL ON will cause the thermostat to wait 5 minutes before turning on the compressor if the heating and cooling system loses power. It will also wait 5 minutes minimum between cooling and heating cycles. This is intended to help protect the compressor from short cycling. Some newer compressors already have a time delay built in and do not require this feature. Your compressor manufacturer can tell you if the lockout feature is already present in their system. When the thermostat compressor time delay occurs it will flash the setpoint for about five minutes.





CONFIGURATION MENU





Press the System button until **OFF** is displayed, then press the  and  simultaneously

INSTALLER/CONFIGURATION MENU

Step	Press Button(s)	Displayed (Factory Default)	Press  or  to select	Comments
1	System	MS 2	SS1, HP2, HP1	Selects Single stage, Multi-stage, or Heat Pump (Single stage or 2-stage) System Configuration
2	System	FA	SL	Selects Fast or Slow Cycle Selection
3	System	CL (OFF)	CL (ON)	Selects Compressor Lockout CL OFF or ON
4	System	CDL (ON)	CDL (OFF)	Selects Backlight Display
5	System	FA (ON)	FA (OFF)	Selects Fast Second Stage ON or OFF
6	System	0 FLTR	50-1950 (increments of 50)	Selects filter replacement run time
7	System	0°F (Room Temperature)	4 LO to 4 HI	Selects Temperature Display Adjustment 4 LO to 4 HI
8	System	°F	°C	For °C selection
9	System	LR (90)	LR 62 to LR89	Selects Limited HEAT range
10	System	LR (45)	LR 46 to LR 82	Selects Limited COOL range
11	System	CA (OFF)	CA (ON)	Feature Not Available
12	System	(OFF)	(ON)	Selects Keypad Lockout
13		0	001 to 999	Selects Keypad lockout combination number Press System to set code
14	System			Returns to the OFF position

- 4) **Select Backlight Display** – The display backlight improves display contrast in low lighting conditions. When the "C" terminal is powered, selecting backlight CdL ON will keep the light on continuously. Select backlight OFF will keep the light on momentarily after any key is pressed. When the "C" terminal is not powered, the light will be on momentarily after any key is pressed no matter the backlight is selected ON or OFF.
- 5) **Select (Fast) Second Stage ON or OFF** – In the run mode, if the setpoint temperature is manually raised by 3°F (2°C) or more above the actual temperature with the , and the fast second stage feature is enabled, FA ON, the second stage will energize immediately. With FA OFF, second stage will not energize until the setpoint temperature is 1°F or more above actual temperature for more than ten minutes.
- 6) **Select filter replacement run time** – The thermostat will display FLTR after a set time of operation. This is a reminder to change or clean your air filter. This time can be set from 0 to 1950 hours in 50 hour increments. **A selection of 000 will cancel this feature.** When FLTR is displayed, you can clear it by pressing **HOLD** and **RUN** at the same time. This resets the timer and starts counting the hours until the next filter change. Contact your system manufacturer for a specific replacement/maintenance interval.
- 7) **Select Temperature Display Adjustment 4 LO to 4 HI** – Allows you to adjust the room temperature display up to 4° higher or lower. Your thermostat was accurately calibrated at the factory but you have the option to change the display temperature to match your previous thermostat. The current or adjusted room temperature will be displayed on the left side of the display.
- 8) **Select F° or C° Readout** – Changes the display readout to Centigrade or Fahrenheit as required.
- 9) **Limited Heat Range** – This feature provides a maximum setpoint temperature for heat. The default setting is 90°F. It can be changed between 62°F and 89°F by pressing the **temperature up** or **temperature down** key.
- 10) **Limited Cool Range** – This feature provides a minimum setpoint temperature for cool. The default setting is 45°F. It can be changed between 46°F and 82°F by pressing the **temperature up** or **temperature down** key.
- 11) **This feature not available.**

12 & 13) **Keypad Lockout** – This menu selection will display **lock** icon. The  and  are used to toggle the function and display the **lock** icon and **OFF** (keypad not locked out, default) indicating in the time digits to the **lock** icon and **ON** (keypad locked out). When the keypad lockout function is enabled (**ON**), and the **SYSTEM** key is pressed again, the display will indicate the number **0** (default, still disabled) in the time digits. The  and  are used to set the combination number from **0** to **999**. "0" will not be a valid combination. If a combination of **0** is selected and the system key is pressed the menu will be exited and keypad lockout will not be evoked. If **1 to 999** is selected and the **SYSTEM** key is pressed again, the combination is locked into non-volatile memory and the menu is exited. The **lock** icon (to designate keypad locked with a valid combination) will display when the menu is exited. The system key will operate for 10 seconds after the menu mode is exited to allow the user to change the mode from **OFF** to the desired system mode.

While the keypad is locked out, a simultaneous press of the temperature  and  will enter the menu item from any mode instead of only **OFF mode**. When the menu is entered with the keypad lockout feature enabled, the first menu item displayed is the combination code **0**. The  or  keys are used to set the combination unlock number from **0** to **999**. If the unlock number matches exactly with the combination lock number stored in memory when the **SYSTEM** key is pressed, the keypad is unlocked and the **lock** icon is removed. If the unlock number does not match when the **SYSTEM** key is pressed, menu is exited and the keypad remains disabled.

To reset the combination code and unlock the keypad if the code is forgotten, see troubleshooting section.

SPECIFICATIONS

ELECTRICAL DATA

Electrical Rating:

- 20 to 30 VAC 50/60 Hz or DC
- 0.05 to 1.5 Amps (Load per terminal)
- 2.5 Amps Maximum Total Load (All terminals combined)

THERMAL DATA

Setpoint Temperature Range:

45°F to 90°F (7°C to 32°C)

Operating Ambient Temperature Range:

32°F to 105°F





Operating Humidity Range:

0 to 90% RH (non-condensing)

Shipping Temperature Range:

-40°F to 150°F

OPERATION

The system "mode" is selected by pressing the **SYSTEM** button. Icons on the bottom right corner of the display will indicate the mode: **COOL** () , **AUTO** ( ), **HEAT** () , **EMER**, or **OFF**. In any mode except **OFF**, the setpoint temperature will be shown on the right side of the display. In **OFF**, this area will be blank. The current temperature will be displayed on the left side of the display.

To operate properly in the **AUTO** mode, the heat setpoint temperature cannot be the same as or higher than the cool setpoint temperature. The heat setpoint must be at least 1° lower than the cool setpoint.

Automatic System Changeover

When the thermostat is in the **AUTO** mode, both the **Flame** and **Snowflake** icons are displayed. The thermostat will call for heat or cool depending on the room temperature. The setpoint temperature displayed will be that of the last mode called. If the last system cycle was heat, the **HEAT** setpoint will be displayed. If the room temperature raises above the **HEAT** setpoint and the **COOL** setpoint and a call for cool is required, the temperature displayed will change to be the **COOL** setpoint.

Second Stage Time Delay

Your thermostat is designed to determine the optimum time to activate the second stage. Simply raising the temperature in heating or lowering it in cooling will not always force the thermostat to bring the second stage on quickly. There is a time delay from 0-30 minutes depending on the performance of the first stage of the system.

EXAMPLE: For the last 2 hours the thermostat is set on 70° and the room temperature is 70° with the equipment using only the first stage of heat. Since the equipment is keeping the temperature within 1 degree of setpoint, the thermostat will delay second stage for a longer time if you manually raise the temperature or if the room temperature quickly changes. Once the second stage comes on, it will come on sooner the next time there is a difference between the setpoint and the room temperature. The net effect of the staging program is that when the first stage is capable of making temperature the second stage will delay longer. When the thermostat calculates that first stage cannot make temperature in a reasonable time, the second stage will come on sooner. This built in function automatically optimizes the use of additional stages of heat or cool.





TROUBLESHOOTING

Reset Operation

If a voltage spike or static discharge blanks out the display or causes erratic thermostat operation, you can reset the thermostat by removing the wires from terminals R and C and removing batteries for 2 minutes. After resetting the thermostat, replace the wires and batteries. If the thermostat has been reset and still does not function correctly contact your heating/cooling service person or place of purchase.

Symptom	Possible Cause	Corrective Action
No Heat/No Cool/No Fan (common problems)	<ol style="list-style-type: none"> 1. Blown fuse or tripped circuit breaker. 2. Furnace power switch to OFF. 3. Furnace blower compartment door or panel loose or not properly installed. 	<p>Replace fuse or reset breaker. Turn switch to ON. Replace door panel in proper position to engage safety interlock or door switch.</p>
No Heat	<ol style="list-style-type: none"> 1. Pilot light not lit. 2. System Switch not set to HEAT. 3. Loose connection to thermostat or system. 4. Furnace Lock-Out Condition. Heat may also be intermittent. 5. Heating system requires service or thermostat requires replacement. 	<p>Re-light pilot. Set System Switch to HEAT and raise setpoint above room temperature. Verify thermostat and system wires are securely attached. Many furnaces have safety devices that shut down when a lock-out condition occurs. If the heat works intermittently contact the furnace manufacturer or local service person for assistance. Diagnostic: Set System Switch to HEAT and raise the setpoint above room temperature. Within a few seconds the thermostat should make a soft click sound. This sound usually indicates the thermostat is operating properly. If the thermostat does not click, try the reset operation listed above. If the thermostat does not click after being reset contact your heating and cooling service person or place of purchase for a replacement. If the thermostat clicks, contact the furnace manufacturer or a service person to verify the heating is operating correctly.</p>
No Cool	<ol style="list-style-type: none"> 1. System Switch not set to COOL. 2. Loose connection to thermostat or system. 3. Cooling system requires service or thermostat requires replacement. 	<p>Set System Switch to COOL and lower setpoint below room temperature. Verify thermostat and system wires are securely attached. Same procedure as diagnostic for No Heat condition except set the thermostat to COOL and lower the setpoint below the room temperature. There may be up to a five minute delay before the thermostat clicks in Cooling.</p>
Heat, Cool or Fan Runs Constantly	<ol style="list-style-type: none"> 1. Possible short in wiring. 2. Possible short in thermostat. 3. Possible short in heat/cool/fan system. 4. Fan Switch set to Fan On. 	<p>Check each wire connection to verify they are not shorted or touching together. No bare wire should stick out from under terminal screws. Try resetting the thermostat as described above. If the condition persists the manufacturer of your system or service person can instruct you on how to test the Heat/Cool system for correct operation. If the system operates correctly, replace the thermostat.</p>
Furnace (Air Conditioner) Cycles Too Fast or Too Slow (narrow or wide temperature swing)	<ol style="list-style-type: none"> 1. The location of the thermostat and/or the size of the Heating System may be influencing the cycle rate. 	<p>Digital thermostats normally provide precise temperature control and may cycle faster than some older mechanical models. A faster cycle rate means the unit turns on and off more frequently but runs for a shorter time so there is no increase in energy use. If you would like to increase the cycle time, choose SL for slow cycle in the menu, step 4. If an acceptable cycle rate is not achieved as received or by choosing slow cycle, contact a local service person for additional suggestions.</p>

TROUBLESHOOTING

Symptom	Possible Cause	Corrective Action
Thermostat Setting & Thermostat Thermometer Disagree	1. Thermostat thermometer setting requires adjustment.	The thermometer can be adjusted +/- 3 degrees. See Temperature Display Adjustment in the Configuration Menu section.
Blank Display and/or Keypad Not Responding	1. Voltage spike or static discharge.	Use the Reset Operation at top of previous page.
Heat Setpoint will not Respond to the Temperature Up Key	1. The desired setpoint conflicts with the setpoint of the COOL mode.	Change system mode to COOL. Raise the Cool setpoint. Return to HEAT mode and set desired temperature.
Cool Setpoint will not Respond to the Temperature Down Key	1. The desired setpoint conflicts with the setpoint of the HEAT mode.	Change system mode to HEAT. Lower the Heat setpoint. Return to COOL mode and set desired temperature.
Forgot Keypad Lockout Code		<p>CAUTION: This resets the thermostat to factory default settings of the configuration menu. After performing this reset, the thermostat will require configuration again. Be sure that you know the required configuration settings before resetting.</p> <p>With the thermostat in any mode, press  and  at the same time to enter the configuration menu at the point where the lockout code is to be entered. Press  and  and SYSTEM button at the same time to reset the lockout code, unlock the keypad and reset all configuration menu settings.</p>
Why won't my 2nd or 3rd stage come on?		Your thermostat is designed to determine the optimum time to activate the second stage. Simply raising the temperature in heating or lowering it in cooling will not always force the thermostat to bring the second stage on quickly. There is a time delay from 0-30 minutes depending on the performance of the first stage of the system.

The Emerson logo is a trademark and a service mark of Emerson Electric Co.



St. Louis, Missouri Markham, Ontario
314-577-1300 905-201-4701
www.white-rodgers.com

Free Manuals Download Website

<http://myh66.com>

<http://usermanuals.us>

<http://www.somanuals.com>

<http://www.4manuals.cc>

<http://www.manual-lib.com>

<http://www.404manual.com>

<http://www.luxmanual.com>

<http://aubethermostatmanual.com>

Golf course search by state

<http://golfingnear.com>

Email search by domain

<http://emailbydomain.com>

Auto manuals search

<http://auto.somanuals.com>

TV manuals search

<http://tv.somanuals.com>