

TELEDYNE HASTINGS INSTRUMENTS

INSTRUCTION MANUAL



Power^{Pod} 400
Power Supply/Totalizer



 **TELEDYNE**
HASTINGS INSTRUMENTS
Everywhere you look™



ISO 9001
CERTIFIED

Manual Print History

The print history shown below lists the printing dates of all revisions and addenda created for this manual. The revision level letter increases alphabetically as the manual undergoes subsequent updates. Addenda, which are released between revisions, contain important change information that the user should incorporate immediately into the manual. Addenda are numbered sequentially. When a new revision is created, all addenda associated with the previous revision of the manual are incorporated into the new revision of the manual. Each new revision includes a revised copy of this print history page.

Revision D (Document Number 164-082005)	August 2005
Revision E (Document Number 164-102005)	October 2005
Revision F (Document Number 164-012006)	January 2006
Revision G (Document Number 164-092006)	September 2006
Revision H (Document Number 164-112006)	November 2006
Revision J (Document Number 164-022009)	February 2009
Revision K (Document Number 164-062009)	June 2009
Revision L (Document Number 164-082010)	August 2010
Revision M (Document Number 164-102012)	October 2012
Revision N (Document Number 164-122012)	December 2012



Visit www.teledyne-hi.com for WEEE disposal guidance.

Hastings Instruments reserves the right to change or modify the design of its equipment without any obligation to provide notification of change or intent to change.

Table of Contents

1.0	QUICK START INSTRUCTIONS	5
2.0	SAFETY	6
3.0	FEATURES	7
4.0	SPECIFICATIONS.....	9
5.0	FRONT PANEL	10
6.0	REAR PANEL.....	11
7.0	WIRING.....	12
7.1.	POWER.....	12
7.2.	COMMUNICATIONS	12
7.3.	TRANSDUCER CONNECTIONS.....	13
7.4.	ALARMS.....	13
7.5.	ANALOG SIGNAL FOLLOWERS.....	14
8.0	MANUAL OPERATION	15
8.1.	POWER ON/OFF	15
8.2.	CHANGING THE COMMAND SET POINT	15
8.3.	OVERRIDE OPEN	15
8.4.	OVERRIDE CLOSED.....	15
8.5.	SETTING A CHANNEL TO AUTO CONTROL.....	16
8.6.	SETTING A CHANNEL TO DIRECTLY METER INCOMING SIGNALS.....	16
8.7.	SETTING A CHANNEL TO DISPLAY THE TOTALIZER FUNCTION	16
9.0	EXTERNAL/REMOTE OPERATION	18
9.1.	SELECTING EXTERNAL/REMOTE OPERATION (FRONT PANEL ONLY)	18
9.2.	CHOOSING RS-232 COMMUNICATION.....	18
9.3.	CHOOSING RS-485 COMMUNICATION.....	18
10.0	SETUP/CAL MODE	19
10.1.	ENTERING THE SETUP/CAL MODE	19
10.2.	DISPLAY SETUP.....	19
10.2.1.	BLANKING A DISPLAY LINE/CHANNEL	19
10.2.2.	SELECTING DISPLAY BRIGHTNESS.....	19
10.2.3.	SELECTING UNIT-OF-MEASURE.....	20
10.2.4.	SELECTING GAS ID	20
10.2.5.	SETTING A/D CONVERSION RATE (FILTER).....	20
10.2.6.	FRONT PANEL LOCK OUT.....	21
10.3.	TOTALIZER SETUP	21
10.3.1.	COUNT UP TO A SET POINT	21
10.3.2.	COUNT DOWN FROM A SET POINT	22
10.3.3.	COUNT CONTINUOUSLY	22
10.4.	EXTERNAL COMMUNICATION SETUP	22
10.4.1.	RS-232 SETTINGS	22
10.4.2.	RS-485 SETTINGS	22
10.5.	SELECTING THE ANALOG SIGNAL LEVEL.....	23
10.5.1.	ZERO TO FIVE VOLT OPERATION.....	23
10.5.2.	ZERO TO TEN VOLT OPERATION	23

10.5.3.	FOUR TO TWENTY MILLIAMPER OPERATION	23
10.6.	SETTING LIMIT ALARMS	24
10.6.1.	SETTING A SINGLE CHANNEL'S HIGH LIMIT	24
10.6.2.	SETTING A SINGLE CHANNEL'S LOW LIMIT	24
10.6.3.	SETTING A SINGLE CHANNEL'S HYSTERESIS.....	24
10.7.	SETTING RATIO CONTROL PARAMETERS	25
	ENABLING RATIO CONTROL	25
10.8.	CALIBRATING A CHANNEL TO ITS INCOMING SIGNALS	26
10.8.1.	RESETTING THE ZERO ONLY	26
10.8.2.	RESETTING THE SPAN ONLY.....	26
10.8.3.	RESETTING ZERO AND SPAN.....	27
10.8.4.	SETTING A MULTIPLICATION FACTOR	27
10.9.	SERIAL COMMUNICATION.....	28
10.9.1.	COMMANDS	28
10.9.2.	SET POINT QUERIES	28
10.9.3.	ALARM/FLAG QUERIES	28
11.0	APPENDIX A	30
12.0	APPENDIX B	33
13.0	APPENDIX C.....	33
14.0	APPENDIX D.....	36
15.0	DRAWINGS	41
16.0	WARRANTY.....	42
16.1.	WARRANTY REPAIR POLICY	42
16.2.	NON-WARRANTY REPAIR POLICY.....	42

1.0 Quick Start Instructions

Important – The Power^{Pod}-400 comes calibrated from the factory according to your specifications. No set up is necessary unless you need to change the specs

- 1ea Power^{Pod}-400
- 1ea AC power cord
- 1ea 15-pin, Hi Density, D-style connector
- 1ea 9-pin, D-style connector
- 1ea user's manual

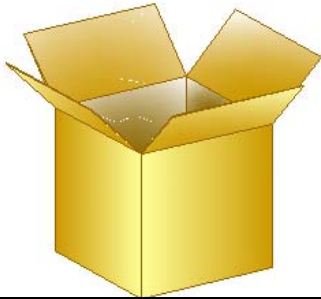

When unpacking the Power^{Pod}, the package will contain everything you need.

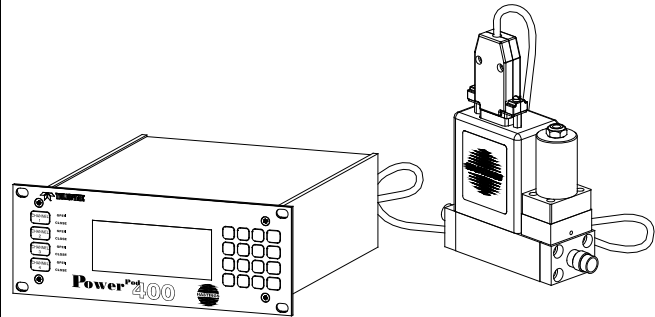

Connect a "known good" cable to the desired channel (See next frame for pin-outs)

J-1	Ch1
J-2	Ch2
J-3	Ch3
J-4	Ch4
J-5	Analog out
J-6	RS-232
J-7	RS-485
J-8	Alarms
J-9	RS-485

Transducer Power, Command and Analog Signals.

Transducer Signal, Volts Only

Serial Com Port

Multi-drop com port (Daisy Chained)

Open-collector Alarms

Multi-drop com port (Daisy Chained)

Pin-outs (see section 7)

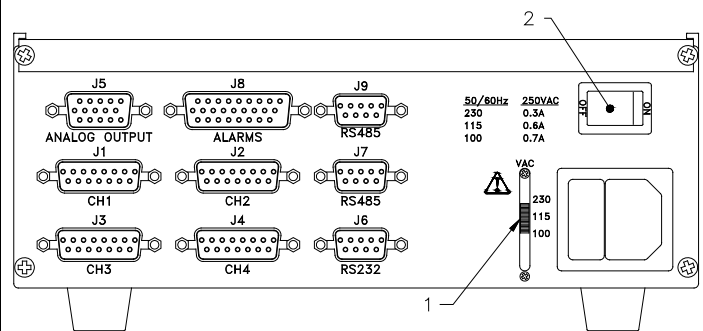

- 1) Check power setting switch on the back panel and make sure it is set appropriately.
- 2) Ensure the power switch is off, and then connect the power cord.

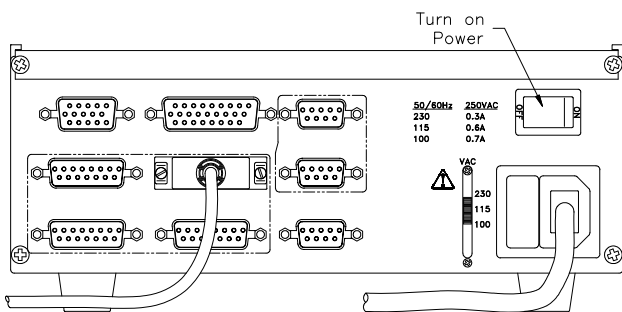

Turn power switch to on position. If you have just turned on the mass flow instrument and the power, some settling is necessary.

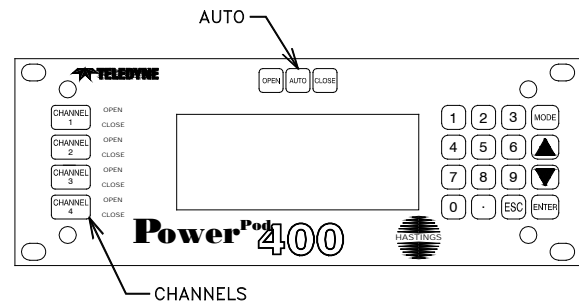

- 1) Press the desired Channel # Key. Press the Auto key.
(For Controllers)
- 2) Press the desired Channel # Key. Enter desired flow. Press the enter key.

2.0 Safety

Read this manual in its entirety before operating the **POWER^{POD}-400** Power Supply/Totalizer. The **POWER^{POD}-400** is designed to operate with most Teledyne Hastings Instruments (THI) flow controllers and meters. Read all wiring and power hookup instructions and understand the requirements prior to using another manufacturer's products with the **POWER^{POD}-400**. Insure that any product being interfaced with the **POWER^{POD}-400** is wired according to prevailing local safety and operational standards before operating.

The following symbols and terms may be found on THI products and/or in THI manuals and indicate important information.



When found on the device, this symbol indicates that the operator should refer to the manual for important instructions on the proper use of this device. When found in the manual, this symbol indicates that the reader should understand the implications contained in the text before operating the device.



This symbol indicates that a shock hazard may be present. Read the instruction manual carefully and insure that the device is wired properly and that all settings have been checked prior to applying power to the device.

The **WARNING** label indicates important information that should be heeded for safe and proper performance of the device.

The label, **CAUTION**, is used to indicate that damage to the power supply or equipment connected to it could occur if directions are not followed. Warranty could be invalidated if the instructions in this manual are not followed.

3.0 Features

The **POWER^{POD}-400** serves as a convenient control center that can be rack-mounted using standard half-rack hardware or can be used as a bench top unit. The **POWER^{POD}-400** is equipped with a 4 X 20 character, vacuum fluorescent display (VFD). The display emulates a liquid crystal display in its command structure but the VFD gives the unit a greater viewing angle and better visibility than available with most conventional LED or LCD displays. The display can be set to four different brightness levels. Use a lower brightness setting to extend the already long expected life time of the display. Use brighter settings for viewing areas where ambient light may be too bright or cause glare, or where greater viewing distances are required.

Most features are accessible via the membrane keys on the front panel. Consult the section on each function to check its availability. Operators are guided through the many features and options by selecting their choices from an intuitive menu structure.

FRONT PANEL LOCKOUT



The Front Panel Lockout function is only available through serial communication. Manual Overrides remain available during Lockout via a minimum number of keystrokes using dedicated keys for this purpose and allow any command setting to be overridden in either the high (open) or low (closed) state.

ANALOG RANGE SELECTION

Analog signal and control ranges are operator selectable. The operator can choose between three different DC ranges:

0 -5 VDC, 0-10 VDC or 4 -20 mA.

A fifteen (15) pin, high density, sub-miniature, D-type connector is provided for separate monitoring of each channel's analog transducer signal.

CAUTION: Consult the appropriate section for limits to the loading of these signals.

SERIAL COMMUNICATION

The **POWER^{POD}-400** comes equipped with standard RS-232 and RS-485, serial communication. Most functions, features, signals and alarms are accessible and modifiable via any remote computer.

The following commands are manual commands only:



OPEN, AUTO and CLOSE.

The status of these settings can be read via serial communication but they cannot be changed except manually, from the front panel.

POWER SELECTION



Power input is switchable between 100 VAC, 115 VAC and 230VAC (50 or 60 Hz) via the rear panel. For the safety of the operator as well as the device, the correct power level should be selected prior to connecting to the power mains. See the table “POWERPOD-400 Specifications” in section 3.0 for the proper fusing when changing power settings.

RATIO CONTROL

Ratio control is possible between channels using a familiar master/slave configuration. Channel one (1) must be enabled as the master channel. Any combination of the remaining channels is possible for slave channel assignment.

TOTALIZER

A Totalizer function is present for each channel with the capability of counting down from a set point, counting up to a set point or continuous count up. The maximum count is ± 999999 units. When the set points are reached, a memory flag for each set point is set to a digital ‘1’ indicating a Boolean ‘true’ value. **The Totalizer set point flags must be polled via digital communication to be read.** Each flow channel has one low-limit and one high-limit set point available. These alarms are available via open-collector, opto-isolated outputs on the rear panel as well as serial communication.

POWER OUTAGES AND THE OVERRIDE CONDITION



In the event of a power outage, even one of short duration, the **POWERPOD-400** is designed to conduct a software reset. During the period of time in which the reset is occurring, it will not accept or respond to any commands either manually or digitally until the reset process is completed. After said reset, the **POWERPOD-400** will have remembered all previously entered set-points but all channels are designed to come up in the “Override-CLOSEd” condition. For meters, this should have no affect on their behavior. All analog-only, THI, flow controllers with normally-closed (NC) valves will close and remain closed until operator intervention manually returns selected channels’ Override condition back to the AUTO mode.

For all other controllers, this means that the control signal (pins 5 to 14) of J1 through J4 will return to the previously set level. For controllers not taking advantage of the Override function (pin 8), these controllers will return to their normal, preset operating condition unless other intermediary steps are undertaken. Controllers that are making use of the override function (Pin 8) and have normally-open valves will be driven to the fully open condition.

4.0 Specifications

Power ^{Pod} -400 Specifications Table			
Specification	Value	Units	Notes
Power Inputs			
V	100	VAC	0.7 A, 250VAC, SB Fuse
	115		0.6 A, 250VAC, SB Fuse
	230		0.315 A, 250VAC, SB Fuse
P	68	VA	
<i>f</i>	50 -60	Hz	
Transducer			
Number Channels	4		
V _{Supply}	±15	VDC	Bi-polar, per Channel
I _{Supply}	±250	mA	Bi-polar, per Channel
I/O	0 - 5	VDC	
	0 - 10		
	4 - 20	mADC	
Display			
Type			Vacuum Fluorescent, LCD Emulator
# Lines	4		
# Characters	20		
Brightness Levels	4		
A/D Converter			
Filtering Rate	4, 15, 30, 100	Hz	
Alarms			
3 per channel	1 High		
	1 Low		
	1 Total		
Dimensions			
Front Panel (h x w)	3.5 x 9.5	in	
Case (h x w x d)	3 x 8 x 9.5	in	
Hole Centers (h x w)	3 x 8.825	in	
Weight	5 1/4	lbs	

5.0 Front Panel

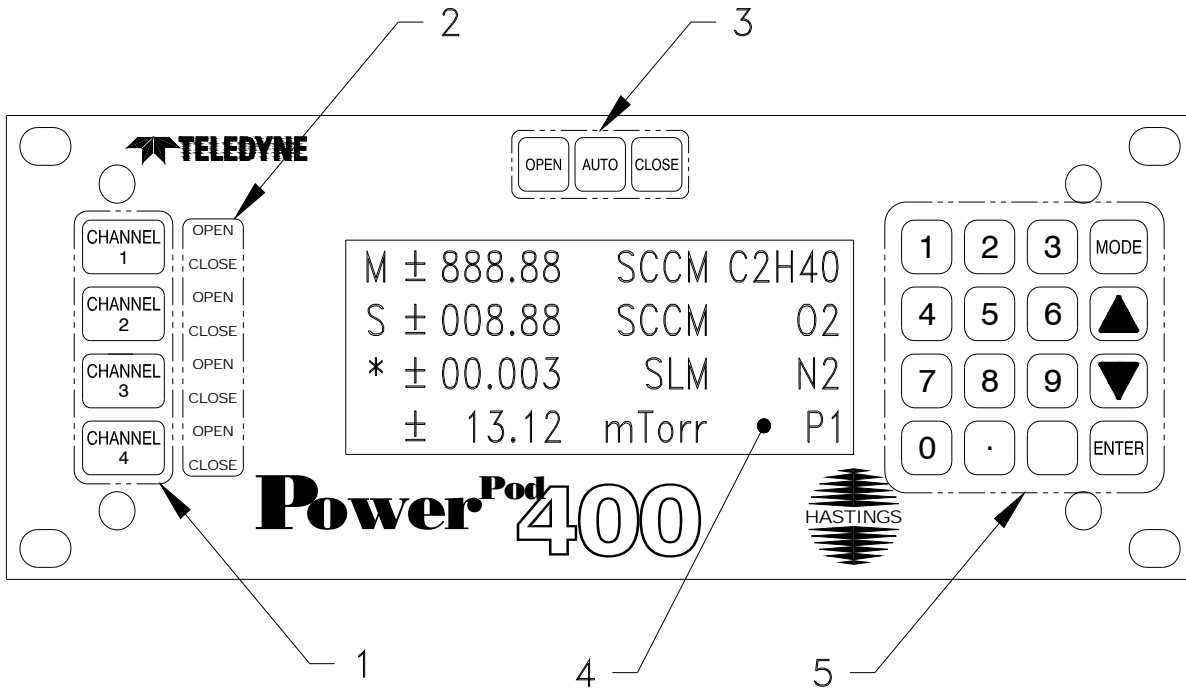

1. CHANNEL NUMBER SELECT KEYS

Selects channel for editing. An asterisk (*) appears in the first column of the display to indicate that this is the channel to be edited.

2. OVERRIDE INDICATORS

Indicates when a channel's command signal is overridden high (OPEN) or low (CLOSED).

3. OVERRIDE KEYS

Override the command signal on the **ACTIVE CHANNEL**. **OPEN** sets control override (pin 8) to +15V. **CLOSED** sets command to -15V. **AUTO** allows the user to set the command signal for normal operation. A channel must be active before these keys can become operational.

4. DISPLAY AREA

Column 1:	Reserved for displaying ACTIVE CHANNEL (*), MASTER channel (M), SLAVE (S) or TOTAL (T).
Column 2:	Reserved for polarity indicator.
Col's 3 – 8:	Signal monitor. Displays current input signal while in METER mode, AVERAGE while set to average readings or TOTAL while in TOTALIZER mode.
Column 9:	Space
Col's 10 – 14:	UNITS OF MEASURE display.
Column 15:	Space
Col's 16 – 20:	GAS ID .

5. KEYPAD

Use to enter **SET POINTS** or to modify the **SETUP** or **CALIBRATION** of control unit.

6.0 Rear Panel

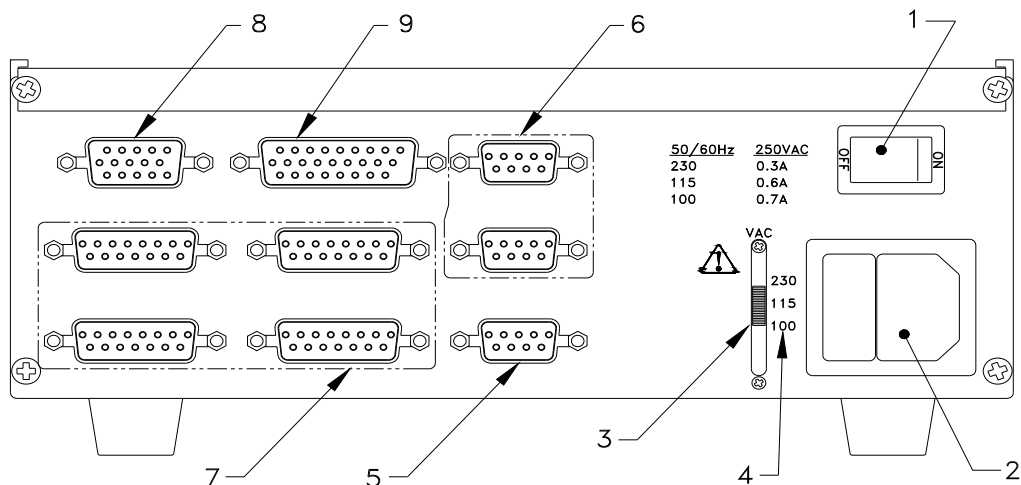

1. POWER ON/OFF SWITCH
2. POWER INLET & FUSE
3. POWER SELECTOR SWITCH
4. FUSE Vs. POWER SETTING TABLE
5. RS-232 SERIAL PORT CONNECTOR (J6)
6. RS-485, DAISY CHAINED, SERIAL PORT CONNECTORS (J7, J9)
7. TRANSDUCER CONNECTORS (J1-J4)
8. ANALOG OUTPUT (J5)
9. ALARMS (J8)

7.0 Wiring

7.1. POWER



Power is supplied through a fused, AC jack on the rear panel (item 2). Use the power cord supplied with the unit (PN15-17-011 for 115 VAC, 60Hz). See the following table for selecting the proper fuse rating. Use a metric, 5 x 20 mm sized, time-delayed fuse.

Power Setting (50 – 60 Hz)	Fuse Rating	THI P/N
100 VAC	0.315 Amp/250 VAC	23-05-038
115 VAC	0.60 Amp/250 VAC	23-05-039
230 VAC	0.70 Amp/250 VAC	23-05-040

Cords without plugs are supplied with units shipped outside of the U.S. Consult and comply with any local laws and/or codes when connecting to any AC main. The AC input is user selectable between 100, 115 or 230 VAC, 50 or 60 Hz, via an AC selector switch next to the AC jack (Item 3).

WARNING: Be sure to set the power select switch prior to connecting to mains. Re-fuse the connector according to the table above.

7.2. COMMUNICATIONS

Connectors J6 (Item 4), J7 (Item 6) and J9 (Item 6) are for RS-232, RS-485 connections respectively. Settings for serial communication are accessible via the front panel.

J6		
RS-232 (DB-9)	1	Unused
	2	Tx
	3	Rx
	4	Unused
	5	Gnd
	6	Unused
	7	RTS
	8	CTS
	9	Unused

J7, J9		
RS-485 (DB-9)	1	Unused
	2	Rx-
	3	Tx+
	4	Unused/Gnd (Gnd)
	5	Unused
	6	Gnd/VCC (VCC)
	7	R+
	8	T-
	9	Unused

7.3. TRANSDUCER CONNECTIONS

Connectors J1, 2, 3 and 4 (Item 7) are 15 pin D style connectors wired in the standard Hastings Instruments pin-out (H pin-out).

J1, J2, J3, J4	1	NC	
	2	NC	Valve Cntrl Voltage
	3	NC	mA Sig
	4	NC	mA Sig
	5	Sig. Com.	
	6	Sig. In	
	7	Case Gnd.	
	8	Cntrl Over-ride	1.5mA
	9	-15 VDC	
	10	NC	
	11	+15 VDC	
	12	Valve Return	
	13	NC	Ext-In
	14	Set Point Out	
	15	+5 VDC Ref.	Not Used.

7.4. ALARMS

Connector J8 (item 9) provides the user with open-collector, opto-isolated alarms for individual channels. Each channel is provided with one user settable “High” and one “Low” alarm.

J8	1	Chnl 1, High Alarm
	2	Chnl 1, Low Alarm
	3	Chnl 1, Alarm Return
	4	Chnl 2, High Alarm
	5	Chnl 2, Low Alarm
	6	Chnl 2, Alarm Return
	7	NC
	8	NC
	9	NC
	10	NC
	11	NC
	12	NC
	13	NC
	14	NC
	15	NC
	16	NC
	17	NC
	18	NC
	19	Chnl 3, High Alarm
	20	Chnl 3, Low Alarm
	21	Chnl 3, Alarm Return
	22	Chnl 4, High Alarm
	23	Chnl 4, Low Alarm
	24	Chnl 4, Alarm Return
	25	NC
	26	NC

7.5.ANALOG SIGNAL FOLLOWERS

Analog signals from each channel's transducers are available for reading or for sending to another power supply for ratio (Master/Slave) operation. The signal can be sent to a channel on another power supply and programmed as a Master for that power supply, allowing the remaining three channels to operate as slaves. When operating 4 – 20 mA instruments, the followers supply a 0.5 -2.5 volt signal.

J5	1	Channel 1 Signal
Analog Out (HD DB-15)	2	Channel 1 Return
	3	Channel 2 Signal
	4	Channel 2 Return
	5	
	6	
	7	
	8	
	9	
	10	
	11	Channel 3 Signal
	12	Channel 3 Return
	13	Channel 4 Signal
	14	Channel 4 Return
	15	

8.0 Manual Operation

8.1. POWER ON/OFF



The Power On switch, item 1 in rear panel drawing, is located in the upper right corner of the rear panel. Insure that the proper power setting is selected prior to turning the power on. See the Power section of WIRING THE **POWER^{POD}-400**, above.

8.2. CHANGING THE COMMAND SET POINT

Channel two (2), example shown.

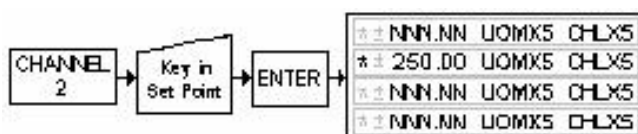

Press the desired **CHANNEL #** key. An asterisk appears in the first space on the line representing the selected channel. The meter display is immediately replaced with the current set point. Pressing a number key begins the editing process. The cursor lands on the channel set point to be edited, and the new command is entered with the most significant bit (MSB) first. The set point is filled in from left to right on the display. When entering a new set point, **you must use the decimal key when it has been used in setting the SPAN**. Pressing **ENTER** completes the editing process. The old command is not changed until the **ENTER** key is actuated. Hitting the **ESC**ape button at any time prior to the **ENTER** key will return the display to its previous state without any changes being made. This command will not be applied to the output until the channel is set for **AUTO** operation. See *Setting a Channel to AUTO Control*.

8.3. OVERRIDE OPEN

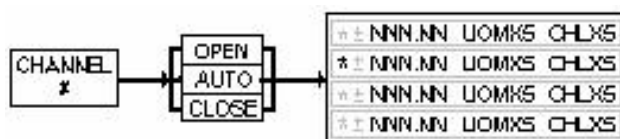

Press the desired **CHANNEL #** key. An asterisk appears in the first space on the line representing the selected channel. The meter display is immediately replaced with the current set point. Pressing the **OPEN** key results in the application of +15 VDC to pin number eight (8) of the corresponding 15 pin Sub-D connector and returns the previously programmed metering function to the display.

8.4. OVERRIDE CLOSED

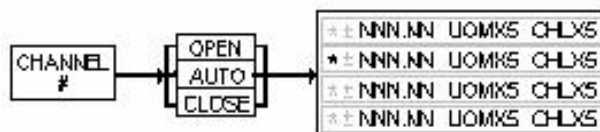

Press the desired **CHANNEL #** key. An asterisk appears in the first space on the line representing the selected channel. The meter display is immediately replaced with the current set point. Pressing the **CLOSE** key results in the application of -15 VDC to pin number eight (8) of the corresponding 15 pin Sub-D connector and returns the previously programmed metering function to the display.

8.5.SETTING A CHANNEL TO AUTO CONTROL

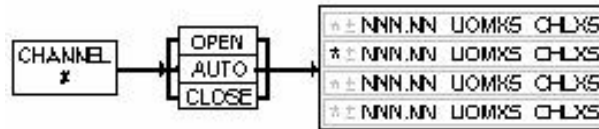

Press the desired **CHANNEL #** key. An asterisk appears in the first space on the line representing the selected channel. The meter display is immediately replaced with the current set point. Pressing the **AUTO** key causes pin number eight (8) of the 15 pin Sub-D connector to float and returns the previously programmed metering function to the display. Pin 14 signal levels are now available for control.

8.6.SETTING A CHANNEL TO DIRECTLY METER INCOMING SIGNALS

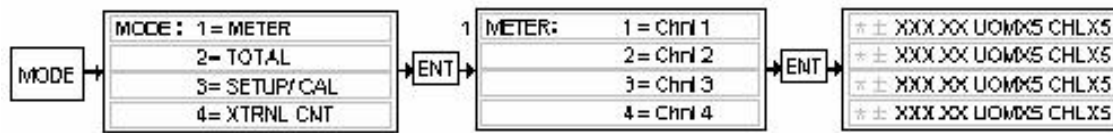

Press the **MODE** key. The **MODE** menu appears in the display. To select **METER**, press **1**, and then **ENTER**. The **METER** menu allows the selection of the desired channel. Press the number key that corresponds with the desired channel followed by **ENTER**. The previously programmed display returns with the selected channel reading the signal between pins 5 and 6 of the corresponding channel's 15 pin D-connector (J1 – J4).

8.7.SETTING A CHANNEL TO DISPLAY THE TOTALIZER FUNCTION

The POWERPOD-400 provides an integrated (*Riemann Sum*) value of the incoming signal for each channel.

$$T = \sum (f_s * C * f_t), \text{ where: } \left\{ \begin{array}{l} T = Total \\ f_s = Fractional Signal Factor \\ C = CAL \text{ value or Span Value} \\ f_t = Fractional Time Interval \end{array} \right.$$

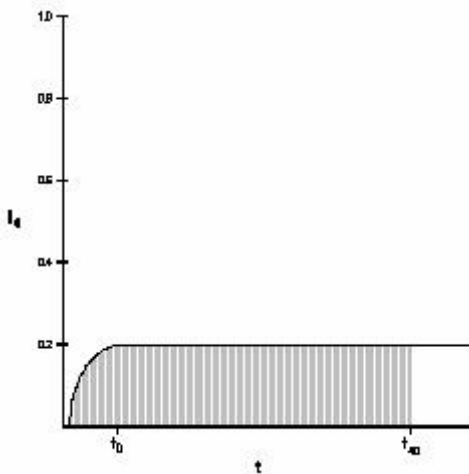

Each channel samples the incoming signal at a rate corresponding to the preset A/D conversion rate in Hz. At each sampling interval, the TOTALIZER function multiplies the average signal, as a fraction of the full-scale value (5v, 10v or 20 mA), times the *span*, or *cal*, value. This results in a rate for that interval. Next, a time element factor is determined according to the flow rate programmed for that channel as follows.

For a time element of seconds, the factor is 1/10.
 For minutes, the factor is 1/600.
 Hours use a factor of 1/36000.

Each calculation is summed and stored for a TOTAL value.

Example (See Graph):

A linear flow transducer with a DC output of 0 to 5 volts is calibrated for a maximum flow of 25 SLH. The transducer is connected to one channel of a **POWER^{POD}-400** which is CAL'd to read 25.000 at 5 volts input and has been programmed to display rate in SLH. The transducer is sending a constant 1.000-volt signal to the POWERPOD-400. What is the total flow after 40 minutes?

During one sampling interval, the TOTALIZER reads the one-volt signal and calculates the fraction of the possible full-scale value.

$$1 \text{ volt}/5 \text{ volts or } 0.20$$

The fractional signal value is multiplied times the CAL value

$$1/5 * 25 = 5$$

Then, because the channel's programmed rate is in SLH (standard liters per hour), a factor of 1/3600 is applied to the result.

$$5 * 1/36000 = 1.389 \times 10^{-4} \text{ standard liters per sampling interval.}$$

A constant signal received over a 40 minute time period would amount to 40 minutes * 60 seconds * 10 samples per second = 24000 samples. The TOTAL would be

$$2.400 \text{ E}03 * 1.389 \text{ E-}04 = 3 \text{ 1/3 Std Liters.}$$

If no rate is programmed on that channel, The TOTALIZER function is disabled for that channel and the display returns to its regular metering configuration.

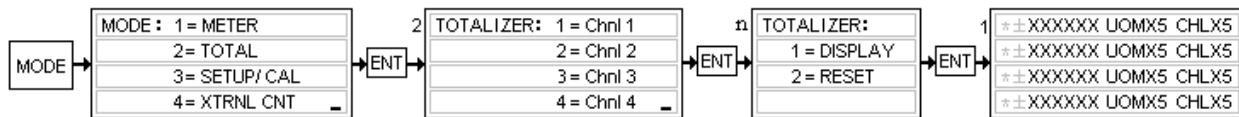

To enable the **TOTALIZER**, press the **MODE** key. The **MODE** menu appears in the display. To select **TOTAL**, press 2, and then **ENTER**. The **TOTALIZER** menu allows the operator to select the desired channel. Press the number key that corresponds with the desired channel followed by **ENTER**. A **TOTALIZER** menu is presented that allows the operator to go directly to displaying whatever the Totalizer has currently stored as the total or to reset the counter. If **DISPLAY** is selected by pressing the number 1 key followed by **ENTER**, the display will return to normal with the most recently stored total being displayed on the appropriate line. If **RESET** is chosen by pressing the number 2 key followed by **ENTER**, the display returns with the total value reset according to the pre-selected counting mode presented in the table below with the Totalizer counting.

Mode	Reset Value
Count Down	Set Point
Count Up	Zero
Continuous	Zero

9.0 External/Remote Operation

9.1. SELECTING EXTERNAL/REMOTE OPERATION (Front Panel Only)

The **POWER^{POD}-400** allows the user to select different methods of serial communication and control. The following text describes how to choose and activate the desired method. Further information and instructions on how conditions may be changed can be found in section 10, **SETUP/CAL** mode.

9.2. CHOOSING RS-232 COMMUNICATION

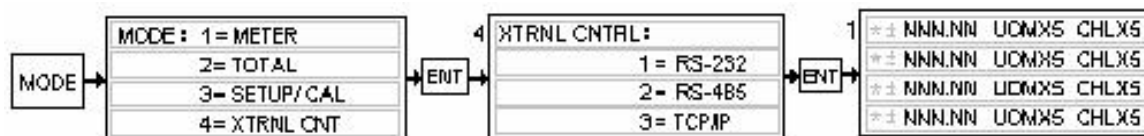

Press the **MODE** button. The **MODE** menu is displayed. Press the number “4” key for **XTRNL CNTRL**. The **XTRNL CNTRL** menu is displayed. Choose RS-232 by pressing the number “1” key. The normal display will return to its previously programmed state.

9.3. CHOOSING RS-485 COMMUNICATION

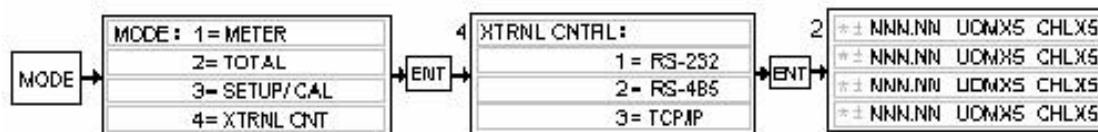

Press the **MODE** button. The **MODE** menu is displayed. Press the number “4” key for **XTRNL CNTRL**. The **XTRNL CNTRL** menu is displayed. Choose RS-485 by pressing the number “2” key. The normal display will return to its previously programmed state.

10.0 Setup/Cal Mode

10.1. ENTERING THE SETUP/CAL MODE

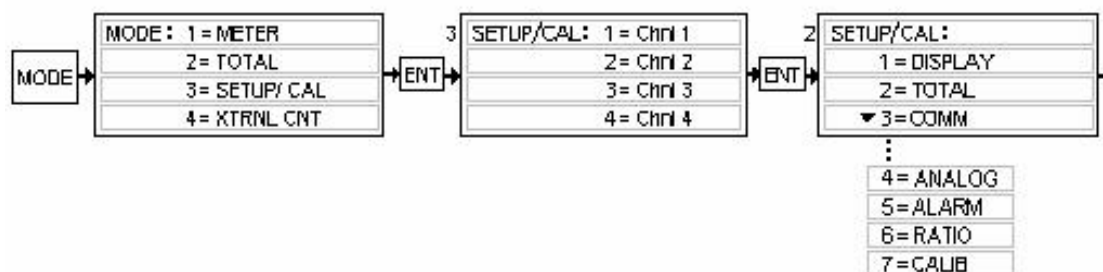

Pressing the **MODE** key causes the **MODE** menu to be displayed. Choose the **SETUP/CAL** mode by pressing the number “3” key then **ENTER**. A **CHANNEL SELECT** menu is presented on the display. It should be noted that, although the user must select a specific channel number, some choices in the following menus may affect the operation of all channels and/or the display (ex; Display Brightness, type of communication). See the following menu options for more details.

10.2. DISPLAY SETUP

After entering the **SETUP/CAL** mode and **selecting a channel number** as described in the previous section, several selections are available that will affect the display. Follow the steps below to gain the desired customized display.



Note: *Front panel lockout and display line (channel) blanking are only available through serial communication.*

10.2.1. Blanking a Display Line/Channel

Use the serial command “DndCr”, where
n = channel number,
d = 1 for Totalizer Mode,
2 for Meter Mode,
3 for a blanked line and
Cr = carriage return.

10.2.2. Selecting Display Brightness



While the **SETUP/CAL** menu is displayed, choose **DISPLAY** by pressing the keys “1” + **ENTER**. Choose **BRIGHTNESS** by pressing the number “1” key + **ENTER**. The **BRIGHTNESS** menu will be visible. One of four different brightness levels can be chosen by pressing a number key. The number “1” key selects the dimmest setting while the number “4” key selects the brightest. Any change in brightness will affect the entire display after pressing the **ENTER** key.

10.2.3. Selecting Unit-of-Measure

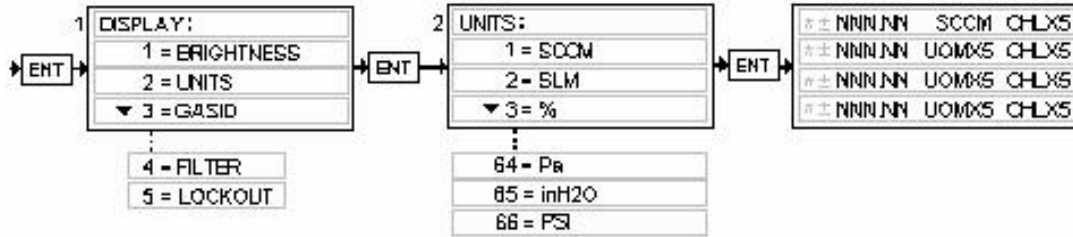

After entering the **SETUP/CAL** mode and after selecting a channel number, the **SETUP/CAL** menu is displayed. Choose **DISPLAY** (1) + **ENTER** and then select **UNITS** by pressing the number “2” key + **ENTER**. The **UNITS** menu will be displayed allowing the selection of over 50 different units of measure (UOM) simply by pressing the number key corresponding to the desired UOM. The number can be found by scrolling up or down until the desired UOM is displayed or by consulting Appendix B, at the end of this manual. Once selected, the UOM will be displayed in character spaces 10 to 14 on the appropriate line. Selecting UOM = “0” results in the UOM characters being blanked.

10.2.4. Selecting Gas ID

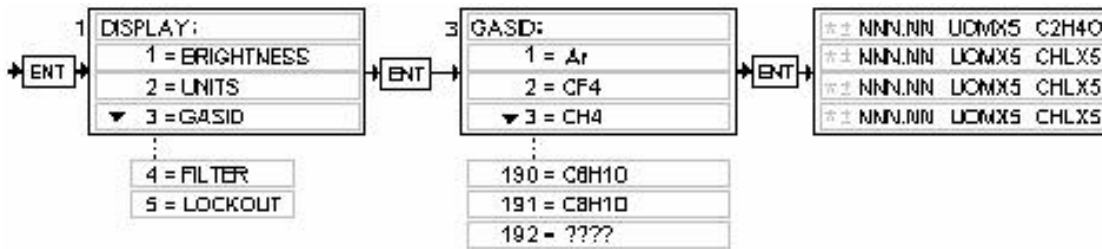

While the **SETUP/CAL** menu is displayed, Select the **DISPLAY** menu by pressing 1 + **ENTER**. Then choose **GASID** by pressing 3 + **ENTER**. The **GASID** menu will be displayed allowing the selection of nearly one hundred different chemical symbols simply by pressing the number key corresponding to the desired gas. The number can be found by scrolling up or down until the desired gas is displayed or by consulting Appendix C at the end of this manual. Once selected, the formula will be displayed in character spaces 16 through 20 on the appropriate line.



Note: *Formulae too long to be completely displayed will display the Hastings Instruments Gas ID number. Choosing “0” will blank the GASID elements on the display.*

10.2.5. Setting A/D Conversion Rate (Filter)

Press the **MODE** button. The **MODE** menu is displayed. Press the number “3” key followed by **ENTER**. The **CHANNEL SELECT** menu is displayed. Choose the channel whose signal is to be filtered using the number keys. For example, “1” + **ENTER**. The **SETUP/CAL** menu is displayed.

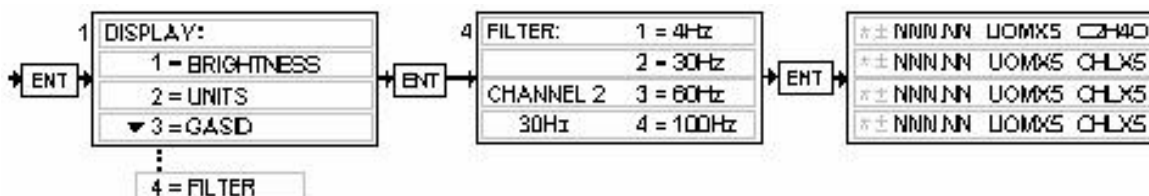

After **SETUP/CAL** is selected and a channel number has been chosen, the **SETUP/CAL** menu is displayed. choose **DISPLAY** by pressing the number “1” key + **ENTER**. The **FILTER** option can be reached by scrolling down once to view the selection number and then pressing the “4” key + **ENTER**. A conversion rate of 4, 15, 30 or 100 Hertz may be selected by entering its menu number + **ENTER**. Enter the number of the desired A/D conversion rate and press **ENTER**. The normal display will return. Changes may be noticed in the flickering of the LSB on the display. In most situations, the flickering digits are an insignificant fraction of the display range and can be ignored. Should the flickering become annoying or make reading the display difficult, choose a slower rate of conversion.



NOTE: *Slower rates of conversion may affect the accuracy of the TOTALIZER in situations where flow is changing often. Steady flow rates will see little loss of TOTALIZER accuracy.*

10.2.6. Front Panel Lock Out

Front Panel Lockout is available only through serial communication. See the **SERIAL COMMUNICATIONS** section of this manual and Appendix A.



CAUTION: While the front panel is locked out, all command functions, excluding the override functions, are disabled. Commands can be overridden OPEN or overridden CLOSED during front panel lockout. This was determined to be useful both as a trouble shooting and as a safety tool. All other functions will be available only through the use of serial communication.

10.3. TOTALIZER SETUP

The **TOTALIZER** can be set to count up to a set point, to count down from a set point or to count up continuously to the maximum ability of the display (999999). In order for the **TOTALIZER** to work, a unit of measure must be chosen that includes a time element. For example, standard liters per hour (SLH) will totalize; percent (%) will not. Each mode is described in the following text and can be followed in the diagram below.

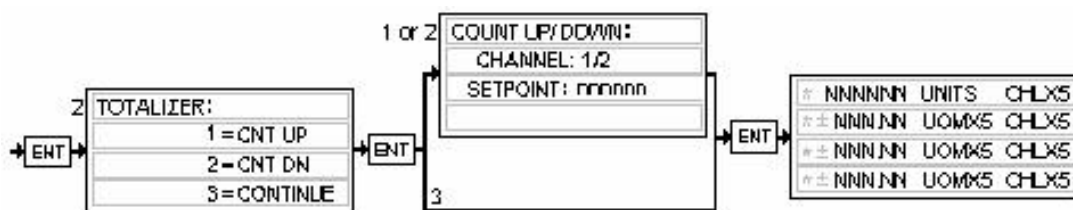

10.3.1. Count Up to a Set Point

The **TOTALIZER** will be set to count from zero (0) to a set point. When the set point is reached, a memory flag will be set to its logic high state. **This flag is readable only through serial communications.** The **TOTALIZER** will continue to count up to the maximum ability of the display.

While the **SETUP/CAL** menu is displayed, choose **TOTAL** by pressing the number “2” key followed by **ENTER**. A **TOTALIZER** menu is displayed. Press the number “1” key to choose the **CNT UP** option. The **COUNT UP/DN** window is displayed for the selected channel. Enter the desired set point using the numbered key pads and press **ENTER**. The unit returns the previously programmed display with the selected channel now displaying the Riemann Sum of the received transducer signal.

10.3.2. Count Down from a Set Point

The **TOTALIZER** will be set to count from a preset value to zero (0). **When zero is reached, a memory flag will be set to its logic high state. This flag is readable only through serial communications.** The **TOTALIZER** will continue to count in the negative direction from zero to the maximum ability of the display (-999999).

While the **SETUP/CAL** menu is displayed, choose **TOTAL** by pressing the number “2” key + **ENTER**. A **TOTALIZER** menu is displayed. Press the number “2” key to choose the **CNT DN** option. The **COUNT UP/DN** window is displayed. Enter the desired set point using the numbered key pads and press **ENTER**. The unit returns the previously programmed display with the selected channel now displaying the set point minus the Riemann Sum of the received transducer signal.

10.3.3. Count Continuously

The **TOTALIZER** will be set to count from zero (0) to the maximum ability of the display. No flags or alarms will be set.

While the **SETUP/CAL** menu is displayed, choose **TOTAL** by pressing the number “2” key and **ENTER**. A **TOTALIZER** menu is displayed. Press the number “3” key to choose the **CONT** option followed by the **ENTER** key. The previously programmed display returns with the selected channel now displaying the Riemann Sum of the received transducer signal.

10.4. EXTERNAL COMMUNICATION SETUP

The following text describes how the **POWER^{POD}-400** can be setup to respond to serial and network communication. Instruction structure and syntax is covered in the section, *Serial Protocol*.

10.4.1. RS-232 Settings

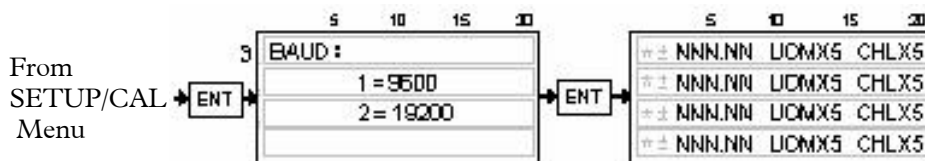

After selecting **SETUP/CAL**, select any channel number and hit **ENTER**, choose option number **3** via the numbered key pad. The first menu to be displayed is the **BAUD** menu. To select the desired baud rate press the number key **1** or **2** respectively. Eight bit bytes, no parity, one stop bit and no handshaking are automatically set. The preprogrammed display is returned upon completion.

10.4.2. RS-485 Settings

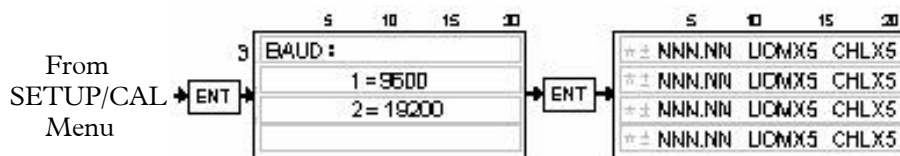

After selecting **SETUP/CAL**, select any channel number and hit **ENTER**, choose option number **3** via the numbered key pad. The **BAUD** menu will be displayed. To select the desired baud rate press the corresponding number key.

The default address as programmed at the factory is 01. If a different address is required, it may be changed using either RS-232 or 485. After making the proper serial connections, use the command *00X to read the default address. Use *00Xdd, where dd = the new address. If the old address is known, use DDXdd, where DD is the old address and dd is the new address. See the section on "Serial Communication: Commands" for more on command structure.

All commands listed in Appendix B are available for RS-485 use by inserting an asterisk and the unit's address in front of the command.

Ex) Set the units of measure on channel two (2) to %.

*10UM203Cr

The command, *00XCr can be used to poll the unit for its current address setting using either RS-232 or RS-485.

10.5. SELECTING THE ANALOG SIGNAL LEVEL

The **POWER^{POD}-400** is capable of 0 to 5 V, 0 to 10 V or 4 to 20 mA operation. Each level is user selectable. The following diagram applies no matter which level of operation is chosen.

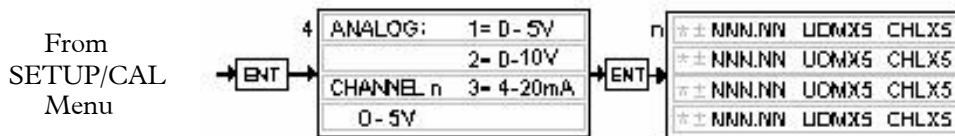

10.5.1. Zero to Five Volt Operation

While in the **SETUP/CAL** menu, select **ANALOG** by pressing the number 4 key and the **ENTER** key. From the **ANALOG SIGNAL** menu, choose **0V – 5V** by pressing the number 1 key and pressing the **ENTER** key. The normal display returns with 0 volts intended to correspond to 0% signal and 5 volts intended to correspond to the 100% signal. Calibration may be required.

10.5.2. Zero to Ten Volt Operation

While in the **SETUP/CAL** menu, select **ANALOG** by pressing the number 4 key and the **ENTER** key. From the **ANALOG SIGNAL** menu, choose **0V – 10V** by pressing the number 2 key and pressing the **ENTER** key. The normal display returns with 0 volts intended to correspond to 0% signal and 10 volts intended to correspond to the 100% signal. Calibration may be required.

10.5.3. Four to Twenty Milliamp Operation

While in the **SETUP/CAL** menu, select **ANLG** by pressing the number 4 key and the **ENTER** key. From the **ANALOG SIGNAL** menu, choose **4mA – 20 mA** operation by pressing the number 3 key and pressing **ENTER**. The normal display returns with 4 milliamps intended to correspond to 0% signal and 20 milliamps intended to correspond to the 100% signal. Calibration may be required.

10.6. SETTING LIMIT ALARMS

Each channel of the **POWER^{POD}-400** has one high limit alarm and one low limit alarm. Each alarm is provided by an open-collector, opto-isolated signal at a corresponding pin on the rear panel, connector J8. Use the provided diagram when referring to the text below.

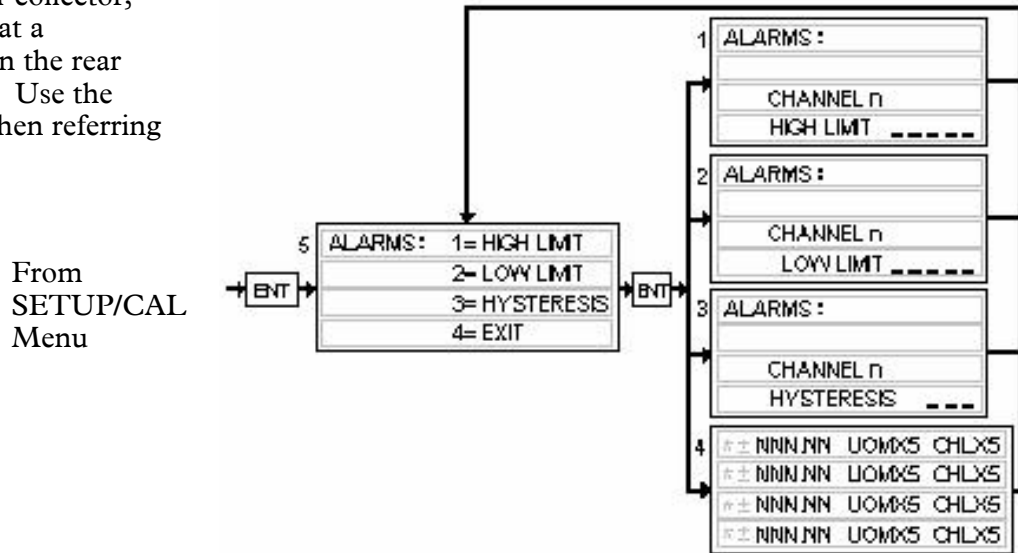

10.6.1. Setting a Single Channel's High Limit

After selecting a channel in the **SETUP/CAL** menu, choose **ALARMS** by pressing the number 5 key followed by the **ENTER** key. The **ALARMS** menu will be displayed. Pressing the number "1" key selects the **HIGH LIMIT** display. Using the number keys, enter the desired high limit level and then press **ENTER**. **EXIT** the loop by pressing the number "4" + **ENTER** key while the **ALARMS** menu is displayed.

10.6.2. Setting a Single Channel's Low Limit

After selecting a channel in the **SETUP/CAL** menu, choose **ALARMS** by pressing the number 5 key. The **ALARMS** menu will be displayed. Pressing the number 2 key selects the **LOW LIMIT** display. Using the number keys, enter the desired high limit level and then press **ENTER**. **EXIT** the loop by pressing the number 4 key while the **ALARMS** menu is displayed, followed by **ENTER**.

10.6.3. Setting a Single Channel's Hysteresis

After selecting a channel in the **SETUP/CAL** menu, choose **ALARMS** by pressing the number 5 key. The **ALARMS** menu will be displayed. Pressing the number 3 key selects the **HYSTERESIS** display. Using the number keys, enter the desired degree of Hysteresis followed by the **ENTER** key. **EXIT** the loop by pressing the number 4 key while the **ALARMS** menu is displayed, followed by **ENTER**.

10.7. SETTING RATIO CONTROL PARAMETERS

Enabling Ratio Control

Ratio control is achieved through the **SETUP/CAL** menu. Ratio Control is activated by selecting channel number one (1) and enabling it as master. After enabling channel one, the operator may assign the channels that will follow its signal by some factor.

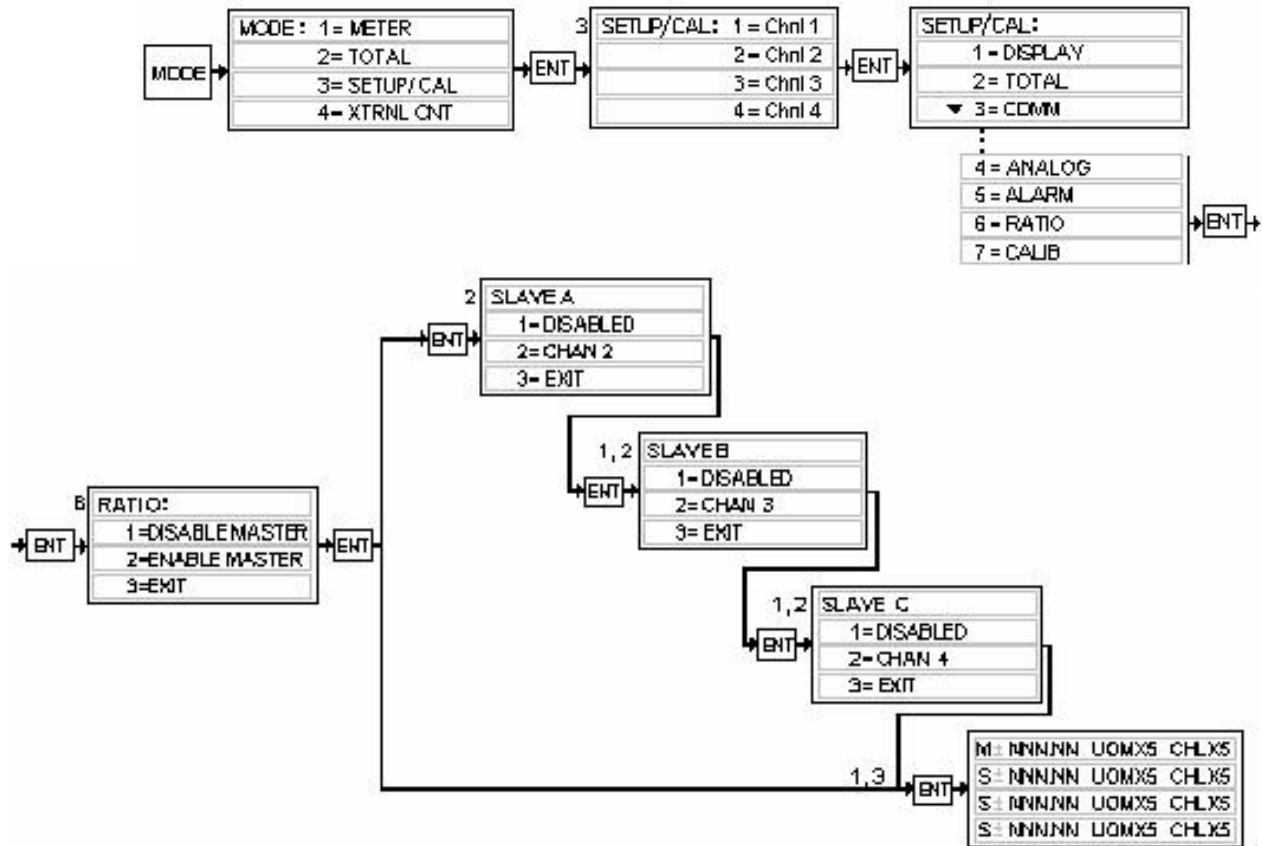

Press the **MODE** key and then **3 + ENTER**. Select channel one by pressing **1 + ENTER**. Choose **RATIO** by pressing the **6** key + **ENTER**. Channel one (1) is enabled as the master when you press **2 + ENTER**.

After enabling **RATIO** control, a series of menus labeled **SLAVE A**, **SLAVE B** and **SLAVE C** will be displayed. These menus correspond to channels 2, 3 and 4 respectively. Each of the channels, 2 through 4, can be enabled or disabled individually. For example, pressing the **1** key + **ENTER** while **SLAVE A** is being displayed will eliminate channel two (2) from ratio control and allow channel two to work normally as an independent channel. Pressing the number **2** key + **ENTER** will make channel 2 the first **SLAVE** and an **S** will appear in the first column of line two on the display. Note that, if **EXIT** is selected at any time, the previous settings remain unchanged and the display is returned to its previously programmed configuration.

10.8. CALIBRATING A CHANNEL TO ITS INCOMING SIGNALS

The **POWER^{POD}-400** is designed to accept the input from almost any transducer that operates in the ranges of zero to five volts, zero to ten volts or four to twenty milliamps. In most cases, transducers are capable of having their minimum signal and maximum signal adjusted to correspond with the minimum (ZERO) and maximum (SPAN) unit-of-measure that they are designed to reflect.

For example:

A transducer designed to output 0 volts while reading a temperature of 0 degrees centigrade and output 5 volts while reading 100 degrees centigrade is connected to channel one of the **POWER^{POD}-400**.

In actuality, the transducer is sending -0.23 volts at 0 degrees and 5.11 volts at 100 degrees. By zeroing channel one of the **POWER^{POD}-400** while reading the low signal from the transducer, the display will be 000.0 when the temperature is 0°C. Like wise, by setting the CAL value to 100.0 while reading the 5.11 volt signal causes the **POWER^{POD}-400** to display 100.0 when the temperature is actually 100°C.

This procedure will not account for any non-linearity in any transducer's output. That is, the accuracy/calibration of any transducer must be independently set, checked and verified before connecting to the POWER^{POD}-400, or, the transducer/ POWER^{POD}-400 combination must be calibrated together as a system, if the accuracy of the whole system is to be known.

10.8.1. Resetting the Zero Only

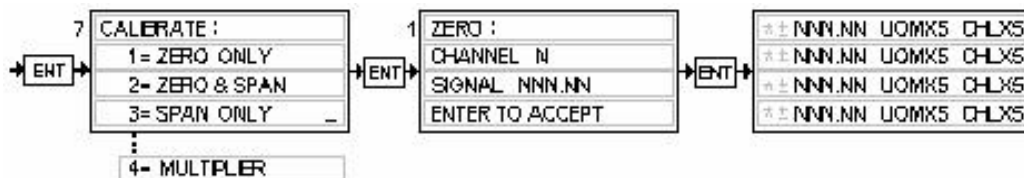

While the **SETUP/CAL** menu is being displayed and after making a selection from the **CHANNEL SELECT** menu, select **CALIBRATE** by pressing the number 7 key followed by **ENTER**, then choose **ZERO ONLY** by pressing the number 1 key and **ENTER**. The **ZERO** menu will be displayed which also displays the selected channel number and the signal being received. If this signal is an acceptable signal for zero, press the **ENTER** key to accept it. If the indicated signal is not an acceptable level for reading zero, the operator has an opportunity at this stage to correct any problems while reading the incoming signal before pressing the **ENTER** key and accepting it. Alternatively, the operator can press ESC to exit the **SETUP/CAL** mode and return to it later. After accepting the displayed signal level as the zero point, the display returns to its previously programmed settings. See Appendix D.

10.8.2. Resetting the Span Only

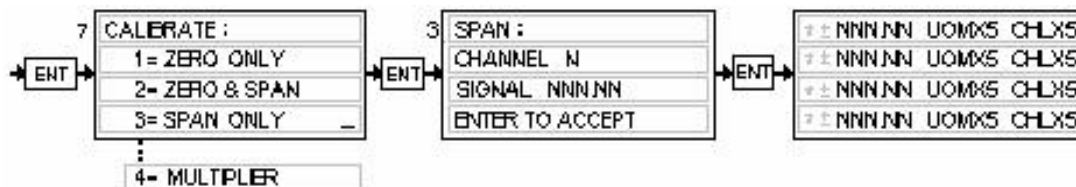

After selecting a channel in the **CHANNEL SELECT** portion of the **SETUP/CAL** menu, press 7 + **ENTER** to select **CALIBRATE**. **SPAN ONLY** is selected by pressing number 3 + **ENTER**. The **SPAN** window is displayed which contains the chosen channel and the incoming signal on that channel. If the displayed signal is an acceptable full range value, press **ENTER** to accept it. The previously programmed display returns with the selected channel now displaying the **CAL'd** value. If the incoming

signal is not an acceptable full range value, the operator has an opportunity to correct any problems at this stage prior to pressing **ENTER**. Alternatively, the operator can press **ESC** to exit **SETUP/CAL** and return later. See Appendix D.

10.8.3. Resetting Zero and Span

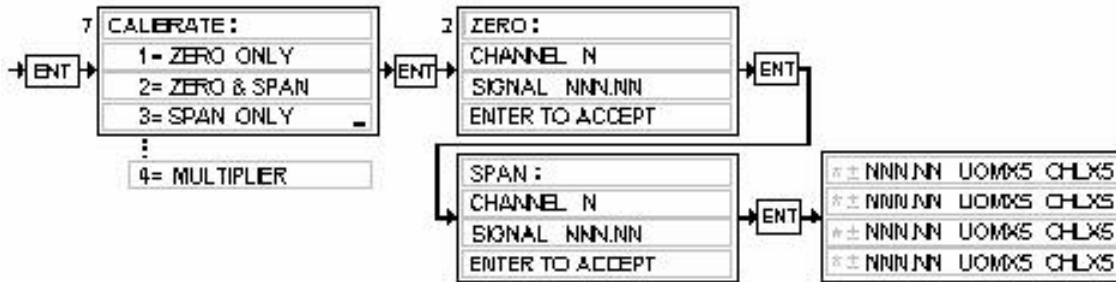

Should it be required to zero and set a new span value for a given channel, The menu option is provided that will present the programmer with the zero menu first, followed by the span, or cal, menu. After selecting a channel in the **CHANNEL SELECT** portion of the **SETUP/CAL** menu, press the number 7 key to select **CALIBRATE**. **ZERO & SPAN** is selected by pressing the number 2 key. The **ZERO** window is displayed first. It contains the chosen channel and the incoming signal on that channel. If the signal displayed is within an acceptable range for zero, Press the **ENTER** key to accept this signal as representing a display of zero while monitoring the transducer. If this signal is not appropriate, the user may correct the problem while the window is displayed or press the **ESC** key and come back at a later time to zero and span.

After setting the zero of the power supply, the SPAN menu window is displayed. If the displayed signal is an acceptable full range value, press **ENTER** to accept it. The previously programmed display returns with the selected channel now displaying the **CAL'd** value. If the incoming signal is not an acceptable full range value, the operator try to correct any problems at this stage prior to pressing **ENTER** or, by pressing the **ESC** key, they can exit **SETUP/CAL** and return to perform this procedure at a later date. See Appendix D.

10.8.4. Setting a Multiplication Factor

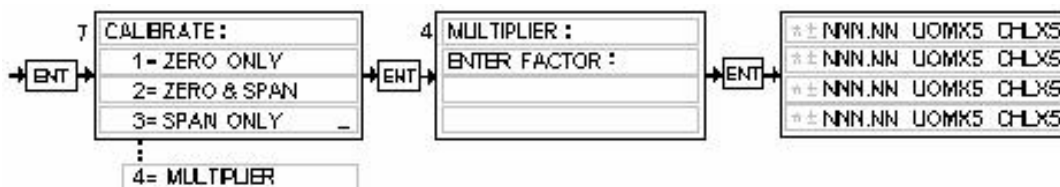

For convenience, it is possible to leave a channel setup one way and merely multiply the display value by some factor and replace the display with the new value. An example might be to set up a channel to read from zero to one hundred percent and use a multiplication factor to make the display read from zero to 500 SCCM. An infinite number of possibilities are possible.

Once a channel in the **CHANNEL SELECT** portion of the **SETUP/CAL** menu has been selected, press the number 7 key to select **CALIBRATE**. From the **CALIBRATE** menu, choose **MULTIPLIER** by pressing the number 4 key. While the **MULTIPLIER** window is in the display, enter the multiplication factor and press **ENTER**. The display returns to normal with the selected channel now displaying the product of the normally displayed value and the entered factor.

10.9. SERIAL COMMUNICATION

Follow the instructions in the section, **WIRING THE POWER^{POD}-400** for cabling and proper pin out for serial communication with the unit. After insuring that the **POWER^{POD}-400** is wired properly, the unit must be set up following the instructions in the section entitled, *External Communications Setup*.

The instruction set for the **POWER^{POD}-400** can be divided into two different types. They differ only in that they

1. Write a command only or
2. Write a command and read a response.

Taking liberty with this vernacular, they may be differentiated using the terms COMMAND or QUERY. The entire set of instructions can be found in Appendix B.

10.9.1. Commands

Typical RS-232 command structure is as follows: CMNDn<value>Cr

For example: To change channel three's high alarm value to 75.00, send A3H075.00Cr.

RS-485 commands require only that an asterisk and the unit's address precede the RS-232 Command. Using the same example as above with a unit whose address is 10 (default), send *10A3H075.00Cr.

When the **POWER^{POD}-400** is the terminating unit on a 485 bus, two jumpers, CJ1 and CJ2 can be shorted to add the required terminating resistors. Remove two machine screws from the rear of the top cover. Slide the cover off. The two jumpers are near the serial communication connectors.

10.9.2. Set Point Queries

Queries are used when information from the unit is required. Each query is followed by a response from the POWERPOD-400.

In this case, the query is asking for a programmed value. Specifically, the set point of channel three, which happens to be set at 50.00 of 100.00.

Sent	SP3Cr
Response	SP3 050.00

10.9.3. Alarm/Flag Queries

The state of the high and low flow alarms for each channel can be monitored via the DB-15 connector (J8) on the rear panel for immediate action from an alarm situation but **the Totalizer set points can only be monitored by reading a memory location's Boolean setting via serial communication.**

As shown in the section, Setting Limit Alarms, to simply QUERY channel three's high alarm set point, send A3HCr. Expect a response similar to A3H 075.00. The actual state of the alarm can be polled using the STATUS query.

STCr

Which results in a response similar to

STATUS

OCA : CH1 AUTO CH2 CLOSED CH3 OPEN CH4 AUTO

HI/LO: 0/0 0/1 1/0 0/0

OCA is short for OPEN/CLOSED/AUTO.

HI/LO stands for the high flow limit alarm or the low flow limit alarm. One must parse the states if digital tests are to be conducted.

To query the status of the totalizer flag on channel four (4), use the following command.

TF4Cr

The response will be either TF4 0 corresponding to a Boolean 'FALSE' indication that the totalizer flag has not been set, or TF4 1, a Boolean 'TRUE', indicating that the total is equal to or beyond the totalizer set point..

D41Cr command tells channel four (4) to display the TOTAL. It is not necessary that the front panel read the total for the TOTALIZER to work. The Totalizer works in the background no matter what mode the display is in.



NOTE: It must be emphasized that, if the total reaches the maximum of the display (± 999999), the unit effectively stops counting.

11.0 Appendix A

Power^{Pod}-400 Serial Commands

Command	Name	Query	Response	
	Channel 1 Display	C1	CH1 ddd.dd U of M GasID	
	Channel 2 Display	C2	CH2 ddd.dd U of M GasID	
	Channel 3 Display	C3	CH3 ddd.dd U of M GasID	
	Channel 4 Display	C4	CH4 ddd.dd U of M GasID	
	All Channels' Display	C5	CH1 ddd.dd U of M GasID CH2 ddd.dd U of M GasID CH3 ddd.dd U of M GasID CH4 ddd.dd U of M GasID	
SP1<dd.ddd>	Set Point - Channel 1	SP1	SP1 ddd.dd	notes 1, 2
SP2<dd.ddd>	Set Point - Channel 2	SP2	SP2 ddd.dd	
SP3<dd.ddd >	Set Point - Channel 3	SP3	SP3 ddd.dd	
SP4<dd.ddd >	Set Point - Channel 4	SP4	SP4 ddd.dd	
A1H<dd.ddd >	Alarm Set Point, Ch1, High	A1H	A1H ddd.dd	notes 1, 2
A1L<dd.ddd >	Alarm Set Point , Ch1, Low	A1L	A1L ddd.dd	
A2H<dd.ddd >	Alarm Set Point , Ch2, High	A2H	A2H ddd.dd	
A2L<dd.ddd >	Alarm Set Point , Ch2, Low	A2L	A2L ddd.dd	
A3H<dd.ddd >	Alarm Set Point , Ch3, High	A3H	A3H ddd.dd	
A3L<dd.ddd >	Alarm Set Point , Ch3, Low	A3L	A3L ddd.dd	
A4H<dd.ddd >	Alarm Set Point , Ch4, High	A4H	A4H ddd.dd	
A4L<dd.ddd >	Alarm Set Point , Ch4, Low	A4L	A4L ddd.dd	
HY1<ddd>	Hysteresis, Ch1	HY1	HY1 ddd	
HY2<ddd>	Hysteresis, Ch2	HY2	HY2 ddd	
HY3<ddd>	Hysteresis, Ch3	HY3	HY3 ddd	
HY4<ddd>	Hysteresis, Ch4	HY4	HY4 ddd	
UM1<dd>	Unit of Meas, Ch1	UM1	UM1 dd	
UM2<dd>	Unit of Meas, Ch2	UM2	UM2 dd	
UM3<dd>	Unit of Meas, Ch3	UM3	UM3 dd	
UM4<dd>	Unit of Meas, Ch4	UM4	UM4 dd	
GS1<ddd >	Gas ID, CH1	GS1	GS1 ddd	
GS2<ddd >	Gas ID, CH2	GS2	GS2 ddd	
GS3<ddd >	Gas ID, CH3	GS3	GS3 ddd	
GS4<ddd >	Gas ID, CH4	GS4	GS4 ddd	
IN1<d>	I/O Select, Ch1	IN1	IN1 d $\Gamma_z - \Gamma_{fs}$	notes 6, 7
IN2<d>	I/O Select, Ch2	IN2	IN2 d $\Gamma_z - \Gamma_{fs}$	
IN3<d>	I/O Select, Ch3	IN3	IN3 d $\Gamma_z - \Gamma_{fs}$	
IN4<d>	I/O Select, Ch4	IN4	IN4 d $\Gamma_z - \Gamma_{fs}$	
FL1<d>	Filter Setting, Ch1	FL1	FL1 d	
FL2<d>	Filter Setting, Ch2	FL2	FL2 d	
FL3<d>	Filter Setting, Ch3	FL3	FL3 d	
FL4<d>	Filter Setting, Ch4	FL4	FL4 d	
ML1<d.ddd>	Multiplier, CH1	ML 1	ML 1 dddd.d	notes 1, 2
ML2<dd.ddd>	Multiplier , CH2	ML 2	ML 2 ddd.dd	
ML 3<ddd.dd>	Multiplier , CH3	ML 3	ML 3 dd.ddd	
ML 4<dddd.d>	Multiplier , CH4	ML 4	ML 4 d.ddd	

APPENDIX A (Cont.)

Power^{Pod}-400 Serial Commands (Cont'd)

Command	Name	Query	Response	
D1<d >	Ch1 Disp Mode		D1 d	note 5
D2<d>	Ch2 Disp Mode		D2 d	
D3<d >	Ch3 Disp Mode		D3 d	
D4<d >	Ch4 Disp Mode		D4 d	
T1S<dddddd>	Totalizer Set Point, Ch1	T1S	T1S ddddd	
T2S<dddddd>	Totalizer Set Point, Ch2	T2S	T2S ddddd	
T3S<dddddd>	Totalizer Set Point, Ch3	T3S	T3S ddddd	
T4S<dddddd>	Totalizer Set Point, Ch4	T4S	T4S ddddd	
T1M<d>	Totalizer Mode, Ch1	T1M	T1M d	note 8
T2M<d>	Totalizer Mode, Ch2	T2M	T2M d	
T3M<d>	Totalizer Mode, Ch3	T3M	T3M d	
T4M<d>	Totalizer Mode, Ch4	T4M	T4M d	
T1R	Totalizer Reset, Ch1			note 8
T2R	Totalizer Reset, Ch2			
T3R	Totalizer Reset, Ch3			
T4R	Totalizer Reset, Ch4			
	Totalizer Flag, Ch1	TF1	TF1 d	note 9
	Totalizer Flag, Ch2	TF2	TF2 d	
	Totalizer Flag, Ch3	TF3	TF3 d	
	Totalizer Flag, Ch4	TF4	TF4 d	
SN1<d.dddd>	Cal Value, CH1	SN1	SN1 d.dddd	notes 1, 2
SN2<dd.ddd>	Cal Value, CH2	SN2	SN2 d.dddd	
SN3<ddd.dd>	Cal Value, CH3	SN3	SN3 d.dddd	
SN4<dddd.d>	Cal Value, CH4	SN4	SN4 d.dddd	
Z1	Zero Ch1			
Z2	Zero Ch2			
Z3	Zero Ch3			
Z4	Zero Ch4			
F1	Set Full Scale Value, Ch1			
F2	Set Full Scale Value, Ch2			
F3	Set Full Scale Value, Ch3			
F4	Set Full Scale Value, Ch4			
	Status, All Channels	ST	OCA: CH1 <i>text</i> CH2 <i>text</i> CH3 <i>text</i> CH4 <i>text</i> HI/LO: CH1 d/d CH2 d/d CH3 d/d CH4 d/d	Note 10
R1<d>	Ratio Mode, Ch1	R1	R1 d	note 11
R2<d>	Ratio Mode, Ch2	R2	R2 d	
R3<d>	Ratio Mode, Ch3	R3	R3 d	
R4<d>	Ratio Mode, Ch4	R4	R4 d	
BR<d>	Baud Rate	BR	BR d	note 12
RE<d>	Front Panel Lock Out	RE	REn: REMOTE/LOCAL	note 13
*00X<dd>	Multi-drop Address	*00X	MULTIDROP ADDRESS: dd	

APPENDIX A (Notes:)

1. All returned values will include decimal points wherever unit has been programmed to display them.
2. All Commands needing decimal points must include them wherever they are intended to be displayed.
3. d = decimal digit (ASCII)
4. n = Channel Number

$$5. \left\{ \begin{array}{l} Dnd : n = \text{Chnl \#} \\ d = 1, \text{ Displays Total Units (Mass)} \\ d = 2, \text{ Displays Flow Units (Rate)} \\ d = 3, \text{ Blanks selected channel} \end{array} \right\}$$

6. r_z = range, zero; r_{fs} = range, full scale

$$7. \left\{ \begin{array}{l} INnd : n = \text{Chnl \#} \\ d = 1, 0 - 5 \text{ VDC} \\ d = 2, 0 - 10 \text{ VDC} \\ d = 3, 4 - 20 \text{ mADC} \end{array} \right\}$$

$$8. \left\{ \begin{array}{l} TnMd : n = \text{Chnl \#} \\ d = 1, \text{ Totalizer Counts Up, Re sets to Zero} \\ d = 2, \text{ Totalizer Counts Down, Re sets to Set Point} \\ d = 3, \text{ Totalizer Counts Continuously, Re sets to Zero} \end{array} \right\}$$

$$9. \left\{ \begin{array}{l} TFnd : n = \text{Chnl \#} \\ d = 0, \text{ Total} < \text{Set Point} \\ d = 1, \text{ Total} \geq \text{Set Point} \end{array} \right\}$$

10. $text$ = "OPEN" or "CLOSE"
 d = 0 or 1

$$11. \left\{ \begin{array}{l} Rnd : n = \text{Chnl \#} \\ d = 1 = \text{Enabled} \\ d = 2, \text{ Disabled} \end{array} \right\}$$

$$12. \left\{ \begin{array}{l} BRd : d = 1, 9600 \\ d = 2, 19200 \end{array} \right\}$$

$$13. \left\{ \begin{array}{l} REd : d = 1, \text{ LOCAL} \\ d = 2, \text{ REMOTE} \end{array} \right\}$$

13.0 Appendix C

Units-of-Measure for Meter Reading & Corresponding Totalizer Units							
#	Name	Rate	Total	#	Name	Rate	Total
1	Standard Cubic Centimeters per Minute	SCCM	SCC	35	Standard Cubic Inches per Minute	SCIM	SCI
2	Standard Liters per Minute	SLM	SL	36	Normal Cubic Inches per Minute	NCIM	NCI
3	Percent	%		37	Standard Cubic Inches per Second	SCIS	SCI
4	Volts	V		38	Normal Cubic Inches per Second	NCIS	NCI
5	Millivolts	MV		39	Standard Cubic Inches per Hour	SCIH	SCI
6	Counts	CNT		40	Normal Cubic Inches per Hour	NCIH	NCI
7	Normal Liters per Minute	NLM	NL	41	Pounds per Minute	LBM	LB
8	Standard Liters per Second	SLS	SL	42	Pounds per Second	LBS	LB
9	Normal Liters per Second	NLS	NL	43	Pounds per Hour	LBH	LB
10	Standard Liters per Hour	SLH	SL	44	Kilograms per Minute	KgM	Kg
11	Normal liters per Hour	NLH	NL	45	Kilograms per Second	KgS	Kg
12	Standard Milliliters per Minute	SMLM	SML	46	Kilograms per Hour	KgH	Kg
13	Normal Milliliters per Minute	NMLM	NML	47	Grams per Minute	GRM	GR
14	Standard Milliliters per Second	SMLS	SML	48	Grams per Second	GMS	GR
15	Normal Milliliters per Second	NMLS	NML	49	Grams per Hour	GRH	GR
16	Standard Milliliters per Hour	SMLH	SML	50	Moles per Minute	MolM	Mol
17	Normal Milliliters per Hour	NMLH	NML	51	Moles per Second	MolS	Mol
18	Normal Cubic Centimeters per Minute	NCCM	NCC	52	Moles per Hour	MolH	Mol
19	Standard Cubic Centimeters per Second	SCCS	SCC	53	Kilomoles per Minute	KMolM	KMol
20	Normal Cubic Centimeters per Second	NCCS	NCC	54	Kilomoles per Second	KMolS	KMol
21	Standard Cubic Centimeters per Hour	SCCH	SCC	55	Kilomoles per Hour	KMolH	KMol
22	Normal Cubic Centimeters per Hour	NCCH	NCC	56	Watts	W	
23	Standard Cubic Feet per Minute	SCFM	SCF	57	Bits per Second	BPS	Bits
24	Normal Cubic Feet per Minute	NCFM	NCF	58	Seconds	Sec	
25	Standard Cubic Feet per Second	SCFS	SCF	59	Minutes	Min	
26	Normal Cubic Feet per Second	NCFS	NCF	60	Hours	Hrs	
27	Standard Cubic Feet per Hour	SCFH	SCF	61	Watt * Hours	WH	W
28	Normal Cubic Feet per Hour	NCFH	NCF	62	Torr	Torr	
29	Standard Cubic Meters per Minute	SCMM	SCM	63	Bar	Bar	
30	Normal Cubic Meters per Minute	NCMM	NCM	64	Pascals	Pa	
31	Standard Cubic Meters per Second	SCMS	SCM	65	Inches of Water	inH2O	
32	Normal Cubic Meters per Second	NCMS	NCM	66	Pounds per Square Inch, Absolute	PSIA	
33	Standard Cubic Meters per Hour	SCMH	SCM	67	Pounds per Square Inch, Gage	PSIG	
34	Normal Cubic Meters per Hour	NCMH	NCM				

Gas ID Table (Page 1 of 2)

#	GAS NAME	Symbol	#	GAS NAME	Symbol	#	GAS NAME	Symbol
1	Acetic Acid	1	46	Diethyl Ether	46	91	Hydrogen Cyanide	CHN
2	Acetic Acid, Anhydride	2	47	Diethyl Sulfide	47	92	Hydrogen Fluoride	HF
3	Acetone	C ₃ H ₆ O	48	Difluoroethylene	48	93	Hydrogen Iodide	HI
4	Acetonitril	C ₂ H ₃ N	49	Dimethylamine	C ₂ H ₇ N	94	Hydrogen Selenide	H ₂ Se
5	Acetylene	C ₂ H ₂	50	Dimethyl Ether	C ₂ H ₆ O	95	Hydrogen Sulfide	H ₂ S
6	Air	Air	51	Dimethyl Sulfide	C ₂ H ₆ S	96	Isobutane	C ₄ H ₁₀
7	Allene	C ₃ H ₄	52	Divinyl	C ₄ H ₆	97	Isobutanol	97
8	Ammonia	NH ₃	53	Ethane	C ₂ H ₆	98	Isobutene	C ₄ H ₈
9	Argon	Ar	54	Ethane, 1-chloro-1,1,2,2-tetrafluoro-	54	99	Isopentane	C ₅ H ₁₂
10	Arsine	AsH ₃	55	Ethane, 1-chloro-1,2,2,2-tetrafluoro-	55	100	Isopropyl Alcohol	C ₃ H ₈ O
11	Benzene	C ₆ H ₆	56	Ethanol	C ₂ H ₆ O	101	Isoxazole	101
12	Boron Trichloride	BCl ₃	57	Ethylacetylene	C ₄ H ₆	102	Ketene	C ₂ H ₂ O
13	Boron Triflouride	BF ₃	58	Ethyl Amine	C ₂ H ₇ N	103	Krypton	Kr
14	Bromine	Br ₂	59	Ethylbenzene	C ₈ H ₁₀	104	Methane	CH ₄
15	Bromochlorodifluoromethane	15	60	Ethyl Bromide	60	105	Methanol	CH ₄ O
16	Bromodifluoromethane	16	61	Ethyl Chloride	61	106	Methyl Acetate	106
17	Bromotrifluormethane	CBrF ₃	62	Ethyl Fluoride	C ₂ H ₅ F	107	Methyl Acetylene	C ₃ H ₄
18	Butane	C ₄ H ₁₀	63	Ethylene	C ₂ H ₄	108	Methylamine	CH ₅ N
19	Butanol	19	64	Ethylene Dibromide	64	109	Methyl Bromide	CH ₃ Br
20	Butene	C ₄ H ₈	65	Ethylene Dichloride	65	110	Methyl Chloride	CH ₃ Cl
21	Carbon Dioxide	CO ₂	66	Ethylene Oxide	C ₂ H ₄ O	111	Methylcyclohexane	C ₇ H ₁₄
22	Carbon Disulfide	CS ₂	67	Ethyleneimine	C ₂ H ₄ N	112	Methyl Ethyl Amine	C ₃ H ₉ N
23	Carbon Monoxide	CO	68	Ethylidene Dichloride	68	113	Methyl Ethyl Ether	C ₃ H ₈ O
24	Carbon Tetrachloride	CCl ₄	69	Ethyl Mercaptan	C ₂ H ₆ S	114	Methyl Ethyl Sulfide	C ₃ H ₈ S
25	Carbonyl Sulfide	COS	70	Fluorine	F ₂	115	Methyl Fluoride	CH ₃ F
26	Chlorine	Cl ₂	71	Formaldehyde	CH ₂ O	116	Methyl Formate	116
27	Chlorine Trifluoride	ClF ₃	72	Freon 11	CCl ₃ F	117	Methyl Iodide	CH ₃ I
28	Chlorobenzene	28	73	Freon 12	73	118	Methyl Mercaptan	CH ₄ S
29	Chlorodifluoroethane	29	74	Freon 13	CClF ₃	119	Methylpentene	C ₆ H ₁₂
30	Chloroform	CHCl ₃	75	Freon 14	CF ₄	120	Methyl Vinyl Ether	C ₃ H ₆ O
31	Chloropentafluoroethane	31	76	Freon 22	76	121	Neon	Ne
32	Chloropropane	32	77	Freon 23	CHF ₃	122	Nitric Oxide	NO
33	Cisbutene	C ₄ H ₈	78	Freon 114	78	123	Nitrogen	N ₂
34	Cyanogen	C ₂ N ₂	79	Furan	C ₄ H ₄ O	124	Nitrogen Dioxide	NO ₂
35	Cyanogen Chloride	ClCN	80	Helium	He	125	Nitrogen Tetroxide	N ₂ O ₄
36	Cyclobutane	C ₄ H ₈	81	Heptafluoropropane	C ₃ HF ₇	126	Nitrogen Trifluoride	NF ₃
37	Cyclopropane	C ₃ H ₆	82	HMDS	HMDS	127	Nitromethane	127
38	Deuterium	H ₂ 2	83	Hexamethyldisiloxane	83	128	Nitrosyl Chloride	NOCl
39	Diborane	B ₂ H ₆	84	Hexane	C ₆ H ₁₄	129	Nitrous Oxide	N ₂ O
40	Dibromodifluoromethane	40	85	Hexafluorobenzene	C ₆ F ₆	130	n-Pentane	C ₅ H ₁₂
41	R21	R21	86	Hexene	C ₆ H ₁₂	131	Octane	C ₈ H ₁₈
42	Dichloromethane	42	87	Hydrazine	N ₂ H ₄	132	Oxygen	O ₂
43	Dichloropropane	43	88	Hydrogen	H ₂	133	Oxygen Difluoride	F ₂ O
44	Dichlorosilane	44	89	Hydrogen Bromide	HBr	134	Ozone	O ₃
45	Diethyl Amine	45	90	Hydrogen Chloride	HCl	135	Pentaborane	B ₅ H ₉

Gas ID Table (Page 2 of 2)

GAS NAME		Symbol	GAS NAME		Symbol	GAS NAME		Symbol
136	Pentane	C ₅ H ₁₂	156	R143	R143	175	Toluene	C ₇ H ₈
137	Perchloryl Fluoride	ClFO ₃	157	R143A	R143A	176	Transbutene	C ₄ H ₈
138	Perfluorocyclobutane	C ₄ F ₈	158	R152A	R152A	177	Trichloroethane	177
139	R116	C ₂ F ₆	159	R218	C ₃ F ₈	178	Trichloroethylene	178
140	Perfluoropropane	C ₃ F ₈	160	R1416	R1416	179	R113	R113
141	Phenol	C ₆ H ₆ O	161	Radon	Rn	180	Triethylamine	180
142	Phosgene	COCl ₂	162	Sec-butanol	162	181	Trimethyl Amine	C ₃ H ₉ N
143	Phosphine	PH ₃	163	Silane	SiH ₄	182	Tungsten Hexafluoride	WF ₆
144	Phosphorus Trifluoride	PF ₃	164	Silicone Tetrafluoride	SiF ₄	183	Uranium Hexafluoride	UF ₆
145	Propane	C ₃ H ₈	165	Sulfur Dioxide	SO ₂	184	Vinyl Bromide	184
146	Propyl Alcohol	C ₃ H ₈ O	166	Sulfur Hexafluoride	SF ₆	185	Vinyl Chloride	185
147	Propyl Amine	C ₃ H ₉ N	167	Sulfur Tetrafluoride	SF ₄	186	Vinyl Flouride	C ₂ H ₃ F
148	Propylene	C ₃ H ₆	168	Sulfur Trifluoride	SF ₃	187	Water Vapor	H ₂ O
149	Pyradine	C ₅ H ₅ N	169	Sulfur Trioxide	SO ₃	188	Xenon	Xe
150	R32	CH ₂ F ₂	170	Tetrachloroethylene	170	189	Xylene, m-	C ₈ H ₁₀
151	R123	R123	171	Tetrafluoroethylene	C ₂ F ₄	190	Xylene, o-	C ₈ H ₁₀
152	R123A	R123A	172	Tetrahydrofuran	C ₄ H ₈ O	191	Xylene, p-	C ₈ H ₁₀
153	R125	C ₂ HF ₅	173	Tert-butanol	173	191	Mixtures	MIXT
154	R134	R134	174	Thiophene	C ₄ H ₄ S	193	Other	????
155	R134A	R134A				194		

14.0 Appendix D

Setting the Zero & Span on the Power^{Pod}-400 Power Supply/Totalizer

All procedures outlined in this document must be performed with the power supply turned on and warmed up for at least one hour.

All procedures outlined in this document must be performed with NO transducers connected to the channel being adjusted*.

You CANNOT successfully zero a channel without, first, supplying zero volts or four milliamps to the meter input for that channel.

You CANNOT successfully span a channel without, first, supplying the meter input for that channel with its appropriate span voltage or span current.

14.1 Zeroing Unit (Voltage Range).

The following instructions explain how to short a given channel's input signal to ground (0 volts DC) and set the display to read zero at this voltage.

Locate the 15-pin, 'D' type connector that corresponds to the channel to be zeroed.

J1 = Channel 1

J2 = Channel 2

J3 = Channel 3

J4 = Channel 4

Short pin 5 (signal common) to pin 6 (signal in).

Press **MODE**

Press **3**

Press **ENTER**

Press **1, 2, 3** or **4**, depending on which channel is to be zeroed.

Press **ENTER**

Press **7**

Press **ENTER**

Press **1**

Press **ENTER**

Press **ENTER** again

You have just told a channel to display zero when the input signal is zero volts!

14.2 Zeroing Unit (4 to 20 mA Range)

The following instructions explain how to use the POWER^{POD}-400 command signal to supply 4mA signal to a channel's input and set the display to read zero at this current level.

Disconnect all connectors from the channel to be calibrated.

Insure that the channel is set to read 4 to 20 mA signals by performing the following steps.

Press **MODE**

Press **3**

Press **ENTER**

Press **1, 2, 3** or **4**, depending on which channel is to be zeroed.

Press **ENTER**

Press **4**

Press **ENTER**

Press **3**

Press **ENTER**

The normal display returns and will respond in the 4 to 20 mA mode.

Connect a milliamp meter between pins 14 and 6 on the 15-pin 'D' connector corresponding to the channel to be calibrated.

J1 = Channel 1

J2 = Channel 2

J3 = Channel 3

J4 = Channel 4

Set the command for the selected channel to zero.

Press the **CHANNEL #** button

Press **1, 2, 3** or **4**, depending on which channel is to be zeroed.

Press **0.0** using the numbered key pad

Press **ENTER**

The milliamp meter should be reading between 3.996 and 4.004 mAmps.

To Zero the meter with a signal of 4mA, perform the following steps.

Press **MODE**

Press **3**

Press **ENTER**

Press **1, 2, 3** or **4**, depending on which channel is to be zeroed.

Press **ENTER**

Press **7**

Press **ENTER**

Press **1**

Press **ENTER**

Press **ENTER** again

You have just told a channel to display zero when the input signal is 4mA!

14.3 Spanning Unit.

The following instructions explain how to use the POWER^{POD}-400 command signal to supply a given channel's input with the proper span voltage and to set the display to read a transducer's span value.

You must know four things prior to setting the display's span value:

1. You must know the maximum signal level for the specific transducer connected to the channel to be spanned (5 VDC, 10VDC or 20mA).
2. You must know the maximum value to be displayed when the maximum signal level for the transducer is connected to the channel to be spanned.
3. You must insure that the channel's multiplier is set to 1.0000.
4. You must know the channel's 'Span Value'. That is, the value that would NOW be displayed (prior to any adjustment) if the maximum signal was fed into the input of the channel to be adjusted.

1 and 2. If this information is not on the transducer itself, consult the manufacturer of the transducer. Their literature or other documentation should specify the maximum output signal from the transducer and the maximum value to be displayed at that signal level.

3. Setting the MULTIPLIER to 1.0000.

Press **MODE**

Press **3**

Press **ENTER**

Press **1, 2, 3** or **4** depending on which channel is to be adjusted.

Press **ENTER**

Press **7**

Press **ENTER**

Press **4**

Press **ENTER**

Press **1.0000** using the numeric key pad.

Press **ENTER**

You have just set a channel's multiplier to 1.0000.

4. If you do not know what the selected channel's maximum display (Span) value is currently set to, follow these steps.

Notice that the last step in this exercise is to press ESC, not ENTER.

Press **MODE**

Press **3**

Press **ENTER**

Press **1, 2, 3** or **4** depending on which channel is to be adjusted.

Press **ENTER**

Press **7**

Press **ENTER**

Press **3**

Press **ENTER**

Read the **VALUE** from the display.

Press **ESC**

An example of one possible transducer/ **POWER^{POD}-400** combination.

TRANSDUCER		POWER ^{POD} -400	
Max signal out	Max value to be displayed	Multiplier	Current Span Value
5 VDC	250.00	1.0000	100.00

Setting the THPS-400 Analog level to correspond with the transducer to be attached.

Press **MODE**

Press **3**

Press **ENTER**

Press **1, 2, 3** or **4** depending on which channel is to be adjusted.

Press **ENTER**

Press **7**

Press **ENTER**

Press **1** for 0 – 5 VDC, **2** for 0 – 10 VDC or **3** for 4 – 20 mADC

Press **ENTER**

In the example listed above, you would have selected option number 1 for the 0 – 5 volt analog signal level since the maximum signal from the transducer is 5 VDC.

You have just set the analog operating level (range) for the selected channel.

Setting the display to read the maximum transducer value at the maximum transducer input.

Locate the 15-pin, 'D' type connector that corresponds to the channel to be spanned.

J1 = Channel 1

J2 = Channel 2

J3 = Channel 3

J4 = Channel 4

For units set to meter a voltage range, short pin 14 (command out) to pin 6 (signal in) of the selected channel and place a calibrated volt meter to read from pin 5 (common) to pin 6.

For units set to read a 4 to 20 mA range, connect a milliamp meter between pins 14 and 6.

Press the **CHANNEL #** key corresponding to the selected channel. An asterisk (*) appears.

Use the number keys to enter THPS-400 current span value. Use the decimal!

Press **ENTER**

Adjust the command to achieve a value as close to the max analog signal level as possible (± 0.01 volts for the 5 volt range, ± 0.02 volts for the 10 volt range and ± 0.004 amps for the milliamp range).

Do this using the **CHANNEL#** key, the numeric key pad and the **ENTER** key until the desired signal is established#.

Press **MODE**

Press **3**

Press **ENTER**

Press **1, 2, 3** or **4** depending on which channel is to be adjusted.

Press **ENTER**

Press **3**

Press **ENTER**

Use the numeric keys to enter the new SPAN value (Max transducer value to be displayed).

Press **ENTER**

Press **ENTER**

Congratulations!

You have just calibrated your **Power^{Pod}-400** to read zero at zero volts and the transducer's max display value at the transducer's max signal input.

The only thing left to do is to insure that your transducer is calibrated and that it is wired correctly to the **Power^{Pod}-400**.

* Individual channels may be calibrated with calibrated transducers connected, breakout connectors (not supplied) and precision multi-meters with NIST traceable calibrations (also not supplied). Such procedures are not covered in this document.

! If the calibration for the channel just zeroed had been severely compromised prior to beginning this procedure, zero may not be immediately displayed and you may have to repeat the procedure after resetting the span. Check that the span has been set correctly!

If a signal level within .1% of the maximum DC voltage level is not attainable, the power supply may need to be repaired.

15.0 Drawings

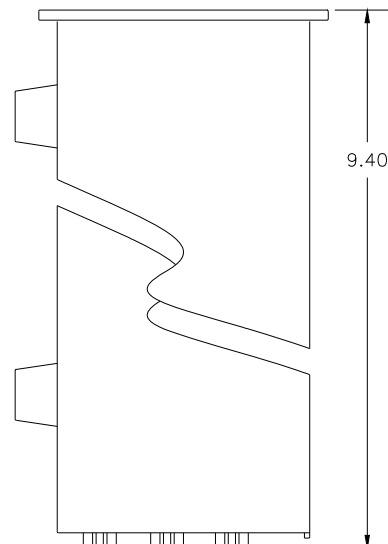
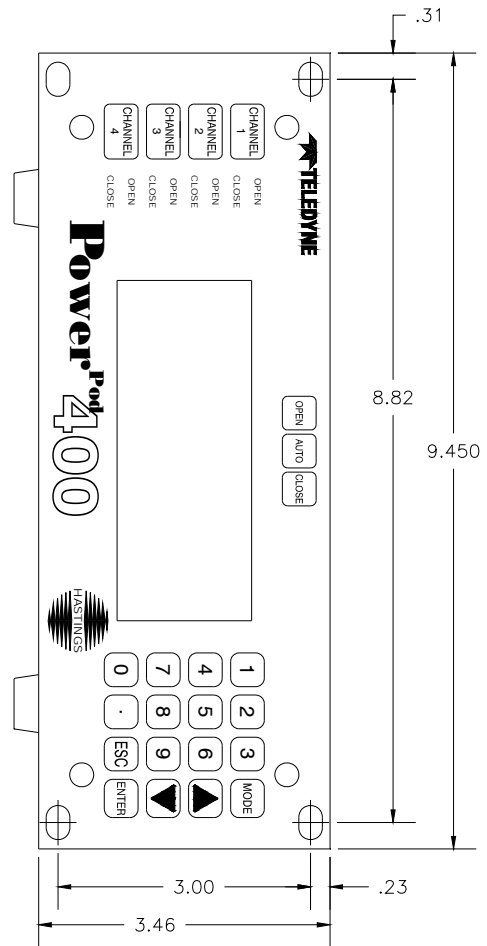
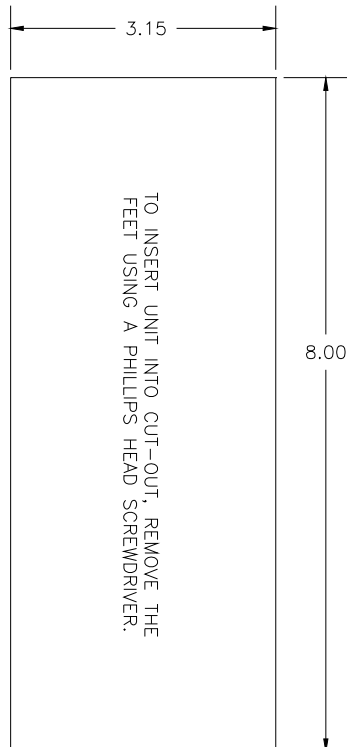
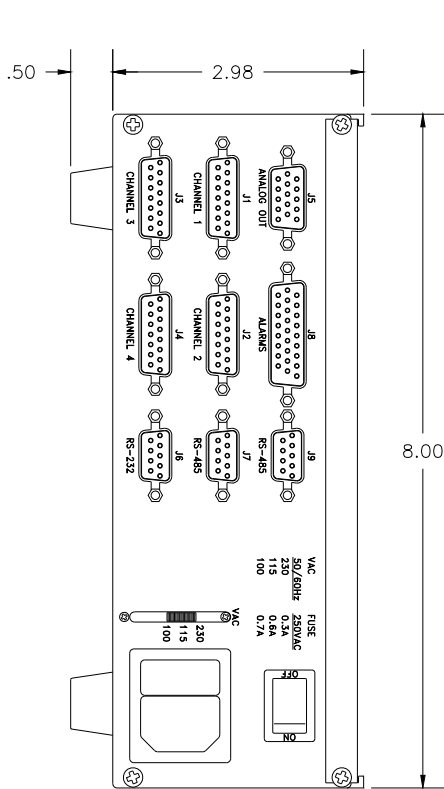

16.0 Warranty

16.1. Warranty Repair Policy

Hastings Instruments warrants this product for a period of one year from the date of shipment to be free from defects in material and workmanship. This warranty does not apply to defects or failures resulting from unauthorized modification, misuse or mishandling of the product. This warranty does not apply to batteries or other expendable parts, nor to damage caused by leaking batteries or any similar occurrence. This warranty does not apply to any instrument which has had a tamper seal removed or broken.

This warranty is in lieu of all other warranties, expressed or implied, including any implied warranty as to fitness for a particular use. Hastings Instruments shall not be liable for any indirect or consequential damages.

Hastings Instruments, will, at its option, repair, replace or refund the selling price of the product if Hastings Instruments determines, in good faith, that it is defective in materials or workmanship during the warranty period. Defective instruments should be returned to Hastings Instruments, **shipment prepaid**, together with a written statement of the problem and a Return Material Authorization (RMA) number. Please consult the factory for your RMA number before returning any product for repair. Collect freight will not be accepted.

16.2. Non-Warranty Repair Policy

Any product returned for a non-warranty repair must be accompanied by a purchase order, RMA form and a written description of the problem with the instrument. If the repair cost is higher, you will be contacted for authorization before we proceed with any repairs. If you then choose not to have the product repaired, a minimum will be charged to cover the processing and inspection. Please consult the factory for your RMA number before returning any product repair.

TELEDYNE HASTINGS INSTRUMENTS
804 NEWCOMBE AVENUE
HAMPTON, VIRGINIA 23669 U.S.A.
ATTENTION: REPAIR DEPARTMENT
TELEPHONE (757) 723-6531
1-800-950-2468
FAX (757) 723-3925
E MAIL mail to:hastings_instruments@teledyne.com
INTERNET ADDRESS <http://www.teledyne-hi.com/>

Repair Forms may be obtained from the "Information Request" section of the Hastings Instruments

Free Manuals Download Website

<http://myh66.com>

<http://usermanuals.us>

<http://www.somanuals.com>

<http://www.4manuals.cc>

<http://www.manual-lib.com>

<http://www.404manual.com>

<http://www.luxmanual.com>

<http://aubethermostatmanual.com>

Golf course search by state

<http://golfingnear.com>

Email search by domain

<http://emailbydomain.com>

Auto manuals search

<http://auto.somanuals.com>

TV manuals search

<http://tv.somanuals.com>