

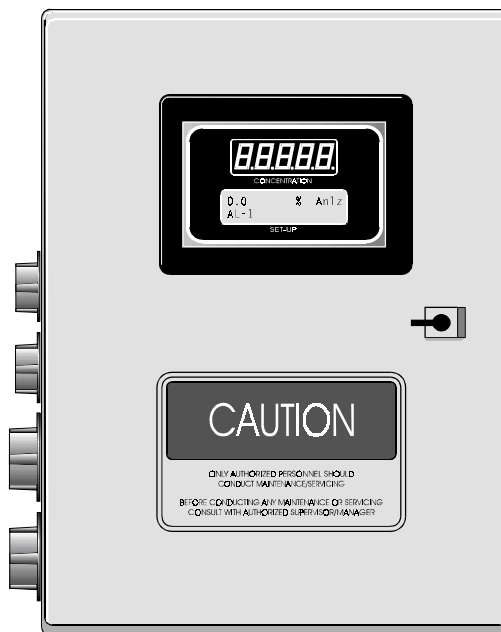

OPERATING INSTRUCTIONS

Model 3010MB

Percent Paramagnetic
Oxygen Analyzer

Bulkhead Mount Control Unit, PN D-71385
Bulkhead Mount Analysis Unit, PN D-71394



	DANGER	
<p>HIGHLY TOXIC AND OR FLAMMABLE LIQUIDS OR GASES MAY BE PRESENT IN THIS MONITORING SYSTEM.</p> <p>PERSONAL PROTECTIVE EQUIPMENT MAY BE REQUIRED WHEN SERVICING THIS SYSTEM.</p> <p>HAZARDOUS VOLTAGES EXIST ON CERTAIN COMPONENTS INTERNALLY WHICH MAY PERSIST FOR A TIME EVEN AFTER THE POWER IS TURNED OFF AND DISCONNECTED.</p> <p>ONLY AUTHORIZED PERSONNEL SHOULD CONDUCT MAINTENANCE AND/OR SERVICING. BEFORE CONDUCTING ANY MAINTENANCE OR SERVICING CONSULT WITH AUTHORIZED SUPERVISOR/MANAGER.</p>		

P/N xxxxxx
12/21/99
ECO: #99-0000

Copyright © 1999 Teledyne Analytical Instruments

All Rights Reserved. No part of this manual may be reproduced, transmitted, transcribed, stored in a retrieval system, or translated into any other language or computer language in whole or in part, in any form or by any means, whether it be electronic, mechanical, magnetic, optical, manual, or otherwise, without the prior written consent of Teledyne Analytical Instruments, 16830 Chestnut Street, City of Industry, CA 91749-1580.

Warranty

This equipment is sold subject to the mutual agreement that it is warranted by us free from defects of material and of construction, and that our liability shall be limited to replacing or repairing at our factory (without charge, except for transportation), or at customer plant at our option, any material or construction in which defects become apparent within one year from the date of shipment, except in cases where quotations or acknowledgements provide for a shorter period. Components manufactured by others bear the warranty of their manufacturer. This warranty does not cover defects caused by wear, accident, misuse, neglect or repairs other than those performed by Teledyne or an authorized service center. We assume no liability for direct or indirect damages of any kind and the purchaser by the acceptance of the equipment will assume all liability for any damage which may result from its use or misuse.

We reserve the right to employ any suitable material in the manufacture of our apparatus, and to make any alterations in the dimensions, shape or weight of any parts, in so far as such alterations do not adversely affect our warranty.

Important Notice

This instrument provides measurement readings to its user, and serves as a tool by which valuable data can be gathered. The information provided by the instrument may assist the user in eliminating potential hazards caused by his process; however, it is essential that all personnel involved in the use of the instrument or its interface, with the process being measured, be properly trained in the process itself, as well as all instrumentation related to it.

The safety of personnel is ultimately the responsibility of those who control process conditions. While this instrument may be able to provide early warning of imminent danger, it has no control over process conditions, and it can be misused. In particular, any alarm or control systems installed must be tested and understood, both as to how they operate and as to how they can be defeated. Any safeguards required such as locks, labels, or redundancy, must be provided by the user or specifically requested of Teledyne at the time the order is placed.

Therefore, the purchaser must be aware of the hazardous process conditions. The purchaser is responsible for the training of personnel, for providing hazard warning methods and instrumentation per the appropriate standards, and for ensuring that hazard warning devices and instrumentation are maintained and operated properly.

Analytical Instruments, the manufacturer of this instrument, cannot accept responsibility for conditions beyond its knowledge and control. No statement expressed or implied by this document or any information disseminated by the manufacturer or its agents, is to be construed as a warranty of adequate safety control under the user's process conditions.

Table of Contents

Specific Model Information iv

Preface v

Part I: Control Unit, Model MB Part I: 1-1

Part II: Analysis Unit, Model M Part II: 1-1

Appendix A-1

Specific Model Information

The instrument for which this manual was supplied may incorporate one or more options not supplied in the standard instrument. Commonly available options are listed below, with check boxes. Any that are incorporated in the instrument for which this manual was supplied are indicated by a check mark in the box.

Instrument Serial Number: _____

Preface

Overview

The Analytical Instruments Model 3010MB Percent Paramagnetic Oxygen Analyzer is a versatile microprocessor-based instrument for detecting parts-per-million (ppm) levels of oxygen in a variety of background gases. It is a “split architecture” instrument. This means that a general purpose Control Unit, designed for nonhazardous areas only, remotely controls a specially designed Analysis Unit, or remote probe.

Part I of this manual covers the Model 3010MB General Purpose NEMA 4 Bulkhead mount Control Unit only. This Control Unit is for outdoor/indoor use in a nonhazardous environment. The Analysis Units (or Remote Probes) it controls, can be designed for a variety of hazardous environments. Part II of this manual covers the 3010M Analysis Unit.

Typical Applications

A few typical applications of the Model 3010MB are:

- Monitoring inert gas blanketing
- Air separation and liquefaction
- Chemical reaction monitoring
- Semiconductor manufacturing
- Petrochemical process control
- Quality assurance
- Gas analysis certification.

Main Features of the Analyzer

The Model 3010MB Percent Oxygen Analyzer is sophisticated yet simple to use. The main features of the analyzer include:

- A 2-line alphanumeric display screen, driven by microprocessor electronics, that continuously prompts and informs the operator.
- High resolution, accurate readings of oxygen content from low % levels through 100%. Large, bright, meter readout.
- Stainless steel sample system.
- Versatile analysis over a wide range of applications.
- Microprocessor based electronics: 8-bit CMOS microprocessor with 32 kB RAM and 128 kB ROM.
- Three user definable output ranges (from 0-5 % through 0-100 %) allow best match to users process and equipment.
- Auto Ranging allows analyzer to automatically select the proper preset range for a given measurement. Manual override allows the user to lock onto a specific range of interest.
- Two adjustable concentration alarms and a system failure alarm.
- Extensive self-diagnostic testing, at startup and on demand, with continuous power-supply monitoring.
- RS-232 serial digital port for use with a computer or other digital communication device.
- Analog outputs for concentration and range identification. (0-1 VDC standard, and isolated 4–20 mADC)

OPERATING INSTRUCTIONS

Model 3010MB

Oxygen Analyzer

Part I: Control Unit

NEMA 4 Bulkhead Mount

Part Numbers: D-71385

Table of Contents

1 Introduction

1.1 Overview	1-1
1.2 Control Unit Inner Control Panel	1-1
1.3 Recognizing Difference Between LCD & VFD	1-3
1.4 Control Unit Interface Panel	1-4

2 Operational Theory

2.1 Introduction	2-1
2.2 Electronics and Signal Processing	2-1

3 Installation

3.1 Unpacking the Control Unit	3-1
3.2 Mounting the Control Unit	3-1
3.3 Electrical Connections	3-3
3.4 Testing the System	3-12

4 Operation

4.1 Introduction	4-1
4.2 Using the Data Entry and Function Buttons	4-2
4.3 The <i>System</i> Function	4-3
4.3.1 Tracking the O ₂ Readings during Calibration	4-4
4.3.2 Setting up an Auto-Cal	4-5
4.3.3 Password Protection	4-5
4.3.3.1 Entering the Password	4-6
4.3.3.2 Installing or Changing the Password	4-7
4.3.4 Logout	4-8
4.3.5 System Self-Diagnostic Test	4-9
4.3.6 Version Screen	4-10
4.3.7 Showing Negative Oxygen Readings	4-10
4.4 The <i>Zero</i> and <i>Span</i> Functions	4-10
4.4.1 Zero Cal	4-11

4.4.1.1	Auto Mode Zeroing	4-11
4.4.1.2	Manual Mode Zeroing	4-12
4.4.1.3	Cell Failure	4-13
4.4.2	Span Cal	4-14
4.4.2.1	Auto Mode Spanning	4-14
4.4.2.2	Manual Mode Spanning	4-16
4.4.3	Span Failure	4-16
4.5	The <i>Alarms</i> Function	4-15
4.6	The <i>Range</i> Function	4-18
4.6.1	Setting the Analog Output Ranges	4-19
4.6.2	Fixed Range Analysis	4-20
4.7	The <i>Analyze</i> Function	4-20
4.8	Signal Output	4-21

5 Maintenance

5.1	Fuse Replacement	5-1
5.2	System Self Diagnostic Test	5-2
5.3	Major Internal Components	5-3

A Appendix

	Model 3010MB Specifications	A-1
--	-----------------------------------	-----

Model 3010MB Percent Paramagnetic Oxygen Analyzer

Introduction

1.1 Overview

The Analytical Instruments Model 3010MB Analyzer Control Unit, together with a 3010M Analysis Unit, is a versatile microprocessor-based instrument for detecting percent amounts of oxygen in a variety of gases.

Part I, this part, of this manual covers the Model 3010MB series General Purpose NEMA 4 Bulkhead mount Control Units. (The Analysis Unit is covered in Part II of this manual.) The Control Unit and Analysis Unit is for indoor/outdoor use in a nonhazardous environment only.

1.2 Control Unit Inner Control Panel

The standard 3010MB Control Unit is housed in a rugged NEMA 4 metal case with all remote controls and displays accessible from the inner control panel. See Figure 1-1. The inner control panel has a digital meter, an alphanumeric display, and thirteen buttons for operating the analyzer.

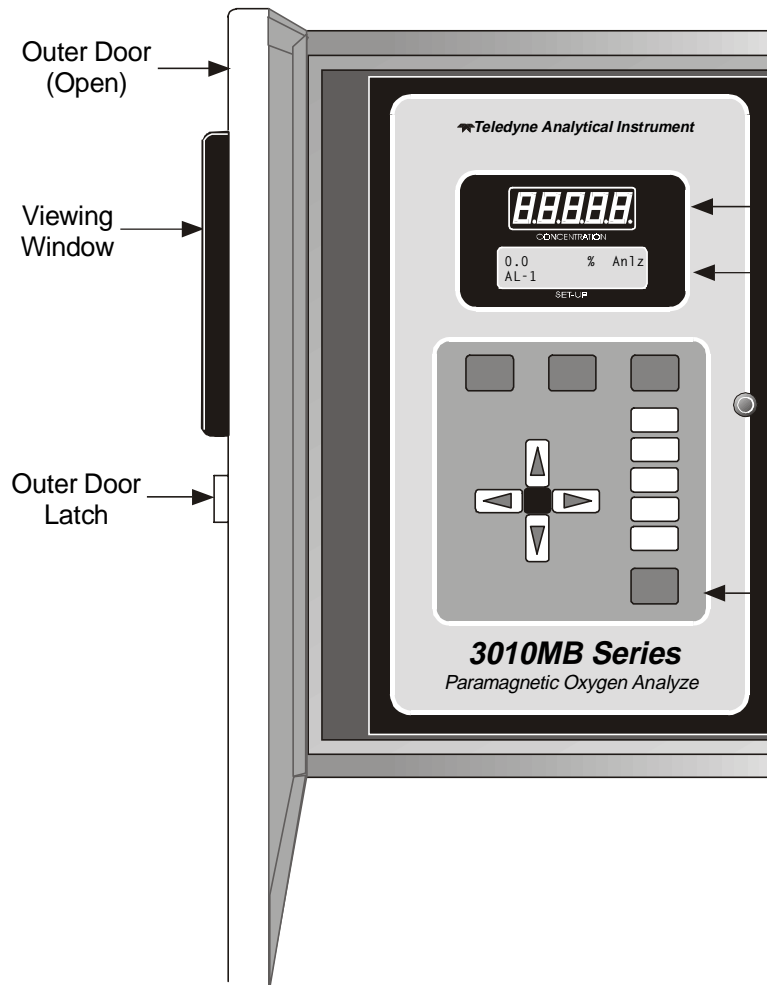

Figure 1-1: Front of Unmounted Control Unit

Function Keys: Six touch-sensitive membrane switches are used to change the specific function performed by the analyzer:

- **Analyze** Perform analysis for oxygen content of a sample gas.
- **System** Perform system-related tasks (described in detail in chapter 4, *Operation*).
- **Span** Span calibrate the analyzer.
- **Zero** Zero calibrate the analyzer.
- **Alarms** Set the alarm setpoints and attributes.
- **Range** Set up the 3 user definable ranges for the instrument.

Data Entry Keys: Six touch-sensitive membrane switches are used to input data to the instrument via the alphanumeric VFD display:

- **Left & Right Arrows** Select between functions currently displayed on the VFD screen.
- **Up & Down Arrows** Increment or decrement values of functions currently displayed.
- **Enter** Moves VFD display on to the next screen in a series. If none remains, returns to the *Analyze* screen.
- **Escape** Moves VFD display back to the previous screen in a series. If none remains, returns to the *Analyze* screen.

Digital Meter Display: The meter display is a LED device that produces large, bright, 7-segment numbers that are legible in any lighting. It is accurate across all analysis ranges. The –MB model produce continuous readout from 0-1% through 0-100%.

Alphanumeric Interface Screen: The backlit VFD screen is an easy-to-use interface between operator and analyzer. It displays values, options, and messages that give the operator immediate feedback.

I/O Power Button: The red I/O button switches the instrument power between I (ON) and O (a Keep-Alive state). In the O state, the instrument's circuitry is operating, but there are no displays or outputs.

CAUTION: *The power must be disconnected to fully disconnect power from the instrument. When chassis is exposed or when access door is open and power cable is connected, use extra care to avoid contact with live electrical circuits .*



Access Door: For access to the electronics and interface panel, the front panel swings open when the latch in the upper right corner of the panel is pressed all the way in with a narrow gauge tool. Accessing the main circuit board and other electronics requires unfastening the rear panel screws and sliding the unit out of the case.

1.3 Recognizing Difference Between LCD & VFD

LCD has *GREEN* background with *BLACK* characters. VFD has *DARK* background with *GREEN* characters. In the case of VFD - *NO CONTRAST ADJUSTMENT IS NEEDED.*

1.4 Control Unit Interface Panel

The Control Unit interface panel, shown in Figure 1-2, contains the electrical terminal blocks for external inputs and outputs. The input/output functions are described briefly here and in detail in the *Installation* chapter of this manual.

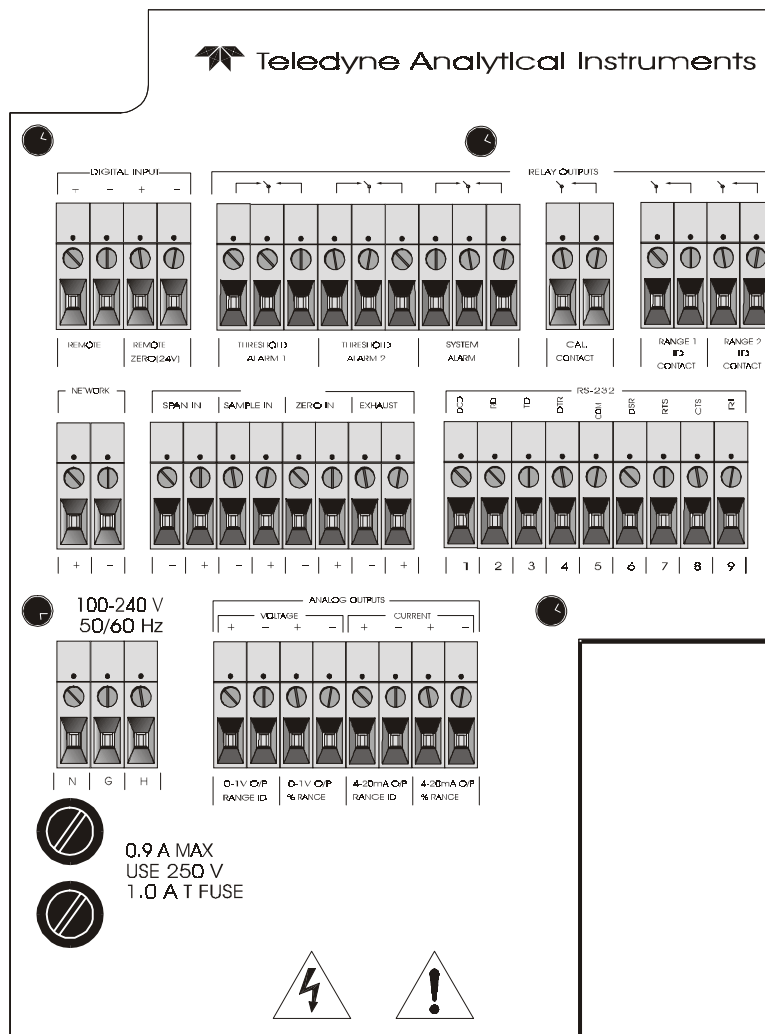

Figure 1-2: Model 3010MB Rear Panel

-
- **Power Connection** AC power source, 100-240VAC, 50/60 Hz
 - **Analog Outputs** 0-1 V dc concentration and 0-1 V dc range ID. Isolated 4-20 mA dc and 4-20 mA dc range ID.
 - **Alarm Connections** 2 concentration alarms and 1 system alarm.
 - **RS-232 Port** Serial digital concentration signal output and control input.
 - **Remote Probe** Provides all electrical interconnect to the Analysis Unit or Remote Probe.
 - **Remote Span/Zero** Digital inputs allow external control of analyzer calibration.
 - **Calibration Contact** To notify external equipment that instrument is being calibrated and readings are not monitoring sample.
 - **Range ID Contacts** Four separate, dedicated, range relay contacts. Low, Medium, High, Cal.
 - **Remote Probe** Interfaces with an Analysis Unit or Remote Probe (external sensor/sample system).
 - **Network I/O** Serial digital communications for local network access. For future expansion. Not implemented at this printing.

Note: If you require highly accurate Auto-Cal timing, use external Auto-Cal control where possible. The internal clock in the Model 3010MB is accurate to 2-3 %. Accordingly, internally scheduled calibrations can vary 2-3 % per day.

Operational Theory

2.1 Introduction

The Model 3010MB Oxygen Analyzer Control Unit uses an 80C31 microcontroller with 32 kB of RAM and 128 kB of ROM to control all signal processing, input/output, and display functions for the Model 3010MB analyzer. (The sample system and Paramagnetic sensor are covered in Part II, *Analysis Unit*, in this manual.) System power is supplied from a universal power supply module designed to be compatible with any international power source.

2.2 Electronics and Signal Processing

All of the Analyzer electronics are located on Printed Circuit Board (PCB) assemblies inside the Control Unit chassis. The PCB locations are illustrated in section 5, *Maintenance*.

Refer to Figure 2-1, *Block Diagram of the 3010MB CU Electronics*:

In the presence of oxygen, the sensor (in the Analysis Unit) generates a current. A current to voltage amplifier (in the Control Unit) converts this current to a voltage.

The second stage amplifier amplifies the voltage. The output from the second stage amplifier is sent to an 18-bit analog to digital converter controlled by the microprocessor.

The digital concentration signal—along with input from the control panel—is processed by the microprocessor, and appropriate control signals are directed to the display, alarms and communications port as well as to the gas control valves in the Analysis Unit.

The same digital information is also sent to a 12 bit digital to analog converter that produces the 4-20 mA dc and the 0-1 V dc analog concentration signal outputs, and the analog range ID outputs.

The microprocessor monitors the power supply, and activates the system failure alarm if a malfunction is detected.

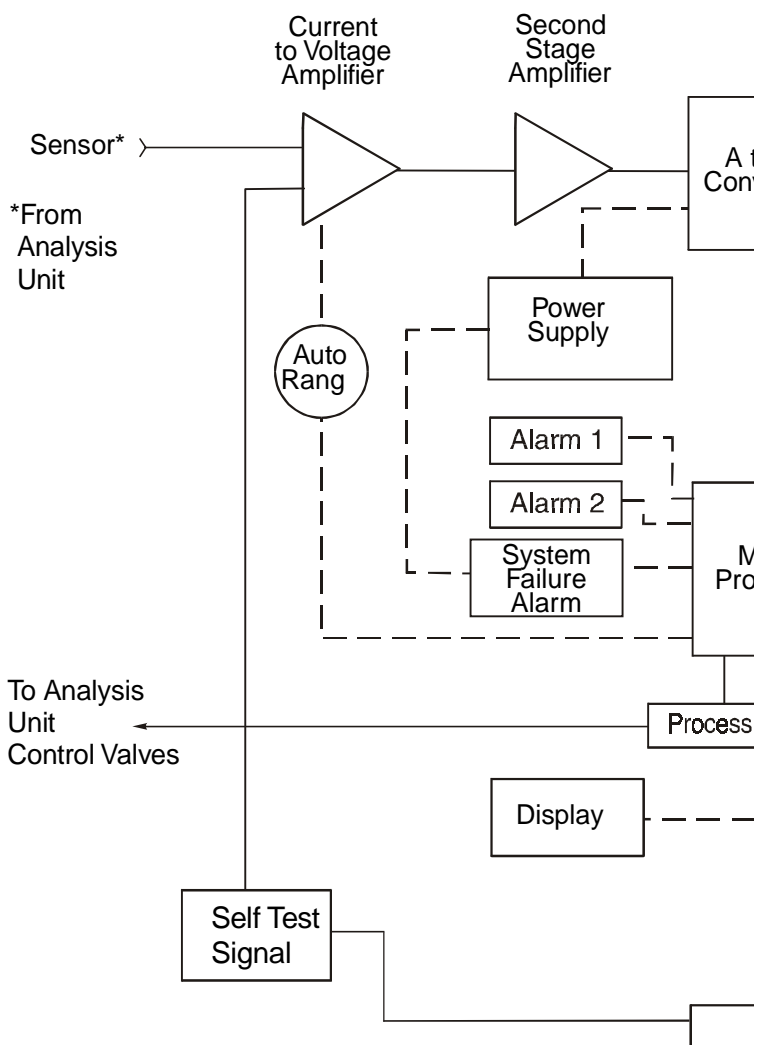

Figure 2-1: Block Diagram of the 3010TB CU Electronics

Installation

Installation of Model 3010MB Analyzers includes:

1. Unpacking, mounting, and interconnecting the Control Unit and the Analysis Unit
2. Making gas connections to the system
3. Making electrical connections to the system
4. Testing the system.

This chapter covers installation of the Control Unit. (Installation of the Analysis Unit is covered in Part II of this manual.)

3.1 Unpacking the Control Unit

The analyzer is shipped with all the materials you need to install and prepare the system for operation. Carefully unpack the Control Unit and inspect it for damage. Immediately report any damage to the shipping agent.

3.2 Mounting the Control Unit

The Model 3010MB Control Unit is for indoor/outdoor use in a general purpose area. This Unit is NOT for any type of hazardous environments.

The standard model is designed for indoor/outdoor mounting. Figure 3-1 is an illustration of a Model 3010MB standard Control Unit front panel and mounting brackets located-two at the top and two at the bottom of the units frame.

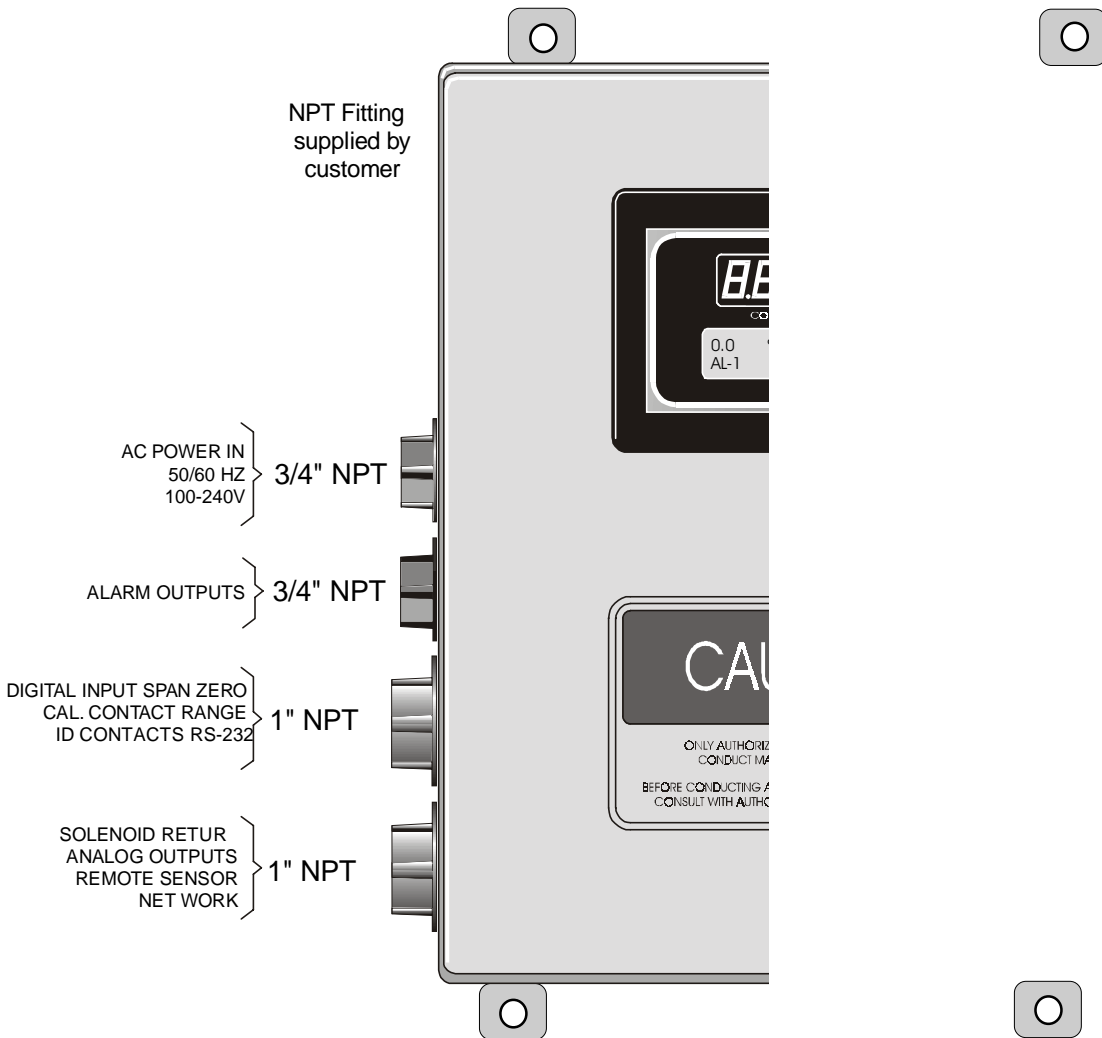

Figure 3-1: Front Panel of the Model 3010MB Control Unit

All operator controls are mounted on the inner control panel, which is hinged on the left edge and doubles as a door to provide access to the internal components of the instrument. The door will swing open when the button of the latch is pressed all the way in with a narrow gauge tool (less than 0.18 inch wide), such as a small hex wrench or screwdriver. Allow

clearance for the door to open in a 90-degree arc of radius 11.75 inches. See Figure 3-2.

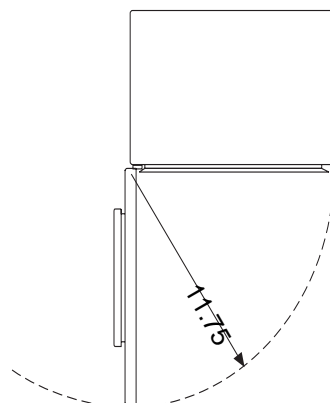

Figure 3-2: Required Front Door Clearance

3.3 Electrical Connections

Figure 3-3 shows the Control Unit interface panel. Connections for power, communications, and both digital and analog signal outputs are described in the following paragraphs. Wire size and maximum length data appear in the Drawings at the back of this manual.

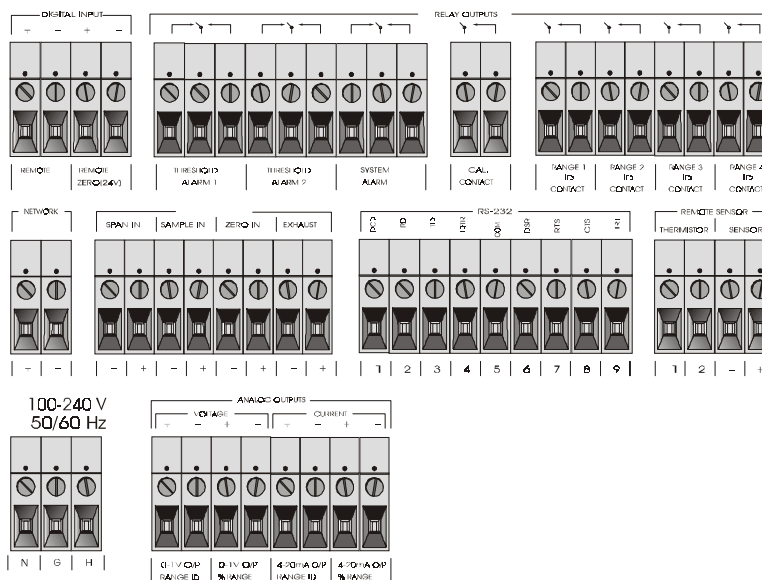

Figure 3-3: Interface Panel of the Model 3010MB Control Unit

For safe connections, ensure that no uninsulated wire extends outside of the terminal blocks that are attached to. Stripped wire ends must insert completely into terminal blocks. No uninsulated wiring should be able to come in contact with fingers, tools or clothing during normal operation.

Primary Input Power: The universal power supply requires a 100-240V ac, 50/60 Hz power source. See Figure 3-4 for detailed connections.

DANGER: *Power is applied to the instrument's circuitry as long as the instrument is connected to the power source. The standby function switches power on or off to the displays and outputs only.*

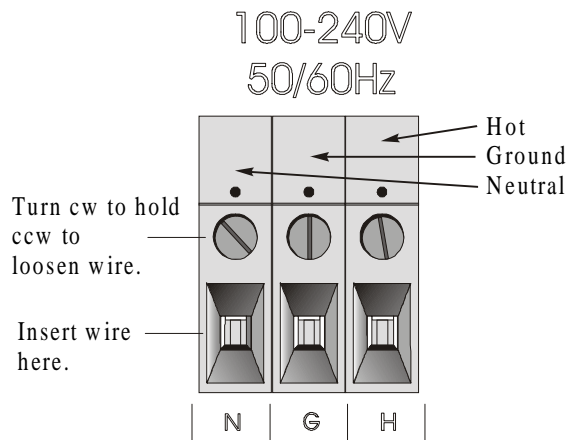

Figure 3-4: Primary Input Power Connections

Fuse Installation: The fuse holders accept 5 x 20 mm, 1.0 A, T type (slow blow) fuses. Fuses are not installed at the factory. Be sure to install the proper fuse as part of installation (See *Fuse Replacement* in chapter 5, *maintenance*.)

Analog Outputs: There are eight DC output signal connectors on the ANALOG OUTPUTS terminal block. There are two connectors per output with the polarity noted. See Figure 3-5.

The outputs are:

- 0-1 V dc % of Range: Voltage rises linearly with increasing oxygen, from 0 V at 0% to 1 V at 100%. (Full scale = 100% programmed range.)
- 0-1 V dc Range ID: 0.25 V = Low Range, 0.5 V = Medium Range, 0.75 V = High Range, 1 V = Air Cal Range.

- 4–20 mA dc % Range: (-M Option) Current increases linearly with increasing oxygen, from 4 mA at 0% to 20 mA at full scale 100%. (Full scale = 100% of programmed range.)
- 4–20 mA dc Range ID: (-M Option) 8 mA = Low Range, 12 mA = Medium Range, 16 mA = High Range, 20 mA = Air Cal Range.

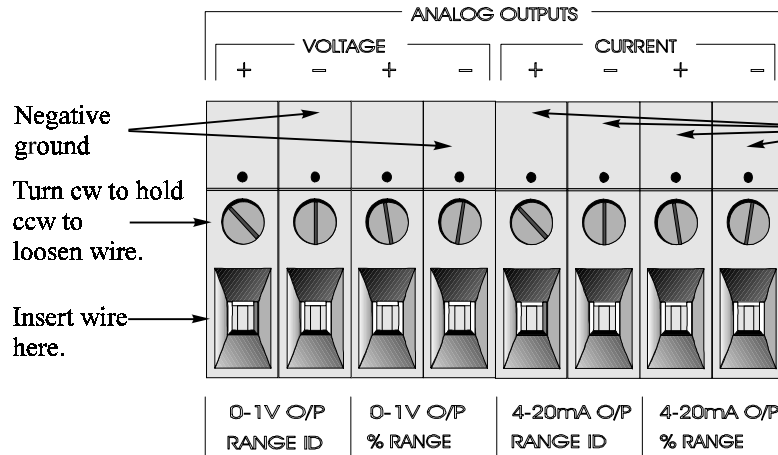

Figure 3-5: Analog Output Connections

Examples:

The analog output signal has a voltage which depends on the oxygen concentration AND the currently activated analysis range. To relate the signal output to the actual concentration, it is necessary to know what range the instrument is currently on, especially when the analyzer is in the autoranging mode.

The signal output for concentration is linear over currently selected analysis range. For example, if the analyzer is set on a range that was defined as)-10 % O₂, then the output would be as shown in Table 3-1.

Table 3-1: Analog Concentration Output-Examples

%O2	Voltage Signal Output (V dc)	Current Signal Output (mA dc)
0	0.0	4.0
1	0.1	5.6
2	0.2	7.2
3	0.3	8.8
4	0.4	10.4
5	0.5	12.0
6	0.6	13.6
7	0.7	15.2
8	0.8	16.8
9	0.9	18.4
10	1.0	20.0

To provide an indication of the range, a second pair of analog output terminals are used. They generate a steady preset voltage (or current when using the current outputs) to represent a particular range. Table 3-2 gives the range ID output for each analysis range.

Table 3-2: Analog Range ID Output - Example

Range	Voltage (V)	Current (mA)
LO	0.25	8
MED	0.50	12
HI	0.75	16
CAL (0-25%)	1.00	20

Alarm Relays:

There are three alarm-circuit connectors on the alarm relays block (under RELAY OUTPUTS) for making connections to internal alarm relay contacts. Each provides a set of Form C contacts for each type of alarm. Each has both normally open and normally closed contact connections. The contact connections are indicated by diagrams on the rear panel. They are capable of switching up to 3 amperes at 250 V AC into a resistive load (Figure 3-6).

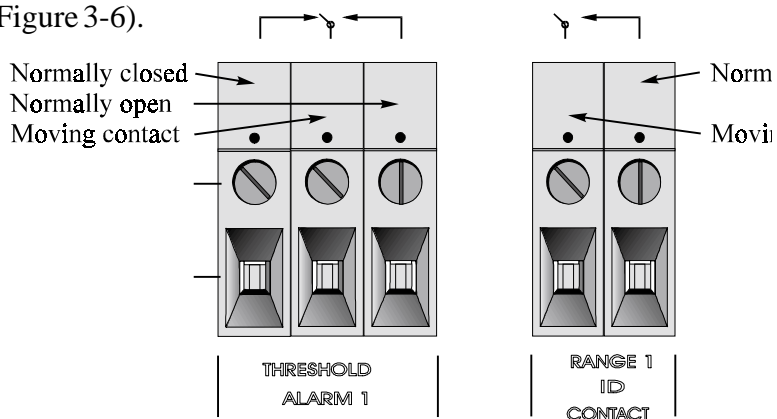

Figure 3-5: Types of Relay Contacts

The connectors are:

- Threshold Alarm 1:
- Can be configured as high (actuates when concentration is above threshold), or low (actuates when concentration is below threshold).
 - Can be configured as fail-safe or non-fail-safe.
 - Can be configured as latching or nonlatching.
 - Can be configured out (defeated).
- Threshold Alarm 2:
- Can be configured as high (actuates when concentration is above threshold), or low (actuates when concentration is below threshold).
 - Can be configured as fail-safe or non-fail-safe.
 - Can be configured as latching or nonlatching.
 - Can be configured out (defeated).
- System Alarm:
- Actuates when DC power supplied to circuits is unacceptable in one or more parameters. Permanently configured as fail-safe and latching. Cannot be defeated. Actuates if self test fails.
- To reset a System Alarm during installation, disconnect power to the instrument and then reconnect it
- Further detail can be found in chapter 4, section 4-5.

Digital Remote Cal Inputs

Remote Zero and Span Inputs: The REMOTE SPAN and REMOTE ZERO inputs are on the DIGITAL INPUT terminal block. They accept 0 V (OFF) or 24 V dc (ON) for remote control of calibration (See *Remote Calibration Protocol* below.)

- Zero: Floating input. 5 to 24 V input across the + and – terminals puts the analyzer into the **ZERO** mode. Either side may be grounded at the source of the signal. 0 to 1 volt across the terminals allows **ZERO** mode to terminate when done. A synchronous signal must open and close the external zero valve appropriately. See *Remote Probe Connector* at end of section 3.3. (With the -C option, the internal valves automatically operate synchronously.)
- Span: Floating input. 5 to 24 V input across the + and – terminals puts the analyzer into the **SPAN** mode. Either side may be grounded at the source of the signal. 0 to 1 volt across the terminals allows **SPAN** mode to terminate when done. A synchronous signal must open and close the external span valve appropriately. See *Remote Probe Connector* at end of section 3.3. (With the -C option, the internal valves automatically operate synchronously.)

Cal Contact: This relay contact is closed while analyzer is spanning and/or zeroing. (See *Remote Calibration Protocol* below.)

Remote Calibration Protocol: To properly time the Digital Remote Cal Inputs to the Model 3010MB Analyzer, the customer's controller must monitor the Cal Relay Contact.

When the contact is OPEN, the analyzer is analyzing, the Remote Cal Inputs are being polled, and a zero or span command can be sent.

When the contact is CLOSED, the analyzer is already calibrating. It will ignore your request to calibrate, and it will not remember that request.

Once a zero or span command is sent, and acknowledged (contact closes), release it. If the command is continued until after the zero or span is complete, the calibration will repeat and the Cal Relay Contact (CRC) will close again.

For example:

- 1) Test the CRC. When the CRC is open, Send a zero command until the CRC closes (The CRC will quickly close.)
- 2) When the CRC closes, remove the zero command.
- 3) When CRC opens again, send a span command until the CRC closes. (The CRC will quickly close.)

- 4) When the CRC closes, remove the span command.

When CRC opens again, zero and span are done, and the sample is being analyzed.

Note: The Remote Probe connector (paragraph 3.3) provides signals to ensure that the zero and span gas valves will be controlled synchronously. If you have the -C Internal valve option - which includes additional zero and span gas inputs - the 3010MB automatically regulates the zero, span and sample gas flow.

Range ID Relays: Four dedicated RANGE ID CONTACT relays . The first three ranges are assigned to relays in ascending order—Low range is assigned to RANGE 1 ID, Medium range is assigned to RANGE 2 ID, and High range is assigned to RANGE 3 ID. RANGE 4 ID is reserved for the Air Cal Range (25%).

Network I/O: A serial digital input/output for local network protocol. At this printing, this port is not yet functional. It is to be used in future versions of the instrument.

RS-232 Port: The digital signal output is a standard RS-232 serial communications port used to connect the analyzer to a computer, terminal, or other digital device. The pinouts are listed in Table 3-3.

Table 3-3: RS-232 Signals

RS-232 Sig	RS-232 Pin	Purpose
DCD	1	Data Carrier Detect
RD	2	Received Data
TD	3	Transmitted Data
DTR	4	Data Terminal Ready
COM	5	Common
DSR	6	Data Set Ready
RTS	7	Request to Send
CTS	8	Clear to Send
RI	9	Ring Indicator

The data sent is status information, in digital form, updated every two seconds. Status is reported in the following order:

- The concentration in percent
- The range is use (HI< MED< LO)
- The span of the range 0-100%, etc)
- Which alarm - if any - are disabled (AL-x DISABLED)
- Which alarms - if any - are tripped (AL-x ON)

Each status output is followed by a carriage return and line feed.

Three input functions using RS-232 have been implemented to date. They are described in Table 3-4.

Table 3-4: Commands via RS-232 Input

Command	Description
as <enter>	Immediately starts an autospan.
az <enter>	Immediately starts an autozero.
st <enter>	Toggling input. Stops/Starts any status message output from the RS-232, Until st <enter> is sent again.

The RS-232 protocol allows some flexibility in its implementation. Table 3-5 lists certain RS-232 values that are required by the 3010MB.

Table 3-5: Required RS-232 Options

Parameter	Setting
Baud	2400
Byte	8 bits
Parity	none
Stop Bits	1
Message Interval	2 seconds

Remote Sensor and Solenoid Valves: The 3010MB is a single-chassis instrument. However, the REMOTE SENSOR and SOLENOID RETURN connectors are provided for use with a remote sensor and/or sampling system, if desired. See Figure 3-7 and 3-8.

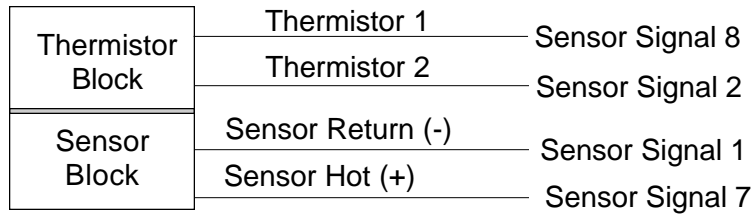

Figure 3-7 Remote Sensor Connector Pinouts

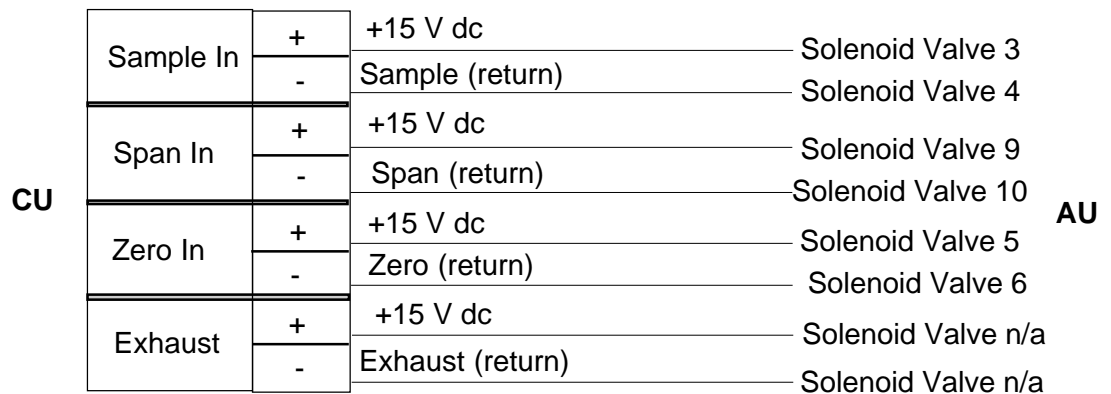

Figure 3-8: Remote Solenoid Return Connector Pinouts

The voltage from the solenoid outputs is nominally 0 V for the OFF and 15 V dc for the ON conditions. The maximum combined current that can be pulled from these output lines is 100 mA. (If two lines are ON at the same time, each must be limited to 50 mA, etc.) If more current and/or a different voltage is required, use relays, power amplifiers, or other matching circuitry to provide the actual driving current.

Note that each individual line has a series FET with a nominal ON resistance of 5 ohms (9 ohms worst case). This can limit the obtainable voltage, depending on the load impedance applied. See Figure 3-9.

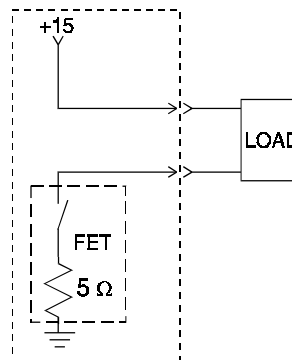

Figure 3-9: FET Series Resistance

3.4 Testing the System

After The Control Unit and the Analysis Unit are **both** installed and interconnected, and the system gas and electrical connections are complete, the system is ready to test. **Before** plugging either of the units into their respective power sources:

- Check the integrity and accuracy of the gas connections. Make sure there are no leaks.
- Check the integrity and accuracy of all electrical connections. Make sure there are no exposed conductors
- Check that sample pressure is between 3 and 40 psig, according to the requirements of your process.

Power up the system, and test it by performing the following operations:

1. Repeat the Self-Diagnostic Test as described in chapter 4, section 4.3.5.

Operation

4.1 Introduction

Once the analyzer has been installed, configure it for your process. To do this you can:

- Set system parameters—
 - Specify a password, if desired, requiring operator to log in.
 - Establish and start an automatic calibration cycle, if desired.
- Calibrate the instrument.
- Define the three user selectable analysis ranges. Then choose autoranging or select a fixed range of analysis, as required.
- Set alarm setpoints, and modes (latching, failsafe, etc).

Before configuration these default values are in effect:

PARAMETER	DEFAULT
LO Range	100 %
MED Range	1000 %
HI Range	10,000 %
Auto Ranging	ON
Alarm Relays	1000 % (Defeated, HI, Not failsafe, Not latching)
Span	000008.00 % (Auto, every 0 days at 0 hours)
Zero	(Auto, every 0 days at 0 hours).

If you choose not to use password protection, the default password is automatically displayed on the password screen when you start up, and you simply press *Enter* for access to all functions of the analyzer.

4.2 Using the Data Entry and Function Buttons

Data Entry Buttons: The < > arrow buttons select options from the menu currently being displayed on the VFD screen. The selected option blinks.

When the selected option includes a modifiable item, the $\Delta\nabla$ arrow buttons can be used to increment or decrement that modifiable item.

The *Enter* button is used to accept any new entries on the VFD screen. The *Escape* button is used to abort any new entries on the VFD screen that are not yet accepted by use of the *Enter* button.

Figure 4-1 shows the hierarchy of functions available to the operator via the function buttons. The six function buttons on the analyzer are:

- *Analyze*. This is the normal operating mode. The analyzer monitors the oxygen content of the sample, displays the concentration of oxygen, and warns of any alarm conditions.
- *System*. The system function consists of six subfunctions that regulate the internal operations of the analyzer:
 - Auto-Cal setup
 - Password assignment
 - Self-Test initiation
 - Checking software version
 - Logging out.
- *Zero*. Used to set up a zero calibration.
- *Span*. Used to set up a span calibration.
- *Alarms*. Used to set the alarm setpoints and determine whether each alarm will be active or defeated, HI or LO acting, latching, and/or failsafe.
- *Range*. Used to set up three analysis ranges that can be switched automatically with autoranging or used as individual fixed ranges.

Any function can be selected at any time by pressing the appropriate button (unless password restrictions apply). The order as presented in this manual is appropriate for an initial setup.

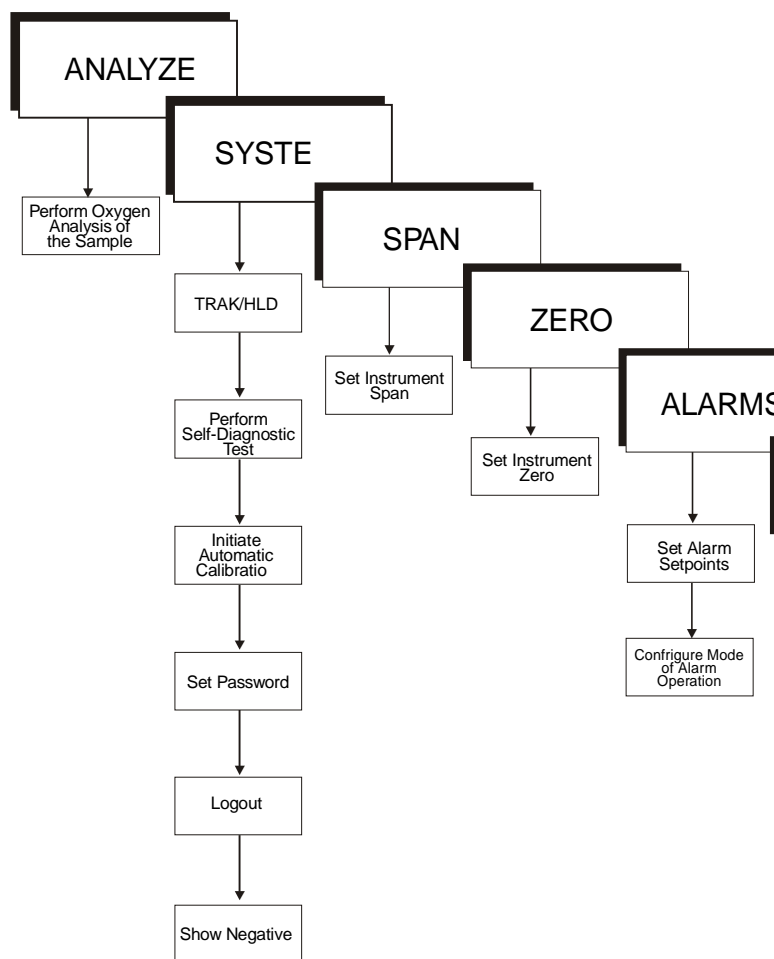

Figure 4-1: Hierarchy of Functions and Subfunctions

Each of these functions is described in greater detail in the following procedures. The VFD screen text that accompanies each operation is reproduced, at the appropriate point in the procedure, in a *Monospaced* type style. Pushbutton names are printed in *Oblique* type.

4.3 The System Function

The subfunctions of the *System* function are described below. Specific procedures for their use follow the descriptions:

- **Auto-Cal:** Used to define an automatic calibration sequence and/or start an Auto-Cal.
- **PSWD:** Security can be established by choosing a 5 digit password (PSWD) from the standard ASCII character set. (See *Installing or Changing a Password*, below, for a table of ASCII characters available.) Once a unique password is assigned and

activated, the operator **MUST** enter the **UNIQUE** password to gain access to set-up functions which alter the instrument's operation, such as setting the instrument span or zero setting, adjusting the alarm setpoints, or defining analysis ranges.

After a password is assigned, the operator must **log out** to activate it. Until then, anyone can continue to operate the instrument without entering the new password.

Only one password can be defined. Before a unique password is assigned, the system assigns **TETAI** by default. This allows access to anyone. After a unique password is assigned, to defeat the security, the password must be changed back to **TETAI**.

- **Logout:** Logging out prevents an unauthorized tampering with analyzer settings.
- **More:** Select and enter **More** to get a new screen with additional subfunctions listed.
- **Self-Test:** The instrument performs a self-diagnostic test to check the integrity of the power supply, output boards and amplifiers.
- **Version:** Displays Manufacturer, Model, and Software Version of instrument.
- **Showing Negative:** The operator selects whether display can show negative readings or not.
- **TRAK/HLD:** The operator sets whether the instrument analog outputs track the concentration change during calibration and sets a time delay for the concentration alarms after calibration

4.3.1 Tracking the Oxygen Readings during Calibration and Alarm delay

The user has the option of setting the preference as to whether the analog outputs track the display readings during calibration or not. To set the preference, press the System key once and the first System menu will appear in the VFD display:

```
TRAK/HLD Auto-Cal  
PSWD Logout More
```

TRAK/HLD should be blinking. To enter this system menu press the Enter key once:

```
Output Sttng: TRACK  
Alarm Dly: 10 min
```

Or

Output Sttng: HOLD

Alarm Dly: 10 min

In the first line, TRACK or HOLD should be blinking. The operator can toggle between TRACK and HOLD with the Up or Down keys. When TRACK is selected, the analog outputs (0-1 VDC and 4-20 ma) and the range ID contacts will track the instrument readings during calibration (either zero or span). TRACK is the factory default.

When HOLD is selected, the analog outputs (0-1 VDC and 4-20 ma) and the range ID contacts will freeze on their last state before entering one of the calibration modes. When the instrument returns to the Analyze mode, either by a successful or an aborted calibration, there will be a three-minute delay before the analog outputs and the range ID contacts start tracking again.

The concentration alarms freeze on their last state before entering calibration regardless of selecting HOLD or TRACK. But, when HOLD is selected the concentration alarms will remain frozen for the time displayed in the second line of the TRAK/HLD menu after the analyzer returns to the Analyze mode.

The factory default is three minutes, but the delay time is programmable. To adjust to delay time use the Left or Right arrow keys. When the time displayed on the second line blinks, it can be adjusted by Pressing the Up or Down keys to increase or decrease its value. The minimum delay is 1 minute, the maximum is 30.

This preference is stored in non-volatile memory so that it is recovered if power is removed from the instrument.

4.3.2 Setting up an Auto-Cal

When the proper calibration gases are connected (see chapter 3, *installation*), the Analyzer can cycle itself through a sequence of steps that automatically zero and span the instrument.

Note: If you require highly accurate Auto-Cal timing, use external Auto-Cal control where possible. The internal clock in the Model 3010MB is accurate to 2-3 %. Accordingly, internally scheduled calibrations can vary 2-3 % per day.

To setup an Auto-Cal cycle:

Choose *System* from the Function buttons. The VFD will display five subfunctions.

```
TRAK/HLD Auto-Cal
PSWD Logout More
```

Use <> arrows to blink *Auto-Cal*, and press **Enter**. A new screen for **Span/Zero** set appears.

```
Span OFF Nxt: 0d 0h
Zero OFF Nxt: 0d 0h
```

Press <> arrows to blink *Span* (or *Zero*), then press **Enter** again. (You won't be able to set **OFF** to **ON** if a zero interval is entered.) A **Span Every ...** (or **Zero Every ...**) screen appears.

```
Span Every 0 d
Start 0 h from now
```

Use $\Delta\nabla$ arrows to set an interval value, then use <> arrows to move to the start-time value. Use $\Delta\nabla$ arrows to set a start-time value.

To turn **ON** the **Span** and/or **Zero** cycles (to activate **Auto-Cal**): Press **System** again, choose *Auto-Cal*, and press **Enter** again. When the **Span/Zero** values screen appears, use the <> arrows to blink the **Span** (or **Zero**) *OFF/ON* field. Use $\Delta\nabla$ arrows to set the *OFF/ON* field to **ON**. You can now turn these fields **ON** because there is a nonzero span interval defined.

4.3.3 Password Protection

If a password is assigned, then setting the following system parameters can be done only after the password is entered: **span** and **zero** settings, **alarm** setpoints, analysis **range** definitions, switching between **autoranging** and manual override, setting up an **auto-cal**, and assigning a new **password**. However, the instrument can still be used for analysis or for initiating a self-test without entering the password.

If you have decided not to employ password security, use the default password **TETAI**. This password will be displayed automatically by the microprocessor. The operator just presses the Enter key to be allowed total access to the instrument's features.

NOTE: If you use password security, it is advisable to keep a copy of the password in a separate, safe location.

4.3.3.1 Entering the Password

To install a new password or change a previously installed password, you must key in and **ENTER** the old password first. If the default password

is in effect, pressing the *ENTER* button will enter the default **TETAI** password for you.

Press *System* to enter the *System* mode.

```
TRAK/HLD Auto-Cal
PSWD Logout More
```

Use the < > arrow keys to scroll the blinking over to *PSWD*, and press *Enter* to select the password function. Either the default **TBEAI** password or **AAAAA** place holders for an existing password will appear on screen depending on whether or not a password has been previously installed.

```
T E T A I
Enter PWD
```

or

```
A A A A A
Enter PWD
```

The screen prompts you to enter the current password. If you are not using password protection, press *Enter* to accept **TETAI** as the default password. If a password has been previously installed, enter the password using the < > arrow keys to scroll back and forth between letters, and the Δ ∇ arrow keys to change the letters to the proper password. Press *Enter* to enter the password.

If the password is accepted, the screen will indicate that the password restrictions have been removed and you have clearance to proceed.

```
PSWD Restrictions
Removed
```

In a few seconds, you will be given the opportunity to change this password or keep it and go on.

```
Change Password?
<ENT>=Yes <ESC>=No
```

Press *Escape* to move on, or proceed as in *Changing the Password*, below.

4.3.3.2 Installing or Changing the Password

If you want to install a password, or change an existing password, proceed as above in *Entering the Password*. When you are given the opportunity to change the password:

```
Change Password?
<ENT>=Yes <ESC>=No
```

Press *Enter* to change the password (either the default **TETAI** or the previously assigned password), or press *Escape* to keep the existing password and move on.

If you chose *Enter* to change the password, the password assignment screen appears.

T E T A I
<ENT> To Proceed

or

A A A A A
<ENT> To Proceed

Enter the password using the < > arrow keys to move back and forth between the existing password letters, and the $\Delta\nabla$ arrow keys to change the letters to the new password. The full set of 94 characters available for password use are shown in the table below.

Characters Available for Password Definition:

A	B	C	D	E	F	G	H	I	J
K	L	M	N	O	P	Q	R	S	T
U	V	W	X	Y	Z	[¥]	^
_	`	a	b	c	d	e	f	g	h
i	j	k	l	m	n	o	p	q	r
s	t	u	v	w	x	y	z	{	
}	→	!	"	#	\$	%	&	'	(
)	*	+	,	-	.	/	0	1	2
3	4	5	6	7	8	9	:	;	<
=	>	?	@						

When you have finished typing the new password, press *Enter*. A verification screen appears. The screen will prompt you to retype your password for verification.

A A A A A
Retype PWD To Verify

Wait a moment. The entry screen will give you clearance to proceed.

A A A A A
<ENT> TO Proceed

Use the arrow keys to retype your password and press *Enter* when finished. Your password will be stored in the microprocessor and the system will immediately switch to the *Analyze* screen, and you now have access to all instrument functions.

If no alarms are tripped, the *Analyze* screen appears as:

```
0.0      ppm   AnlZ
Range: 0 - 100
```

If an alarm is tripped, the second line will change to show which alarm it is:

```
0.0      ppm   AnlZ
AL-1
```

NOTE: If you previously logged off the system, you will now be required to re-enter the password to gain access to Span, Zero, Alarm, and Range functions.

4.3.4 Logout

The **Logout** function provides a convenient means of leaving the analyzer in a password protected mode without having to shut the instrument off. By entering **Logout**, you effectively log off the instrument leaving the system protected against use until the password is reentered. To log out, press the *System* button to enter the *System* function.

```
TRAK/HLD Auto-Cal
PSWD Logout More
```

Use the <> arrow keys to position the blinking over the **Logout** function, and press *Enter* to Log out. The screen will display the message:

```
Protected Until
Password Reentered
```

4.3.5 System Self-Diagnostic Test

The Model 3010MB has a built-in self-diagnostic testing routine. Pre-programmed signals are sent through the power supply, output board and sensor circuit. The return signal is analyzed, and at the end of the test the status of each function is displayed on the screen, either as **OK** or as a number between 1 and 3. (See *System Self Diagnostic Test* in chapter 5 for number code.)

Note: Remote Probe connector must be connected to the Analysis Unit, or sensor circuit will not be properly checked.

The self diagnostics are run automatically by the analyzer whenever the instrument is turned on, but the test can also be run by the operator at will. To initiate a self diagnostic test during operation:

Press the *System* button to start the *System* function.

```
TRAK/HLD Auto-Cal  
PSWD Logout More
```

Use the < > arrow keys to blink **More**, then press *Enter*.

```
Version Self-Test
```

Use the < > arrow keys again to move the blinking to the **Self-Test** function. The screen will follow the running of the diagnostic.

```
RUNNING DIAGNOSTIC  
Testing Preamp - 83
```

During preamp testing there is a countdown in the lower right corner of the screen. When the testing is complete, the results are displayed.

```
Power: OK Analog: OK  
Preamp: 3
```

The module is functioning properly if it is followed by **OK**. A number indicates a problem in a specific area of the instrument. Refer to chapter 5 *Maintenance* for number-code information. The results screen alternates for a time with:

```
Press Any Key  
To Continue...
```

Then the analyzer returns to the initial System screen.

4.3.6 Version Screen

Move the < > arrow key to **More** and press *Enter*. With **Version** blinking, press *Enter*. The screen displays the manufacturer, model, and software version information.

4.3.7 Showing Negative Oxygen Readings

For software version 1.4.4 or later, the instrument only displays oxygen readings that are positive or zero. The instrument can be reconfigured to show negative readings if sensor output drifts below zero. This situation may arise after the instrument has been zeroed, as time progresses the sensor may drift below the zero calibration setpoint.

To show negative oxygen readings on the display:

- Press the *System* key

TRAK/HLD Auto-Cal
PSWD Logout More

- Use the Right or Left arrow keys and select More. *Press Enter.*

Version Self-Test
Show_Negative=NO

- Use the Right or Left arrow keys and select “Show_Negative=NO”.
- Use the Up or Down key to toggle from NO to YES.
- Press the *Escape* key twice to return to the analyze mode.

This preference is stored in non-volatile memory, so this configuration is remembered after a power shutdown. If the instrument is cold started, it will go back to default (not showingg negative oxygen readings).

4.4 The *Zero* and *Span* Functions

Zeroing is not required in order to achieve the published accuracy specification of this unit.

Zeroing will eliminate offset error contributed by sensor, electronics, and internal and external sampling system and improve performance beyond published specification limits.

The analyzer is calibrated using zero and span gases.

Any suitable oxygen-free gas can be used for zero gas as long as it is known that it will not react adversely with the sample system.

Although the instrument can be spanned using air, a span gas with a known oxygen concentration in the range of 70–90% of full scale of the range of interest is recommended. Since the oxygen concentration in air is 20.9 % (209,000 ppm), the cell can take longer to recover if the instrument is used for trace or less than 1% full scale oxygen analysis immediately following calibration in air.

Connect the calibration gases to the analyzer according to the instructions given in Section 3.4.1, *Gas Connections*, observing all the prescribed precautions.

Shut off the gas pressure before connecting it to the analyzer, and be sure to limit the pressure to 40 psig or less when turning it back on.

Readjust the gas pressure into the analyzer until the flowrate (as read on the Analysis Unit SLPM flowmeter) settles between 0.5 and 2.4 SLPM (approximately 1-5 scfh).

If you are using password protection, you will need to enter your password to gain access to either of these functions. Follow the instructions in sections 4.3.3.2 or 4.3.3.3 to enter your password. Once you have gained clearance to proceed, you can enter the *Zero* or *Span* function.

4.4.1 Zero Cal

The *Zero* button on the front panel is used to enter the zero calibration function. Zero calibration can be performed in either the automatic or manual mode. In the **automatic** mode, an internal algorithm compares consecutive readings from the sensor to determine when the output is within the acceptable range for zero. In the **manual** mode, the operator determines when the reading is within the acceptable range for zero. Make sure the zero gas is connected to the instrument. If you get a **CELL FAILURE** message skip to section 4.4.1.3.

4.4.1.1 Auto Mode Zeroing

Press *Zero* to enter the zero function mode. The screen allows you to select whether the zero calibration is to be performed automatically or manually. Use the Δ / ∇ arrow keys to toggle between **AUTO** and **MAN** zero settling. Stop when **AUTO** appears, blinking, on the display.

```
Zero: Settling: AUTO
<ENT> To Begin
```

Press *Enter* to begin zeroing.

```
##### PPM Zero
Slope=##### ppm/s
```

The beginning zero level is shown in the upper left corner of the display. As the zero reading settles, the screen displays and updates information on **Slope** (unless the Slope starts within the acceptable zero range and does not need to settle further).

Then, and whenever Slope is less than 0.08 for at least 3 minutes, instead of Slope you will see a countdown: **5 Left**, **4 Left**, and so fourth. These are five steps in the zeroing process that the system must complete, **AFTER** settling, before it can go back to *Analyze*.

```
##### PPM Zero
4 Left=### ppm/s
```

The zeroing process will automatically conclude when the output is within the acceptable range for a good zero. Then the analyzer automatically returns to the *Analyze* mode.

4.4.1.2 Manual Mode Zeroing

Press *Zero* to enter the *Zero* function. The screen that appears allows you to select between automatic or manual zero calibration. Use the $\Delta\nabla$ keys to toggle between **AUTO** and **MAN** zero settling. Stop when **MAN** appears, blinking, on the display.

```
Zero: Settling: Man
<ENT> To Begin
```

Press *Enter* to begin the zero calibration. After a few seconds the first of five zeroing screens appears. The number in the upper left hand corner is the first-stage zero offset. The microprocessor samples the output at a predetermined rate. It calculates the differences between successive samplings and displays the rate of change as **Slope**= a value in parts per million per second (ppm/s).

```
##### ppm Zero
Slope=##### ppm/s
```

NOTE: It takes several seconds for the true Slope value to display. Wait about 10 seconds. Then, wait until Slope is sufficiently close to zero before pressing Enter to finish zeroing. Slope is given in ppm/s.

Generally, you have a good zero when **Slope** is less than 0.05 ppm/s for about 30 seconds. When **Slope** is close enough to zero, press *Enter*. In a few seconds, the screen will update.

Once span settling completes, the information is stored in the microprocessor, and the instrument automatically returns to the *Analyze* mode.

4.4.1.3 Cell Failure

Cell failure in the 3010MB is usually associated with inability to zero the instrument down to a satisfactorily low ppm reading, e.g. cell does not fail if it comes below 5PPM . When this occurs, the 3010MB system alarm trips, and the LCD displays a failure message.

```
#. # ppm Anlz
CELL FAIL/ ZERO HIGH
```

Before replacing the cell:

- a. Check your span gas to make sure it is within specifications.
- b. Check for leaks downstream from the cell, where oxygen may be leaking into the system.

- c. Check whether more time is needed for readings to drop to a satisfactory level. This might happen when zero was started from very high PPM level

If there are no leaks and the span gas is OK, replace the cell as described in Part II *Analysis Units*, chapter 5 *Maintenance*.

4.4.2 Span Cal

The *Span* button on the front panel is used to span calibrate the analyzer. Span calibration can be performed using the **automatic** mode, where an internal algorithm compares consecutive readings from the sensor to determine when the output matches the span gas concentration. Span calibration can also be performed in **manual** mode, where the operator determines when the span concentration reading is acceptable and manually exits the function.

4.4.2.1 Auto Mode Spanning

Press *Span* to enter the span function. The screen that appears allows you to select whether the span calibration is to be performed automatically or manually. Use the $\Delta\nabla$ arrow keys to toggle between **AUTO** and **MAN** span settling. Stop when **AUTO** appears, blinking, on the display.

```
Span: Settling: AUTO
<ENT> For Next
```

Press *Enter* to move to the next screen.

```
Calib. Holding time
Cal hold: 5 min
```

This menu allows the operator to set the time the analyzer should be held in the auto span mode. It does not affect anything in Manual Mode. Just press *Enter* to continue.

Press *Enter* to move to the next screen.

```
Span Val: 000008.00
<ENT>Span <UP>Mod #
```

Use the $\Delta\nabla$ arrow keys to enter the oxygen-concentration mode. Use the $\langle \rangle$ arrow keys to blink the digit you are going to modify. Use the $\Delta\nabla$ arrow keys again to change the value of the selected digit. When you have finished typing in the concentration of the span gas you are using (209000.00 if you are using air), press *Enter* to begin the Span calibration.

```
#####      ppm      Span
Slope=##### ppm/s
```

The beginning span value is shown in the upper left corner of the display. As the span reading settles, the screen displays and updates information on **Slope**. Spanning automatically ends when the span output corresponds, within tolerance, to the value of the span gas concentration. Then the instrument automatically returns to the analyze mode.

4.4.2.2 Manual Mode Spanning

Press *Span* to start the *Span* function. The screen that appears allows you to select whether the span calibration is to be performed automatically or manually.

```
Span: Settling:MAN
<ENT> For Next
```

Use the $\Delta\nabla$ keys to toggle between **AUTO** and **MAN** span settling. Stop when **MAN** appears, blinking, on the display. Press *Enter* to move to the next screen.

Press *Enter* to move to the next screen.

```
Calib. Holding time
Cal hold: 5 min
```

This menu allows the operator to set the time the analyzer should be held in the auto span mode. It does not affect anything in the Manual Mode. Just press *Enter* to continue.

```
Span Val : 000008.00
<ENT>Span <UP>Mod #
```

Press Δ (<UP>) to permit modification (**Mod #**) of span value.

Use the arrow keys to enter the oxygen concentration of the span gas you are using (209000.00 if you are using air). The < > arrows choose the digit, and the $\Delta\nabla$ arrows choose the value of the digit.

Press *Enter* to enter the span value into the system and begin the span calibration.

Once the span has begun, the microprocessor samples the output at a predetermined rate. It calculates the difference between successive samplings and displays this difference as Slope on the screen. It takes several seconds for the first Slope value to display. Slope indicates rate of change of the Span reading. It is a sensitive indicator of stability.

```
#####      % Span
Slope=##### ppm/s
```

When the *Span* value displayed on the screen is sufficiently stable, press **Enter**. (Generally, when the *Span* reading changes by 1 % or less of the full scale of the range being calibrated for a period of ten minutes it is sufficiently stable.) Once **Enter** is pressed, the *Span* reading changes to the correct value. The instrument then **automatically** enters the *Analyze* function.

4.4.3 Span Failure

The analyzer checks the output of the cell at the end of the span. If the raw output of the cell is less than 0.5 uA/ppm O₂, the span will not be accepted. The analyzer will return to the previous calibration values, trigger the System Alarm, and display in the VFD:

Span Failed!!

This message will be shown for five seconds and the instrument shall return to the Analyze mode. In the upper right hand corner of the VFD display “FCAL” will be shown. This message flag will help the operator troubleshoot in case calibration was initiated remotely. To reset the alarm and the flag message, the unit must be turned off by cycling the standby key . It will not reset if the next span cycle is correct.

A trace cell is unlikely to fail span. As explained before, when the sensor reaches the end of its useful life, the zero offset begins to rise until the analyzer finds the zero unsatisfactory. Nevertheless, feeding the wrong span gas or electronics failure could set this feature off at the end of the span. Consider this before replacing the cell.

4.5 The Alarms Function

The Model 3010MB is equipped with 2 fully adjustable concentration alarms and a system failure alarm. Each alarm has a relay with a set of form C contacts rated for 3 amperes resistive load at 250 V ac. See figure in chapter 3, *Installation* and/or the Interconnection Diagram included at the back of this manual for relay terminal connections.

The system failure alarm has a fixed configuration described in chapter 3 *Installation*.

The concentration alarms can be configured from the front panel as either *high* or *low* alarms by the operator. The alarm modes can be set as

latching or *nonlatching*, and either *failsafe* or *nonfailsafe*, or, they can be *defeated* altogether. The setpoints for the alarms are also established using this function.

Decide how your alarms should be configured. The choice will depend upon your process. Consider the following four points:

1. Which if any of the alarms are to be high alarms and which if any are to be low alarms?

Setting an alarm as HIGH triggers the alarm when the oxygen concentration rises above the setpoint. Setting an alarm as LOW triggers the alarm when the oxygen concentration falls below the setpoint.

Decide whether you want the alarms to be set as:

- Both high (high and high-high) alarms, or
- One high and one low alarm, or
- Both low (low and low-low) alarms.

2. Are either or both of the alarms to be configured as failsafe?

In failsafe mode, the alarm relay de-energizes in an alarm condition. For nonfailsafe operation, the relay is energized in an alarm condition. You can set either or both of the concentration alarms to operate in failsafe or nonfailsafe mode.

3. Are either of the alarms to be latching?

In latching mode, once the alarm or alarms trigger, they will remain in the alarm mode even if process conditions revert back to no-alarm conditions. This mode requires an alarm to be recognized before it can be reset. In the nonlatching mode, the alarm status will terminate when process conditions revert to no-alarm conditions.

4. Are either of the alarms to be defeated?

The defeat alarm mode is incorporated into the alarm circuit so that maintenance can be performed under conditions which would normally activate the alarms.

The defeat function can also be used to reset a latched alarm. (See procedures, below.)

If you are using password protection, you will need to enter your password to access the alarm functions. Follow the instructions in Section 4.3.3 to enter your password. Once you have clearance to proceed, enter the *Alarm* function.

Press the *Alarm* button on the front panel to enter the *Alarm* function. Make sure that **AL-1** is blinking.

```
AL-1      AL-2
Choose Alarm
```

Set up alarm 1 by moving the blinking over to **AL-1** using the < > arrow keys. Then press *Enter* to move to the next screen.

```
AL-1 1000 ppm HI
Dft-N Fs-N Ltch-N
```

Five parameters can be changed on this screen:

- Value of the alarm setpoint, AL-1 ##### (ppm or % oxygen)
- Out-of-range direction, HI or LO
- Defeated? Dft-**Y/N** (Yes/No)
- Failsafe? Fs-**Y/N** (Yes/No)
- Latching? Ltch-**Y/N** (Yes/No).
- To define the setpoint, use the < > arrow keys to move the blinking over to AL-1 #####. Then use the $\Delta \nabla$ arrow keys to change the number. Holding down the key speeds up the incrementing or decrementing. (Remember, setpoint units are parts-per-million.)
- To set the other parameters use the < > arrow keys to move the blinking over to the desired parameter. Then use the $\Delta \nabla$ arrow keys to change the parameter.
- Once the parameters for alarm 1 have been set, press *Alarms* again, and repeat this procedure for alarm 2 (AL-2).
- To reset a latched alarm, go to **Dft-** and then press either Δ two times or ∇ two times. (Toggle it to **Y** and then back to **N**.)

-OR -

Go to **Ltch-** and then press either Δ two times or ∇ two times. (Toggle it to **N** and back to **Y**.)

4.6 The Range Function

The Range function allows the operator to program up to three concentration ranges to correlate with the DC analog outputs. If no ranges are defined by the user, the instrument defaults to:

Range	Limits
Low	0-1%
Med	0-5%
High	0-10%

The Model 3010MB is set at the factory to default to autoranging. In this mode, the microprocessor automatically responds to concentration changes by switching ranges for optimum readout sensitivity. If the current range limits are exceeded, the instrument will automatically shift to the next higher range. If the concentration falls to below 85% of full scale of the next lower range, the instrument will switch to that range. A corresponding shift in the DC percent-of-range output, and in the range ID outputs, will be noticed.

The autoranging feature can be overridden so that analog output stays on a fixed range regardless of the oxygen concentration detected. If the concentration exceeds the upper limit of the range, the DC output will saturate at 1 V dc (20 mA at the current output).

However, the digital readout and the RS-232 output of the concentration are unaffected by the fixed range. They continue to read accurately with full precision. See *Front Panel* description in chapter 1.

The automatic air calibration range is always 0-25 % and is not programmable.

4.6.1 Setting the Analog Output Ranges

To set the ranges, enter the range function mode by pressing the *Range* button on the front panel.

```
L-###      M-####  
H-#####  Mode-AUTO
```

Use the <> arrow keys to blink the range to be set: low (L), medium (M), or high (H).

Use the Δ and ∇ arrow keys to enter the upper value of the range (all ranges begin at 0 ppm). Repeat for each range you want to set. Press *Enter* to accept the values and return to *Analyze* mode. (See note below.)

Note: The ranges must be increasing from low to high, for example, if range 1 is set as 0–10% and range 2 is set as 0–100%, range 3 cannot be set as 0–50% since it is lower than range 2.

4.6.2 Fixed Range Analysis

The autoranging mode of the instrument can be overridden, forcing the analyzer DC outputs to stay in a single predetermined range.

To switch from autoranging to fixed range analysis, enter the range function by pressing the *Range* button on the front panel.

Use the < > arrow keys to move the blinking over **AUTO**.

Use the $\Delta \nabla$ arrow keys to switch from **AUTO** to **FX/LO**, **FX/MED**, or **FX/HI** to set the instrument on the desired fixed range (low, medium, or high).

```
L-#### M-####
H-##### Mode-FX/LO
```

or

```
L-#### M-####
H-##### Mode-FX/MED
```

or

```
L-#### M-####
H-##### Mode-FX/HI
```

Press *Escape* to re-enter the *Analyze* mode using the fixed range.

NOTE: When performing analysis on a fixed range, if the oxygen concentration rises above the upper limit (or default value) as established by the operator for that particular range, the output saturates at 1 V dc (or 20 mA). However, the digital readout and the RS-232 output continue to read the true value of the oxygen concentration regardless of the analog output range.

4.7 The *Analyze* Function

When the *Analyze* function is active, the 3010MB is monitoring the sample gas currently flowing in the Analysis Unit cell block. All undefeated alarms are ready to activate should their respective setpoints be crossed.

Press the *Analyze* button to put the analyzer in the *Analyze* mode.

Normally, all of the functions automatically switch back to the *Analyze* function when they have completed their assigned operations. Pressing the *Escape* button in many cases also switches the analyzer back to the *Analyze* function. Alternatively, you can press the *Analyze* button at any time to return to analyzing your sample.

4.8 Signal Output

The standard Model 3010MB Percent Paramagnetic Oxygen Analyzer is equipped with two 0-1 V dc analog output terminals accessible on the interface panel (one concentration and one range ID) and two isolated 4-20 mA dc current outputs (one concentration and one range ID).

See *Rear Panel* in chapter 3, *Installation*, for illustration.

The signal output for concentration is linear over the currently selected analysis range. For example, if the analyzer is set on range that was defined as 0–10% O₂, then the output would be:

ppm O ₂	Voltage Signal Output (V dc)	Current Signal Output (mA dc)
0	0.0	4.0
1	0.1	5.6
2	0.2	7.2
3	0.3	8.8
4	0.4	10.4
5	0.5	12.0
6	0.6	13.6
7	0.7	15.2
8	0.8	16.8
9	0.9	18.4
10	1.0	20.0

The analog output signal has a voltage which depends on the oxygen concentration AND the currently activated analysis range. To relate the signal output to the actual concentration, it is necessary to know what range the instrument is currently on, especially when the analyzer is in the autoranging mode.

To provide an indication of the range, a second pair of analog output terminals are used. They generate a steady preset voltage (or current when using the current outputs) to represent a particular range. The following table gives the range ID output for each analysis range:

Range	Voltage (V)	Current (mA)
LO	0.25	8
MED	0.50	12
HI	0.75	16
CAL (0-25%)	1.00	20



IMPORTANT: In the event of loss of flow through the analyzer, if the vent is vented to a location of high oxygen content, oxygen will back diffuse through the vent line and in most cases quickly saturate the cell with oxygen which can then require a quite long purge down time for the sensor when then exposed to low oxygen concentrations. In the event that flow is to be interrupted into the analyzer, it is suggested that the user do one of the following:

1. Bag the sensor in nitrogen during this time
2. Install a shut off valve on the vent port of the analyzer or somewhere within the users sample system.

Maintenance



Aside from normal cleaning and checking for leaks at the gas connections, routine maintenance is limited to replacing fuses, and recalibration.

Checking for leaks, and replacing fuses in the Analysis Unit are covered in Part II, Chapter 5. For recalibration, see Part I, section 4.4 *Calibration*.



WARNING: SEE WARNINGS ON THE TITLE PAGE OF THIS MANUAL.

5.1 Fuse Replacement

The 3010MB requires two 5 x 20 mm, 1.0 A, T type (Slow Blow) fuses.

The fuses are located inside the main housing on the Electrical Connector Panel, as shown in Figure 5-3. To replace a fuse:

1. Disconnect the Unit from its power source.
2. Place a small screwdriver in the notch in the fuse holder cap, push in, and rotate 1/4 turn. The cap will pop out a few millimeters. Pull out the fuse cap and fuse, as shown in Figure 5-1

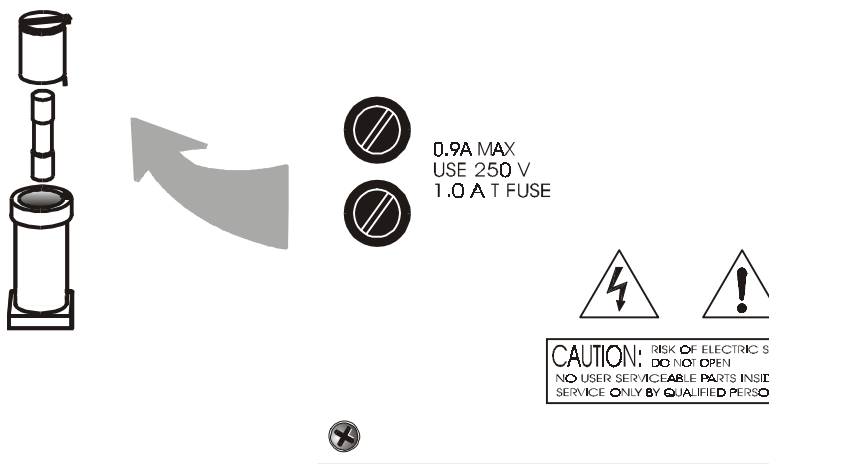

Figure 5-1: Removing Fuse Block Cap and Fuse from Housing

2. Replace fuse by reversing process in step 1.

5.2 System Self Diagnostic Test

1. Press the *System* button to enter the system mode.
2. Use the < > arrow keys to move to More, and press *Enter*.
3. Use the < > arrow keys to move to Self-Test, and press *Enter*.

The following failure codes apply:

Table 5-1: Self Test Failure Codes

Power

- | | |
|---|---------------|
| 0 | OK |
| 1 | 5 V Failure |
| 2 | 15 V Failures |
| 3 | Both Failed |

Analog

- | | |
|---|-----------------------------|
| 0 | OK |
| 1 | DAC A (0–1 V Concentration) |
| 2 | DAC B (0–1 V Range ID) |
| 3 | Both Failed |

Preamp

0	OK
1	Zero too high
2	Amplifier output doesn't match test input
3	Both Failed

5.3 Major Internal Components

The major components in the Control Unit are shown in Figure 5-3.

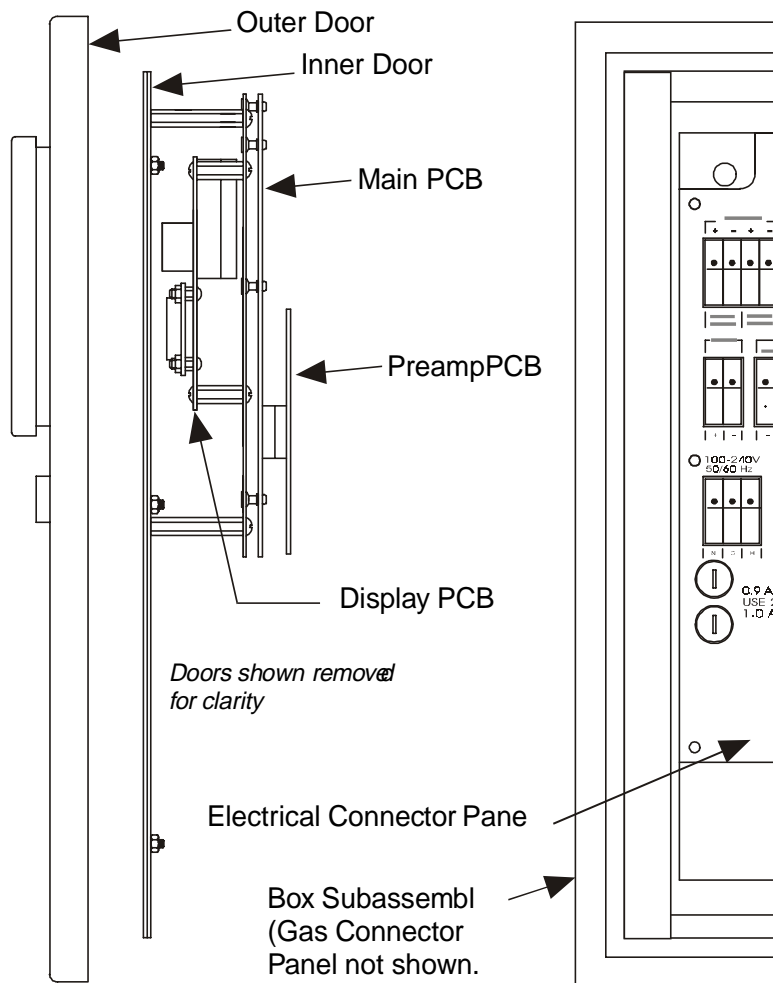

Figure 5-3: Control Unit Major Internal Components

WARNING: HAZARDOUS VOLTAGES EXIST ON CERTAIN COMPONENTS INTERNALLY WHICH MAY PERSIST FOR A TIME EVEN AFTER THE POWER IS TURNED OFF AND DISCONNECTED.

The 3010MB Control Units contain the following major components:

- Power Supply
- Motherboard (with Microprocessor, RS-232 chip, and Preamplifier PCB)
- Front Panel Display Board and Displays—
 - 5 digit LED meter
 - 2 line, 20 character, alphanumeric, VFD display

See the drawings in the Drawings section in back of this manual for details.

OPERATING INSTRUCTIONS

Model 3010M

Oxygen Analyzer

Part II: Analysis Unit

Part Number D-71394

Table of Contents

1 Operational Theory

1.1 Introduction 1-1
1.2 Precise Paramagnetic Sensors 1-1
 1.2.1 Principles of Operation 1-1
1.3 Cross Interface 1-3

2 Maintenance

2.1 Routine Maintenance 2-1
2.2 Major Internal Components 2-1
2.3 Sensor Replacement 2-1
2.4 Output Goes Negative 2-1

Operational Theory

1.1 Introduction

The analyzer is composed of three subsystems:

1. Paramagnetic Sensor
2. Sample System
3. Electronic Signal Processing, Display and Control

The sample system is designed to accept the sample gas and transport it through the analyzer without contaminating or altering the sample prior to analysis. The Paramagnetic Sensor is an electromechanical device that translates the amount of oxygen present in the sample into an electrical signal. The electronic signal processing, display and control subsystem simplifies operation of the analyzer and accurately processes the sampled data. The microprocessor controls all signal processing, input/output and display functions for the analyzer.

1.2 Precise Paramagnetic Sensor

1.2.1 Principles of Operation

The heart of the 3010M is a paramagnetic type oxygen sensor that is maintenance free and has a long lifetime. Oxygen has a very high magnetic susceptibility compared to other gases and thus displays a particularly paramagnetic behavior. A small glass dumbbell filled with nitrogen and rotating on a taut platinum wire is suspended in an inhomogeneous magnetic field. This glass dumbbell is diamagnetic and tends to rotate out of the magnetic field. The strength of the resulting torque determined by an susceptibility of the sample gas. This torque is compensated for by a counter torque induced by an electrically charged platinum coil on the dumbbell. The zero position of the dumbbell is controlled by means of an optical system consisting of a light source, a mirror at the dumbbell axis and a pair of detectors. The difference between the compensating currents required to bring the dumb-

bell to the zero position in the presence of zero gas (i.e. no O₂ present) or of sample gas is proportional to the partial pressure of oxygen in the sample gas.

The sensor enclosure is temperature controlled to 55 degrees centigrade to insure that the magnetic susceptibility of oxygen in the sample is not affected by the ambient temperature. The measuring cell has a measuring volume of approximately 3 cm³

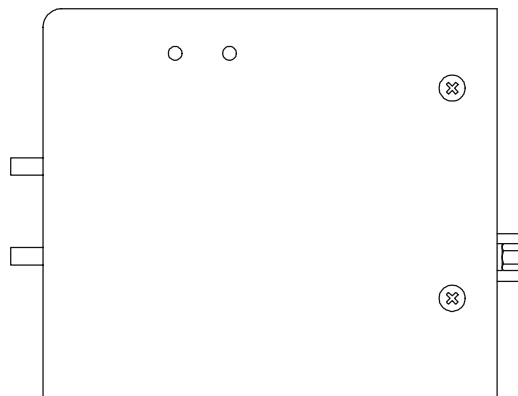

Sensor
(side view shown)

The Paramagnetic sensor enclosure holds not only the sensing elements, but the temperature controller electronics, heating elements, sensor electronics, and preamplifier. The Electronics and heating elements require a separate power source, from the rest of the 3020M capable of delivering 1.5 amps approximately at 24 volts dc. The output of the sensor is roughly calibrated to be 0 to 1 volt DC for the the range of 0 to 100 % O₂. The true calibration of the sensor is carried out by the microprocessor as described later in chapter 4. The electrical interconnections to the sensor are done through a 15 pin D connector. Some signals from the sensor are not connected. They are only useful for troubleshooting, by trained personnel, as test points.

*Sensor
(rear view shown)*

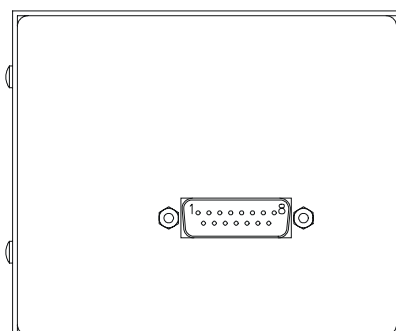

Pin out:

1	-15Vdc test pin (Not connected)
2	+15Vdc test pin (Not connected)
3	Measuring ground
4	Not used
5	Preamplifier output ~0- 1 Vdc
6	Not used
7	24 Vdc return, power ground
8	Collector of transistor switching heating element (Not connected)
9	Fault signal: <0 Vdc= OK, >4.6 Vdc = Fault (Not connected)
10	Not used
11	Negative reference voltage (Not connected)
12	Positive reference voltage (Not connected)
13	Nominal temperature voltage signal (Not connected)
14	Actual temperature voltage signal (Not connected)
15	+24 Vdc power.

1.3 Cross Interference

As mentioned previously, the selectivity of the measuring system is based on the extraordinarily high magnetic susceptibility of Oxygen compared to other gases. In most cases the presence of other gases can be ignored but significant errors can occur when the sensor is calibrated with a mixture of oxygen and nitrogen and the sample gas consists mainly of other gases with considerable magnetic susceptibility. In this case, the reading shows a measured value even if the sample gas contains no Oxygen. It is actually displaying the cross sensitivity to another gas.

The following table shows the cross sensitivity of some gases when changing from pure nitrogen to 100% of one of the gases listed.

Gas	Cross Sensitivity in vol. %	Gas	Cross Sensitivity in vol. %
Acetylene C ₂ H ₂	-0.24	Hydrogen chloride HCl	-0.30
Allene C ₃ H ₄	-0.44	Hydrogen fluoride HF	+0.10
Ammonia NH ₃	-0.26	Hydrogen iodide HI	-1.10
Argon Ar	-0.22	Hydrogen sulphide H ₂ S	-0.39
Bromine Br ₂	-1.30	Iodine I	-2.40
1.2 Butadiene C ₄ H ₆	-0.49	Isobutane C ₄ H ₁₀	-1.11
1.3 Butadiene C ₄ H ₆	-0.49	Isopentane C ₅ H ₁₂	-1.49
n-Butane C ₄ H ₁₀	-1.11	Krypton Kr	-0.51
I-Butane C ₄ H ₈	-0.85	Laughing gas N ₂ O	-0.20
cis 2-Butane C ₄ H ₈	-0.89	Methane CH ₄	-0.20
trans 2-Butane C ₄ H ₈	-0.92	Neon Ne	+0.13
Carbon dioxide CO ₂	-0.27	Neopentane C ₅ H ₁₂	-1.49
Carbon monoxide CO	+0.06	Nitric acid HNO ₃	+0.43
Chlorine Cl ₂	-0.77	Nitrogen dioxide NO ₂	+28.00
Cyclo hexane C ₆ H ₁₂	-1.56	Nitrous oxide NO	+40.00
Ethane C ₂ H ₆	-0.43	n-Octane C ₈ H ₁₈	-2.50
Ethylene C ₂ H ₄	-0.26	n-Pentane C ₅ H ₁₂	-1.45
Helium He	+0.30	Propane C ₃ H ₈	-0.86
n-Heptane C ₇ H ₁₆	-2.10	Propylene C ₃ H ₆	-0.55
n-Hexane C ₆ H ₁₄	-1.70	Vinyl chloride	-0.63
Hydrogen H ₂	+0.24	Water H ₂ O	-0.02
Hydrogen bromide HBr	-0.61	Xenon Xe	-0.95

With gas mixtures the components are weighted according to their proportional volumes.

The cross interference with a gas mixture can be determined in advance if the concentration of the individual background gases is known.

Example:

Cross sensitivity calculation for a gas mixture:

The gas to be measured consists of 10 % CO₂, 40 % of N₂, and 50% of Ar.

$$\text{CO}_2: -0.27 \times 10\% = -0.027$$

$$\text{Ar: } \frac{-0.22 \times 50\%}{1} = -0.11$$

$$\text{TOTAL CROSS INTERFERENCE } -0.137$$

Calculation of the zero value:

$$(0\% \text{ O}_2) - (\text{Cross Interference Value}) = \text{Zero Point Value}$$

$$0\% - (-0.137) = +0.137\% \text{ O}_2$$

Maintenance

2.1 Routine Maintenance



Aside from normal cleaning and checking for leaks at the gas connections, routine maintenance is limited to replacing Paramagnetic Sensor and fuses, and recalibration. For recalibration, see Section 4.4 *The Zero and Span Functions*.



WARNING: SEE WARNINGS ON TITLE PAGE OF THIS MANUAL.

2.2 Major Internal Components

The 3010M contains the following major internal components:

- Paramagnetic Sensor

2.3 Sensor Replacement

The Paramagnetic Sensor is maintenance free, and has a long life. Should the sensor fail, contact the factory for service and replacement.

2.4 Output Goes Negative

If during operation of the instrument, gas pressure exceeds 20 psig, the output of the sensor may reverse polarity, readings on the display may go negative. If this happens:

Make sure analyzer is mounted in the upright position (see chapter 3, Installation).

Turn power off by unplugging the instrument.

Turn gas pressure to less than 20 psig.

Turn power on again.

Return instrument to analyze mode.

Appendix

A-1 Specifications

Packaging: Bulkhead mount.

Sensor: Paramagnetic Sensor.

Ranges: Three user definable ranges from 0-5 % to 0-100 %.

Autoranging with range ID output.

Sample System: Positive pressure service.

Vacuum service (optional).

Auto Cal / Auto Zero. (Available with optional, electrically operated valves.)

Alarms: One system-failure alarm contact to detect power failure.

Two adjustable concentration threshold alarms with fully programmable setpoints.

Diagnostics: Start-up or on-demand self-testing function.

Response Time: 90% in 10 seconds or less.

Displays: 2 line by 20 alphanumeric, VFD screen, and one 5 digit LED display.

Digital Interface: Full duplex RS-232 communications port.

Power: Universal power supply 100-240 V ac, at 50 or 60 Hz, 70 Watts max.

Operating Temperature: 0-45 °C

Accuracy: ±1% of full scale at constant temperature.
±5% of full scale over operating temperature

range, on factory default analysis ranges, once thermal equilibrium has been achieved.

Analog outputs: 0-1 V dc percent-of-range
0-1 V dc range ID.

4-20 mADC percent-of-range
4-20 mADC range ID.

Password Access: Can be user-configured for password protection.

A-2 Recommended 2-Year Spare Parts List

QTY.	PART NUMBER	DESCRIPTION
1	C62371B	Display PCB
1	D70046	Customer Interface PCB
1	C70043	Percent Preamplifier Board
1	C62365-A	Main PCB (4-20 mA)
4	F1295	Fuse, 4A, 250V, 5x20 mm, T (Slow Blow)

A minimum charge is applicable to spare parts orders.

Note: Orders for replacement parts should include the part number (if available) and the model and serial number of the instrument for which the parts are intended.

Orders should be sent to:

Teledyne Analytical Instruments
16830 Chestnut Street
City of Industry, CA 91749-1580

Phone (626) 934-1500, Fax (626) 961-2538
TWX (910) 584-1887 TDYANYL COID

Web: www.teledyne-ai.com

or your local representative.

A-3 Drawing List

D-66826 Wiring Diagram

C-71466 Interconnection Diagram

NOTE: The MSDS on this material is available upon request through the Teledyne Environmental, Health and Safety Coordinator. Contact at (626) 934-1592

A-5 Zero Cal

The ZERO function on the MAIN MENU is used to enter the zero calibration function. Zero calibration can be performed in either the automatic or manual mode. In the **automatic** mode, an internal algorithm compares consecutive readings from the sensor to determine when the output is within the acceptable range for zero. In the **manual** mode, the operator determines when the reading is within the acceptable range for zero.

Make sure the zero gas is connected to the instrument.

If you have trouble zeroing, you may need to skip to section 4.8.1.3 *Cell Failure*.

Auto Mode Zeroing

Select ZERO to enter the ZERO function. The ZERO screen allows you to select whether the zero calibration is to be performed automatically or manually. Use the DOWN/UP control to toggle between AUTO and MAN zero settling. Stop when AUTO appears on the display.

```
Zero: Settling: AUTO  
<ENT> To Begin
```

ENTER to begin zeroing.

```
##### % Zero  
Slope=##### ppm/s
```

The beginning zero level is shown in the upper left corner of the display. As the zero reading settles, the screen displays and updates information on Slope (unless the Slope starts within the acceptable zero range and does not need to settle further).

Then, and whenever Slope is less than 0.08 for at least 3 minutes, instead of Slope you will see a countdown, such as 1 Left, 0 Left. These are steps in the zeroing process that the system must complete, AFTER settling, before it can go back to ANALYZE.

```
##### % Zero  
1 Left=##### ppm/s
```

The zeroing process will automatically conclude when the output is within the acceptable range for a good zero. Then the analyzer automatically returns to the ANALYZE screen.

Manual Mode Zeroing

ENTER the ZERO function. The screen that appears allows you to select between automatic or manual zero calibration. Use DOWN/UP to toggle between AUTO and MAN zero settling. Stop when MAN appears on the display.

```
Zero: Settling: Man  
<ENT> To Begin
```

ENTER to begin the zero calibration. After a few seconds the first of five zeroing screens appears. The number in the upper left hand corner is the first-stage zero offset. The microprocessor samples the output at a predetermined rate. It calculates the differences between successive samplings and displays the rate of change as Slope= a value in parts per million per second (ppm/s).

```
#### % Zero  
Slope=#### ppm/s
```

NOTE: It takes several seconds for the true Slope value to display.

Wait about 10 seconds. Then, wait until Slope is sufficiently close to zero before using ENTER to finish zeroing.

Generally, you have a good zero when Slope is less than 0.05 ppm/s for about 30 seconds. When Slope is close enough to zero, ENTER it. In a few seconds, the screen will update.

Once zero settling completes, the information is stored in the microprocessor, and the instrument automatically returns to the ANALYZE screen.

Free Manuals Download Website

<http://myh66.com>

<http://usermanuals.us>

<http://www.somanuals.com>

<http://www.4manuals.cc>

<http://www.manual-lib.com>

<http://www.404manual.com>

<http://www.luxmanual.com>

<http://aubethermostatmanual.com>

Golf course search by state

<http://golfingnear.com>

Email search by domain

<http://emailbydomain.com>

Auto manuals search

<http://auto.somanuals.com>

TV manuals search

<http://tv.somanuals.com>