

# 730 Bubbler Module

## Installation and Operation Guide



Part #60-9003-063  
Copyright © 1995. All rights reserved, Teledyne Isco, Inc.  
Revision K, May 9, 2007



## Foreword

This instruction manual is designed to help you gain a thorough understanding of the operation of the equipment. Teledyne Isco recommends that you read this manual completely before placing the equipment in service.

Although Teledyne Isco designs reliability into all equipment, there is always the possibility of a malfunction. This manual may help in diagnosing and repairing the malfunction.

If the problem persists, call or e-mail the Teledyne Isco Technical Service Department for assistance. Simple difficulties can often be diagnosed over the phone.

If it is necessary to return the equipment to the factory for service, please follow the shipping instructions provided by the Customer Service Department, including the use of the **Return Authorization Number** specified. **Be sure to include a note describing the malfunction.** This will aid in the prompt repair and return of the equipment.

Teledyne Isco welcomes suggestions that would improve the information presented in this manual or enhance the operation of the equipment itself.

**Teledyne Isco is continually improving its products and reserves the right to change product specifications, replacement parts, schematics, and instructions without notice.**

### Contact Information

#### *Customer Service*

Phone: (800) 228-4373 (USA, Canada, Mexico)  
(402) 464-0231 (Outside North America)  
Fax: (402) 465-3022  
Email: IscoCSR@teledyne.com

#### *Technical Service*

Phone: (800) 775-2965 (Analytical)  
(800) 228-4373 (Samplers and Flow Meters)  
Email: IscoService@teledyne.com

Return equipment to: 4700 Superior Street, Lincoln, NE 68504-1398

#### *Other Correspondence*

Mail to: P.O. Box 82531, Lincoln, NE 68501-2531  
Email: IscoInfo@teledyne.com  
Web site: www.isco.com

Revised September 15, 2005



*General Warnings*

Before installing, operating, or maintaining this equipment, it is imperative that all hazards and preventive measures are fully understood. While specific hazards may vary according to location and application, take heed in the following general warnings:

 **WARNING**

**This instrument has not been certified for use in “hazardous locations” as defined by the National Electrical Code.**

 **WARNING**

**Avoid hazardous practices! If you use this instrument in any way not specified in this manual, the protection provided by the instrument may be impaired; this will increase your risk of injury.**

 **AVERTISSEMENT**

**Éviter les usages périlleux! Si vous utilisez cet instrument d’une manière autre que celles qui sont spécifiées dans ce manuel, la protection fournie de l’instrument peut être affaiblie; cela augmentera votre risque de blessure.**

This product is often installed in confined spaces. Some examples of confined spaces are manholes, pipelines, digesters, and storage tanks. These spaces may become hazardous environments that can prove fatal for those unprepared. These spaces are governed by OSHA 1910.146 and require a permit before entering.

*Hazard Severity Levels*

This manual applies *Hazard Severity Levels* to the safety alerts, These three levels are described in the following sample alerts.

 **CAUTION**

Cautions identify a potential hazard, which if not avoided, may result in minor or moderate injury. This category can also warn you of unsafe practices, or conditions that may cause property damage.

 **WARNING**













**Warnings identify a potentially hazardous condition, which if not avoided, could result in death or serious injury.**

 **DANGER**

**DANGER – limited to the most extreme situations to identify an imminent hazard, which if not avoided, will result in death or serious injury.**

*Hazard Symbols*

The equipment and this manual use symbols used to warn of hazards. The symbols are explained below.

<b>Hazard Symbols</b>	
<b>Warnings and Cautions</b>	
	The exclamation point within the triangle is a warning sign alerting you of important instructions in the instrument's technical reference manual.
	The lightning flash and arrowhead within the triangle is a warning sign alerting you of "dangerous voltage" inside the product.
 	Pinch point. These symbols warn you that your fingers or hands will be seriously injured if you place them between the moving parts of the mechanism near these symbols.
<b>Symboles de sécurité</b>	
	Ce symbole signale l'existence d'instructions importantes relatives au produit dans ce manuel.
	Ce symbole signale la présence d'un danger d'électrocution.
 	Risque de pincement. Ces symboles vous avertit que les mains ou les doigts seront blessés sérieusement si vous les mettez entre les éléments en mouvement du mécanisme près de ces symboles
<b>Warnungen und Vorsichtshinweise</b>	
	Das Ausrufezeichen in Dreieck ist ein Warnzeichen, das Sie darauf aufmerksam macht, daß wichtige Anleitungen zu diesem Handbuch gehören.
	Der gepfeilte Blitz im Dreieck ist ein Warnzeichen, das Sei vor "gefährlichen Spannungen" im Inneren des Produkts warnt.
 	Vorsicht Quetschgefahr! Dieses Symbol warnt vor einer unmittelbar drohenden Verletzungsgefahr für Finger und Hände, wenn diese zwischen die beweglichen Teile des gekennzeichneten Gerätes geraten.

# 730 Bubbler Module

---

## *Table of Contents*

### **Section 1 Introduction**

---

1.1 Introduction . . . . .	1-1
1.2 Connecting to the Sampler . . . . .	1-2
1.3 Installation Checklist . . . . .	1-2
1.4 Calibrating the Bubbler Module. . . . .	1-2
1.5 Power Consumption . . . . .	1-2
1.6 General Mounting Considerations for the Bubbler. . . . .	1-3
1.6.1 Line Length . . . . .	1-3
1.6.2 Attach the Bubble Line to the Module . . . . .	1-3
1.6.3 Bubble Line Position in the Stream . . . . .	1-3
1.6.4 Bubble Line Extensions . . . . .	1-4
1.6.5 Installing the Bubble Line in a Primary Device . . . . .	1-4

### **Section 2 Programming the Module**

---

2.1 Module Screens . . . . .	2-1
2.2 Programmed Enable . . . . .	2-1
2.3 Data Storage . . . . .	2-1
2.3.1 Recovering Module Data . . . . .	2-1
2.4 Operation of the Bubbler System. . . . .	2-6
2.4.1 Purges . . . . .	2-6
2.4.2 Automatic Drift Compensation . . . . .	2-6
2.5 Alternative Flow Measurement Systems. . . . .	2-7

### **Section 3 Installation Methods**

---

3.1 Installation in Round Pipes . . . . .	3-1
3.1.1 Flow Metering Inserts . . . . .	3-1
3.1.2 Spring Rings . . . . .	3-2
3.1.3 Scissors Rings . . . . .	3-3
3.1.4 Street Level Installation System . . . . .	3-5
3.2 Other Installation Methods . . . . .	3-5
3.2.1 Rectangular, Trapezoidal, and Earthen Channels . . . . .	3-5
3.2.2 U-Channels . . . . .	3-5
3.2.3 Non-Standard Installations . . . . .	3-5

### **Section 4 Maintenance**

---

4.1 Desiccant Reactivation . . . . .	4-1
4.2 Hydrophobic Filter . . . . .	4-2
4.3 Bubble Line Maintenance. . . . .	4-2
4.4 Repairing The Module. . . . .	4-2
4.5 Flash Memory and Software Upgrades . . . . .	4-2

### **Appendix A Accessories List**

---

## Appendix B Technical Specifications

---

## Appendix C Material Safety Data Sheets

---

### *List of Figures*

---

1-1 730 Module Mounted on Sampler .....	1-1
2-1 Sample Reports .....	2-2
2-2 Sampler Programming: 730 Module Screens .....	2-3
2-3 Sampler Programming: 730 Module Setup Screens .....	2-4
2-4 Sampler Programming: 730 Module Quick View Screens .....	2-5
3-1 Spring Ring (6 to 15 inches) .....	3-2
3-2 Scissors Ring Adjustment .....	3-4
3-3 Bubbler Carrier Mounted on Scissors Ring .....	3-5
3-4 Typical installation methods .....	3-6

### *List of Tables*

---

2-1 Flow Conversion Types .....	2-7
A-1 Parts and Accessories .....	A-1
B-1 Technical Specifications for the 730 Bubbler Module .....	B-1



# 730 Bubbler Module

## *Section 1 Introduction*

### 1.1 Introduction

The 730 Bubbler Module is one of Teledyne Isco's interchangeable modules for the Avalanche and 6700 Series Samplers. The module uses a differential pressure transducer and a flow of bubbles to measure liquid levels up to ten feet. The bubbler is unaffected by wind, fluctuations in air or liquid temperatures, turbulence, steam, foam on the surface, corrosive chemicals, debris, oil, floating grease, or lightning.

You can install the module only on a 6712 or 6700 controller. The bubble line can be used in nearly any location with a known level-to-flow relationship.

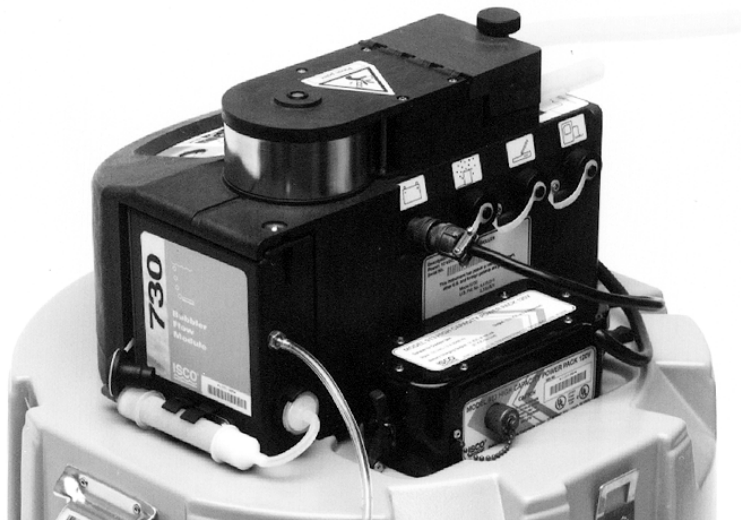

*Figure 1-1 730 Module Mounted on Sampler*

### **⚠ WARNING**

**The module has not been approved for use in hazardous locations as defined by the National Electrical Code. Installation of this module in a hazardous location may cause fire or explosion resulting in death, personal injury, or property damage. Before installing any device in a dangerous location, review safety precautions in your sampler manual. Check applicable guidelines, codes and regulations of federal, state, city, and county agencies.**

## 1.2 Connecting to the Sampler

To install the module:

1. Turn the sampler off.
2. Remove the connector cap in the module bay and move it aside.
3. Slide the module into the bay.
4. Push against the module to be sure the connector is fully seated.

To remove the module:

1. Turn the sampler off.
2. Press the silver button on top of the module and pull the module from the bay.
3. Replace the connector cap in the module bay.

## 1.3 Installation Checklist

1. Check the desiccant cartridge. Make sure the desiccant is active (blue in color) and **remove the red cap**.
2. Install the module and turn the sampler on.
3. Install the bubble line in the flow stream.
4. Connect the bubbler line to the module.
5. Program the sampler and calibrate the module's level reading.
6. Run the program.

### **Note**

You should install the module before turning the controller on. When the controller is turned on, it looks for a module. The controller will not recognize a newly installed module if it is not seen during this power-up routine. If you install a module while the controller is already on, turn the controller off and then on again to reconfigure the controller to use with the module.

## 1.4 Calibrating the Bubbler Module

After the sampler, module, and bubble line have been installed at the site, calibrate the module by measuring the depth of the water and adjust the reading to match.

It is possible to calibrate the module in a container of water. Use a bubble line of the same length as the one at the installation site to get an accurate and reliable calibration.

## 1.5 Power Consumption

The 730 Module consumes a considerable amount of power. A nickel-cadmium battery may not be sufficient to finish a sample routine. For example, the battery should be expected to complete three sampling routines of 24 samples, each sample 200 ml, at one sample per hour with a 10 foot suction line and a 5 foot head. But if the routine is changed to 24 samples, 4 samples per bottle, each sample 250 ml, at 15 minute intervals, with the same suction line and head height, *the battery does not have the capacity to complete one routine*. Teledyne Isco recommends using a lead-acid battery or a 913 or 923 power pack when using the 730 Bubbler Module.

## 1.6 General Mounting Considerations for the Bubbler

This section contains some general information regarding the installation of the 730 module. More detailed installation information can be found in Section 3 Installation Methods.

### 1.6.1 Line Length

A standard 25 foot (7.6 m) length of  $\frac{1}{8}$ " (0.32 cm) ID vinyl line is shipped with the module. We recommend that you do not use lengths longer than 25 feet. Please consult with the factory if your installation requires a nonstandard setup.

Cut the bubble line to the shortest usable length. This will minimize friction head effects in the line and also will reduce the amount of line exposed to cuts, kinks, etc. This will also improve the response time to changing levels and make the purge more effective.

The bubble line should be routed and secured so that it does not disturb the flow. Do not kink the tubing or restrict the airflow by over-tightening the mounting hardware.

### 1.6.2 Attach the Bubble Line to the Module

The vinyl bubble line attaches directly to the barbed fitting. Simply push the tubing over the fitting.

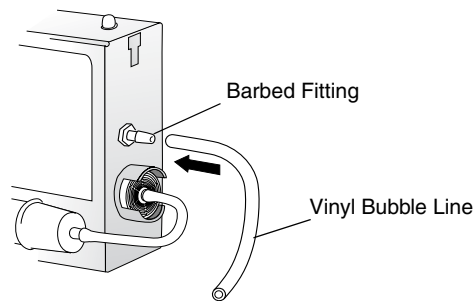

### 1.6.3 Bubble Line Position in the Stream

The bubble line outlet does not need to be at the bottom of the stream. In fact, positioning the bubble line outlet above the bottom can be beneficial if the stream carries large amounts of solids or is subject to silting.

The simplest installation method attaches the bubble line to the side of the flow stream with the bubble line outlet positioned below the lowest expected level.

To measure the liquid level down to the actual "zero" level of the primary device, Teledyne Isco recommends placing the bubble line outlet at least 1 to 2 inches (2.5 to 5.1 cm) **below** the primary device "zero" level to avoid measurement failures when the liquid level is even with the outlet. *The module cannot accurately measure levels that are even with or below the bubble line outlet.*

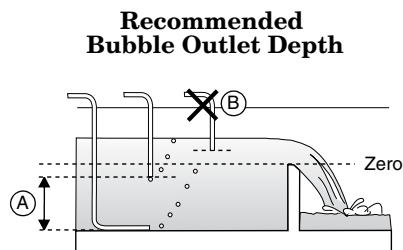

- A. The recommended depth ranges from the bottom to 1 inch below the zero level.
- B. This position would be unable to measure low levels through the primary device.

#### 1.6.4 Bubble Line Extensions

For some applications, a stainless steel tube may be easier to install in the flow stream than the plastic bubble line because of its relative rigidity. The vinyl bubble line attaches by simply slipping the vinyl tube over the end of the extension. Contact your Teledyne Isco representative about purchasing a stainless steel bubble line extension.

A copper extension to the bubble line is advantageous in applications where algae tends to grow in the bubble line. The copper salts released by the tubing are algicides that tend to inhibit the growth of algae. However, the copper tubing may not be compatible with the flow stream. Attach the copper bubble line extensions to the bubble line in the same way as the stainless steel extensions.

#### 1.6.5 Installing the Bubble Line in a Primary Device

Primary devices such as weirs or flumes will usually specify a head (level) measurement point. It is important to place the bubble line outlet at this point to convert levels to flow rates correctly. For more details about locating the head measurement point, refer to the *Isco Open Channel Flow Measurement Handbook*, or to information provided by the primary device manufacturer.

**Flume Bubble Line Fittings** – Because of the variety of primary measuring devices and installations, no comprehensive bubble line installation instructions are practical. However, there are valid general observations on bubble line installation that can be made. You can have most flumes specified to include a bubbler fitting. In new construction, this is highly recommended. It may even be possible to modify an existing installation to include a permanent bubbler fitting.

**Stilling Wells** – If the primary device includes a stilling well, you should install the bubble line in the stilling well. However, not all stilling wells are suitable for bubble line installation. If the well is subject to silting or buildup of foreign material, you should probably avoid it and mount the bubble line in the flow stream proper.

**Open Channel Installation** – Attach the bubble line to the side of the flow channel or flume. Make the attachment so it causes a minimum amount of disturbance to the flow stream. If possible, cut a groove in the side of the channel, place the bubble line in the groove, and then grout over the groove.

Alternately, you can attach the bubble line to the side of the channel, and then grout over the line to form smooth, sloped lead-in and lead-out surfaces. However, you may simply attach the bubble line to the side of the channel or the upstream side of a weir.

 <b>Note</b>
---

When installing the bubble line in a high-velocity flow stream (exceeding 5 ft/sec or 1.5 m/sec), please consult with the Teledyne Isco Customer Service Department for recommendations.

# 730 Bubbler Module

---

## *Section 2 Programming the Module*

### 2.1 Module Screens

When the controller is configured with the module, it adds the necessary screens for programming. The screens appear on the following pages in Figures 2-2 through 2-4. These figures outline the steps for module programming and calibration. For 6712 programming and general programming information refer to the sampler manual.

### 2.2 Programmed Enable

When the 730 Module is installed, additional sampler enable options are available. If programmed for LEVEL ONLY the option will be LEVEL. If programmed for FLOW METER the options will be LEVEL and FLOW. For more information about programmed enables, refer to the sampler manual.

### 2.3 Data Storage

When the sampler is configured for use with the module, a memory partition is reserved. The module readings are stored in this sampler memory partition. For more information on data storage and partition management, see the sampler manual.

#### 2.3.1 Recovering Module Data

The stored module data can be collected or viewed as “reports.” Three of the sampler reports contain module information, and are shown in Figure 2-1. Refer to the Sampler Instruction Manual for collecting and reading the reports.

 <b>Note</b>
---

An \* (asterisk) appears next to the reading if the module was unable to take a reading. If an asterisk appears, the reading displayed is the last available reading.



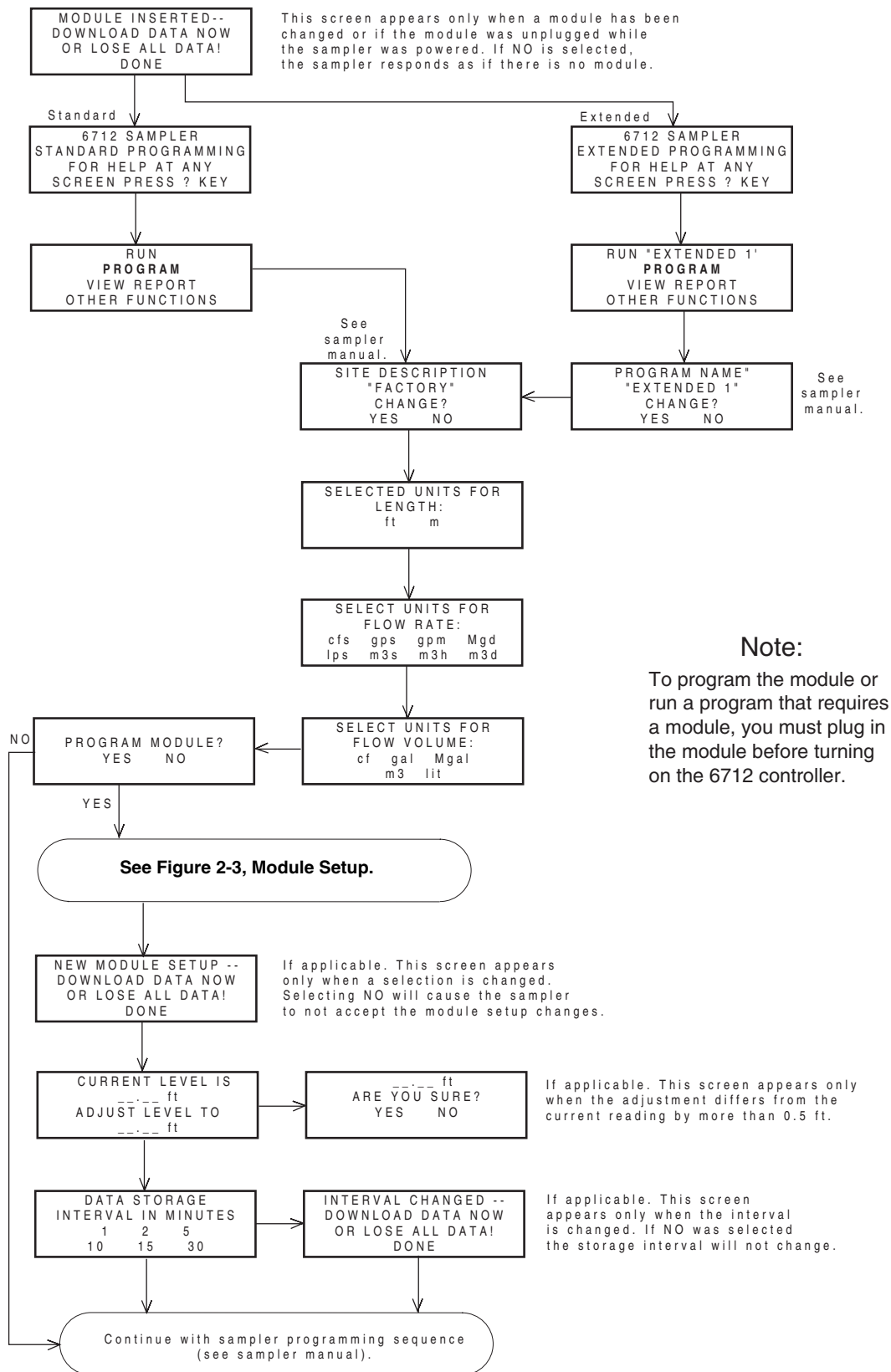

**Note:**

To program the module or run a program that requires a module, you must plug in the module before turning on the 6712 controller.

Figure 2-2 Sampler Programming: 730 Module Screens

730 Bubbler Module  
 Section 2 Programming the Module

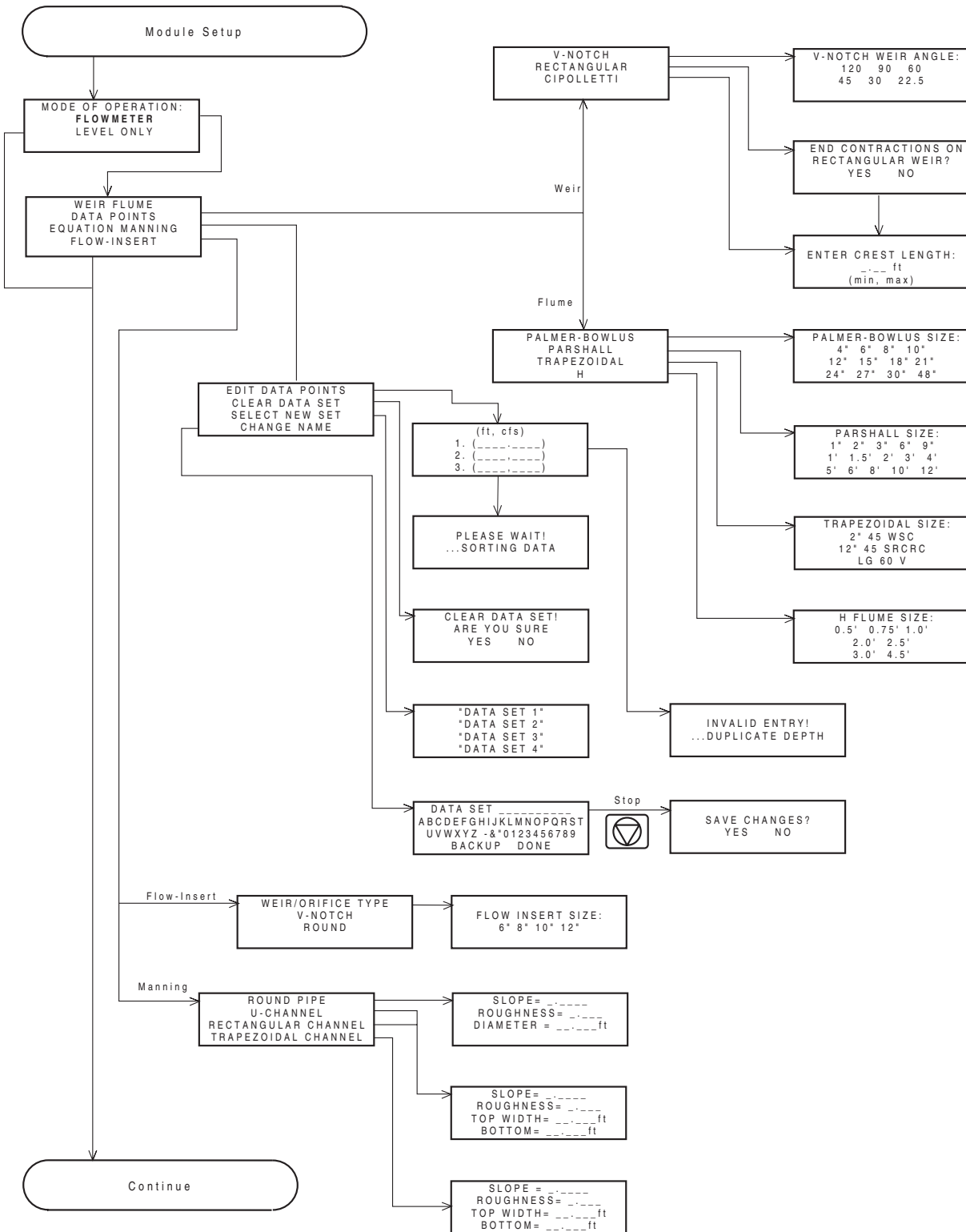

Figure 2-3 Sampler Programming: 730 Module Setup Screens



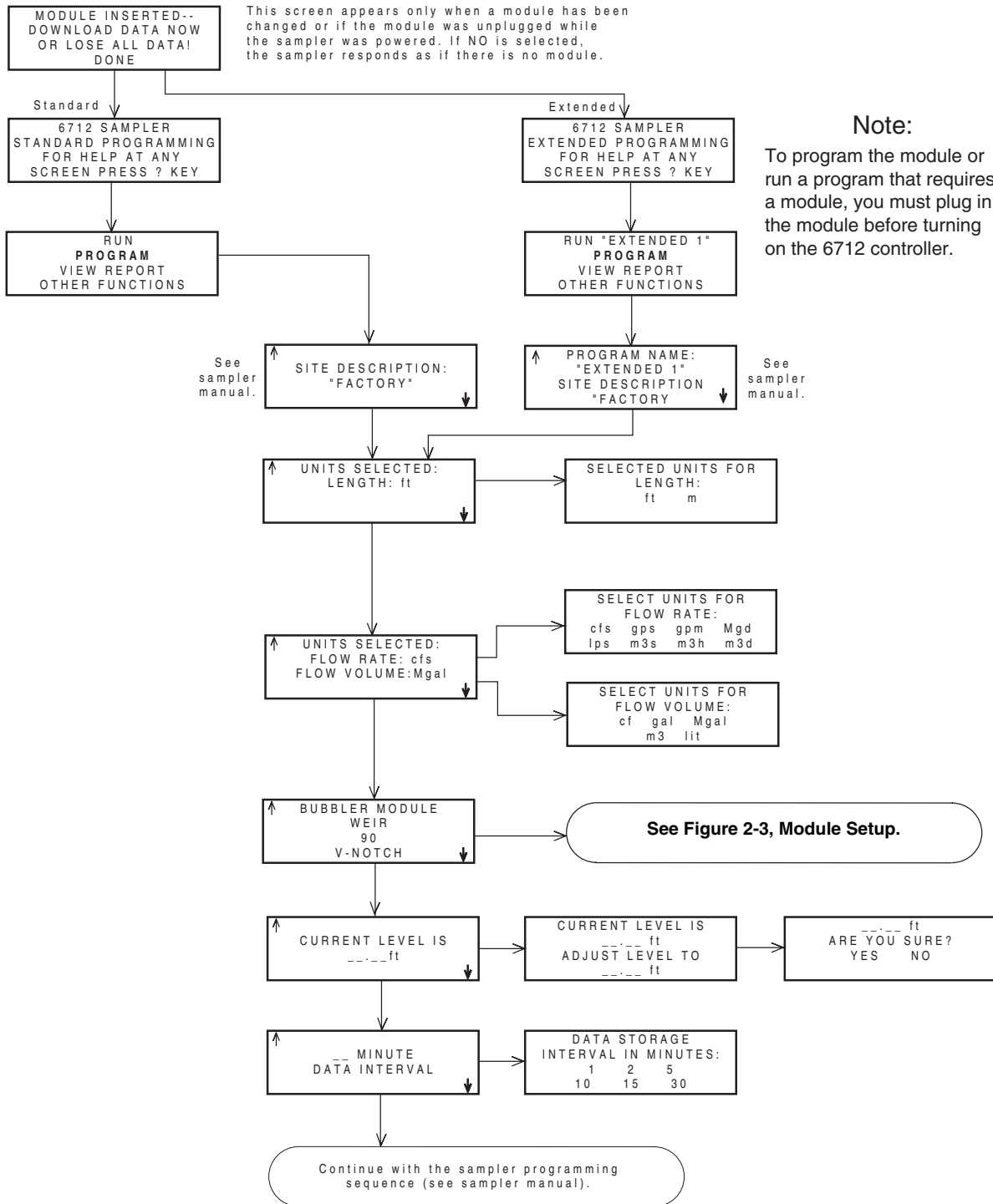

Figure 2-4 Sampler Programming: 730 Module Quick View Screens

## 2.4 Operation of the Bubbler System

When measuring flow rate, the module is used with a primary measuring device (typically a weir or a flume) or other open channel flow arrangement where a known relationship exists between level and flow rate (refer to Table 2-1 Flow Conversion Types). The level measuring device is a bubbler which measures the liquid level in the flow stream. The level reading is converted into a properly scaled flow rate value.

The module contains microprocessor-controlled circuitry to calculate level from the signals produced by the pressure transducer, and communicate with the 6712 controller.

The module's bubbler system works as follows: A small compressor pumps air into a reservoir. This air is slowly released by an orifice into a bubble line. The other end of this tube is submerged in the flow stream. Inside the module, the bubble line also connects to one side of a differential pressure transducer. As air is released slowly into the bubble line by the orifice, pressure builds inside the line to force the air out of the line into the flow stream. When there is enough pressure to counteract the hydrostatic pressure of the flow stream, a bubble will be forced from the end of the line. The amount of pressure required to force the bubble from the end of the line is directly dependent on the hydrostatic pressure of the flow stream over the end of the bubble line.

The pressure transducer inside the module senses this pressure and converts it into an electrical signal that the module converts into level. The 6712 controller then calculates flow rate and total flow from the level measurement and lookup tables for the primary device you are using.

The module produces the pressurized air supply, regulates the rate of air to the bubbler tube, measures the pressure in the bubbler tube, purges the air line, compensates for drift, and other functions.

### 2.4.1 Purges

Periodically, the module releases a high pressure, unregulated burst of air directly into the bubble line. This is done to clear the line and prevent any buildup of debris at the bubble line outlet.

### 2.4.2 Automatic Drift Compensation

The module measures the output of the pressure transducer at zero pressure. When the module is first turned on, and every 15 minutes after that, the processor actuates the automatic drift compensation valve, which connects the input port of the pressure transducer to the reference port. With the two ports connected, it then measures the output offset.

The module stores this offset reading in memory and uses it in level calculations. The repetition of this process causes any pressure transducer or amplifier drift to cancel out, eliminating the most significant cause of drift, especially when operating at low water levels.

The following table contains programming information for each of the conversion types.

Table 2-1 Flow Conversion Types		
Conversion Type	Device, Formula, or Table	Size or Parameters
Weir	V- Notch Weir	22.5, 30, 45, 60, 90, 120 degrees
	Rectangular Weir with End Contractions	Crest length
	Rectangular Weir without End Contractions	Crest length
	Cipoletti Weir	Crest length
Flume	Palmer-Bowlus Flume	4, 6, 8, 10, 12, 15, 18, 21, 24, 27, 30, 48 inches
	Parshall Flume	1, 2, 3, 6, 9 inches 1, 1.5, 2, 3, 4, 5, 6, 8, 10, 12 feet
	Trapezoidal Flume	Large 60-degree V 2-inch, 45-degree WSC 12-inch, 45-degree SRCRC
	"H" Flume	0.5, 0.75, 1, 1.5, 2, 2.5, 3, 4.5 feet.
Equation	$Q = a \times H^{b+c} \times H^d$	Q = flow H = head a, b, c, & d = entered values
Data Points	User-developed tables for level-to-flow rate. Includes data points from a user derived flow profile.	3 to 50 data points
Manning Equation	Round Pipe	Slope, Roughness, Diameter
	U-Channel Pipe	Slope, Roughness, Width
	Rectangular Pipe	Slope, Roughness, Width
	Trapezoidal	Slope, Roughness, Bottom Width, Top Width
Flow Metering Insert	V-Notch	6, 8, 10, 12 inch
	Round	6, 8, 10, 12 inch

## 2.5 Alternative Flow Measurement Systems

Because of the characteristics of bubbler flow measurement, there may be some installations where the bubbler method is either unreliable or inaccurate. In these instances, it is worthwhile to consider using an alternate method of flow measurement.

In addition to the 730 Module, Teledyne Isco offers three other types of plug-and-play flow modules in the 700 Series: the 720 Submerged Probe Module, the 710 Ultrasonic Module, and the 750 Area-Velocity Module.

Information about these flow modules is available from the factory. Call for more information or visit our Web site at [www.isco.com](http://www.isco.com).



# 730 Bubbler Module

---

## Section 3 Installation Methods

The bubble line may be installed in many different channel types, which are summarized here. For more detailed information about mounting options, consult your *Isco Mounting Rings Installation and Operation Guide*. See Figure 3-4 for examples of the mounting methods described in this section.

### 3.1 Installation in Round Pipes

Teledyne Isco offers four systems for installing bubble line in round pipes:

- Flow Metering Inserts
- Isco Spring Rings  
(for pipe diameters of 15 inches or less)
- Scissors Rings  
(for pipe diameters from 16 to 80 inches)
- Street Level Installation System

#### 3.1.1 Flow Metering Inserts

Flow metering inserts are available for use with the module that you can *temporarily* install inside round pipe sewers and flow streams to create a primary device inside the pipe. These inserts are available to fit 6", 8", 10", and 12" pipes and install from street level.

The inserts create a restriction in the flow stream and may cause clogging. Where this could be a problem, we suggest using one of the other three installation systems instead.

Because the flow metering inserts are installed from street level, it is not possible to measure the level. Instead, you must set the level to zero before installing the flow metering insert in the pipe. Set the level to zero using the following instructions:

1. Install the module in the Sampler and **remove the red cap from the desiccant cartridge**.
2. Assemble the flow metering insert to the length that will be installed.
3. Attach the bubble line to the module. **The inside of the bubble line must be dry and unobstructed.**
4. Turn on the sampler and wait 2 to 3 minutes to allow the bubbler's air system to stabilize.
5. Select Program from the sampler's main menu and step through the screens until the "Current Level" screen appears. (Detailed programming instructions appear in the sampler manual.)
6. Adjust the level to read zero (0.00 feet or meters).

You may exit the programming after setting the current level to zero. When you install the flow metering insert, the bubbler module will then provide liquid level readings based on this zero level.

7. Proceed with installing the insert into the pipe.

### 3.1.2 Spring Rings

**Consult your Isco Mounting Rings instruction manual for detailed hardware information.**

Stainless steel spring rings simplify probe installation in 6 to 15 inch round pipes. Teledyne Isco offers five diameter sizes: 6, 8, 10, 12, and 15 inches (15.2, 20.3, 25.4, 30.5, and 38 cm). A typical spring ring is shown in Figure 3-1.

This self-expanding device compresses to slide into a pipe. When released, the ring secures itself against the wall with an inherent outward force.

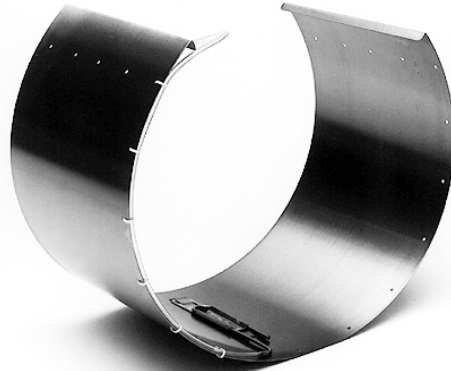
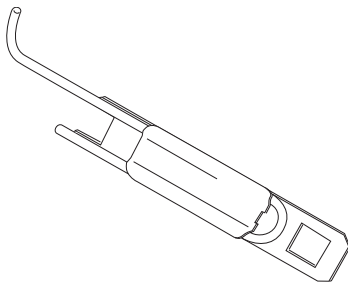

Figure 3-1 Spring Ring (6 to 15 inches)



Bubble Line Carrier

#### Preparing the Spring Ring:

First attach the bubble line to the bubbler carrier assembly (contact your Teledyne Isco representative to purchase the bubbler carrier). Then fit the carrier onto the mounting tabs of the ring, making sure the tabs completely engage the slots in the carrier. This method of attaching the bubble line to the ring allows for easy removal in case service is needed later.

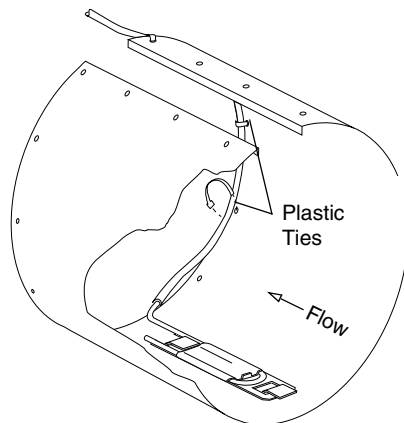

**Spring Ring Preparation**

Route the vinyl bubble line away from the carrier and along the spring ring's edge with holes. Secure the line in position by placing plastic ties through the holes and then locking them around the line. To prevent debris from collecting, attach the line so that it offers as little resistance to the flow as possible. Avoid loops or slack sections. Attach it neatly and closely to the spring ring.

#### **Installing the Spring Ring:**

After the bubble line and carrier have been attached to the spring ring, the actual installation procedure is fairly simple. First, lower the spring ring assembly into the area of the pipe. Next, grasp the spring ring and compress it into a tight circle. Then push the ring up into the pipe the desired distance.

When you have the ring positioned, release the ring, allowing it to expand outward. It may be necessary to rotate the ring to position the bubble line outlet in the bottom center of the pipe. This completes the installation.

Under conditions of high velocity (greater than five feet per second or 1.5 meters per second), the spring ring may not have sufficient outward force to keep it tight against the pipe. The flow could lift the ring off the bottom of the pipe, or even carry it downstream.

This problem is more prevalent in the larger diameter pipes (10, 12, and 15 inch) and in pipes with a smooth inner surface (plastic, for example). If any of these conditions are present, or if movement of the spring ring is detected or suspected, you must anchor the ring in place. You can do this by shooting studs through the ring into the pipe or by other appropriate means. In some cases, it may be sufficient to increase the outward force of the ring by bending it into a less rounded shape.

### **3.1.3 Scissors Rings**

#### **Consult your Isco Mounting Rings instruction manual for detailed hardware information.**

For pipes larger than 15" in diameter, Teledyne Isco offers the adjustable Scissors Ring (also known as the Universal Mounting Ring). This device consists of two or more metal strips that lock together with tabs to form a single assembly. There is a base section where the sensors are mounted, one or more extension sections (usually), and a scissors section at the top that expands the entire assembly and tightens it inside the pipe. The scissors mechanism includes a long screw that increases the width as it is tightened.

The assembled rings fit pipe diameters from 16" to 80". Secure the unit in place by tightening the scissors mechanism with a  $\frac{5}{8}$ " socket wrench or other suitable tool. Ring sections are .040" thick half-hard 301 stainless steel sheet. All other parts are also stainless steel, except for the plastic cable ties in the hardware kit.

Each extension, 1, 2, 3, and 4, adds 9.0", 21.5", 31.5", or 41.5", respectively, to the circumference of the ring. Used alone, the base section fits pipe that is approximately 16" to 18" in

diameter. The 9.0" (the smallest) extension exists so that in larger pipe sizes, where large variations in circumference can occur, you can use one or two of these extensions to take up or remove slack, to bring the scissors mechanism into a position where it can be effectively tightened.

Mounting ring kits are available for different pipe sizes. A kit is also available for partial pipe applications (see your *Isco Mounting Rings Installation and Operation Guide*). For a listing of part numbers and ordering information, see Appendix A.

To prevent debris from catching on the cable, it is important to attach the cable to the mounting ring so it offers as little resistance to the flow as possible. Attach the sensor cable to the downstream edge of the ring, using the self-locking plastic ties supplied with the ring. Place the ties through the holes in the edge of the mounting ring and then lock them around the cable.

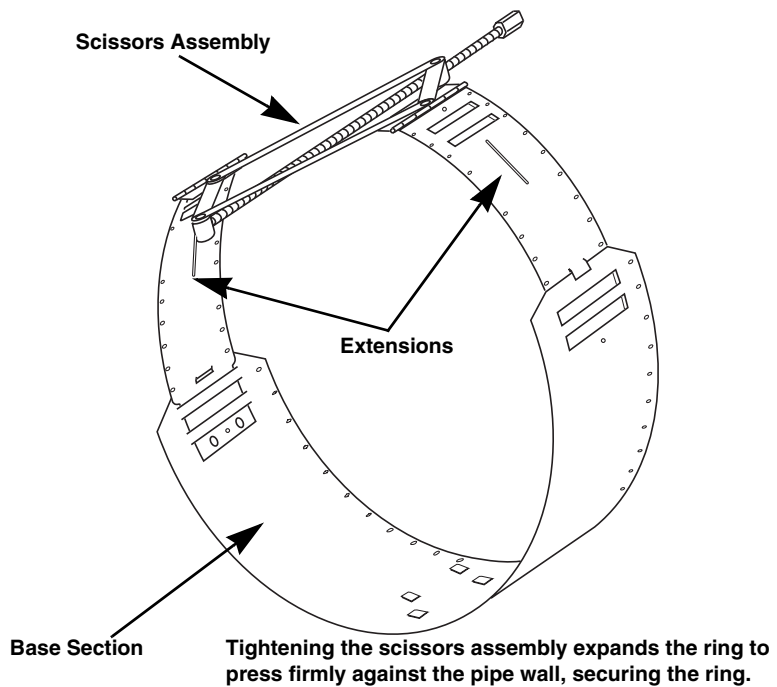

Figure 3-2 Scissors Ring Adjustment





Figure 3-3 Bubbler Carrier Mounted on Scissors Ring

#### 3.1.4 Street Level Installation System

The Street Level Installation System provides a way to install the probe in a round pipe without entering a manhole. This system uses multi-section poles and expansion rings that fit 6, 8, 10, 12, and 15 inch round pipes in manholes as deep as 15 feet. The system includes an instruction manual.

### 3.2 Other Installation Methods

Teledyne Isco's mounting hardware can be installed or adapted for use in many channels. The paragraphs below list additional bubble line installation methods.

#### 3.2.1 Rectangular, Trapezoidal, and Earthen Channels

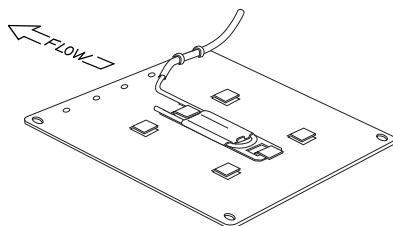

Sensor Mounting Plate

Teledyne Isco offers the Sensor Mounting Plate for these channels. The stainless steel plate has tabs to mount up to three sensors. The bubble line carrier also attaches to the tabs (see figure in the left margin). It is secured in concrete channels by driving studs into the channel bottom and bolting the plate to the studs. In an earthen channel, the plate can be held in place by driving in stakes.

#### 3.2.2 U-Channels

It is possible to mount the bubble line retainer in a U-channel with a scissoring ring base section. Attach the base section to the channel wall with studs fired from a power-activated stud gun. Consult the factory for more information, if you must mount the bubble line in a U-channel.

#### 3.2.3 Non-Standard Installations

If you are not using a primary device, or if your primary device is not listed in Figure 3-4, please consult with the Teledyne Isco Customer Service Department for installation recommendations.

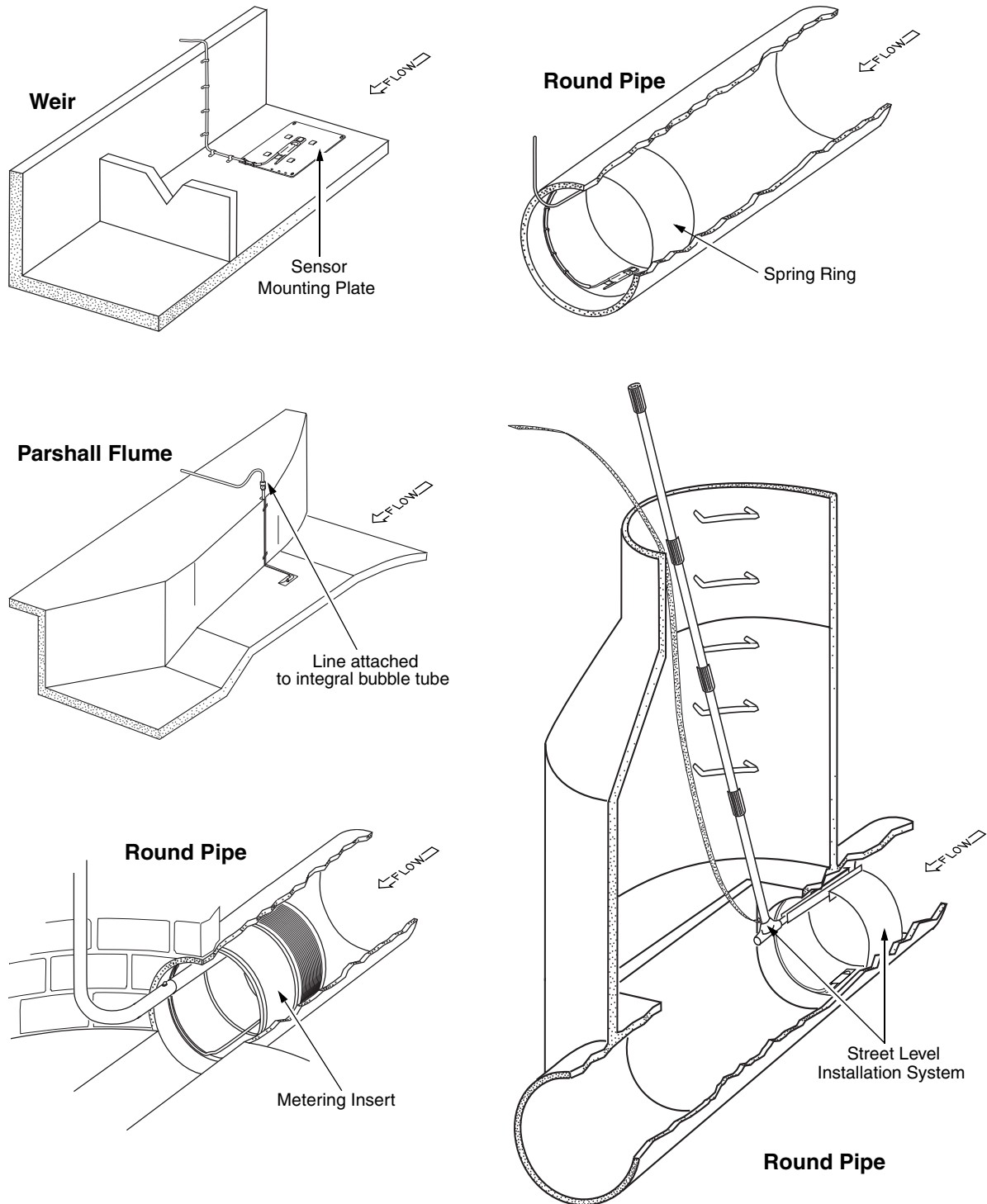

Figure 3-4 Typical installation methods

# 730 Bubbler Module

## Section 4 Maintenance

The 730 Bubbler Module has no user serviceable parts. It is completely sealed to protect the internal components. If you think the module requires repair, contact Teledyne Isco's Customer Service Department.

### 4.1 Desiccant Reactivation

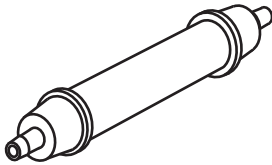

A cartridge on the side of the module dries the air inside the module and probe reference line. It contains a silica gel desiccant with a color indicator that changes from blue to pink, or yellow to green, when saturated. Pink or green desiccant cannot remove moisture and must be replaced or reactivated.

A saturated desiccator will let moisture into the bubbler system, which can cause several undesirable effects, including:

- The moisture may block internal tubing and cause reading errors.
- The air in many installations contains fumes that will form acids in the presence of moisture. These acids may corrode internal components.
- At temperatures near or below freezing, there could be permanent damage if ice forms inside the air pump.

To reactivate the desiccant, pour the desiccant out of the cartridge into a heat-resistant container. Never heat the plastic cartridge; it will melt. Heat the silica gel in a vented convection oven at 212° to 350° F (100° to 175° C) for two to three hours, or until the blue or yellow color returns. Allow the desiccant to cool and then refill the cartridge.

#### CAUTION

Desiccant may produce irritating fumes when heated. Observe the following precautions:

- Use a vented oven in a well-ventilated room.
- Do not remain in the room while the regeneration is taking place.
- Use the recommended temperature. Avoid heating the desiccant at higher than recommended temperatures.

The desiccant's ability to remove moisture may lessen with each saturation/reactivation cycle, resulting in a need for more frequent service. After several cycles, the desiccant may no longer be effective as it saturates too quickly. At this point, replace the desiccant.

The filters in the end caps keep small pieces of the desiccant material from falling out of the cartridge. When the filters become soiled, clean with dish soap and water, then allow to dry.

## 4.2 Hydrophobic Filter

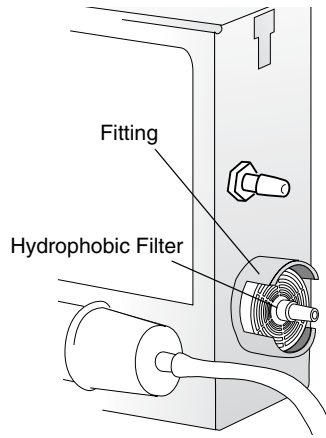

The hydrophobic filter prevents water from entering the module. Any amount of water will plug the filter. If the filter becomes plugged replace it.

To remove the filter, turn it counterclockwise while making sure the black fitting does not rotate.

Replacement hydrophobic filters, Isco P/N 60-2005-003, are available from Teledyne Isco.

## 4.3 Bubble Line Maintenance

Periodically inspect the bubble line to make sure that it has not become kinked or damaged in any way. If you find damage to the bubble line, replace it. A leaking or obstructed line will cause inaccurate level readings and lower battery life. (The pump must run more frequently.) If you need to replace the bubble line, install a new line the same way you installed the original. Generally, the new line should be the same length as the old.

If you replace the bubble line or if you change the outlet either by cutting off the tip or by installing a bubble line extension, you must recalibrate the level.

Inspect the outlet of the bubble line regularly for any signs of clogging. Sediment or debris from the flow stream and algae can all clog the line. If the line is blocked, you can either clean it out, or simply cut off the tip.

If algae growth is a problem, consider using a copper bubble line extension. The copper salts formed on a copper line will prevent algae growth.

## 4.4 Repairing The Module

The module has no user-serviceable parts. Its case is completely sealed to protect the internal components. To repair the unit, the case must be broken open and replaced. If you think your module requires repair, contact Teledyne Isco's Customer Service Department for information on returning it to the factory.

## 4.5 Flash Memory and Software Upgrades

The module has Flash memory to store its software. With Flash technology, you can upgrade your module's software without sending it back to the factory or replacing a chip.

To update the module software, install the module in a 6712 sampler. Then connect the sampler power source and turn the sampler on. Connect the sampler to a computer and follow the instructions received with your Flash Update program.

# 730 Bubbler Module

## Appendix A Accessories List

The following table contains information about replacement parts and accessories. Replacement parts and accessories can be purchased by contacting Teledyne Isco's Customer Service Department.

<b>Table A-1 Parts and Accessories</b>	
<b>Part Description</b>	<b>Part Number</b>
730 Bubbler Module <i>(includes module, bubble line, and manual)</i>	60-6700-050
Bubble Line 25'	60-9003-281
Bulk Bubble Line 100'	68-1700-003
4' SST Extension	60-1873-043
Bubbler Carrier Assembly	60-3204-007
Accessory Package <i>(includes desiccator cartridge and hydrophobic filter)</i>	60-9004-144
Replacement Hydrophobic Filter	60-2005-003
Isco Open Channel Flow Measurement Handbook	60-3003-041
Spring Ring - 6" Dia.	68-3200-007
Spring Ring - 8" Dia.	68-3200-008
Spring Ring - 10" Dia.	68-3200-009
Spring Ring - 12" Dia.	68-3200-010
Spring Ring - 15" Dia.	68-3200-011
<i>(Each spring ring includes plastic ties to fasten the bubble line.)</i>	
Scissors Ring for 16" - 23" Pipe	68-3000-042
Scissors Ring for 16" - 36" Pipe	68-3000-043
Scissors Ring for 39" - 43" Pipe	68-3000-044
Scissors Ring for 45" - 49" Pipe	68-3000-045
Scissors Ring for 58 to 62" Pipe	68-3000-046
Scissors Ring for 72" Pipe	68-3000-047
Scissors Ring for 16" - 80" Pipe	68-3000-048
<i>(Each scissors ring includes a base section, scissors mechanism, extensions, plastic ties, and installation instructions)</i>	
Mounting Ring Base Assembly <i>(Includes plastic ties and installation instructions)</i>	60-3004-169
Scissors Mechanism	60-3004-170
Pair of 7.5" Extensions for Scissors Ring	68-3000-038
Pair of 20" Extensions for Scissors Ring	68-3000-039

<b>Table A-1 Parts and Accessories (Continued)</b>	
<b>Part Description</b>	<b>Part Number</b>
Pair of 30" Extensions for Scissors Ring	68-3000-040
Pair of 40" Extensions for Scissors Ring	68-3000-041
Street Level Installation System Multi-Section Pole. <i>(Includes instruction manual. To complete your system, you must also order a Street Level Mounting Ring.)</i>	60-3204-012
Street Level Mounting Ring for 6" diameter pipe	60-3204-014
Street Level Mounting Ring for 8" diameter pipe	60-3204-015
Street Level Mounting Ring for 10" diameter pipe	60-3204-016
Street Level Mounting Ring for 12" diameter pipe	60-3204-017
Street Level Mounting Ring for 15" diameter pipe	60-3204-018
6" Metering Insert	68-3230-005
8" Metering Insert	68-3230-006
10" Metering Insert	68-3230-007
12" Metering Insert	68-3230-008
<i>(Metering inserts include poles, pump, hose, attachable 60 degree V-notch weir plate, and instruction manual.)</i>	
Probe Extension	68-3200-012
Sensor Mounting Plate	68-3000-051

# 730 Bubbler Module

## Appendix B Technical Specifications

The following table contains information covering the technical specifications of the 730 Module.

General Notes:

1. All weights may vary  $\pm 0.2$  lb ( $\pm 0.1$  kg).
2. All lengths may vary  $\pm 0.25$  inch ( $\pm 0.64$  cm).

**Table B-1 Technical Specifications for the 730 Bubbler Module**

Item	Specification
Weight	1.5 lbs. (0.7 kg)
Dimensions	4.9 x 5.7 x 2.0 inches (12.4 x 14.5 x 5.1 cm)
Material	Polystyrene
Operational Temperature	32° to 120° F (0° to 49° C)
Storage Temperature	0° to 140° F (-18° to 60° C)
Enclosure	NEMA 4X and 6, IP67
Power	Provided by the sampler.
Memory	Nonvolatile programmable Flash; can be field updated through the sampler.
Readings	Programmable through the sampler at 1, 2, 5, 10, 15, and 30 minute intervals.
Bubble Line	Vinyl: inside diameter: 1/8 " (0.32 cm) length: 25 feet (7.6 cm)
Range	0.010 ft (0.003 m) minimum water level above bubble outlet. 10 ft. (3.038 m) maximum water level above bubble outlet.
Level Measurement Accuracy	0.01 to 5.0 ft: 0.01 ft 0.01 to 10.0 ft: 0.035 ft 0.003 to 1.524 m: 0.003 m 0.003 to 3.048 m: 0.011 m Includes linearity, repeatability, and hysteresis at 77° F (25° C). Does not include the temperature coefficient. Level is the distance between the bubble outlet and the liquid surface.
Temperature Coefficient	0.01 to 5.0 ft: $\pm 0.0006$ x level in feet x temperature change from 77° F 0.01 to 10.0 ft: $\pm 0.0005$ x level in feet x temperature change from 77° F 0.003 to 1.524 m: $\pm 0.00108$ x level in meters x temperature change from 25° C 0.003 to 3.048 m: $\pm 0.0009$ x level in meters x temperature change from 25° C Temperature coefficient is the maximum error within the operating temperature range per degree of temperature change. Add to Level Accuracy.
Automatic Drift Correction	$\pm 0.002$ ft ( $\pm 0.0006$ m) at 15 minute intervals
Level Resolution	0.001 ft (0.0003 m)





# 730 Bubbler Module

---

## *Appendix C Material Safety Data Sheets*

This appendix provides Material Safety Data Sheets for the desiccant used by the 730 Bubbler Module.

Teledyne Isco cannot guarantee the accuracy of the data. Specific questions regarding the use and handling of the products should be directed to the manufacturer listed on the MSDS.

# Material Safety Data Sheet

Indicating Silica Gel

Identity (Trade Name as Used on Label)

Manufacturer : MULTISORB TECHNOLOGIES, INC. (formerly Multiform Desiccants, Inc.)	MSDS Number* : M75
Address: 325 Harlem Road Buffalo, NY 14224	CAS Number* :
Phone Number (For Information): 716/824-8900	Date Prepared: July 6, 2000
Emergency Phone Number: 716/824-8900	Prepared By* : G.E. McKedy

## Section 1 - Material Identification and Information

Components - Chemical Name & Common Names (Hazardous Components 1% or greater; Carcinogens 0.1% or greater)	%*	OSHA PEL	ACGIH TLV	OTHER LIMITS RECOMMENDED
Silica Gel SiO <sub>2</sub>	98.0	6mg/m <sup>3</sup> (total dust)	10mg/m <sup>3</sup> (total dust)	
Cobalt Chloride	>2.0	0.05mg/m <sup>3</sup> (TWA cobalt metal dust & fume)	.05mg/m <sup>3</sup> (Cobalt, TWA)	
Non-Hazardous Ingredients				
<b>TOTAL</b>	<b>100</b>			

## Section 2 - Physical/Chemical Characteristics

Boiling Point	N/A	Specific Gravity (H <sub>2</sub> O = 1)	2.1
Vapor Pressure (mm Hg and Temperature)	N/A	Melting Point	N/A
Vapor Density (Air =1)	N/A	Evaporation Rate (_____ =1)	N/A
Solubility in Water	Insoluble, but will adsorb moisture.	Water Reactive	Not reactive, but will adsorb moisture.
Appearance and Odor	Purple crystals, no odor.		

## Section 3 - Fire and Explosion Hazard Data

Flash Point and Methods Used	N/A	Auto-Ignition Temperature	N/A	Flammability Limits in Air % by Volume	N/A	LEL	UEL
Extinguisher Media	Dry chemical, carbon dioxide and foam can be used.						
Special Fire Fighting Procedures	Water will generate heat due to the silica gel which will adsorb water and liberate heat.						
Unusual Fire and Explosion Hazards	When exposed to water, the silica gel can get hot enough to reach the boiling point of water. Flooding with water will reduce the temperature to safe limits.						

## Section 4 - Reactivity Hazard Data

<b>STABILITY</b> <input type="checkbox"/> Stable <input type="checkbox"/> Unstable	Conditions To Avoid	Moisture and high humidity environments.
Incompatibility (Materials to Avoid)	Water.	
Hazardous Decomposition Products	Carbon dioxide, carbon monoxide, water	
<b>HAZARDOUS POLYMERIZATION</b> <input type="checkbox"/> May Occur	Conditions To Avoid	None.

\*Optional

Indicating Silica Gel

Section 5 - Health Hazard Data	
<b>PRIMARY ROUTES OF ENTRY</b>	<input type="checkbox"/> Inhalation <input type="checkbox"/> Ingestion <input type="checkbox"/> Skin Absorption <input type="checkbox"/> Not Hazardous
<b>HEALTH HAZARDS</b>	<b>CARCINOGEN LISTED IN</b> <input type="checkbox"/> NTP <input type="checkbox"/> OSHA <input type="checkbox"/> IARC Monograph <input type="checkbox"/> Not Listed Acute      May cause eye, skin and mucous membrane irritation. Chronic      Prolonged inhalation may cause lung damage.
Signs and Symptoms of Exposure	Drying and irritation.
Medical Conditions Generally Aggravated by Exposure	Asthma.
<b>EMERGENCY FIRST AID PROCEDURES</b> - Seek medical assistance for further treatment, observation and support if necessary.	
Eye Contact	Flush with water for at least 15 minutes.
Skin Contact	Wash affected area with soap and water.
Inhalation	Remove affected person to fresh air.
Ingestion	Drink at least 2 glasses of water.

Section 6 - Control and Protective Measures	
Respiratory Protection (Specify Type)	Use NIOSH approved dust mask or respirator.
Protective Gloves	Light cotton gloves.
Eye Protection	Safety glasses.
<b>VENTILATION TO BE USED</b>	<input type="checkbox"/> Local Exhaust <input type="checkbox"/> Mechanical (General) <input type="checkbox"/> Special <input type="checkbox"/> Other (Specify)
Other Protective Clothing and Equipment	None.
Hygienic Work Practices	Avoid raising dust. Avoid contact with skin, eyes and clothing.

Section 7 - Precautions for Safe Handling and Use/Leak Procedures	
Steps to be Taken if Material Is Spilled Or Released	Sweep or vacuum up and place the spilled material in a waste disposal container. Avoid raising dust.
Waste Disposal Methods	Dispose in an approved landfill according to federal, state and local regulations.
Precautions to be Taken In Handling and Storage	Cover promptly to avoid blowing dust. Wash after handling.
Other Precautions and/or Special Hazards	Keep in sealed containers away from moisture. The silica gel will readily adsorb moisture.

\*Optional

Indicating Silica Gel



## MATERIAL SAFETY DATA SHEET

**Effective Date** March 8, 2005  
**MSDS Number** M163

### Section 1 – Product and Company Information

**Product Name:** Silica gel, indicating, yellow

**Product Use:** Desiccant, absorbent

**Grades:** Silica gel, indicating

**Synonyms:** Amorphous silica gel, SiO<sub>2</sub>, silicon dioxide (amorphous)

**Company;** Multisorb Technologies, Inc.  
**Street Address:** 325 Harlem Road  
**City, State, Zip, Country:** Buffalo, NY 14224-1893 USA

**Telephone Number:** (716) 824 8900 [USA] Monday - Friday (8:00 - 5:00 EDT)

**Fax Number:** (716) 824 4091 [USA]

**Website / E-Mail :** multisorb.com

### Section 2 – Composition / Information on Ingredients

Component Name	CAS Number	% by Weight
Synthetic amorphous silica gel (SiO <sub>2</sub> )	112926-00-8	100
Phenolphthalein	77-09-08	100 ppm

While this material is not classified, this MSDS contains valuable information critical to the safe handling and proper use of this product. This MSDS should be retained and available for employees and other users of this product.

### Section 3 – Hazard Identification

**Emergency Overview:** A yellow bead or granular material that poses little or no immediate hazard. This material is not combustible.

**Potential Health Effects:**

**Eyes:** Dust and or product may cause eye discomfort and irritation seen as tearing and reddening.

**Skin:** The product dust may cause drying of the skin. Silica gel may get hot enough to burn skin when it adsorbs moisture rapidly. Use an excess of water to cool the silica gel.

**Ingestion:** Material is not toxic and will pass through the body normally.

**Inhalation:** Slight irritation is possible but none is expected.

**Medical Effects Generally Aggravated by Exposure:** Respiratory ailments.

**Chronic Effects/Carcinogenity:** May cause eye, skin and mucous membrane irritation and drying.

#### Section 4 – First Aid Measures

- Eyes:** Rinse the eyes well with water while lifting the eye lids. If irritation persists, consult a physician.
- Skin:** Wash affected area with soap and water.
- Ingestion:** Ingestion is unlikely, this material will pass through the body normally.
- Inhalation:** Remove the affected person to fresh air and get medical attention if necessary.
- Notes to Physician:** Not applicable

#### Section 5 – Fire Fighting Measures

- Flammable Properties:** Not flammable
- Flash Point:** Not applicable                      **Method:** Not applicable
- Flammable Limits:** Not flammable
- Lower Flammability Limit:** Not applicable
- Upper Flammability Limit:** Not applicable
- Autoignition Temperature:** Not applicable
- Hazardous Combustion Products:** Not applicable
- Extinguishing Media:** Use extinguishing media that is appropriate for the surrounding fire. Silica gel is not combustible.
- Fire Fighting Instructions:** Not combustible
- Unusual Fire and Explosion Hazards:** None

#### Section 6 – Accidental Release Measures

- Spill:** Sweep or vacuum up and place the spilled material in a waste disposal container. Avoid raising dust. Wash with soap and water after handling.

#### Section 7 – Handling and Storage

- Handling:** Avoid raising dust and minimize the contact between worker and the material. Practice good hygienic work practices.
- Storage:** Store in a cool, dry location. Keep in sealed containers away from moisture. The silica gel will readily adsorb moisture.

**Section 8 – Exposure Controls/Personal Protection**

- Engineering Controls:** Use exhaust ventilation to keep the airborne concentrations below the exposure limits.
- Respiratory Protection:** Use NIOSH approved respirator when the air quality levels exceed the TLV's.
- Skin Protection:** Light gloves will protect against abrasion and drying of the skin.
- Eye Protection:** Safety glasses.

Component Name	Exposure Limits		
	OSHA PEL	ACGIH TLV	Other Recommended Limits
Silica gel	TWA 20 mppcf (80 mg / m <sup>3</sup> % SiO <sub>2</sub> )	TWA 10 mg / m <sup>3</sup>	NIOSH REL TWA 6 mg / m <sup>3</sup> IDLH 3000 mg / m <sup>3</sup>
Phenolphthalein	Not Applicable	Not Applicable	Not Applicable

**Section 9 – Physical and Chemical Properties**

- Appearance:** Yellow beads or granules      **Vapor Density:** Not applicable
- Odor:** None      **Boiling Point:** 4046° F (2230° C)
- Physical State:** Solid bead      **Melting Point:** 3110° F (1710° C)
- PH:** Not applicable      **Solubility:** Insoluble in water
- Vapor Pressure:** Not applicable      **Specific Gravity:** 2.1

**Section 10 – Stability and Reactivity**

- Stability:** Stable
- Conditions to avoid:** Moisture and high humidity environments.
- Incompatibility:** Water, fluorine, oxygen difluoride, chlorine trifluoride
- Hazardous Decomposition Products:** None
- Hazardous Polymerization:** Will not occur

### Section 11 – Toxicological Information

This product and its components are not listed on the NTP or OSHA Carcinogen lists.

**Animal Toxicology** Tests for DOT Hazard classification  
( Tests Conducted on finely ground silica gel)  
1 - hour LC<sub>50</sub> (rat) > 2 mg / l  
48 - hour oral LD<sub>50</sub> (rat) est. > 31,600 mg / kg  
48 - hour dermal LD<sub>50</sub> (rabbit) est. > 2,000 mg / kg  
Considered an ocular irritant

**Human Toxicology** Silica gel is a synthetic amorphous silica not to be confused with crystalline silica. Epidemiological studies indicate low potential for adverse health effects. In the activated form, silica gel acts as a desiccant and can cause a drying irritation of the mucous membranes and skin in cases of severe exposure. Multisorb Technologies Inc. knows of no medical conditions that are abnormally aggravated by exposure to silica gel. The primary route of entry is inhalation of dust.

### Section 12 – Ecological Information

Not known to have any adverse effect on the aquatic environment. Silica gel is insoluble and non-toxic.

### Section 13 – Disposal Information

**Disposal Information** If this product as supplied becomes a waste, it does not meet the criteria of a hazardous waste as defined under the Resource Conservation and Recovery Act (RCRA) 40 CFR 261. Materials of a hazardous nature that contact the product during normal use may be retained on the product. The user of the product must identify the hazards associated with the retained material in order to assess the waste disposal options. Dispose according to federal, state and local regulations.

### Section 14 – Transportation Information

**U.S. Department of Transportation Shipping Name:** Not classified as a hazardous material. Not regulated.

### Section 15 – Regulatory Information (Not meant to be all inclusive - selected regulations represented)

**TSCA Listed:** Yes

**DSL/NDSL (Canadian) Listed:** Yes

**OSHA:** TWA 20 mppcf (80 mg / m<sup>3</sup> % SiO<sub>2</sub>) for Silica gel

**NIOSH:** REL TWA 6 mg / m<sup>3</sup> IDLH 3,000 mg / m<sup>3</sup> for silica gel  
Animal tests conducted in 1976 - 1978. 18 month exposure at 15 mg / m<sup>3</sup> showed silica deposition in respiratory macrophages and lymph nodes, minimum lung impairment, no silicosis.

**ACGIH:** TLV - 10 mg / m<sup>3</sup> for Silica gel

**DOT:** Not classified as a hazardous material.

**Section 16 – Other Information**

**HMIS – Hazardous Materials Identification System**

HMIS Rating	
Health	0
Flammability	0
Reactivity	0

**0 - minimal hazard, 1 - slight hazard, 2 - moderate hazard, 3 - serious hazard, 4 - severe hazard**

This MSDS was prepared by: George E. Mckedy  
Senior Applications Development Specialist  
Multisorb Technologies, Inc.

This data and recommendations presented in this data sheet concerning the use of our product and the materials contained therein are believed to be correct but does not purport to be all inclusive and shall be used only as a guide. However, the customer should determine the suitability of such materials for his purpose before adopting them on a commercial scale. Since the use of our products is beyond our control, no guarantee, expressed or implied, is made and no responsibility assumed for the use of this material or the results to be obtained therefrom. Information on this form is furnished for the purpose of compliance with Government Health and Safety Regulations and shall not be used for any other purposes. Moreover, the recommendations contained in this data sheet are not to be construed as a license to operate under, or a recommendation to infringe, any existing patents, nor should they be confused with state, municipal or insurance requirements, or with national safety codes.



# DECLARATION OF CONFORMITY

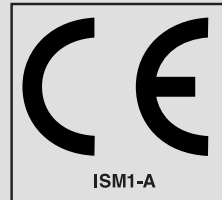

Application of Council Directive: 89/336/EEC – The EMC Directive  
73/23/EEC – The Low Voltage Directive

Manufacturer's Name: Teledyne Isco, Inc.  
Manufacturer's Address: 4700 Superior, Lincoln, Nebraska 68504 USA  
Mailing Address: P.O. Box 82531, Lincoln, NE 68501

Equipment Type/Environment: Laboratory Equipment for Light Industrial/Commercial Environments

Trade Name/Model No: 730 Bubbler Module

Year of Issue: 2001

Standards to which Conformity is Declared: EN 61326-1998 EMC Requirements for Electrical Equipment for Measurement, Control, and Laboratory Use  
EN 61010-1 Safety Requirements for Electrical Equipment for Measurement, Control, and Laboratory Use

Standard	Description	Severity Applied	Performance Criteria
EN61000-4-2	Electrostatic Discharge	Level 2 - 4kV contact discharge Level 3 - 8kV air discharge	B B
EN61000-4-3	Radiated RF Immunity	80 MHz to 1000MHz 80% AM at 1kHz Level 1 – 10V/m	A
EN61000-4-4	Electrical Fast Transient	Level 2 – 2kV on ac lines	B
EN61000-4-5	Surge on AC Lines	2kV common mode, 1KV differential mode	B
EN61000-4-6	Conducted RF on AC lines	150 kHz to 80 MHz, 3V rms, 80% modulated	B
EN61000-4-11	Voltage Dips/Short Interruptions	0.5 cycle, each polarity/100%	B
CISPR11/ EN 55011	RF Emissions	Group 1, Class A Industrial, Scientific, and Medical Equipment	
EN61000-3-2, 3-3	Harmonic, Flicker		

We, the undersigned, hereby declare that the design of the equipment specified above conforms to the above Directive(s) and Standards as of March 6, 2001.

William Foster  
USA Representative



William Foster  
Director of Engineering  
Teledyne Isco, Inc.  
4700 Superior Street  
Lincoln, Nebraska 68504

Phone: (402) 464-0231  
Fax: (402) 464-4543

60-9002-071  
Rev. A



# ***Teledyne Isco One Year Limited Factory Service Warranty \****

Teledyne Isco warrants covered products against failure due to faulty parts or workmanship for a period of one year (365 days) from their shipping date, or from the date of installation by an authorized Teledyne Isco Service Engineer, as may be appropriate.

During the warranty period, repairs, replacements, and labor shall be provided at no charge. Teledyne Isco's liability is strictly limited to repair and/or replacement, at Teledyne Isco's sole discretion.

Failure of expendable items (e.g., charts, ribbon, tubing, lamps, glassware, seals, filters, fittings, and wetted parts of valves), or from normal wear, accident, misuse, corrosion, or lack of proper maintenance, is not covered. Teledyne Isco assumes no liability for any consequential damages.

This warranty does not cover loss, damage, or defects resulting from transportation between the customer's facility and the repair facility.

Teledyne Isco specifically disclaims any warranty of merchantability or fitness for a particular purpose.

This warranty applies only to products sold under the Teledyne Isco trademark and is made in lieu of any other warranty, written or expressed.

No items may be returned for warranty service without a return authorization number issued from Teledyne Isco.

The warrantor is Teledyne Isco, Inc.  
4700 Superior, Lincoln, NE 68504, U.S.A.

**\* This warranty applies to the USA and countries where Teledyne Isco Inc. does not have an authorized dealer. Customers in countries outside the USA, where Teledyne Isco has an authorized dealer, should contact their Teledyne Isco dealer for warranty service.**

*In the event of instrument problems, always contact the Teledyne Isco Service Department, as problems can often be diagnosed and corrected without requiring an on-site visit. In the U.S.A., contact Teledyne Isco Service at the numbers listed below. International customers should contact their local Teledyne Isco agent or Teledyne Isco International Customer Service.*

## **Return Authorization**

A return authorization number must be issued prior to shipping. Following authorization, Teledyne Isco will pay for surface transportation (excluding packing/crating) both ways for 30 days from the beginning of the warranty period. After 30 days, expense for warranty shipments will be the responsibility of the customer.

**Shipping Address:** Teledyne Isco, Inc. - Attention Repair Service  
4700 Superior Street  
Lincoln NE 68504 USA

**Mailing address:** Teledyne Isco, Inc.  
PO Box 82531  
Lincoln NE 68501 USA

**Phone:** Repair service: (800)775-2965 (lab instruments)  
(800)228-4373 (samplers & flow meters)  
Sales & General Information (800)228-4373 (USA & Canada)

**Fax:** (402) 465-3001

**Email:** [iscoservice@teledyne.com](mailto:iscoservice@teledyne.com) **Web site:** [www.isco.com](http://www.isco.com)





## Free Manuals Download Website

<http://myh66.com>

<http://usermanuals.us>

<http://www.somanuals.com>

<http://www.4manuals.cc>

<http://www.manual-lib.com>

<http://www.404manual.com>

<http://www.luxmanual.com>

<http://aubethermostatmanual.com>

Golf course search by state

<http://golfingnear.com>

Email search by domain

<http://emailbydomain.com>

Auto manuals search

<http://auto.somanuals.com>

TV manuals search

<http://tv.somanuals.com>