

## 2007 Owner's Manual

# SUPRA

A BETTER WAKE. A BETTER BOAT.



Comp 20



Launch 20



Sunsport 20V



Launch 20SSV



Sunsport 22V



Launch 21V



Sunsport 24V



Launch 22SSV



Launch 24SSV



SKIER'S CHOICE, INC.

1717 Henry G. Lane Street, Maryville, Tennessee 37801  
Tel: 865.983.9924 Fax: 865.983.9950  
[www.supraboats.com](http://www.supraboats.com)

### Trademarks

Supra, the Supra Logo, Comp 20, Sunsport 20V, Sunsport 22V, Sunsport 24V, Launch 20, Launch 20SSV, Launch 21V, Launch 22SSV, Launch 24SSV are registered trademarks of Skier's Choice, Inc.  
All other product names are copyright and registered trademarks/trade names of their respective owners.

Skier's Choice, Inc. reserves the right to change product specifications at any time without incurring obligation.  
© 2007 Skier's Choice, Inc.

## Table of Contents

Section I	Introduction	3
Section II	Boating Safety	5
Section III	Emergency Procedures	11
Section IV	Boating Rules	15
Section V	Boat Specifications	19
Section VI	Operating Information	25
Section VII	Starting & Operation	27
Section VIII	Instrument Panel	31
Section IX	Equipment & Options	45
Section X	Service & Maintenance	63
Section XI	Cleaning, Care & Storage	69
Section XII	Winterization & Dry Storage	71
Section XIII	Technical Information	73
Section XIV	Trailer Your Boat	75
Section XV	Supra Warranty	81
Section XVI	Index	85

## Boat Information

Hull Identification Number: \_\_\_\_\_

Date of Purchase: \_\_\_\_\_

Dealership \_\_\_\_\_

Dealer's Phone Number: \_\_\_\_\_

Registration Number: \_\_\_\_\_

Engine Serial Number: \_\_\_\_\_

Trailer Serial Number: \_\_\_\_\_

### Introduction

Supra inboard ski boats are manufactured by Skier's Choice, Inc. in Maryville, Tennessee and distributed throughout the United States and the world.

This manual provides an overview for operating your Supra boat. It should be considered a permanent part of your Supra boat, and contains important information on Safety, Boating Rules, Proper Operation and Maintenance of your boat. Should the boat be sold, this manual will provide the same important information to the next owner.

Be sure to read and understand all aspects of Boating Safety and Operation before using your boat. If you have any questions, your dealer can provide the information you need to have a safe and pleasurable boating experience.

All information, illustrations and specifications in this manual are based on the latest product information available at the time of printing. Supra may discontinue models and equipment or change specifications and designs without any notice and without incurring obligation.



This manual contains information about several Supra models. Some information may not apply to your boat since standard and optional equipment may vary from model to model.

As you read through this manual, you will find CAUTION, WARNING and DANGER symbols which require special attention. Please read them carefully! They may tell you how to avoid problems and/or endangering yourself, your passengers, and other boaters. PLEASE REVIEW ALL SAFETY INFORMATION.

 CAUTION

 WARNING

 DANGER

A maintenance schedule and accessory information are included to assure trouble-free operation of your boat. Should service problems arise, remember that your Supra dealer knows your boat best and is interested in your total satisfaction.

Thank you for purchasing a Supra boat. We hope your ownership results in an enjoyable and rewarding boating experience. Be safe and enjoy the fun!

## Daily Check List



- Life-Saving Devices (One for every person on board?)
- Drain Plugs (Securely in place?)
- Steering System (Working smoothly and properly?)
- Fuel System (Adequate fuel? Leaks? Fumes?)
- Battery (Fully charged? Cable terminals clean and tight?)
- Engine (In Neutral?)
- Capacity Plate (Are you overloaded or overpowered?)
- Weather Conditions (Safe to go out?)
- Electrical Equipment (Lights, horn, blower, bilge pump, etc.?)
- Emergency Gear (Fire extinguisher, bailer, paddle, anchor & line, signaling device, tool kit, etc.?)
- Bilge Pump (Working properly?)

**NOTE: Bilge pump should be checked prior to each use to ensure proper operation!**

Check **BEFORE** running (where applicable)

- Engine Oil level
- Transmission Lubricant level
- Engine Drain Plug, Transom Drain Plug and Center Drain Plug
- Leakage (Fuel, water lines and connections)

**CAUTION** DO NOT operate engine without cooling water flowing through water pump, otherwise pump will sustain damage and subsequent engine damage may result!

Check **BEFORE** running

- Oil Pressure: Refer to Engine Owner's Manual
- Water Temperature: 160 degrees to 180 degrees for raw water systems (water is not recirculated), and 180 degrees to 200 degrees for closed cooling systems (water is recirculated).
- Idle RPM: (650-750) in gear.
- Maximum Forward RPM: See Engine Owner's Manual.
- Shifting Linkage (Forward, Neutral and Reverse).

**WARNING** GASOLINE VAPORS CAN EXPLODE! It is very important to check for fuel spillage or leaks prior to each use of your boat.

- Check engine compartment for gasoline vapors.
- Operate blower for 4 minutes before starting the engine.
- Always operate blower below cruising speed.

**NOTE: Please refer to your Engine Owner's Manual for maximum RPM and engine break-in procedure.**

## Important Safety Information!

Your safety, as well as the safety of others with and around you, is a direct result of how you operate and maintain your boat. Read and comprehend this manual. Make sure that you understand all the controls and operating instructions before attempting to operate the boat. Improper operation is extremely dangerous.

The basic safety rules are outlined in this section of the manual. Additional precautions throughout the manual are noted by the following symbols:



This symbol indicates a potentially hazardous circumstance, which, if not avoided, may result in *minor or moderate injury*. It may also be used to alert against unsafe practices.



This symbol indicates a potentially hazardous situation, which, if not avoided, could result in *death or serious injury*.



This symbol indicates an imminently hazardous situation, which, if not avoided, will result in death or serious injury. This is limited to the most extreme situations.

The precautions listed in this manual and on the boat are not exhaustive. If a procedure, method, tool or part is not specifically recommended by Skier's Choice, you must satisfy yourself that it is safe for you and others, and that the boat will not be damaged or made unsafe as a result of your decision.

**REMEMBER: ALWAYS USE COMMON SENSE WHEN OPERATING, SERVICING OR REPAIRING THE BOAT!**

In addition to everyday safety, failure to observe safety recommendations may result in severe personal injury or death to you or to others. Use caution and common sense when operating your boat. Don't take unnecessary chances!

Be certain that all boat passengers are aware of this information and conform to boat safety principles.

## Safe Boating

Safe boating practices may seem obvious, but people have thought up risky and dangerous activities in boats, with boats, and behind boats. Just because you or your passengers have seen a boating maneuver performed or have seen a particular activity promoted, do not assume there is no risk of injury or death. Before you or your passengers go out in the boat and engage in any water sport activity, give careful consideration to the risks. Plan ahead. Think twice before you try something new behind your boat or with your boat. Know the limits of you, your passengers and your equipment and do not exceed them.

In addition to careful review of this manual, you should be aware as well that there are many sources of information available. Skier's Choice urges you to pursue additional training, such as safety and seamanship courses offered by the U.S. Coast Guard Auxiliary and the U.S. Power Squadron.

Safe boating and safe actions may seem obvious, yet every year US Coast Guard statistics give evidence that many people disregard safe boating practices. Do not take safety for granted. Think twice. We want all our boat owners and their passengers, friends, and families to have a safe and enjoyable experience on the water.

## US Coast Guard Auxiliary Boating Safety Course

The purchaser of a new 2007 Supra boat is entitled to a USCGA Boating Safety Course that Supra will pay for. Please see the Certificate in your owner's packet or your dealer for more details.

## Safety Training Organizations

The following is a listing of just some of the agencies and organizations that offer safety training or information:

American Red Cross, National HQ  
17th & D Streets NW  
Washington, DC 20006  
(202) 639-3686  
www.redcross.org

USA Waterski  
799 Overlook Drive  
Winter Haven, FL 33884  
(941) 324-4341  
www.usawaterski.org

Boat Owners Association of the United States (BOAT/US)  
880 South Pickett Street  
Alexandria, VA 22304  
(703) 823-9550  
www.boatus.com

National Safe Boating Council  
2550 M Street NW, Suite 425  
Washington, DC 20037  
(202) 296-4588  
www.safeboatingcouncil.org

U.S. Coast Guard Auxiliary Commandant (G-NAB)  
2100 Second Street SW  
Washington, DC 20593-0001  
(800) 336-2628  
www.cgaux.org

U.S. Power Squadron  
www.usps.org

On-Line Basic Boating  
Safety Course  
www.boatsafe.com

National Marine Manufacturers Association  
200 E. Randolph Dr. Suite 5100  
Chicago, IL 60601  
(312) 946-6200  
www.nmma.org

Federal law requires certain safety equipment to be onboard at all times. In addition, responsible boaters carry other equipment in case of emergency. Check with the local boating authorities for any additional requirements over and above the federal stipulations.

## Safety Equipment

Your Supra has been equipped at the factory with most of the federally required safety equipment for inland waters (Class 1, 16'-to-26'). This equipment includes:

- UL-approved Marine Fire Extinguisher, Type A-BC (2 lbs.), good for solids, liquids, and electrical fire
- ABYC-approved Marine Mufflers with water injection
- USCG-approved Marine Flame Arrestor
- USCG-approved Engine Box Ventilation with sparkless power blower
- ABYC-approved Electric Horn sound warning device
- USCG-approved inland lighting

Federal law also requires at least one Type I, II or III Personal Flotation Device (PFD) for each person on board or being towed on water skis or other recreational equipment. In addition, one throwable Type IV PFD must also be on board. As the owner, obtaining the appropriate PFDs is your responsibility. Your Supra dealer can and will be happy to assist you.

**NOTE: Requirements for coastal waters and inland waters differ. Check with the local authorities for more information.**

A smart owner will avoid potential problems on an outing by having additional equipment on board. Normally, this equipment is dependent on the body of water and the length of the trip.

We suggest the following—as a minimum. Your Supra dealer can also assist you with additional recommendations.

- An anchor with at least 75 feet of line
- A manual bailing device for removing water
- A combination oar/boat hook
- A day-and-night visual distress signal
- A first aid kit and manual
- An airway breathing tube
- A waterproof flashlight
- A set of local navigation charts
- Mooring lines and fenders
- Extra engine oil
- A tool kit
- A portable AM/FM radio or weather radio
- VHF hand held marine radio

Boating-related accidents are generally caused by the operator's failure to follow basic safety rules or written precautions. Most accidents can be avoided if the operator is completely familiar with the boat, its operation, and can recognize potentially hazardous situations before an accident occurs.

## General Safety Precautions

Failure to adhere to these precautions may result in severe injury or death to you and/or others.

### **WARNING**

- Improper operation is extremely dangerous. Operators must read and understand all operating manuals supplied with the boat before operation.
- Remain seated at all times while boat is in motion.
- Never stand or allow passengers to stand while the boat is moving. You or others may be thrown from the boat.
- Children in the bow of the boat should be accompanied by an adult at all times.
- Never operate the boat while under the influence of alcohol or drugs.
- On-board equipment must always conform to the governing federal, state, and local regulations.
- Gasoline vapors can explode. Before starting engine, open engine box, check engine compartment for gasoline vapors, and operate blower for at least four minutes. Run blower below cruising speed.
- Leaking fuel is a fire and explosion hazard. Inspect system regularly. Examine fuel tanks for leaks or corrosion at least annually.
- Never override or modify the engine safety shut-off switch or engine neutral starting safety switch in any way.
- Never remove or modify components of the fuel system in any way except for maintenance by qualified personnel. Tampering with fuel components may cause a hazardous condition.
- Never allow any type of spark or open flame on board. It may result in fire or explosion.
- It is the owner's responsibility to check tightness of the Rad-A-Cage Tower bolts BEFORE each use.
- The Rad-A-Cage Tower is designed to pull a single (1) individual. DO NOT climb or sit on the Rad-A-Cage Tower. Rope may loop on inverted tricks. DO NOT sit behind the pulling point of the Rad-A-Cage Tower.

### **DANGER**

- To avoid serious personal injury, DO NOT be on or about the swim platform while engine is running and keep away from rear of boat while engine is running.
- To avoid serious personal injury, DO NOT operate engine while anyone is on or about the swim platform or in the water near the boat.

## General Safety Precautions *(continued)*

### **CAUTION**

- The tow bar is not designed for vertical extensions. Any modifications to the tow bar or its mountings may result in damage to the boat and injury to the user.
- Rear storage area is located above the gas tank and is not designed for ballast. Weight limit is 150 lbs. equally distributed.
- The Rad-A-Cage Tower may strike low objects. Check clearance height around docks, shore, overhanging objects, bridges and power lines.
- Do not pull past 45 degrees of the centerline of the boat. Failure to follow this rule could result in the boat capsizing.

### **CAUTION**

- It is the driver's responsibility to ensure all passengers are seated when boat is underway.

### **WARNING**

Failure to adhere to these warnings may result in severe injury or death to you and/or others.

- This boat is a high-performance boat and capable of quick and tight turns and changes in direction. It is the driver's responsibility to operate the boat in a manner to ensure the safety of all passengers.

### **WARNING**

Boaters must continuously be aware of weather conditions.

- Sudden storms, wind, lightning, etc., can unexpectedly put boaters in grave danger. Always check the local weather report before going boating.

### **DANGER**

It is the driver's responsibility to determine if weather or other factors have created an unsafe boating environment.

- The driver is solely responsible for the consequences of their actions.

## Skiing Safety

Skiers are obligated to be as aware of the fundamental safety rules as well as the boat operator. If you are new to water skiing, seek certified training before starting. You will find it especially helpful to join a local ski club and USA Waterski when possible.

Always remember that the majority of water skiing injuries are the result of impacts with other objects, so always look where you are going and be aware of what is going on around you.

### CAUTION

Failure to adhere to these warnings may result in severe injury or death to you and/or others.

- Every skier must always wear a USCG-approved personal flotation device.
- Maintain a distance of at least 100 feet from all other objects, including other boats, piers, rafts, mooring and navigational buoys, pilings, abutments, or any other items.
- Always have an experienced driver and observer in the boat when skiing.
- Never ski in shallow water, close to shore, or in water where you do not know the depth or what is beneath the surface.
- Never put your arm, head, or any other part of your body through the handle-bridle of the ski line nor wrap the line around any part of the body at any time.
- Never ski at night, or directly in front of other boats.
- Never jump from a boat that is moving at any speed, nor enter or exit the water when the engine is running (ON).
- Make sure that everyone knows and uses approved skiing hand signals and common skiing courtesies.

## Ski Pylon Extensions

The use of a ski pylon extension or extensions in excess of 7-feet vertical is not recommended by Supra on our products. If you elect to use merchandise such as these, be aware that they could create excessive stress on your boat and subjectively cause damages not covered by the warranty.

## Carbon Monoxide (CO) Safety

### DANGER

Carbon monoxide is a colorless, odorless and tasteless gas. It is produced by gasoline engines and is a component of exhaust fumes.

Shut off the engine when people are on the swim platform or in the water around the rear of the boat.

Do not do any other activities which puts people in close proximity of the transom when the engine is running.

For the most current information on carbon monoxide, you may call, write or visit on-line any of the following:

United States Coast Guard  
Office of Boating Safety (G-OPB-3)  
2100 Second Street SW  
Washington, DC 20593-0001  
[www.uscgboating.org](http://www.uscgboating.org)  
1-800-368-5647

NMMA  
National Marine Manufacturers Association  
200 East Randolph Drive, Suite 5100  
Chicago, IL 60601-6528  
[www.nmma.org](http://www.nmma.org)  
312-946-6200

American Boat & Yacht Council, Inc.  
3069 Solomon's Island Road  
Edgewater, MD 21037-1416  
[www.abycinc.org](http://www.abycinc.org)  
410-956-1050

## Product Misuse

Misuse of the product or use of it in a manner for which it was never intended can create dangerous situations. The driver and passengers are responsible for using the product safely and as intended. The driver must operate the boat in a manner that ensures the safety of all passengers. If you or your passengers are unsure about use of the product, about performing certain boating maneuvers or are unsure about a particular water activity, refer to this manual or contact a knowledgeable source such as your local dealer, Skier's Choice, Inc., the US Coast Guard, or your local boating authority.



## Proper Seating

Proper seating is an important element of boating safety. Proper seating consists of sitting with your buttock in full contact with a seat anytime the boat is underway and using hand holds and grab handles to secure oneself and prevent loss of balance. Do not sit in locations not designed as a seat. For instance, do not sit on seat backs, do not sit on the sides or gunwale of the boat, and do not sit on the sundeck while the boat is in motion. See examples below of proper sitting positions.



The driver must be aware of all passenger's locations and positions, and passengers must stay alert to changes in direction. THE BOAT IS CAPABLE OF QUICK AND TIGHT TURNS. SUCH MANUEVERS CAN CAUSE UNSEATED OCCUPANTS TO BE THROWN AROUND OR OUT OF THE BOAT. ALERT PASSENGERS BEFORE CHANGES IN DIRECTION.

## Contact Information

If you have questions regarding the operation of your boat, accessory or options or questions in regard to Boat Safety, contact your dealer or Skier's Choice, Inc. at 865-983-9924.

# Warning Plates and Labels

Read and note ALL warning plates and labels from bow to stern that appear on the boat, including these!

**⚠ DANGER**

- CARBON MONOXIDE AND PROPELLER HAZARD. DO NOT OPERATE ENGINE WHILE ANYONE IS ON OR ABOUT THE SWIM PLATFORM OR IN THE WATER NEAR THE BOAT. OWNERS AND OPERATORS MUST READ AND UNDERSTAND ALL PRODUCT WARNINGS AND MANUALS BEFORE USE.

**⚠ WARNING**

- AVOID SERIOUS INJURY FROM LOSS OF BALANCE AND FALLING OVERBOARD, ALL OCCUPANTS MUST REMAIN SEATED AT ALL TIMES WHILE BOAT IS IN MOTION.
- BOAT IS CAPABLE OF QUICK AND TIGHT TURNS. SUCH MANEUVERS CAN CAUSE UNSEATED OCCUPANTS TO BE THROWN AROUND OR OUT OF THE BOAT. ALERT PASSENGERS BEFORE CHANGES IN DIRECTION. THE DRIVER IS RESPONSIBLE FOR OPERATING BOAT IN A MANNER THAT ENSURES THE SAFETY OF PASSENGERS.
- GASOLINE VAPORS CAN EXPLODE. BEFORE STARTING ENGINE, OPEN ENGINE BOX, CHECK ENGINE COMPARTMENT FOR GASOLINE VAPORS, AND OPERATE BLOWER FOR AT LEAST 4 MINUTES. RUN BLOWER BELOW CRUISING SPEED.

WLDG0804

**⚠ WARNING**

- AVOID SERIOUS INJURY OR DEATH FROM LOSS OF BALANCE AND FALLING OVERBOARD.
- CHILDREN SHOULD BE SUPERVISED BY AN ADULT AT ALL TIMES.
- REMAIN PROPERLY SEATED AT ALL TIMES WHILE BOAT IS IN MOTION.
- DO NOT STAND UP OR MOVE ABOUT WHILE THE BOAT IS IN MOTION.

WLOB0804

**⚠ WARNING**

- AVOID SERIOUS INJURY OR DEATH.
- TOW PYLON SHOULD BE USED ONLY FOR TOWABLE WATER SPORTS DEVICES.
- DO NOT USE TOW PYLON FOR OTHER TOWABLE OBJECTS OR TOWING BOATS.
- TOW PYLON IS NOT DESIGNED FOR VERTICAL EXTENSIONS. ANY MODIFICATIONS TO THE TOW PYLON OR ITS MOUNTINGS MAY RESULT IN DAMAGE TO THE BOAT AND INJURY TO THE USER.
- DO NOT SIT BEHIND THE TOW PYLON WHEN IN USE.

WLSKP0803

**⚠ WARNING**

- AVOID SERIOUS INJURY OR DEATH.
- FIRE, EXPLOSION AND SPLASHING FUEL HAZARD.
- IF TANK IS OVERFILLED, FUEL WILL DISCHARGE OUT THIS PORT.

WLFH0804

**⚠ WARNING**

- AVOID SERIOUS INJURY OR DEATH.
- TOW EYE SHOULD BE USED ONLY FOR TOWABLE WATER SPORTS DEVICES WITH 1 OR 2 INDIVIDUALS. **TOW EYE WEIGHT LIMIT IS 800 LBS.**
- DO NOT USE TOW EYE FOR OTHER TOWABLE OBJECTS OR TOWING BOATS.
- DO NOT USE TOW EYE TO LIFT BOAT.

WLTE0803

**⚠ CAUTION**

- REAR STORAGE AREA NOT DESIGNED FOR BALLAST.
- GAS TANK LOCATED UNDER FLOOR OF STORAGE AREA.
- STORAGE AREA WEIGHT CAPACITY IS 150 LBS.

WLR0804

**⚠ WARNING**

LOOSE FITTINGS  
MAY RESULT IN  
TOWER COLLAPSE.

CHECK TIGHTNESS  
OF TOWER BOLTS  
AND KNOBS BEFORE  
EACH USE.

WLRB0804

**⚠ DANGER**

- AVOID SERIOUS INJURY OR DEATH FROM CARBON MONOXIDE AND PROPELLER HAZARD.
- DO NOT BE ON OR ABOUT THE SWIM PLATFORM WHILE ENGINE IS RUNNING OR BOAT IS IN MOTION.
- KEEP AWAY FROM REAR OF BOAT WHILE ENGINE IS RUNNING.

WLSWP0804

**⚠ WARNING**

- AVOID SERIOUS INJURY OR DEATH.
- LEAKING FUEL IS A FIRE AND EXPLOSION HAZARD.
- INSPECT SYSTEM REGULARLY. EXAMINE FUEL SYSTEM FOR LEAKS AND CORROSION AT LEAST ANNUALLY.

WLENG0803

**⚠ WARNING**

- AVOID SERIOUS INJURY OR DEATH FROM MISUSE OF TOWER.
- THE TOWER IS DESIGNED TO PULL A SINGLE (1) WAKEBOARDER.
- DO NOT CLIMB OR SIT ON THE TOWER.
- DO NOT SIT BEHIND THE PULLING POINT OF THE TOWER TO AVOID CONTACT WITH ROPE.
- THE TOWER MAY STRIKE LOW OBJECTS. CHECK CLEARANCE HEIGHTS DURING OPERATION AND TOWING.

WLTWR0804

If your warning decals should become damaged in any way, please contact your Supra Dealer or write to Skier's Choice, Inc., 1717 Henry G. Lane Street, Maryville, Tennessee 37801 to request replacement warning decals. The decals will be provided free of charge. Your boat's serial number (located on the transom) must be included for warning decal requests.

Skier's Choice, Inc. reserves the right to change warning labels without notification or incurring obligation. For a copy of the most current warning labels, please contact your dealer or Skier's Choice, Inc.

Reprinted from "Fishing and Skiing Boats Owner's Manual" with permission from the NMMA.

The time to think about emergencies is before they happen. Plan ahead. Know what to do before you encounter any of these situations. Wear a PFD (Personal Flotation Device) when boating.

## Explosion & Fire



**WARNING**

### EXPLOSION/FIRE/ASPHYXIATION HAZARD

- Open flame cooking appliances consume oxygen. This can cause asphyxiation or death.
- Maintain open ventilation.
- Liquid fuel may ignite, causing severe burns.
- Use fuel appropriate for type of stove.
- Turn off stove burner before filling.
- Do not use stove for comfort heating.

**FIRE/ASPHYXIATION HAZARD** - Use special care with flames or high temperatures near urethane foam, if used in construction of your boat. Burning, welding, lights, cigarettes, space heaters and the like can ignite urethane foam. Once ignited, it burns rapidly, producing extreme heat, releasing hazardous gases and consuming much oxygen.

#### Explosion

- If explosion is imminent, put on PFDs, grab distress signals and survival gear, and immediately abandon ship.

#### Fire

- Turn off engines, generators, stoves and blowers. Extinguish smoking materials.
- Fixed fire suppression system, if equipped, has heat sensors that automatically flood machinery space with a fire extinguishant. Allow extinguishant to "soak" compartment for at least 15 minutes to cool hot metals or fuel before cautiously inspecting fire area. Have portable fire extinguishers ready. Do not breathe fumes or vapors caused by the fire or extinguishant.
- If no fixed firefighting system is installed and fire is in engine compartment, discharge portable fire extinguishers through engine compartment access plate, if equipped. Do not open engine hatch as this feeds oxygen to the fire.
- If you have access to fire, direct contents of extinguishers at base of flames, not at the top.

## Section III

### Emergency Procedures

- Throw burning materials overboard if possible.
- Move anyone not needed for firefighting operations away from the flames.
- Signal for help.
- Put on PFDs, grab distress signals and survival gear, and prepare to abandon ship.

#### Abandoning Ship



**WARNING**

### BURN HAZARD

Swim against the current or wind if you abandon ship. Leaking fuel will float with the current and may ignite.

- When clear of danger, account for all who were on board, and help those in need.
- Use distress signal.
- Keep everyone together to make rescue easier.

## Flooding, Swamping or Capsizing

- **STAY WITH THE BOAT!** A boat will usually float even if there is major hull damage. Rescuers can spot a boat much easier than a head bobbing in the water.
- Signal for help.

## Collision

- Account for everyone on board.
- Check for injuries.
- Inspect structural damage.
- Reduce flooding.
- Signal for help.
- **STAY WITH THE BOAT!**

## Grounding

Action depends on how hard the boat hits bottom and whether the boat remains stranded. If it is a simple touch, you may need only to inspect the hull. If you are aground, assess the situation before reacting. In some cases, throwing the boat into reverse can cause more damage.

## Grounding (continued)

### Basic Guidelines

- Inspect damage to hull, propulsion and steering systems.
- Check for leaks. If water is coming in, stopping the flow takes priority over getting free.
- Determine water depth all around the boat and type of bottom (sand, mud, rocks, etc.). This will help you decide which way to move the boat.
- Determine if tide, wind or current will drive the boat harder aground or will help free it.

## Leaks

- Immediately switch on bilge pumps.
- Assign crew to operate manual pumps, if needed.
- If boat is taking on water, have someone take the helm while you manage damage control.
- Slow or stop to minimize inflow. However, if you can keep a hole above water by maintaining speed, do so.
- If possible, patch the outside with whatever material is available.

## Towing

### **WARNING**

**PERSONAL INJURY HAZARD**  
**Towing or being towed stresses the boats, hardware and lines. Failure of any part can seriously injure people or damage the boat.**

A recreational boat towing another is usually a last resort because of possible damage to one or both boats. The Coast Guard or a private salvage company is better equipped. A recreational boat may assist by standing by, and possibly keeping the disabled boat's bow at a proper angle until help arrives. Only when conditions are ideal—that is, waters are calm, disabled boat is small, and one or both skippers know correct technique—should a recreational boat tow another.

### Towing Vessel

- Be sure your boat will not run aground too.
- Because you are maneuverable and the grounded boat is not, you should pass the towline to the grounded boat.

### Towing Vessel (continued)

- Use double-braided or braid-on-braid line. Never use three-strand twisted nylon; it has too much elasticity and can snap back dangerously.
- Fasten the towline as far forward as possible on the upwind or up-current side of the towing boat. Fastening it to the stern will restrict maneuverability of the towing boat.
- If possible, use a bridle.
- Move slowly to prevent sudden strain on slack line.
- Be ready to cast loose or cut the line if the towing situation becomes hazardous.

### Vessel Being Towed

- Attach the towline to the bow eye, forward bitt or cleats if the fitting can take the load.
- If the boat has eyebolts in the transom for pulling skiers, a towline may be attached to a small bridle hooked to both eyebolts.
- If it is necessary to be towed after being freed, keep someone at the wheel to steer.

### Both Vessels

- If you attach the towline to a fitting, be sure the fitting is fastened with a through bolt and is reinforced on the underside.
- Creating a bridle with a line around the hull or superstructure will distribute the load over a wide area; pad pressure points. This technique can be used on both the towing and towed boat.
- Keep lines clear of propellers on both boats.
- Keep hands and feet clear of the other boat.
- Never hold a towline after it is pulled taut.

## Person Overboard

- Immediately sound an alarm and keep pointing to the person overboard.
- Throw a life preserver even if the person is wearing a PFD. It will serve as a marker.
- Immediately stop or slow the boat, then circle toward the victim.

## Person Overboard (continued)

- Keep person overboard on helm side so operator has the person constantly in sight.
- Approach from downwind and move alongside into the wind for pickup.
- When almost alongside, stop the engine in gear to prevent dangerous propeller “windmilling.”
- As part of your emergency plan, consider what to do if you were alone and fell overboard (e.g., wear PFD, keep signal device in PFD, attach emergency stop switch lanyard to yourself).

## Drowning

- Swim to rescue a drowning victim only as a last resort.
- Immediate resuscitation is critical! At least two people on board should be certified in CPR.
- Keep the victim warm.
- Use care in handling. Spinal injury may exist if the victim fell overboard.
- Signal for help.

## Medical Emergency

- In an emergency, you may be far from professional medical assistance. Be prepared. Take a first aid course, and carry a first aid kit. Be aware of special conditions that may affect anyone on board.

## Carbon Monoxide

Carbon monoxide is an odorless, colorless, extremely toxic gas. Symptoms of carbon monoxide poisoning are dizziness, ears ringing, headaches, nausea and unconsciousness. A poisoning victim's skin often turns cherry red.

Have the victim breathe fresh air deeply. If breathing stops, resuscitate. A victim often revives, then relapses because organs are damaged by lack of oxygen. Seek immediate medical attention.

## Propulsion, Control or Steering Failure

- Shut off engine.
- Put out an anchor to prevent drifting.
- Determine if you can fix the problem yourself. See engine operator's manual if engine is flooded.
- Signal for help.

## Radio Communication

Radio is the boat operator's main method of receiving safety information and summoning aid. VHF-FM radio is the primary means of short-range communication. Single sideband radio (SSB) is used for longer range communication.

VHF-FM Channel 16 and SSB 2182 kHz are designated for emergency use. Such situations can be categorized as:

- Emergency - “MAYDAY, MAYDAY, MAYDAY” - Used when a life or vessel is in imminent danger.
- Urgency - “PAN-PAN, PAN-PAN, PAN-PAN” (pronounced PAHN-PAHN) - Used when a person or vessel is in some jeopardy less than indicated by a Mayday call.
- Safety - “SECURITY, SECURITY, SECURITY” (pronounced SAY-CURE-IT-TAY) - Used for navigational safety or weather warning.

An emergency situation will be hectic and there will not be time to learn proper radio procedure. **LEARN WHAT TO DO BEFORE YOU NEED TO DO IT.**

If you hear a distress call, stop all radio transmissions. If you can directly assist, respond on the emergency frequency. If you cannot assist, do not transmit on that frequency. However, continue to monitor until it is obvious that help is being provided.

## Distress Signals

Consult your national boating law enforcement agency.

### Visual Distress Signals

- U.S. Coast Guard regulations require boats in coastal waters and the Great Lakes to carry visual distress signals for day or night use, as appropriate for the time of operation. Exempt from the day signals requirement, but not night signals, are boats less than 4.8 meters (16 feet), open sailboats less than 7.9 meters (26 feet),

---

## **Visual Distress Signals (continued)**

boats participating in organized events, and manually propelled boats.

- If you are required to have visual distress signals, at least three safety-approved pyrotechnic devices in serviceable condition must be readily accessible. They must be marked with a date showing the service life, which must not be expired.
- Carry three signals for day use and three signals for night use. Some pyrotechnic signals, such as red flares, meet both day and night use requirements.
- Store pyrotechnic signals in a cool, dry location. An orange or red watertight container prominently marked "Distress Signals" is recommended.

Other recognized visual distress signals include:

- Flames in a bucket
- Code flags November and Charlie
- Square flag and ball
- Black square and ball on orange background flag
- Orange flag (certified)
- Electric distress light (certified) - for night use only.
- Dye marker (any color)
- Person waving arms
- U.S. ensign flown upside down

## **Audible Distress Signals**

U.S. Coast Guard regulations require one hand, mouth or power-operated whistle or horn, audible for at least a half mile.

Other recognized audible distress signals include:

- Radio communication (*see Emergency Procedures - Radio Procedures - Radio Communication*)
- Radio-telegraph alarm
- Position indicating radio beacon
- Morse Code SOS (3 short, 3 long, 3 short) sounded by any means
- Fog horn sounded continuously

## **Notes**

### Basic Boating Rules

You should be aware of these rules and follow them whenever you encounter another vessel on the water.

The rules presented in this manual are condensed and have been provided as a convenience only. Consult your local U.S. Coast Guard Auxiliary (USCGA) or Department of Motor Vehicles (DMV) for a complete set of rules governing the waters in which you will be using your boat. If you plan to travel—even for a short trip—you would be well served to contact the regional USCGA or DMV in the area where you will be boating.

Review and understand all local and state laws.

Any time two vessels on the water meet one another, one vessel has the right-of-way. It is called the stand-on vessel. The vessel which does NOT have the right-of-way is called the give-way or burdened vessel.

These rules determine which vessel has the right-of-way, and accordingly, what each vessel should do.

The vessel with the right-of-way has the duty to continue its course and speed, except to avoid an immediate collision. When you maintain your direction and speed, the other vessel will be able to determine how best to avoid you.

The vessel which does not have the right-of-way has the duty to take positive and timely action to stay out of the way of the stand-on vessel. Normally, the give-way vessel should not cross in front of the stand-on vessel. Slow down or change directions briefly and pass behind the other vessel. You should always move in such a way that the stand-on operator can see what you are doing.

This rule is called Rule 2 in the International Rules and says,

“In obeying and construing these rules due regard shall be had to all dangers of navigation and collision, and to any special circumstances, which may render a departure from the above rules necessary in order to avoid immediate danger.”

### Encountering Other Vessels

There are three main situations in which you may encounter other vessels and you must observe the Steering Rules in order to avoid a collision. These are:

- Meeting (you are approaching another vessel head-on)
- Crossing (you are traveling across the other vessel's path)
- Overtaking (you are passing or being passed by another vessel)

Using the following illustration in which you are the boat in the center, you should give right-of-way to all vessels shown in the white area. In this instance, you are the give-way vessel. All vessels in the shaded area must yield to you as you are the stand-on vessel. Both you and the meeting vessel must alter course to avoid each other.

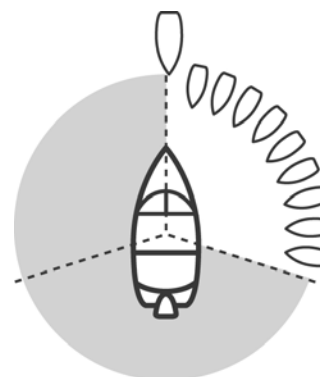

If you are meeting another power vessel head-on, and you are close enough to run the risk of collision, neither of you has the right-of-way. Both of you should alter course to avoid an accident. You should keep the other vessel on your port (left) side. This rule doesn't apply if both of you can clear each other by continuing your set course and speed.

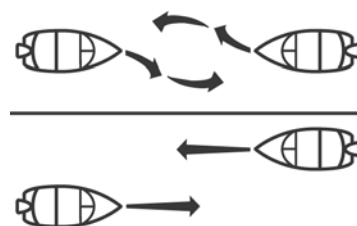

When two power-driven vessels are crossing each other's path close enough to run the risk of collision, the vessel that views the crossing vessel to the starboard (right) side must give-way.

If the other vessel is to the port (left) side, maintain your course and direction, provided the other vessel gives you the right-of-way as it should.

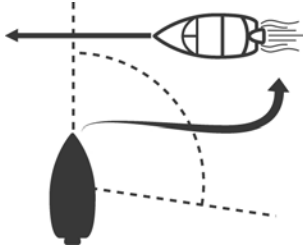

If you are passing another vessel, you are the give-way vessel. This means that the other vessel is expected to maintain its course and speed. You must stay out of its way as you clear it, altering course and speed as necessary.

Conversely, if you are being passed by another vessel, you should maintain your speed and direction so that the other vessel can steer itself around you.

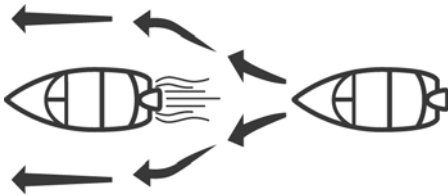

There are three other rules to always remember when driving your boat around other vessels.

When navigating in narrow channels, you should keep to the right when it is safe and practical to do so. If the operator of a power-driven vessel is preparing to go around a bend that may obstruct the view of other water vessels, the operator should sound a prolonged blast on the whistle or horn—four to six seconds.

If another vessel is around the bend, it too should sound the whistle or horn. Even if no reply is heard, however, the vessel should still proceed around the bend with caution.

If you navigate these type of waters, you should carry a portable air horn, which are available from local marine supply stores.

All vessels which are fishing with nets, lines or trawls are considered under International Rules to be fishing vessels. Boats with trolling lines are not considered fishing vessels.

Fishing vessels have the right-of-way, regardless of position. These vessels, however, cannot impede the passage of other vessels in narrow channels.

Sailing vessels should normally be given the right-of-way. The exceptions to this are:

- When the sailing vessel is overtaking the power-driven vessel, the power-driven vessel has the right-of-way.
- Sailing vessels should keep clear of any fishing vessel.
- In a narrow channel, a sailing vessel should not hamper the safe passage of a power-driven vessel which can navigate only in such a channel.

The waters of the United States are marked for safe navigation by the lateral system of buoyage. The markers and buoys you will encounter have an arrangement of shapes, colors, numbers and lights to show which side of the buoy a boater should pass when navigating in a particular direction.

The markings on these buoys are oriented from the perspective of being entered from seaward while the boater is going towards the port. This means that red buoys are passed on the starboard (right) side when proceeding from open water into port, and black buoys are to port (left) side. When navigating out of port, your position to the buoys should be reversed: red buoys to port and black buoys to starboard.

Many boating bodies of water are entirely within the boundaries of a single state. The Uniform State Waterway Marking Systems has been devised for these waters. This system uses buoys and signs with distinctive shapes and colors to show regulatory or advisory information.

These markers are white with black letters and orange borders. The information signifies speed zones, restricted areas, danger areas and general information.

Remember: Markings may vary by geographic location. Always consult local boating authorities before driving your boat in unfamiliar waters.

***(See examples of buoys and markers next page.)***



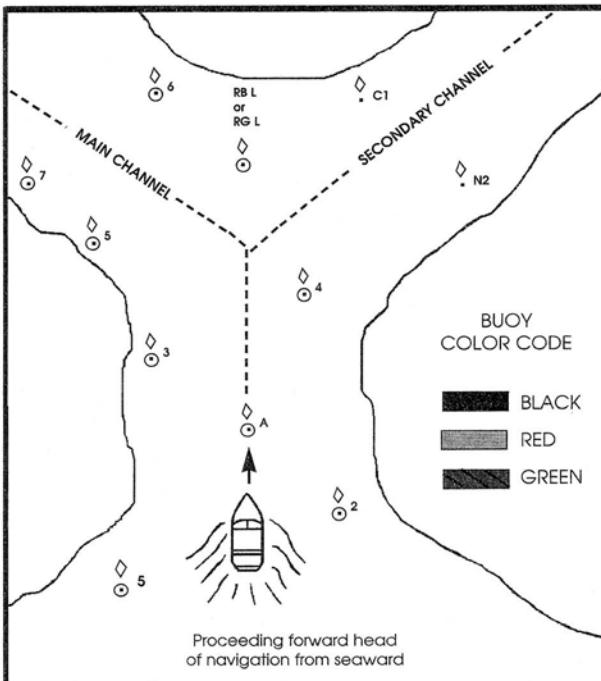

**MAIN CHANNEL BUOYS**

◇ 1, 3, 5

White Light OR Green Light

old OR new

**LIGHTED BUOY (Port Hand)**

Odd number, increasing toward head of navigation. Leave to port (left) proceeding upstream.

◇ 2, 4, 6

White Light OR Red Light

old OR new

**LIGHTED BUOY (Starboard Hand)**

Even number, increasing toward head of navigation. Leave to starboard (right) proceeding upstream.

◇ A

White Light OR Top Mark Red Light

old OR new

**LIGHTED SAFE WATER BUOY**

No number. Marks mid-channel. Pass on either side. Letter has no lateral significance; it is used for identification and location purposes.

**SECONDARY CHANNEL BUOYS**  
STARTS NEW NUMBERING SYSTEM

◇ c1

old OR new

**CAN BUOY**

Odd number. Leave to port.

◇ n2

no change

**NUN BUOY**

Even number. Leave to starboard.

◇ RB L RG L

Red or White Light OR Red Light

old OR new

**LIGHTED PREFERRED CHANNEL TO PORT BUOY**

No number. Topmost band red; preferred channel is to the left of the buoy. Letter has no lateral significance; it is used for identification and location purposes.



### Comp 20

### Sunsport 20V

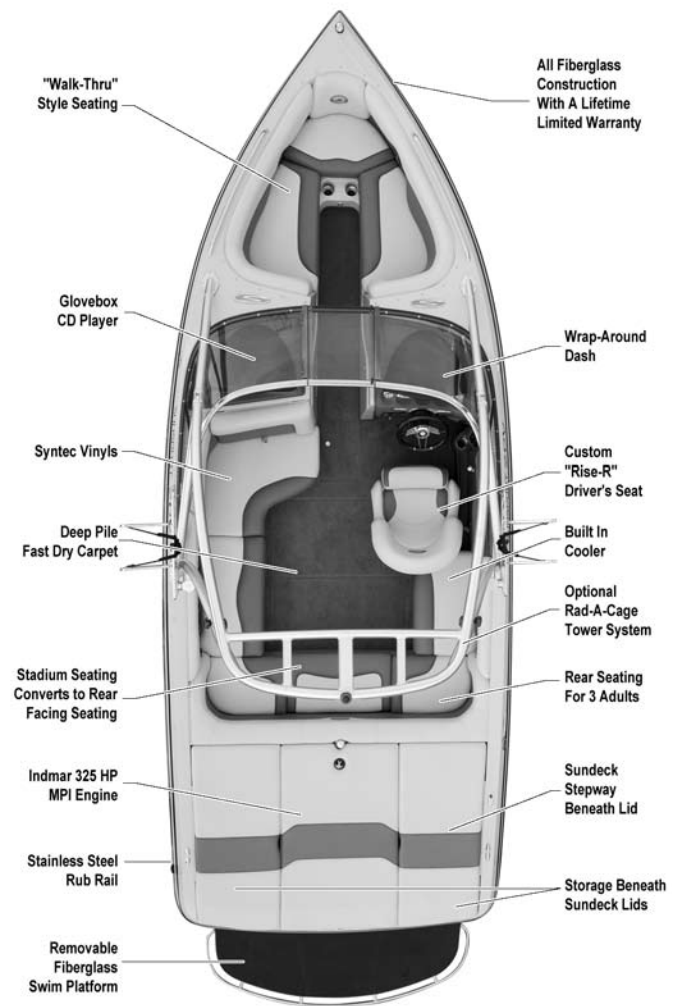
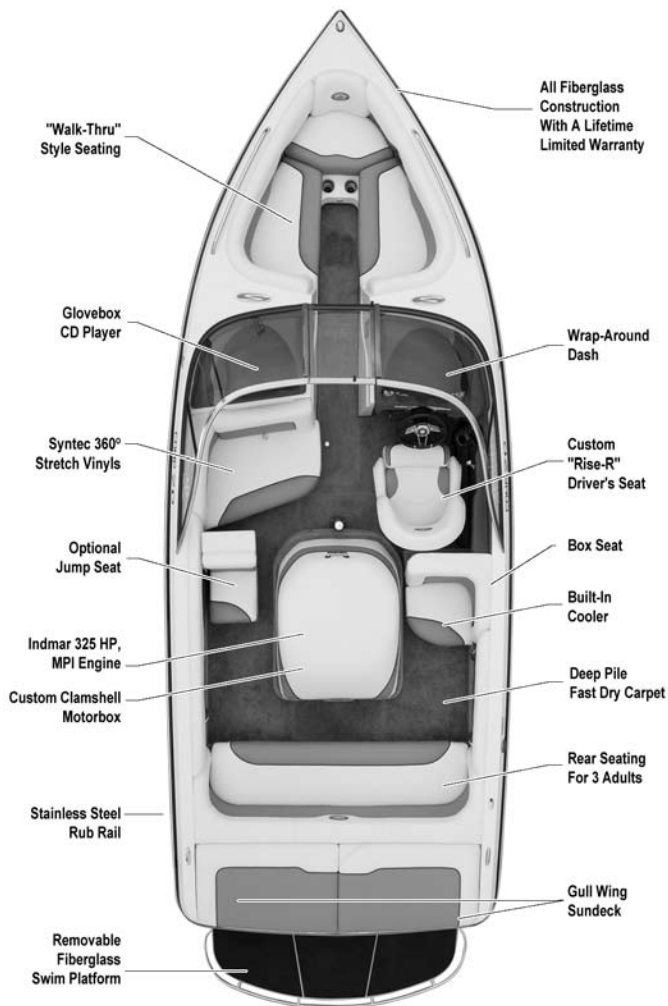

#### Boat Specifications:

Overall Length w/o Platform	20' 8"
Overall Length w/Platform	22' 10"
Overall Length w/Trailer	24' 8"
Width (Beam)	95"
Draft	22"
Weight - Boat Only	3,050 lbs.
Weight - Boat & Trailer	3,900 lbs.
Capacity - Passenger	10
Capacity - Weight	1,480 lbs.
Capacity - Fuel	34 gals.
Engine	325 HP, MPI V-8

#### Boat Specifications:

Overall Length w/o Platform	20' 8"
Overall Length w/Platform	22' 10"
Overall Length w/Trailer	24' 8"
Width (Beam)	95"
Draft	24"
Weight - Boat Only	3,200 lbs.
Weight - Boat & Trailer	4,050 lbs.
Capacity - Passenger	10
Capacity - Weight	1,480 lbs.
Capacity - Fuel	40 gals.
Engine	325 HP, MPI V-8

## Sunsport 22V

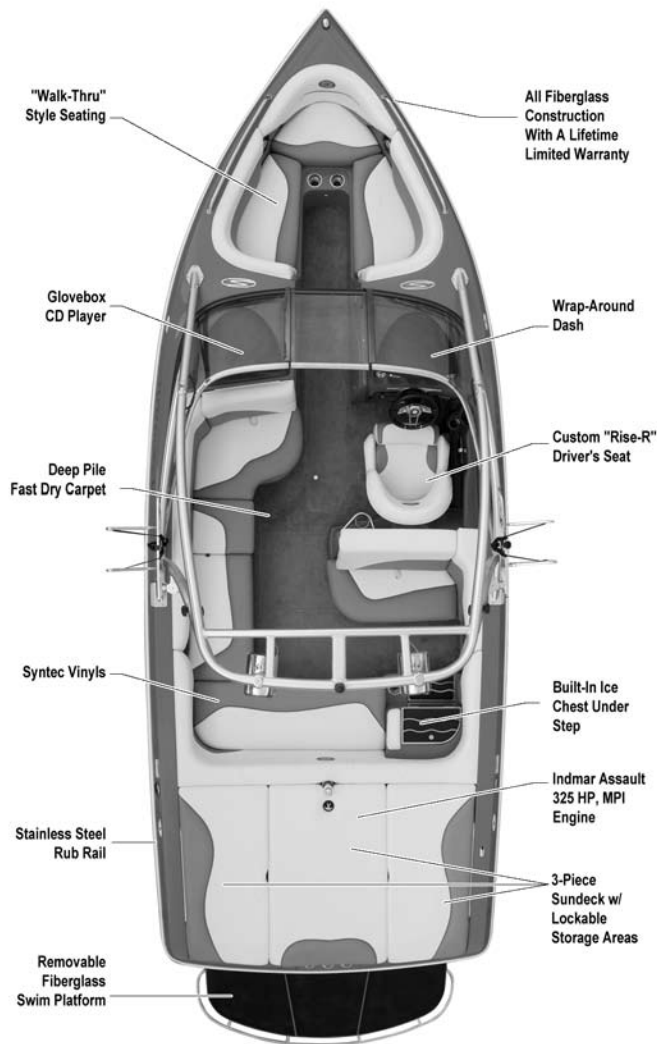

### Boat Specifications:

Overall Length w/o Platform	22' 6"
Overall Length w/Platform	24' 6"
Overall Length w/Trailer	26' 4"
Width (Beam)	100"
Draft	25"
Weight - Boat Only	3,800 lbs.
Weight - Boat & Trailer	4,900 lbs.
Capacity - Passenger	15
Capacity - Weight	2,100 lbs.
Capacity - Fuel	40 gals.
Engine	325 HP, MPI V-8

## Sunsport 24V

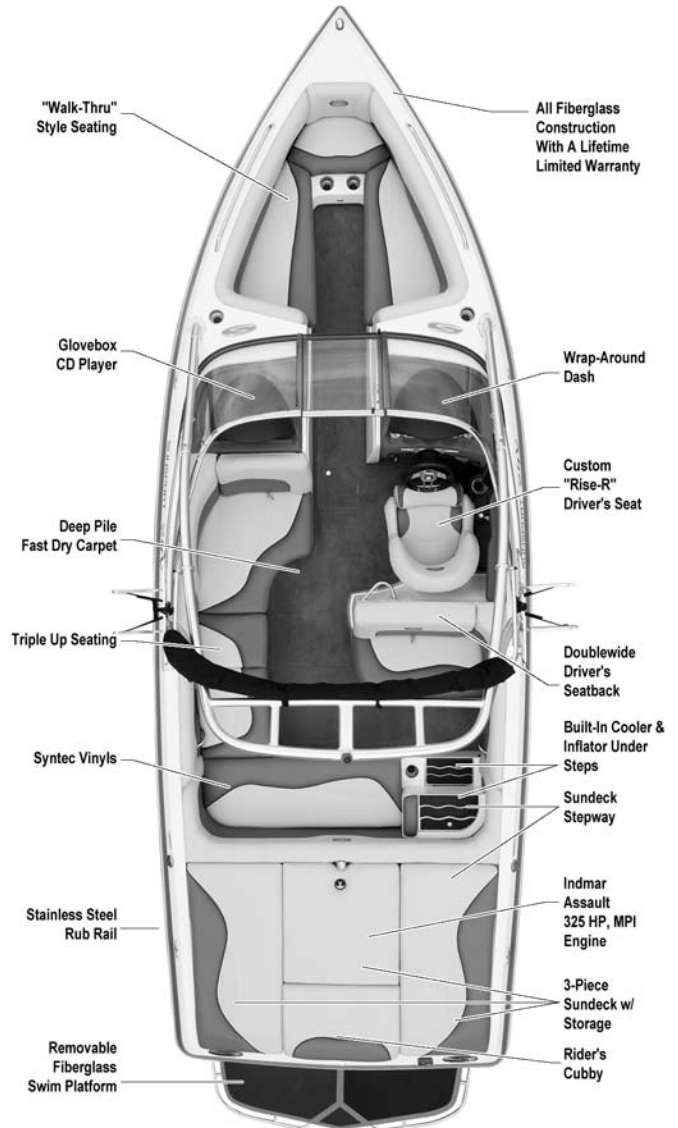

### Boat Specifications:

Overall Length w/o Platform	24'
Overall Length w/Platform	26'
Overall Length w/Trailer	27' 4"
Width (Beam)	102"
Draft	26"
Weight - Boat Only	3,950 lbs.
Weight - Boat & Trailer	5,050 lbs.
Capacity - Passenger	16
Capacity - Weight	2,300 lbs.
Capacity - Fuel	52 gals.
Engine	325 HP, MPI V-8

## Launch 20

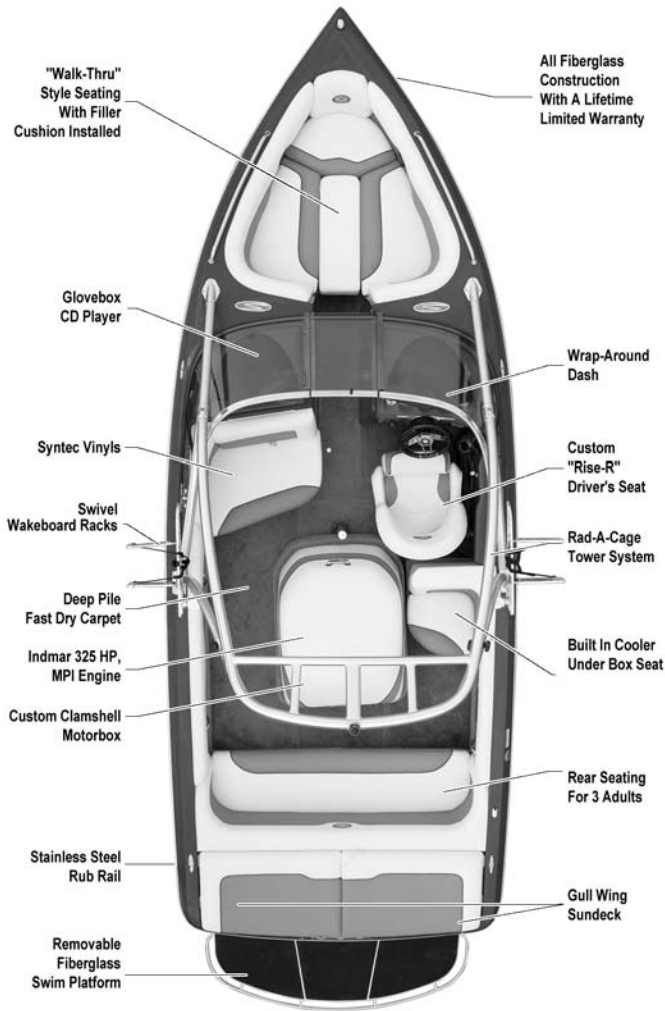

### Boat Specifications:

Overall Length w/o Platform	20' 8"
Overall Length w/Platform	22' 10"
Overall Length w/Trailer	24' 8"
Width (Beam)	95"
Draft	22"
Weight - Boat Only	3,050 lbs.
Weight - Boat & Trailer	3,900 lbs.
Capacity - Passenger	10
Capacity - Weight	1,480 lbs.
Capacity - Fuel	34 gals.
Engine	325 HP, MPI V-8

## Launch 20SSV

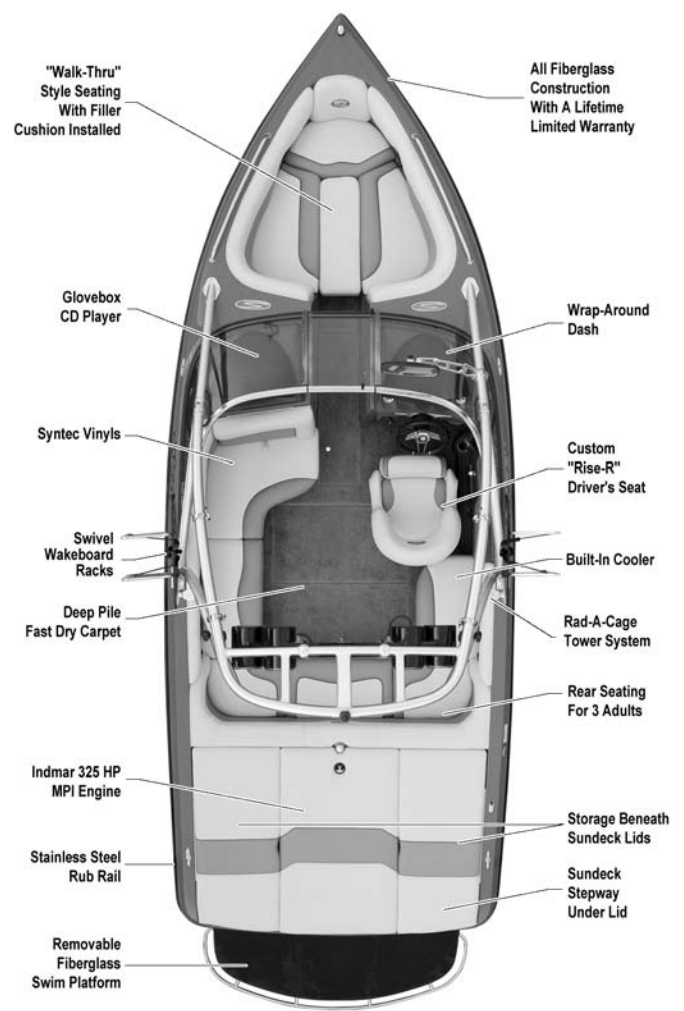

### Boat Specifications:

Overall Length w/o Platform	20' 8"
Overall Length w/Platform	22' 10"
Overall Length w/Trailer	24' 8"
Width (Beam)	95"
Draft	24"
Weight - Boat Only	3,200 lbs.
Weight - Boat & Trailer	4,050 lbs.
Capacity - Passenger	10
Capacity - Weight	1,480 lbs.
Capacity - Fuel	40 gals.
Engine	325 HP, MPI V-8

## Launch 21V

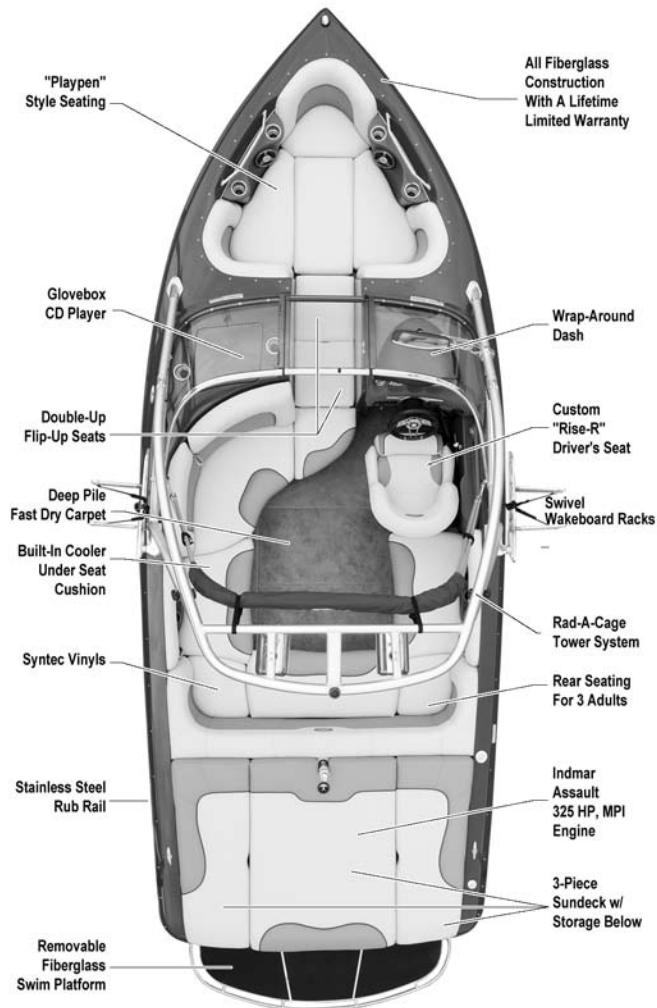

## Launch 22SSV

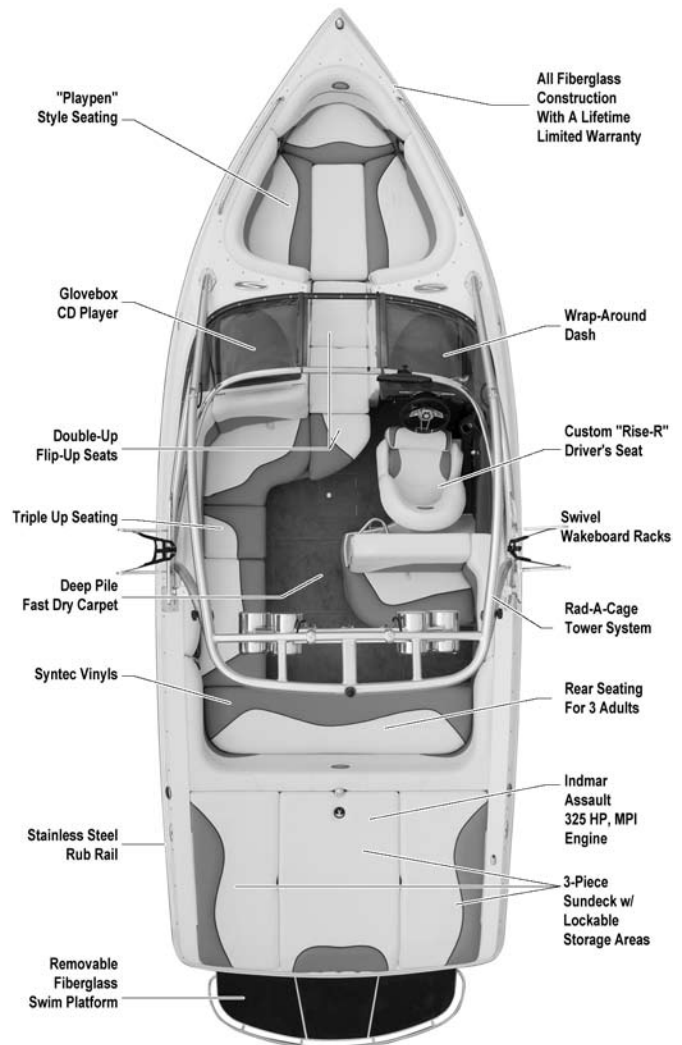

### Boat Specifications:

Overall Length w/o Platform	21' 2"
Overall Length w/Platform	23'
Overall Length w/Trailer	25' 2"
Width (Beam)	100"
Draft	25"
Weight - Boat Only	3,400 lbs.
Weight - Boat & Trailer	4,500 lbs.
Capacity - Passenger	13
Capacity - Weight	1,775 lbs.
Capacity - Fuel	40 gals.
Engine	325 HP, MPI V-8

### Boat Specifications:

Overall Length w/o Platform	22' 6"
Overall Length w/Platform	24' 6"
Overall Length w/Trailer	26' 4"
Width (Beam)	100"
Draft	25"
Weight - Boat Only	3,800 lbs.
Weight - Boat & Trailer	4,900 lbs.
Capacity - Passenger	15
Capacity - Weight	2,100 lbs.
Capacity - Fuel	40 gals.
Engine	325 HP, MPI V-8

# Launch 24SSV

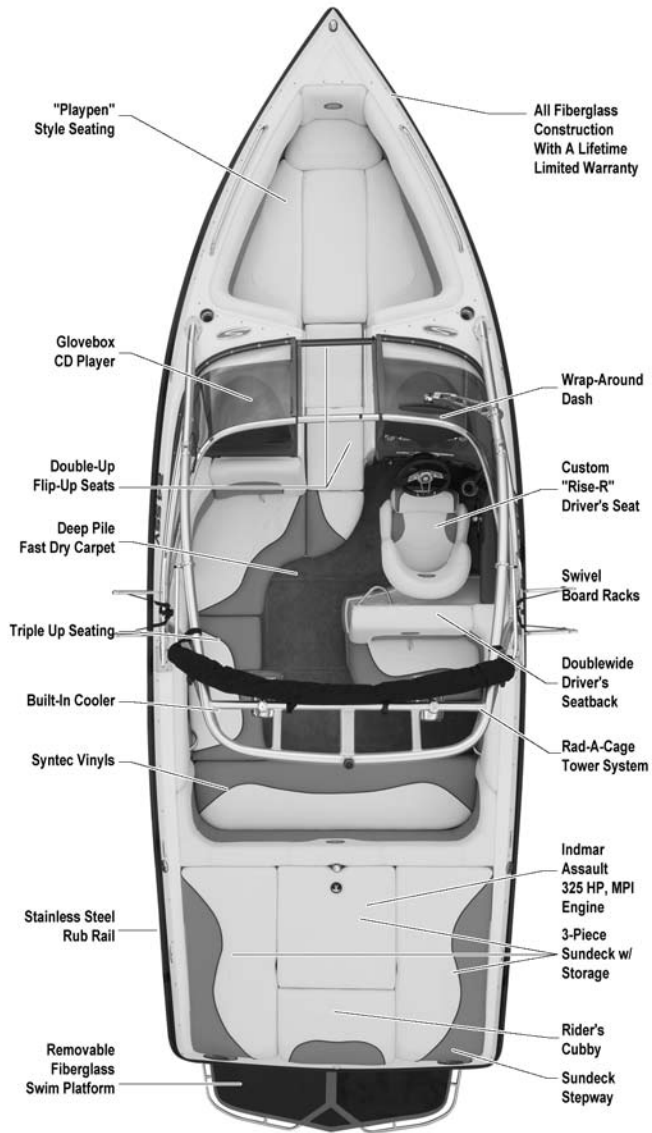

<b>Boat Specifications:</b>	
Overall Length w/o Platform	24'
Overall Length w/Platform	26'
Overall Length w/Trailer	27' 4"
Width (Beam)	102"
Draft	26"
Weight - Boat Only	3,950 lbs.
Weight - Boat & Trailer	5,050 lbs.
Capacity - Passenger	16
Capacity - Weight	2,300 lbs.
Capacity - Fuel	52 gals.
Engine	325 HP, MPI V-8

---

## Notes



## Break In Period

Taking care to properly break in your new engine will pay off in the long run. In our years of field testing, we have proven that an Indmar engine, when properly broken in according to our simple procedures, will last longer, run better and have fewer repairs over its lifetime.

Your new engine does not require an elaborate break-in procedure. Just follow these simple instructions and you are off to a great start.

The three (3) most important aspects of new engine break-in are:

1. Avoid running engine at high speeds.
2. Do not carry a heavy load (passengers, gear, etc.).
3. Vary your boat speed during break-in, don't run at the same RPM for a long period of time.

### BREAK-IN STEPS

- For the first hour, do not exceed 2,000 RPM.
- For the second hour, do not exceed 3,000 RPM.
- For the next five hours, do not exceed 4,000 RPM

### BREAK-IN TIPS

- Avoid fast accelerations and don't carry (or pull) a heavy load during this period.
- Always let engine warm up gradually before acceleration.
- Check oil frequently. During the first 50 to 100 hours, an engine can use more oil than usual. Maintain oil at a proper level at all times (do not overfill).
- Monitor transmission fluid levels.
- Report abnormal noises or vibrations to your dealer.
- Keep an eye out for loose mountings, fittings, nuts, bolts, and clamps.

During the BREAK-IN process, engine temperature should be carefully monitored and speed should be reduced if overheating is evident. ALSO, PLEASE REFER TO ENGINE OWNER'S MANUAL FOR BREAK-IN INFORMATION.

NOTICE: PLEASE REFER TO ENGINE OWNER'S MANUAL for maximum RPM and engine break-in procedure.

After the first 20 hours of operation, take your boat to the dealer for its first oil and filter change, as well as an engine checkup. Remember to keep a sharp eye on all gauges and warning lights during these first hours of operation. Report anything unusual to your dealer.

After the break-in procedure is over, your boat may be operated continuously at any speed.

### CAUTION

**Do not exceed maximum RPM recommended for your engine. Exceeding the maximum RPM may result in damage to the engine.**

### CAUTION

**Before starting your engine you must open the engine box and check engine compartment and bilge for gasoline and oil vapors.**



## Starting & Operation

A standard pre-starting procedure should always be followed before the first start-up of the day.

1. Check the engine oil level.
2. Check for gasoline fumes in bilge or engine compartment.
3. Operate engine blower for 4 minutes before starting the engine to remove any fumes.
4. Check manual operation of bilge pump. Make sure bilge areas are empty.

Other items might also be inspected, depending on the boat and its use. It is advisable to formulate a check list particular to the equipment and operation of your boat.

### REFER TO THE BOATMAN'S CHECKLIST OF THIS MANUAL.

Consult the local Coast Guard Auxiliary or Power Squadron for full details on boating safety.

**NOTE: Add-on electrical accessories should never be connected to the ignition terminal or ignition circuit.**

**IMPORTANT: DO NOT** continue to operate the starter for more than 15 seconds at a time without pausing to allow the starter motor to cool down for at least 2 minutes. This will also allow the battery to recover between starting attempts. PLEASE REFER TO ENGINE OWNER'S MANUAL FOR ADDITIONAL DETAILS.

**BEFORE STARTING ENGINE, BE SURE THAT THE SHIFT SELECTOR IS IN NEUTRAL.**

The correct starting procedure depends upon the type of engine. Please refer to the engine manual before starting.

## Coast Guard Regulations

The United States Coast Guard boating regulations prescribe minimum standards of safety to be met and maintained by all watercraft. It is necessary that your boat remain in compliance with these regulations.

The staff at Skier's Choice, Inc. recommend that all boat operators complete a Coast Guard approved boating safety course.

## Maximum Capacities



In compliance with United States Coast Guard Regulations, Supra Boats meet or exceed all safety standards designed for recreational boats. To ensure safe handling and performance, each Supra boat displays a maximum capacity sticker (see sample), stating the maximum total weight load allowable.

**NOTICE: Refer to the Maximum Capacity Sticker on your boat for allowable loading.**



**Do not exceed the maximum capacity of the boat.**

A standard pre-starting procedure should be always be followed before the first start-up of the day.

1. Check the engine oil level.
2. Check for gasoline fumes in bilge or engine compartment.
3. Operate engine blower for 4 minutes before starting the engine to remove any fumes.
4. Check manual operation of bilge pump. Make sure bilge areas are empty.

Other items might also be inspected, depending on the boat and its use. It is advisable to formulate a check list particular to the equipment and operation of your boat.

#### **REFER TO THE BOATMAN'S CHECKLIST OF THIS MANUAL.**

Consult the local Coast Guard Auxiliary or Power Squadron for full details on boating safety.

**NOTE: Add-on electrical accessories should never be connected to the ignition terminal or ignition circuit.**

**IMPORTANT:** DO NOT continue to operate the starter for more than 15 seconds at a time without pausing to allow the starter motor to cool down for at least 2 minutes. This will also allow the battery to recover between starting attempts. PLEASE REFER TO ENGINE OWNER'S MANUAL FOR ADDITIONAL DETAILS.

#### **⚠ DANGER**

**BEFORE STARTING ENGINE, BE SURE THAT THE SHIFT SELECTOR IS IN NEUTRAL.**

The correct starting procedure depends upon the type of engine. Please refer to the engine manual before starting.

#### **⚠ DANGER**

**Do not start engine if gas fumes are present.**

## To Start Electronic Fuel Injection (EFI) Engine

1. Place shift selector in Neutral with the throttle in the upright (zero) position. (If throttle is not in the idle position, the throttle position sensor will not allow the engine computer to proceed with a normal starting procedure).
2. Turn Ignition Key to Start Position to operate the starter.
3. Release the Key when engine starts (key will return to run position).
4. Allow the engine to establish a good idle (30 to 60 seconds) before getting underway.
5. Shift slowly into forward or reverse, allowing the transmission time to engage before powering up.

**NOTE:** It is normal for the idle to speed up in cold start conditions.

#### **⚠ CAUTION**

DO NOT continue to operate the starter for more than 15 seconds at a time without pausing to allow the starter motor to cool down for at least 2 minutes. This will also allow the battery to recover between starting attempts. PLEASE REFER TO ENGINE OWNER'S MANUAL FOR ADDITIONAL DETAILS.

**NOTE:** Should the EFI engine become "flooded" use the following procedure to start:

1. Place shift selector in Neutral and disengage the transmission by pushing the transmission lockout button located at the bottom of the lever.
2. With the transmission disengaged push the lever forward to full throttle position. (This will cause the computer to shut off the fuel injectors which will allow the engine to clear of excess fuel during starting).
3. Turn the Ignition Key to Start Position and operate the starter for no more than 15 seconds at a time until the engine starts.
4. When the engine starts, back off the throttle and allow the engine to establish a good idle (30 to 60 seconds).
5. Return the throttle to idle position and the transmission lockout will automatically reengage the transmission in neutral position.
6. When ready to get underway, shift slowly into forward or reverse, allowing the transmission time to engage the gearing before powering up.

**NOTE: See also "EFI Phased Warm-Up"**

## Engine Warm-Up

Always let engine warm up to normal operating temperature before accelerating.



Supra Team Rider — Josh Sanders

## Throttle Lever



The throttle lever controls both the throttle and the transmission. The idle position (normally vertical) is the zero throttle position and the neutral position for the transmission. A safety ring (umbrella) keeps the lever from being accidentally moved to engage the transmission.

To place the transmission into gear, with your hand placed over the lever ball, pull up on the safety ring (umbrella) and slowly push the lever into forward gear or slowly pull the lever back into reverse gear.

### CAUTION

Never shift the lever directly from the neutral (vertical) position into a speed position.

- To prevent damage to the transmission always allow the transmission time to engage before accelerating the engine.
- Once the transmission's engaged, you may accelerate as quickly as you like.

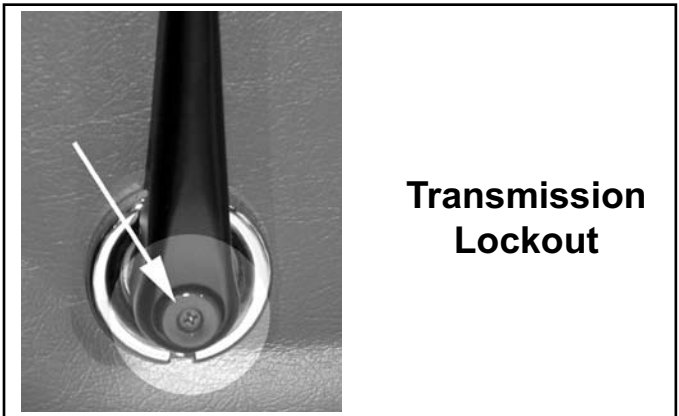

The Transmission Lockout button allows the transmission to be disengaged while giving the throttle full operating range. With the lever in the idle position (normally vertical) push the button located at the bottom of the lever to disengage the transmission. The throttle may then be operated in any open position (forward of neutral or back of neutral upright position). Return the throttle to idle position, and the transmission lockout will automatically reengage the transmission in neutral position.

## Bilge Area Center Drain Plug

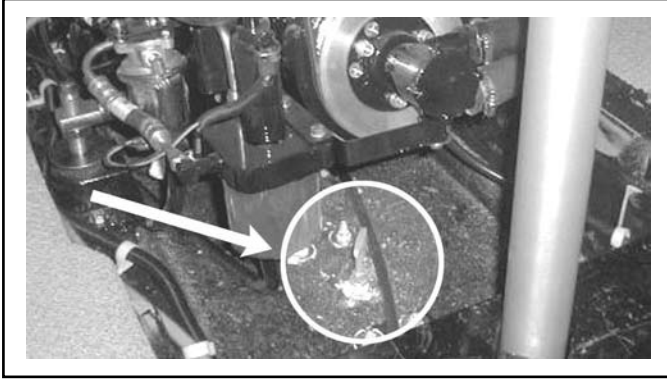

The bilge area center drain plug is located at the front of the motor well, directly under the engine.

It is extremely important that the drain plug is always checked before starting the engine. The drain plug should be secured in place using a wrench.

**NOTE: Not all Supra models have center drain plugs.**

### **⚠ WARNING**

**DO NOT** start engine until center drain plug is checked and secured in place. **DO NOT** try to install center drain plug while engine is running!

### **⚠ CAUTION**

Some Supra models **DO NOT** have mechanical devices to hold the motor box cover in the open position. Please use caution to prevent accidental closing.

## Rear Drain Plug



The rear drain plug is located at the back of the boat, near the bottom of the transom (See photo). It is extremely important that the drain plug is always checked before starting the engine. The drain plug should be secured in place using a wrench.

### **⚠ CAUTION**

**DO NOT** start the engine until the drain plug is checked and secured in place.

**DO NOT** try to install the drain plug while the engine is running.

## Fuel Precautions



Use a gasoline with a minimum octane rating of 89. The H.O. engine should use a minimum octane rating of 91. See engine owner's manual for more information.

### **⚠️ WARNING**

**DO NOT** use gasoline containing methyl alcohol (methanol). Methanol can damage your boat's fuel system.

### **⚠️ CAUTION**

Gasoline Stabilizer should be added to the fuel tank when the boat is used infrequently or whenever your boat will not be used for two weeks or more. During storage always add Gasoline Stabilizer to reduce gumming or tank sludge.

## Filling the Tank

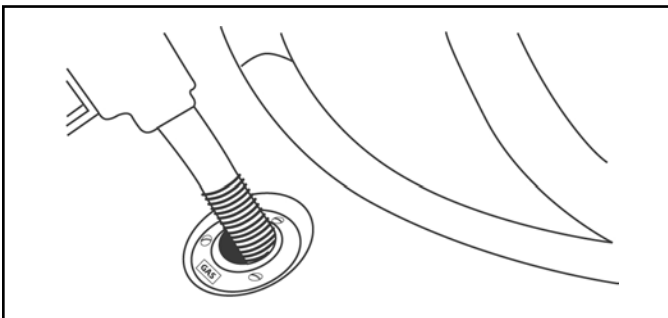

### **⚠️ WARNING**

- AVOID SERIOUS INJURY OR DEATH.
- FIRE, EXPLOSION AND SPLASHING FUEL HAZARD.
- IF TANK IS OVERFILLED, FUEL WILL DISCHARGE OUT THIS PORT.

WLFH0804

### **⚠️ CAUTION**

Be especially careful when filling the fuel tank. **DO NOT** over fill the tank. Fuel may empty through the fuel vent and damage to finishes could result.

If fuel is spilled on stripes or decals, apply a common bath cleaner (nonabrasive) and wipe with a damp cloth. Rinse the spill area with clean water.

## Fueling



### **⚠️ WARNING**

**Sparks while fueling could cause an explosion!**

### **Before Fueling:**

1. Turn off engine.
2. Turn off ignition.
3. Extinguish cigarettes or any open flame.

### **While Fueling:**

1. Keep hose nozzle in contact with fill pipe to provide a ground against static sparks.
2. Fill tank at a slow rate to avoid any spillage.

## Fuel Cap & Key



The fuel cap is located on the rear deck near the stern. A special fuel key is provided to open the cap.

**NOTE:** The cap is sealed by a rubber O-ring. Please do not over tighten.

The 22 and 24 Series boats, for extra convenience, have a fuel fill on both sides to allow for easy fueling.

## Section VIII

### Instrument Panel & Controls



This section provides the information needed to understand and operate the Medallion Instrumentation System installed on all Supra Boat Models.

The instrument system includes gauges, digital displays, and a Graphical Information Center to communicate vital real-time information about the status and performance of the boat to the driver. By just glancing at the dash, the driver can determine:

- Boat Speed
- Perfect Pass™ Status
- Trim
- Depth
- Engine RPM
- Remaining Fuel
- Lake Temperature
- Air Temperature
- Engine Oil Pressure
- Engine Coolant Temperature
- Battery Voltage

### Supra Helm Station Layout

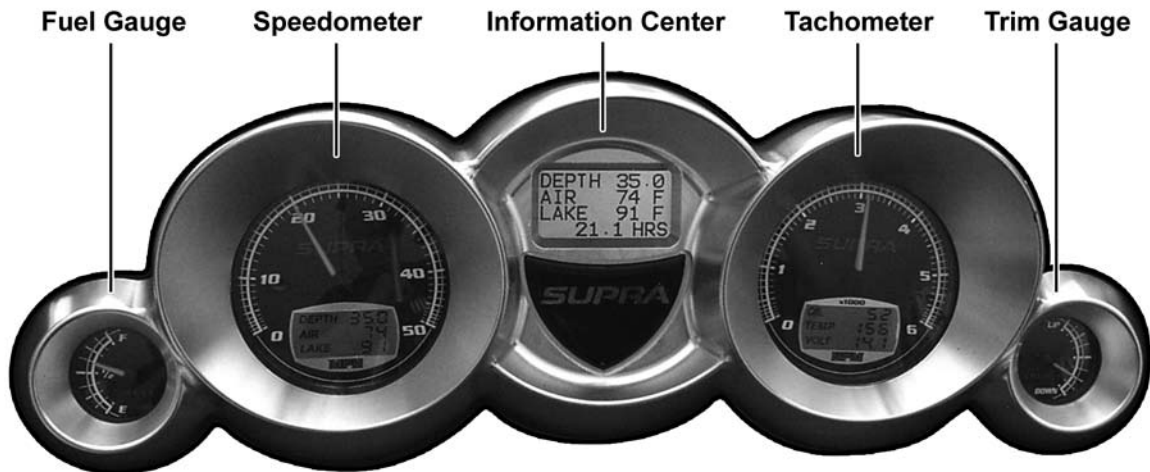

#### Slalom Course Speeds:

MPH	Seconds	Allowable
+ or - 1/2 MPH		Times / (Secs)
18	32.19	32.0 - 32.6
20	28.97	28.0 - 28.6
30	19.31	19.0 - 19.6
32	18.11	17.9 - 18.3
34	16.95	16.8 - 17.2
36	16.08	15.9 - 16.3

(Times are from start gate to end gate)

Speed may be checked using a stopwatch and a standard slalom course.

Speed may also be checked by using a hand-held GPS.

## Tachometer



The tachometer indicates the engine revolutions per minute (RPM). Engine Oil Pressure, Engine Coolant Temperature, and Battery Voltage are also continuously displayed in a Digital Display located within the Tachometer.

**DO NOT** exceed the recommended RPM during break-in and normal operation of your motor. Exceeding the manufacturer's suggested RPM may cause damage to the engine.

### Oil Pressure

The top line of the digital display indicates the pressure of the lubricating oil inside the engine. Oil Pressure varies with the engine speed. Oil Pressure typically varies from 6 PSI at 1,000 RPM up to 80 PSI or greater at cruising speeds. Low oil pressure may be caused by a low oil level or other potentially serious problems. If you experience low oil pressure, stop your engine immediately and investigate before resuming operation.

### **CAUTION**

**Running the engine with low oil pressure may cause severe engine damage.**

### Coolant Temperature

The second line of the digital display indicates the temperature of the cooling water inside the engine. The normal operating temperature will range from 140 degrees F to 190 degrees F. If you observe excessive engine temperature, stop your engine immediately and investigate before resuming operation.

**NOTICE: Refer to your Engine Owners Manual for additional details.**

### **CAUTION**

**Damage from overheating an engine IS NOT warrantable.**

## Battery Voltage

The voltage displayed indicates the battery voltage when the engine is running or the battery voltage when the engine is stopped. By monitoring the displayed voltage, the driver can become aware of charging system problems and have them repaired before starting difficulties occur. The voltmeter should indicate a voltage between 13.5 and 16 Volts when the engine is running. The voltage of a fully charged battery is 12.7 to 12.8 volts when the engine is stopped. A completely discharged battery will produce 12.0 volts or less.

## Speedometer



The speedometer indicates the water speed of the boat in miles per hour. It is recommended that the speedometer be checked for accuracy periodically.

The Depth, Air Temperature, and Lake Temperature are continuously displayed in a digital display located within the speedometer.

## Speedometer Paddle Wheel

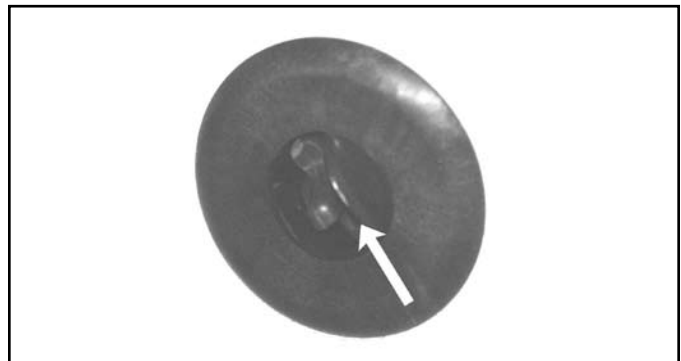

The Speedometer pickup is a paddle wheel located on the bottom of the boat. Poor water conditions may cause the wheel to become clogged or give incorrect information.



## Fuel Gauge

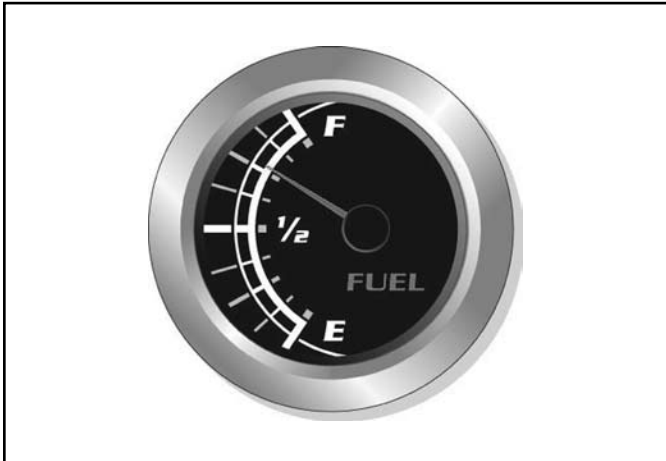

The Fuel Gauge indicates the amount of fuel remaining in the fuel tank.

This gauge indicates the approximate quantity of fuel remaining in the tank when the ignition is in the "ON" position.

**NOTICE: DO NOT run the tank to empty. To prevent condensation from forming in the tank, it is recommended that the tank be filled when the gauge indicates 1/4 tank of fuel remaining.**

The following conditions may be considered normal operation of the fuel gauge and fuel system:

- Gas station pumps may shut off before the fuel gauge indicates FULL.
- The amount of fuel required for fill-up may not exactly correspond to the gauge.
- The gauge needle may not move away from FULL until some time after fill-up.
- The gauge needle may move around when boat is in motion.

**NOTICE: Become familiar with engine hourly fuel consumption at various speeds and know when to check the fuel gauge.**

## Trim Gauge



The Trim Gauge indicates the position of the Wake Plate.

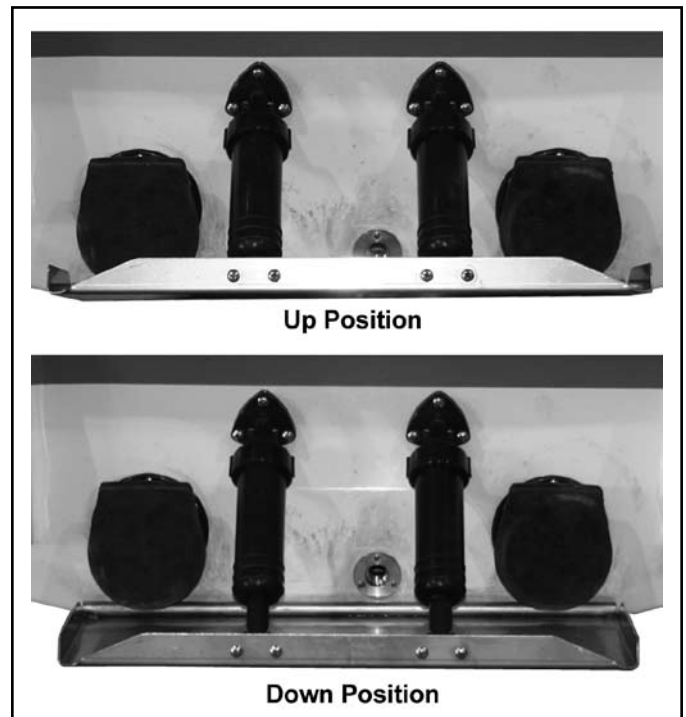

## Information Center



The Info Center located in the center of the dash supports many of the system's Key features:

- It is the graphical display for the embedded Perfect Pass Speed Control System.
- It can digitally display: Speed, Engine RPM, Oil Pressure, Coolant Temperature, Battery Voltage, Remaining Fuel, Depth, Air Temperature, Water Temperature, and Engine Hours.
- It allows access to Set Up Screens from which you can:
  - Calibrate the speedometer.
  - Adjust the Display Contrast.
  - Select either English or Metric Units.
  - Adjust the calibration of the Trim Gauge.
  - Run Diagnostic Routines.

The Available Information is divided into manageable pages or screens and organized into a straightforward menu structure for presentation to the driver. Display controls, conveniently located to the right of the helm, allow rapid navigation of the menu structure to display the desired information.



**Instrument System Display  
Control Buttons**

**Stereo Remote**

**Perfect Pass™  
Control Buttons**

The four buttons to the left of the Stereo Remote are Screen Navigation buttons dedicated to the Instrument System Screens:

- The SCROLL UP ARROW and SCROLL DOWN ARROW buttons are used to navigate through the screens, scroll through lists, and adjust stored values.
- The ENTER button is used to access sub-menu screens, select an item in a list, and store new values.
- The BACK button is used to return from sub-menu screens.

The four buttons to the right of the Stereo Remote are dedicated to the Perfect Pass Speed™ Control System. Once the Speed Control System is activated by pressing the ON/OFF button, the Info Center is dedicated solely to the Perfect Pass™ system until it is turned off.

- The ON/OFF button is used to turn the speed control system on and off.
- The SCROLL UP ARROW and SCROLL DOWN ARROW buttons are used to adjust stored values, select settings, and edit settings.
- The MENU button is used to move around within a screen and scroll through lists.

## Info Center Display Modes

Since the Info Center is used to support both the Instrument System and the Perfect Pass™ Speed Control System, it has two operating modes:

- **Perfect Pass™ Speed Control Mode**
- **Instrument System Mode**

Once the Speed Control System is activated by pressing the ON/OFF button, the Info Center is in Speed Control Mode and dedicated solely to the Perfect Pass™ system until the Speed Control System is switched off by pressing the ON/OFF button again.

While in Perfect Pass™ Speed Control Mode, the display responds to the Speed Control Buttons and displays only Speed Control Screens.

While in Instrument System Mode, the display responds to the Instrument System Display buttons and displays only Instrument System Screens.

Perfect Pass™ Speed Control Mode cannot be entered from an Instrument System Mode set up screen.

When power is applied, the Supra Logo is displayed while the instrument system is initializing and performing self checks. Once the initialization routines are complete, the Info Center returns to the operating mode it was in when the power was removed. If it was in Instrument System Mode, it returns to Instrument System Mode and displays the MAIN SCREEN. If it was in Perfect Pass Mode, it returns to speed control mode and displays the screen that was being displayed when the power was removed.

## Instrument Screens Road Map

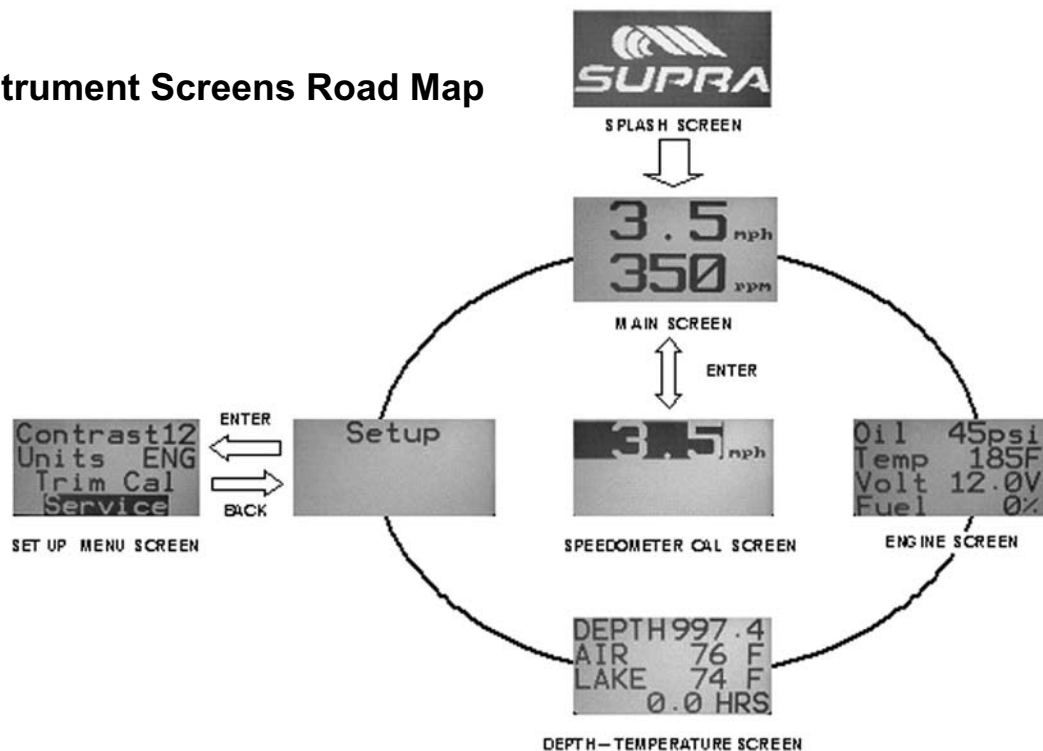

The Instrument System data is organized into 6 screens as illustrated above.

- The Main Screen
- The Engine Screen
- The Depth — Temperature Screen
- The Set Up Screen
- The Set Up Sub Menu Screen
- The Speedometer Calibration Screen

## Info Center Screen Descriptions

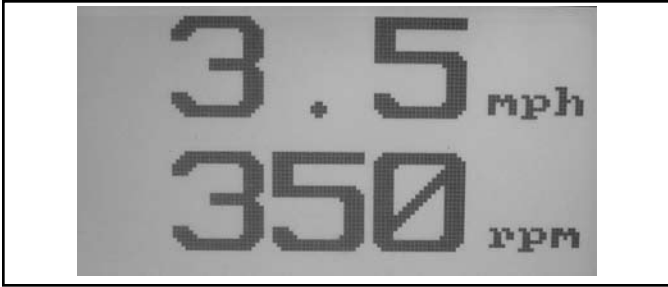

### Main Screen

The Main Screen displays digital speed and engine RPM in a large font size.

The indicated speed may be displayed in either English or Metric units as selected in the Set Up Menu screen.

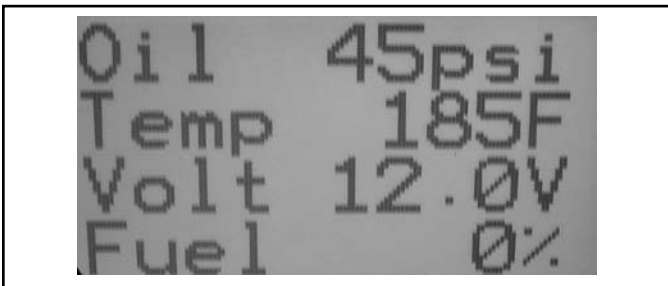

### Engine Screen

The Engine Screen displays engine oil pressure, engine coolant temperature, battery voltage, and the percentage of fuel remaining.

The oil pressure and coolant temperature may be displayed in either English or Metric Units as selected in the Set Up Menu screen.

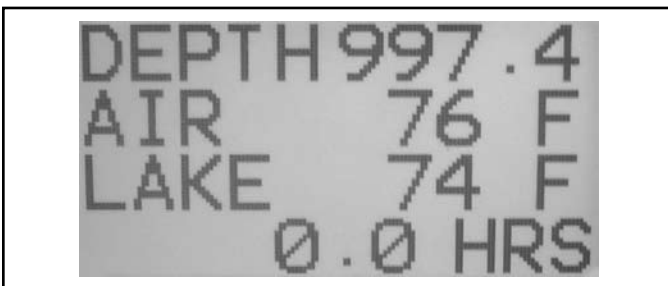

### Depth - Temperature Screen

The Depth — Temperature Screen displays depth of the water under the boat, the air temperature, the water temperature, and the total engine hours.

The depth, lake, and air temperature may be displayed in either English or Metric Units as selected in the Set Up Menu screen.

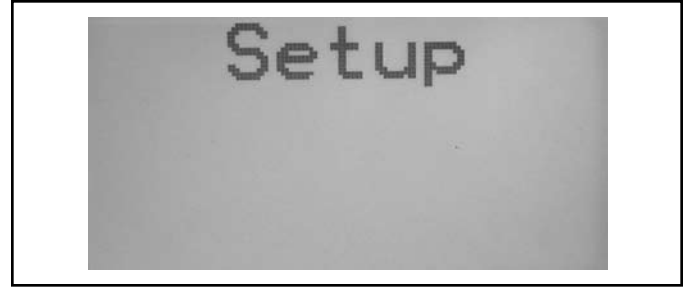

### Set Up Screen

The Set Up Screen is the gateway to the Set Up sub-menu from which you can adjust the displays contrast, select the desired display units, calibrate the Trim Gauge, and run diagnostic routines.

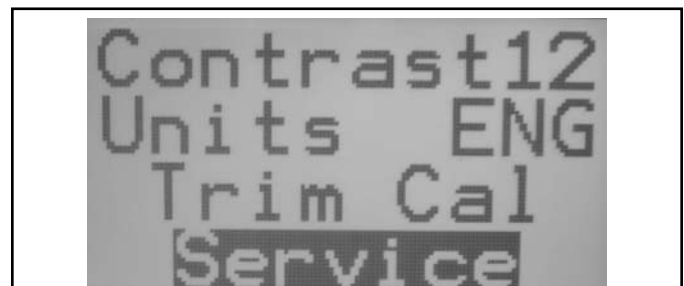

From the Set Up screen, push the Enter button to display the Set Up Menu screen.

## Set Up Procedures

Note: All system set up parameters are pre-set at the factory and normally do not require adjustment in the field.

### Speedometer Calibration

1. With the Info Center in Instrument System Mode, use the SCROLL UP ARROW or SCROLL DOWN ARROW buttons to display the Main screen.
2. Push and hold the Enter button for 3 seconds to display the Speedo Calibration screen.
3. While holding a constant speed compare the displayed speed against your standard (stop watch or GPS) and use the SCROLL UP ARROW or SCROLL DOWN ARROW buttons to adjust the displayed speed to agree with the standard.
4. Once the speeds are in agreement push the Enter button to store the calibration and return to the Main screen.

## Set Up Procedures (continued)

### Contrast Adjustment

1. With the Info Center in Instrument System Mode, use the SCROLL UP ARROW or SCROLL DOWN ARROW buttons to display the Set Up screen.
2. Push the Enter button to display the Set Up Menu screen.
3. Use the SCROLL UP ARROW or SCROLL DOWN ARROW buttons to highlight the Contrast line in the menu.
4. Push the Enter button.  
Once the Enter button is pushed, the highlighted line will start flashing on and off indicating that the system is in data entry mode.

The Contrast is set at 12 at the factory. Lowering that number will make the screen appear lighter and increasing that number will make the screen darker.

5. Use the SCROLL UP ARROW or SCROLL DOWN ARROW buttons to adjust the contrast to the desired level.

Changes in the contrast take effect immediately, so you can see the effect on the display as you make the adjustment.

6. Push the Enter button to store the new value. The Contrast line will stop flashing.
7. Push the Back button to exit the Set Up Menu screen.

### Unit Selection

1. With the Info Center in Instrument System Mode, use the SCROLL UP ARROW or SCROLL DOWN ARROW buttons to display the Set Up screen.
2. Push the Enter button to display the Set Up Menu screen.
3. Use the SCROLL UP ARROW or SCROLL DOWN ARROW buttons to highlight the Units line in the menu.
4. Push the Enter button.  
Once the Enter button is pushed, the highlighted line will start flashing on and off indicating that the system is in data entry mode.
5. Use the SCROLL UP ARROW or SCROLL DOWN ARROW buttons to toggle between English and Metric Units.
6. Push the Enter button to store the new value. The Units line will stop flashing.

### Unit Selection (continued)

7. Push the Back button to exit the Set Up Menu screen.

The following parameters change in value in response to a change in units:

Depth	Digital Speed
Air Temperature	Oil Pressure
Lake Temperature	Coolant Temperature



### Running System Diagnostics

1. With the Info Center in Instrument System Mode, use the SCROLL UP ARROW or SCROLL DOWN ARROW buttons to display the Set Up screen.
2. Push the Enter button to display the Set Up Menu screen.
3. Use the SCROLL UP ARROW or SCROLL DOWN ARROW buttons to highlight the Service line in the menu.
4. Push the Enter button.  
The Service screen will be displayed.
5. Use the SCROLL UP ARROW or SCROLL DOWN ARROW buttons to highlight the Gauge line in the menu.
6. Push the Enter button. The Gauge line will start flashing.
7. Use the SCROLL UP ARROW or SCROLL DOWN ARROW buttons to select between the NORM, SWEEP, FULL, and ZERO options.
8. Push the Enter button to activate the selected gauge exercise routine.  
Note: Once the exercise routine is initiated, it will run until the NORM option is once again selected or until the Back button is pushed to exit the Service screen.
9. Pushing the Back button again will exit the Set Up Menu screen.

## Set Up Procedures (continued)

### Resetting the Perfect Pass™ System

1. With the Info Center in Instrument System Mode, use the SCROLL UP ARROW or SCROLL DOWN ARROW buttons to display the Set Up screen.
2. Push the Enter button to display the Set Up Menu screen.
3. Use the SCROLL UP ARROW or SCROLL DOWN ARROW buttons to highlight the Service line in the menu.
4. Push the Enter button.
5. The Service screen will be displayed.
6. Use the SCROLL UP ARROW or SCROLL DOWN ARROW buttons to highlight the RESET PP line in the menu.
7. Push the Enter button.
8. Push the Back button to exit the Service screen.
9. Push the Back button again will exit the Set Up Menu screen.

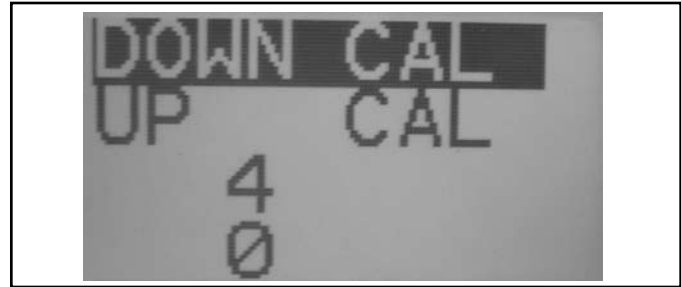

### Trim Gauge Calibration

Note: The Trim Gauge is calibrated at the factory and need not be recalibrated unless the indicated trim position no longer agrees with the physical position of the wake plate at its extremes.

1. With the Info Center in Instrument System Mode, use the SCROLL UP ARROW or SCROLL DOWN ARROW buttons to display the Set Up screen.
2. Push the Enter button to display the Set Up Menu screen.
3. Use the SCROLL UP ARROW or SCROLL DOWN ARROW buttons to highlight the Trim Cal line in the menu.
4. Push the Enter button.
5. The Trim Cal screen will be displayed.
6. Use the SCROLL UP ARROW or SCROLL DOWN ARROW buttons to highlight the Down CAL line in the menu.
7. Push the Enter button.
8. The DOWN CAL line will be highlighted and flashing. Use the Manual Trim Switch to run the Trim Tab all the way down and push the Enter button to store the down value. The DOWN CAL line will stop flashing and indicate DONE.
9. Use the SCROLL DOWN ARROW buttons to highlight the UP CAL line in the menu.
10. Push the Enter button.
11. The UP CAL line will be highlighted and flashing.
12. Use the Manual Trim Switch to run the Trim Tab all the way up and push the Enter button to store the up value. The UP CAL line will stop flashing and indicate DONE.
13. Push the Back button to exit the Trim Cal screen.
14. Push the Back button again to exit the Set Up Menu screen.

## Stereo



Please refer to your stereo owner's manual for proper operation instruction.

NOTE: Stereo unit is connected to the Stereo switch on the switch panel. The "Stereo" switch must be in the "ON" (lighted) position before the stereo can be turned on.

## STANDARD SUPRA PACKAGE\*

### NAVIGATION LIGHTS SWITCH

The Navigation Light switch supplies power to the Bow Light, the Stern Light and the Pole Light.

**For Operation**  
(Refer to Illustration Below)



### BILGE PUMP SWITCH

The bilge pump switch operates in two positions. The manual position is used to verify that the pump is operational.

The automatic pump function is engaged at all other times so that any excess water in the bilge may automatically be pumped out.

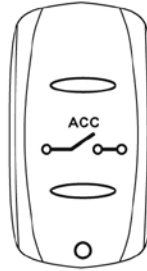

### COURTESY LIGHTS SWITCH

The Courtesy Lights switch supplies power to the interior lights located throughout the boat.

### ACCESSORY SWITCH

The Accessory switch supplies power to an extra circuit for accessories that may be added (such as heaters, optional stereo, etc.)

### DOCKING LIGHTS

The Docking LT switch supplies power to the docking lights.

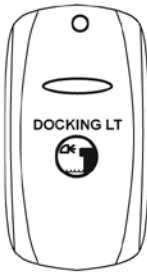

### STEREO SWITCH

The Stereo switch supplies power to the stereo unit. The switch must be turned on before the stereo can be played.

### OPTIONAL TOWER LIGHT SWITCH

If the optional lights are installed on the boat, this switch controls its function.

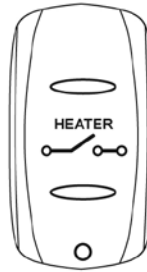

### HEATER SWITCH

If the optional heater is installed on the boat, this switch controls its function.

### NOTICE

If any lights, bilge, stereo, courtesy lights, or accessories fail to operate, press the appropriate circuit breaker located under the switch.

### NAVIGATION LIGHTS

When underway during night time operation, set the switch in the NAV position to activate all of the running lights.

When docked or at anchor, set the switch, in the ANC position to activate only the pole light.

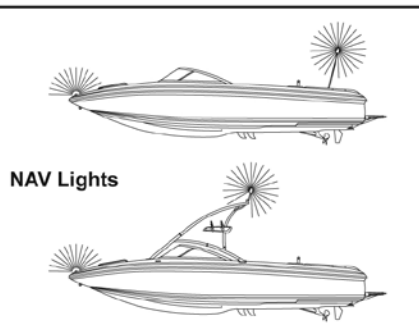

NAV Lights

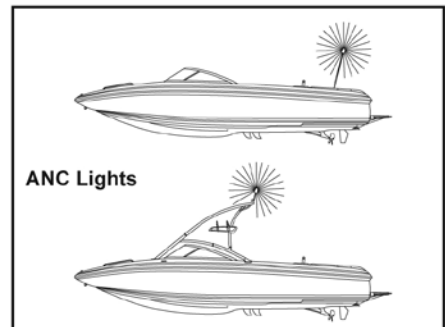

ANC Lights

\*Switch configuration may vary slightly based on options. If you have any questions regarding operation, please contact your dealer or Skier's Choice, Inc.



## Ignition Switch



Located on the port side of the dashboard, the ignition switch has three positions. In the vertical position the ignition is OFF. With the key in, turn the ignition switch one notch to the right to check all electrical equipment, including blower, pump, and lights. Turn the ignition all the way to the right to operate the starter.

**NOTE: All electrical equipment should be turned off when the boat is in storage.**

## Blower Switch



The blower switch activates the blower motor. The primary function of the blower fan is to remove any fumes from the bilge area. The blower also draws fresh air into the engine compartment.

Never depend solely on the blower to eliminate dangerous fumes. Before starting the engine, always open the motor box to check if fumes are present. Switch on the blower fan a minimum of four minutes before starting the engine.

**NOTICE: If the blower fails to operate, reset the circuit breaker. If the blower still does not operate, notify your Supra dealer.**

### **⚠ DANGER**

Failure to operate the blower in accordance with the Coast Guard Recommendation could result in an explosion.

## Horn Switch



The Horn Switch is located on the port dash panel near the ignition. Sound the horn by depressing the button.

## Horn/Whistle Signals

One Long Blast:

*Warning Signal (Coming out of slip)*

One Short Blast:

*Pass on my Port Side*

Two Short Blasts:

*Pass on my Starboard Side*

Three Short Blasts:

*Engines in Reverse*

Four or More Blasts:

*Danger Signal*

1. OVERTAKING / PASSING: *Boat being passed has the right-of-way. KEEP CLEAR.*
2. MEETING HEAD-ON: *Keep to the right.*
3. CROSSING: *Boat on the right has the right-of-way. slow down and permit him to pass.*

## Tilt Steering

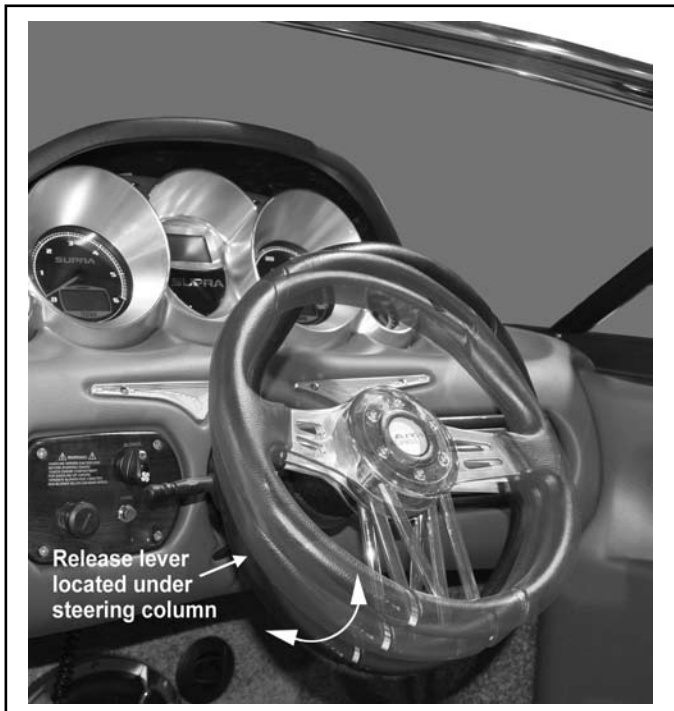

Tilt steering may be adjusted up or down in five different locking positions. To adjust, depress the tilt lever located beneath the bezel and move the steering wheel to the desired position. Release the lever to lock the wheel into place.

## Safety Lanyard/Engine Shut Off Switch



Your Supra is equipped with a Safety Lanyard/Engine Shut Off switch. In order for the engine to run, the plastic tip of the safety lanyard must be attached to the switch. If the clip is removed from the switch, the engine will not run.

### **WARNING**

**Avoid serious injury or death. Attach Safety Lanyard to driver prior to operating boat.**

## V-Drive Warning Light



The V-Drive transmission in your Supra is equipped with a "low pressure" warning light. This light is located by the dash. Do not operate your Supra if the warning light remains on, whenever the engine speed is above, 1,200 RPM (+/- 400 RPM). This warning light should be on whenever the engine speed is below 1,200 RPM (+/- 400 RPM). If this light remains on during operation above idle, shut your engine off immediately and check your v-drive oil level and see your dealer.

## Circuit Breaker Panel

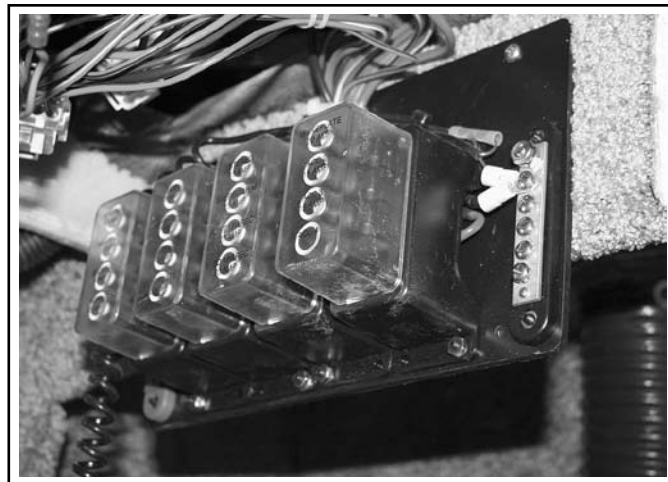

The circuit breaker panel contains breakers for all electrical equipment. The panel is located below the dashboard on the side wall nearest the driver's left knee.

If a switch fails to operate, locate the corresponding circuit breaker and press the reset button. If the equipment still does not operate, notify your Supra dealer.

## Gravity Ballast System



The optional Gravity Ballast System is an electronically controlled ballast system that can be operated from the driver's seat. The Gravity system is available in a 1 or 3 position system. The switch panel to the 3 position system is located directly below the shifter mechanism, and the 1 position system is operated from a switch on the dash. Each switch allows independent filling and draining of each ballast container by simply hitting the fill or drain switch. If the system fails to fill or drain, you may check the resettable breaker on the switch panel, or the separate ballast fuse block located under the dash area. The ballast bags or tanks can be found in the front ski locker, under the rear seat, or in the rear v-drive storage areas depending on the the model and ballast system.



**CAUTION** When bags begin to vent, shut off!

**WARNING** Do Not overfill ballast bags!

Care should be taken that the ballast bags are situated properly with the fill hose on top and drain hose on bottom and that all fittings are installed securely. The bags should not be twisted and the bags should be free to expand and drain completely. Care should be taken to prevent sharp objects from coming in contact with the bags. Cuts and punctures to the bags are not warrantable.

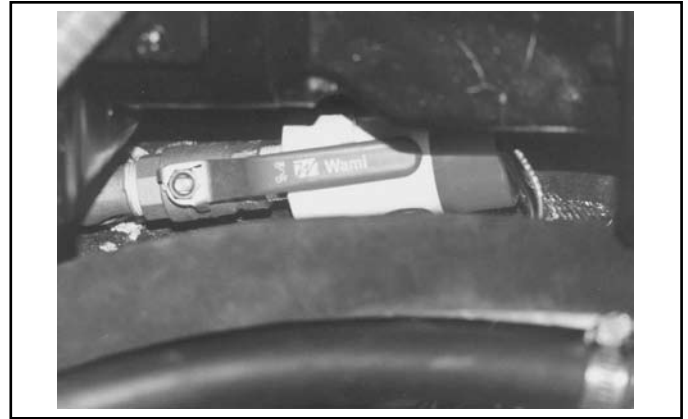

Each Gravity Ballast system also includes a manual shut off valve in case of emergencies. If closed, the valve will prevent any water from entering the system and is only used in emergency situations. Under normal use the valve should remain open to allow full flow of water into system.

### Priming the System

To allow water into the system, the Gravity Ballast system utilizes a scooped intake strainer to force water into the system. This allows the ballast system to be filled while running or sitting still. If air becomes trapped in the system, it may be necessary to run the boat at planing speeds to force water into the system and allows the fill pump to prime fully. Once the pump has primed it is no longer necessary to run the boat for filling. This situation may occur if the boat is trailered.

## DC Outlet



For your convenience, a DC outlet has been included on the panel to the right of the driver's seat. Some models have receptacles located in the glovebox. Location varies by model.

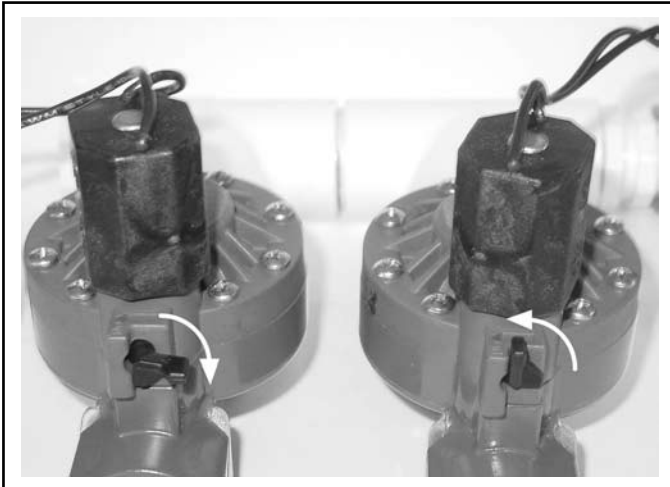

The Gravity Ballast system utilizes a manifold and a solenoid valve to independently fill each bag or tank. The solenoid valves have a small toggle switch that can manually override the opening of the valve. The manual toggle switch needs to be in the "down" position to allow the system to be controlled by the switches in the dash area. If the manual toggle switch is turned to the "up" position, the valve will be open all the time and cannot be controlled by switches in the dash area. If the ballast system fills continuously while running the boat, check to make sure the manual override toggle switch is in the "down" position. If it continues to fill and the manual toggle switch is in the "down" position, check for debris that may have clogged the solenoid valve forcing the valve to stay open. If the valves continue to fill, closing the manual emergency shut-off valve will prevent any water from entering the system.



Each Gravity Ballast system also includes an in-line water strainer before the manifold. This strainer will keep debris out of the solenoid valve and should prevent the valve from getting clogged up and forced open. The strainer cover should be removed periodically and the filter screen cleaned to prevent debris buildup on the mesh screen. Be careful when removing the cover not to lose the O-ring used to seal the cover. Also, the strainer should be removed and drained during winterization.

To fill the ballast system, press the fill switch. To empty, press the empty switch. With the ballast full, the boat may porpoise at speeds above 25 mph.

### **⚠ WARNING**

**Empty ballast before trailering the boat. DO NOT trailer boat with ballast full!**

## Ignition Keys



Two ignition keys are provided with the boat. Key entry into the ignition may be difficult due to the boot protector. Please, do not unduly force the key into the ignition. Key tumblers are located vertically, thus the key should be vertical when placed into the switch.

**NOTE:** Always attach the ignition key and gas key to a floating key chain to prevent loss in the water.

## Fuel Cap Key



To prevent tampering with fuel system, your Supra is provided with a gas cap, which may be opened only with a special key.

**NOTICE:** The gas cap is sealed by a rubber O-ring. Do not over tighten!

### CAUTION

Always attach the ignition key and gas key to a floating key chain to prevent loss overboard.



Windshield Mounted Mirror

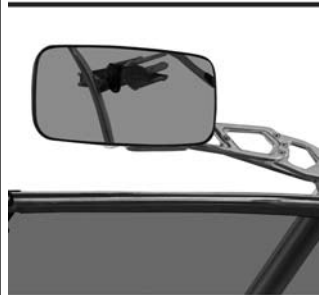

Tower Mounted Mirror

## Mirrors

The rear view mirror is installed as a standard item. The mirror is adjustable and is not permanently placed so that it may be set for each driver.

- Mirror should always be checked before driving.
- Mirror angle will change with each new driver.

## Driver's Seat & Seat Adjustment



The Rise-R Seat is a unique driver seat enhancement. The front edge of the driver's seat cushion lifts up to give the driver a taller sightline. To switch the seat to the raised position, use two hands to lift and push the front edge of the seat cushion up and back until it is sitting on the rear half of the driver's seat cushion. To switch to the lower position, use two hands to push the Rise-R seat cushion forward and down.

### **CAUTION**

Be careful of the articulating hinge. Do not place fingers or other objects in the hinge mechanism during use.

The driver's seat may be adjusted forward or backward by moving the lever below the front of the seat. Use body pressure to move the seat to the desired position. Release the lever then check to feel the seat lock into place.

### **CAUTION**

After adjusting the seat, be sure that it has locked into place by pushing forward and backward until it has securely latched. **DO NOT** attempt to adjust the driver's seat while the boat is moving.

## Inboard Motor Box



The motor box encloses the inboard engine and quiets engine noise. To open, stand on either side of the engine toward the stern seat. Grasp the handle and pull up at approximately a 45 degree angle. If the engine requires maintenance, open the box until it rests open.

The motor box base is fitted with quick release rubber hold-downs and stainless steel brackets for easy removal.

### **WARNING**

**Never open the Motor Box while the boat is moving!**

### **CAUTION**

Some Supra models **DO NOT** have mechanical devices to hold the motor box cover in the open position. Please use caution to prevent accidental closing.

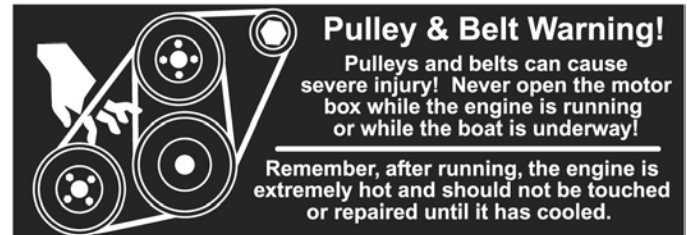

## V-Drive Engine Compartment

To access the engine compartment, turn latch and pull to raise the center sun deck lid. When the ski lockers and engine compartment lids are closed, the upholstered lids double as a cushioned sun deck.



## Fire Extinguisher



A standard United States Coast Guard approved fire extinguisher is provided with your Supra boat. The fire extinguisher is usually located under the observer's seat cushion, however, locations vary by boat. You should know the exact location of your boat's fire extinguisher in case of an emergency.

**NOTICE:** Refer to the instructions on the fire extinguisher for proper use.

## Flame Precautions

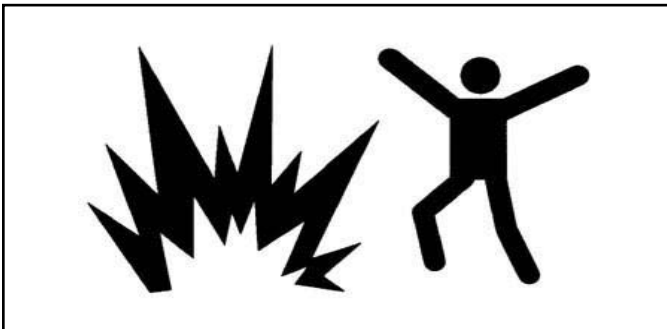

### **WARNING**

Sparks while fueling can cause explosion! Extreme caution should be taken when an open flame is present on board. Fumes from the engine and fumes from the battery are highly flammable. No flame or spark should come near these areas.

<b>WARNING</b>	
	• AVOID SERIOUS INJURY OR DEATH.
	• LEAKING FUEL IS A FIRE AND EXPLOSION HAZARD.
	• INSPECT SYSTEM REGULARLY. EXAMINE FUEL SYSTEM FOR LEAKS AND CORROSION AT LEAST ANNUALLY.

WLENG0803

## V-Drive Ski Pylon



The ski pylon is to be used to pull skiers. **DO NOT** use ski pylon to hoist boat! Only use the lifting rings for this purpose.

The 24 Series and 20V boats have a retractable ski pylon. To use, pull pylon up, twist counterclockwise and push back down into the lock position. To retract, pull pylon up, twist clockwise and push down to storage position.

### **WARNING**

**DO NOT** mount any Pylon Extension on the rear pylon (located at the rear sundeck).

## Inboard Ski Pylon



The ski pylon is located in the center portion of the boat directly in front of the motor box. The ski pylon is to be used to pull skiers. **DO NOT** use ski pylon to hoist boat! Only use the lifting rings for this purpose.

**NOTICE:** The use of pylon extensions may cause the pylon to loosen. Please see your dealer for proper tightening procedures.

### **WARNING**

The use of pylon extensions can severely effect the overall handling of the boat. Follow pylon extension manufacturers directions for mounting.

## Rad-A-Cage

If your Supra model has been equipped with an optional RAD-A-CAGE towing tower, please review this section for details on its usage, maintenance and storage. The cage is designed as a stable tower to enhance wakeboarding. It is NOT intended to be used to tow skiers, barefoot skiers, or multiple wakeboarders. Such use will void any warranties written or implied.

### **⚠ WARNING**

Before use, be sure that all mounting bolts are properly tightened in place.

### **⚠ WARNING**

Be aware of and avoid low overhead objects such as bridges, power lines, overhanging trees, etc.

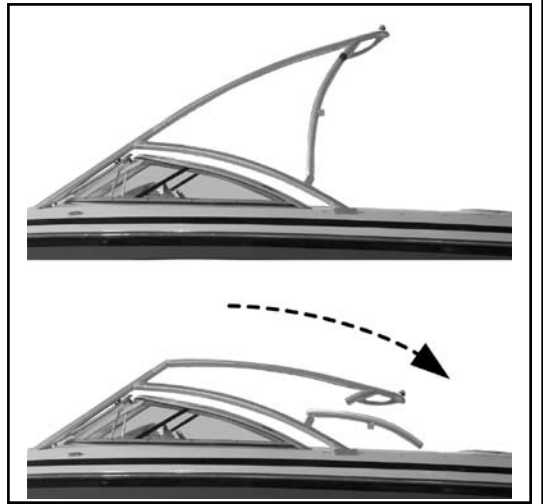

### To Raise Cage

- Lift the tower and swing up the rear legs. Install the four hand knobs.

### **⚠ CAUTION**

The threads in the aluminum foot could be damaged if the bolts are not aligned and threaded correctly.

### **⚠ WARNING**

The Rad-A-Cage is designed to pull a single (1) wakeboarder, trick skier, or kneeboarder.

**NOTE: Apply a thin coat of anti-seize to the threads of the hand knobs periodically.**

### To Lower Cage for Storage

- Remove the four hand knobs from the top of the rear leg. While holding the tower up, lower the side legs. Then lower the tower downward into the boat.

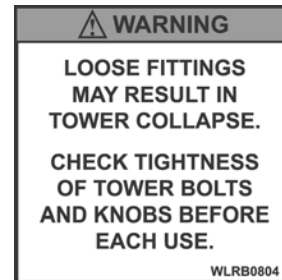



## Pole Light Receptacle

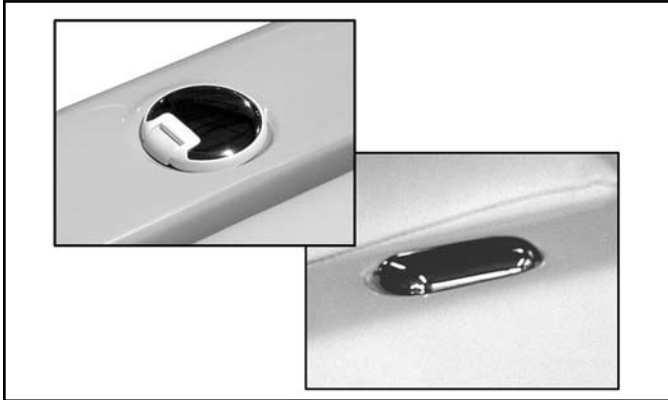

The pole light receptacle is located on the starboard of the stern, along side of the sun deck. To install pole light, slide open the weather cover and insert the pole light in the aligned position.

## Pole Light

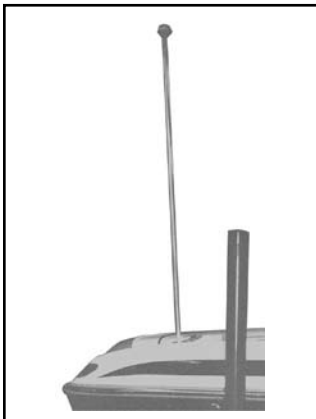

On some models, the removable pole light is stored on the side wall of the rear storage area. Gently pull the pole light from the mounting and place into the pole light receptacle.

The pole light must always be in place and illuminated when visibility is limited. The pole light must be displayed while underway from sunset to sunrise.

Boats equipped with factory installed towers do not have a stern light pole, even though the rear light receptacle is installed.

## Tower Navigation Light



Boats equipped with factory installed towers have the 360° White Pole Light mounted on the tower. The light can be illuminated by the "NAV" switch located on the panel.

## Bow Light

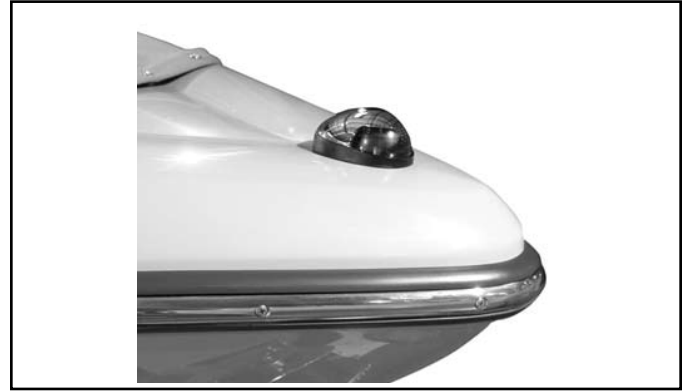

The bow light is located on the bow of the deck at the front of the boat. To alert other boaters to your position and direction, the light is green on the starboard side and red on the port side. The bow light is activated by the "NAV" switch.

## Courtesy Lights



Courtesy lights are installed at several locations in the interior of the boat. The courtesy light switch is located on the instrument panel and is marked "COURT".

## Stern Courtesy Light



Some Supra models are equipped with stern lights. The stern light is located at the center of the transom below the rub rail. The stern light is activated by the "Courtesy" light switch.

## Lifting Rings

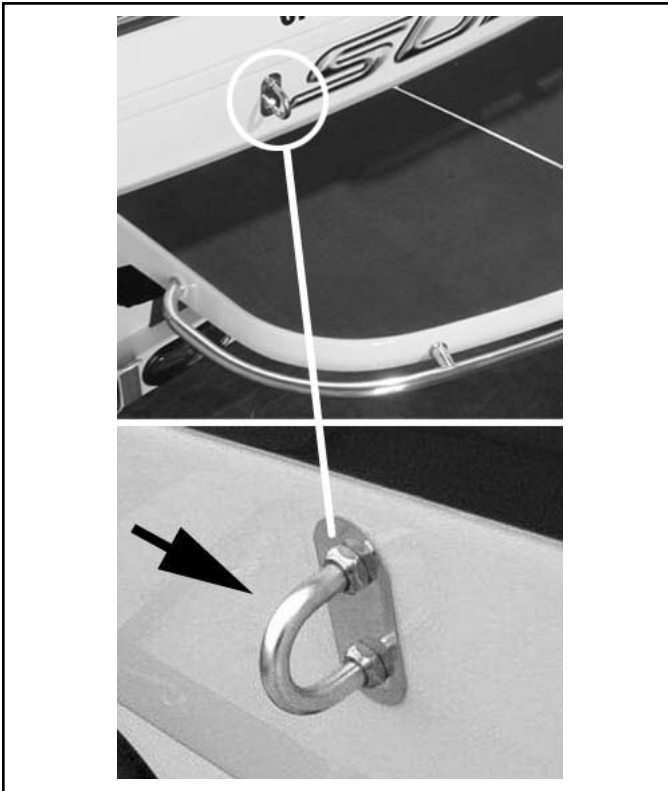

Two lifting rings are located on the transom.

## Ski Platform

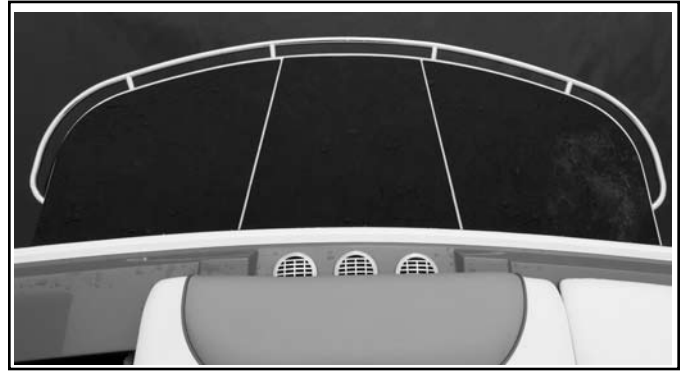

The transom mounted ski platform allows easy access to and from the water for skiers and swimmers.

It is recommended that entries to and exits from the water be made from the platform to avoid accidents. (The fiberglass deck can become slippery when wet)

### **⚠ DANGER**

Shut off the engine when people are on the platform or in the water near the platform.

### **⚠ DANGER**

Exhaust fumes contain carbon monoxide. Direct or prolonged exposure to carbon monoxide will cause brain damage or death.

### **⚠ CAUTION**

Children should be supervised while on the ski platform to ensure that their feet or legs do not get caught between the platform rail and platform.

## Bow Eye

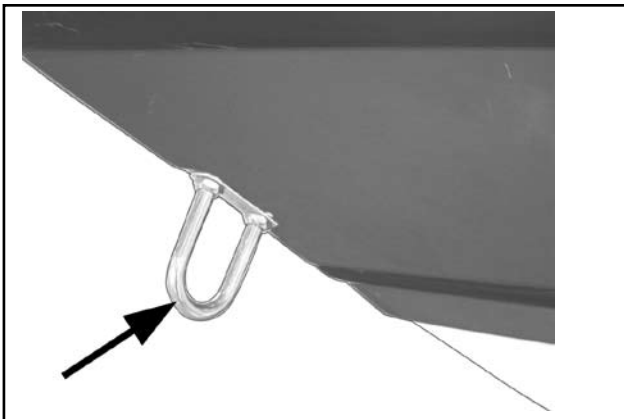

The bow eye is located at the front of the hull below the rub rail. It is the point of the attachment to lead the boat onto the trailer and to secure the boat to the trailer or to tie-off when docking.

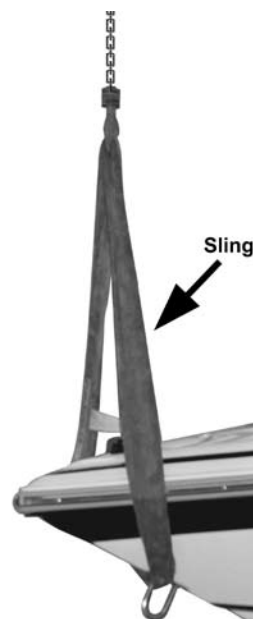

**NOTICE:** Do not use the bow eye ONLY to hoist the boat. You must use a sling with the bow eye when hoisting the boat. (See Hoisting Instructions)

## Detachable Bracket

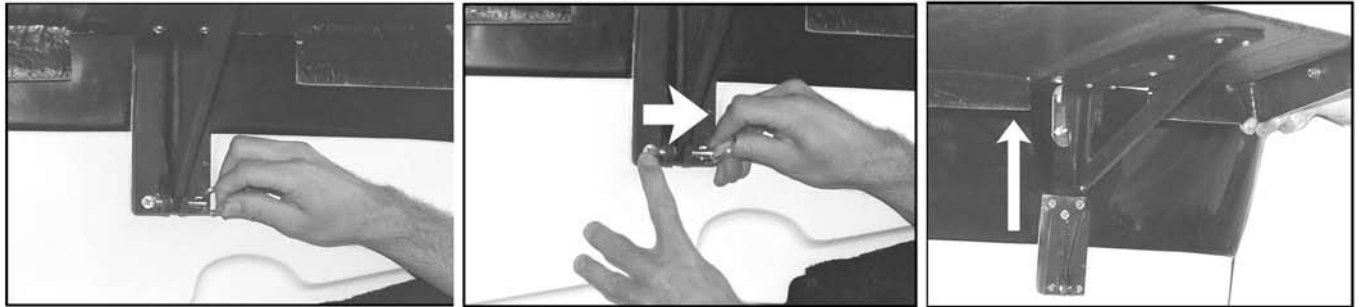

The ski platform is attached to the boat with detachable brackets. The platform may be removed from the boat by pulling the retaining pins from the brackets and lifting up and out.

## Ski Locker



Ski storage, depending on the model of Supra you own, is located either between the observer's seat and driver's console on most v-drives or can be found under the sun deck of inboard models. On storage found between the driver and observer's console, simply unstrap and lift to open. Models with ski storage at the rear of the boat can be accessed by grasping the strap and pulling up and forward.

## Bilge Inspection Plate

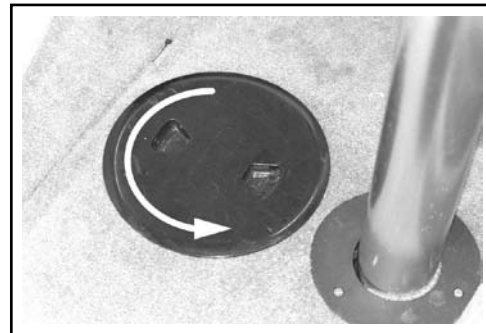

The fuel tank inspection plate/bilge inspection plate is located on the floor. Open the inspection plate by unscrewing it to check the condition of the fuel tank and wire harness or for water in the bilge.

**NOTICE:** Keep this area clean and free of dirt and debris.

## 20, 22 & 24 V-Drive Sundeck Stepway



The Supra 20, 22 and 24 V-drives offer a convenient stepway for either entering or exiting the boat. Lift the starboard side sundeck lid to access the stepway.

## Sundeck



When the ski locker is closed, the upholstered lid doubles as a cushioned sun deck.

## Propeller

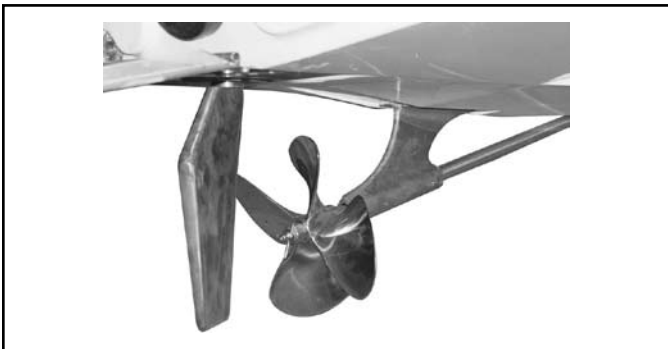

The research and design team at Skier's Choice has carefully explored and tested many different propellers and pitch angles for use on our boats. All tests indicate that the current propeller installed on your model is the best for the variety of boating performance required, whether skiing competitively or for pleasure.

It is strongly recommended that your Supra dealer be notified before changing the propeller. In general, changing to a lower pitched propeller may increase acceleration, but will decrease top speed. Changing to a higher pitched propeller may achieve higher top speed with a light load, while acceleration and power may decrease.

### CAUTION

**Avoid engine damage. Do not exceed the maximum RPM as listed for your motor. Some props may allow the engine to over rev, which can cause non-warrantable engine damage.**

### PROPELLER PRECAUTION!



A moving propeller will cause injury. The propeller may turn with the boat in neutral. Shut off the engine while skiers or swimmers are in the water near the ski platform.

**NOTICE:** Under no circumstances should a propeller be used which allows the engine to exceed manufacturer's recommended RPM's.

## Double-Up Seating



Some Supra models offer Double-Up Seating. This unique seating can be stored flat for easy access to the bow or flipped up for extra rear and forward facing seating. To use this seating, lift and pull the seat back into the locked position. Be sure that the metal arms are locked straight before applying pressure. To lay seat back down, simply push down on the middle section of the metal support arm.

## Triple-Up Seating

Both the 22 and 24 Series boats have "Triple-Up" seating. This unique type of seating can be stored flat or flipped up for extra rear facing seating. To use this seating, lift and pull the seat back into the locked position. Be sure that the metal arms are locked straight before applying pressure. To lay seat back down, simply push down on the middle section of the metal support arm.



## Altitude and Wakeboard Prop

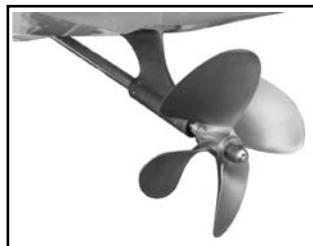

Supra offers an optional prop designed specifically for high altitude and wakeboarding. This prop may help boats perform better if the boat is being operated at elevations above 4,000 feet. This prop also helps boats specifically weighted for wakeboarding get on plane faster.

**NOTE:** This prop will reduce the top end speed of the boat.

**NOTE:** It will change the RPM-to-speed ratio and make it possible for the RPM limiter built into the engine to engage at full throttle.

## Hydraulic Wake Plate

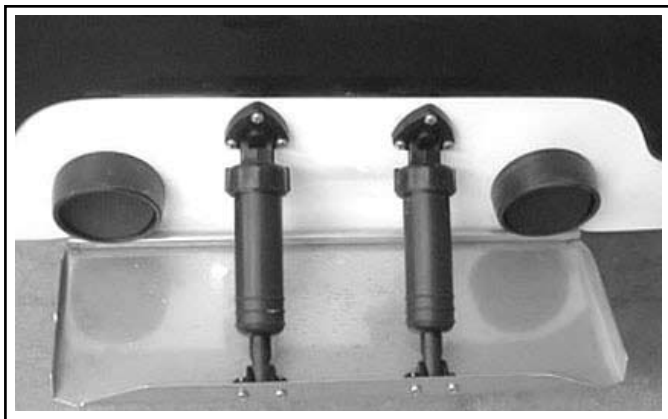

The hydraulic wake plate allows the driver to control the running attitude of the boat. It can be controlled by the switch on the dashboard.

## Trim Switch



This switch controls the optional hydraulic wake plate. The gauge indicates the position of the plate.

## Glove Box



To open the glove box, press the black round cylinder down while lifting the black finger tab. Once open, the lid is supported by a shock. To close the lid, push down on black finger tab.



To open the glove box, press the button on the door. To close the lid, simply push the lid back until it latches.

## Optional Boat Heater



The boat heater is a forced air heater that uses hot engine water as a heat source. To use the heater, simply turn the heater switch to the selected fan speed. In order for the heater to work, the engine must be at operating temperature. One of the features of the heater are the snorkel vents, which can be pulled out to direct heat to specific areas.

## Walk-Thru Windshield

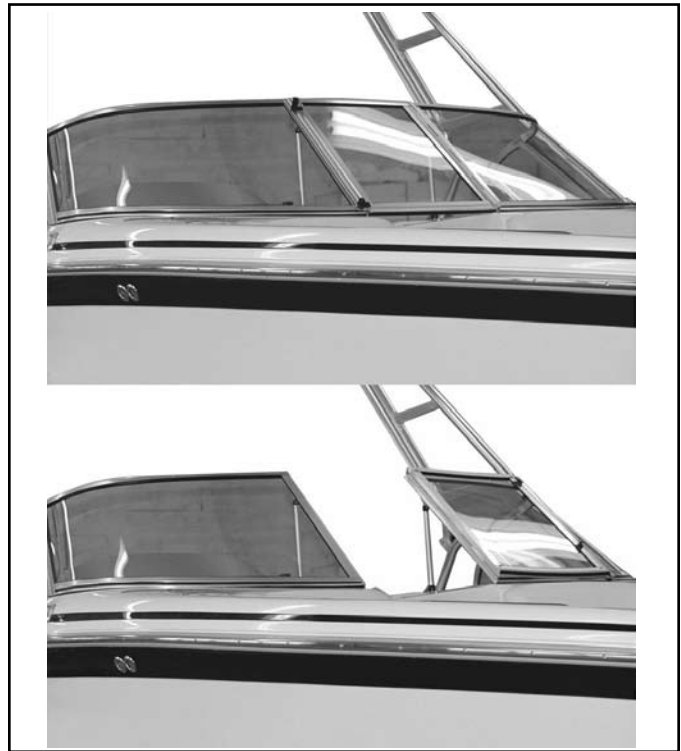

The movable center windshield panel allows access to and from the bow deck. To open, turn safety latches to vertical and push. Lay the center windshield panel gently against the fixed side panel.

## Optional Bimini Tops



The bimini top is designed as a sunshade. Please see the mooring cover section for instructions on cleaning and caring for your bimini top. When opening and latching the straps to the eye hooks, twist the strap one to two times to prevent them from vibrating in the wind.

### **CAUTION**

**DO NOT** operate the boat above 45 MPH with the bimini top open. Do not trailer the boat with the bimini top open.

## Battery Box



The battery is mounted inside the observer's seat storage compartment. Location may vary slightly depending on the model.

**NOTICE:** It is recommended that the battery cables be disconnected from the battery when the boat is placed in storage.

### CAUTION

Avoid damage or injury from battery acid. Ensure that the battery is properly secured before using boat.

## Dual Battery Option Hookup

The dual battery option is designed to give you extra battery power to run accessories, but at the same time give you a safety feature not commonly found in a dual battery setup. The Supra Dual battery option features a Voltage Sensitive relay which always monitors the engine starting battery so that your engine will always restart.

We recommend that the selector switch always be set to "1". In the "1" position, the Voltage Sensitive Relay monitors the engine starting battery, which will ensure that you have a fully charged battery to start your boat. The "House" or "Accessory" battery may become drained during a high discharge cycle since it does not get charged until the Starting battery is fully charged.

In position "1" when the Sensed battery (engine starting battery) reaches 13.7 volts, the relay closes and parallels both batteries. When this happens the LED light on Voltage Sensitive Relay comes on.

In position "2" the sensed battery is the accessory battery. We do not recommend using this position since it can cause the starting battery to drain, which would not allow the engine battery to have enough power to restart your boat.

In position "both", the batteries are paralleled and in a high discharge cycle, both batteries can become drained, which would not allow the engine battery to have enough power to restart your boat.

**NOTE:** It is recommended that you fully recharge your batteries using a battery charger periodically or after a session of high discharge (lots of accessories running for an extended period).

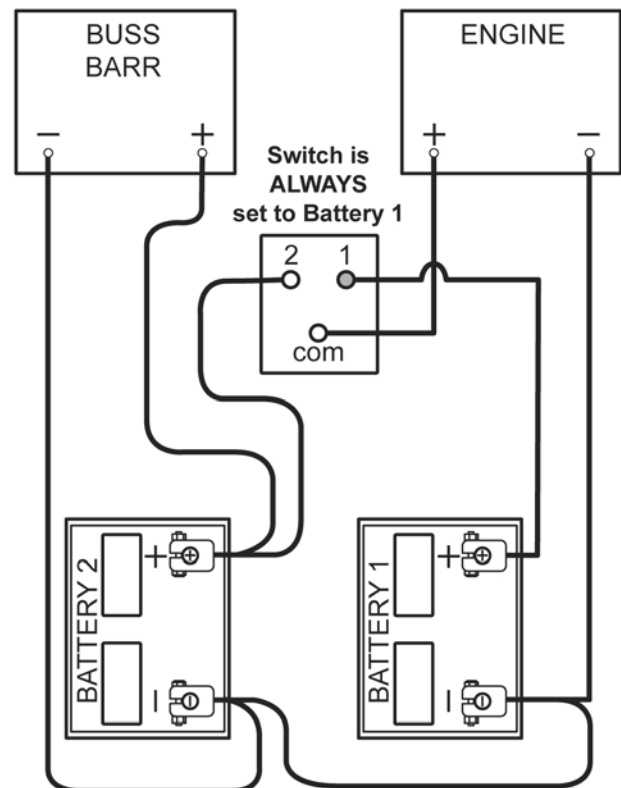

**NOTE:** It is possible with this system for accessories to shut down when the engine is running due to the accessory battery draining down. This is a safety feature. This system monitors the starting battery and will sacrifice the accessory battery so that you are not stranded on the water with a weak starting battery.

**NOTE:** We highly recommend using high quality "Dual-Purpose Batteries" in both the starting and house position.

## Cooler



Some Supra models offer built-in coolers. They are insulated and have drain holes that drain water into the bilge. Be sure to thoroughly clean the cooler and allow it to dry after each use to prevent mold and mildew.

## Wakeboard Racks

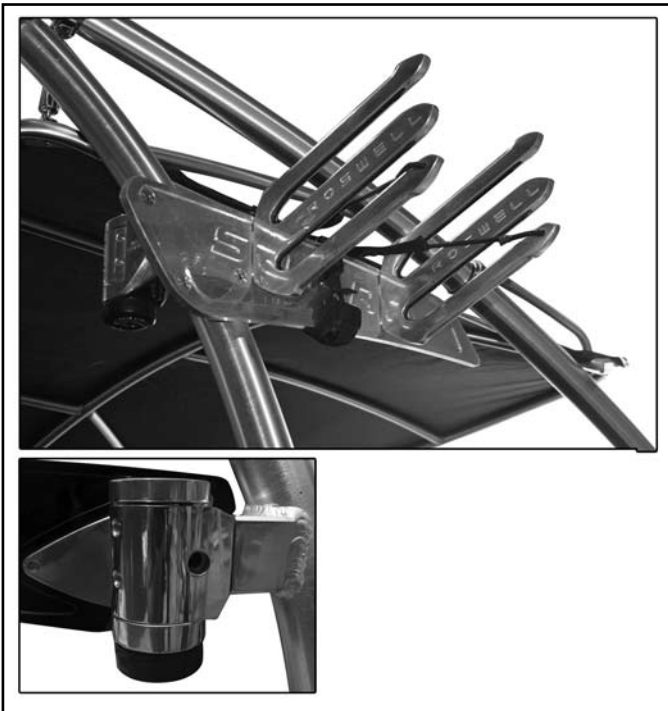

Wakeboard racks are a convenient way to transport and store wakeboards while using your boat.

Supras have swing arm wakeboard racks for easier loading and unloading of boards. The swing arm has a stop at 0, 90, and 180 degrees. To operate, push button on bottom of hinge and rotate to the next stop. Push next button to rotate again. Reverse steps to go other direction.

### **CAUTION**

- Place wakeboard swing arm in the 0 degree position prior to putting the boat in gear.
- Check tightness of all mounting hardware before each use.
- DO NOT trailer the boat with wakeboards mounted in the racks.

## Optional Tower Speakers



The optional tower speaker and light bar combo is a unit that houses both an additional set of tower speakers and lights. The speakers are designed to allow the rider to be able to hear the music. The tower speakers require the addition of an amplifier to power the speakers. The tower lights are designed to make docking, loading and unloading easier. The tower lights require the addition of a dual-battery electrical system.

**NOTE:** Tower lights are not to be used as running lights at night. USCG regulations mandate that a boat under power after sunset must display a 360 degree white light and a red/green bow light.

### **WARNING**

It is illegal to wakeboard, ski, tube, etc., after sunset and before sunrise in most states. It has been outlawed because it is dangerous. Tower lights do not make these activities legal or safe.

### **CAUTION**

Some lakes have noise restriction ordinances. The use of tower speakers may not be allowed in your area. Please check all applicable laws in your area regarding noise level restrictions.

## Transom Mount Stereo Remote



The optional transom mounted stereo remote allows the stereo to be controlled from the rear of the boat.

### **DANGER**

Keep away from rear of boat while the engine is running. Do not be on or about the swim platform while the engine is running or the boat is in motion.



## Mooring Cover



Your Supra boat cover is made from the finest canvas and webbing to ensure that your boat will be protected in the off season. The cover has been designed to fit securely around each boat.

Use the following procedure when covering the boat:

1. Be sure that the cover fits snugly at the bow then unfold from front to back.
2. Be sure to install cover pole(s) and adjust to proper height, using set screw on pole(s). This will keep water from gathering in the center, which can damage the cover.
3. Secure all fastening straps around the trailer frame.
4. Pull the draw cord equally from both sides and tie off to the lifting eyes on the stern in accordance with the illustration.

### Folding Cover

When folding the cover for storage, be sure the cover is dry. Take care not to scratch the canvas finish against rough surfaces. Store in a dry location.

### Cover Repair

If the cover becomes damaged, immediately patch and reseal the area. Use a tent seam sealer to reseal any new stitches. Spray fabric guard on scraped or worn surfaces. Canvas tears should be repaired professionally and stitches sealed to prevent leakage.

### **CAUTION**

**DO NOT trailer the boat with the mooring cover installed. The cockpit cover is not designed as a trailer cover and may come unsnapped or rip. This type of damage IS NOT covered by your boat warranty!**

## Optional Tonneau Cover



The optional tonneau cover is designed to snap over the bow of the boat. Its purpose is to minimize air flow into the cockpit area when the boat is in use and as a storage cover when used in combination with the optional cockpit cover.

### **CAUTION**

**DO NOT trailer the boat with the tonneau cover installed. The tonneau cover is not designed as a trailer cover and may come unsnapped or rip. This type of damage IS NOT covered by your boat warranty!**

## Optional Cockpit Cover



The optional cockpit cover is a snap down storage cover designed to help protect the interior of your boat. To install the cover, start at the windshield and work towards the transom. Be sure to install the cover poles to prevent water pocketing.

### **CAUTION**

**DO NOT trailer the boat with the cockpit cover installed. The cockpit cover is not designed as a trailer cover and may come unsnapped or rip. This type of damage IS NOT covered by your boat warranty!**

## Optional Stereo Amp



The stereo amplifier is an optional piece of stereo equipment that is designed to increase the wattage of the signal going to the speakers while minimizing distortion of this signal. Please see stereo amplifier owner's manual for more information.

### **CAUTION**

Using a stereo amplifier without boat engine running may drain the battery to the point where the boat will not restart. This condition may happen very quickly, depending on the size of the battery.

## Optional Subwoofer



The optional subwoofer is designed to increase the sound level of the bass notes. The amplifier powers the subwoofer. The bass level can be adjusted on the amplifier. Please see stereo amplifier owner's manual for more information.

## Optional Satellite Radio



The optional satellite radio is designed to give the user music access anywhere they go in North America. The system is a 100 channel system which is broken down into different music types such as: oldies, hard rock, easy listening, alternative, 80's, jazz, big bands, etc. This system does have a minimal subscription fee that must be paid annually to continue service. Please see satellite radio owner's manual for more information.

**NOTE:** Location of satellite antenna may vary by model.

## Optional Air Inflator



The Sunsport 24V model comes standard with an air inflator. It is a high volume, low pressure pump designed specifically for tubes, air mattresses, etc. To use the pump, pull the unit out of its storage compartment located to the rear of the walk through area and plug the cord into the 12 volt receptacle. Connect the hose of the inflator to air input on inflatable object and turn on.

### **CAUTION**

**DO NOT** leave air inflator running unattended.

## Optional Water Strainer

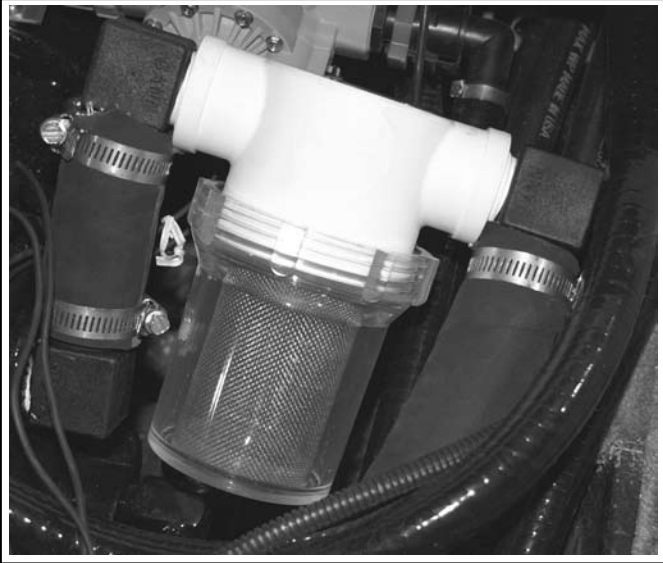

The optional engine water strainer is a filter for the engine cooling water. It is recommended for boats that are going to be operated in weedy conditions or other areas where debris could clog the engine. It consists of a stainless steel mesh filter inside a clear cup. It is located between the water intake on the bottom of the boat and the engine's raw water pump. It should be checked periodically for debris as conditions dictate. To remove debris, unscrew the clear sight cup, remove the o-ring and stainless steel filter mesh and proceed to rinse out the cup. Be sure to reinstall the filter mesh and o-ring before reattaching the sight cup to the inlet.

## Optional Walk-Through Curtain

Some Supra models offer an optional Walk-through curtain that snaps into the front walk-through to help prevent cool air from flowing into the cockpit area.

## Optional CD Changer

The optional 10 disk CD changer is mounted to the floor of the boat and is controlled using the stereo controls. It can also be controlled by the stereo remote. Please see CD changer owner's manual for more information.

## Fresh Water Cooling System

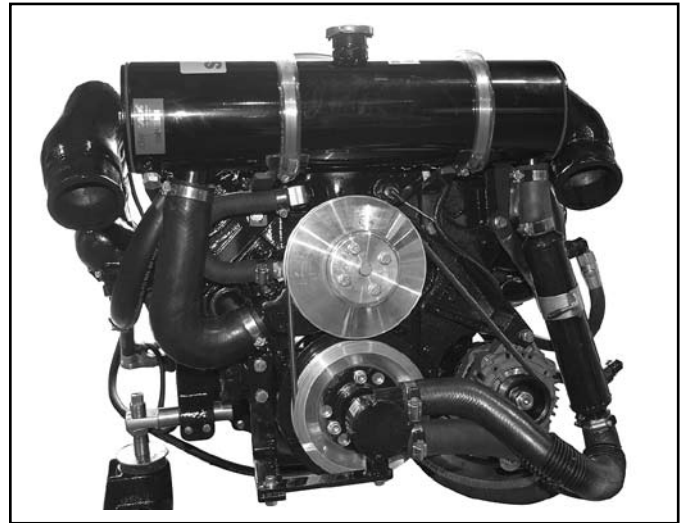

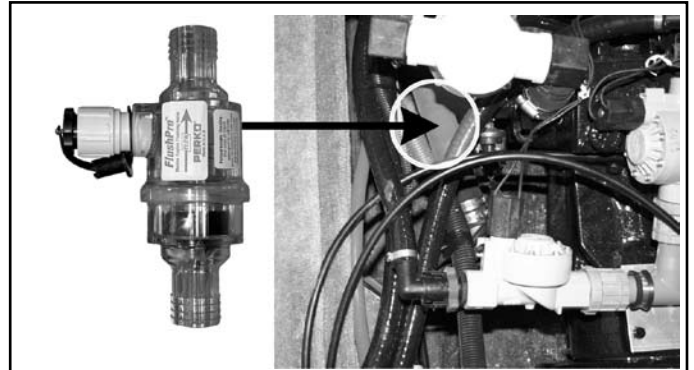

The optional fresh water cooling system has a heat exchanger which allows the engine to have an antifreeze mixture which circulates in the engine. For more information, see your engine owner's manual.

## Fresh Water Flush



The optional Fresh Water Flush kit is a valve specifically designed to allow you to attach a garden hose to your engine water intake to flush brackish or salt water out of your engine. To use the Fresh Water Flush, simply attach a garden hose to the valve. Turn on the water to the valve. Start the engine. Monitor the exhaust ports on the transom of your boat and engine temperature gauge. Water should come out of the exhaust ports while the engine is running. It is recommended that you run the engine at a low RPM while flushing, since the engine's raw water pump at higher RPMs can pump more water than the garden hose can supply. If you have questions on the operation of your Fresh Water Flush kit, consult your Supra Dealer.

## Fuel Precautions

 <b>WARNING</b>	
	<ul style="list-style-type: none"><li>• AVOID SERIOUS INJURY OR DEATH.</li><li>• LEAKING FUEL IS A FIRE AND EXPLOSION HAZARD.</li><li>• INSPECT SYSTEM REGULARLY. EXAMINE FUEL SYSTEM FOR LEAKS AND CORROSION AT LEAST ANNUALLY.</li></ul> <small>WLENG0803</small>

### **WARNING**

Sparks while fueling could cause an explosion!

#### Before Fueling:

1. Turn off engine.
2. Turn off all electrical systems.
3. Extinguish cigarettes or any open flame.

#### While Fueling:

1. Keep fuel hose nozzle in contact with fill pipe to provide grounding.
2. Fill tank at a slow rate to avoid spills.

## Fuel Tank



The fuel cap is located in the middle of the rear of the boat. A specially designed fuel key is provided to open the cap.

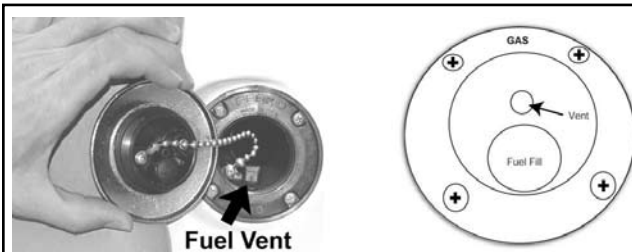

**NOTE: The cap is sealed by a rubber o-ring. Please do not overtighten.**

Both the 22 and 24 Series boats, for extra convenience, have a fuel fill on both sides to allow for easy fueling.



Fuel Vent

## Filling the Tank

 <b>WARNING</b>	
	<ul style="list-style-type: none"><li>• AVOID SERIOUS INJURY OR DEATH.</li><li>• FIRE, EXPLOSION AND SPLASHING FUEL HAZARD.</li><li>• IF TANK IS OVERFILLED, FUEL WILL DISCHARGE OUT THIS PORT.</li></ul> <small>WLFH0804</small>

**NOTICE: Pay careful attention when filling the fuel tank. DO NOT overfill the tank! Fuel may empty through the fuel vent and damage the outside finish.**

If fuel is spilled on stripes or decals, apply a common bath cleaner (non-abrasive) and wipe with a damp cloth. Rinse spill area with clean water.

## V-Drive Fuel Tank



The fuel cap is located on the starboard side of the boat near the stern. A specially designed fuel key is provided to open the cap.

**NOTE: The cap is sealed by a rubber o-ring. Please do not overtighten.**

## Fuel Vent

The fuel vent is a part of the gas filler neck. This vent is connected to the fuel tank via the vent hose, which releases gasoline fumes from the fuel tank.

### **CAUTION**

Gasoline vapors are highly explosive.

## Docking Lights



The optional docking lights are designed to help you dock, load and unload your boat in low light or at night.

**NOTE: Docking lights are not to be used as running lights at night. USCG regulations mandate that a boat under power after sunset must display a 360 degree white light and a red/green bow light.**

## Automatic Fire Suppression System



The optional Automatic Fire Suppression System has a sensor in the engine compartment that is designed to detect a fire. Under normal conditions, the dash area warning light will glow green when the ignition is "ON". If the engine compartment sensor is activated by a fire, it will deploy the content of its fire extinguisher and the dash mounted warning light will turn red.

## Jump Seat



The Jump Seat option is a small extra seat which can be placed in the walk-thru area to give more seating. It must be used in an area which keeps the seat from moving.

---

## Notes

### Typical Inboard

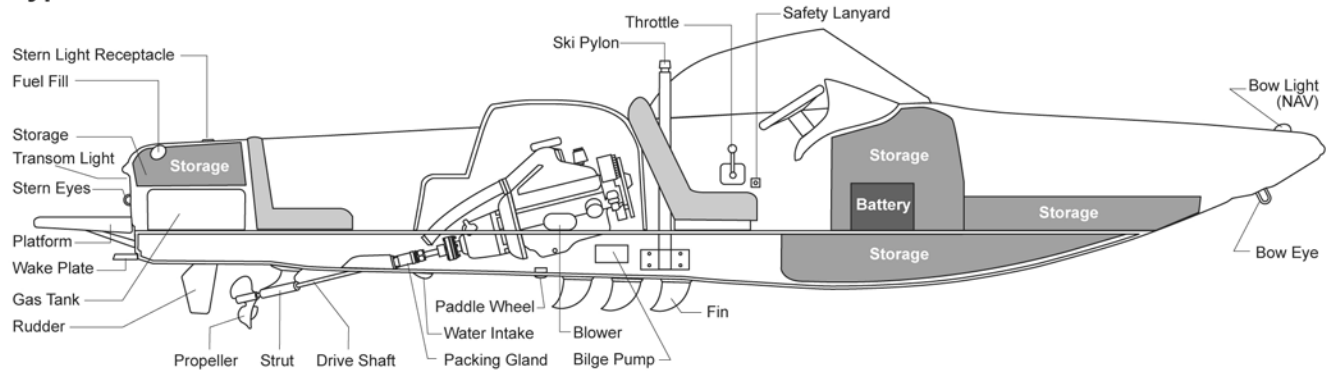

### Typical V-Drive

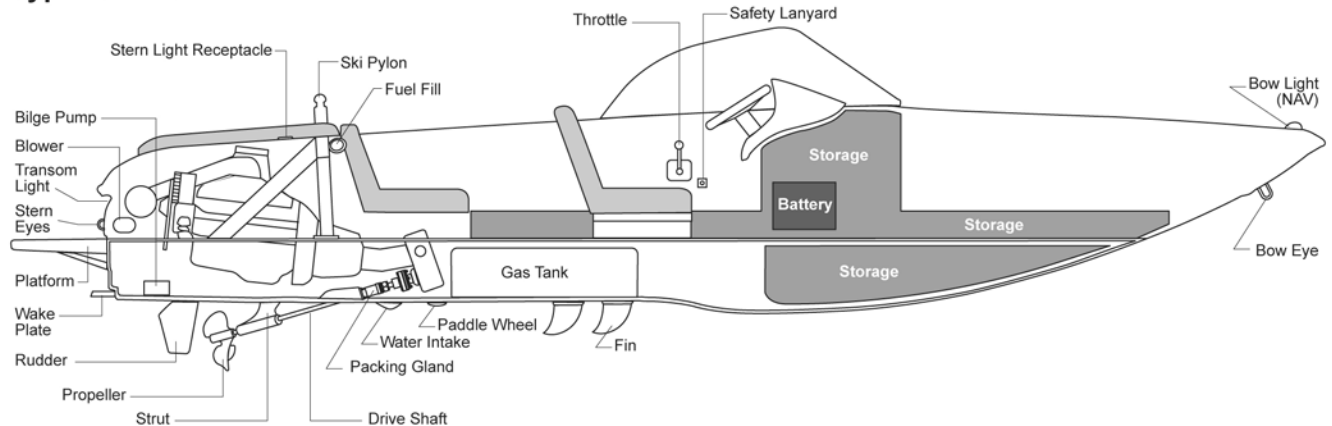

The illustrations above denote the areas which may need to be accessed or may require cleaning or maintenance. It is important to have a basic understanding of the parts and their location on the boat. However, it is recommended that any service beyond routine maintenance be performed by an authorized Supra dealer.

## Service & Maintenance

For your convenience, a maintenance schedule has been included in this manual. The items listed outline when to perform safety checks, lubrication and general service to your boat. Engine hours or elapsed time determine when service is necessary.

It is recommended that any replacement parts used during maintenance or for repair be supplied by an authorized Supra dealer.

**NOTICE: You are responsible for keeping records of all maintenance on your boat. To maintain your new boat warranty, you may be required to prove that required maintenance was performed.**

## Maintenance Intervals @ Engine Hours

<b>Maintenance To Perform</b>	<b>Weekly</b>	<b>1st 25</b>	<b>50</b>	<b>100</b>	<b>Yearly</b>
Change Engine Oil		X	X	X	X
Replace Oil Filter		X	X	X	X
Clean Oil Filler Cap				X	
Check Transmission Fluid Level	X	X	X	X	X
Change Transmission Fluid					X
Check Water Strainer (if applicable)*	X	X	X	X	X
Clean Flame Arrestor		X		X	X
Clean Crankcase Ventilating System		X	X		X
Check Water Pump & Alternator Belt Tension	X	X			X
Change Fuel Filter				X	X
Check Fuel Lines & Connections for Leaks	X	X	X	X	X
Impeller Replacement				X	X
Clean Transmission Oil Strainer Screen					X
Lubricate Distributor Cam					X
Shaft Packing Log		X	X	X	X
Check Condition of Spark Plugs					X
Check Battery Electrolyte Level		X	X	X	X
Check All Electrical Connections		X			X
Check Cooling System Hoses for Leaks	X	X			X
Tighten Engine Mount Fasteners					X
Lubricate Throttle and Shift Linkage Pivot Points					X
Check for Loose, Damaged or Missing Parts	X	X			X
Check Engine to Propeller Shaft Alignment		X		X	X
Lubricate Rudder Port				X	X
Check V-Drive Fluid Level**	X	X	X	X	X
Change V-Drive & Transmission Fluid**					X

\* If engine overheats, visually check. If clogged, remove debris.

\*\*Pertains to V-Drives only.

*This inspection and maintenance schedule is recommended for average operating conditions in normal service. Under severe operating conditions or service, intervals should be shortened.*

## Cooling Systems

### FRESH WATER COOLING SYSTEM

The standard cooling system for Supra boats is an open circulation cooling system with intake water. This is preferred for lakes and reservoirs with low salt content. If the engine is occasionally operated in salt water, the cooling system should be flushed with fresh water periodically and always before storage. If your boat is regularly operated in salt water, it should be equipped with the optional salt water package.

### SALT WATER COOLING SYSTEM

The optional cooling system for use on salt water is a closed system with a solution of 50% antifreeze and 50% fresh water. The coolant is left in the closed system and replaced once a year.

## Component Lubrication

Normal use of your Supra causes metal to metal movement at some parts in the boat. Driver seat track should be lubricated with a water resistant chassis lubricant such as silicon grease.

Lubricate rudder grease fitting located below the engine, once annually.

## Fuel Filter



There is an in-line fuel filter installed for added protection. On V-drive models, it is mounted on the starboard stringer, accessible under the V-drive cover. On inboard models, it is mounted on the inside of the transom. It is accessible by removing the aft storage panel. This is a serviceable component and should be changed every 100 hours or yearly/annually.



## Engine Oil and Filter

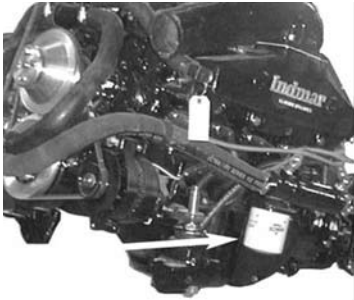

**Engine Oil & Filter**

The oil filter is located below the engine. The engine manufacturer recommends that you change the oil and oil filter after the first 10-20 hours use of your new boat. Thereafter, to maximize engine life, change oil and filter after every 50 hours of use (See Engine Manual).

Crankcase oil should be selected to deliver the highest performance for your operating conditions and climate. In general, engine oils with lower viscosity ratings are used when temperatures remain low or when better fuel economy is desired. Oils with higher viscosity ratings are used when temperatures remain higher and when higher performance is expected from the engine.

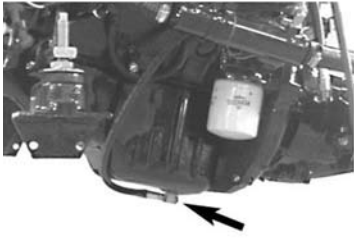

**Oil Drain Hose**

The Engine Manufacturer recommends Pennzoil 15W-40 Marine Motor Oil. If this is unavailable, use a 15W-40 motor oil with an A.P.I. classification rating of SL/SJ/CI4/Ch4/CG4 or equivalent.

**REFER TO ENGINE MANUAL for more information.**

## V-Drive Remote Oil Filter

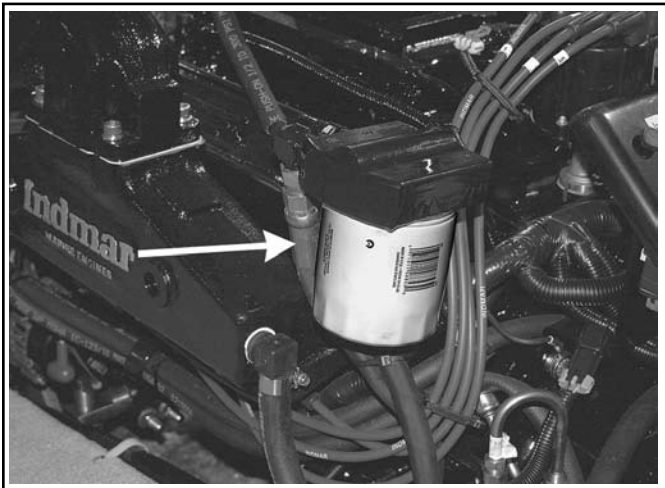

V-Drive remote oil filter is mounted in the engine compartment for convenience.

## Oil Level Check

Engine oil level should be checked at regular intervals (such as every 5 engine hours). To obtain a true reading, when the engine is at operating temperature and turned off, check the oil level showing on the dipstick.

If the oil level is between the "FULL" and the "ADD" marks on the dipstick, simply replace the dipstick. When the oil level is at or below the "ADD" mark, add oil to return the level to the "FULL" mark.



## Transmission Level Check

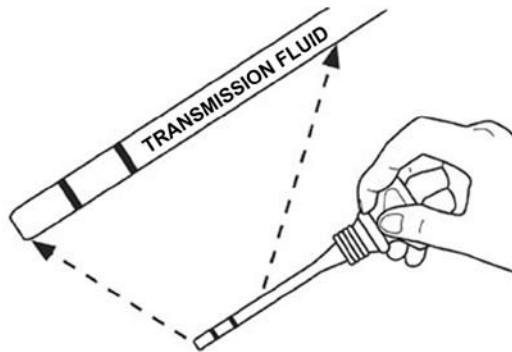
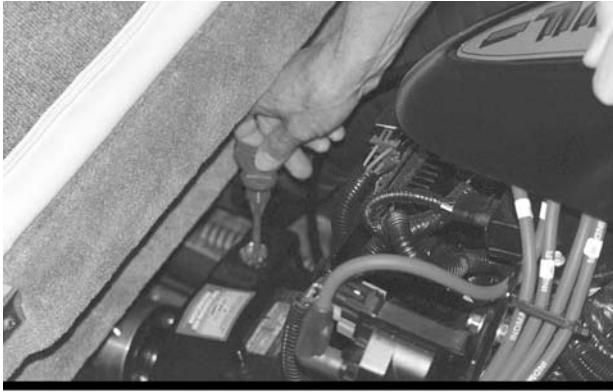

Transmission Fluid Check

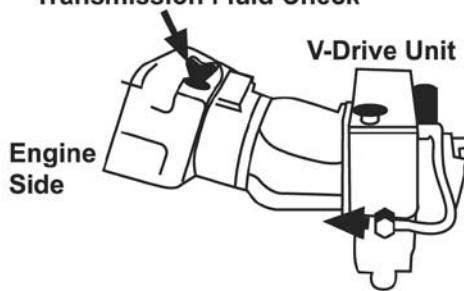

Use only automatic transmission fluid type "A" in transmissions with 1:1 drive train. Refer to Engine Owner's Manual.

### Change Frequency

Change transmission fluid every year, using only Dextron-III Mercon automatic transmission fluid.

### Maintaining Fluid Level

Transmission fluid level should be checked regularly and fluid added if necessary. Maintain fluid levels as follows:

- Boat must be at rest.
- Engine should be at operating temperature, but turned off while checking level.
- Remove transmission dipstick.
- Wipe fluid clean from dipstick and replace.
- Remove dipstick and note level indicated by the upper and lower marks.
- If required, add fluid to bring the level to the upper mark.

## V-Drive Fluid Check

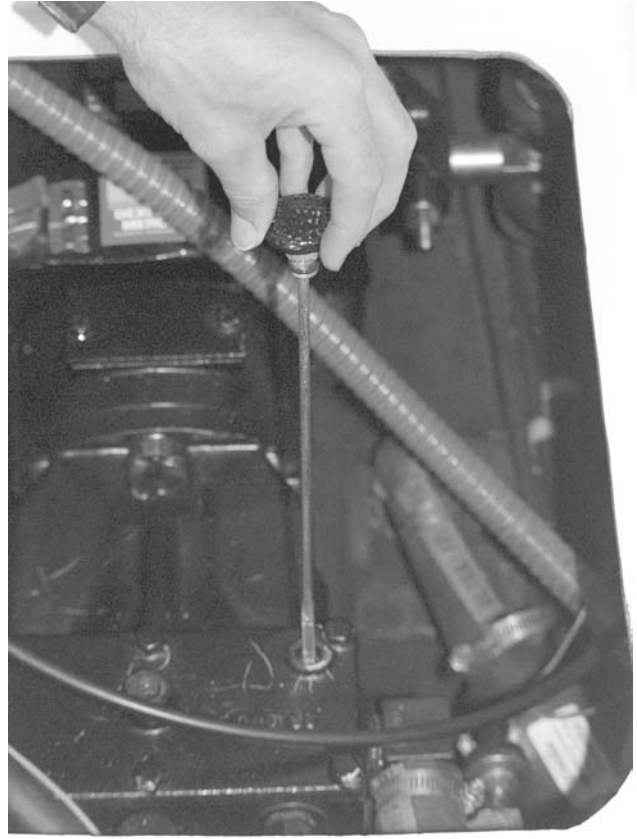

The fluid level can be checked by using the oil level gauge, which is located on top of the V-Drive unit. This unit is located under the center cushion of the rear seat. Pull out the cushion to access the transmission.

Pull the oil level gauge to check the fluid level. If the level is low, add fluid to the correct mark on the dipstick. Use SAE 30 motor oil.

**NOTE: Only a trained and qualified technician should perform the oil change on your V-drive unit.**

### Change Frequency

The oil should be changed in the V-drive unit after the first 100 hours of operation, then each year at the end of your boating season.

### Maintaining Fluid Level

V-Drive unit fluid level should be checked regularly and fluid added if necessary. Maintain fluid levels as follows:

- Boat must be at rest.
- Engine should be at operating temperature, but turned off while checking level.
- Remove fluid dipstick.
- Wipe fluid clean from dipstick and replace.
- Remove dipstick and note level indicated by the upper and lower marks.
- If required, add fluid to bring the level to the upper mark.

## Battery Cable Installation & Precautions

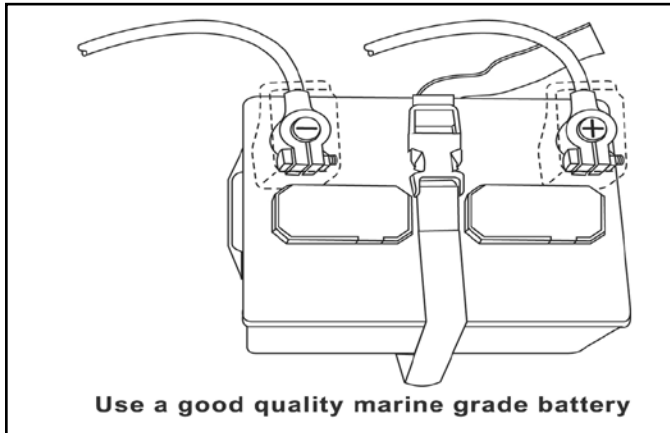

Your battery is an important part of your boat. It provides all the power to start your boat and allows all of your electrical components (bilge pump, blower, stereo, etc.) to work even if the motor is not running.

Because of its important role, Supra recommends using a good quality "Marine Dual Purpose" battery. The "Dual Purpose" rating means that it can provide the cranking Amps needed to start your motor, yet it also has an Amp hour discharge rating so it can handle low electrical drawdown cycle.

Your Supra electrical system is a negative ground type. The negative battery cable is grounded to the engine block. The positive battery cable is connected to the starter solenoid.

Connect the positive (+) battery cable to the positive (+) post on the battery. Connect the negative (-) battery cable to the negative (-) post on the battery.

### **CAUTION**

Failure to connect battery cables as outlined will damage the system and void the warranty.



### **WARNING**

Sulfuric acid in the battery can cause serious burns. If spilled on skin or in eyes, flush with clean water immediately, then seek medical attention.



### **WARNING**

Hydrogen and oxygen gases are produced during normal battery operation and charging. Sparks or flames near the battery vent openings can cause the mixture to ignite and explode.

## Dripless Shaft Seal



Your Supra comes standard with a dripless shaft seal. If any seepage occurs, contact your dealer.

---

## Notes

#### Fiberglass Care

Washing and waxing the boat hull and deck regularly will extend the life and beauty of your Supra. It is a good routine to rinse your boat with fresh water after each day's use.

It is recommended that the hull and deck be cleaned and waxed after every 25 hours of use. This will decrease water friction and lesson the potential for staining or spotting on the gelcoat surface.

When the original gelcoat shine cannot be restored by waxing, the shine may be restored by hand buffing with a commercial polishing compound. Be sure to apply a new coat of wax containing Carnauba over the area that has been polished.

**IMPORTANT:** Porcelain cleaning powders are too abrasive for use on gelcoat and may cause permanent discoloration if used. Household detergents containing ammonia or chlorine should not be used on gelcoat. Never use acetone or ketone solvents to clean your boat finish.

#### Washing Your Boat



The easiest way to preserve the beauty of your boat is to keep it clean by frequent washing. Wash the boat with luke warm or cold water. Wipe the boat down immediately after washing to avoid water spots. Avoid using hot water or washing your boat in direct sunlight. Avoid using strong soaps or chemical detergents. To avoid spotting, all cleaning agents should be thoroughly rinsed from the surface promptly and not allowed to dry on the finish.

#### Rub Rail Care



Use a sponge or other soft material to wash and wax the rub rail. To wax, use a commercial automotive bumper wax.

**NOTICE:** When tying up to a dock or another boat, always use cushioned fenders (dock bumpers) to protect your boat from hard surfaces.

#### Windshield Care



All Supra windshields are constructed of tempered safety glass to ensure passenger safety. The glass surfaces should be cleaned regularly to ensure that visibility is not obstructed.

Use a commercial glass cleaner to remove any spotting or stubborn stains that develop on the windshield. Never use abrasive cleaners on glass surfaces.

## Upholstery Care



All upholstery items on your Supra are made of tough marine grade vinyl that is easily cleaned.

It is important to provide for the drying of all upholstery and carpet after each use of the boat. Open all storage compartments and slide all removable cushions out about an inch to allow air to circulate behind.

### **CAUTION**

Strong detergents and cleaners may shorten the life of the vinyl. PLEASE SEE VINYL MANUFACTURER'S RECOMMENDED CARE GUIDE INCLUDED IN YOUR OWNER'S MANUAL PACKAGE.

FAILURE TO FOLLOW CARE GUIDE MAY VOID VINYL WARRANTY.

## Drying Upholstery

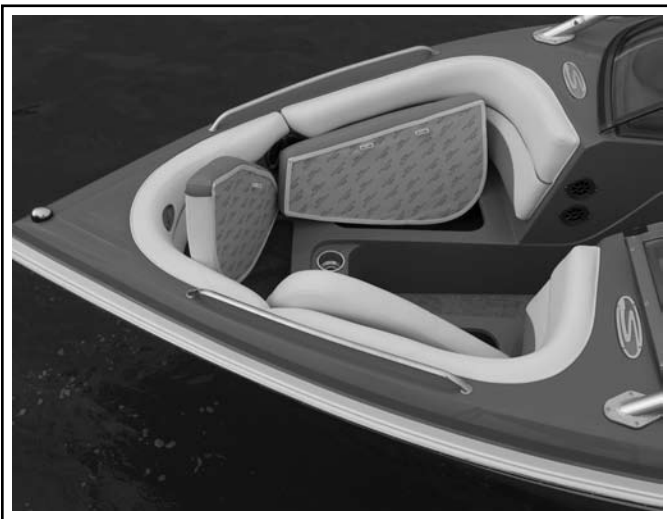

It is important to provide for the drying of all upholstery and carpet after each use of the boat. Open all storage compartments and slide all removable cushions out about an inch to allow air to circulate behind.

## Foreign Deposits

Tree sap, bird droppings, air borne chemicals, petroleum products and other foreign matter may damage the gelcoat surface if not removed promptly (See Washing Instructions).

### **Boat Hull Protection**

If your Supra is to remain in the water for an extended period, the hull below the water line should be painted with a marine bottom paint. Boats left in the water for extended periods of time without bottom paint may experience blistering or discolorization. This type of damage is not covered by your boat's warranty.

### **Teak Wood Care**

If teak wood has been installed on your Supra, a small amount of maintenance will be required to retain the natural beauty. Teak wood should not be varnished. Instead, teak oil or mineral oil should be applied. Oil should be applied 3 to 4 times per year. If teak has been allowed to become gray and dry, sand with fine grit paper and reapply teak oil.

### **CAUTION**

Damage caused by improper care, cleaning agents, conditioner oils, waxes, gasoline, etc., IS NOT covered under your boat's warranty. Use only the recommended vinyl cleaner as listed on the Vinyl Care Instruction Sheet.

Please refer to [www.marinespecialtiesgroup.com](http://www.marinespecialtiesgroup.com) for more information regarding vinyl care.

## Wet Slipping Boats

### **CAUTION**

- In the event of large storms, boats in wet slips are more likely to be damaged.
- If you do not use the boat often, the battery can go dead from pumping out water.
- The boat may develop organic growth which can greatly reduce performance, attack and discolor the gelcoat.\*
- The boat may develop osmotic blisters.\*
- The boat may get a stain line which cannot be removed.\*

\* *Painting the area below the waterline of the boat with Interlux products will reduce the likelihood of these last three.*

### Winterization

When the boating and ski season comes to a close, it is important to have your boat professionally winterized.

If your boat is exposed to temperatures below 32 degrees F (0 degrees C) it is possible for water in the engine, ballast system, heater core, etc., to freeze. As this water freezes, it expands and can crack pumps, valves, heat exchangers, engine blocks, etc. This type of damage usually requires the replacement of the cracked item and can be very expensive to repair.

#### CAUTION

**It is extremely important to follow the proper winterizing procedure. The engine must be correctly winterized for safe storage in your climate. This should be done by a professional. Your Supra dealer will know exactly what must be done to ensure the longest possible life for your boat.**

In addition to having your boat professionally winterized, the following tasks should be done to protect your boat during storage:

1. Remove the drain plug from the boat.
2. Thoroughly clean the boat inside and out. Inspect the hull for any residue or algae growth and remove if required.
3. Clean the bilge area thoroughly and operate the bilge pump to remove any water from the bilge hose.
4. Remove all seat cushions and open all storage areas to air circulation in the boat interior. When thoroughly dry, replace cushions and close storage areas.
5. Top off fuel tank to prevent any condensation from accumulating in the fuel system. Use a commercially available fuel stabilizer to remove water and prevent gumming.
6. If the boat is stored on its trailer, ensure that the boat is properly positioned. If possible, lift the tongue so that the bow is slightly raised to promote drainage from the drain hole.
7. Install the canvas cover and secure the straps in accordance with cover instructions.

**NOTE: During the winter months, water is a boat's worst enemy. Always store the boat when the interior is completely dry. Periodically check on the condition of the stored boat.**

#### CAUTION

**Damage due to improper winterization IS NOT covered under your boat's warranty.**

### Summerization

Before using the boat after it has been in dry storage requires some special treatment. Supra recommends having your boat professionally summerized, preferably by the same facility that prepped it for storage. They will be familiar with what items were done in the fall and what items need to be addressed in the spring.

In addition to having your boat professionally summerized, the following list of tasks should be done to ensure a successful start to your boating season.

- Check Trailer
  - Tire Pressure
  - Bearing Lube
  - Brake Fluid
  - Lights
- 
- Charge Battery
  - Clean & Wax Gelcoat
  - Clean Interior
- 
- Check All Systems
  - Blower
  - Bilge Pump
  - Navigation Lights
  - Interior Lights

When launching the boat for the first time of the season, carefully watch all gauges to ensure that the boat is not overheating, the alternator is charging and the engine has proper oil pressure.

## Temporary Hoisting

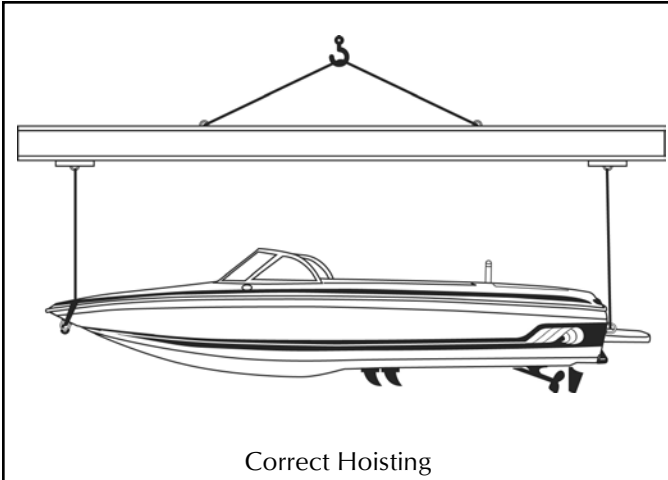

Correct Hoisting

If the boat ever needs to be hoisted, special attention should be given to the following recommendations:

- Hoist the boat using a horizontal lifting bar only.
- Never attempt to lift the boat by means of a cable sling from bow to stern lifting eyes.
- Hoist operator should slowly and smoothly lift the boat without jerking to avoid damage to the lifting eyes.

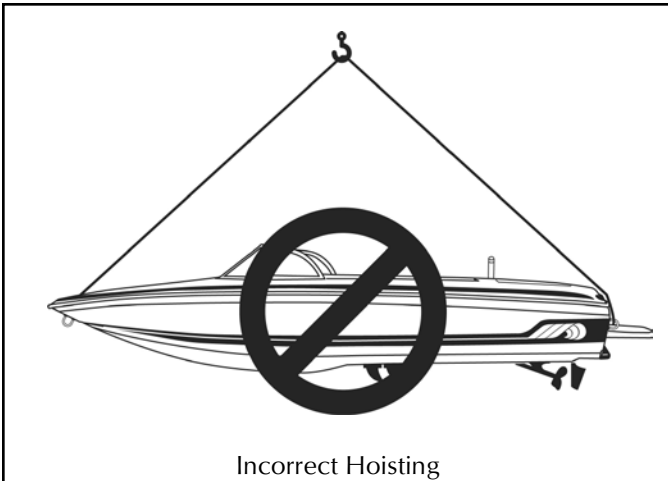

Incorrect Hoisting

### **⚠ WARNING**

DO NOT use the ski pylon to hoist the boat.

### **⚠ CAUTION**

Incorrect hoisting may invalidate the warranty on the boat.

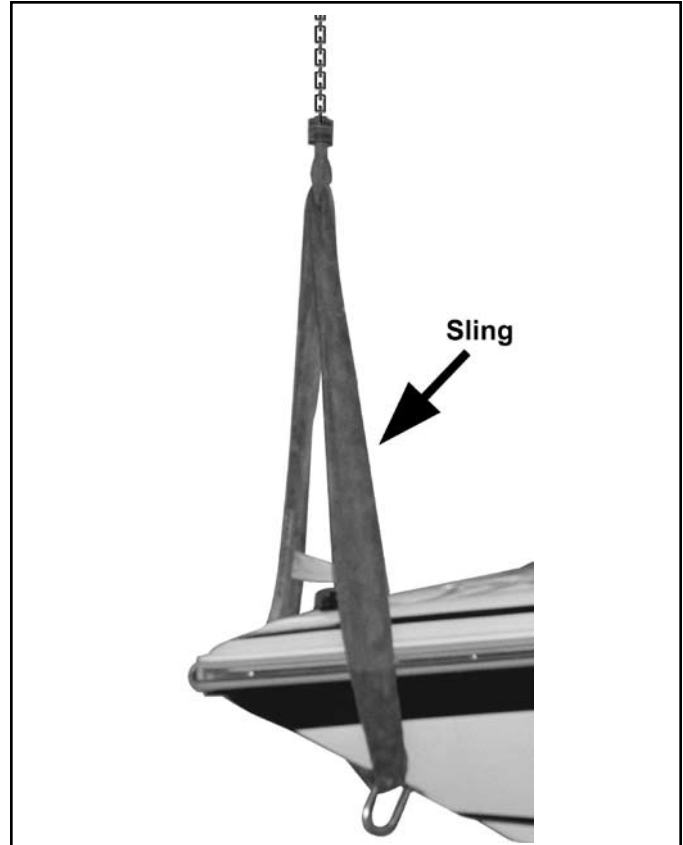

### **⚠ WARNING**

Use only a proper sized sling in the designated lifting rings to hoist the boat.



### **NOTE:**

For boat houses, we highly recommend the use of a lift cradle. Cradle bunk design should mimic the bunk design of the trailer.



### Identification Number



The hull identification number is located on the upper right hand side of the transom below the rub rail.

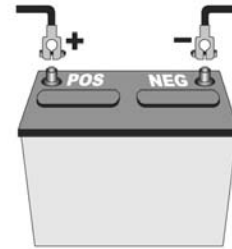

### Battery Specifications

**12 Volt Marine Type with Tapered Post Connectors**

Engine Size: ..... Cold Crank  
350 ..... 400 Amps

**Good Quality Marine Dual Purpose battery recommended.**

#### **WARNING**

Hydrogen and oxygen gases are produced during normal battery operation or charging. Sparks or flames can cause this mixture to ignite and explode if it comes near the vent openings. Sulfuric acid in the battery can cause serious burns if spilled on skin or in eyes. Flush with clear water immediately!

### 2007 Supra Engine & Transmission Data

Engine Model:	Indmar Assault MPI-325	Indmar Assault MPI-340	Indmar Assault MPI-450
Fuel Delivery	Multi Port Fuel Injection	Multi Port Fuel Injection	Multi Port Fuel Injection
Horsepower:	325-HP	340-HP	450-HP
Displacement:	350 CI	350 CI	496 CI
Bore (in):	4.00	4.00	4.25
Stroke (in):	3.48	3.48	3.37
Compression Ratio:	9.4 to 1	9.4 to 1	9.1 to 1
Electrical System:	12-V Neg Ground	12-V Neg Ground	12-V Neg Ground
Ignition Type:	Electronic Distributor	Electronic Distributor	No Distributor
Alternator Output:	70 Amps @ 1,200 RPM	90 Amps @ 1,200 RPM	90 Amps @ 1,200 RPM
Thermostat:	162 Degrees F	162 Degrees F	160 Degrees F
Firing Order:	1-8-4-3-6-5-7-2	1-8-4-3-6-5-7-2	1-8-7-2-6-5-4-3
Initial Timing:	Non Adjustable	Non Adjustable	Non Adjustable
Oil Filter:	Pennzoil PZ-3	Pennzoil PZ-3	Pennzoil PZ-3
Oil Capacity:	5-Quarts	5-Quarts	8-Quarts
Oil Type:	Pennzoil 15W-40 Marine	Pennzoil 15W-40 Marine	Pennzoil 15W-40 Marine
Spark Plugs:	AC 41-932	AC 41-932	AC 41-983
Gap:	0.060	0.060	0.050
RPM Range @ WOT:	4,400 - 4,800 RPM	4,600 - 5,200 RPM	5,000 - 5,400 RPM

**V-Drive: ..... Walters**

Model: ..... RV-26 D  
Ratio: ..... 1.46 to 1  
Oil Type: ..... SAE-30  
Oil Capacity: ..... 2 pints

**Transmission: ..... ZF Hurth**

Model: ..... 450 D  
Ratio: ..... 1 to 1  
Oil Type: ..... ATF Dextron III  
Oil Capacity: ..... 2 qts.

### 2007 Supra Electrical Replacements

Fuses	Type	Size
<b>Under Dash</b>		
Ballast Fill Pump	Breaker	10 Amp
Ballast Empty Pump	ATO	5 Amp
Ballast Solenoid	ATO	3 Amp
Stereo	ATM	10 Amp
Flash Light	ATO	2 Amp
<b>Battery Connection</b>		
Amp Harness (4 channel)	MAX	40 Amp
Amp Harness (2 channel)	ATO	25 Amp
<b>Back of Engine</b>		
Fuel Pump	ATM	20 Amp
Engine Ignition	ATM	20 Amp
Starter	ATM	20 Amp
<b>Bulbs</b>		
Bow Light	3175	12V8W
Interior Light	891	12V10W
Pole Light	906	12V
Docking Lights	MR16	50W 24 Degree
Tower Light Bar	H3	12V55W



## Trailer & Towing

The trailer supplied with your Supra was designed especially for the boat with your convenience in mind. Please be sure that you have an appropriate tow vehicle before attempting to trailer your boat. Your vehicle must be capable of towing 5,000 lbs. and must be fitted with no less than a Class III (5,000 lb. max.) trailer hitch.

### **CAUTION**

**Read the trailer towing section of your vehicle owner's manual before towing your trailer.**

All Supra trailers require a 2" ball and a five (5) pin marine grade trailer wiring connector. The standard height from the ground to the top of the hitch ball should be about 20 inches. With the trailer attached to the tow vehicle, the trailer should stand approximately level.

#### **Trailer Plug Wire Schematic**

White: Ground  
Green: Right Turn / Brake  
Yellow: Left Turn / Brake  
Brown: Running Lights  
Blue: Reverse Lights

**NOTE: Supra trailers feature disk brakes. The 5th wire (blue) on the wire connector needs to be connected to your vehicle's reverse lights to be operative. This wire (blue) provides power to a solenoid which deactivates the brakes while in reverse. You may still tow your trailer without the blue wire connected, however, you may experience difficulty backing the trailer.**

## Prolong Trailer Life

**The following guidelines will prolong the life of the boat and trailer:**

- 1. Always secure the boat to the trailer with tie-downs. Do not place straps around fenders or lights.**
2. Always verify that the winch hook is securely in the bow eye, the strap is tight and the winch handle locked in place before trailering.
3. Check the recommended pressure displayed on the side of the tires and assure that it is maintained. Under-inflated tires could cause trailer sway and excessive tire wear.
4. Before use, please read all information supplied with the trailer by the manufacturer (Bearing Buddy, Boat Buddy and hydraulic brake actuator). Check wheel bearing grease.
5. Before operating Boat Buddy, check trigger setting and latch pin location. After loading, check latch pin and confirm that it is properly seated in the eye hook before pulling trailer out of water. Wash Boat Buddy moving parts with high pressure water.
6. Check wheel bearing lube.
7. See Trailer Owner Manual for Maintenance Schedule.

### **CAUTION**

**Inadvertent release of latch pin could result in injury**

## Connecting the Trailer



When connecting the trailer to your tow vehicle use the following procedure:

1. Raise the tongue with the trailer jack, position the trailer tongue directly over the 2" ball, and lower the jack until the tongue goes all the way down over the ball.
2. Press down on the latch until it locks on the ball with a "click."

**NOTICE:** If your hitch ball has an excessive flat spot on top, the latch may not engage properly. If the latch does not catch, check with your dealer or hitch installer before trailering.

3. Insert the locking pin into the tongue. Lock pin hole is on the side of the tongue.
4. When all weight is off the trailer jack, pull the jack lock pin and rotate the jack to the horizontal position and re-lock the pin.
5. Attach the safety cables to the tow vehicle hitch. Cross the cables and wrap them around each other once or possibly twice allowing just enough slack to permit tight turns of the vehicle and trailer.
6. Plug the trailer lights connector to the vehicle harness.
7. Clip the brake lockout cable to the vehicle hitch.

## Trailer Alignment



When pulling the boat onto the trailer, be sure that it is centered on the trailer.



The distance between the boat and the wheel runner board should be equal on both sides.

Incorrect Alignment



## Unloading Procedure

To unload the boat use the following procedure as a guide:

1. Make sure that all drain plugs are securely in place.
2. Unplug light cord before backing into the water.
3. With Bow Eye Hook fastened, retract Boat Buddy latch pin by pulling trigger into "safety" position. (If latch pin is bound, tighten winch to relieve pressure, then pull trigger into "safety" position).
4. With Bow Eye Hook fastened, back the trailer until the water level is approximately 1 inch below the top of the trailer fenders. NOTICE: Ramp slopes vary, so actual level of water on trailer may be different. (NOTE: Caution on this page!).
5. Follow the cold start procedure recommended in this manual.
6. After starting the engine, remove Bow Eye Hook.
7. With engine idling, center steering wheel, engage transmission and slowly pull throttle into reverse. Ease back on the throttle lever until the boat starts to move.

**NOTE: DO NOT attempt to use excessive power to free the boat from dry carpet runners. Power off of the trailer only when the boat has floated free.**

### **CAUTION**

If the trailer is not submerged to the correct depth, the bow of the boat could drop when powering off incorrectly, possibly damaging the boat.

### **WARNING**

Roll driver's side window of tow vehicle down prior to backing down ramp. Should the vehicle slip into the water, the driver can escape through open window.

**NOTE: Because your Supra is a direct drive inboard, when backing up, the stern will have a tendency to drift left or right depending on propeller rotation.**

## Loading Procedure

To load the boat on the trailer, position the trailer in the water with approximately 1 inch of the top of the fender showing.

1. Set the Boat Buddy for loading by pulling trigger or latch mechanism into "set" position.
2. Idle/coast the boat onto the trailer using as little power as possible, while keeping it centered between the guide poles.
3. Power slowly forward until the bow eye solidly contacts the Boat Buddy and the latch is triggered.
4. Winch hook must be attached to bow eye and tightened before trailering.

**DO NOT Power onto the trailer during rough conditions!**

**Once correctly positioned on the trailer, switch off ignition.**

**DO NOT OVER POWER onto trailer or damage may occur to the boat and/or the trailer!**

### **CAUTION**

The trailer must be positioned for the correct water depth for loading or you may damage the boat. Varying ramp angles require different procedures. In general, the steeper the ramp, the more shallow the trailer should be positioned in the water. Your local dealer can help you understand this, should you require additional assistance.

## Boat Buddy



Your Supra trailers come standard with a trailer Boat Buddy. This feature makes loading your boat on the trailer much easier.

### Loading

Place the trigger in the "SET" position. When the bow eye contacts the Boat Buddy, the pin will latch, securing the boat.



### Unloading

To unload the boat, pull back on the trigger and locate it in the "SAFETY" position.



## Surge Brakes Fluid Reservoir



To check brake fluid, twist black cap and remove. Pry rubber plug out of reservoir. Follow instructions printed on plug. Use DOT 3 Brake Fluid.

## "Gold Series" Oil Bath Bearings



Your trailer features "Gold Series" oil bath bearings. Check the fluid color of hubs before each use. If not completely full or if oil is brownish/gray and cloudy, drain and refill hub.

NOTE: Use 50 SAE oil.

## Tandem Axle



Some models come standard with a tandem axle trailer and with some it is an option.

## Second Axle Disc Brakes



This optional second axle disc brakes give the trailer more stopping power. Some states required brakes on both axles. Be sure to check your local laws.

## Aluminum Step Plate



The optional aluminum step plate gives the trailer a durable, long-lasting nonskid surface on the trailer steps.

## Swing-Away Tongue



**WARNING**  
Do Not tow trailer without Latch Pin installed.

**CAUTION**  
Always install safety clip on end of Latch Pin.

Optional Stainless Steel Swing-Away Tongue available.



With the swing tongue, you can shorten the trailer length for storage by pulling the pin and swinging the tongue away to the side.

**WARNING**  
DO NOT tow trailer without latch pin installed.

**CAUTION**  
Always install safety clip on end of latch pin.

## Spare Tire Bracket



The optional spare tire bracket allows you to conveniently carry a spare tire.

## LED Package

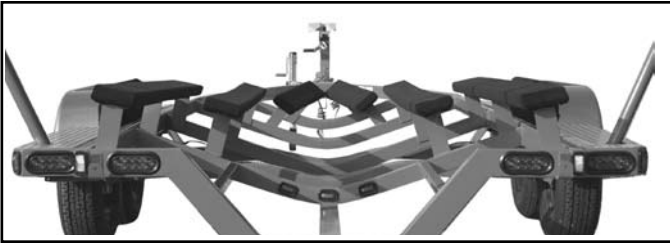

The optional LED lighting package replaces the traditional trailer lights with LED lights. The LED lights are brighter than the traditional lights.

NOTE: Vehicles with trailer light monitors may not function properly with LED lights due to the low resistance of the LED lights. Aftermarket resistor packages are available which allow the monitors to work properly.

## Laser Cut Steps



The optional laser cut steps are backlit so they illuminate when the trailer's running lights are illuminated.

## Aluminum Wheels



The optional aluminum wheels are a trailer grade wheel. They are a great way to dress up your trailer.

## Gravity Wheels



The Gravity Games Edition 24SSV comes with custom wheels.

NOTE: See Trailer Packet for more information regarding tire size and rating.



## Supra Limited Warranty

Taking care of our product after it becomes yours has always been "standard policy" at Skier's Choice, Inc., the proud manufacturer of the Supra line of boats. And to further prove our point, we offer the following limited warranty.

### TERMS OF WARRANTY

During the applicable Warranty Period (as defined below), Skier's Choice, Inc. ("Skier's Choice" or the "Company") warrants to the original retail purchaser (the "First Owner") that the components and parts manufactured by Skier's Choice (the "Covered Components") of each new Skier's Choice boat are free from any defects in material and workmanship, under normal use and when operated and maintained according to boat's instructions ("Normal Use and Operation").

- This Limited Warranty applies to all Covered Components other than the deck, hull, floor and stringers for a period of one year (the "One-Year Warranty Period") from the original date of purchase by the First Owner (the "Original Purchase Date"). Exclusions do apply.
- This Limited Warranty applies to the deck, hull, floor (excluding carpet) and stringers for the lifetime of the boat (the "Lifetime Warranty Period"). Exclusions do apply.
- This Limited Warranty applies to the gel coat for a period of one year (The "One-Year Warranty Period") from the original date of purchase by the First Owner (The "Original Purchase Date"). Exclusions do apply.

This Limited Warranty may be transferred (for a minimal fee) to subsequent owner(s) only through a Supra Dealer during a period of two (2) years from the Original Purchase Date.

Subject to the terms of this Limited Warranty, Skier's Choice will repair or replace, at its sole option, any Covered Component which is returned during the applicable Warranty Period to the Skier's Choice factory or to any other Supra authorized repair facility (an "Authorized Supra Facility"), provided that:

- Only the Covered Components that are declared defective upon examination by Skier's Choice will be repaired or replaced under this Limited Warranty;
- Transportation of the boat, parts or components to and from the Skier's Choice factory or the Authorized Supra Facility must be pre-paid by the owner;
- Notice of any claim under this Limited Warranty must be provided to Skier's Choice by the Authorized Supra Facility no later than sixty (60) days after the owner becomes aware of the defect.

Notification of a claim or defect must be properly made directly to an Authorized Supra Facility, who subsequently must submit the claim information to Skier's Choice, Inc. at 1717 Henry G. Lane Street, Maryville, Tennessee 37801. Information needed for processing a claim includes (1) Name and address of the owner; (2) Serial number of the boat; (3) Original retail purchase date; (4) Detailed explanation of the defect; and (5) Estimated repair cost.

## Section XV Supra Warranty

**Note: Warranty repair or replacement cannot be made until this information is approved by Skier's Choice.**

In case of defect of a Covered Component, Skier's Choice will use its reasonable best efforts to repair or replace the Covered Component within ninety (90) days of receipt thereof at its factory or an Authorized Supra Facility. Any warranty on replaced or repaired components pursuant to this Limited Warranty shall remain in effect only for the remainder of the original Warranty Period. The repair or replacement of Covered Components will be made by Skier's Choice without charge to the owner for parts or labor. The replacement or repair of the defective part or component as stated in this Limited Warranty shall be the sole remedy of the owner and the sole liability of the Company under this Warranty and any implied warranties.

There are no express or implied warranties on the parts and components manufactured or sold by Skier's Choice except as set forth in this Limited Warranty.

### EXCLUSIONS

Claims or assertions relating to the following are specifically excluded from coverage under this Limited Warranty and Skier's Choice disclaims any liability or obligation with respect to the following:

1. Defects in or damage caused by or relating to the engine or any part thereof. (Note: The engine may be covered by warranty of the engine manufacturer. Please see engine manufacturer warranty for details.)
2. Defects in or damage caused by or relating to the trailer or any part thereof. (Note: The trailer may be covered by warranty of the trailer manufacturer. Please see trailer manufacturer warranty for details.)
3. Covered Components of a boat that has been sold or transferred by the First Owner, unless this Warranty is properly transferred through a Supra Dealer to the subsequent purchaser(s) within two years of the Original Purchase Date.
4. Damage caused by, related to, or resulting from failure of components or parts which are not manufactured by Skier's Choice, including but not limited to bilge pump failure.
5. The Limited Lifetime Warranty on the deck, hull, floor (excluding carpet) and stringers does not include hardware or other components fastened or adhered to the hull, deck, floor or stringers.
6. Normal maintenance and upkeep relating to the boat or any part thereof, including but not limited to, alignment, adjustments, connectors, tune-ups and wear items, such as, shaft packing, belts, hoses, filters, seals, gaskets, strut bushing, etc.

7. Damage to or malfunction of a boat, or any component thereof, resulting from owner use, lack of maintenance, improper maintenance, impact, misuse, negligence, collision, delay in repair, improper hoisting or cradling of the boat.
8. Any and all consequential damages including, but not limited to, costs incurred for haul-out, launching, towing and storage charges, telephone or rental charges of any type, inconveniences, loss of use, or loss of time or income.
9. Equipment installed by anyone other than authorized factory personnel at the Company's production facility. Equipment replaced at an Authorized Supra Facility pursuant to this warranty agreement remains under warranty until the expiration of the Limited Warranty period.
10. Any boat which is: (a) used for rental or other commercial, military or industrial purposes; (b) used in boat racing, demonstrations, ski school, or similar events; (c) altered, modified, repaired or replaced so as to increase the cubic inch capacity or horsepower output of the engine and boat as originally manufactured; (d) not properly stored or maintained.
11. Speeds, fuel consumption and other performance characteristics because they are estimated and may vary.
12. Damage to or defects in paints, varnishes, gelcoat surfaces and colors, finish distortions, chrome plated or anodized finishes, floor covers and any other surface coatings.
13. Gelcoat discoloration, blisters or bubbles, including, but not limited, to those which may result from a boat being left in the water for long periods of time.
14. Upholstery cracks, mildew, stains or tears resulting from owner use, lack of maintenance, improper maintenance, impact, misuse, negligence, delay in repair, use of improper cleaners or conditioners.
15. Skier's Choice reserves the right to improve its products through changes in design or material with out being obligated to incorporate such changes in products of prior manufacture.

## OTHER LIMITATIONS

1. THIS LIMITED WARRANTY LIMITS THE DURATION OF ANY IMPLIED WARRANTY OF MERCHANTABILITY OR IMPLIED WARRANTY OF FITNESS FOR A PARTICULAR PURPOSE TO THE PERIODS SPECIFIED HEREIN. Some states do not allow limitations on how long an Implied Warranty lasts, so this limitation may not apply to you. THE REMEDIES OF REPAIR OR REPLACEMENT AT THE OPTION OF SKIER'S CHOICE, AS SET FORTH HEREIN, ARE THE ONLY REMEDIES AVAILABLE UNDER THIS WARRANTY. SKIER'S CHOICE DISCLAIMS ANY OBLIGATION OR LIABILITY FOR COSTS OR CHARGES DERIVED FROM INCONVENIENCE OF LOSS OF USE, COMMERCIAL OR MONETARY LOSS DUE TO LOSS OF TIME, INCONVENIENCE, OR ANY OTHER CONSEQUENTIAL, SPECIAL OR INCIDENTAL DAMAGES. Some states do not allow the exclusion or limitation of incidental or consequential damages, so the above limitations or exclusions may not apply to you.
2. THIS WARRANTY IS IN PLACE OF ANY OTHER EXPRESS WARRANTIES.
3. THIS WARRANTY APPLIES TO THE FIRST OWNER AND IS TRANSFERABLE TO SUBSEQUENT OWNER(S) ONLY THROUGH AN AUTHORIZED SUPRA DEALER DURING A PERIOD OF TWO YEARS FROM THE ORIGINAL PURCHASE DATE. SKIER'S CHOICE RESERVES THE RIGHT TO NOT TRANSFER THE WARRANTY ON ANY BOAT THAT HAS BEEN DAMAGED OR MISUSED.
4. THIS WARRANTY GIVES YOU SPECIFIC LEGAL RIGHTS, AND YOU MAY ALSO HAVE OTHER RIGHTS WHICH VARY FROM STATE TO STATE.
5. THIS WARRANTY IS EXPRESSLY IN LIEU OF ANY CONTRACTUAL LIABILITIES, INCLUDING PRODUCT LIABILITIES.
6. THE DEALER IS NOT THE AGENT OF SKIER'S CHOICE AND SKIER'S CHOICE DOES NOT AUTHORIZE THE DEALER, OR ANY OTHER PERSON, TO ASSUME ON BEHALF OF SKIER'S CHOICE ANY LIABILITY OR EXPENSE INCURRED IN THE COURSE OF REPAIRING ITS PRODUCTS OTHER THAN THOSE EXPRESSLY AUTHORIZED IN THIS LIMITED WARRANTY. THE DEALER MAY NOT EXTEND OR IN ANY WAY CHANGE OR AMEND THIS LIMITED WARRANTY.

---

## Owner's Responsibility

1. Before operating your Supra, it is necessary to read and fully understand this Owner's Manual and all other information delivered with the boat.
2. It is the owner's responsibility to take the boat to an authorized Supra dealer to obtain warranty service.
3. It is the owner's responsibility to properly operate and maintain the boat in accordance with this manual and all other information delivered with the boat.
4. The owner should keep maintenance records, should it be necessary to show that required maintenance has been performed on the boat.

## Dealer's Responsibility

1. The Dealer should provide the buyer with an adequate orientation in the general operation of the boat and review all systems and accessories included with the boat.
2. The Dealer should deliver a complete owner's manual packet with the boat consisting of Owner's Manual, Registration Engine Manual, Stereo Manual, Supra Warranty and all warranties for separately warranted items aboard the boat.
3. The Dealer should review all warranty information with the buyer and assist in filling out warranty cards if necessary.
4. The Dealer should ensure that any information or obligation from either Skier's Choice, Inc. or from the dealership is clearly understood by the buyer.
5. The Dealer should instruct the buyer in obtaining local service and out-of-area service for a Supra boat.

## Customer Assistance

The staff at Skier's Choice, Inc. is concerned with your complete satisfaction. This includes the prompt resolution of any problems that may arise during the warranty period. Normally, problems encountered may be efficiently and effectively resolved by your Supra Dealer. However, if a problem cannot be handled by the Dealer or if a solution is not satisfactory to you as an Owner, please follow these steps to get the matter resolved:

### STEP ONE

Discuss the problem with a member of your Supra Dealer's management staff. It is most likely that the problem will be resolved at this level.

### STEP TWO

If the Dealer management does not resolve the problem to your satisfaction, please have the problem and all action taken, documented by the Dealer, then contact the factory Customer Service Representative at Skier's Choice, Inc.:

Skier's Choice, Inc.  
1717 Henry G. Lane Street  
Maryville, TN 37801  
Tel: (865) 983-9924 Fax: (865) 983-9950

Describe the original problem in detail to the Customer Service Representative. Be prepared to furnish appropriate documentation and the reasons why service by the Dealer was unsatisfactory. If further action is required to resolve the problem, the Customer Service Representative will dictate the appropriate action.

### STEP THREE

Finally, if after following these steps and providing documentation and after obtaining necessary authorization from the Customer Service Representative to take additional action, the problem is still not resolved to your satisfaction, the President of Skier's Choice, Inc. will personally review the problem and make a determination concerning final resolution.

---

## Notes

<b>A</b>			
Accessory Power Switch	40		
Air Inflator—Sunsport 24V	58		
<b>B</b>			
Ballast System - Gravity (Optional)	43-44		
Battery & Cable Installation	55		
Battery Box	55		
Battery Specifications	55		
Bilge Area Drain Plug	29		
Bilge Inspection Plate	51		
Bilge Pump Switch	40		
Bimini Top (Optional)	54		
Blower Switch	41		
Boating Rules	15-17		
Boating Safety	5		
Boat Specifications	19-23		
Body Lubrication	64		
Bow Eye	50		
Bow Light	49		
Break-In Period	25		
<b>C</b>			
Canvas Cover	57		
CD Changer (Optional)	59		
Circuit Breaker Panels	42		
Coast Guard Regulations	26		
Cockpit Cover (Optional)	57		
Cooler	56		
Cooling Systems	64		
Courtesy Lights	40,49		
Customer Assistance	83		
<b>D</b>			
Daily Check List	4		
DC Outlet	24		
Dealer's Responsibilities	83		
Depth Sounder	36-37		
Double-Up Seating	52		
Driver's Seat	46		
<b>E</b>			
Engine Data	73		
Engine Hours and Gauge	34		
Engine Warm-Up	28		
Electrical Replacements (Bulbs & Fuses)	74		
<b>F</b>			
Fiberglass Care	69		
Filling Fuel Tank	30, 60		
Fire Extinguisher	47		
Foreign Material Deposits - Upholstery	70		
Fuel	30		
Fuel Cap Key	30, 43		
Fuel Filter	62		
Fuel Gauge	33		
Fuel Information	30, 60		
Fuel Precautions	60		
Fuel Tank	60		
Fuel Vent	60		
<b>G</b>			
Glove Box	53		
<b>H</b>			
Hoisting	72		
Horn	41		
Hull Identification Number	73		
Hull Protection	70		
<b>I</b>			
Ignition	41		
Ignition Key	45		
Introduction	3		
Instrument Panel & Controls	31		
<b>K</b>			
<b>L</b>			
Lifting Rings	50		
Lights—Docking	40		
<b>M</b>			
Maintenance Chart	64		
Maximum Capacities	26		
Mirror	45		
Motor Box (Inboard)	46		
<b>N</b>			
Navigation Lights	40		
Neutral Lock Out (Transmission)	28		
<b>O</b>			
Oil Dipstick	65		
Oil & Filter	65		
Oil Level Check	65		
Oil Pressure and Gauge	35-37		
Operating Information	25		
<b>P</b>			
Perfect Pass Cruise Control	31, 35-38		
Pole Light	49		
Pole Light Receptacle	49		
Propeller	52		
Propeller Precaution	52		
<b>R</b>			
Rad-A-Cage	48		
Rear Drain Plug	29		
Rub Rail Care	69		

(Continued Next Page)

## Index (continued)

### S

Safety Lanyard/Engine Shut-Off Switch	42
Safety Equipment	6
Satellite Radio (Optional)	58
Seat Adjustment	46
Service & Maintenance	63
Shaft Seal (Dripless)	67
Ski Locker	51
Ski Platform	50
Ski Platform Detachable Brackets	51
Ski Pylon (Inboard & V-Drive)	47
Slalom Course Speeds	31
Speedometer	32
Speed Calibration	36
Speedometer Paddle Wheel	32
Starting & Operation	25, 27
Stereo	39
Stereo Amp (Optional)	58
Stereo Switch	40
Stern Light	49
Subwoofer (Optional)	58
Summerization	71
Sundeck	51-52

### T

Tachometer	32
Teak Wood Care	70
Temperature Gauge	32
Throttle Lever	28
Tonneau Cover (Optional)	57
Tower Pole Light	49
Tower Speakers (Optional)	56
Tilt Steering	42
Trailer	75
Boat Buddy	78
Surge Brakes	78
"Gold Series" Oil Bath Bearings	78
Swing Tongue Optional	79
Boat Connecting	75-76
Loading Procedure	77
Trailer Alignment	76
Unloading Procedure	77
Transmission	66
Fluid Check	66
Fluid Specifications	66
Lockout	28
Trim Switch and Gauge	53
Triple-Up Seating	52

### U

Upholstery Care	70
-----------------	----

### V

V-Drive	
Engine Compartment	46
Fluid Check	66
Fuel Tank	60
Remote Oil Filter	65
Warning Light	42
Voltmeter	32, 34, 36

### W

Wakeboard Racks	56
Wake Plate (Hydraulic)	53
Walk-Thru Curtain (Optional)	59
Walk-Thru Windshield	54
Warning Labels	10
Warranty	81-82
Washing Your Boat	69
Water Strainer (Optional)	59
Windshield Care	69
Winterization	71

---



## Watersports Responsibility Code

Be aware that there are elements of risk in boating, skiing, and riding that common sense and personal awareness can help reduce. Know your ability level and stay within it.

To increase your enjoyment of the sport follow the "Watersports Responsibility Code".

It is your responsibility to:

- Familiarize yourself with all applicable laws, the risks inherent in the sport, and the proper use of equipment.
- Know the waterways where you will be skiing or riding. Do not ski or ride in shallow water, near shore, docks, pilings, swimmers, or other watercraft.
- Always have a person other than the boat driver as an observer and agree on hand signals before starting.
- Always wear a U.S. Coast Guard type III (PFD) vest.
- Read your owner's manual and inspect your equipment prior to use.
- Ski or ride within your limits. Always ski or ride in control and at speeds appropriate for your ability.
- Always turn ignition off when anyone is near watercraft power drive unit.
- Carbon Monoxide (CO) poisoning from engine exhaust may cause injury or death. Never "Platform Drag" or touch a swim platform while the engine is running.
- Not operate watercraft, ski or ride under the influence of alcohol or drugs.

Water Sports Industry Association

---

## Notes



## Free Manuals Download Website

<http://myh66.com>

<http://usermanuals.us>

<http://www.somanuals.com>

<http://www.4manuals.cc>

<http://www.manual-lib.com>

<http://www.404manual.com>

<http://www.luxmanual.com>

<http://aubethermostatmanual.com>

Golf course search by state

<http://golfingnear.com>

Email search by domain

<http://emailbydomain.com>

Auto manuals search

<http://auto.somanuals.com>

TV manuals search

<http://tv.somanuals.com>