

HDR-CX300/CX350/CX350V/ CX370/XR350/XR350V

Digital HD Video Camera Recorder

Operating Guide

US

Guía de operaciones

ES



HANDYCAM®

Owner's Record

The model and serial numbers are located on the bottom. Record the serial number in the space provided below. Refer to these numbers whenever you call upon your Sony dealer regarding this product.

Model No. HDR- _____

Serial No. _____

Model No. AC- _____

Serial No. _____



This symbol is intended to alert the user to the presence of important operating and maintenance (servicing) instructions in the literature accompanying the appliance.

WARNING

To reduce fire or shock hazard, do not expose the unit to rain or moisture.

Do not expose the batteries to excessive heat such as sunshine, fire or the like.

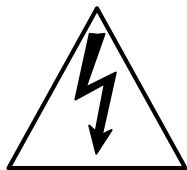
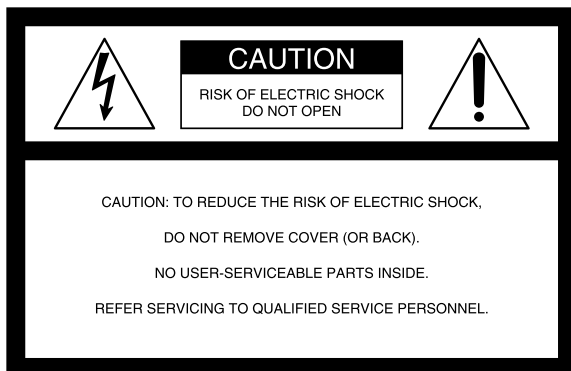

This symbol is intended to alert the user to the presence of uninsulated "dangerous voltage" within the product's enclosure that may be of sufficient magnitude to constitute a risk of electric shock to persons.

IMPORTANT SAFETY INSTRUCTIONS

SAVE THESE INSTRUCTIONS.
DANGER - TO REDUCE THE RISK OF FIRE
OR ELECTRIC SHOCK,
CAREFULLY FOLLOW THESE
INSTRUCTIONS.

- Read these instructions.
- Keep these instructions.
- Heed all warnings.
- Follow all instructions.
- Do not use this apparatus near water.
- Clean only with dry cloth.
- Do not block any ventilation openings. Install in accordance with the manufacturer's instructions.
- Do not install near any heat sources such as radiators, heat registers, stoves, or other apparatus (including amplifiers) that produce heat.
- Do not defeat the safety purpose of the polarized or grounding-type plug. A polarized plug has two blades with one wider than the other. A grounding type plug has two blades and a third grounding prong. The wide blade or the third prong are provided for your safety. If the provided plug does not fit into your outlet, consult an electrician for replacement of the obsolete outlet.
- Protect the power cord from being walked on or pinched particularly at plugs, convenience receptacles, and the point where they exit from the apparatus.
- Only use attachments/accessories specified by the manufacturer.
- Use only with the cart, stand, tripod, bracket, or table specified by the manufacturer, or sold with the apparatus. When a cart is used, use caution when moving the cart/apparatus combination to avoid injury from tip-over.



- Unplug this apparatus during lightning storms or when unused for long periods of time.
- Refer all servicing to qualified service personnel. Servicing is required when the apparatus has been damaged in any way, such as power-supply cord or plug is damaged, liquid has been spilled or objects have fallen into the apparatus, the apparatus has been exposed to rain or moisture, does not operate normally, or has been dropped.
- If the shape of the plug does not fit the power outlet, use an attachment plug adaptor of the proper configuration for the power outlet.

US

Representative plug of power supply cord of countries/regions around the world.

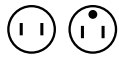

A Type
(American Type)



B Type
(British Type)



BF Type
(British Type)



B3 Type
(British Type)



C Type
(CEE Type)



SE Type
(CEE Type)



O Type
(Ocean Type)

The representative supply voltage and plug type are described in this chart.

Depend on an area, Different type of plug and supply voltage are used.

Attention: Power cord meeting demands from each country shall be used.

– For only the United States

Use a UL Listed, 1.5-3 m (5-10 ft.), Type SPT-2 or NISPT-2, AWG no. 18 power supply cord, rated for 125 V 7 A, with a NEMA 1-15P plug rated for 125 V 15 A.”

Europe

Countries/regions	Voltage	Frequency (Hz)	Plug type
Austria	230	50	C
Belgium	230	50	C
Czech	220	50	C
Denmark	230	50	C
Finland	230	50	C
France	230	50	C
Germany	230	50	C
Greece	220	50	C
Hungary	220	50	C
Iceland	230	50	C
Ireland	230	50	C/BF
Italy	220	50	C
Luxemburg	230	50	C
Netherlands	230	50	C
Norway	230	50	C
Poland	220	50	C
Portugal	230	50	C
Romania	220	50	C
Russia	220	50	C
Slovak	220	50	C
Spain	127/230	50	C
Sweden	230	50	C
Switzerland	230	50	C
UK	240	50	BF

Asia

Countries/regions	Voltage	Frequency (Hz)	Plug type
China	220	50	A
Hong Kong	200/220	50	BF
India	230/240	50	C
Indonesia	127/230	50	C
Japan	100	50/60	A
Korea (rep)	220	60	C
Malaysia	240	50	BF
Philippines	220/230	60	A/C
Singapore	230	50	BF
Taiwan	110	60	A
Thailand	220	50	C/BF

Countries/regions	Voltage	Frequency (Hz)	Plug type
Vietnam	220	50	A/C

Oceania

Countries/regions	Voltage	Frequency (Hz)	Plug type
Australia	240	50	O
New Zealand	230/240	50	O

North America

Countries/regions	Voltage	Frequency (Hz)	Plug type
Canada	120	60	A
USA	120	60	A

Central America

Countries/regions	Voltage	Frequency (Hz)	Plug type
Bahamas	120/240	60	A
Costa Rica	110	60	A
Cuba	110/220	60	A/C
Dominican (rep)	110	60	A
El Salvador	110	60	A
Guatemala	120	60	A
Honduras	110	60	A
Jamaica	110	50	A
Mexico	120/127	60	A
Nicaragua	120/240	60	A
Panama	110/220	60	A

South America

Countries/regions	Voltage	Frequency (Hz)	Plug type
Argentina	220	50	C/BF/O
Brazil	127/220	60	A/C
Chile	220	50	C
Colombia	120	60	A
Peru	220	60	A/C
Venezuela	120	60	A

Middle East

Countries/regions	Voltage	Frequency (Hz)	Plug type
Iran	220	50	C/BF
Iraq	220	50	C/BF
Israel	230	50	C
Saudi Arabia	127/220	50	A/C/BF
Turkey	220	50	C
UAE	240	50	C/BF

Africa

Countries/regions	Voltage	Frequency (Hz)	Plug type
Algeria	127/220	50	C
Congo (dem)	220	50	C
Egypt	220	50	C
Ethiopia	220	50	C
Kenya	240	50	C/BF
Nigeria	230	50	C/BF
South Africa	220/230	50	C/BF
Tanzania	230	50	C/BF
Tunisia	220	50	C

Read this first

Before operating the unit, please read this manual thoroughly, and retain it for future reference.

CAUTION

Battery pack

If the battery pack is mishandled, the battery pack can burst, cause a fire or even chemical burns. Observe the following cautions.

- Do not disassemble.
- Do not crush and do not expose the battery pack to any shock or force such as hammering, dropping or stepping on it.
- Do not short circuit and do not allow metal objects to come into contact with the battery terminals.
- Do not expose to high temperature above 60°C (140°F) such as in direct sunlight or in a car parked in the sun.
- Do not incinerate or dispose of in fire.
- Do not handle damaged or leaking lithium ion batteries.
- Be sure to charge the battery pack using a genuine Sony battery charger or a device that can charge the battery pack.
- Keep the battery pack out of the reach of small children.
- Keep the battery pack dry.
- Replace only with the same or equivalent type recommended by Sony.
- Dispose of used battery packs promptly as described in the instructions.

Replace the battery with the specified type only. Otherwise, fire or injury may result.

AC Adaptor

Do not use the AC Adaptor placed in a narrow space, such as between a wall and furniture.

Use the nearby wall outlet (wall socket) when using the AC Adaptor. Disconnect the AC Adaptor from the wall outlet (wall

socket) immediately if any malfunction occurs while using your camcorder.

Even if your camcorder is turned off, AC power source (mains) is still supplied to it while connected to the wall outlet (wall socket) via the AC Adaptor.

For customers in the U.S.A. and CANADA

RECYCLING LITHIUM-ION BATTERIES

Lithium-Ion batteries are recyclable. You can help preserve our environment by returning your used rechargeable batteries to the collection and recycling location nearest you.



For more information regarding recycling of rechargeable batteries, call toll free 1-800-822- 8837, or visit <http://www.rbrc.org/>

Caution: Do not handle damaged or leaking Lithium-Ion batteries.

Battery pack

This device complies with Part 15 of the FCC Rules. Operation is subject to the following two conditions: (1) This device may not cause harmful interference, and (2) this device must accept any interference received, including interference that may cause undesired operation.

This Class B digital apparatus complies with Canadian ICES-003.

For the customers in the U.S.A.

UL is an internationally recognized safety organization.
The UL Mark on the product means it has been UL Listed.

If you have any questions about this product, you may call:
Sony Customer Information Center 1-800-222-SONY (7669).
The number below is for the FCC related matters only.

Regulatory Information

Declaration of Conformity

Trade Name: SONY
Model No.: HDR-CX300
Responsible Party: Sony Electronics Inc.
Address: 16530 Via Esprillo, San Diego, CA 92127 U.S.A.
Telephone No.: 858-942-2230
This device complies with Part 15 of the FCC Rules. Operation is subject to the following two conditions: (1) This device may not cause harmful interference, and (2) this device must accept any interference received, including interference that may cause undesired operation.

Declaration of Conformity

Trade Name: SONY
Model No.: HDR-CX350V
Responsible Party: Sony Electronics Inc.
Address: 16530 Via Esprillo, San Diego, CA 92127 U.S.A.
Telephone No.: 858-942-2230
This device complies with Part 15 of the FCC Rules. Operation is subject to the following two conditions: (1) This device may not cause harmful interference, and (2) this device must accept any interference received, including interference that may cause undesired operation.

Declaration of Conformity

Trade Name: SONY
Model No.: HDR-XR350V
Responsible Party: Sony Electronics Inc.
Address: 16530 Via Esprillo, San Diego, CA 92127 U.S.A.
Telephone No.: 858-942-2230
This device complies with Part 15 of the FCC Rules. Operation is subject to the following two conditions: (1) This device may not cause harmful interference, and (2) this device must accept any interference received, including interference that may cause undesired operation.

CAUTION

You are cautioned that any changes or modifications not expressly approved in this manual could void your authority to operate this equipment.

Note

This equipment has been tested and found to comply with the limits for a Class B digital device, pursuant to Part 15 of the FCC Rules.

These limits are designed to provide reasonable protection against harmful interference in a residential installation. This equipment generates, uses, and can radiate radio frequency energy and, if not installed and used in accordance with the instructions, may cause harmful interference to radio communications. However, there is no guarantee that interference will not occur in a particular installation. If this equipment does cause harmful interference to radio or television reception, which can be determined by turning the equipment off and on, the user is encouraged to try to correct the interference by one or more of the following measures:

- Reorient or relocate the receiving antenna.

- Increase the separation between the equipment and receiver.
- Connect the equipment into an outlet on a circuit different from that to which the receiver is connected.
- Consult the dealer or an experienced radio/TV technician for help.

The supplied interface cable must be used with the equipment in order to comply with the limits for a digital device pursuant to Subpart B of Part 15 of FCC Rules.

For the State of California , USA only

Perchlorate Material – special handling may apply,
See

www.dtsc.ca.gov/hazardouswaste/perchlorate

Perchlorate Material: Lithium battery contains perchlorate.

Supplied items

The numbers in () are the supplied quantity.

- AC Adaptor (1)
- Power cord (Mains lead) (1)
- Component A/V cable (1) **A**
- A/V connecting cable (1) **B**
- USB cable (1) **C**
- Wireless Remote Commander (1)
A button-type lithium battery is already installed. Remove the insulation sheet before using the Wireless Remote Commander.
- Rechargeable battery pack NP-FV50 (1)
- CD-ROM “Handycam” Application Software (1) (p. 37)
 - “PMB” (software, including “PMB Help”)
 - “Handycam” Handbook (PDF)
- “Operating Guide” (This manual) (1)

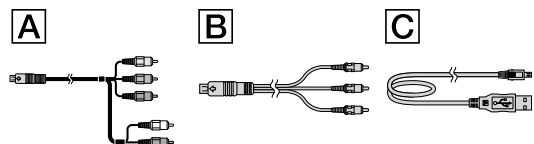

- See page 21 for the memory card you can use with this camcorder.

Using the camcorder

- Do not hold the camcorder by the following parts, and also do not hold the camcorder by the jack covers.

Shoe cover

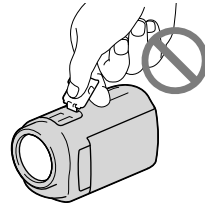

LCD Screen

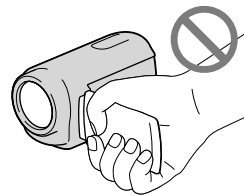

Battery pack

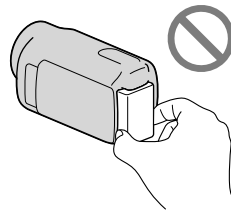

- The camcorder is not dustproofed, dripproofed or waterproofed. See “Precautions” (p. 66).
- Even if the camcorder is turned off, the GPS function is working as long as the GPS switch is set to ON. Make sure that the GPS switch is set to OFF during take off and landing of an airplane (HDR-CX350V/XR350V).

Menu items, LCD panel, and lens

- A menu item that is grayed out is not available under the current recording or playback conditions.
- The LCD screen is manufactured using extremely high-precision technology, so over 99.99% of the pixels are operational for effective use. However, there may be some tiny black points and/or bright points (white, red, blue, or green in color) that appear constantly on the

LCD screen. These points are normal results of the manufacturing process and do not affect the recording in any way.

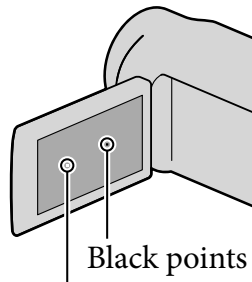

White, red, blue or green points

- Exposing the LCD screen or the lens to direct sunlight for long periods of time may cause malfunctions.
- Do not aim at the sun. Doing so might cause your camcorder to malfunction. Take images of the sun only in low light conditions, such as at dusk.

About language setting

- The on-screen displays in each local language are used for illustrating the operating procedures. Change the screen language before using the camcorder if necessary (p. 19).

On recording

- To ensure stable operation of the memory card, it is recommended to initialize the memory card with your camcorder before the first use. Initializing the memory card will erase all the data stored on it and the data will be irrecoverable. Save your important data on your PC etc.
- Before starting to record, test the recording function to make sure the image and sound are recorded without any problems.
- Compensation for the contents of recordings cannot be provided, even if recording or playback is not possible due to a malfunction of the camcorder, recording media, etc.
- TV color systems differ depending on the country/region. To view your recordings on a TV, you need a NTSC system-based TV.
- Television programs, films, video tapes, and other materials may be copyrighted.

Unauthorized recording of such materials may be contrary to the copyright laws.

Notes on playing back

- The camcorder is compatible with MPEG-4 AVC/H.264 High Profile for high definition image quality (HD) recording. Therefore, you cannot play back images recorded with high definition image quality (HD) on the camcorder with the following devices;
 - Other AVCHD format compatible devices which are not compatible with High Profile
 - Devices which are not compatible with the AVCHD format
- You may not be able to play back normally images recorded on your camcorder with other devices. Also, you may not be able to play back images recorded on other devices with your camcorder.

Discs recorded with HD image quality (high definition)

- This camcorder captures high definition footage in the AVCHD format. DVD media containing AVCHD footage should not be used with DVD based players or recorders, as the DVD player/recorder may fail to eject the media and may erase its contents without warning. DVD media containing AVCHD footage may be played on a compatible Blu-ray Disc™ player/recorder or other compatible device.

Save all your recorded image data

- To prevent your image data from being lost, save all your recorded images on external media periodically. It is recommended that you save the image data on a disc such as DVD-R, etc. using your computer. Also, you can save your image data using a VCR, or a DVD/HDD recorder (p. 49).
- You cannot make a AVCHD disc from the image data recorded with **MENU** (MENU) → [Show others] → [REC MODE] (under [SHOOTING SET] category) set to [HD FX]. Save them on a Blu-ray Disc or using an external media (p. 45, 47).

Notes on battery pack/AC Adaptor

- Be sure to remove the battery pack or the AC Adaptor after turning off the camcorder.
- Disconnect the AC Adaptor from the camcorder, holding both the camcorder and the DC plug.

Note on the camcorder/battery pack temperature

- When the temperature of the camcorder or battery pack becomes extremely high or extremely low, you may not be able to record or play back on the camcorder, due to the protection features of the camcorder being activated in such situations. In this case, an indicator appears on the LCD screen.

When the camcorder is connected to a computer or accessories

- Do not try to format the recording media of the camcorder using a computer. If you do so, your camcorder may not operate correctly.
- When connecting the camcorder to another device with communication cables, be sure to insert the connector plug in the correct way. Pushing the plug forcibly into the terminal will damage the terminal and may result in a malfunction of the camcorder.

If you cannot record/play back images, perform [MEDIA FORMAT]

- If you repeat recording/deleting images for a long time, fragmentation of data occurs on the recording media. Images cannot be saved or recorded. In such a case, save your images on some type of external media first, and then perform [MEDIA FORMAT] by touching **MENU** (MENU) → [Show others] → [MEDIA FORMAT] (under [MANAGE MEDIA] category) → the desired medium → [YES] → [YES] → **OK**.

Notes on optional accessories

- We recommend using genuine Sony accessories.
- Genuine Sony accessories may not be available in some countries/regions.

About this manual, illustrations and on-screen displays

- The example images used in this manual for illustration purposes are captured using a digital still camera, and therefore may appear different from images and screen indicators that actually appear on your camcorder. And, the illustrations of your camcorder and its screen indication are exaggerated or simplified for understandability.
- In this manual, the internal memory (HDR-CX300/CX350/CX350V/CX370) and the hard disk (HDR-XR350/XR350V) of the camcorder and the memory card are called “recording media.”
- In this manual, the DVD disc recorded with high definition image quality (HD) is called AVCHD disc.
- Design and specifications of your camcorder and accessories are subject to change without notice.



Confirm the model name of your camcorder

- The model name is shown in this manual when there is a difference in specification between models. Confirm the model name on the bottom of your camcorder.
- The main differences in specification of this series are as follows.

	Recording media	Capacity of internal recording media	USB jack
HDR-CX300	Internal memory + memory card	16 GB	Input/output
HDR-CX350/ HDR-CX350V*		32 GB	
HDR-CX370		64 GB	
HDR-XR350/ HDR-XR350V*	Internal hard disk + memory card	160 GB	

The model with * is equipped with GPS.

Notes on use

- Do not do any of the following. Otherwise, the recording media may be damaged, recorded images may be impossible to play back or may be lost, or other malfunctions could occur.
 - ejecting the memory card when the access lamp (p. 22) is lit or flashing
 - removing the battery pack or AC Adaptor from the camcorder, or applying mechanical shock or vibration to the camcorder when the  (Movie)/ (Photo) lamps (p. 23) or the access lamp (p. 22) are lit or flashing
- When using a shoulder belt (sold separately), do not crash the camcorder against an object.
- Do not use your camcorder in very loud areas.

On the drop sensor (HDR-XR350/ XR350V)

- To protect the internal hard disk from shock by dropping, the camcorder has a drop sensor function. When a drop occurs, or under a non-gravity condition, the block noise made when this function is activated by the camcorder may also be recorded. If the drop sensor catches a drop repeatedly, recording/playback may be stopped.

Note on using the camcorder at high altitudes (HDR-XR350/XR350V)

- Do not turn on the camcorder in a low-pressure area, where the altitude is more than 5,000 meters (16,000 feet). Doing so may damage the internal hard disk drive of your camcorder.

Operation flow

Getting started (p. 15)

Prepare the power source and memory card.

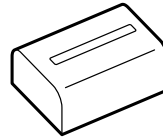

Recording movies and photos (p. 23)

Recording movies → p. 24

💡 Changing the recording mode

💡 Expected recording time(MEDIA INFO)

Shooting photos → p. 26

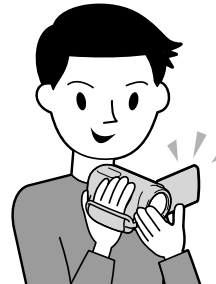

Playing movies and photos

Playback on the camcorder → p. 28

Playing images on a TV → p. 31

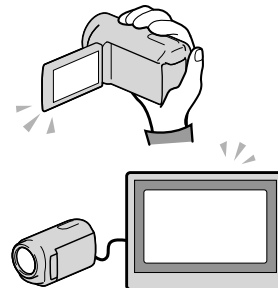

Saving images

Saving movies and photos with a computer → p. 36

Saving movies and photos in external media → p. 47

Saving images with a DVD writer/recorder → p. 49

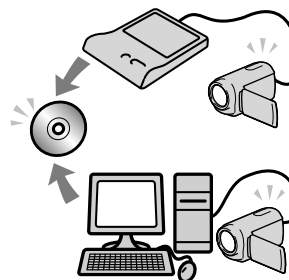

Deleting movies and photos (p. 34)

If you delete the image data that has been saved on your computer or a disc, you can record new images on the free media space again.

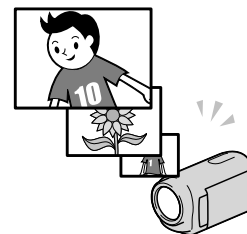

Table of contents

IMPORTANT SAFETY INSTRUCTIONS	3
Read this first.....	6
Operation flow.....	12
■ Getting started	
Step 1: Charging the battery pack.....	15
Charging the battery pack abroad	17
Step 2: Turning the power on, and setting the date and time	18
Changing the language setting.....	19
Step 3: Preparing the recording media	20
To check the recording media settings.....	21
Dubbing or copying movies and photos from the internal recording media to memory card	22
■ Recording/Playback	
Recording.....	23
Acquiring location information using the GPS (HDR-CX350V/XR350V)	27
Playback on the camcorder	28
Playing images on a TV	31
■ Making good use of your camcorder	
Deleting movies and photos.....	34
■ Saving movies and photos with a computer	
Preparing a computer (Windows)	36
When using a Macintosh.....	37
Starting PMB (Picture Motion Browser).....	39
Selecting the method for creating a disc (computer).....	40
Creating a disc with one touch (One Touch Disc Burn)	42
Importing movies and photos to a computer.....	43
Creating an AVCHD disc	44
Playing an AVCHD disc on a computer.....	44
Creating a Blu-ray disc.....	45
Creating a standard definition image quality (STD) disc that can be played on ordinary DVD players.....	45
Copying a disc.....	46
Editing movies	46
Capturing photos from a movie	46

■ Saving images with an external device	
Saving images in external media (DIRECT COPY).....	47
Creating a disc with a DVD writer, recorder.....	49
■ Customizing your camcorder	
Using menus.....	56
Getting detailed information from the “Handycam” Handbook.....	63
■ Additional information	
? Troubleshooting.....	64
Precautions.....	66
Specifications.....	68
■ Quick reference	
Screen indicators.....	73
Parts and controls.....	74
Index.....	77

Step 1: Charging the battery pack

HDR-CX300/CX350/CX350V/CX370

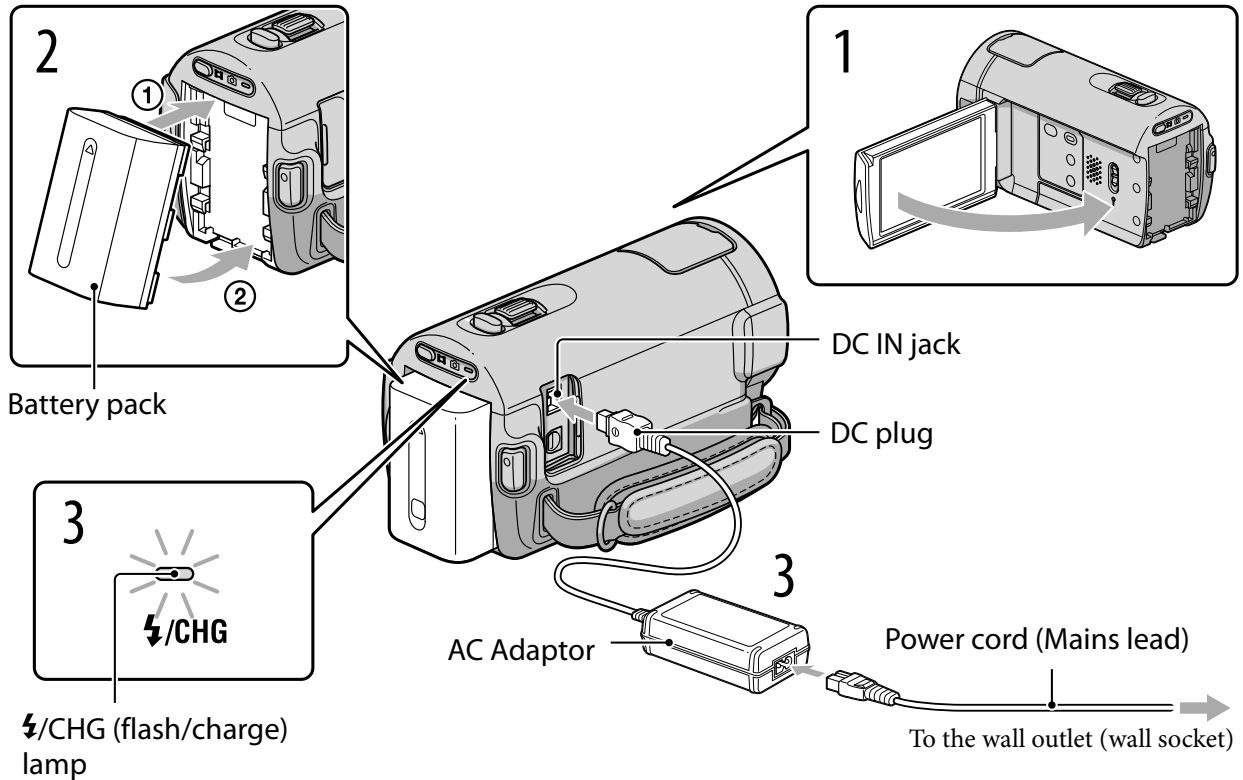

HDR-XR350/XR350V

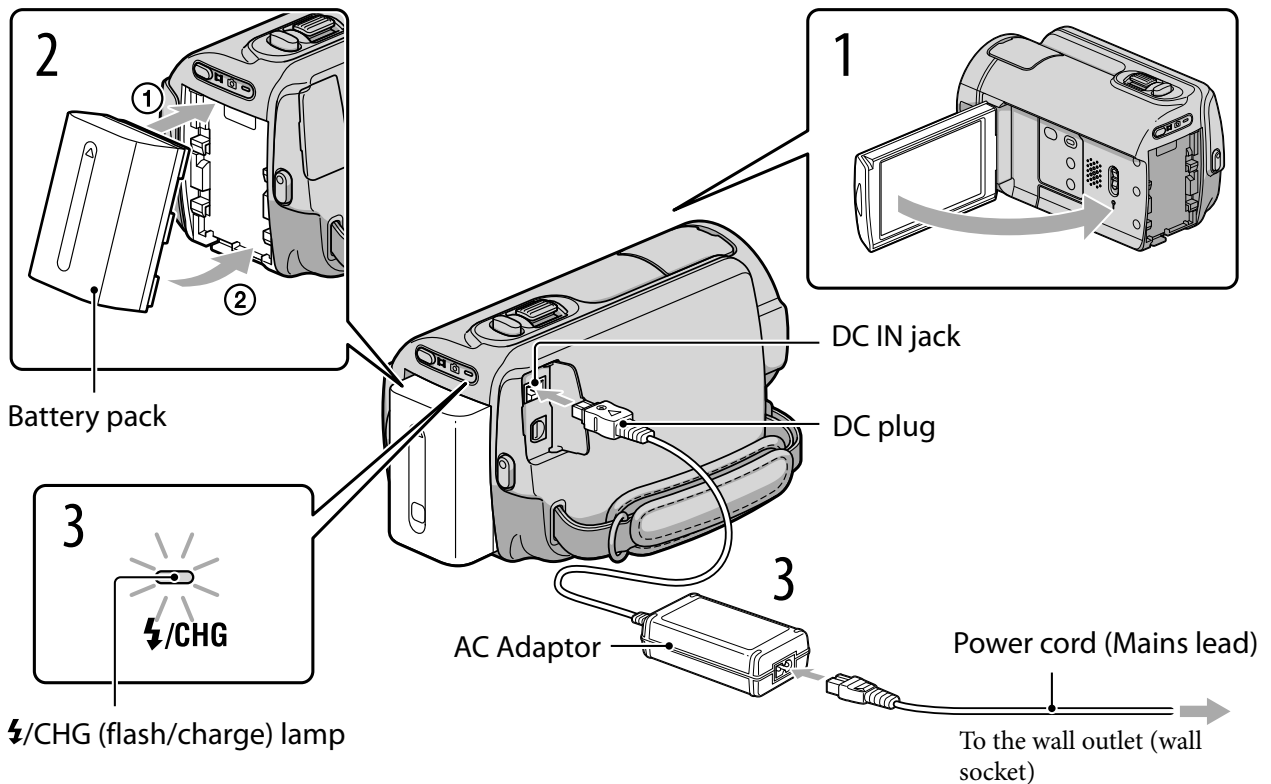

You can charge the “InfoLITHIUM” battery pack (V series) after attaching it to your camcorder.

⚡ Notes

- You cannot attach any “InfoLITHIUM” battery pack other than the V series to your camcorder.

1 Turn off your camcorder by closing the LCD screen.

2 Attach the battery pack by aligning the battery terminals (①) and pushing the battery pack in the direction of the arrow (②) until it clicks.

3 Connect the AC Adaptor and the power cord (mains lead) to your camcorder and the wall outlet (wall socket).

- Align the ▲ mark on the DC plug with that on the DC IN jack.

The ⚡/CHG (flash/charge) lamp lights up and charging starts. The ⚡/CHG (flash/charge) lamp turns off when the battery pack is fully charged.

4 When the battery is charged, disconnect the AC Adaptor from the DC IN jack of your camcorder.

💡 Tips

- See page 70 on recording and playing time.
- When your camcorder is on, you can check the approximate amount of remaining battery power with the remaining battery indicator at the upper left on the LCD screen.

To remove the battery pack

Close the LCD screen. Pushing the PUSH (battery release) button (①), remove the battery pack in the direction of the arrow (②).

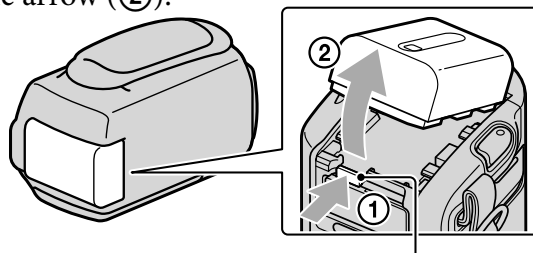



PUSH (battery release) button

To use a wall outlet (wall socket) as a power source

Make the same connections as “Step 1: Charging the battery pack.” Even if the battery pack is attached, the battery pack is not discharged.

Notes on the battery pack

- When you remove the battery pack or disconnect the AC Adaptor, close the LCD screen and make sure that the  (Movie)/ (Photo) lamps (p. 23), the access lamp (p. 22) are turned off.
- The /CHG (flash/charge) lamp flashes during charging under the following conditions:
 - The battery pack is not attached correctly.
 - The battery pack is damaged.
 - The temperature of the battery pack is low.
Remove the battery pack from your camcorder and put it in a warm place.
 - The temperature of the battery pack is high.
Remove the battery pack from your camcorder and put it in a cool place.
- When attaching a video light (sold separately), it is recommended that you use an NP-FV70 or NP-FV100 battery pack.
- We do not recommend using an NP-FV30, which only allows short recording and playback times, with your camcorder.
- In the default setting, the power turns off automatically if you leave your camcorder without any operation for about 5 minutes, to save battery power ([A.SHUT OFF]).

Notes on the AC Adaptor

- Use the nearby wall outlet (wall socket) when using the AC Adaptor. Disconnect the AC Adaptor from the wall outlet (wall socket) immediately if any malfunction occurs while using your camcorder.
- Do not use the AC Adaptor placed in a narrow space, such as between a wall and furniture.
- Do not short-circuit the DC plug of the AC Adaptor or battery terminal with any metallic objects. This may cause a malfunction.

Charging the battery pack abroad

You can charge the battery pack in any countries/regions using the AC Adaptor supplied with your camcorder within the AC 100 V - 240 V, 50 Hz/60 Hz range.

- Do not use an electronic voltage transformer.

Step 2: Turning the power on, and setting the date and time

1 Open the LCD screen of your camcorder.

Your camcorder is turned on and the lens cover is opened.

- To turn on your camcorder when the LCD screen is open, press POWER.

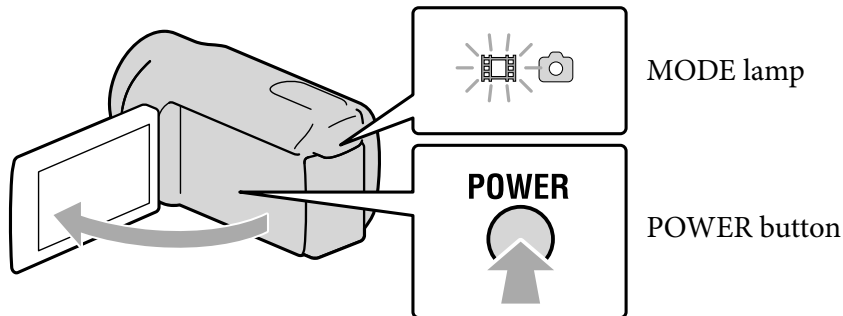

2 Select the desired geographical area with **▲**/**▼**, then touch [NEXT].

Touch the button on the LCD screen

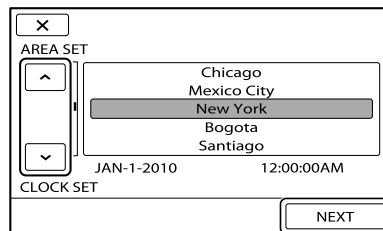
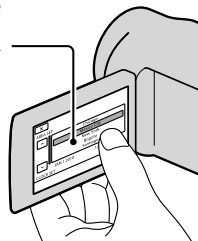

- To set the date and time again, touch **MENU** (MENU) → [Show others] → [CLOCK/ **LANG**] (under **GENERAL SET** category) → [CLOCK SET]. When an item is not on the screen, touch **▲**/**▼** until the item appears.



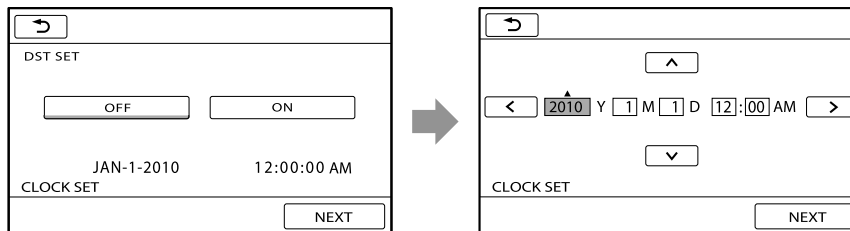

3 Set [DST SET] or [SUMMERTIME], date and time, then touch **OK**.

The clock starts.

- If you set [DST SET] or [SUMMERTIME] to [ON], the clock advances 1 hour.



⚡ Notes

- The date and time does not appear during recording, but they are automatically recorded on the recording media, and can be displayed during playback. To display the date and time, touch **MENU** (MENU) → [Show others] → [PLAYBACK SET] (under  [PLAYBACK] category) → [DATA CODE] → [DATE/TIME] → **OK** →  → **X**.
- You can turn off the operation beeps by touching **MENU** (MENU) → [Show others] → [SOUND/DISP SET] (under  [GENERAL SET] category) → [BEEP] → [OFF] → **OK** →  → **X**.
- If the button you touch does not react correctly, calibrate the touch panel.
- Once the clock is set, the clock time is automatically adjusted with [AUTO CLOCK ADJ] and [AUTO AREA ADJ] set to [ON]. The clock may not be adjusted to the correct time automatically, depending on the country/region selected for your camcorder. In this case, set [AUTO CLOCK ADJ] and [AUTO AREA ADJ] to [OFF] (HDR-CX350V/XR350V).

To turn off the power



Close the LCD screen. The  (Movie) lamp flashes for a few seconds and the power is turned off.

💡 Tips

- You can turn off your camcorder also by pressing POWER.
- When [POWER ON BY LCD] is set to [OFF], turn off your camcorder by pressing POWER.

Changing the language setting

You can change the on-screen displays to show messages in a specified language.

Touch **MENU** (MENU) → [Show others] → [CLOCK/ LANG] (under  [GENERAL SET] category) → [ LANGUAGE SET] → a desired language → **OK** →  → **X**.

Step 3: Preparing the recording media

The recording media that can be used differs depending on your camcorder. The following icons are displayed on the screen of your camcorder.

HDR-CX300/CX350/CX350V/CX370

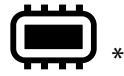

Internal
memory



Memory
card

HDR-XR350/XR350V



Internal hard
disk



Memory
card

* In the default setting, both movies and photos are recorded on this recording media. You can perform recording, playback and editing operations on the selected medium.

Tips

- See page 70 for the recordable time of movies.

Selecting the recording media for movies

- 1 Touch **MENU** (MENU) → [Show others] → [MEDIA SETTINGS] (under  [MANAGE MEDIA] category) → [MOVIE MEDIA SET].

The [MOVIE MEDIA SET] screen appears.

- 2 Touch the desired recording media.

- 3 Touch [YES] → **OK**.

The recording medium is changed.

Selecting the recording media for photos

- 1 Touch **MENU** (MENU) → [Show others] → [MEDIA SETTINGS] (under  [MANAGE MEDIA] category) → [PHOTO MEDIA SET].

The [PHOTO MEDIA SET] screen appears.

- 2 Touch the desired recording media.

3 Touch [YES] → **OK**.

The recording medium is changed.

To check the recording media settings

In either movie recording mode or photo recording mode, the media icon of the selected recording media is displayed at the top right corner of the screen.

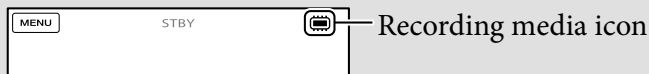

- The icon displayed may vary depending on your model.

Inserting a memory card

⚡ Notes

- Set the recording medium to [MEMORY CARD] to record movies and/or photos on a memory card.

Types of memory card you can use with your camcorder

- Only “Memory Stick PRO Duo” (Mark2) media, “Memory Stick PRO-HG Duo” media, SD memory cards (Class 4 or faster) and SDHC memory cards (Class 4 or faster) can be used with this camcorder. A MultiMediaCard cannot be used with this camcorder.
- In this manual, “Memory Stick PRO Duo” (Mark2) media and “Memory Stick PRO-HG Duo” media are called “Memory Stick PRO Duo” media.
- Memory cards of up to 32 GB have been verified to operate with your camcorder.

“Memory Stick PRO Duo” media/“Memory Stick PRO-HG Duo” media
(This size can be used with your camcorder.)



- “Memory Stick PRO Duo” media can be used only with “Memory Stick PRO” media compatible equipment.
- Do not attach a label or the like on “Memory Stick PRO Duo” media or “Memory Stick Duo” media adaptor.

Open the cover, and insert the memory card with the notched edge in the direction as illustrated until it clicks.

- Close the cover after inserting the memory card.

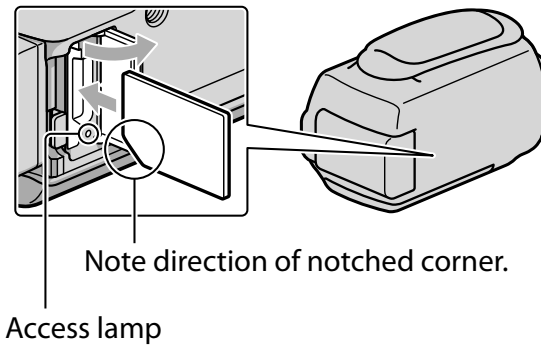

The [Create a new Image Database File.] screen may appear if you insert a new memory card. In that case, touch [YES]. If you record only photos on the memory card, touch [NO].

- Confirm the direction of the memory card. If you forcibly insert the memory card in the wrong direction, the memory card, memory card slot, or image data may be damaged.

⚡ Notes

- If [Failed to create a new Image Database File. It may be possible that there is not enough free space.] is displayed, format the memory card by touching **MENU** (MENU) → [Show others] → [MEDIA FORMAT] (under [MANAGE MEDIA] category) → [MEMORY CARD] → [YES] → [YES] → **OK**.

To eject the memory card

Open the cover and lightly push the memory card in once.

- Do not open the cover during recording.
- When inserting or ejecting the memory card, be careful so that the memory card does not pop out and drop.

Dubbing or copying movies and photos from the internal recording media to memory card

Touch **MENU** (MENU) → [Show others] → [MOVIE DUB]/[PHOTO COPY] (under [EDIT] category), then follow the displays on the screen.

Recording

In the default setting, movies are recorded with high definition image quality (HD) on the following media.

HDR-CX300/CX350/CX350V/CX370: Internal memory

HDR-XR350/XR350V: Internal hard disk

Tips

- To change the recording media, see page 20.

1 Fasten the grip belt.

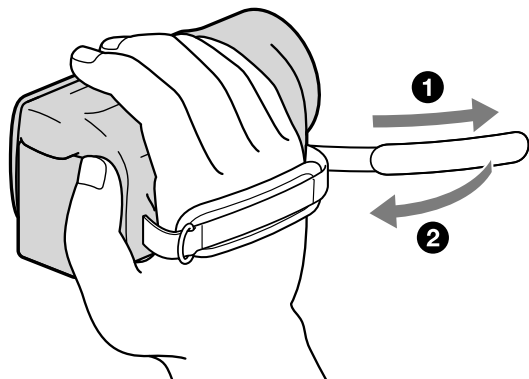

2 Open the LCD screen of your camcorder.

Your camcorder is turned on and the lens cover is opened.

- To turn on your camcorder when the LCD screen is already open, press POWER (p. 18).
- You can switch recording modes by pressing MODE. Press MODE to light up the desired recording mode lamp.

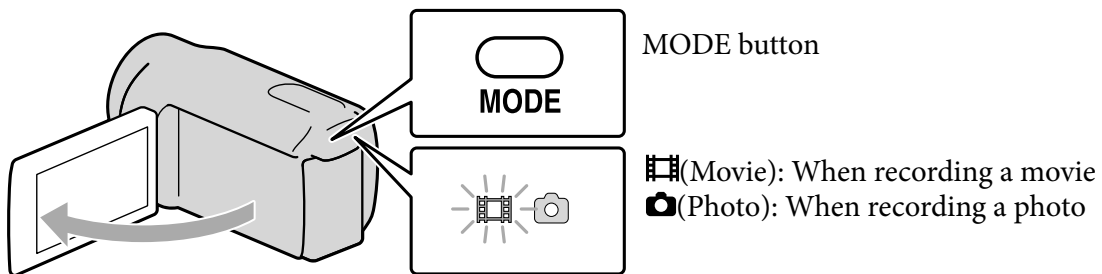

Recording movies

Press START/STOP to start recording.

- You can start recording also by touching ● in the bottom left of LCD screen.

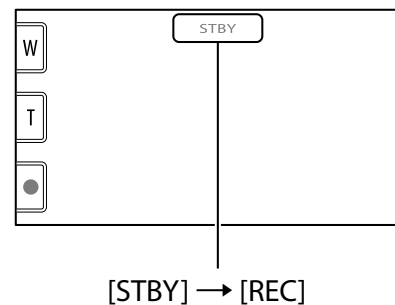
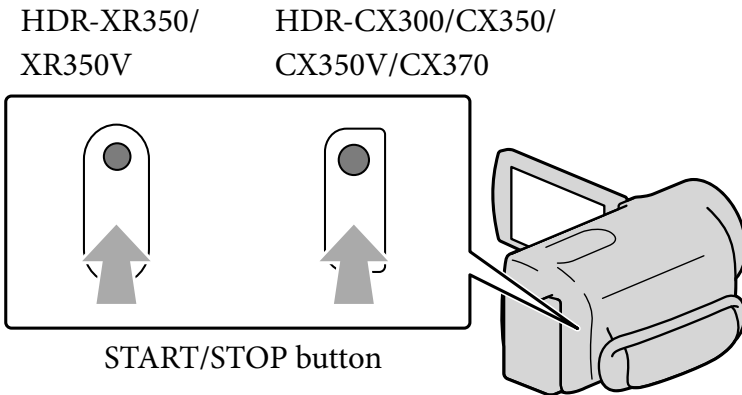

To stop recording, press START/STOP again.

- You can stop recording also by touching ● in the bottom left of LCD screen.

-
- The icons and indicators on the LCD panel will be displayed for about 3 seconds, then disappear after turning on your camcorder or switching the recording (movie/photo)/playback modes. To display the icons and indicators again, touch anywhere on the screen except the rec & zoom buttons on the LCD.

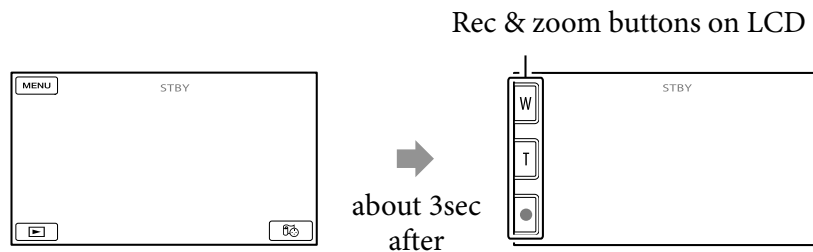

⚡ Notes

- If you close the LCD screen while recording movies, the camcorder stops recording.
- The maximum continuous recordable time of movies is about 13 hours.
- When a movie file exceeds 2 GB, the next movie file is created automatically.

- It will take several seconds until you can start recording after you turn on the camcorder. You cannot operate your camcorder during this time.
- The following states will be indicated if data is still being written onto the recording media after recording has finished. During this time, do not apply shock or vibration to the camcorder, or remove the battery or AC Adaptor.
 - Access lamp (p. 22) is lit or flashing
 - The media icon in the upper right of the LCD screen is flashing

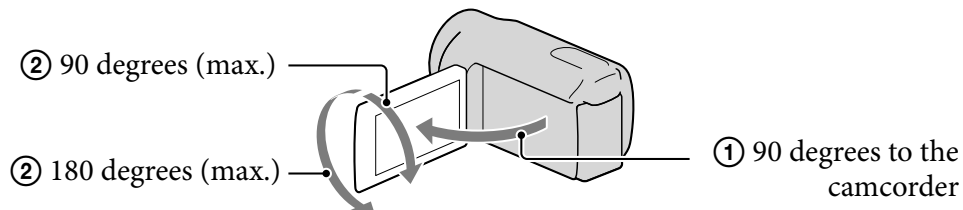

Tips

- See page 70 on the recordable time of movies.
- You can record photos during movie recording by pressing PHOTO fully (Dual Rec).
- When a face is detected, a white frame appears and the image quality around the face is optimized automatically ([FACE DETECTION]).
- You can specify the priority face by touching it.
- In the default setting, a photo is recorded automatically when the camcorder detects the smile of a person during movie recording (Smile Shutter).
- You can capture photos from recorded movies.
- You can check the recordable time, estimated remaining capacity, etc., by touching **MENU** (MENU) → [Show others] → [MEDIA INFO] (under  [MANAGE MEDIA] category).
- The LCD screen of your camcorder can display recording images across the entire screen (full pixel display). However, this may cause slight trimming of the top, bottom, right and left edges of images when played back on a TV which is not compatible with full pixel display. In this case, set [GUIDEFRAAME] to [ON], and record images using the outer frame displayed on the screen as a guide.
- To adjust the angle of the LCD panel, first open the LCD panel 90 degrees to the camcorder (①), and then adjust the angle (②).



- [STeadyShot] is set to [ACTIVE] in the default setting.

Data code during recording

The recording date, time and condition, and coordinates (HDR-CX350V/XR350V) are recorded automatically on the recording media. They are not displayed during recording. However, you can check them as [DATA CODE] during playback. To display them, touch **MENU** (MENU) → [Show others] → [PLAYBACK SET] (under  [PLAYBACK] category) → [DATA CODE] → a desired setting → **OK** →  → .

Shooting photos

In the default setting, photos are recorded on the following recording media.

HDR-CX300/CX350/CX350V/CX370: Internal memory

HDR-XR350/XR350V: Internal hard disk

Tips

- To change the recording media, see page 20.

1 Press MODE to turn on the (Photo) lamp.

The LCD screen display switches for photo recording mode, and the screen aspect ratio becomes 4:3.



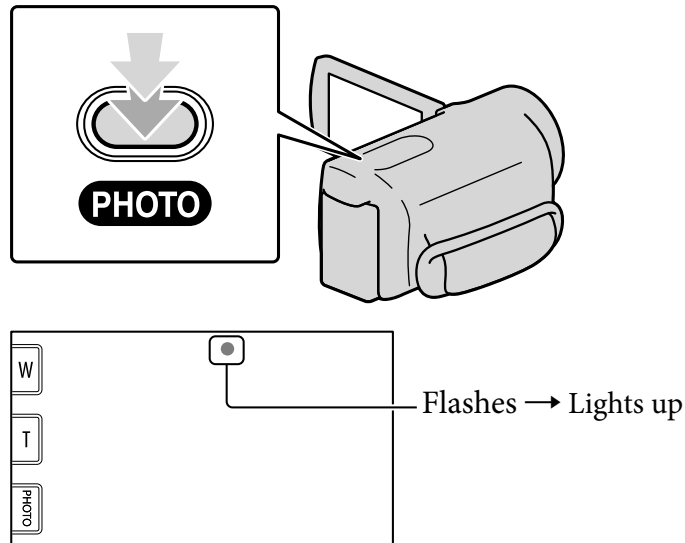

2 Press PHOTO lightly to adjust the focus, then press it fully.

- You can record photos also by touching  on the LCD screen.



When  disappears, the photo is recorded.

Tips

- You can check the recordable number of photos on the LCD (p. 73).
- To change the image size, touch **MENU** (MENU) → [Show others] → [ IMAGE SIZE] (under  [PHOTO SETTINGS] category) → a desired setting → **OK** → **X**.
- You cannot record photos while  is displayed.
- Your camcorder flashes automatically when there is insufficient ambient light. The flash does not work in the movie recording mode. You can change how your camcorder flashes by **MENU** (MENU) → [Show others] → [FLASH MODE] (under  [PHOTO SETTINGS] category) → a desired setting → **OK** → **X**.
- If you record photos using a flash with a conversion lens (sold separately), the shadow may be reflected.

If white circular spots appear on photos

This is caused by particles (dust, pollen, etc.) floating close to the lens. When they are accentuated by the camcorder's flash, they appear as white circular spots.

To reduce the white circular spots, light the room and shoot the subject without a flash.

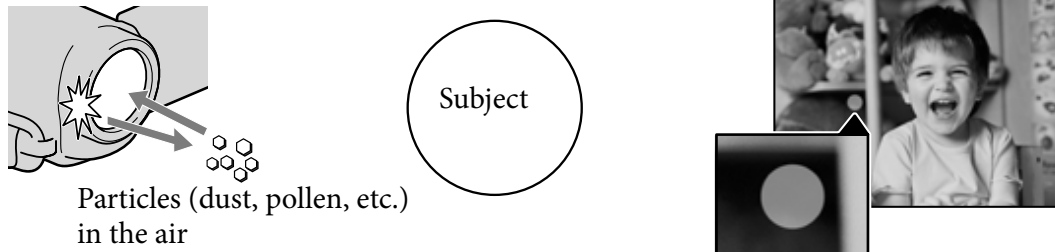

Acquiring location information using the GPS (HDR-CX350V/XR350V)

When you set the GPS switch (p. 75) to ON,  appears on the LCD screen, and your camcorder acquires the location information from the GPS satellites. Acquiring the location information enables you to use functions such as the Map Index.

The indicator changes according to the strength of GPS signal reception.

- Make sure that the GPS switch is set to OFF during take off and landing of an airplane.
- Processing time can be shortened when you load the GPS assist data into the camcorder using the supplied software "PMB." Install "PMB" on your computer (P. 37) and connect the computer to the internet. Then connect the camcorder to the computer and the GPS assist data will be automatically updated.
- The GPS assist data may not function in the following cases:
 - When the GPS assist data are not updated for about 30 days or more
 - When the date and time of the camcorder are not correctly set
 - When the camcorder is moved for a long distance
- Built-in map is powered by companies as follows; Map of Japan by ZENRIN CO., LTD., other areas by NAVTEQ.

Playback on the camcorder

In the default setting, movies and photos that are recorded on the following recording media are played.

HDR-CX300/CX350/CX350V/CX370: Internal memory

HDR-XR350/XR350V: Internal hard disk

Tips

- To change the recording media, see page 20.

1 Open the LCD screen of your camcorder.

Your camcorder is turned on and the lens cover is opened.

- To turn on your camcorder when the LCD screen is already open, press POWER (p.18).

2 Press (VIEW IMAGES).

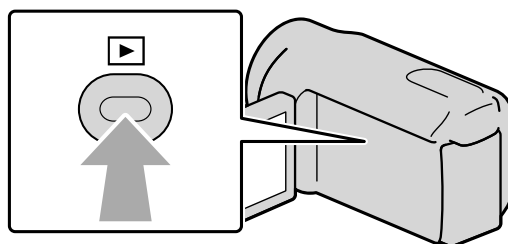

The VISUAL INDEX screen appears after some seconds.

- You can display the VISUAL INDEX screen also by touching  (VIEW IMAGES) on the LCD screen.

3 Touch or (①) → a desired movie (②) to playback a movie. Touch the (Photo) (①) → a desired photo (②) to view a photo.

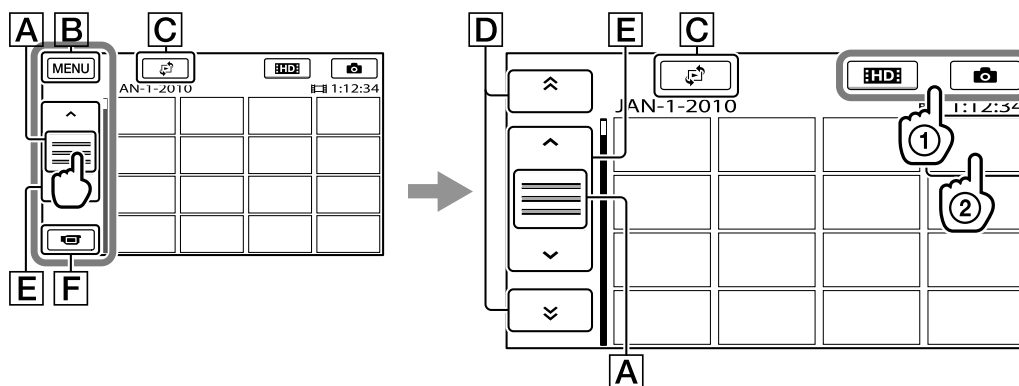

Movies are displayed and sorted by recording date.



A Switches operating button display.

B To MENU screen

C Displays the screen to select the index type ([DATE INDEX]/[MAP]) (HDR-CX350V/XR350V)/[FILM ROLL]/[FACE]).

D  /  : Displays movies recorded on the previous/next date.*

E / : Displays the previous/next movie.

F Returns to the recording screen.

* **D** is displayed when **A** is touched.

- **STD** appears when the standard definition image quality (STD) movie is selected with [**HDI** / **STD** SET].
- You can scroll the display by touching and dragging **D** or **E**.
- appears with the movie or photo that was most recently played or recorded. If you touch the movie or photo with , you can continue playback from the previous time. (appears on the photo recorded on the memory card.)

Playing movies

Your camcorder starts playing the selected movie.

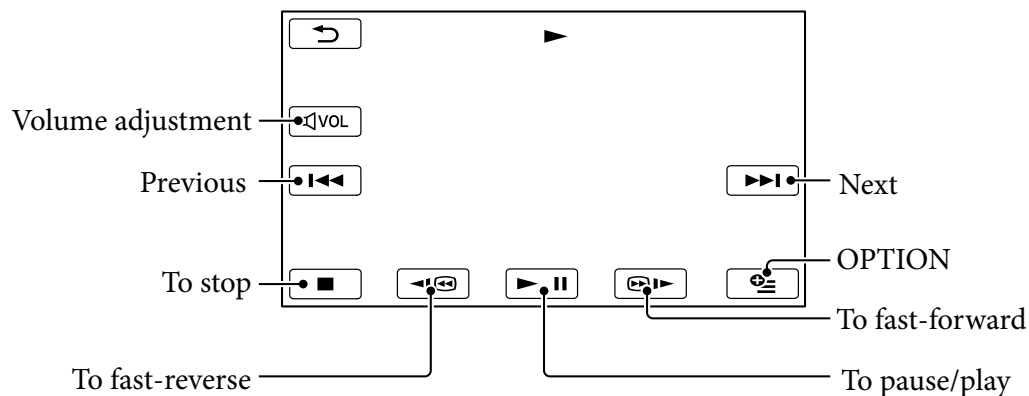

Notes

- You may not be able to play back the images with other devices than camcorder.

Tips

- When playback from the selected movie reaches the last movie, the screen returns to the INDEX screen.
- Touch / during pause to play back movies slowly.
- As you repeat touching / during playback, movies are played as fast as about 5 times → about 10 times → about 30 times → about 60 times.
- You can also display the VISUAL INDEX by touching **MENU** (MENU) → [Show others] → [VISUAL INDEX] (under [PLAYBACK] category).
- The recording date, time, and shooting conditions, and coordinates (HDR-CX350V/XR350V) are recorded automatically during recording. This information is not displayed during recording, but you can display it during playback by touching **MENU** (MENU) → [Show others] → [PLAYBACK SET] (under [PLAYBACK] category) → [DATA CODE] → a desired setting → **OK** → → **X**.
- In the default setting, a protected demonstration movie is pre-recorded (HDR-CX350/CX350V/CX370/XR350/XR350V).

To adjust the sound volume of movies

While playing back movies, touch **[VOL]** → adjust with **[VOL-]** / **[VOL+]** → **[RETURN]**.

- You can also adjust the sound volume by using **[-]** / **[+]** in the OPTION MENU.

Viewing photos

Your camcorder displays the selected photo.

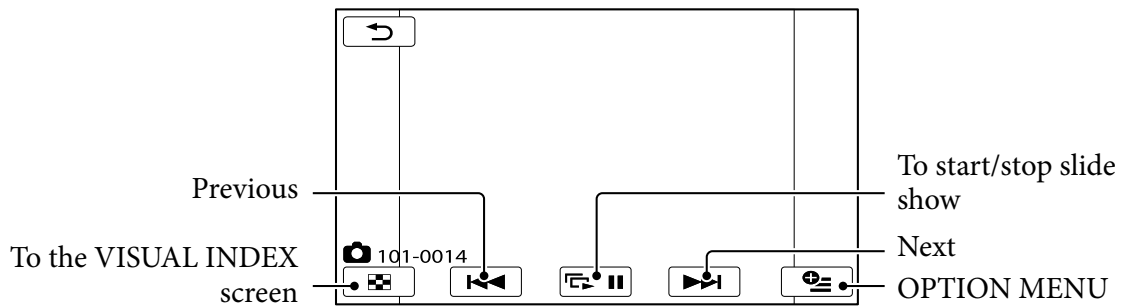

Tips

- When viewing photos recorded on the memory card, **101** ▶ (playback folder) appears on the screen.

Playing images on a TV

Connection methods and the image quality (high definition (HD) or standard definition (STD)) viewed on the TV screen differ depending on what type of TV is connected, and the connectors used.

Connecting a TV using [TV CONNECT Guide]

You can connect your camcorder to the TV easily following the instructions displayed on the LCD screen, [TV CONNECT Guide].

1 Switch the input on the TV to the connected jack.

- Refer to the instruction manuals of the TV.

2 Turn on your camcorder, and touch **MENU** (MENU) → [Show others] → [TV CONNECT Guide] (under **OTHERS** category) on the LCD screen.

- Use the supplied AC Adaptor as the power source (p. 17).

3 Touch [High Definition TV].

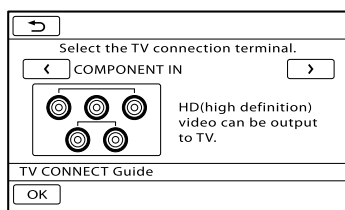

4 Touch **</>** to select the input jack of your TV, then touch **OK**.

- The connection method is displayed.
- If you touch [HINT], you can see tips for the connection or change the settings of your camcorder.

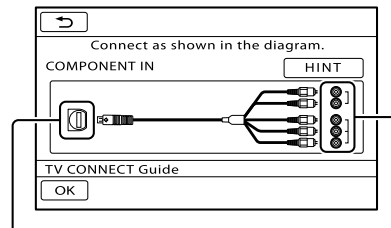

Connectors on your camcorder

Input connectors on the TV

5 Connect your camcorder to the TV.

HDMI OUT jack

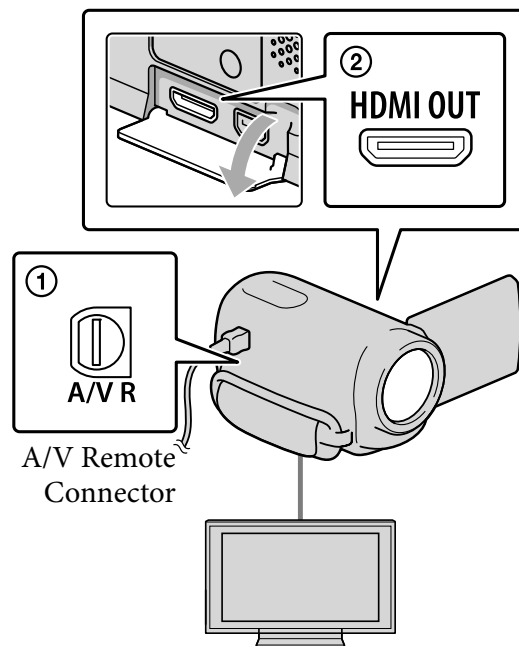

6 Touch **OK** → [YES].

- When the A/V connecting cable is used to output movies, movies are output with standard definition image quality (STD).

7 Play back movies and photos on your camcorder (p. 28).

Types of connection cables between your camcorder and TV

Connecting to a high definition TV

Component A/V Cable (supplied)

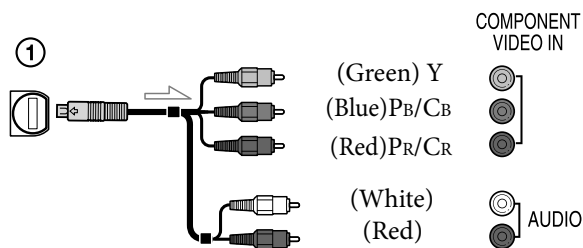

HDMI Cable (sold separately)

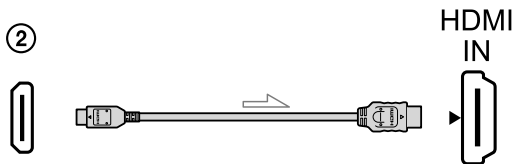

Connecting to a non-high-definition 16:9 (wide) or 4:3 TV

Component A/V Cable (supplied)

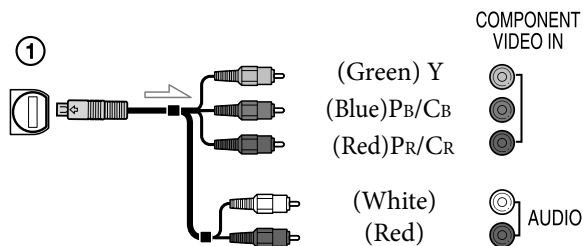

A/V connecting cable with S VIDEO (sold separately)

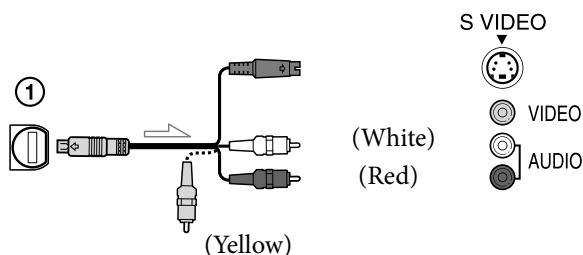

A/V connecting cable (supplied)

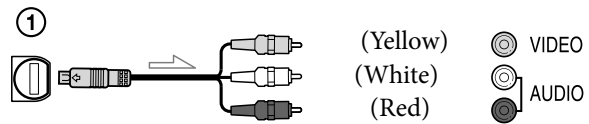

When connecting to your TV via a VCR

- Connect your camcorder to the LINE IN input on the VCR using the A/V connecting cable. Set the input selector on the VCR to LINE (VIDEO 1, VIDEO 2, etc.).

To set the aspect ratio according to the connected TV (16:9/4:3)

- Set [TV TYPE] to [16:9] or [4:3] according to your TV.

When your TV is monaural (When your TV has only one audio input jack)

- Connect the yellow plug of the A/V connecting cable to the video input jack and connect the white (left channel) or red (right channel) plug to the audio input jack of your TV or VCR.

When you connect with component A/V cable

- If you connect only component video plugs, audio signals are not output. Connect the white and red plugs to output audio signals.





When you connect with HDMI cable

- Use an HDMI cable with the HDMI logo.
- Use an HDMI mini connector on one end (for the camcorder), and a plug suitable for connecting your TV on the other end.
- Copyright-protected images are not output from the HDMI OUT jack of your camcorder.
- Some TVs may not function correctly (e.g., no sound or image) with this connection.
- Do not connect the camcorder HDMI OUT jack to an external device HDMI OUT jack, as malfunction may result.

When you connect with A/V connecting cable with S VIDEO

- When the S VIDEO plug (S VIDEO channel) is connected, audio signals are not output. To output audio signals, connect the white and red plugs to the audio input jack of your TV.
- This connection produces higher resolution images compared with the A/V connecting cable.

⚡ Notes

- When you play back standard definition image quality (STD) movies on a 4:3 TV that is not compatible with the 16:9 signal, record movies with 4:3 aspect ratio. Touch **MENU** (MENU) → [Show others] → [OTHER REC SET] (under  [SHOOTING SET] category) → [ WIDE SELECT] → [4:3] → **OK** →  →  (p. 59).

💡 Tips

- If you connect your camcorder to the TV using more than one type of cable to output images, the order of priority of the TV input jacks is as follows:
HDMI → component → S VIDEO → video
- HDMI (High Definition Multimedia Interface) is an interface to send both video/audio signals. The HDMI OUT jack outputs high quality images and digital audio.

On “Photo TV HD”

This camcorder is compatible with the “Photo TV HD” standard. “Photo TV HD” allows for highly-detailed, photo-like depiction of subtle textures and colors. By connecting Sony’s Photo TV HD-compatible devices using an HDMI cable* or the component A/V cable**, a whole new world of photos can be enjoyed in breathtaking full HD quality.

* The TV will automatically switch to the appropriate mode when displaying photos.

** Setup of the TV will be necessary. Please refer to the instructions of your Photo TV HD-compatible TV for details.

Deleting movies and photos

You can free media space by deleting movies and photos from recording media.

⚡ Notes

- You cannot restore images once they are deleted. Save important movies and photos in advance.
- Do not remove the battery pack or the AC Adaptor from your camcorder while deleting the images. It may damage the recording media.
- Do not eject memory card while deleting images from the memory card.
- You cannot delete protected movies and photos. Undo the protection of the movies and photos to delete them, before you try to delete them.
- The demonstration movie on your camcorder is protected (HDR-CX350/CX350V/CX370/XR350/XR350V).
- If the deleted movie is included in the Playlist, the movie added to the Playlist is deleted also from the Playlist.
- If the deleted movie is included in the saved Highlight Playback scenario, the movie is also deleted from the scenario.



💡 Tips



- You can delete an image on the playback screen from  OPTION MENU.
- To delete all images recorded in the recording media, and recover all the recordable space of the media, format the media.
- Reduced-size images which enable you to view many images at the same time on an index screen are called “thumbnails.”

1

Touch **MENU** (MENU) → [Show others] → [DELETE] (under  [EDIT] category).

2

To delete movies, touch [ DELETE] → [ DELETE] or [ DELETE].

- To delete photos, touch [ DELETE] → [ DELETE].

3

Touch and display the ✓ mark on the movies or photos to be deleted.

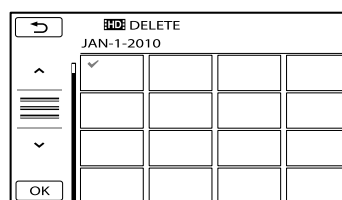





- Press and hold the image down on the LCD screen to confirm the image. Touch  to return to the previous screen.

4

Touch **OK** → [YES] → **OK** → **X**.

To delete all movies/photos at one time



In step 2, touch [ DELETE] → [ DELETE ALL]/[ DELETE ALL] → [YES] → [YES] → **OK** → **X**.

- To delete all photos at one time, touch [ DELETE] → [ DELETE ALL] → [YES] → [YES] → **OK** → **X**.

To delete all the movies/photos recorded on the same day at one time

⚡ Notes

- You cannot delete photos on memory card by recording date.

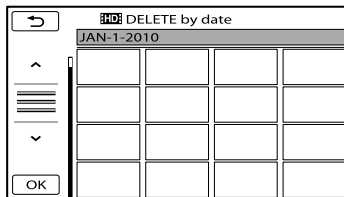

① In step 2, touch [ DEDELETE] → [ DELETE by date] / [ DELETE by date].

- To delete all photos on the same day at one time, touch [ DELETE] → [ DELETE by date].



② Touch  /  to select the recording date of the desired movies/photos, then touch .

- Touch the image on the LCD screen to confirm the image. Touch  to return to the previous screen.

③ Touch [YES] →  → .

Preparing a computer

(Windows)

You can perform following operations using “PMB (Picture Motion Browser).”

- Importing images to a computer
- Viewing and editing imported images
- Creating a disc
- Uploading movies and photos to websites

To save movies and photos using a computer, install “PMB” from the supplied CD-ROM beforehand.

Notes

- Do not format the media of your camcorder from a computer. Your camcorder may not operate correctly.
- This camcorder captures high definition footage in the AVCHD format. Using the enclosed PC software, high definition footage can be copied onto DVD media. However, DVD media containing AVCHD footage should not be used with DVD based players or recorders, as the DVD player/recorder may fail to eject the media and may erase its contents without warning.

Step 1 Checking the computer system

OS*1

Microsoft Windows XP SP3*2/Windows Vista SP2*3/Windows 7

CPU*4

Intel Core Duo 1.66 GHz or faster, or Intel Core 2 Duo 1.66 GHz or faster (Intel Core 2 Duo 2.26 GHz or faster is required when processing HD FX/HD FH movies)
However, Intel Pentium III 1 GHz or faster is sufficient for the following operations:

- Importing the movies and photos to the computer
- One Touch Disc Burn
- Creating an Blu-ray disc/AVCHD disc/DVD-video (Intel Core Duo 1.66 GHz or faster is required when creating a DVD video by converting high definition image quality (HD) to standard definition image quality (STD).)
- Copying a disc
- Processing only the movies with standard definition image quality (STD)

Application

DirectX 9.0c or later (This product is based on DirectX technology. It is necessary to have DirectX installed.)

Memory

For Windows XP: 512 MB or more (1 GB or more is recommended.)
However, 256 MB or more is sufficient for processing only the movies with standard definition image quality (STD).
For Windows Vista/Windows 7: 1 GB or more

Hard disk

Disk volume required for installation:
Approximately 500 MB (10 GB or more may be necessary when creating AVCHD discs. 50 GB maximum may be necessary when creating Blu-ray discs.)

Display

Minimum 1,024 × 768 dots

Others

USB port (this must be provided as standard, Hi-Speed USB (USB 2.0 compatible)), Blu-ray disc/DVD burner (CD-ROM drive is necessary for installation) Either NTFS or exFAT file system is recommended as the hard disk file system.

*¹ Standard installation is required. Operation is not assured if the OS has been upgraded or in a multi-boot environment.

*² 64-bit editions and Starter (Edition) are not supported. Windows Image Mastering API (IMAPI) Ver.2.0 or newer is required to use disc creation function, etc.

*³ Starter (Edition) is not supported.

*⁴ Faster processor is recommended.

⚡ Notes

- Operation with all computer environments is not assured.

When using a Macintosh

The supplied software “PMB” is not supported by Macintosh computers. To process photos using a Macintosh computer connected to your camcorder, see the following website.

<http://guide.d-imaging.sony.co.jp/mac/ms/us/>

Step 2 Installing the supplied software “PMB”

Install “PMB” before connecting your camcorder to a computer.

⚡ Notes

- If a version of “PMB” under 5.0.00 has been installed on your computer, you may be unable to use some functions of those “PMB” when installing the “PMB” from the supplied CD-ROM. Also, “PMB Launcher” is installed from the supplied CD-ROM and you can start “PMB” or other software by using the “PMB Launcher.” Double-click the “PMB Launcher” short-cut icon on the computer screen to start “PMB Launcher.”

1 Confirm that your camcorder is not connected to the computer.

2 Turn on the computer.

- Log on as an Administrator for installation.
- Close all applications running on the computer before installing the software.

3 Place the supplied CD-ROM in the disc drive of your computer.

The installation screen appears.

- If the screen does not appear, click [Start] → [Computer] (in Windows XP, [My Computer]), then double-click [SONYPMB (E:)] (CD-ROM)*.

* Drive names (such as (E:)) may vary depending on the computer.

4 Click [Install].



5 Select the country or region.

6 Select the language for the application to be installed, then proceed to the next screen.

7 Read the terms of the license agreement carefully. If you agree to the terms, change to , and then click [Next] → [Install].

-
- 8** Turn on your camcorder, then connect the camcorder to the computer using the supplied USB cable.

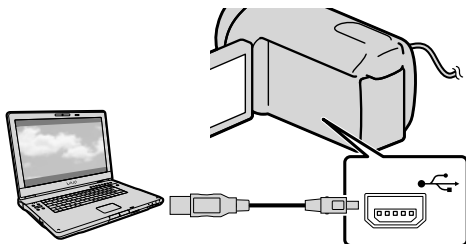

The [USB SELECT] screen appears on the camcorder screen automatically.

-
- 9** Touch the one of the media types displayed on the camcorder screen to make the computer recognize your camcorder.

HDR-CX300/CX350/CX350V/CX370
: [ USB CONNECT] (internal memory)

HDR-XR350/XR350V: [ USB CONNECT] (internal hard disk)

- The displayed recording media differ depending on the model.
- If the [USB SELECT] screen does not appear, touch **MENU** (MENU) → [Show others] → [USB CONNECT] (under  [OTHERS] category).

-
- 10** Click [Continue] on the computer screen.



-
- 11** Follow the on-screen instructions to install the software.

- Connect the camcorder to the computer during the installation of “PMB.”
- Depending on the computer, you may need to install third party software. If the installation screen appears, follow the instructions to install the required software.
- Restart the computer if required to complete the installation.

When the installation is completed, following icons will appear.

Remove the CD-ROM from your computer.



-  : Starts “PMB.”
-  : Displays “PMB Help.”
-  : Displays “PMB Launcher.”

“PMB Launcher” enables you to start “PMB” or other software, or to open web sites.

- Other icons may appear.
 - No icon may appear depending on the installation procedure.
-

Starting PMB (Picture Motion Browser)

⚡ Notes

- To create discs or use other functions on Windows XP, Image Mastering API v2.0 for Windows XP should be installed. If Image Mastering API v2.0 for Windows XP has not been installed yet, select it from required programs on the installation screen and install it following the procedures displayed. (The computer must be connected to the internet for the installation.) You may install Image Mastering API v2.0 for Windows XP in response to the message displayed when you try to start those functions.

To disconnect your camcorder from the computer

- ① Click the  icon at the bottom right of the desktop of the computer → [Safely remove USB Mass Storage Device].



- ② Touch [END] → [YES] on the camcorder screen.
- ③ Disconnect the USB cable.

⚡ Notes

- Access from the computer using the supplied software “PMB.” Do not modify the files or folders on the camcorder from the computer. The image files may be destroyed or may not be played back.
- Operation is not guaranteed, if you perform the above operation.
- When you delete image files, follow the steps on page 34. Do not delete the image files on the camcorder directly from the computer.
- Do not copy the files on the recording media from the computer. Operation is not guaranteed.
- You can create a Blu-ray disc by using a computer with a Blu-ray disc burner. Install the BD Add-on Software for “PMB”(p. 45).

Double-click the “PMB” short-cut icon on the computer screen.



⚡ Notes

- If the icon is not displayed on the computer screen, click [Start] → [All Programs] → [PMB] to start “PMB.”

You can view, edit, or create discs of movies and photos using “PMB.”

Reading “PMB Help”

For details on how to use “PMB,” read the “PMB Help.” Double-click the “PMB Help” short-cut icon on the computer screen to open the “PMB Help.”

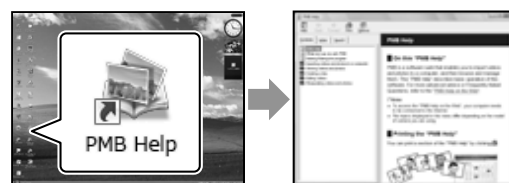





⚡ Notes

- If the icon is not displayed on the computer screen, click [Start] → [All Programs] → [PMB] → [PMB Help]. You can also open the “PMB Help” from [Help] of “PMB.”

Selecting the method for creating a disc (computer)

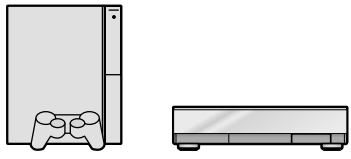
Several methods for creating a high definition image quality (HD) disc or a standard definition image quality (STD) disc from high definition image quality (HD) movies or photos recorded on your camcorder are described here. Select the method that suits your disc player.

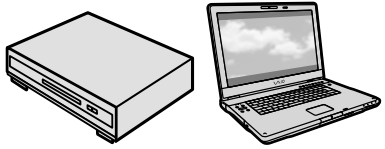
Player	Choosing a method and disc type	
Blu-ray disc playback devices (a Blu-ray disc player, PlayStation [®] 3, etc.)	① Importing movies and photos to a computer (p. 43) ↓ ② Creating a Blu-ray disc* with high definition image quality (HD) (p. 45)	
AVCHD format playback devices (a Sony Blu-ray disc player, PlayStation [®] 3, etc.)	Creating a disc with one touch (One Touch Disc Burn) (p. 42)	
	① Importing movies and photos to a computer (p. 43) ↓ ② Creating a AVCHD format disc with high definition image quality (HD) (p. 44)	
Ordinary DVD playback devices (a DVD player, a computer that can play DVDs, etc.)	① Importing movies and photos to a computer (p. 43) ↓ ② Creating a standard definition image quality (STD) disc (p. 45)	
		

* To create a Blu-ray disc, the BD Add-on Software for “PMB” must be installed (p. 45).

Characteristics of each type of disc

 Using a Blu-ray disc enables you to record high definition image quality (HD) movies of a longer duration than DVD discs.

 High definition image quality (HD) movie can be recorded on DVD media, such as DVD-R discs, and a high definition image quality (HD) disc is created.
 You can play a high definition image quality (HD) disc on AVCHD format playback devices, such as a Sony Blu-ray disc player and a PlayStation[®]3. You cannot play the disc on ordinary DVD players.

 Standard definition image quality (STD) movie converted from high definition image quality (HD) movie can be recorded on DVD media, such as DVD-R discs, and a standard image quality (STD) disc is created.

Discs you can use with “PMB”

You can use 12 cm discs of following type with “PMB.” For Blu-ray disc, see page 45.

Disc type	Features
DVD-R/DVD+R/DVD+R DL	Unrewritable
DVD-RW/DVD+RW	Rewritable

Notes

- Always maintain your PlayStation®3 to use the latest version of the PlayStation®3 system software.
- The PlayStation®3 may not be available in some countries/regions.

Creating a disc with one touch

(One Touch Disc Burn)

Movies and photos recorded on your camcorder that have not yet been saved with One Touch Disc Burn function can be saved on a disc automatically. Movies and photos are saved on a disc with their recorded image quality.

⚡ Notes

- High definition image quality (HD) movies (the default setting) will make an AVCHD disc.
- You cannot create AVCHD discs from movies recorded with [HD FX] mode of [REC MODE].
- Creating a Blu-ray disc is not available with One Touch Disc Burn.
- To create a standard definition image quality (STD) disc from high definition image quality (HD) movies, import movies to a computer first (p. 43), and then create a standard definition image quality (STD) disc (p. 45).
- Install “PMB” beforehand (p. 37), however, do not start “PMB.”
- Connect your camcorder to the wall outlet (wall socket) using the AC Adaptor supplied for this operation (p. 17).
- With One Touch Disc Burn function on your camcorder, you can save movies and photos recorded on the internal recording media only.

1 Turn on your computer, and place an unused disc on the DVD drive.

- See page 41 for the type of discs you can use.
- If any other software than “PMB” starts automatically, shut it down.

2 Turn on your camcorder, then connect the camcorder to the computer using the supplied USB cable.

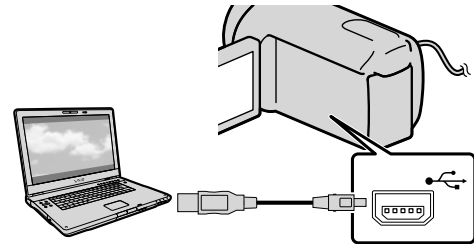

3 Press  (DISC BURN).

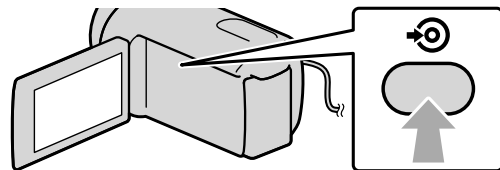

4 Follow the instructions on the computer screen.

⚡ Notes

- Movies and photos are not saved on the computer when you perform One Touch Disc Burn.

Importing movies and photos to a computer

Movies and photos recorded on your camcorder can be imported to a computer. Turn on the computer beforehand.

⚡ Notes

- Connect your camcorder to the wall outlet (wall socket) using the supplied AC Adaptor for this operation (p. 17).

- 1 Turn on your camcorder, then connect the camcorder to the computer using the supplied USB cable.

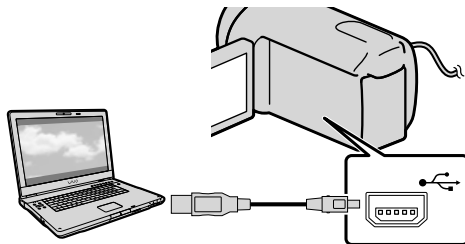

The [USB SELECT] screen appears on the camcorder screen.

- 2 Touch the recording media that contains the images you want to save on the camcorder screen.

[USB CONNECT]: Internal memory

[USB CONNECT]: Internal hard disk

[USB CONNECT]: Memory card

- The displayed recording media differ depending on the model.
- If the [USB SELECT] screen does not appear, touch **MENU** (MENU) → [Show others] → [USB CONNECT] (under [OTHERS] category).

The window for import appears on the computer screen.

- 3 Click [Import].

- Refer to “PMB Help” (p. 39) for details.

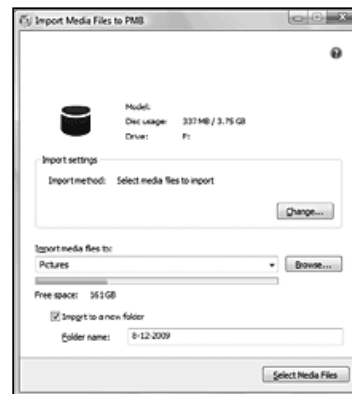

Movies and photos are imported to your computer. When the operation is completed, the “PMB” screen appears.

💡 Tips

- You can export high definition image quality (HD) movies from your computer to your camcorder. See “PMB Help” (p. 39) for details.

Creating an AVCHD disc

You can create an AVCHD disc by putting together high definition image quality (HD) movies previously imported to your computer (p. 43).

In this section, the procedure for recording a high definition image quality (HD) movie on a DVD disc is explained.

1 Turn on your computer, and place an unused disc on the DVD drive.

- See page 40 for the type of discs you can use.
- If any other software than “PMB” starts automatically, shut it down.

2 Start “PMB” (p. 39).

3 Click [Calendar] or [Index] on the left side in the window, and select the date or folder, then select the high definition image quality (HD) movies.

- High definition image quality (HD) movies are marked with **HD**.
- You cannot save photos on a disc.
- To select plural movies, hold the Ctrl key down and click thumbnails.

4 At the top of the window, click  → [Create AVCHD Format Discs (HD)].



The window used to select movies appears.

- To add movies to the previously selected ones, select the movies in the main window and drag and drop onto the window for selecting movies.

5 Follow the instructions on the screen to create a disc.

- It may take a long time to create a disc.

Playing an AVCHD disc on a computer

You can play back AVCHD discs using “Player for AVCHD” that is installed together with “PMB.”

To start “Player for AVCHD” Click [Start] → [All Programs] → [PMB] → [PMB Launcher] → [View] → [Player for AVCHD].

See the “Player for AVCHD” help on the operation.

- Movies may not be played smoothly depending on the computer environment.

Creating a standard definition image quality (STD) disc that can be played on ordinary DVD players

You can create a standard definition image quality (STD) disc by selecting movies previously imported to your computer (p. 43).

⚡ Notes

- You may select high definition image quality (HD) movies as sources. However, image quality is converted from high definition (HD) to standard definition (STD). It will take a longer time for converting the image quality of the movies than it took to actually record the movies.

1 Turn on your computer, and place an unused disc on the DVD drive.

- See page 40 for the type of discs you can use.
- If any other software than “PMB” starts automatically, shut it down.

2 Start “PMB” (p. 39).

3 Click [Calendar] or [Index] on the left side in the window, and select the date or folder, then select the movies.

- High definition image quality (HD) movies are marked with **HD**.
- To select plural movies, hold the Ctrl key down and click thumbnails.

Creating a Blu-ray disc

You can create a Blu-ray disc with a high definition image quality (HD) movie previously imported to a computer (p. 43).

To create a Blu-ray disc, the BD Add-on Software for “PMB” must be installed. Click [BD Add-on Software] on the installation screen of “PMB,” and install this plug-in according to the on-screen instructions.

- Connect your computer to the internet when you install [BD Add-on Software].



Place an unused Blu-ray disc in the disc drive, and click  → [Create Blu-ray Disc (HD)] in step 4 of “Creating an AVCHD disc” (p. 44). Other procedures are the same as that for creating an AVCHD disc.

- Your computer must support the creation of Blu-ray discs.
- BD-R (unrewritable) and BD-RE (rewritable) media are available for creating Blu-ray discs. You cannot add contents to either type of disc after creating the disc.

4 At the top of the window, click  → [Create DVD-Video Format Discs (STD)].

The window used to select movies appears.

- To add movies to the previously selected ones, select the movies in the main window and drag and drop onto the window for selecting movies.



5 Follow the instructions on the screen to create a disc.

- It may take a long time to create a disc.

Copying a disc

You can copy a recorded disc to another disc using “Video Disc Copier.”

Click [Start] → [All Programs] → [PMB] → [PMB Launcher] → [Disc Creation] → [Video Disc Copier] to start the software. See “Video Disc Copier” help on the operation.

- You cannot copy high definition image quality (HD) movies by converting them to standard definition image quality (STD).
- You cannot copy to a Blu-ray disc.

Editing movies

You can cut out only necessary parts from a movie and save it as another file. Double-click the movie to be edited on “PMB,” then click [Show Edit Palette] on the right side of the screen → [Trim Video], or select the [Manipulate] menu → [Edit] → [Trim Video]. See “PMB Help” (p. 39) for details.

Capturing photos from a movie

You can save a frame of a movie as a photo file.

Double-click the movie to be edited on “PMB,” then click [Show Edit Palette] on the right side of the screen → [Save Frame]. See “PMB Help” (p. 39) for details.



Saving images in external media

(DIRECT COPY)

You can save movies and photos on external media (USB storage device), such as an external hard disk drive. You can also play back images on the camcorder or another playback device.

⚡ Notes

- For this operation, you need the USB Adaptor Cable VMC-UAM1 (sold separately).
- The USB Adaptor Cable VMC-UAM1 may not be available in some countries/regions.
- You cannot use the following devices as an external media.
 - media with a capacity exceeding 2 TB
 - ordinary disc drive such as CD or DVD drive
 - media connected via USB hub
 - media with built-in USB hub
 - card reader
- You may not be able to use external media with a code function.
- FAT file system is available for your camcorder. If the external media was formatted to NTFS file system, etc., format the external media on your camcorder before use. The format screen appears when the external media is connected to your camcorder.
- Operation is not assured with every device satisfying requirements for operating.
- Connect your camcorder to the wall outlet (wall socket) using the supplied AC adaptor (p. 17).
- Refer to the instruction manual supplied with the external media.
- For details on available external media, go to the Sony support website in your country/region.

1 Connect the AC Adaptor and the power cord (mains lead) to the DC IN jack of your camcorder and the wall outlet (wall socket).

2 If the external media has the AC power cable, connect it to the wall outlet (wall socket).

3 Connect the USB Adaptor Cable to the external media.

4 Connect the USB Adaptor Cable to the Ψ (USB) jack of your camcorder.

When the [Create a new Image Database File.] screen appears, touch [YES].

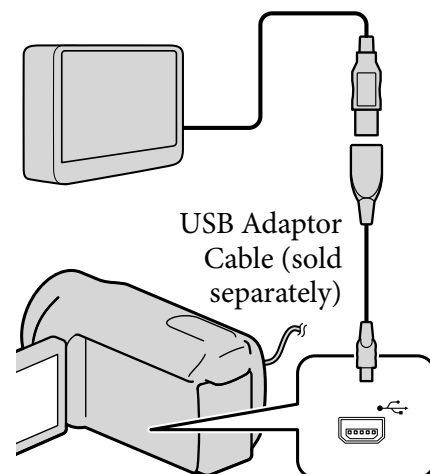

5 Touch [Copy.] on the camcorder screen.

Movies and photos in the internal recording media of the camcorder that have not yet been saved on to external media can be saved.

- This screen will appear only when there are newly recorded images.

6 After the operation is completed, touch **OK** on the camcorder screen.

Notes

- The number of scenes you can save on the external media are as follows. However, even if the external media has free space, you cannot save scenes exceeding the following number.
High definition image quality (HD) movies: Max. 3,999
Standard definition image quality (STD) movies: 9,999
Photos: 9,999 frames × 899 folders
The number of scenes may be smaller depending on the type of images recorded.

When connecting an external media

The images saved in the external media are displayed on the LCD screen. The movie display and photo display buttons on the VISUAL INDEX screen change as illustrated below.

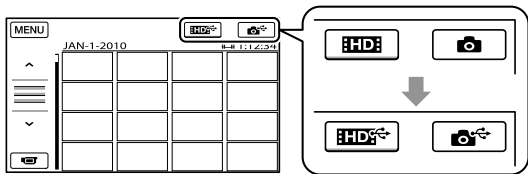

You can make menu settings of the external media such as deleting images. Touch **MENU** (MENU) → [Show others] on the VISUAL INDEX screen.

To save desired movies and photos

Notes

- You cannot copy or search photos by date which are recorded on the memory card.

① Touch [Play without copying.] in step 5 above.

The VISUAL INDEX screen of the external media is displayed.

② Touch **MENU** (MENU) → [Show others] → [MOVIE DUB] (when selecting movies)/[PHOTO COPY] (when selecting photos).

③ Follow the on-screen instructions to select the recording media and image selection methods.

④ When you selected [DUB by select], touch the image to be saved.

✓ appears.

- When you selected [DUB by date], select the date of the images to be dubbed with **^** / **v**, then touch **OK** and go to step ⑤.

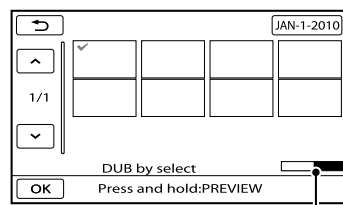

Remaining external media capacity

- Press and hold the image down on the LCD screen to confirm the image. Touch **↶** to return to the previous screen.
- By touching date, you can search for images by date.

⑤ Touch **OK** → [YES] → **OK** on the camcorder screen.

Creating a disc with a DVD writer, recorder

To play back images in the external media on the camcorder

- ① Touch [Play without copying.] in step 5 above.

The VISUAL INDEX screen of the external media is displayed.

- ② Play back the image (p. 28).
 - You can also view images on a TV connected to your camcorder (p. 31).
 - You can play back the high definition image quality (HD) movies on your computer using [Player for AVCHD]. Start [Player for AVCHD] (p. 44), and select the drive where the external media is connected with [Settings].

⚡ Notes

- The Date Index and Map Index (HDR-CX350V/XR350V) of photos cannot be displayed.
- If your camcorder does not recognize the external media, try the following operations.
 - Reconnect the USB Adaptor Cable to your camcorder
 - If the external media has the AC power cable, connect it to the wall outlet (wall socket)

To finish the external media connection

- ① Touch  on the VISUAL INDEX screen of the external media.
- ② Disconnect the USB Adaptor Cable.

Selecting the method for creating a disc

Several methods for creating an AVCHD disc or a standard definition image quality (STD) disc from high definition image quality (HD) movies or photos recorded on your camcorder are described here. Select the method that suits your disc player.

⚡ Notes

- Prepare a DVD disc such as a DVD-R, for creating a disc.
- See page 45 to create a Blu-ray disc.
- See page 47 to save images in the external media.

AVCHD format compatible device

Player

- Sony Blu-ray disc player
- PlayStation®3, etc.

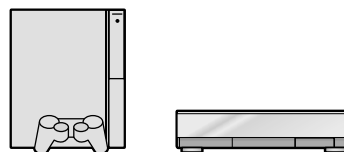

Creating device

- DVD writer, DVDirect Express (p. 50)
- DVD writer, etc., other than DVDirect Express (p. 53)

Disc type

- AVCHD disc (high definition image quality (HD))



Ordinary DVD device

Player

- DVD player
- Computer that can play DVDs, etc.

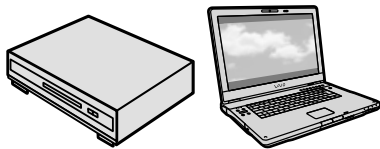

Creating device

- DVD writer, DVDirect Express (p. 50)
- DVD writer, other than DVDirect Express (p. 53)
- Disc recorder, etc. (p. 54)

Disc type

- Standard definition image quality (STD) disc



⚡ Notes

- Always maintain your PlayStation®3 to use the latest version of the PlayStation®3 system software.
- The PlayStation®3 may not be available in some countries/regions.
- Delete the demonstration movie when dubbing or creating discs. If it is not deleted, the camcorder may not operate correctly. However, you cannot recover the demonstration movie once you delete it.
- The AVCHD disc can be played back only on AVCHD format compatible devices.
- The AVCHD disc should not be used in DVD players/recorders. Because DVD players/recorders are not compatible with the AVCHD format, DVD players/recorders may fail to eject the disc.
- You cannot create an AVCHD disc from a movie recorded with [HD FX] mode of [RECORD MODE]. Save a movie recorded with [HD FX] mode onto Blu-ray discs or external storage devices (p. 47).

Creating a disc with the dedicated DVD writer, DVDirect Express

You can create a disc or play back the images on a created disc by using the dedicated DVD writer, DVDirect Express (sold separately).

Refer also to the instruction manual supplied with the DVD writer.

⚡ Notes

- Connect your camcorder to the wall outlet (wall socket) using the supplied AC Adaptor for this operation (p. 17).
- Only unused discs of the following types can be used:
 - 12cm DVD-R
 - 12cm DVD+R
- The device does not support two-layered discs.
- DVDirect Express is referred to as “DVD writer” in this section.

1 Connect the AC Adaptor and the power cord (mains lead) to the DC IN jack of your camcorder and the wall outlet (wall socket) (p. 17).

2 Turn on your camcorder, and connect the DVD writer to the ⚡ (USB) jack of your camcorder with the USB cable of the DVD writer.

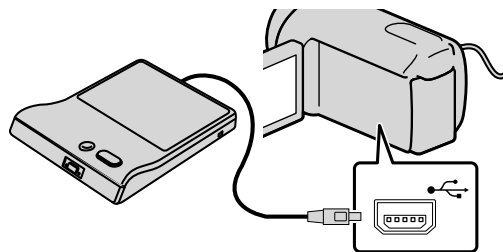

-
- 3** Insert an unused disc into the DVD writer, and close the disc tray.

The [DISC BURN] screen appears on the camcorder screen.

- 4** Press **DISC BURN** on the DVD writer.

Movies recorded on the internal recording media that have not been saved on any discs will be recorded onto the disc.

- When there are unsaved high definition (HD) and standard definition (STD) image quality movies, they will be saved on individual discs according to the image quality.
-

- 5** Repeat steps 3 and 4 when the total memory size of movies to be burnt exceeds that of the disc.
-

- 6** Touch **OK** → [END] → [EJECT DISC] on the camcorder screen.

Remove the disc after the operation is completed.

- 7** Touch **OK**, then disconnect the USB cable.
-

To customize a disc with DISC BURN OPTION

Perform this operation in the following cases:

- When dubbing a desired image
- When creating multiple copies of the same disc
- When converting high definition (HD) movies to standard definition (STD) movies, and creating a disc
- When dubbing images in the memory card

- ① Touch [DISC BURN OPTION] in step 4.

- ② Select the recording media containing the movie(s) you want to save.

When you select movies with high definition image quality (HD), the screen to select the image quality of the disc to be created appears on the LCD screen. Select the desired image quality, and touch **OK**.

- The image quality of the disc depends on the recording time of the selected movies when you create a disc converting them from high definition image quality (HD) to standard definition image quality (STD).

- ③ Touch the movie you want to burn on the disc.

✓ appears.

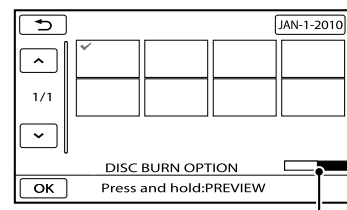

Remaining Disc capacity

- Press and hold the image down on the LCD screen to confirm the image. Touch **DISC BURN** to return to the previous screen.
- By touching date, you can search for images by date.

- ④ Touch **OK** → [YES] on the camcorder screen.
 - To create another disc of the same contents, insert a new disc and touch [CREATE SAME DISC].
- ⑤ After the operation is completed, touch [EXIT] → [END] on the camcorder screen.
- ⑥ Disconnect the USB cable from your camcorder.

⚡ Notes

- Do not do any of the following when creating a disc.
 - Turn off the camcorder
 - Disconnect the USB cable or the AC adaptor
 - Subject the camcorder to mechanical shock or vibration
 - Eject the memory card from the camcorder
- Play the created disc to make sure dubbing was performed correctly before deleting the movies on your camcorder.
- If [Failed.] or [DISC BURN failed.] appears on the screen, insert another disc into the DVD writer and perform the DISC BURN operation again.

💡 Tips

- If the total memory size of movies to be burnt by the DISC BURN operation exceeds that of the disc, disc creation stops when the limit is reached. The last movie on the disc may be cut off.
- Disc creation time to dub movies to the limit of the disc is about 20 to 60 minutes. It may take more time depending on the recording mode or the number of scenes. Also, if high definition image quality (HD) is converted to standard definition image quality (STD), image quality conversion takes longer than the actual recording.

To play back a disc on the DVD writer

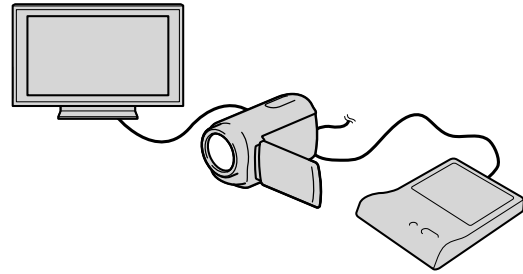

- ① Connect the AC Adaptor and the power cord (mains lead) to the DC IN jack of your camcorder and the wall outlet (wall socket) (p. 17).
- ② Turn on your camcorder, and connect the DVD writer to the Ψ (USB) jack of your camcorder with the USB cable of the DVD writer.
 - You can play back movies on the TV screen by connecting the camcorder to a TV (p. 31).
- ③ Insert a created disc into the DVD writer.

The movies on the disc appear as VISUAL INDEX on the camcorder screen.
- ④ Press the play button on the DVD writer.
 - You can also operate by the camcorder screen.
- ⑤ Touch [END] → [EJECT DISC] on the camcorder screen and remove the disc after the operation is completed.
- ⑥ Touch **OK** and disconnect the USB cable.

To play back a disc on the ordinary DVD player

Select the standard image quality (STD) on the screen to select the image quality of the disc to be created in step 2 of “To customize a disc with DISC BURN OPTION.”

Tips

- If you cannot play back created standard definition (STD) image quality discs on any DVD player, connect the camcorder to the DVD writer, and then play back.

Creating a high definition image quality (HD) disc with a DVD writer, etc., other than DVDirect Express

Use USB cable to connect your camcorder to a disc creation device, which is compatible with high definition image quality (HD) movies, such as a Sony DVD writer. Refer also to the instruction manuals supplied with the device to be connected.

Notes

- Connect your camcorder to the wall outlet (wall socket) using the supplied AC Adaptor for this operation (p. 17).
- Sony DVD writer may not be available in some countries/regions.
- Always maintain the firmware of the Sony DVDirect (DVD writer) to its latest version. For details, see the following website.
<http://sony.storagesupport.com/>

- 1** Connect the AC Adaptor and the power cord (mains lead) to the DC IN jack of your camcorder and the wall outlet (wall socket) (p. 17).

- 2** Turn on your camcorder, and connect a DVD writer, etc. to the  (USB) jack of your camcorder with the USB cable (supplied).

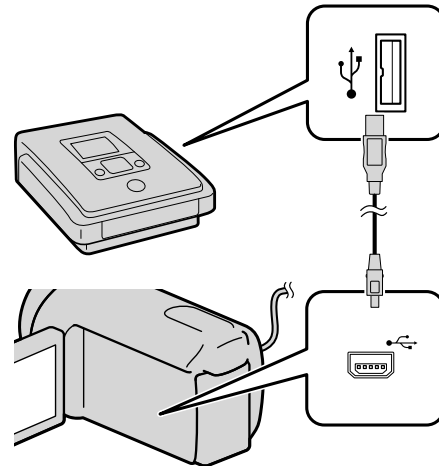

The [USB SELECT] screen appears on the camcorder screen.

- If the [USB SELECT] screen does not appear, touch **MENU** (MENU) → [Show others] → [USB CONNECT] (under  [OTHERS] category).

- 3** Touch the recording media that contains the images on the camcorder screen.

 [USB CONNECT]: Internal memory

 [USB CONNECT]: Internal hard disk

 [USB CONNECT]: Memory card

- The displayed recording media differ depending on the model.

- 4** Record movies on the connected device.

- For details, refer to the instruction manuals supplied with the device to be connected.

5 After the operation is completed, touch [END] → [YES] on the camcorder screen.

6 Disconnect the USB cable.

Creating a standard definition image quality (STD) disc with a recorder, etc.

You can dub images played back on your camcorder on a disc or video cassette, by connecting your camcorder to a disc recorder, a Sony DVD writer, etc., other than DVDirect Express, with the A/V connecting cable. Connect the device in either way of **1** or **2**. Refer also to the instruction manuals supplied with the devices to be connected.

⚡ Notes

- Connect your camcorder to the wall outlet (wall socket) using the supplied AC Adaptor for this operation (p. 17).
- Sony DVD writer may not be available in some countries/regions.
- High definition image quality (HD) movies will be dubbed with standard definition image quality (STD).

1 A/V connecting cable (supplied)
Connect the A/V connecting cable to the input jack of another device.

2 A/V connecting cable with S VIDEO (sold separately)
When connecting to another device via the S VIDEO jack, by using an A/V connecting cable with an S VIDEO cable (sold separately), higher quality images can be produced than with an A/V connecting

cable. Connect the white and red plug (left/right audio) and the S VIDEO plug (S VIDEO channel) of the A/V connecting cable with an S VIDEO cable. If you connect the S VIDEO plug only, you will hear no sound. The yellow plug (video) connection is not necessary.

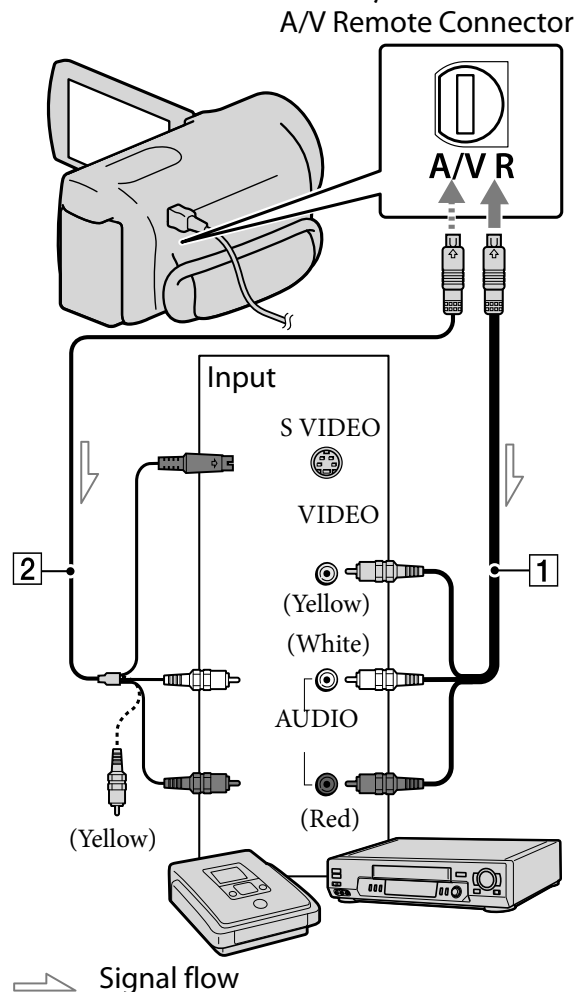

1 Insert the recording media in the recording device.

- If your recording device has an input selector, set it to the input mode.

2 Connect your camcorder to the recording device (a disc recorder, etc.) with the A/V connecting cable **1** (supplied) or an A/V connecting cable with S VIDEO **2** (sold separately).





- Connect your camcorder to the input jacks of the recording device.

3 Start playback on your camcorder, and record it on the recording device.



- Refer to the instruction manuals supplied with your recording device for details.

4 When dubbing is finished, stop the recording device, and then your camcorder.

Notes

- Since dubbing is performed via analog data transfer, the image quality may deteriorate.
- You cannot dub images to recorders connected with an HDMI cable.
- To hide the screen indicators (such as a counter, etc.) on the screen of the monitor device connected, touch **MENU** (MENU) → [Show others] → [OUTPUT SETTINGS] (under  [GENERAL SET] category) → [DISP OUTPUT] → [LCD PANEL] (the default setting) → **OK** →  → **X**.
- To record the date/time, coordinates (HDR-CX350V/XR350V), or camera settings data, touch **MENU** (MENU) → [Show others] → [PLAYBACK SET] (under  [PLAYBACK] category) → [DATA CODE] → a desired setting → **OK** →  → **X**. In addition, touch **MENU** (MENU) → [Show others] → [OUTPUT SETTINGS] (under  [GENERAL SET] category) → [DISP

OUTPUT] → [V-OUT/PANEL] → **OK** →  → **X**.

- When the screen size of display devices (TV, etc.) is 4:3, touch **MENU** (MENU) → [Show others] → [OUTPUT SETTINGS] (under  [GENERAL SET] category) → [TV TYPE] → [4:3] → **OK** →  → **X**.
- When you connect a monaural device, connect the yellow plug of the A/V connecting cable to the video input jack, and the white (left channel) or the red (right channel) plug to the audio input jack on the device.

Using menus

Using the menus, you can perform useful functions and change various settings. If you make good use of menu operations, you can enjoy using your camcorder.

The camcorder has various menu items under each of eight menu categories.

 **MANUAL SETTINGS** (Items to adjust for scene condition) → p. 59

 **SHOOTING SET** (Items for customized shooting) → p. 59

 **PHOTO SETTINGS** (Items for recording photos) → p. 60

 **PLAYBACK** (Items for playback) → p. 60

 **EDIT** (Items for editing) → p. 60

 **OTHERS** (Items for other settings) → p. 61



 **MANAGE MEDIA** (Items for recording media) → p. 61

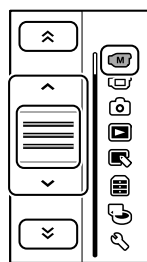
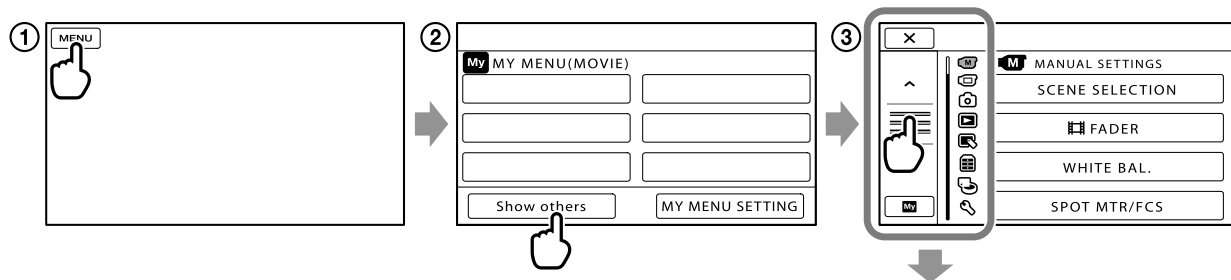

 **GENERAL SET** (Other setup items) → p. 62

- Menu items are described in more details in the “Handycam” Handbook.

Setting menus



 /  : The menu list moves from category to category.

 /  : The menu list moves through 4 items at once.

- You can touch buttons and drag the screen to scroll the list of the menu.
- The selected category icon is displayed in orange.
- When you touch , the screen returns to the MY MENU screen.

1 Touch **MENU** (MENU).

2 Touch [Show others] on the MY MENU screen.

- See the next page for details on MY MENU.

3 Touch the central part in the left side of screen to change the display.

4 Touch the menu item to be changed.

5 After changing the setting, touch **OK**.

To finish setting the menu, touch **X**.

To return to the previous menu screen, touch .

- **OK** may not be displayed depending on the menu item.

⚡ Notes

- You may not be able to set some menu items, depending on the recording or playback conditions.
- Grayed out menu items or settings are not available.

💡 Tips

- Depending on the menu items being changed, your camcorder switches between playback mode and recording mode (movie/photo).

Using MY MENU

You can use the menu items more easily by registering the menu items you use most often on MY MENU. You can register 6 menu items on each MY MENU of the MOVIE, PHOTO, and PLAYBACK.

Example: deleting [SPOT MTR/FCS] and registering [FADER]

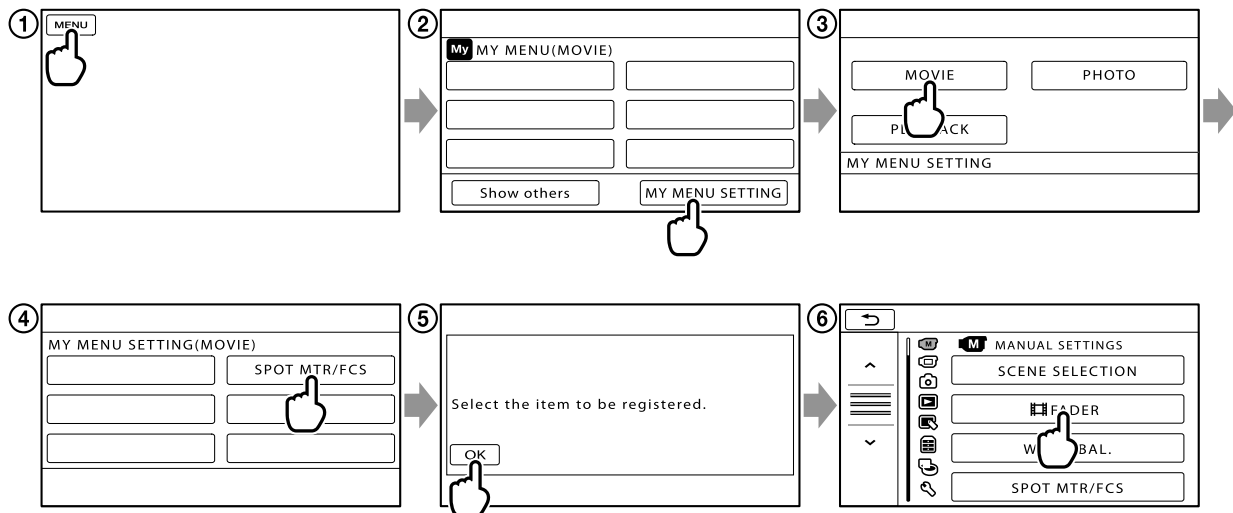



- ① Touch **MENU** (MENU).
- ② Touch [MY MENU SETTING].
- ③ Touch [MOVIE].
- ④ Touch [SPOT MTR/FCS].
- ⑤ Touch **OK**.
- ⑥ Touch [**F**ADER] (under **M** [MANUAL SETTINGS] category).
- ⑦ When MY MENU is displayed, touch **X**.

Repeat the same steps above to register menu items on MY MENU, and enjoy using your “Handycam.”



💡 Tips

- When an external storage device is connected, the exclusive MY MENU appears.

Using the OPTION MENU

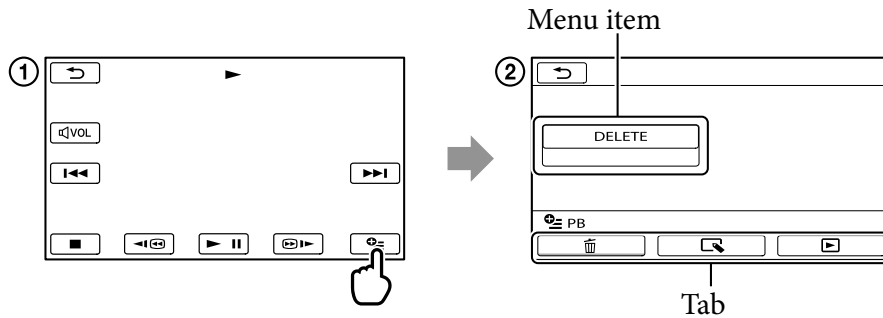
The OPTION MENU appears just like the pop-up window that appears when you right-click the mouse on a computer. When  is displayed at bottom-right of the screen, you can use the OPTION MENU. You touch , and the menu items you can change in the context appear.



- ① Touch  (OPTION).
- ② Touch the desired tab → the item to change the setting.
- ③ After completing the setting, touch .

Notes







- Grayed out menu items or settings are not available.
- When the item you want is not on the screen, touch another tab. (There may be no tab.)
- The tabs and items that appear on the screen depend on the recording/playback status of your camcorder at the time.

Menu lists

(MANUAL SETTINGS) category

- SCENE SELECTION Selects an appropriate recording setting according to the type of scene, such as night view or beach.
-  FADER..... Fades scenes in or out.
- WHITE BAL..... Adjusts the color balance to the brightness of the recording environment.
- SPOT MTR/FCS Adjusts the brightness and focus for the selected subject simultaneously.
- SPOT METER Adjusts the brightness of images to a subject you touch on the screen.
- SPOT FOCUS Focuses on a subject you touch on the screen.
- EXPOSURE Adjusts the brightness of movies and photos.
- FOCUS..... Focuses manually.
- TELE MACRO..... Shoots a subject in focus with, the background out of focus.
- GOLF SHOT Divides two seconds of fast movement into frames which are then recorded as a movie and photos.
- SMTH SLW REC..... Records fast moving subjects in slow-motion.







(SHOOTING SET) category

-  HD/STD SET Sets image quality for recording, playback, or editing movies.
-  REC MODE Sets the mode to record movies. When recording fast moving subject, a high image quality is recommended.
- GUIDEFAME..... Displays the frame to make sure the subject is horizontal or vertical.
-  STEADYSHOT Sets the SteadyShot function when recording movies.
- CONVERSION LENS..... Sets the type of an attached conversion lens (sold separately). Optimizes the SteadyShot function and focus according to the attached lens.
- LOW LUX Records bright color images in the dim.
- FACE DETECTION Adjusts the image quality of the face(s) automatically.
- PRIORITY SETTING..... Select the subject that has priority for the face detection and the smile shutter.
- SMILE DETECTION Automatically takes a shot whenever a smile is detected.
- SMILE SENSITIVITY..... Sets the smile detection sensitivity using the smile shutter function.
- AUDIO REC SET
- BLT-IN ZOOM MIC..... Records movies with vivid sound appropriate to the zoom position.
- MICREF LEVEL..... Sets the microphone level.
- OTHER REC SET
-  DIGITAL ZOOM Sets the maximum zoom level of the digital zoom that exceeds the zoom level of the optical zoom.
- AUTO BACK LIGHT..... Adjusts the exposure for backlit subjects automatically.
-  X.V.COLOR..... Records wider range of colors.
-  WIDE SELECT..... Sets the horizontal to vertical ratio when recording movies with standard definition image quality (STD).

(PHOTO SETTINGS) category

- SELF-TIMER..... Sets the self-timer when your camcorder is in photo recording mode.
- IMAGE SIZE..... Sets the photo size.
-  STEADYSHOT..... Sets the SteadyShot function when recording photos.
- FLASH MODE..... Sets how the flash is activated.
- FLASH LEVEL..... Sets the brightness of flash.
- REDEYE REDUC..... Prevents redevye when shooting with flash.
- FILE NO. Sets how to assign the file number.

(PLAYBACK) category

- VISUAL INDEX..... Displays recording images as thumbnails (p. 28).
- VIEW IMAGES
 - DATE INDEX..... Enables searching for desired images by date.
 -  MAP^{*1} Displays the Map Index for searching for movies and photos by recording location.
 -  FILM ROLL..... Displays and plays the scenes by a certain interval.
 -  FACE..... Displays and plays the face scenes.
- PLAYLIST..... Displays and plays the playlist of movies.
-  HIGHLIGHT Selects a number of short scenes and plays them back together as a digest of your movies with music and visual effects.
-  SCENARIO Plays the favorite scenario saved in Highlight Playback.
- PLAYBACK SET
 -  SET Sets image quality for recording, playback, or editing movies.
 - DATA CODE..... Displays the detailed recording data during playback.

(EDIT) category









- DELETE
 -  DELETE Deletes movies.
 - DELETE Deletes photos.
-  SCENARIO ERASE
 - ERASE Erases scenarios saved in Highlight Playback.
 - ERASE ALL..... Erases all scenarios saved in Highlight Playback.
- PROTECT
 -  PROTECT..... Protects movies to avoid deleting.
 - PROTECT Protects photos to avoid deleting.
-  DIVIDE..... Divides movies.
- PHOTO CAPTURE Captures photos from desired scenes of movies.
- MOVIE DUB
 - DUB by select Selects movies and dub.
 - DUB by date Dubs all movies of a specified date.
 -  DUB ALL/
 -  DUB ALL..... Dubs all saved movies in a playlist.

PHOTO COPY

COPY by select Selects photos and copy.



COPY by date Copies all photos of a specified date.

PLAYLIST EDIT

 ADD/ ADD Adds movies in a playlist.



 ADD by date/

 ADD by date Adds movies recorded on a same day at one time in a playlist.

 ERASE/ ERASE .. Erases movies from a playlist.

 ERASE ALL/

 ERASE ALL Erases all movies from a playlist.

 MOVE/ MOVE ... Changes the order of movies in a playlist.

(OTHERS) category

 YOUR LOCATION*1 Displays the current location on a map.

USB CONNECT

 USB CONNECT*2 Connects the internal memory via USB.

 USB CONNECT*3 Connects the internal hard disk via USB.

 USB CONNECT Connects the memory card via USB.

DISC BURN Allows you to save images onto discs by pressing the  (DISC BURN) button (p. 42).

TV CONNECT Guide Introduces the connection method depending on the TV type connected (p. 31).

MUSIC TOOL

EMPTY MUSIC Deletes music files.

DOWNLOAD MUSIC Download music files that can be played with Highlight Playback.

BATTERY INFO Displays the battery information.

(MANAGE MEDIA) category

MEDIA SETTINGS

MOVIE MEDIA SET Sets the media for recording movies (p. 20).

PHOTO MEDIA SET Sets the media for recording photos (p. 20).

MEDIA INFO Displays information on the recording media, such as free space.

MEDIA FORMAT

INT. MEMORY*2 Deletes all data on the internal memory.

HDD*3 Deletes all data on the internal hard disk.

MEMORY CARD Deletes all data on the memory card.

REPAIR IMG.DB F.

INT. MEMORY*2 Repairs the image database file on the internal memory (p. 66).

HDD*3 Repairs the image database file on the internal hard disk (p. 66).

MEMORY CARD Repairs the image database file on the memory card (p. 66).

 (GENERAL SET) category

SOUND/DISP SET

- VOLUME..... Adjusts the volume of playback sound (p. 30).
- BEEP Sets whether the camcorder sounds operation beeps or not.
- LCD BRIGHT Adjusts the brightness of the LCD screen.
- LCD BL LEVEL Adjusts the backlight of the LCD screen.
- LCD COLOR..... Adjusts the color intensity of the LCD screen.
- DISPLAY SET Sets the duration that icons or indicators are displayed on the LCD screen.

OUTPUT SETTINGS

- TV TYPE..... Converts the signal depending on the TV connected (p. 31).
- COMPONENT Select this option when you connect your camcorder to a TV with the component input jack (p. 32).
- HDMI RESOLUTION..... Selects the output image resolution when connecting your camcorder to a TV with an HDMI cable.
- DISP OUTPUT Sets whether the on-screen displays appears on the TV screen or not.

CLOCK/LANG

- CLOCK SET Sets the date and time (p. 18).
- AREA SET Adjusts for a time difference without stopping the clock (p. 18).
- AUTO CLOCK ADJ*¹ Sets whether the camcorder adjusts the clock automatically by acquiring the time from GPS or not.
- AUTO AREA ADJ*¹ Sets whether the camcorder compensates for a time differences automatically by acquiring the current location information from GPS or not.

DST SET/

- SUMMERTIME Sets the DST SET (p. 18).
- LANGUAGE SET Sets the display language (p. 19).

POWER SETTINGS

- A.SHUT OFF Changes the [A.SHUT OFF] setting (p. 17).
- POWER ON BY LCD Sets whether or not the camcorder is turned on and off when you open and close the LCD screen.

OTHER SETTINGS

- DEMO MODE..... Sets whether the demonstration appears or not.
- CALIBRATION Calibrates the touch panel.
- CTRL FOR HDMI Sets whether or not the TV's Remote Commander is to be used when the camcorder is connected to a "BRAVIA" Sync compatible TV with the HDMI cable (sold separately).
- DROP SENSOR*³ Activates or deactivates the drop sensor.
- REC LAMP..... Sets REC LAMP to light up or not.
- REMOTE CTRL Sets whether the Wireless Remote Commander is to be used or not.

*¹ HDR-CX350V/XR350V

*² HDR-CX300/CX350/CX350V/CX370

*³ HDR-XR350/XR350V

Getting detailed information from the “Handycam” Handbook

The “Handycam” Handbook is a user guide designed to be read on a computer screen. The “Handycam” Handbook is intended to be read when you want to know more about operating your camcorder.

1 To install the “Handycam” Handbook on a Windows computer, place the supplied CD-ROM in the disc drive of your computer.

2 On the installation screen displayed, click [Handycam Handbook].

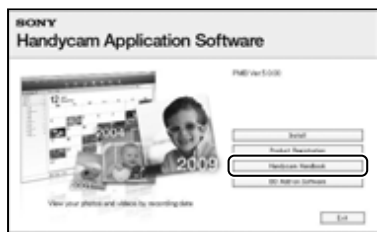

3 Select the desired language and the model name of your camcorder, then click [Handycam Handbook (PDF)].

- The model name of your camcorder is printed on its bottom surface.

4 Click [Exit] → [Exit], then remove the CD-ROM from your computer.

To view the “Handycam” Handbook, double-click the short-cut icon on the computer screen.

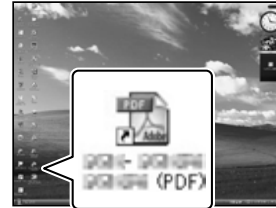

- When using a Macintosh, open the [Handbook] – [US] folder in the CD-ROM, then copy [Handbook.pdf].
- You need Adobe Reader to read “Handycam” Handbook. If it is not installed on your computer, you can download it from the Adobe Systems web page: <http://www.adobe.com/>
- Refer to “PMB Help” for details on the supplied software “PMB” (p. 39).

? Troubleshooting

If you run into any problems using your camcorder, follow the steps below.

① Check the list (p. 64 to 66), and inspect your camcorder.

② Remove the power source, attach the power source again after about 1 minute, and turn the camcorder on.

③ Press RESET (p. 75) using a pointed object, and turn the camcorder on. If you press RESET, all settings, including the clock setting, are reset.

④ Contact your Sony dealer or local authorized Sony service facility.

- Your camcorder may be required to initialize or change the current internal recording media of your camcorder, depending on the problem. In the event of this, the data stored on the internal recording media will be deleted. Be sure to save the data on the internal recording media on other media (backup) before sending your camcorder for repair. We will not compensate you for any loss of internal recording media data.
- During repair, we may check a minimum amount of data stored on the internal recording media in order to investigate the problem. However, your Sony dealer will neither copy nor retain your data.
- See the “Handycam” Handbook (p. 63) for details on the symptoms of your camcorder, and “PMB Help” (p. 39) on connecting your camcorder to a computer.

The power does not turn on.

- Attach a charged battery pack to the camcorder (p. 15).
- Connect the plug of the AC Adaptor to the wall outlet (wall socket) (p. 17).

The camcorder does not operate even when the power is set to on.

- It takes a few seconds for your camcorder to be ready to shoot after the power is turned on. This is not a malfunction.
- Disconnect the AC Adaptor from the wall outlet (wall socket) or remove the battery pack, then reconnect it after about 1 minute. If your camcorder still does not work, press RESET (p. 75) using a pointed object. (If you press RESET, all settings, including the clock setting, are reset.)
- The temperature of your camcorder is extremely high. Turn off the camcorder and leave it for a while in a cool place.
- The temperature of your camcorder is extremely low. Leave the camcorder with the power turned on. If you still cannot operate your camcorder, turn off the camcorder and take it to a warm place. Leave the camcorder there for a while, then turn on the camcorder.



Your camcorder gets warm.

- Your camcorder may become warm during operation. This is not a malfunction.

The power abruptly turns off.

- Use the AC Adaptor (p. 17).
- Turn on the power again.
- Charge the battery pack (p. 15).

Pressing START/STOP or PHOTO does not record images.

- Press MODE to turn on the  (Movie) or  (Photo) lamp.
- Your camcorder is recording the image you have just shot on the recording media. You cannot make any new recordings during this period.
- The recording media is full. Delete unnecessary images (p. 34).
- Total number of movie scenes or photos has exceeded the recordable capacity of your camcorder. Delete unnecessary images (p. 34).

The recording stops.

- The temperature of your camcorder is extremely high/low. Turn off your camcorder and leave it for a while in a cool/warm place.
-

"PMB" cannot be installed.

- Check the computer environment or installation procedure required to install "PMB" (p. 36).
-

"PMB" does not work correctly.

- Quit "PMB" and restart your computer.
-

The camcorder is not recognized by the computer.

- Disconnect devices from the USB jack of the computer other than the keyboard, mouse, and your camcorder.
 - Disconnect the USB cable from the computer and your camcorder, and restart the computer, then connect the computer and your camcorder again in an orderly manner.
-

Self-diagnosis display/Warning indicators

If indicators appear on the LCD screen, check the following.

If the problem persists even after you have tried to fix a couple of times, contact your Sony dealer or local authorized Sony service facility. In this case, when you contact them, give them all the numbers of the error code beginning with C or E.

C:04:□□

- The battery pack is not an "InfoLITHIUM" battery pack V series. Use an "InfoLITHIUM" battery pack (V series) (p. 15).
 - Connect the DC plug of the AC Adaptor to your camcorder securely (p. 15).
-

C:06:□□

- The battery pack temperature is high. Change the battery pack or place it in a cool place.
-

C:13:□□ / C:32:□□

- Remove the power source. Reconnect it and operate your camcorder again.
-

E:□□:□□

- Follow the steps from ② to ④ on page 64.
-



- The internal hard disk of your camcorder is full. Delete unnecessary images on the internal hard disk (p. 34).
 - An error may have occurred with the internal hard disk of your camcorder.
-



- Battery power is low.
-



- The battery pack temperature is high. Change the battery pack or place it in a cool place.
-



- The temperature of your camcorder is getting high. Turn off your camcorder and leave it in a cool place.
-



- The temperature of your camcorder is low. Make the camcorder warm.
-



- No memory card is inserted (p. 21).
 - When the indicator flashes, there is not enough free space for recording images. Delete unnecessary images (p. 34), or format the memory card after storing the images on other media.
-

Precautions

- The Image Database File is damaged. Check the data base file by touching **MENU** (MENU) → [Show others] → [REPAIR IMG.DB F.] (under  [MANAGE MEDIA] category) → the recording medium.



- The memory card is damaged. Format the memory card with your camcorder (p. 61).



- Incompatible memory card is inserted (p. 21).



- Access to the memory card was restricted on another device.



- There is something wrong with the flash.



- The amount of light is not sufficient. Use the flash.
- The camcorder is unsteady. Hold the camcorder steady with both hands. However, note that the camera-shake warning indicator does not disappear.



- The drop sensor function is activated. You may not be able to record nor play back images.



- The recording media is full. Delete unnecessary images (p. 34).
- Photos cannot be recorded during processing. Wait for a while, then record.

On use and care

- Do not use or store the camcorder and accessories in the following locations:
 - Anywhere extremely hot, cold or humid. Never leave them exposed to temperatures above 60 °C (140 °F), such as under direct sunlight, near heaters or in a car parked in the sun. They may malfunction or become deformed.
 - Near strong magnetic fields or mechanical vibration. The camcorder may malfunction.
 - Near strong radio waves or radiation. The camcorder may not be able to record properly.
 - Near AM receivers and video equipment. Noise may occur.
 - On a sandy beach or anywhere dusty. If sand or dust gets in your camcorder, it may malfunction. Sometimes this malfunction cannot be repaired.
 - Near windows or outdoors, where the LCD screen or the lens may be exposed to direct sunlight. This damages the inside of the LCD screen.
- Operate your camcorder on DC 6.8 V/7.2 V (battery pack) or DC 8.4 V (AC Adaptor).
- For DC or AC operation, use the accessories recommended in these operating instructions.
- Do not let your camcorder get wet, for example, from rain or sea water. If your camcorder gets wet, it may malfunction. Sometimes this malfunction cannot be repaired.
- If any solid object or liquid gets inside the casing, unplug your camcorder and have it checked by a Sony dealer before operating it any further.
- Avoid rough handling, disassembling, modifying, physical shock, or impact such as hammering, dropping or stepping on the product. Be particularly careful of the lens.
- Keep the camcorder turning off when you are not using your camcorder.
- Do not wrap your camcorder with a towel, for example, and operate it. Doing so might cause heat to build up inside.
- When disconnecting the power cord (mains lead), pull it by the plug and not the cord (lead).
- Do not damage the power cord (mains lead)

- such as by placing anything heavy on it.
- Do not use a deformed or damaged battery pack.
- Keep metal contacts clean.
- If the battery electrolytic liquid has leaked:
 - Consult your local authorized Sony service facility.
 - Wash off any liquid that may have contacted your skin.
 - If any liquid gets in your eyes, wash with plenty of water and consult a doctor.

When not using your camcorder for a long time

- To keep your camcorder in optimum state for a long time, turn it on and let it run by recording and playing back images about once a month.
- Use up the battery pack completely before storing it.

LCD screen

- Do not exert excessive pressure on the LCD screen, as it may cause damage.
- If your camcorder is used in a cold place, a residual image may appear on the LCD screen. This is not a malfunction.
- While using your camcorder, the back of the LCD screen may heat up. This is not a malfunction.

To clean the LCD screen

- If fingerprints or dust make the LCD screen dirty, it is recommended that you use a soft cloth to clean it. When you use the LCD Cleaning Kit (sold separately), do not apply the cleaning liquid directly to the LCD screen. Use cleaning paper moistened with the liquid.

On handling the casing

- If the casing is soiled, clean the camcorder body with a soft cloth lightly moistened with water, and then wipe the casing with a dry soft cloth.
- Avoid the following to avoid damage to the finish:
 - Using chemicals such as thinner, benzine, alcohol, chemical cloths, repellent, insecticide and sunscreen

- Handling the camcorder with above substances on your hands
- Leaving the casing in contact with rubber or vinyl objects for a long period of time

About care and storage of the lens

- Wipe the surface of the lens clean with a soft cloth in the following instances:
 - When there are fingerprints on the lens surface
 - In hot or humid locations
 - When the lens is exposed to salty air such as at the seaside
- Store in a well-ventilated location subject to little dirt or dust.
- To prevent mold, periodically clean the lens as described above.

On charging the pre-installed rechargeable battery

Your camcorder has a pre-installed rechargeable battery to retain the date, time, and other settings even when the camcorder is turned off. The pre-installed rechargeable battery is always charged while your camcorder is connected to the wall outlet (wall socket) via the AC Adaptor or while the battery pack is attached. The rechargeable battery will be fully discharged in about 3 months if you do not use your camcorder at all. Use your camcorder after charging the pre-installed rechargeable battery. However, even if the pre-installed rechargeable battery is not charged, the camcorder operation will not be affected as long as you are not recording the date.

Procedures

Connect your camcorder to a wall outlet (wall socket) using the supplied AC Adaptor, and leave it with the LCD screen closed for more than 24 hours.

Note on disposal/transfer of the camcorder

Even if you delete all movies and still images, or perform [MEDIA FORMAT], data on the internal recording media may not be completely erased. When you transfer the camcorder, it is recommended that you perform [EMPTY]

Specifications

(See “Getting detailed information from the “Handycam” Handbook” on page 63.) to prevent the recovery of your data. Also, when you dispose of the camcorder, it is recommended that you destroy the actual body of the camcorder.

Note on disposal/transfer of memory card

Even if you delete data in the memory card or format the memory card on your camcorder or a computer, you may not delete data from the memory card completely. When you give the memory card to somebody, it is recommended that you delete data completely using data deletion software on a computer. Also, when you dispose of the memory card, it is recommended that you destroy the actual body of the memory card.

To change the battery of the Wireless Remote Commander

- ① While pressing on the tab, inset your fingernail into the slit to pull out the battery case.
- ② Place a new battery with the + side facing up.
- ③ Insert the battery case back into the Wireless Remote Commander until it clicks.

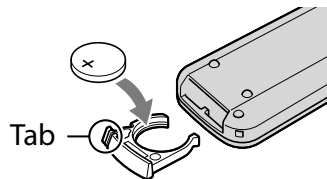

WARNING

Battery may explode if mistreated. Do not recharge, disassemble or dispose of in fire.

- When the lithium battery becomes weak, the operating distance of the Wireless Remote Commander may shorten, or the Wireless Remote Commander may not function properly. In this case, replace the battery with a Sony CR2025 lithium battery. Use of another battery may present a risk of fire or explosion.

System

Signal format: NTSC color, EIA standards
HDTV 1080/60i specification

Movie recording format:
HD: MPEG-4 AVC/H.264 AVCHD format compatible
STD: MPEG-2 PS

Audio recording system:
Dolby Digital 2ch
Dolby Digital Stereo Creator

Photo file format
: DCF Ver.2.0 Compatible
: Exif Ver.2.21 Compatible
: MPF Baseline Compatible

Recording media (Movie/Photo)
Internal memory
HDR-CX300: 16 GB
HDR-CX350/CX350V: 32 GB
HDR-CX370: 64 GB
Internal hard disk
HDR-XR350/XR350V: 160 GB
“Memory Stick PRO Duo” media
SD Memory card, SDHC Memory card (Class 4, 6, 10)

When measuring media capacity, 1 GB equals 1 billion bytes, a portion of which is used for system management and/or application files. The capacity that a user can use is below.

HDR-CX300:
approximately 15.5 GB
HDR-CX350:
approximately 31.5 GB
HDR-CX350V:
approximately 30.8 GB
HDR-CX370:
approximately 63.6 GB
HDR-XR350:
approximately 159 GB
HDR-XR350V:
approximately 158 GB

Image device: 4.5 mm (1/4 type) CMOS sensor
Recording pixels (photo, 4:3):
Max. 7.1 mega (3 072 × 2 304) pixels*1
Gross: Approx. 4 200 000 pixels
Effective (movie, 16:9):
Approx. 2 650 000 pixels*2
Effective (photo, 16:9):
Approx. 2 650 000 pixels
Effective (photo, 4:3):
Approx. 3 540 000 pixels

Lens: G lens

12 × (Optical)^{*2}, 17 ×^{*3}, 160 × (Digital)

Filter diameter: 30 mm (1 3/16 in.)

F1.8 ~ 3.4

Focal length:

f=2.9 ~ 34.8 mm (1/8 ~ 1 3/8 in.)

When converted to a 35 mm still camera

For movies^{*2}: 29.8 ~ 357.6 mm (1 3/16 ~ 14 1/8 in.) (16:9)

For photos: 27.4 ~ 328.8 mm (1 1/8 ~ 13 in.) (4:3)

Color temperature: [AUTO], [ONE PUSH],
[INDOOR] (3 200 K), [OUTDOOR]
(5 800 K)

Minimum illumination

11 lx (lux) (in default setting, shutter speed 1/60 second)

3 lx (lux) (LOW LUX is set to [ON], shutter speed 1/30 second)

^{*1} The unique pixel array of Sony's ClearVid and the image processing system (BIONZ) allow still image resolution equivalent to the sizes described.

^{*2} [STEADYSHOT] is set to [STANDARD] or [OFF].

^{*3} [STEADYSHOT] is set to [ACTIVE].

Input/Output connectors

A/V Remote Connector: Component/video and audio output jack

HDMI OUT jack: HDMI mini connector

USB jack: mini-AB

LCD screen

Picture: 6.7 cm (2.7 type, aspect ratio 16:9)

Total number of pixels: 230 400 (960 × 240)

General

Power requirements: DC 6.8 V/7.2 V (battery pack) DC 8.4 V (AC Adaptor)

Average power consumption: During camera recording, using LCD screen at normal brightness:

HDR-CX300/CX350/CX350V/CX370

HD: 3.3 W STD: 2.4 W

HDR-XR350/XR350V

HD: 3.6 W STD: 2.7 W

Operating temperature: 0 °C to 40 °C (32 °F to 104 °F)

Storage temperature: -20 °C to +60 °C (-4 °F to +140 °F)

Dimensions (approx.):

HDR-CX300/CX350/CX350V/CX370:

52 × 64 × 112 mm (2 1/8 × 2 5/8 × 4 1/2 in.)

(w/h/d) including the projecting parts

52 × 64 × 125 mm (2 1/8 × 2 5/8 × 5 in.)

(w/h/d) including the projecting parts, and the supplied rechargeable battery pack attached

HDR-XR350/XR350V:

59 × 67 × 113 mm (2 3/8 × 2 3/4 × 4 1/2 in.)

(w/h/d) including the projecting parts

59 × 67 × 125 mm (2 3/8 × 2 3/4 × 5 in.)

(w/h/d) including the projecting parts, and the supplied rechargeable battery pack attached

Mass (approx.)

HDR-CX300/CX350/CX370:

310 g (10 oz) main unit only

360 g (12 oz) including the supplied rechargeable battery pack

HDR-CX350V:

320 g (11 oz) main unit only

370 g (13 oz) including the supplied rechargeable battery pack

HDR-XR350:

380 g (13 oz) main unit only

430 g (15 oz) including the supplied rechargeable battery pack

HDR-XR350V:

390 g (13 oz) main unit only

440 g (15 oz) including the supplied rechargeable battery pack

AC Adaptor AC-L200C/AC-L200D

Power requirements: AC 100 V - 240 V, 50 Hz/60 Hz

Current consumption: 0.35 A - 0.18 A

Power consumption: 18 W

Output voltage: DC 8.4 V*

Operating temperature: 0 °C to 40 °C (32 °F to 104 °F)

Storage temperature: -20 °C to +60 °C (-4 °F to +140 °F)

Dimensions (approx.): 48 × 29 × 81 mm (1 15/16 × 1 3/16 × 3 1/4 in.) (w/h/d) excluding the projecting parts

Mass (approx.): 170 g (6.0 oz) excluding the power cord (mains lead)

* See the label on the AC Adaptor for other specifications.

Rechargeable battery pack NP-FV50

Maximum output voltage: DC 8.4 V

Output voltage: DC 6.8 V

Maximum charge voltage: DC 8.4 V

Maximum charge current: 2.1 A

Capacity

Typical: 7.0 Wh (1 030 mAh)

Minimum: 6.6 Wh (980 mAh)

Type: Li-ion

Design and specifications of your camcorder and accessories are subject to change without notice.

- Manufactured under license from Dolby Laboratories.

Expected charging and running time for the supplied battery pack (in minute)

HDR-CX300/CX350/CX350V/CX370

Image quality	HD	STD
Charging time (full charge)	155	
Continuous recording time	110	155
Typical recording time	55	75
Playback time	190	240



HDR-XR350/XR350V

Image quality	HD	STD
Charging time (full charge)	155	
Continuous recording time	100	140
Typical recording time	50	70
Playback time	155	200

- Recording and playback time is approximate time available using a fully charged battery pack.
- High definition image quality (HD)/Standard definition image quality (STD)
- Recording condition: [ REC MODE] is set to [HQ].

- Typical recording time shows the time when you repeat recording start/stop, turning the power on/off and zooming.

Expected recording time of movies in the internal recording media

- To set the recording mode, touch **MENU** (MENU) → [Show others] → [ REC MODE] (under  [SHOOTING SET] category). In the default setting, the recording mode is [HD HQ].

Internal memory

HDR-CX300

High definition image quality (HD) in h (hour) and m (minute)

Recording mode	Recording time
[HD FX]	1 h 25 m
[HD FH]	1 h 55 m
[HD HQ]	3 h 50 m
[HD LP]	6 h 35 m

Standard definition image quality (STD) in h (hour) and m (minute)

Recording mode	Recording time
[STD HQ]	3 h 55 m

HDR-CX350/CX350V

High definition image quality (HD) in h (hour) and m (minute)

Recording mode	Recording time	
	HDR-CX350	HDR-CX350V
[HD FX]	3 h	2 h 55 m
[HD FH]	3 h 55 m	3 h 45 m
[HD HQ]	7 h 50 m	7 h 35 m
[HD LP]	13 h 20 m	13 h

Standard definition image quality (STD) in h (hour) and m (minute)

Recording mode	Recording time	
	HDR-CX350	HDR-CX350V
[STD HQ]	8 h 5 m	7 h 50 m

HDR-CX370

High definition image quality (HD) in h (hour) and m (minute)

Recording mode	Recording time
[HD FX]	6 h 5 m
[HD FH]	7 h 55 m
[HD HQ]	15 h 50 m
[HD LP]	26 h 55 m

Standard definition image quality (STD) in h (hour) and m (minute)

Recording mode	Recording time
[STD HQ]	16 h 15 m

Internal hard disk

HDR-XR350/XR350V

High definition image quality (HD) in h (hour) and m (minute)

Recording mode	Recording time	
	HDR-XR350	HDR-XR350V
[HD FX]	15 h 20 m	15 h 10 m
[HD FH]	19 h 50 m	19 h 40 m
[HD HQ]	39 h 40 m	39 h 30 m
[HD LP]	67 h 30 m	67 h 10 m

Standard definition image quality (STD) in h (hour) and m (minute)

Recording mode	Recording time	
	HDR-XR350	HDR-XR350V
[STD HQ]	40 h 50 m	40 h 40 m

Example of expected recording time of movies in a memory card (in minute)

Recording mode	For 4 GB capacity	
	High definition (HD)	Standard definition (STD)
[FX]	20 (20)	-
[FH]	25 (25)	-
[HQ]	55 (40)	55 (50)
[LP]	95 (75)	-

- The number in () is the minimum recordable time.
- The recordable time may vary depending on the recording and subject conditions and [ REC MODE].
- On charging/recording/playback time
 - Measured when using the camcorder at 25 °C (77 °F) (10 °C to 30 °C (50 °F to 86 °F) is recommended)
 - The recording and playback time will be shorter in low temperatures, or depending on the conditions under which you use your camcorder.
- If you want to record up to the maximum recording time indicated in the table, you need to delete the demonstration movie on your camcorder (HDR-CX350/CX350V/CX370/XR350/XR350V).

On trademarks

- “Handycam” and **HANDYCAM** are registered trademarks of Sony Corporation.
- “AVCHD” and “AVCHD” logotype are trademarks of Panasonic Corporation and Sony Corporation.
- “Memory Stick,” “,” “Memory Stick Duo,” “**MEMORY STICK DUO**,” “Memory Stick PRO Duo,” “**MEMORY STICK PRO DUO**,” “Memory Stick PRO-HG Duo,” “**MEMORY STICK PRO-HG DUO**,” “MagicGate,” “**MAGIC GATE**,” “MagicGate Memory Stick” and “MagicGate Memory Stick Duo” are trademarks or registered trademarks of Sony Corporation.
- “InfoLITHIUM” is a trademark of Sony Corporation.
- “x.v.Color” is a trademark of Sony Corporation.
- “BIONZ” is a trademark of Sony Corporation.
- “BRAVIA” is a trademark of Sony Corporation.
- “DVDirect” is a trademark of Sony Corporation.
- “Blu-ray Disc” and the logo are trademarks.
- Dolby and the double-D symbol are trademarks of Dolby Laboratories.
- HDMI, the HDMI logo and High-Definition Multimedia Interface are trademarks or registered trademarks of HDMI Licencing LLC.
- Microsoft, Windows, Windows Vista, and DirectX are either registered trademarks or trademarks of Microsoft Corporation in the United States and/or other countries.
- Macintosh and Mac OS are registered trademarks of Apple Inc. in the U.S. and other countries.
- Intel, Intel Core, and Pentium are trademarks or registered trademarks of Intel Corporation or its subsidiaries in the United States and other countries.
- “PlayStation” is a registered trademark of Sony Computer Entertainment Inc..
- Adobe, the Adobe logo, and Adobe Acrobat are either registered trademarks or trademarks of Adobe Systems Incorporated in the United States and/or other countries.
- NAVTEQ and the NAVTEQ Maps logo are trademarks of NAVTEQ in the US and other countries.
- SDHC logo is a trademark.



- MultiMediaCard is a trademark of MultiMediaCard Association.

All other product names mentioned herein may be the trademarks or registered trademarks of their respective companies. Furthermore, TM and ® are not mentioned in each case in this manual.

Screen indicators

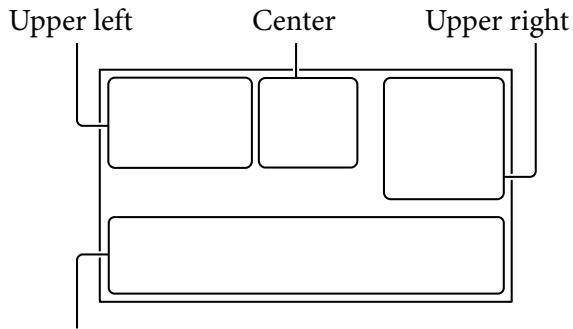

Upper left

Indicator	Meaning
	MENU button
	Self-timer recording
	GPS tracking status
	Flash / REDEYE REDUC
	MICREF LEVEL low
	WIDE SELECT
	BLT-IN ZOOM MIC
	60 min Remaining battery
	Recording folder
	Return button

Center

Indicator	Meaning
	[STBY]/[REC] Recording status
	Photo size
	Slide show set
	Warning
	Playback mode
	Drop sensor off
	Drop sensor activated

Upper right





Indicator	Meaning
	Recording image quality (HD/STD) and recording mode (FX/FH/HQ/LP)
	Recording/playback/editing media
	Counter (hour:minute:second)
	[00min] Estimated recording remaining time
	WHITE BLACK FADER FADER FADER
	9999 Approximate number of recordable photos and recording media
	101 Playback folder
	100/112 Current playing movie or photo/Number of total recorded movies or photos

Bottom

Indicator	Meaning
	[FACE DETECTION] set to [OFF]
	SMILE DETECTION
	LOW LUX
	Manual focus
	SCENE SELECTION
	White balance
	SteadyShot off
	SPOT MTR/FCS / SPOT METER / EXPOSURE
	TELE MACRO
	(COLOR) X.V.COLOR
	CONVERSION LENS
	i AUTO INTELLIGENT AUTO
	OPTION button
	VIEW IMAGES button

Quick reference

Parts and controls

Indicator	Meaning
	Slide show button
	iYOUR LOCATION button
 101-0005	Data file name
	Protected image
	Index button

- Indicators and their positions are approximate and may differ from what you actually see.
- Some indicators may not appear, depending on your camcorder model.

Figures in () are reference pages.

HDR-CX300/CX350/CX350V/CX370

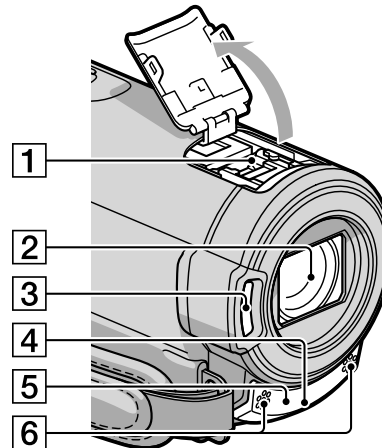

HDR-XR350/XR350V

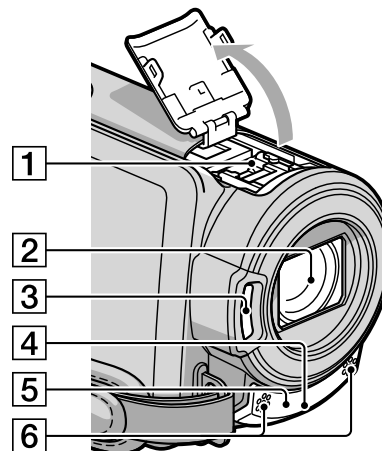

1 Active Interface Shoe



The Active Interface Shoe supplies power to optional accessories such as a video light, a flash, or a microphone. The accessory can be turned on or off as you operate the POWER switch on your camcorder.

2 Lens (G lens)

3 Flash

4 Camera recording lamp

The camera recording lamp lights up in red during recording. The lamp flashes when the remaining recording media capacity or battery power is low.

5 Remote sensor/Infrared port

6 Built-in microphone

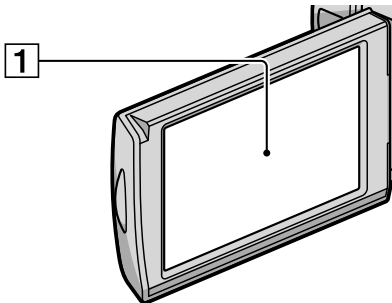

1 LCD screen/Touch panel

If you rotate the LCD panel 180 degrees, you can close the LCD panel with the LCD screen facing out. This is convenient during playback operations.

HDR-CX300/CX350/CX350V/CX370

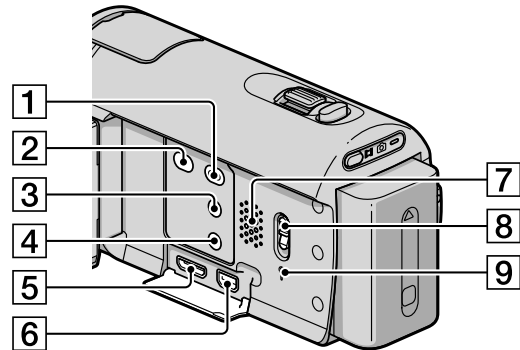

HDR-XR350/XR350V

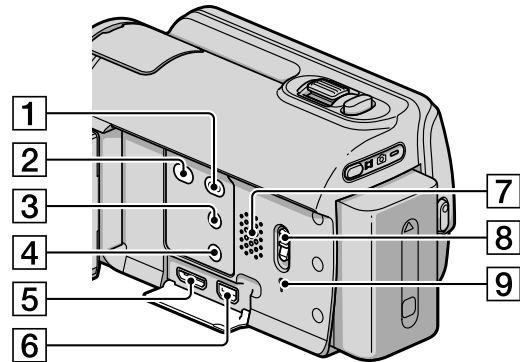

- 1** (VIEW IMAGES) button (28)
- 2** (DISC BURN) button (42)
- 3** (INTELLIGENT AUTO) button
- 4** POWER button (18)
- 5** HDMI OUT jack (31)
- 6** (USB) jack (38, 42, 43, 47, 50)
- 7** Speaker
- 8** GPS switch (HDR-CX350V/XR350V)
- 9** RESET button

Press RESET using a pointed object.

Press RESET to initialize all the settings including the clock setting.

HDR-CX300/CX350/CX350V/CX370

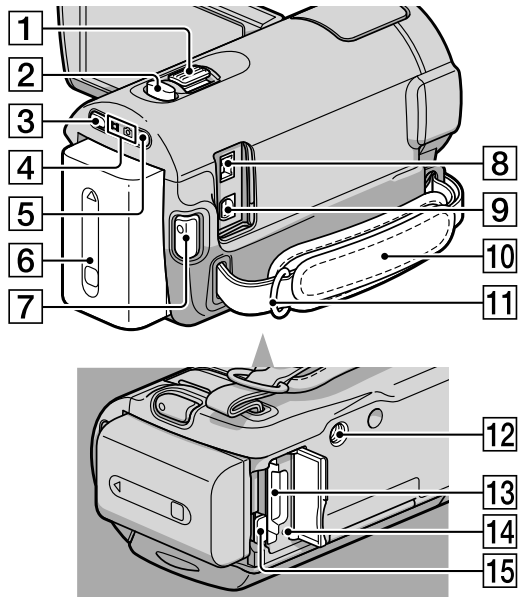

- 8 DC IN jack (15)
- 9 A/V Remote Connector (31)
- 10 Grip belt (23)
- 11 Hook for a shoulder belt
- 12 Tripod receptacle
Attach a tripod (sold separately) to the tripod receptacle using a tripod screw (sold separately: the length of the screw must be less than 5.5 mm (7/32 in.)).
- 13 Memory card slot (22)
- 14 Memory card Access lamp (22)
While the lamp is lit or flashing, the camcorder is reading or writing data.
- 15 PUSH (battery release) button (16)

HDR-XR350/XR350V

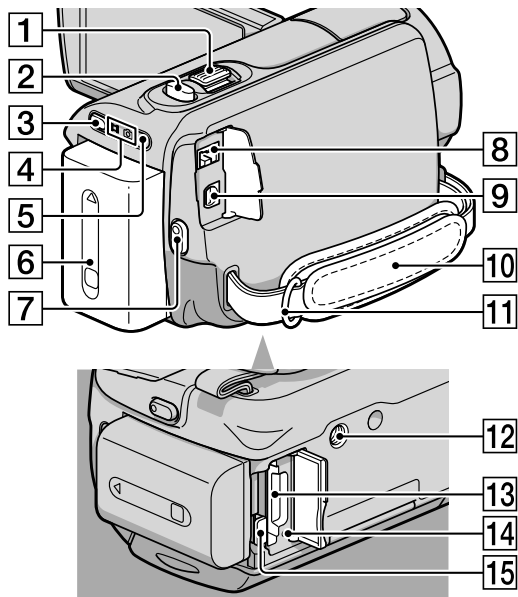

- 1 Power zoom lever
- 2 PHOTO button (26)
- 3 MODE button (23)
- 4 (movie)/ (Photo) lamps (23)
- 5 (flash/charge) lamp (15)
- 6 Battery pack (15)
- 7 START/STOP button (24)

Index

A

A/V connecting cable.....32, 54
AVCHD.....40

B

Battery pack.....15
Blu-ray disc.....45

C

Capturing photos from
a movie.....46
Care66
Charging the battery abroad17
Charging the battery pack.....15
CLOCK SET18
Computer.....36
Computer system.....36
Copying a disc.....46
Creating a disc40, 49
Creating a standard definition
image quality (STD) disc.....45
Creating AVCHD disc44

D

DATA CODE19
DATE/TIME.....19
DELETE.....34
Disc recorder.....54
Dubbing.....22
DVDirect Express.....50
DVD writer.....50, 53

E

Editing movies46
External media.....47

F

Fully charged.....15

G

GPS.....27

H

“Handycam” Handbook.....63

I

Image quality.....59
Install.....37

L

LANGUAGE SET19

M

Macintosh.....37
Maintenance.....66
MANAGE MEDIA20
MEDIA SETTINGS.....20
Memory card.....21
“Memory Stick” media.....21
“Memory Stick PRO-HG Duo”
media.....21
“Memory Stick PRO Duo”
media.....21
Menus.....56, 59
MOVIE MEDIA SET20
Movies.....24, 29
MY MENU57
MY MENU SETTING57

O

One Touch Disc Burn42
Operation flow.....12
OPTION MENU58

P

Parts and controls.....74
PHOTO MEDIA SET20
Photos26, 30
Playing.....28
Playing AVCHD disc.....44
PMB (Picture Motion
Browser).....36, 39
PMB Help39
Power on.....18
Precautions.....66

R

Recording23
Recording and playback time ...70

Recording media.....20
Repair64
RESET75

S

Saving images in external
media.....47
Screen indicators73
Self-diagnosis display.....65
Setting the date and time.....18
Software37
Specifications68
Supplied items.....8

T

Thumbnail.....34
Tripod.....76
Troubleshooting.....64
Turning the power on18
TV.....31
TV CONNECT Guide.....31

U

USB cable.....50, 53
USB CONNECT43, 53

V

VISUAL INDEX28
Volume.....30

W

Wall outlet (wall socket)15
Warning indicators.....65
Windows.....36

You will find the menu lists
on pages 59 to 62.

Additional information on this product and answers to frequently asked questions can be found at our Customer Support Website.

Puede encontrar más información sobre este producto y respuestas a las preguntas más frecuentes en nuestro sitio Web de atención al cliente.

<http://www.sony.net/>

Printed on 70% or more recycled paper using VOC (Volatile Organic Compound)-free vegetable oil based ink.

Impreso en papel reciclado en un 70% o más utilizando tinta hecha con aceite vegetal exento de compuesto orgánico volátil (COV).

Printed in Japan



4171504120

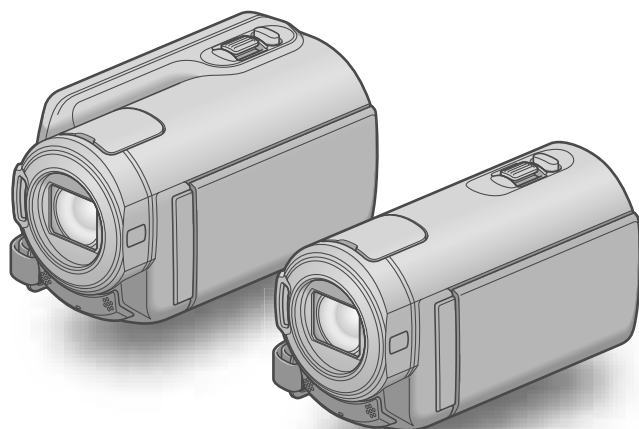

HDR-CX300E/CX305E/CX350E/ CX350VE/CX370E/XR350E/XR350VE

Digital HD Video Camera Recorder

“Handycam” Handbook

AVCHD HDMI

MEMORY STICK™

InfoLITHIUM™ V SERIES

**NAVTEQ
MAPS**

Table of contents	9
Getting started	12
Recording/Playback	20
Making good use of your camcorder	39
Saving images with an external device	52
Customizing your camcorder	61
Additional information	85
Quick reference	112

HANDYCAM®

Read this first

Supplied items

The numbers in () are the supplied quantity.

- AC Adaptor (1)
- Power cord (Mains lead) (1)
- Component A/V cable (1) **A**
- A/V connecting cable (1) **B**
- USB cable (1) **C**
- Wireless Remote Commander (1)
A button-type lithium battery is already installed. Remove the insulation sheet before using the Wireless Remote Commander.
- Rechargeable battery pack NP-FV50 (1)
- CD-ROM “Handycam” Application Software (1)
 - “PMB” (software, including “PMB Help”)
 - “Handycam” Handbook (PDF)
- “Operating Guide” (1)

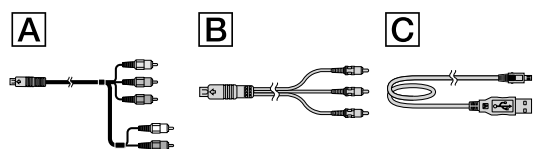

- See page 18 for the memory card you can use with this camcorder.

Using the camcorder

- Do not hold the camcorder by the following parts, and also do not hold the camcorder by the jack covers.

Shoe cover

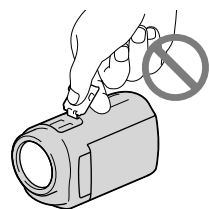

LCD Screen

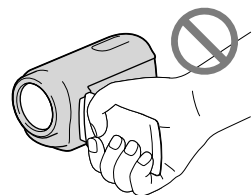

Battery pack

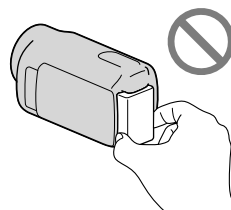

- The camcorder is not dustproofed, dripproofed or waterproofed. See “About handling of your camcorder” (p. 107).
- Even if the camcorder is turned off, the GPS function is working as long as the GPS switch is set to ON. Make sure that the GPS switch is set to OFF during take off and landing of an airplane (HDR-CX350VE/XR350VE).

Menu items, LCD panel, and lens

- A menu item that is grayed out is not available under the current recording or playback conditions.
- The LCD screen is manufactured using extremely high-precision technology, so over 99.99% of the pixels are operational for effective use. However, there may be some tiny black points and/or bright points (white, red, blue, or green in color) that appear constantly on the LCD screen. These points are normal results of the manufacturing process and do not affect the recording in any way.

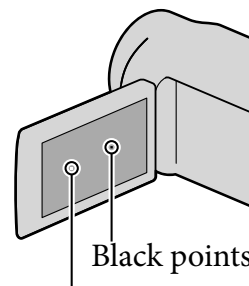

Black points
White, red, blue or green points

- Exposing the LCD screen or the lens to direct sunlight for long periods of time may cause malfunctions.
- Do not aim at the sun. Doing so might cause your camcorder to malfunction. Take images of the sun only in low light conditions, such as at dusk.

About language setting

- The on-screen displays in each local language are used for illustrating the operating procedures. Change the screen language before using the camcorder if necessary (p. 16).

On recording

- To ensure stable operation of the memory card, it is recommended to initialize the memory card with your camcorder before the first use (p. 79). Initializing the memory card will erase all the data stored on it and the data will be irrecoverable. Save your important data on your PC etc.
- Before starting to record, test the recording function to make sure the image and sound are recorded without any problems.
- Compensation for the contents of recordings cannot be provided, even if recording or playback is not possible due to a malfunction of the camcorder, recording media, etc.
- TV color systems differ depending on the country/region. To view your recordings on a TV, you need a PAL system-based TV.
- Television programs, films, video tapes, and other materials may be copyrighted. Unauthorized recording of such materials may be contrary to the copyright laws.

Notes on playing back

- The camcorder is compatible with MPEG-4 AVC/H.264 High Profile for high definition image quality (HD) recording. Therefore, you cannot play back images recorded with high definition image quality (HD) on the camcorder with the following devices;
 - Other AVCHD format compatible devices which are not compatible with High Profile
 - Devices which are not compatible with the AVCHD format
- You may not be able to play back normally images recorded on your camcorder with other devices. Also, you may not be able to play back images recorded on other devices with your camcorder.

Discs recorded with HD image quality (high definition)

- This camcorder captures high definition footage in the AVCHD format. DVD media containing AVCHD footage should not be used with DVD based players or recorders, as the DVD player/recorder may fail to eject the media and may erase its contents without warning. DVD media containing AVCHD footage may be played on a compatible Blu-ray Disc™ player/recorder or other compatible device.

Save all your recorded image data

- To prevent your image data from being lost, save all your recorded images on external media periodically. It is recommended that you save the image data on a disc such as DVD-R, etc. using your computer. Also, you can save your image data using a VCR, or a DVD/HDD recorder (p. 54).
- You cannot make a AVCHD disc from the image data recorded with **MENU** (MENU) → [Show others] → [REC MODE] (under [SHOOTING SET] category) set to [HD FX]. Save them on a Blu-ray Disc or using an external media (p. 52).

Notes on battery pack/AC Adaptor

- Be sure to remove the battery pack or the AC Adaptor after turning off the camcorder.
- Disconnect the AC Adaptor from the camcorder, holding both the camcorder and the DC plug.

Note on the camcorder/battery pack temperature

- When the temperature of the camcorder or battery pack becomes extremely high or extremely low, you may not be able to record or play back on the camcorder, due to the protection features of the camcorder being activated in such situations. In this case, an indicator appears on the LCD screen (p. 92).

When the camcorder is connected to a computer or accessories

- Do not try to format the recording media of the camcorder using a computer. If you do so, your camcorder may not operate correctly.
- When connecting the camcorder to another device with communication cables, be sure to insert the connector plug in the correct way. Pushing the plug forcibly into the terminal will damage the terminal and may result in a malfunction of the camcorder.

If you cannot record/play back images, perform [MEDIA FORMAT]

- If you repeat recording/deleting images for a long time, fragmentation of data occurs on the recording media. Images cannot be saved or recorded. In such a case, save your images on some type of external media first, and then perform [MEDIA FORMAT] by touching **MENU** (MENU) → [Show others] → [MEDIA FORMAT] (under  [MANAGE MEDIA] category) → the desired medium → [YES] → [YES] → **OK**.

Notes on optional accessories

- We recommend using genuine Sony accessories.
- Genuine Sony accessories may not be available in some countries/regions.

About this manual, illustrations and on-screen displays

- The example images used in this manual for illustration purposes are captured using a digital still camera, and therefore may appear different from images and screen indicators that actually appear on your camcorder. And, the illustrations of your camcorder and its screen indication are exaggerated or simplified for understandability.
- In this manual, the internal memory (HDR-CX300E/CX305E/CX350E/CX350VE/CX370E) and the hard disk (HDR-XR350E/XR350VE) of the camcorder and the memory card are called “recording media.”
- In this manual, the DVD disc recorded with

high definition image quality (HD) is called AVCHD disc.

- Design and specifications of your camcorder and accessories are subject to change without notice.



Confirm the model name of your camcorder

- The model name is shown in this manual when there is a difference in specification between models. Confirm the model name on the bottom of your camcorder.
- The main differences in specification of this series are as follows.

	Recording media	Capacity of internal recording media	USB jack
HDR-CX300E	Internal memory + memory card	16GB	Input/output
HDR-CX305E			Output only
HDR-CX350E/ HDR-CX350VE*		32GB	Input/output
HDR-CX370E		64GB	
HDR-XR350E/ HDR-XR350VE*	Internal hard disk + memory card	160GB	

The model with * is equipped with GPS.

Notes on use

- Do not do any of the following. Otherwise, the recording media may be damaged, recorded images may be impossible to play back or may be lost, or other malfunctions could occur.
 - ejecting the memory card when the access lamp (p. 19) is lit or flashing
 - removing the battery pack or AC Adaptor from the camcorder, or applying mechanical shock or vibration to the camcorder when the  (Movie)/ (Photo) lamps (p. 20) or the access lamp (p. 19) are lit or flashing

- When using a shoulder belt (sold separately), do not crash the camcorder against an object.
- Do not use your camcorder in very loud areas.

On the drop sensor (HDR-XR350E/ XR350VE)

- To protect the internal hard disk from shock by dropping, the camcorder has a drop sensor function (p. 84). When a drop occurs, or under a non-gravity condition, the block noise made when this function is activated by the camcorder may also be recorded. If the drop sensor catches a drop repeatedly, recording/playback may be stopped.

Note on using the camcorder at high altitudes (HDR-XR350E/XR350VE)

- Do not turn on the camcorder in a low-pressure area, where the altitude is more than 5,000 meters (16,000 feet). Doing so may damage the internal hard disk drive of your camcorder.

Operation flow

Getting started (p. 12)

Prepare the power source and memory card.

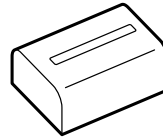

Recording movies and photos (p. 20)

Recording movies → p. 20

💡 Changing the recording mode (p. 25)

💡 Expected recording time (MEDIA INFO, p. 79)

Shooting photos → p. 22

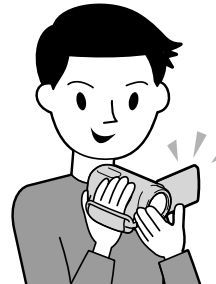

Playing movies and photos

Playback on the camcorder → p. 28

Playing images on a TV → p. 36

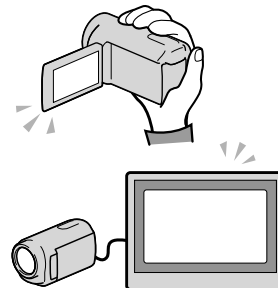

Saving images

Saving movies and photos with a computer

Saving movies and photos in external media → p. 52

Saving images with a DVD writer/recorder → p. 54

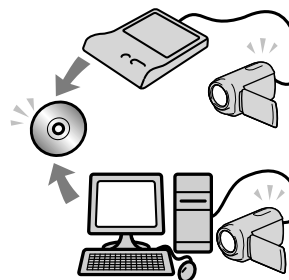

Deleting movies and photos (p. 39)

If you delete the image data that has been saved on your computer or a disc, you can record new images on the free media space again.

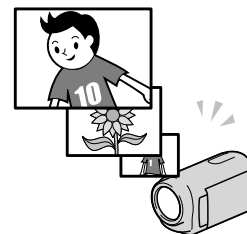

Advice for successful recording



■ To get good results in recording



★ Stabilizing your camcorder

When you hold the camcorder, keep your upper body upright, and hold your arms close to your body. The SteadyShot function is effective against camera-shake, however, it is essential that you not move the camcorder.

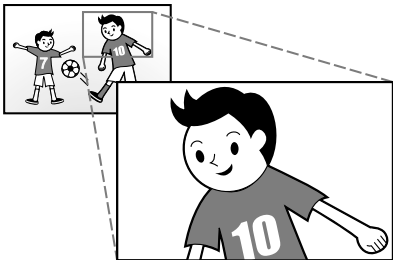

★ Zooming smoothly

Zoom in and out slowly and smoothly. And, use zooming sparingly. Excessive zooming will make movies that may make the viewer feel tired when viewing them.

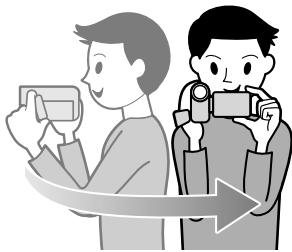

★ Evoking a feeling of spaciousness

Use the panning technique. Stabilize yourself, move your camcorder horizontally as you turn your upper body slowly. Stay still at the end of panning for a while to make the scene look stable.



★ Accentuating movies with narration

Consider the sound to be recorded with your movies. Narrate the subject, or talk to the subject during shooting. Aim for a balanced volume of voices, since the recording person is closer to the microphone than the recorded person.



★ Using accessories

Make good use of camcorder accessories. For example, using a tripod, you can make a time-lapse recording or record subjects in dim light, such as scenes of fireworks, or night views. By always carrying spare batteries, you can continue recording without worrying about battery power shortages.

■ Useful recording techniques

Capturing images beautifully without troublesome setting

INTELLIGENT AUTO(24)



Focusing on the child on the left side of the screen

Prioritizing the subject(26)
SPOT FOCUS(68)



Capturing photos during movie recording

Dual Rec(27)
Smile Shutter (27)



Recording in a dimly-lit room

LOW LUX(72)



Capturing fireworks, or a sunset in all its splendor

FIREWORKS(66)
SUNRISE&SUNSET(66)

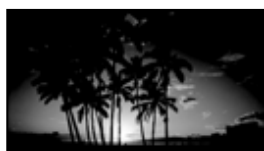

Checking your golf swing

GOLF SHOT(69)
SMTH SLW REC(70)

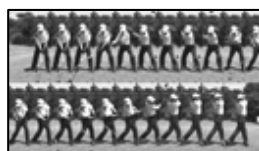

Table of contents

Read this first.....	2
Notes on use.....	4
Operation flow.....	6
Advice for successful recording.....	7
■ Getting started	
Step 1: Charging the battery pack.....	12
Step 2: Turning the power on, and setting the date and time.....	15
Changing the language setting.....	16
Step 3: Preparing the recording media.....	17
Selecting the recording media for movies.....	17
Selecting the recording media for photos.....	17
Inserting a memory card.....	18
■ Recording/Playback	
Recording.....	20
Recording movies.....	20
Shooting photos.....	22
Useful functions for recording movies and photos.....	24
Zooming.....	24
Recording better images automatically (INTELLIGENT AUTO).....	24
Selecting high definition image quality (HD) or standard image quality (STD).....	25
Selecting the recording mode.....	25
Prioritizing the subject.....	26
Capturing smiles automatically (Smile Shutter).....	27
Recording high quality photos during movie recording (Dual Rec).....	27
Recording in mirror mode.....	27
Playback on the camcorder.....	28
Useful functions for playing movies and photos.....	31
Searching for desired images by date (Date Index).....	31
Searching for desired scene by pinpoint (Film Roll Index).....	31
Searching for desired scene by face (Face Index).....	32
Playing back a digest of your movies (Highlight Playback).....	32
Using PB zoom with photos.....	34
Playing back a series of photos (Slide show).....	35
Playing images on a TV.....	36
Connecting a TV using [TV CONNECT Guide].....	36
Using "BRAVIA" Sync.....	38





■ Making good use of your camcorder

Deleting movies and photos.....	39
Protecting recorded movies and photos (Protect)	40
Dividing a movie	41
Capturing a photo from a movie.....	42
Dubbing/copying movies and photos from the internal recording media to memory card	43
Dubbing movies	43
Copying photos.....	44
Using the Playlist of movies.....	45
Creating the Playlist	45
Playing the Playlist	46
Using the GPS function (HDR-CX350VE/XR350VE)	47
Setting the GPS function.....	48
Acquiring the current location information	49
Searching for a desired scene by recording location (Map Index)	49
Displaying the coordinate information (COORDINATES)	50
Adjusting the clock and the area automatically (AUTO CLOCK ADJ/AUTO AREA ADJ)	51

■ Saving images with an external device

Saving images in external media (DIRECT COPY).....	52
Creating a disc with a DVD writer, recorder	54
Selecting the method for creating a disc	54
Creating a disc with the dedicated DVD writer, DVDirect Express	55
Creating a high definition image quality (HD) disc with a DVD writer, etc., other than DVDirect Express	58
Creating a standard definition image quality (STD) disc with a recorder, etc.	59

■ Customizing your camcorder

Using menus	61
Operating menus	61
Using MY MENU.....	62
Using the  OPTION MENU	63
Menu lists.....	64
 MANUAL SETTINGS (Items to adjust for scene condition)	66
 SHOOTING SET (Items for customized shooting)	71
 PHOTO SETTINGS (Items for recording photos)	74

 PLAYBACK (Items for playback)	76
 EDIT (Items for editing)	78
 OTHERS (Items for other settings)	78
 MANAGE MEDIA (Items for recording media)	79
 GENERAL SET (Other setup items)	80

■ Additional information

 Troubleshooting	85
Self-diagnosis display/Warning indicators	92
Recording time of movies/number of recordable photos	96
Expected time of recording and playback with each battery pack	96
Expected recording time of movies	96
Expected number of recordable photos	98
Using your camcorder abroad	100
Maintenance and precautions	102
About the AVCHD format	102
About GPS (HDR-CX350VE/XR350VE)	102
About the "Memory Stick" media	104
About the "InfoLITHIUM" battery pack	105
About x.v.Color	107
About handling of your camcorder	107

■ Quick reference

Screen indicators	112
Parts and controls	113
Index	117

Getting started

Step 1: Charging the battery pack

HDR-CX300E/CX305E/CX350E/CX350VE/CX370E

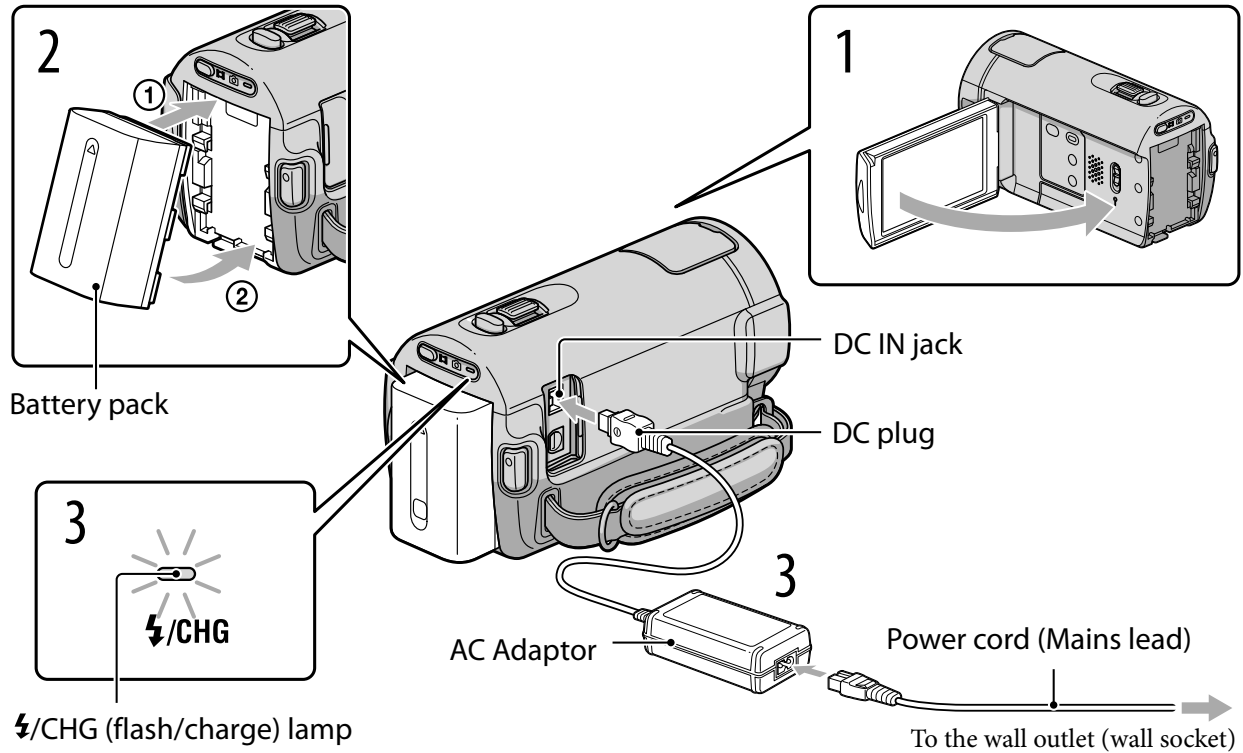

HDR-XR350E/XR350VE

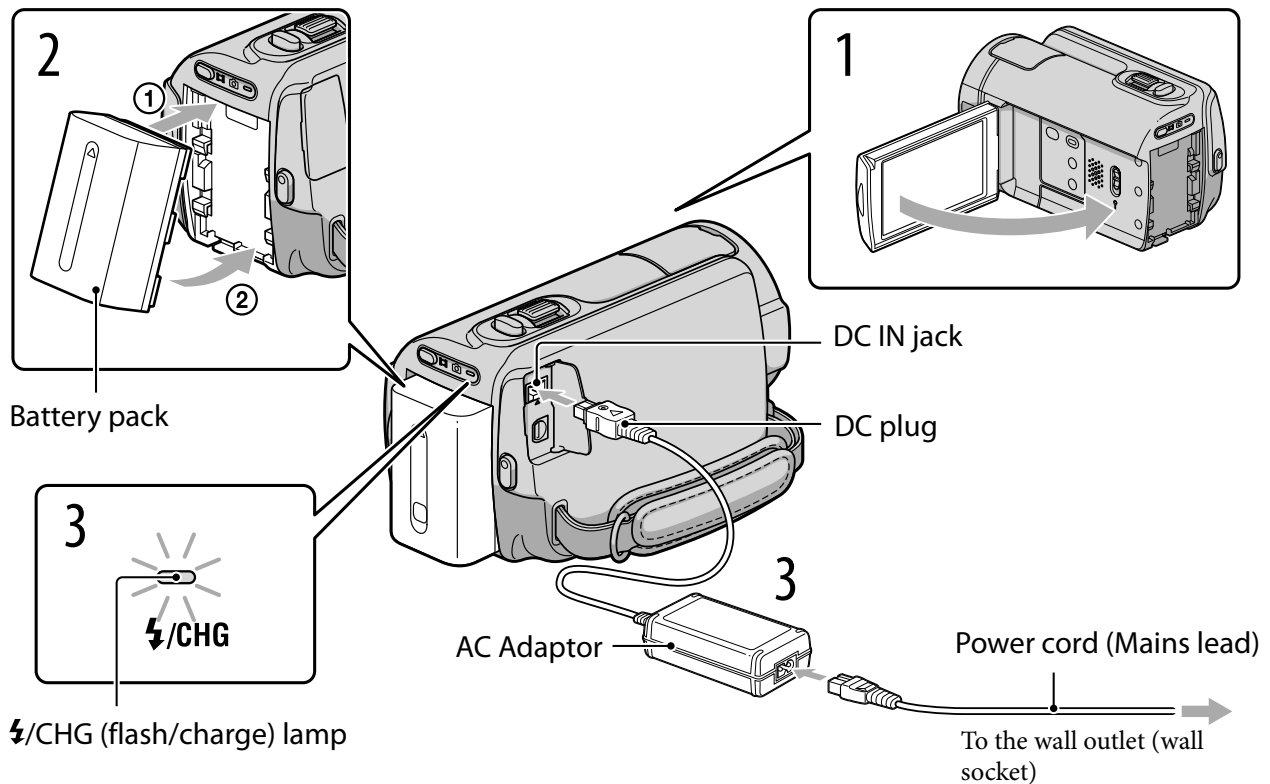

You can charge the “InfoLITHIUM” battery pack (V series) after attaching it to your camcorder.

Notes

- You cannot attach any “InfoLITHIUM” battery pack other than the V series to your camcorder.

- 1 Turn off your camcorder by closing the LCD screen.
- 2 Attach the battery pack by aligning the battery terminals (①) and pushing the battery pack in the direction of the arrow (②) until it clicks.
- 3 Connect the AC Adaptor and the power cord (mains lead) to your camcorder and the wall outlet (wall socket).
 - Align the ▲ mark on the DC plug with that on the DC IN jack.The ⚡/CHG (flash/charge) lamp lights up and charging starts. The ⚡/CHG (flash/charge) lamp turns off when the battery pack is fully charged.
- 4 When the battery is charged, disconnect the AC Adaptor from the DC IN jack of your camcorder.

Tips

- See page 96 on recording and playing time.
- When your camcorder is on, you can check the approximate amount of remaining battery power with the remaining battery indicator at the upper left on the LCD screen.

Charging time

Approximate time (min.) required when you fully charge a fully discharged battery pack.

Battery pack	Charging time
NP-FV50(supplied)	155
NP-FV70	195
NP-FV100	390

- Times measured with the camcorder at 25 °C (77 °F).
10 °C to 30 °C (50 °F to 86 °F) is recommended.

To remove the battery pack

Close the LCD screen. Pushing the PUSH (battery release) button (①), remove the battery pack in the direction of the arrow (②).

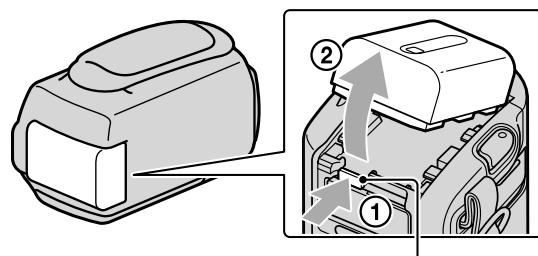

PUSH (battery release) button

To use a wall outlet (wall socket) as a power source

Make the same connections as “Step 1: Charging the battery pack.” Even if the battery pack is attached, the battery pack is not discharged.



Charging the battery pack abroad

You can charge the battery pack in any countries/regions using the AC Adaptor supplied with your camcorder within the AC 100 V - 240 V, 50 Hz/60 Hz range.

⚡ Notes

- Do not use an electronic voltage transformer.

Notes on the battery pack

- When you remove the battery pack or disconnect the AC Adaptor, close the LCD screen and make sure that the  (Movie)/ (Photo) lamps (p. 20), the access lamp (p. 19) are turned off.
- The /CHG (flash/charge) lamp flashes during charging under the following conditions:
 - The battery pack is not attached correctly.
 - The battery pack is damaged.
 - The temperature of the battery pack is low.
Remove the battery pack from your camcorder and put it in a warm place.
 - The temperature of the battery pack is high.
Remove the battery pack from your camcorder and put it in a cool place.
- When attaching a video light (sold separately), it is recommended that you use an NP-FV70 or NP-FV100 battery pack.
- We do not recommend using an NP-FV30, which only allows short recording and playback times, with your camcorder.
- In the default setting, the power turns off automatically if you leave your camcorder without any operation for about 5 minutes, to save battery power ([A.SHUT OFF], p. 83).

Notes on the AC Adaptor

- Use the nearby wall outlet (wall socket) when using the AC Adaptor. Disconnect the AC Adaptor from the wall outlet (wall socket) immediately if any malfunction occurs while using your camcorder.
- Do not use the AC Adaptor placed in a narrow space, such as between a wall and furniture.
- Do not short-circuit the DC plug of the AC Adaptor or battery terminal with any metallic objects. This may cause a malfunction.

Step 2: Turning the power on, and setting the date and time

1 Open the LCD screen of your camcorder.

Your camcorder is turned on and the lens cover is opened.

- To turn on your camcorder when the LCD screen is open, press POWER.

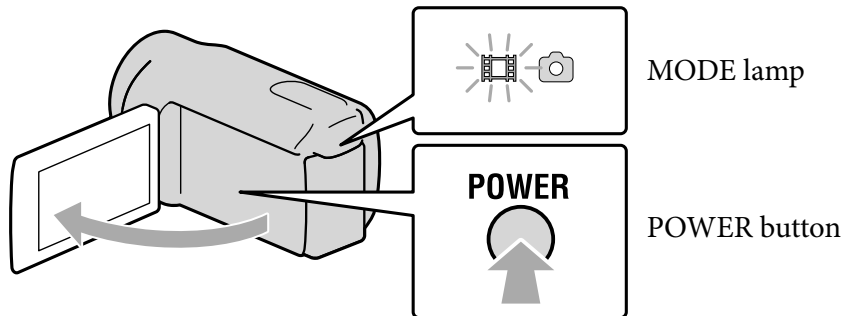

2 Select the desired geographical area with **▲**/**▼**, then touch [NEXT].

Touch the button on the LCD screen

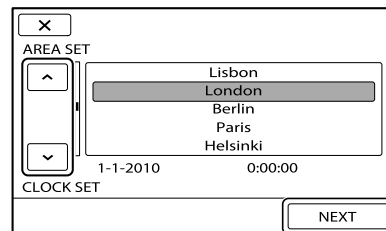
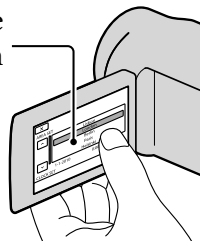

- To set the date and time again, touch **MENU** (MENU) → [Show others] → [CLOCK/ALANG] (under **☞** [GENERAL SET] category) → [CLOCK SET]. When an item is not on the screen, touch **▲**/**▼** until the item appears.



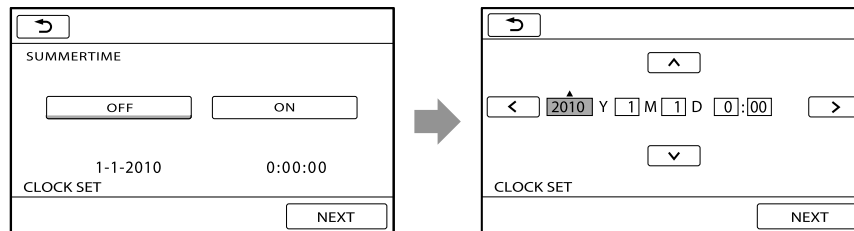

3 Set [SUMMERTIME], date and time, then touch **OK**.

The clock starts.

- If you set [SUMMERTIME] to [ON], the clock advances 1 hour.



⚡ Notes

- The date and time does not appear during recording, but they are automatically recorded on the recording media, and can be displayed during playback. To display the date and time, touch **MENU** (MENU) → [Show others] → [PLAYBACK SET] (under  [PLAYBACK] category) → [DATA CODE] → [DATE/TIME] → **OK** →  → **X**.
- You can turn off the operation beeps by touching **MENU** (MENU) → [Show others] → [SOUND/DISP SET] (under  [GENERAL SET] category) → [BEEP] → [OFF] → **OK** →  → **X**.
- If the button you touch does not react correctly, calibrate the touch panel (p. 108).
- Once the clock is set, the clock time is automatically adjusted with [AUTO CLOCK ADJ] and [AUTO AREA ADJ] set to [ON] (p. 82). The clock may not be adjusted to the correct time automatically, depending on the country/region selected for your camcorder. In this case, set [AUTO CLOCK ADJ] and [AUTO AREA ADJ] to [OFF] (HDR-CX350VE/XR350VE).

To turn off the power





Close the LCD screen. The  (Movie) lamp flashes for a few seconds and the power is turned off.

💡 Tips

- You can turn off your camcorder also by pressing POWER.
- When [POWER ON BY LCD] (p. 83) is set to [OFF], turn off your camcorder by pressing POWER.

Changing the language setting

You can change the on-screen displays to show messages in a specified language.

Touch **MENU** (MENU) → [Show others] → [CLOCK/ LANG] (under  [GENERAL SET] category) → [ LANGUAGE SET] → a desired language → **OK** →  → **X**.

Step 3: Preparing the recording media

The recording media that can be used differs depending on your camcorder. The following icons are displayed on the screen of your camcorder.

HDR-CX300E/CX305E/CX350E/
CX350VE/CX370E



Internal
memory *



Memory
card

HDR-XR350E/XR350VE



Internal hard
disk *



Memory
card

* In the default setting, both movies and photos are recorded on this recording media. You can perform recording, playback and editing operations on the selected medium.

Tips

- See page 96 for the recordable time of movies.
- See page 98 for the number of recordable photos.

Selecting the recording media for movies

- 1 Touch **MENU** (MENU) → [Show others] → [MEDIA SETTINGS] (under  [MANAGE MEDIA] category) → [MOVIE MEDIA SET].

The [MOVIE MEDIA SET] screen appears.

- 2 Touch the desired recording media.

- 3 Touch [YES] → **OK**.

The recording medium is changed.

Selecting the recording media for photos

- 1 Touch **MENU** (MENU) → [Show others] → [MEDIA SETTINGS] (under  [MANAGE MEDIA] category) → [PHOTO MEDIA SET].

The [PHOTO MEDIA SET] screen appears.

- 2 Touch the desired recording media.

3 Touch [YES] → **OK**.

The recording medium is changed.

To check the recording media settings

In either movie recording mode or photo recording mode, the media icon of the selected recording media is displayed at the top right corner of the screen.

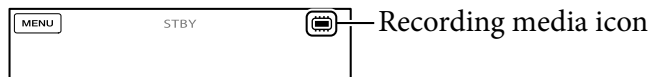

- The icon displayed may vary depending on your model.

Inserting a memory card

⚡ Notes

- Set the recording medium to [MEMORY CARD] to record movies and/or photos on a memory card.

Types of memory card you can use with your camcorder

- Only “Memory Stick PRO Duo” media, “Memory Stick PRO-HG Duo” media, SD memory cards and SDHC memory cards can be used with this camcorder. A MultiMediaCard cannot be used with this camcorder.
- In this manual, “Memory Stick PRO Duo” media and “Memory Stick PRO-HG Duo” media are called “Memory Stick PRO Duo” media.
- Memory cards of up to 32 GB have been verified to operate with your camcorder.

Types of “Memory Stick” media you can use with your camcorder

- For recording movies, it is recommended that you use “Memory Stick PRO Duo” media of 1 GB or larger marked with:
 - **MEMORY STICK PRO DUO** (“Memory Stick PRO Duo” media)*
 - **MEMORY STICK PRO-HG DUO** (“Memory Stick PRO-HG Duo” media)
- * Marked with Mark2 or not, either can be used.

“Memory Stick PRO Duo” media/“Memory Stick PRO-HG Duo” media
(This size can be used with your camcorder.)



- “Memory Stick PRO Duo” media can be used only with “Memory Stick PRO” media compatible equipment.
- Do not attach a label or the like on “Memory Stick PRO Duo” media or “Memory Stick Duo” media adaptor.

Open the cover, and insert the memory card with the notched edge in the direction as illustrated until it clicks.

- Close the cover after inserting the memory card.

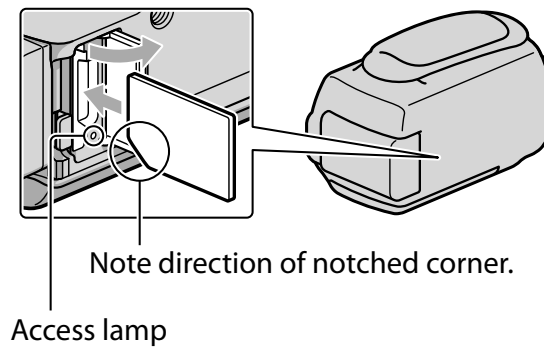

The [Create a new Image Database File.] screen may appear if you insert a new memory card. In that case, touch [YES]. If you record only photos on the memory card, touch [NO].

- Confirm the direction of the memory card. If you forcibly insert the memory card in the wrong direction, the memory card, memory card slot, or image data may be damaged.

⚡ Notes

- If [Failed to create a new Image Database File. It may be possible that there is not enough free space.] is displayed, format the memory card by touching **MENU** (MENU) → [Show others] → [MEDIA FORMAT] (under [MANAGE MEDIA] category) → [MEMORY CARD] → [YES] → [YES] → **OK**.

To eject the memory card

Open the cover and lightly push the memory card in once.

- Do not open the cover during recording.
- When inserting or ejecting the memory card, be careful so that the memory card does not pop out and drop.

Recording

In the default setting, movies are recorded with high definition image quality (HD) on the following media.

HDR-CX300E/CX305E/CX350E/CX350VE/CX370E: Internal memory

HDR-XR350E/XR350VE: Internal hard disk

Tips

- To change the recording media, see page 17.

1 Fasten the grip belt.

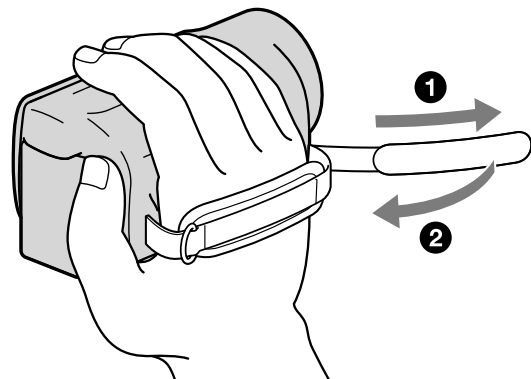

2 Open the LCD screen of your camcorder.

Your camcorder is turned on and the lens cover is opened.

- To turn on your camcorder when the LCD screen is already open, press POWER (p. 15).
- You can switch recording modes by pressing MODE. Press MODE to light up the desired recording mode lamp.

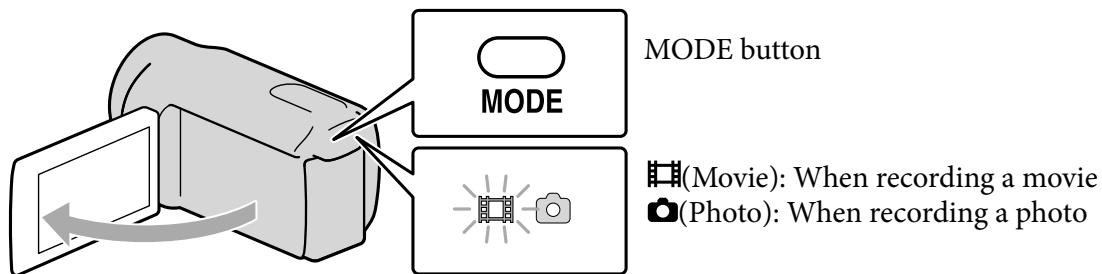

Recording movies

Press START/STOP to start recording.

- You can start recording also by touching ● in the bottom left of LCD screen.

HDR-XR350E/ XR350VE HDR-CX300E/CX305E/
CX350E/CX350VE/CX370E

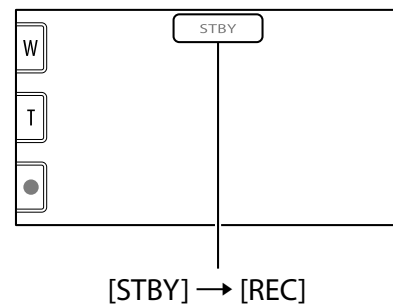
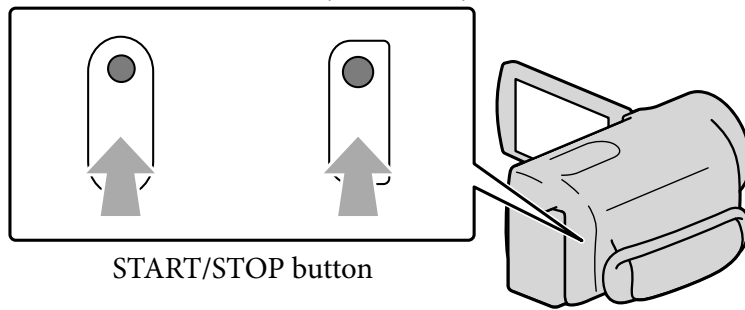

To stop recording, press START/STOP again.

- You can stop recording also by touching ● in the bottom left of LCD screen.

- The icons and indicators on the LCD panel will be displayed for about 3 seconds, then disappear after turning on your camcorder or switching the recording (movie/photo)/playback modes. To display the icons and indicators again, touch anywhere on the screen except the rec & zoom buttons on the LCD.

Rec & zoom buttons on LCD

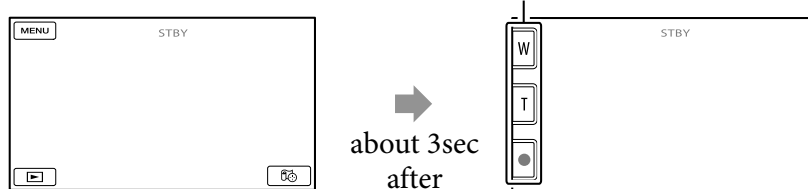



⚡ Notes

- If you close the LCD screen while recording movies, the camcorder stops recording.
- The maximum continuous recordable time of movies is about 13 hours.
- When a movie file exceeds 2 GB, the next movie file is created automatically.
- It will take several seconds until you can start recording after you turn on the camcorder. You cannot operate your camcorder during this time.
- The following states will be indicated if data is still being written onto the recording media after recording has finished. During this time, do not apply shock or vibration to the camcorder, or remove the battery or AC Adaptor.
 - Access lamp (p. 19) is lit or flashing
 - The media icon in the upper right of the LCD screen is flashing

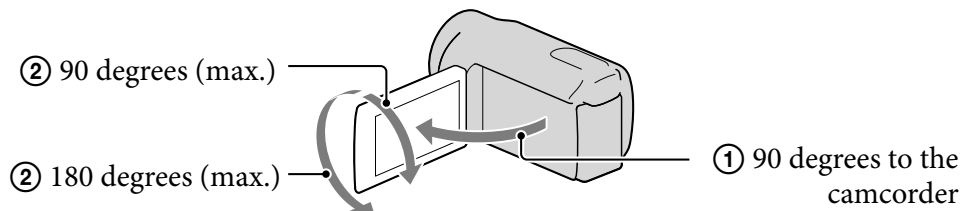

Tips

- See page 96 on the recordable time of movies.
- You can record photos during movie recording by pressing PHOTO fully (Dual Rec, p. 27).
- When a face is detected, a white frame appears and the image quality around the face is optimized automatically ([FACE DETECTION], p. 72).
- You can specify the priority face by touching it (p. 26).
- In the default setting, a photo is recorded automatically when the camcorder detects the smile of a person during movie recording (Smile Shutter, p. 27).
- You can capture photos from recorded movies (p. 42).
- You can check the recordable time, estimated remaining capacity, etc., by touching **MENU** (MENU) → [Show others] → [MEDIA INFO] (under  [MANAGE MEDIA] category).
- The LCD screen of your camcorder can display recording images across the entire screen (full pixel display). However, this may cause slight trimming of the top, bottom, right and left edges of images when played back on a TV which is not compatible with full pixel display. In this case, set [GUIDEFRA] to [ON] (p. 71), and record images using the outer frame displayed on the screen as a guide.
- To adjust the angle of the LCD panel, first open the LCD panel 90 degrees to the camcorder (①), and then adjust the angle (②).



- [ STEADYSHOT] is set to [ACTIVE] in the default setting.

Data code during recording

The recording date, time and condition, and coordinates (HDR-CX350VE/XR350VE) are recorded automatically on the recording media. They are not displayed during recording. However, you can check them as [DATA CODE] during playback. To display them, touch **MENU** (MENU) → [Show others] → [PLAYBACK SET] (under  [PLAYBACK] category) → [DATA CODE] → a desired setting → **OK** →  → **X**.

Shooting photos

In the default setting, photos are recorded on the following recording media.

HDR-CX300E/CX305E/CX350E/CX350VE/CX370E: Internal memory

HDR-XR350E/XR350VE: Internal hard disk

Tips

- To change the recording media, see page 17.

1 Press MODE to turn on the (Photo) lamp.

The LCD screen display switches for photo recording mode, and the screen aspect ratio becomes 4:3.

2 Press PHOTO lightly to adjust the focus, then press it fully.

- You can record photos also by touching **PHOTO** on the LCD screen.

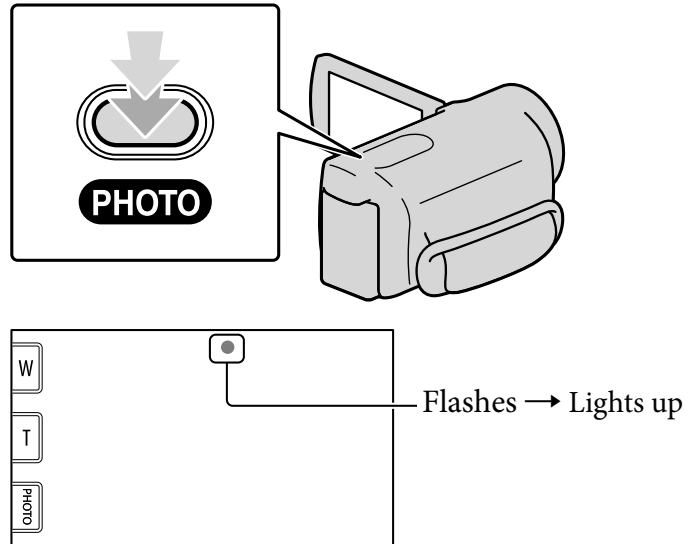

When **|||||||** disappears, the photo is recorded.

Tips

- See page 98 on the recordable number of photos.
- To change the image size, touch **MENU** (MENU) → [Show others] → [**IMAGE SIZE**] (under [PHOTO SETTINGS] category) → a desired setting → **OK** → **X**.
- You cannot record photos while is displayed.
- Your camcorder flashes automatically when there is insufficient ambient light. The flash does not work in the movie recording mode. You can change how your camcorder flashes by **MENU** (MENU) → [Show others] → [FLASH MODE] (under [PHOTO SETTINGS] category) → a desired setting → **OK** → **X**.
- If you record photos using a flash with a conversion lens (sold separately), the shadow may be reflected.

If white circular spots appear on photos

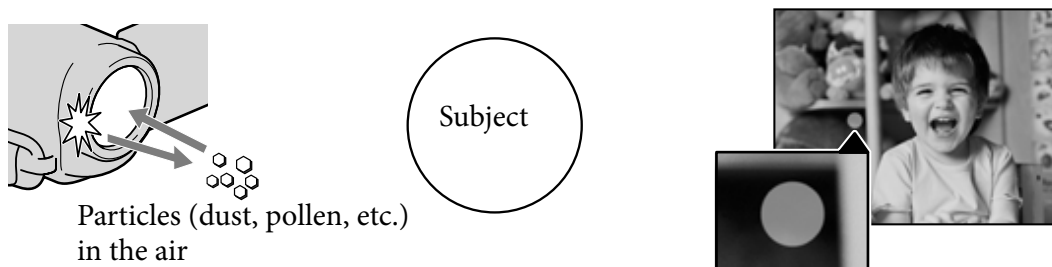

This is caused by particles (dust, pollen, etc.) floating close to the lens. When they are accentuated by the camcorder's flash, they appear as white circular spots.

To reduce the white circular spots, light the room and shoot the subject without a flash.



Useful functions for recording movies and photos

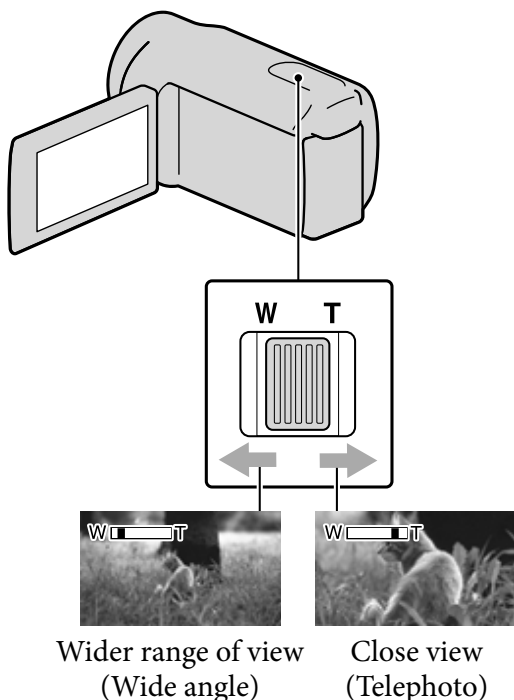

Zooming

You can magnify images up to 17 times the original size with the power zoom lever. You can magnify images also with the   on the LCD screen.



Move the power zoom lever slightly for a slower zoom. Move it further for a faster zoom.

Notes

- Be sure to keep your finger on the power zoom lever. If you move your finger off the power zoom lever, the operation sound of the power zoom lever may also be recorded.
- You cannot change the zoom speed with the   button on the LCD screen.
- The minimum possible distance between camcorder and subject while maintaining sharp focus is about 1 cm (about 13/32 in.) for wide angle and about 80 cm (about 31 1/2 in.) for telephoto.
- You can magnify images up to 12 times using optical zooming, unless [ STEADYSHOT] is

set to [ACTIVE].

Tips

- You can set [ DIGITAL ZOOM] (p. 73) if you want to zoom to a greater level.

Recording better images automatically (INTELLIGENT AUTO)



By pressing **i**, you can record images using the INTELLIGENT AUTO function. When you turn the camcorder toward the subject, the camcorder records using the optimum combination of the three detection modes: Face detection, Scene detection and Camera-shake detection. When the camcorder detects the subject, the icons that correspond to the detected condition are displayed.

Tips

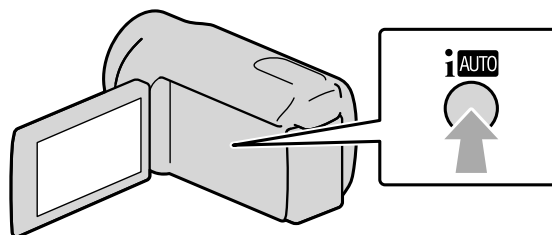
- In the default setting, INTELLIGENT AUTO is set to ON.









Face detection

 (Portrait),  (Baby)

The camcorder detects faces, and adjusts the focus, color, and exposure.

Scene detection

 (Backlight),  (Landscape),  (Twilight),  (Spotlight),  (Low light),  (Macro)

The camcorder selects the most effective setting automatically, depending on the scene.

Camera-shake detection

(Walk), (Tripod)

The camcorder detects whether camera-shake occurs or not, and makes the optimum compensation.

Notes

- The camcorder may not detect the expected scene or subject, depending on the recording conditions.
- You cannot use the flash depending on the scenes detected.

To cancel INTELLIGENT AUTO

Press **i** .

i or the detection mode icons disappear, and you can record with the preferred settings.

Also, the INTELLIGENT AUTO setting is canceled if you change the following settings:

- [GOLF SHOT]
- [SMTH SLW REC]
- [SCENE SELECTION]
- [WHITE BAL.]
- [SPOT MTR/FCS]
- [SPOT METER]
- [SPOT FOCUS]
- [EXPOSURE]
- [FOCUS]
- [TELE MACRO]
- [STEADYSHOT]
- [STEADYSHOT]
- [AUTO BACK LIGHT]
- [LOW LUX]
- [FACE DETECTION]
- [SMILE PRIORITY]

Notes

- Above settings are reset to the default settings when INTELLIGENT AUTO is set to ON.

Selecting high definition image quality (HD) or standard image quality (STD)

You can select the desired image quality from the high definition image quality (HD) that enables you to record fine images, or the standard definition image quality (STD) that has more compatibility with various playback devices. Change the image quality according to the recording situation or the playback device.

1 Touch **MENU** (MENU) → [Show others] → [**HD**/**STD** SET] (under [SHOOTING SET] category).

2 Touch [**HD** HD QUALITY] to record high definition image quality (HD) images, or touch [**STD** STD QUALITY] to record standard definition image quality (STD) images.

3 Touch [YES] → **OK** .

Recording image quality is changed.

Tips

- You can record, play, or edit movies in the selected image quality only. To record, play, or edit movies in another image quality, change this setting.

Selecting the recording mode

You can select a recording mode to record the high definition image quality (HD) movies from 4 levels. The recording time

of the media is changed depending on recording mode.



1 Touch **MENU** (MENU) → [Show others] → [REC MODE] (under [SHOOTING SET] category).

2 Touch a desired setting.

If you want to record high quality images with the high definition image quality (HD), select the FX or FH mode. If you want to record longer movies, select the LP mode.

3 Touch **OK** → **X**.

Notes

- You cannot create an AVCHD disc from a movie recorded with [HD FX] mode of [REC MODE]. Save a movie recorded with [HD FX] mode onto Blu-ray discs or external storage devices (p. 52).

Tips

- Movies are recorded with AVCHD 1920 × 1080/50i format when the FX or FH mode of the high definition image quality (HD) is selected. And when the HQ or LP mode of the high definition image quality (HD) is selected, movies are recorded with AVCHD 1440 × 1080/50i format. Movies are recorded with MPEG-2 format when the standard image quality (STD) is selected.
- You can select the following high definition image quality (HD) recording mode. “24M” of [HD FX] is the maximum bit-rate, and the

value other than of [HD FX], such as “17M,” is an average bit-rate.

- [HD FX] (AVC HD 24M (FX))
 - [HD FH] (AVC HD 17M (FH))
 - [HD HQ] (AVC HD 9M (HQ)) (the default setting)
 - [HD LP] (AVC HD 5M (LP))
- The recording mode of the standard image quality (STD) is limited to the following value. “9M” is an average bit-rate.
 - [STD HQ] (STD 9M (HQ))
 - “M,” such as in “24M,” means “Mbps.”

Prioritizing the subject

When [FACE DETECTION] (p. 72) is set to [ON] (the default setting), and several faces are detected, touch the face you want to record as priority. Focus/color/exposure are adjusted automatically for the selected face. Since the face you touched has priority also with the Smile Shutter function, your camcorder records a photo automatically when it detects the smiling face.



Touch the face you want to record as priority.

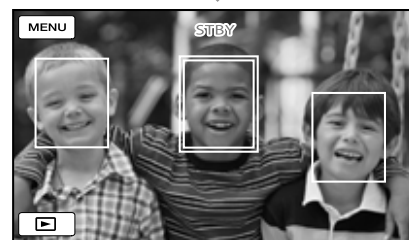

The double-lined frame is displayed.

Touch the face with the double-lined frame again to cancel.

⚡ Notes

- The face you touched may not be detected, depending on the surrounding brightness or hairstyle of the subject. In this case, touch the face again when you record.

💡 Tips

- The double-lined frame around a face targeted for possible smile detection shot turns orange.
- If the face you touched disappears from the LCD screen, the subject selected in [PRIORITY SETTING] (p. 72) has priority. If the face you touched returns to the screen, the face has priority.

Capturing smiles automatically (Smile Shutter)

In the default setting, a photo is recorded automatically when the camcorder detects the smile of a person during movie recording. An orange frame appears around a face targeted for possible smile detection shot.

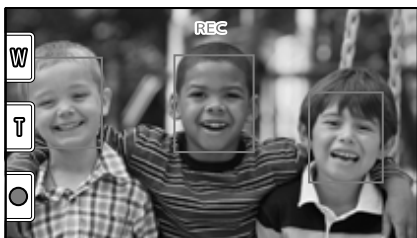

⚡ Notes

- Smiles may not be detected depending on recording conditions, subject conditions, and the setting of your camcorder.
- When [REC MODE] is set to [HD FX], you cannot use the Smile Shutter function.

💡 Tips



- You can select the subject that has priority for face detection and smile detection with [PRIORITY SETTING] (p. 72). When you specify the priority subject by touching the detection frame on the LCD screen, the face with a double-lined frame has priority.

- If a smile is not detected, set the [SMILE SENSITIVITY] (p. 73).



Recording high quality photos during movie recording (Dual Rec)

You can record photos during movie recording by pressing PHOTO.

⚡ Notes

- You cannot use the flash during Dual Rec.
-  may appear when the capacity of the recording media is not enough or when you record photos continuously. You cannot record photos while  is displayed.
- When [REC MODE] is set to [HD FX], you cannot use Dual Rec.

💡 Tips

- When the MODE lamp is set to  (Movie), the size of photos becomes [ 5.3M] (16:9 wide) or [4.0M] (4:3).
- You can record photos during recording standby in the same way as when the  (Photo) lamp is turned on.

Recording in mirror mode

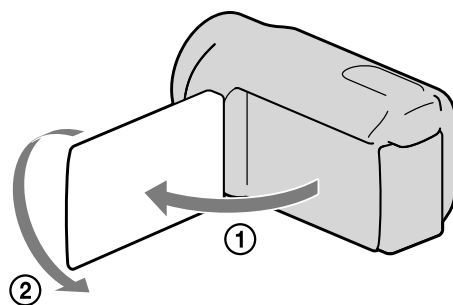

Open the LCD panel 90 degrees to the camcorder (①), then rotate it 180 degrees to the lens side (②).

💡 Tips

- A mirror-image of the subject appears on the LCD screen, but the image will be normal when recorded.

Playback on the camcorder

In the default setting, movies and photos that are recorded on the following recording media are played.

HDR-CX300E/CX305E/CX350E/CX350VE/CX370E: Internal memory

HDR-XR350E/XR350VE: Internal hard disk

Tips

- To change the recording media, see page 17.

1 Open the LCD screen of your camcorder.

Your camcorder is turned on and the lens cover is opened.

- To turn on your camcorder when the LCD screen is already open, press POWER (p.15).

2 Press (VIEW IMAGES).

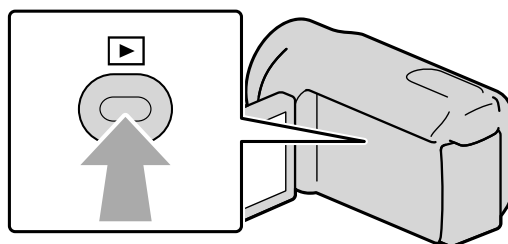

The VISUAL INDEX screen appears after some seconds.

- You can display the VISUAL INDEX screen also by touching  (VIEW IMAGES) on the LCD screen.

3 Touch or (①) → a desired movie (②) to playback a movie. Touch the (Photo) (①) → a desired photo (②) to view a photo.

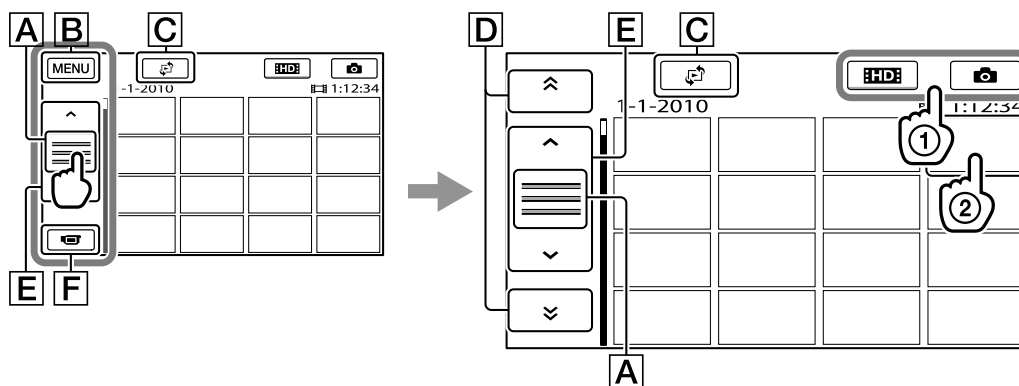

Movies are displayed and sorted by recording date.



A Switches operating button display.

B To MENU screen

C Displays the screen to select the index type ([DATE INDEX]/[MAP] (HDR-CX350VE/XR350VE)/[FILM ROLL]/[FACE]) (p. 31, 49, 31, 32).

D  /  : Displays movies recorded on the previous/next date.*

E / : Displays the previous/next movie.

F Returns to the recording screen.

* **D** is displayed when **A** is touched.

- **STD** appears when the standard definition image quality (STD) movie is selected with [**HDI** / **STD** SET] (p. 25).
- You can scroll the display by touching and dragging **D** or **E**.
- **▶** appears with the movie or photo that was most recently played or recorded. If you touch the movie or photo with **▶**, you can continue playback from the previous time. (**▶** appears on the photo recorded on the memory card.)

Playing movies

Your camcorder starts playing the selected movie.

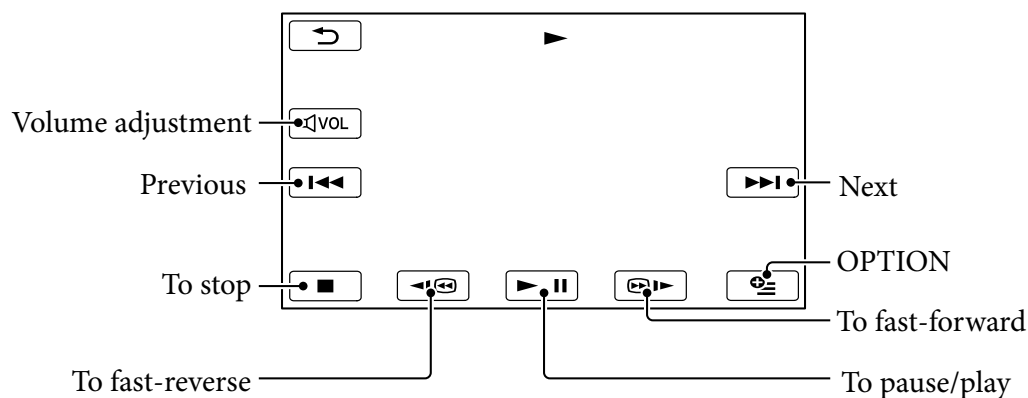

⚡ Notes

- You may not be able to play back the images with other devices than camcorder.

💡 Tips

- When playback from the selected movie reaches the last movie, the screen returns to the INDEX screen.
- Touch / during pause to play back movies slowly.
- As you repeat touching / during playback, movies are played as fast as about 5 times → about 10 times → about 30 times → about 60 times.
- You can also display the VISUAL INDEX by touching **MENU** (MENU) → [Show others] → [VISUAL INDEX] (under [PLAYBACK] category).
- The recording date, time, and shooting conditions, and coordinates (HDR-CX350VE/XR350VE) are recorded automatically during recording. This information is not displayed during recording, but you can display it during playback by touching **MENU** (MENU) → [Show others] → [PLAYBACK SET] (under [PLAYBACK] category) → [DATA CODE] → a desired setting → **OK** → → **X**.
- In the default setting, a protected demonstration movie is pre-recorded (HDR-CX350E/CX350VE/CX370E/XR350E/XR350VE).

To adjust the sound volume of movies

While playing back movies, touch **[VOL]** → adjust with **[VOL-]** / **[VOL+]** → **[RETURN]**.

- You can also adjust the sound volume by using **[-]** / **[+]** in the OPTION MENU.

Viewing photos

Your camcorder displays the selected photo.

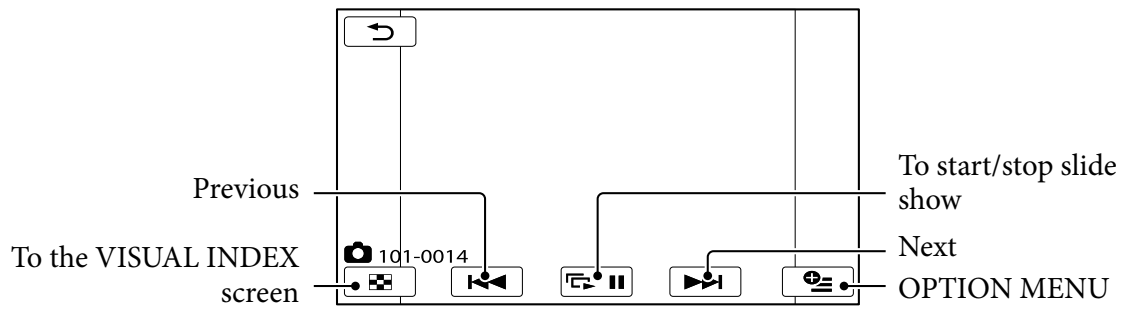

Tips

- When viewing photos recorded on the memory card, **101** ▶ (playback folder) appears on the screen.

Useful functions for playing movies and photos

Searching for desired images by date (Date Index)

You can search for desired images by date efficiently.

⚡ Notes

- You cannot use the Date Index function for photos on the memory card.

1 Press (VIEW IMAGES).

The VISUAL INDEX screen appears.

2 Touch → [DATE INDEX].

Returns to the VISUAL INDEX screen

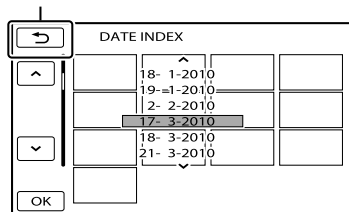

3 Touch / to select the date of the desired image, then touch .

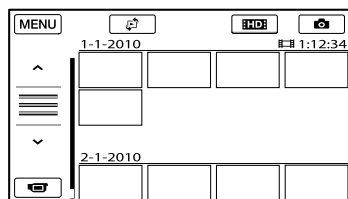

The images of the selected date are displayed on the VISUAL INDEX screen.

💡 Tips

- You can also display Date Index by touching (MENU) → [Show others] → [VIEW

IMAGES] (under [PLAYBACK] category) → [DATE INDEX].

- On the Film Roll Index/Face Index screen, you can display the Date Index by touching the date in the upper right corner of the screen.

Searching for desired scene by pinpoint (Film Roll Index)

Movies can be divided by a set time and the first scene of each division is displayed on the INDEX screen. You can start playing back a movie from the selected thumbnail.

1 Press (VIEW IMAGES).

The VISUAL INDEX screen appears.

2 Touch → [FILM ROLL].

Returns to the VISUAL INDEX screen

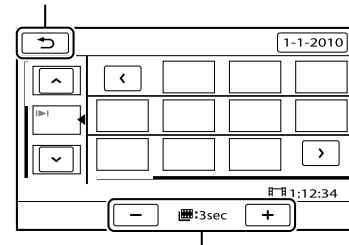



Sets the interval at which to create thumbnails of scenes in a movie.

3 Touch / to select the desired movie.

4 Touch / to search for the desired scene, then touch the scene you want to play back.

Playback starts from the selected scene.

Tips

- You can also display the Film Roll Index by touching **MENU** (MENU) → [Show others] → [VIEW IMAGES] (under  [PLAYBACK] category) → [ FILM ROLL].



Searching for desired scene by face (Face Index)

The face images detected or touched during movie recording are displayed on the INDEX screen.

You can play back the movie from the selected face image.

- 1 Press  (VIEW IMAGES).



The VISUAL INDEX screen appears.

- 2 Touch  → [ FACE].

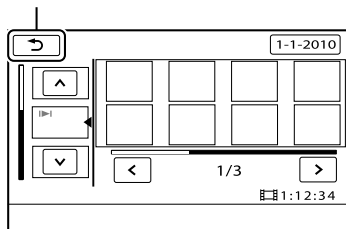
Returns to the VISUAL INDEX screen



- 3 Touch  /  to select the desired movie.



- 4 Touch  /  to search for the desired face image, then touch the desired face image to view the scene.

Playback starts from the beginning of the scene with the selected face image.

Notes



- Faces may not be detected depending on recording conditions.
Example: People wearing glasses or hats, or who do not face towards the camera.
- Make sure that you set [FACE DETECTION] to [ON] (p. 72) (the default setting) prior to recording, to search movies on the Face Index.

Tips

- You can also display the Face Index by touching **MENU** (MENU) → [Show others] → [VIEW IMAGES] (under  [PLAYBACK] category) → [ FACE].

Playing back a digest of your movies (Highlight Playback)

Your camcorder selects Highlight Playback scenes at random, puts them together, and plays them back as a digest of your high definition image quality (HD) movies with music and visual effects. Scenes for Highlight Playback differ each time Highlight Playback is selected. You can save the desired Highlight Playback scenario.

Touch **MENU** (MENU) → [Show others] → [ HIGHLIGHT] (under  [PLAYBACK] category).

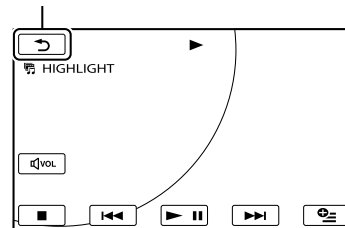

The settings for Highlight Playback appear. The Highlight Playback starts after several seconds.

Returns to the VISUAL INDEX screen







To stop Highlight Playback

To pause, touch .

To stop, touch  or .

To change the settings for Highlight Playback

After touching [ HIGHLIGHT], touch [HIGHLIGHT SET] before the Highlight Playback starts. You can set following items.

- [PLAYBACK RANGE]
Set the range of movies to be played by selecting the from and to date, then touch .If no range is set, your camcorder plays the movies starting from those of the date displayed on the VISUAL INDEX screen until the most recently recorded movie.
- [THEME]
Select one of the following: [SIMPLE], [NOSTALGIC], [STYLISH], [ACTIVE] (the default setting)
The music category is selected automatically according to the theme.
- [MUSIC]
From the music category, you can add one or more of the following: [MUSIC1] - [MUSIC4] (the default setting), [MUSIC5] - [MUSIC8] (the desired music* for HDR-CX300E/CX350E/CX350VE/CX370E/XR350E/XR350VE).
* To change music files, for details, see page 34.
- [AUDIO MIX]
The original sound is played back with the music.
Touch / to adjust the balance between the original sound and the music.
- [SHUFFLE]
To play back movies in random order, select [ON].



Notes

- The [PLAYBACK RANGE] setting is cleared when the Highlight Playback stops.



Tips

- You can change the settings for Highlight Playback during Highlight Playback by touching  (OPTION).
- If you change the settings for Highlight Playback, Highlight Playback scenes are re-selected.
- If you change [MUSIC] after you select [THEME], the music will be selected automatically for the theme from next time.



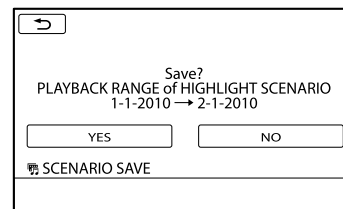



To save a scenario for Highlight Playback

Touch  (OPTION) → [ SCENARIO SAVE] → [YES] during Highlight Playback.



- You can save a maximum of 8 scenarios. If 8 scenarios have already been saved, [HIGHLIGHT SCENARIO full. HIGHLIGHT SCENARIOS may be erased when the  SCENARIO ERASE button is pressed.] appears on the LCD screen. Touch [ SCENARIO ERASE] to delete unwanted scenarios.

To play back a saved Highlight Playback scenario

Touch  (MENU) → [Show others] → [ SCENARIO] (under  [PLAYBACK] category) and select a scenario you want to play back with / and touch .

Notes

- If movies included in the Highlight Playback scenario you are going to play are deleted or divided, the scenario is played back with those movies skipped.

To erase the saved Highlight Playback scenario

Touch **MENU** (MENU) → [Show others] → [SCENARIO ERASE] (under [EDIT] category) → [ERASE] and select a scenario you want to erase with **</>**, then touch **OK** → [YES] → **OK** → **X**.

- To erase all scenarios, touch **MENU** (MENU) → [Show others] → [SCENARIO ERASE] (under [EDIT] category) → [ERASE ALL] → [YES] → [YES] → **OK** → **X**.
- You can erase also by touching **☰** (OPTION) during Highlight Scenario Playback or on the scenario selection screen.

To change music files (HDR-CX300E/CX350E/CX350VE/CX370E/XR350E/XR350VE)

- You can transfer music files from audio CDs or MP3 files to your camcorder, and play them with Highlight Playback. To transfer music files, you need to install the supplied software “PMB” on your computer. Turn on your camcorder and computer, connect them with the supplied USB cable, then touch [DOWNLOAD MUSIC] on the camcorder screen. (If the [USB SELECT] screen does not appear, touch **MENU** (MENU) → [Show others] → [MUSIC TOOL] (under [OTHERS] category) → [DOWNLOAD MUSIC]).
- After the music file is transferred to the camcorder, if you cannot play the music, the music file may be damaged. Delete the music file by touching **MENU** (MENU) → [Show others] → [MUSIC TOOL] (under [OTHERS] category) → [EMPTY MUSIC], then transfer the music file again. If you delete music files using [EMPTY MUSIC], the music data recorded on your camcorder at the factory will be deleted too. In this case, you can restore them using Music Transfer, a software installed together with “PMB.” To start Music Transfer, click [Start] → [All Programs] → [PMB] → [PMB Launcher] → [Export] → [Music Transfer]. For operating instructions, see [Music Transfer] help.

Using PB zoom with photos

You can magnify photos from about 1.1 to 5 times the original size.

Magnification can be adjusted with the power zoom lever.

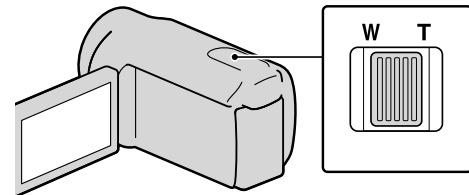

1 Play back the photo you want to magnify.

2 Magnify the photo with T (Telephoto).

The screen is framed.

3 Touch the screen at the point you want to display in the center of the displayed frame.

The point where you touched on the screen is moved to the center of the display frame.

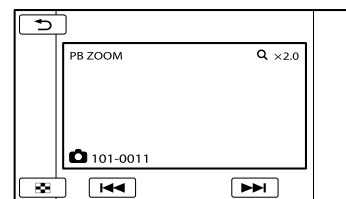

4 Adjust the magnification with W (Wide angle)/T (Telephoto).

To cancel, touch **↶**.

Playing back a series of photos (Slide show)

Touch  on the photo playback screen.

The slide show begins from the selected photo.

To stop the slide show

Touch .



To restart the slide show

Touch  again.

Notes

- You cannot operate playback zoom during slide show.

Tips

- You can set continuous slide show playback by selecting  (OPTION) →  tab → [SLIDE SHOW SET] while playing photos. The default setting is [ON] (continuous playback).

Playing images on a TV

Connection methods and the image quality (high definition (HD) or standard definition (STD)) viewed on the TV screen differ depending on what type of TV is connected, and the connectors used.

Connecting a TV using [TV CONNECT Guide]

You can connect your camcorder to the TV easily following the instructions displayed on the LCD screen, [TV CONNECT Guide].

- 1 Switch the input on the TV to the connected jack.
 - Refer to the instruction manuals of the TV.
- 2 Turn on your camcorder, and touch **MENU** (MENU) → [Show others] → [TV CONNECT Guide] (under **[OTHERS]** category) on the LCD screen.
 - Use the supplied AC Adaptor as the power source (p. 14).

- 3 Touch [High Definition TV].

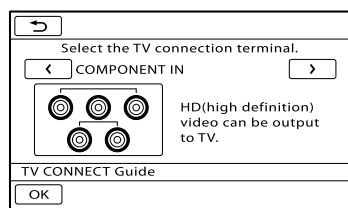

- 4 Touch **</>** to select the input jack of your TV, then touch **OK**.
 - The connection method is displayed.
 - If you touch [HINT], you can see tips for the connection or change the settings of

your camcorder.

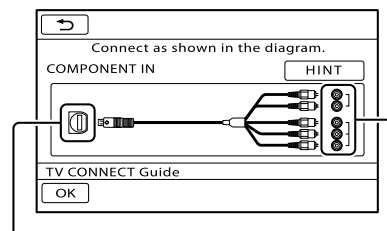

Connectors on your camcorder

Input connectors on the TV

- 5 Connect your camcorder to the TV.

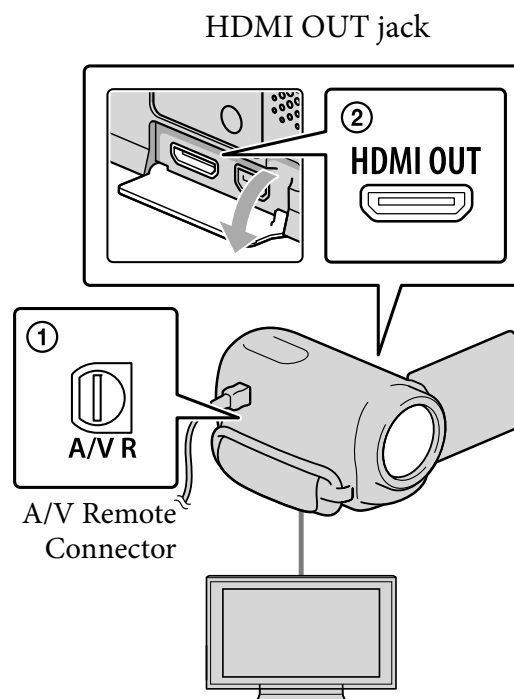

- 6 Touch **OK** → [YES].

- When the A/V connecting cable is used to output movies, movies are output with standard definition image quality (STD).

- 7 Play back movies and photos on your camcorder (p. 28).

Types of connection cables between your camcorder and TV

Connecting to a high definition TV

Component A/V Cable (supplied)

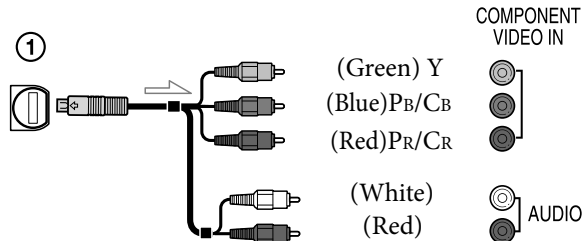

HDMI Cable (sold separately)

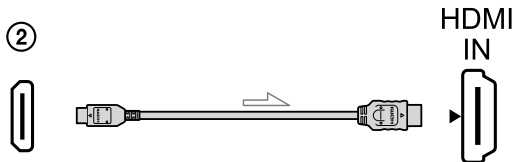

Connecting to a non-high-definition 16:9 (wide) or 4:3 TV

Component A/V Cable (supplied)

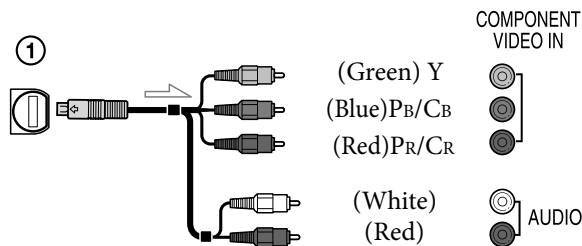

A/V connecting cable with S VIDEO (sold separately)

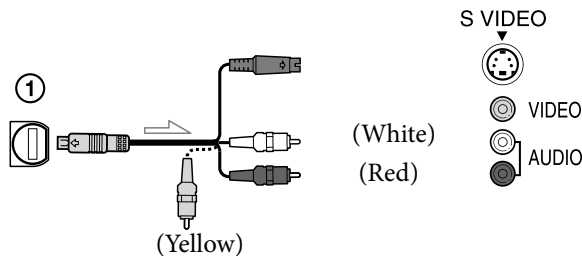

A/V connecting cable (supplied)

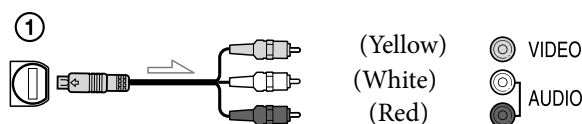

When connecting to your TV via a VCR

- Connect your camcorder to the LINE IN input on the VCR using the A/V connecting cable. Set the input selector on the VCR to LINE (VIDEO 1, VIDEO 2, etc.).

To set the aspect ratio according to the connected TV (16:9/4:3)

- Set [TV TYPE] to [16:9] or [4:3] according to your TV (p. 81).

When your TV is monaural (When your TV has only one audio input jack)

- Connect the yellow plug of the A/V connecting cable to the video input jack and connect the white (left channel) or red (right channel) plug to the audio input jack of your TV or VCR.

When you connect with component A/V cable

- If you connect only component video plugs, audio signals are not output. Connect the white and red plugs to output audio signals.



When you connect with HDMI cable

- Use an HDMI cable with the HDMI logo.
- Use an HDMI mini connector on one end (for the camcorder), and a plug suitable for connecting your TV on the other end.
- Copyright-protected images are not output from the HDMI OUT jack of your camcorder.
- Some TVs may not function correctly (e.g., no sound or image) with this connection.
- Do not connect the camcorder HDMI OUT jack to an external device HDMI OUT jack, as malfunction may result.

When you connect with A/V connecting cable with S Video

- When the S VIDEO plug (S VIDEO channel) is connected, audio signals are not output. To output audio signals, connect the white and red plugs to the audio input jack of your TV.
- This connection produces higher resolution images compared with the A/V connecting cable.

⚡ Notes

- When you play back standard definition image quality (STD) movies on a 4:3 TV that is not compatible with the 16:9 signal, record movies with 4:3 aspect ratio. Touch **MENU** (MENU) → [Show others] → [OTHER REC SET] (under  [SHOOTING SET] category) → [ WIDE SELECT] → [4:3] → **OK** →  → **X** (p. 74).

If your TV/VCR has a 21-pin adaptor (EUROCONNECTOR)

Use a 21-pin adaptor (sold separately) to view playback pictures.

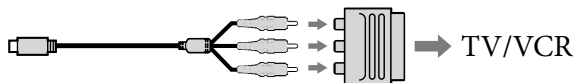

💡 Tips



- If you connect your camcorder to the TV using more than one type of cable to output images, the order of priority of the TV input jacks is as follows:
HDMI → component → S VIDEO → video
- HDMI (High Definition Multimedia Interface) is an interface to send both video/audio signals. The HDMI OUT jack outputs high quality images and digital audio.

Using "BRAVIA" Sync

You can operate your camcorder with the remote commander of your TV by connecting your camcorder to a "BRAVIA" Sync compatible TV launched in 2008 or later with the HDMI cable.

You can operate the menu of your camcorder by pressing the SYNC MENU button of the remote commander of your TV. You can display index screens such as VISUAL INDEX, play selected movies or display selected photos by pressing up/down/left/right/enter buttons of the remote commander of your TV.

⚡ Notes

- There may be some operations you cannot do with the remote commander.
- To set your camcorder, touch **MENU** (MENU) → [Show others] → [OTHER SETTINGS] (under  [GENERAL SET] category) → [CTRL FOR HDMI] → [ON] (the default setting) → **OK** →  → **X**.
- Also set your TV. Refer to the instruction manual of the TV for details.
- The operation of "BRAVIA" Sync differs according to each model of BRAVIA. Refer to the instruction manual of your TV for details.

💡 Tips

- If you turn off the TV, your camcorder is turned off simultaneously.

Deleting movies and photos



You can free media space by deleting movies and photos from recording media.



⚡ Notes



- You cannot restore images once they are deleted. Save important movies and photos in advance.
- Do not remove the battery pack or the AC Adaptor from your camcorder while deleting the images. It may damage the recording media.
- Do not eject memory card while deleting images from the memory card.
- You cannot delete protected movies and photos. Undo the protection of the movies and photos to delete them, before you try to delete them (p. 40).
- The demonstration movie on your camcorder is protected (HDR-CX350E/CX350VE/CX370E/XR350E/XR350VE).
- If the deleted movie is included in the Playlist (p. 45), the movie added to the Playlist is deleted also from the Playlist.
- If the deleted movie is included in the saved Highlight Playback scenario (p. 34), the movie is also deleted from the scenario.

💡 Tips

- You can delete an image on the playback screen from  OPTION MENU.
- To delete all images recorded in the recording media, and recover all the recordable space of the media, format the media (p. 79).
- Reduced-size images which enable you to view many images at the same time on an index screen are called “thumbnails.”

1 Touch  (MENU) → [Show others] → [DELETE] (under  [EDIT] category).



2 To delete movies, touch  [DELETE] →  [DELETE] or  [DELETE].

- To delete photos, touch  [DELETE] →  [DELETE].

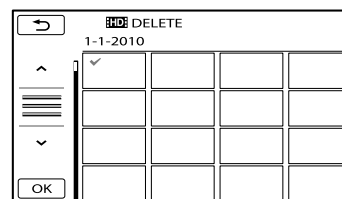



3 Touch and display the  mark on the movies or photos to be deleted.







- Press and hold the image down on the LCD screen to confirm the image. Touch  to return to the previous screen.

4 Touch  → [YES] →  → .

To delete all movies/photos at one time



In step 2, touch  [DELETE] →  [DELETE ALL]/ [DELETE ALL] → [YES] → [YES] →  → .

- To delete all photos at one time, touch  [DELETE] →  [DELETE ALL] → [YES] → [YES] →  → .

To delete all the movies/photos recorded on the same day at one time

⚡ Notes

- You cannot delete photos on memory card by recording date.

① In step 2, touch  [DELETE] →  [DELETE by date]/ [DELETE by date].

- To delete all photos on the same day at one time, touch  [DELETE] →  [DELETE by date].



Protecting recorded movies and photos (Protect)

Protect movies and photos to avoid deleting them by mistake.

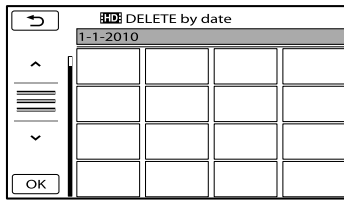

Tips



- You can protect movies and photos on the playback screen from  OPTION MENU.







② Touch  /  to select the recording date of the desired movies/photos, then touch .

- Touch the image on the LCD screen to confirm the image. Touch  to return to the previous screen.

③ Touch [YES] →  → .

1 Touch  (MENU) → [Show others] → [PROTECT] (under  [EDIT] category).

2 To protect movies, touch  [PROTECT] →  [HDD: PROTECT] /  [STD: PROTECT].



- To protect photos, touch  [PROTECT] → .

3 Touch the movies and photos to be protected.

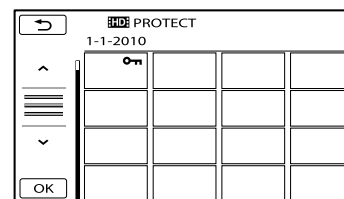
 is displayed on the selected images.



- Press and hold the image down on the LCD screen to confirm the image. Touch  to return to the previous screen.

4 Touch  → [YES] →  → .

Dividing a movie

To undo the protection of movies and photos



Touch the movie or photo marked with  in step 3.



 disappears.

To protect all the movies and photos recorded on the same day at one time



Notes

- You cannot select [PRT. by date] for still images recorded on the memory card.

① In step 2, touch [PROTECT] → [HD: PRT. by date]/[STD: PRT. by date].

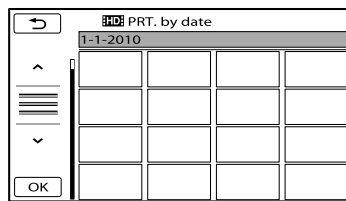
- To protect all photos on the same day at one time, touch [PROTECT] → [PRT. by date].









② Touch  /  to select the recording date of the desired movies/photos, then touch .

- Touch the image on the LCD screen to confirm the image. Touch  to return to the previous screen.

③ Touch [PROTECT] →  → .

To undo the protection of movies and photos recorded on the same day at one time

In step ② above, select the recording date of the desired movies/photos, then touch  → [UNPROTECT] →  → .

1 Touch  (MENU) → [Show others] → [DIVIDE] (under  [EDIT] category).

2 Touch the movie to be divided.
The selected movie starts playback.

3 Touch  at the point where you want to divide the movie into scenes.

The movie pauses. Play and pause toggles as you press .

Adjusts the dividing point with more precision after you selected the dividing point with .

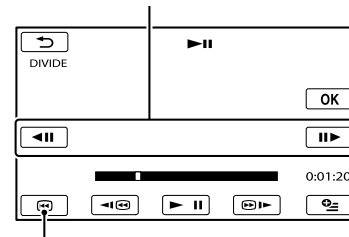

Returns to the beginning of the selected movie

4 Touch  → [YES] → .

Notes

- You cannot restore movies once they are divided.
- You cannot divide protected movie. Undo the protection of the movie to divide it, before you try to divide it (p. 40).
- Do not remove the battery pack or the AC Adaptor from your camcorder while dividing the movie. It may damage the recording media.

Capturing a photo from a movie

Also, do not eject the memory card while dividing movies on the memory card.

- A slight difference may occur from the point where you touch  and the actual dividing point, as your camcorder selects the dividing point based on about half-second increments.
- If you divide the original movie, the movie added to the Playlist will also be divided.
- If the divided movie is included in the saved Highlight Playback scenario (p. 33), the movie is deleted from the scenario.
- Only simple editing is available on the camcorder. Use the supplied software “PMB” for more advanced editing.

Tips

- You can divide a movie on the playback screen from  OPTION MENU.

- 1 Touch  (MENU) → [Show others] → [PHOTO CAPTURE] (under  [EDIT] category).

The [PHOTO CAPTURE] screen appears.

- 2 Touch the movie to be captured.

The selected movie starts playback.

- 3 Touch  at the point where you want to capture.

The movie pauses. Play and pause toggles as you press .

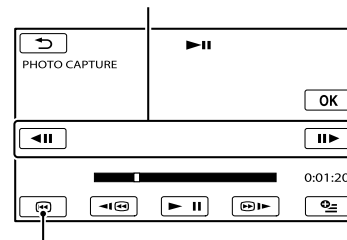

Adjust the capturing point with more precision after you selected the point with .



Returns to the beginning of the selected movie



- 4 Touch .

When capturing is finished, the screen returns to pause.

- The captured photo is saved on the recording media selected in [PHOTO MEDIA SET] (p. 17).
- To continue capturing, touch , then repeat steps from step 3.
- To capture a photo from another movie, touch , then repeat steps from step 2.

5 Touch  → .

⚡ Notes

- The image size is fixed depending on the image quality of the movie:
 - [ 2.1M] with high definition image quality (HD)
 - [ 0.2M] in 16:9 (wide) with standard definition image quality (STD)
 - [VGA(0.3M)] in 4:3 with standard definition image quality (STD)
- The recording medium where you want to save photos should have enough free space.
- The recording date and time of captured photos is the same as the recording date and time of the movies.
- If the movie you are capturing from has no data code, the recording date and time of the photo will be the date and time you captured from the movie.
- You cannot capture a photo from a movie recorded on memory card (HDR-CX305E).

Dubbing/copying movies and photos from the internal recording media to memory card

Dubbing movies

You can dub movies recorded on the internal recording media of your camcorder to memory card.

Insert memory card into your camcorder before the operation.

⚡ Notes

- When you record a movie on the memory card for the first time, create the image database file by touching **MENU** (MENU) → [Show others] → [REPAIR IMG.DB F.] (under  [MANAGE MEDIA] category) → [MEMORY CARD].
- Connect your camcorder to the wall outlet (wall socket) using the supplied AC Adaptor to prevent your camcorder from running out of power during dubbing.

💡 Tips

- The original movie will not be deleted after dubbing.
- All included images in a Playlist will be dubbed.
- The images recorded by this camcorder and stored onto the recording media are called “original.”

1 Touch **MENU** (MENU) → [Show others] → [MOVIE DUB] (under  [EDIT] category).

The [MOVIE DUB] screen appears.

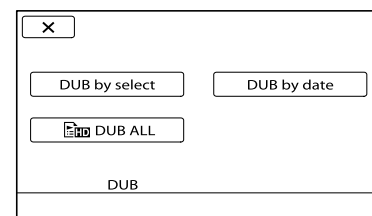

2 Touch the type of dubbing.

[DUB by select]: To select movies and dub

[DUB by date]: To dub all movies of a specified date

[ DUB ALL]: To dub the high definition image quality (HD) Playlist

[ DUB ALL]: To dub the standard definition image quality (STD) Playlist
When you select the Playlist as the source of dubbing, follow the on-screen instructions to dub the Playlist.

3 Select the movie to be dubbed.

[DUB by select]: Touch the movie to be dubbed, and mark it with . You can select multiple movies.

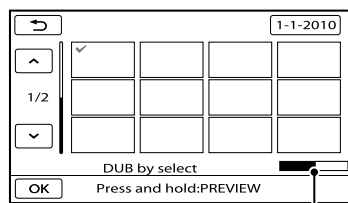

Remaining capacity of the memory card

- Press and hold the image down on the LCD screen to confirm the image. Touch  to return to the previous screen.

[DUB by date]: Select the recording date of the movie to be dubbed, then touch . You cannot select multiple dates.

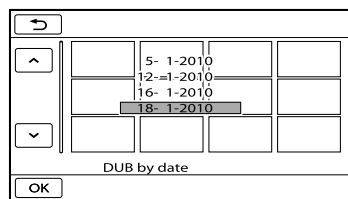

4 Touch → [YES] → → .

Tips

- To check the dubbed movies after dubbing is finished, select [MEMORY CARD] on [MOVIE MEDIA SET] and play them back (p. 17).

Copying photos

You can copy photos from the internal recording media of the camcorder to memory card.

Insert a memory card into your camcorder before the operation.

Notes

- Connect your camcorder to the wall outlet (wall socket) using the supplied AC Adaptor to prevent your camcorder from running out of power during copying.

1 Touch (MENU) → [Show others] → [PHOTO COPY] (under [EDIT] category).

The [PHOTO COPY] screen appears.

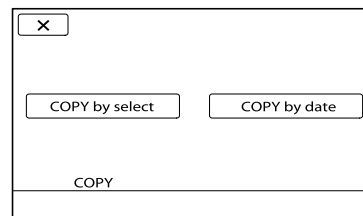

2 Touch the type of copying.

[COPY by select]: To copy selected photos

[COPY by date]: To copy all photos of a specified date

Using the Playlist of movies

The Playlist is a list showing thumbnails of the movies that you have selected.

The original movies are not changed even if you edit or erase the movies added to the Playlist.

3 Select the photo to be copied.

[COPY by select]: Touch the photo to be copied, and mark with ✓. You can select multiple photos.

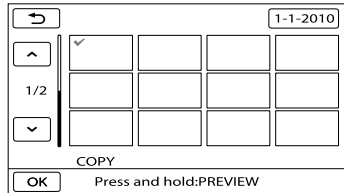

- Press and hold the image down on the screen to confirm the image. Touch to return to the previous screen.

[COPY by date]: Select the recording date of the photo to be copied, then touch . You cannot select multiple dates.

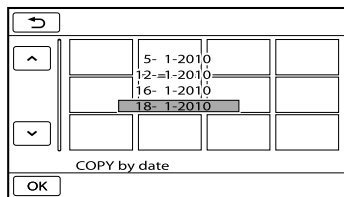

- 4 Touch → [YES] → → .

Tips

- To check the copied photos after copying is finished, select [MEMORY CARD] on [PHOTO MEDIA SET] and play them back (p. 17).

Creating the Playlist

Notes

- High definition image quality (HD) movies and standard definition image quality (STD) movies are added to an individual Playlist.

- 1 Touch (MENU) → [Show others] → [PLAYLIST EDIT] (under [EDIT] category).

- 2 Touch [ADD] or [ADD].

- 3 Touch the movie to be added to the Playlist.

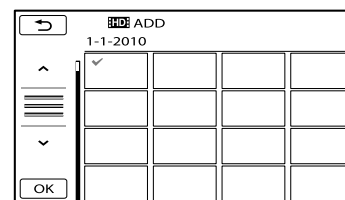

The selected movie is marked with ✓.

- Press and hold the image down on the LCD screen to confirm the image. Touch to return to the previous screen.

- 4 Touch → [YES] → → .

To add all the movies recorded on the same day at one time

- ① In step 2, touch [**HDD** ADD by date]/ [**STD** ADD by date].

The recording dates of movies are displayed on the screen.

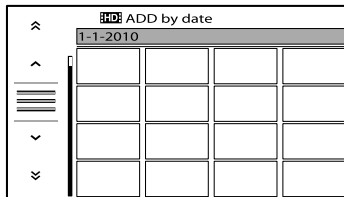

- ② Touch **▲**/**▼** to select the recording date of the desired movie, then touch **OK**.

- Touch the image on the LCD screen to confirm the image. Touch **↶** to return to the previous screen.

- ③ Touch [YES] → **OK** → **X**.

⚡ Notes

- Do not remove the battery pack or the AC Adaptor from your camcorder while adding movies to the Playlist. It may damage the recording media. Also, do not eject the memory card while editing movies on the memory card.
- You cannot add photos to the Playlist.
- You cannot create a Playlist which contains both high definition image quality (HD) movies and standard definition image quality (STD) movies.

💡 Tips

- You can add a maximum of 999 high definition image quality (HD) movies, or 99 standard definition image quality (STD) movies to the Playlist.
- You can add a movie on the playback screen or the Playlist screen by touching **⊕** (OPTION).

Playing the Playlist

- 1 Touch **MENU** (MENU) → [Show others] → [PLAYLIST] (under **▶** [PLAYBACK] category).

Movies added to the Playlist appear.

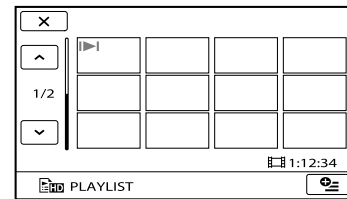

- 2 Touch the movie you want to play back.

The Playlist is played back from the selected movie to the end, then the screen returns to the Playlist screen.

To erase unnecessary movies from the Playlist

- ① Touch **MENU** (MENU) → [Show others] → [PLAYLIST EDIT] (under **✎** [EDIT] category).

- ② Touch [**HDD** ERASE]/[**STD** ERASE]. To erase all the movies from the Playlist, touch [**HDD** ERASE ALL]/[**STD** ERASE ALL] → [YES] → [YES] → **OK** → **X**.

- ③ Select the movie to be erased from the list.

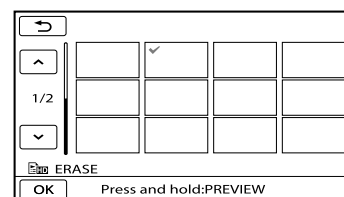

The selected movie is marked with **✓**.

- Press and hold the image down on the LCD screen to confirm the image. Touch **↶** to return to the previous screen.

Using the GPS function (HDR-CX350VE/ XR350VE)

- ④ Touch **OK** → [YES] → **OK** → **X**.

Tips

- Even if you erase a movie from a Playlist, the original movie is not deleted.

To change the order within the Playlist

- ① Touch **MENU** (MENU) → [Show others] → [PLAYLIST EDIT] (under [EDIT] category).
- ② Touch [**MOVE** MOVE]/[**STD** MOVE].
- ③ Select the movie to be moved.

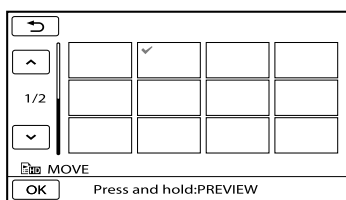

The selected movie is marked with ✓.

- Touch the image on the LCD screen to confirm the image. Touch to return to the previous screen.

- ④ Touch **OK**.
- ⑤ Select the destination with / .

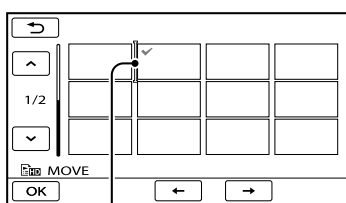

Destination bar

- ⑥ Touch **OK** → [YES] → **OK** → **X**.

Tips

- When you select multiple movies, the movies are moved following the order appearing in the Playlist.

What is GPS?

The GPS (Global Positioning System) is a system that calculates geographical location from highly accurate US space satellites. This system allows you to pinpoint your exact location on the earth.

The following function is available if you use the GPS function.

- Your location
You can display the current location on a map.
- Map Index
You can find a movie or photo on a map by its recording location.
- COORDINATES
You can display the coordinate information during playback.
- AUTO CLOCK ADJ/AUTO AREA ADJ
Your camcorder adjusts the clock and the time difference on each area automatically.

When you conduct the following operations for the first time, a message appears to confirm whether you assent with the license agreement of the map data.

- Touch (YOUR LOCATION) on the recording screen.
- Touch → [MAP] on the playback screen.

You can use the map data by touching [YES] on the screen after assenting to the supplied license agreement.





You cannot use the map data when you touch [NO]. However, when you conduct the above operations for the second time, the same message will appear on the screen, and you can use the map data by touching [YES].



Setting the GPS function

Set the GPS switch to ON ( appears on the LCD screen). Your camcorder starts trying to triangulate. When your camcorder triangulates successfully, it will record the location information at the time movies and photos were recorded.

Notes



- Use the GPS function in outdoors. The camcorder may not be able to receive radio signals in places where radio signals are blocked or reflected, such as indoors or a place surrounded by buildings or trees.
- The indicator changes according to the strength of GPS signal reception.

Triangulating status	GPS indicators	GPS reception status
Function off	No indicator	The GPS switch is set to OFF, or the GPS receiver is not functioning normally.
Unable to triangulate		Your camcorder cannot find a GPS signal, therefore, it cannot triangulate. Move to an open area and turn on the GPS switch again.
Processing		Your camcorder is searching for a GPS satellite signal. It may take several minutes to complete the triangulation.
Triangulating		Your camcorder is receiving a GPS signal, and can acquire location information.
Triangulating		Your camcorder is receiving a strong GPS signal, and can acquire location information.

- The GPS switch is set to ON in the default setting. Movies and photos will be recorded with location information. When your camcorder cannot acquire the location information, the last acquired location information is recorded. If you do not want to record location information, set the GPS switch to OFF.
- If the camcorder cannot track a satellite even after waiting for several minutes, you are in a difficult place to receive a GPS signal. Start recording in the current state or move to a place that is easier receive radio signals.
- Even if the camcorder is turned off, the GPS function is working as long as the GPS switch is set to ON. Make sure that the GPS switch is set to OFF during takeoff and landing of an airplane.
- The dots in the lower right of  show GPS signal quantity. When fewer than 3 dots are displayed, the GPS signal is not stable enough to triangulate in the current environment. Move to an open area first, and turn the GPS switch to OFF and ON again, or turn the power of your camcorder off and on.
- When search of satellite signal is unsuccessful after a few minutes of searching, your camcorder quits searching for a satellite signal. If your camcorder continues to display  (triangulation process not started) even after moved to an open area, turn the GPS switch to OFF and ON again, or turn the power of your camcorder off and on.
- Processing time can be shortened by entering GPS assist data in the “GPS Support Tool” that is installed together with the supplied software “PMB”.
To start “GPS Support Tool” Click [Start] → [All Programs] → [PMB] → [PMB Launcher] → [GPS] → [GPS Support Tool]. See the “GPS Support Tool” help on the operation.

Acquiring the current location information

You can display the current location on a map. Set the GPS switch to ON so that your camcorder can acquire the current location information.

Touch  () on the recording screen.



The current location is displayed and marked at the center of the LCD screen. If you touch a certain point on the screen, the map shows the area with that point at the center.

Touch  (your location) at the bottom left of the LCD screen to move the current location back to the center.

To close the map screen



Touch .

Notes

- The map always displays the north at the top.

Tips

- You can change the scale using the zoom lever (W: larger, T: smaller).
- Your camcorder acquires the current location information every 10 seconds. The displays of the center marker, etc., appear differently according to the status of the current inquiry.
- To display the current location on a map, touch the  on the screen during triangulation. When triangulation is unsuccessful, the map shows the default setting location or a location acquired previously.

- If you hold a certain point, the map keeps scrolling.
- You can also display the current location by touching  (MENU) → [Show others] → [] (under  [OTHERS] category).



Searching for a desired scene by recording location (Map Index)

Where movies and photos were recorded is marked on a map. You can select a movie or photo by recording location.

- You can use the Map Index only with movies and photos having location information that was recorded with the GPS switch set to ON.
- You cannot use the Map Index with photos recorded on memory card.

1 Press  (VIEW IMAGES).

The VISUAL INDEX screen appears.

2 Touch  → [MAP].

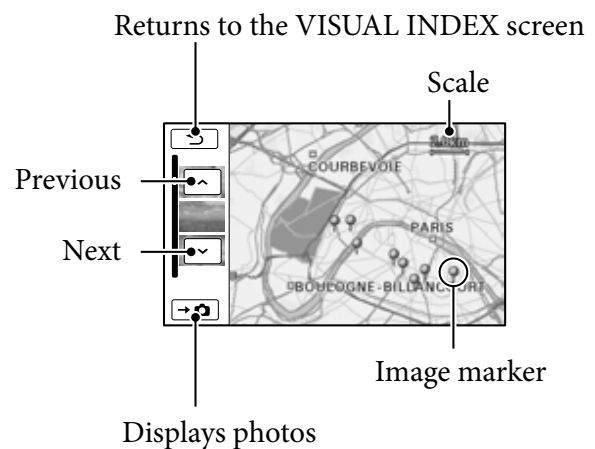

- You can change the scale using the zoom lever (W: larger, T: smaller).
- The point you touch on the map scrolls to the center automatically. If you hold a certain point, the map keeps scrolling.
-  will appear at the upper right corner of the thumbnail of the movie or photo without location information.

- 3** Touch the image marker where you recorded the movies and photos to be played back.

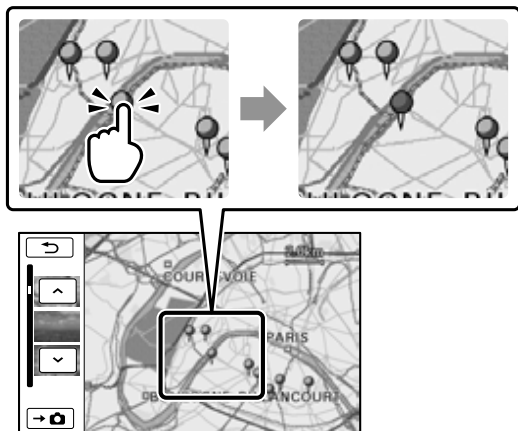

The image marker turns red. The movies or photos recorded at that location are displayed on the left of the screen.

- 4** Touch the desired movie or photo.

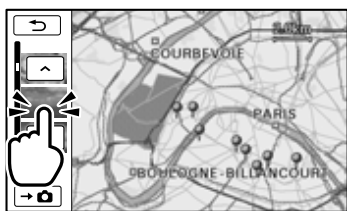

Playback starts from the selected scene.

⚡ Notes

- The map always displays the north at the top.
- When you record several movies and photos at the same location, the movie or photo recorded most recently will be displayed on the LCD screen.

💡 Tips

- You can also display the Map Index by touching **MENU** (MENU) → [Show others] → [VIEW IMAGES] (under **▶** [PLAYBACK] category) → **[MAP]**.
- You can also search for the thumbnail of the movie or photo you want to play by touching **▲**/**▼** in step 3. The recording location of the movie or photo will be displayed at the center of the map.

Displaying the coordinate information (COORDINATES)

During playback, your camcorder can display the coordinates information recorded on movies and photos.

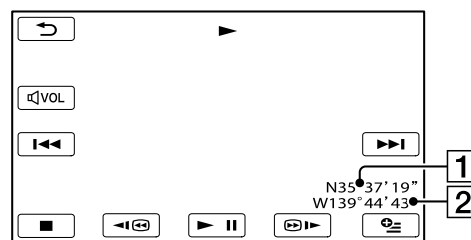

Touch **MENU** (MENU) → [Show others] → [DATA CODE] (under **▶** [PLAYBACK] category) → [COORDINATES] → **OK** → **X**.



- 1** Latitude
2 Longitude

Adjusting the clock and the area automatically (AUTO CLOCK ADJ/ AUTO AREA ADJ)

Your camcorder can maintain accurate time and compensate for time difference automatically, by acquiring time and location information from GPS.

1 Touch **MENU** (MENU) → [Show others] → [CLOCK/ LANG] (under  [GENERAL SET] category) → [AUTO CLOCK ADJ]/[AUTO AREA ADJ].

2 Touch a desired setting → **OK** → **X**.

Notes

- You must set the date and time on your camcorder before using your camcorder (p. 15).
- There may be discrepancies of a few seconds even if [AUTO CLOCK ADJ] is activated.
- The clock is adjusted automatically by [AUTO CLOCK ADJ] when you turn off your camcorder if the camcorder is receiving a GPS signal while it is being used. The clock is not adjusted until the camcorder is turned off. Also, the clock is not adjusted unless the camcorder is receiving a GPS signal, even if the GPS switch is set to ON.
- The [AUTO AREA ADJ] function automatically compensates for a time difference when it detects a time differences with the current area.
- The clock may not be adjusted to the correct time automatically, depending on the country/region selected for your camcorder. In this case, set [AUTO CLOCK ADJ] and [AUTO AREA ADJ] to [OFF].

Saving images in external media

(DIRECT COPY)

You can save movies and photos on external media (USB storage device), such as an external hard disk drive. You can also play back images on the camcorder or another playback device.

⚡ Notes

- For this operation, you need the USB Adaptor Cable VMC-UAM1 (sold separately).
- The USB Adaptor Cable VMC-UAM1 may not be available in some countries/regions.
- You cannot use the following devices as an external media.
 - media with a capacity exceeding 2 TB
 - ordinary disc drive such as CD or DVD drive
 - media connected via USB hub
 - media with built-in USB hub
 - card reader
- You may not be able to use external media with a code function.
- FAT file system is available for your camcorder. If the external media was formatted to NTFS file system, etc., format the external media on your camcorder before use. The format screen appears when the external media is connected to your camcorder.
- Operation is not assured with every device satisfying requirements for operating.
- Connect your camcorder to the wall outlet (wall socket) using the supplied AC adaptor (p. 14).
- Refer to the instruction manual supplied with the external media.
- For details on available external media, go to the Sony support website in your country/region.

1 Connect the AC Adaptor and the power cord (mains lead) to the DC IN jack of your camcorder and the wall outlet (wall socket).

2 If the external media has the AC power cable, connect it to the wall outlet (wall socket).

3 Connect the USB Adaptor Cable to the external media.

4 Connect the USB Adaptor Cable to the Ψ (USB) jack of your camcorder.

When the [Create a new Image Database File.] screen appears, touch [YES].

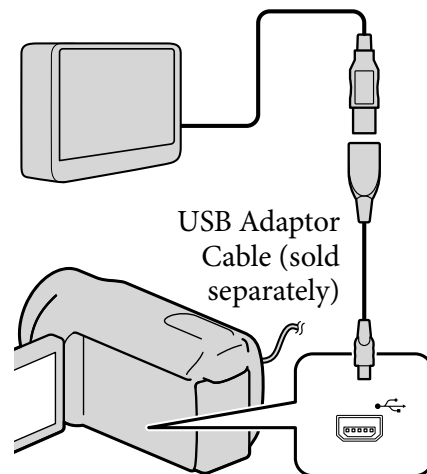

5 Touch [Copy.] on the camcorder screen.

Movies and photos in the internal recording media of the camcorder that have not yet been saved on to external media can be saved.

- This screen will appear only when there are newly recorded images.

6 After the operation is completed, touch **OK** on the camcorder screen.

⚡ Notes

- The number of scenes you can save on the external media are as follows. However, even if the external media has free space, you cannot save scenes exceeding the following number.
High definition image quality (HD) movies: Max. 3,999
Standard definition image quality (STD) movies: 9,999
Photos: 9,999 frames × 899 folders
The number of scenes may be smaller depending on the type of images recorded.

When connecting an external media

The images saved in the external media are displayed on the LCD screen. The movie display and photo display buttons on the VISUAL INDEX screen change as illustrated below.

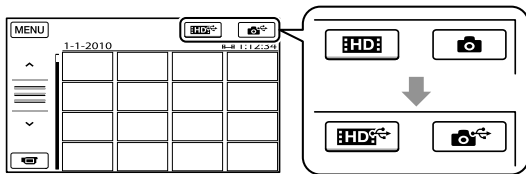

You can make menu settings of the external media such as deleting images. Touch **MENU** (MENU) → [Show others] on the VISUAL INDEX screen.

To save desired movies and photos

⚡ Notes

- You cannot copy or search photos by date which are recorded on the memory card.

① Touch [Play without copying.] in step 5 above.

The VISUAL INDEX screen of the external media is displayed.

- Touch **MENU** (MENU) → [Show others] → [MOVIE DUB] (when selecting movies)/[PHOTO COPY] (when selecting photos).
- Follow the on-screen instructions to select the recording media and image selection methods.
- When you selected [DUB by select], touch the image to be saved.
 - ✓ appears.
 - When you selected [DUB by date], select the date of the images to be dubbed with **^** / **v**, then touch **OK** and go to step ⑤.

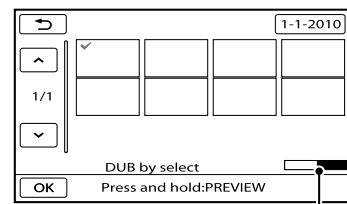

Remaining external media capacity

- Press and hold the image down on the LCD screen to confirm the image. Touch **↶** to return to the previous screen.
 - By touching date, you can search for images by date.
- ⑤ Touch **OK** → [YES] → **OK** on the camcorder screen.

To play back images in the external media on the camcorder

① Touch [Play without copying.] in step 5 above.

The VISUAL INDEX screen of the external media is displayed.

- Play back the image (p. 28).
 - You can also view images on a TV connected to your camcorder (p. 36).
 - You can play back the high definition image quality (HD) movies on your computer using [Player for AVCHD]. Start [Player for AVCHD], and select the drive

Creating a disc with a DVD writer, recorder

where the external media is connected with [Settings].

⚡ Notes

- The Date Index and Map Index (HDR-CX350VE/XR350VE) of photos cannot be displayed.
- If your camcorder does not recognize the external media, try the following operations.
 - Reconnect the USB Adaptor Cable to your camcorder
 - If the external media has the AC power cable, connect it to the wall outlet (wall socket)

To finish the external media connection



- ① Touch  on the VISUAL INDEX screen of the external media.
- ② Disconnect the USB Adaptor Cable.

Selecting the method for creating a disc

Several methods for creating an AVCHD disc or a standard definition image quality (STD) disc from high definition image quality (HD) movies or photos recorded on your camcorder are described here. Select the method that suits your disc player.

⚡ Notes

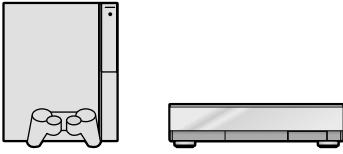
- Prepare a DVD disc such as a DVD-R, for creating a disc.
- See page 52 to save images in the external media.

AVCHD format compatible device
Player <ul style="list-style-type: none">• Sony Blu-ray disc player• PlayStation[®] 3, etc. 
Creating device <ul style="list-style-type: none">• DVD writer, DVDDirect Express (p. 55)• DVD writer, etc., other than DVDDirect Express (p. 58)
Disc type <ul style="list-style-type: none">• AVCHD disc (high definition image quality (HD)) 

Ordinary DVD device

Player

- DVD player
- Computer that can play DVDs, etc.

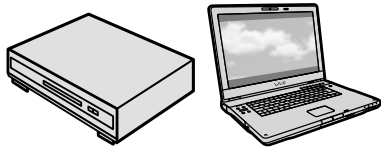

Creating device

- DVD writer, DVDirect Express (p. 55)
- DVD writer, other than DVDirect Express (p. 58)
- Disc recorder, etc. (p. 59)

Disc type

- Standard definition image quality (STD) disc



⚡ Notes

- Always maintain your PlayStation®3 to use the latest version of the PlayStation®3 system software.
- The PlayStation®3 may not be available in some countries/regions.
- Delete the demonstration movie when dubbing or creating discs. If it is not deleted, the camcorder may not operate correctly. However, you cannot recover the demonstration movie once you delete it.
- The AVCHD disc can be played back only on AVCHD format compatible devices.
- The AVCHD disc should not be used in DVD players/recorders. Because DVD players/recorders are not compatible with the AVCHD format, DVD players/recorders may fail to eject the disc.
- You cannot create an AVCHD disc from a movie recorded with [HD FX] mode of [REC MODE]. Save a movie recorded with [HD FX] mode onto Blu-ray discs or external storage devices (p. 52).

Creating a disc with the dedicated DVD writer, DVDirect Express

You can create a disc or play back the images on a created disc by using the dedicated DVD writer, DVDirect Express (sold separately).

Refer also to the instruction manual supplied with the DVD writer.

⚡ Notes

- Connect your camcorder to the wall outlet (wall socket) using the supplied AC Adaptor for this operation (p. 14).
- Only unused discs of the following types can be used:
 - 12cm DVD-R
 - 12cm DVD+R
- The device does not support two-layered discs.
- DVDirect Express is referred to as “DVD writer” in this section.

1 Connect the AC Adaptor and the power cord (mains lead) to the DC IN jack of your camcorder and the wall outlet (wall socket) (p. 14).

2 Turn on your camcorder, and connect the DVD writer to the USB (USB) jack of your camcorder with the USB cable of the DVD writer.

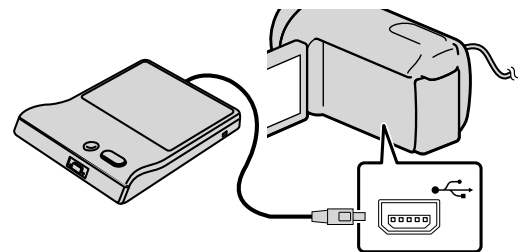

-
- 3** Insert an unused disc into the DVD writer, and close the disc tray.

The [DISC BURN] screen appears on the camcorder screen.

- 4** Press **DISC BURN** on the DVD writer.

Movies recorded on the internal recording media that have not been saved on any discs will be recorded onto the disc.

- When there are unsaved high definition (HD) and standard definition (STD) image quality movies, they will be saved on individual discs according to the image quality.
-

- 5** Repeat steps 3 and 4 when the total memory size of movies to be burnt exceeds that of the disc.
-

- 6** Touch **OK** → [END] → [EJECT DISC] on the camcorder screen.

Remove the disc after the operation is completed.

- 7** Touch **OK**, then disconnect the USB cable.
-

To customize a disc with DISC BURN OPTION

Perform this operation in the following cases:

- When dubbing a desired image
- When creating multiple copies of the same disc
- When converting high definition (HD) movies to standard definition (STD) movies, and creating a disc
- When dubbing images in the memory card

- ① Touch [DISC BURN OPTION] in step 4.

- ② Select the recording media containing the movie(s) you want to save.

When you select movies with high definition image quality (HD), the screen to select the image quality of the disc to be created appears on the LCD screen. Select the desired image quality, and touch **OK**.

- The image quality of the disc depends on the recording time of the selected movies when you create a disc converting them from high definition image quality (HD) to standard definition image quality (STD).

- ③ Touch the movie you want to burn on the disc.

✓ appears.

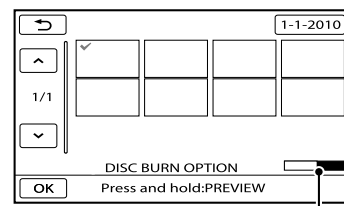

Remaining Disc capacity

- Press and hold the image down on the LCD screen to confirm the image. Touch **DISC BURN** to return to the previous screen.
- By touching date, you can search for images by date.

- ④ Touch **OK** → [YES] on the camcorder screen.
 - To create another disc of the same contents, insert a new disc and touch [CREATE SAME DISC].
- ⑤ After the operation is completed, touch [EXIT] → [END] on the camcorder screen.
- ⑥ Disconnect the USB cable from your camcorder.

⚡ Notes

- Do not do any of the following when creating a disc.
 - Turn off the camcorder
 - Disconnect the USB cable or the AC adaptor
 - Subject the camcorder to mechanical shock or vibration
 - Eject the memory card from the camcorder
- Play the created disc to make sure dubbing was performed correctly before deleting the movies on your camcorder.
- If [Failed.] or [DISC BURN failed.] appears on the screen, insert another disc into the DVD writer and perform the DISC BURN operation again.

💡 Tips

- If the total memory size of movies to be burnt by the DISC BURN operation exceeds that of the disc, disc creation stops when the limit is reached. The last movie on the disc may be cut off.
- Disc creation time to dub movies to the limit of the disc is about 20 to 60 minutes. It may take more time depending on the recording mode or the number of scenes. Also, if high definition image quality (HD) is converted to standard definition image quality (STD), image quality conversion takes longer than the actual recording.

To play back a disc on the DVD writer

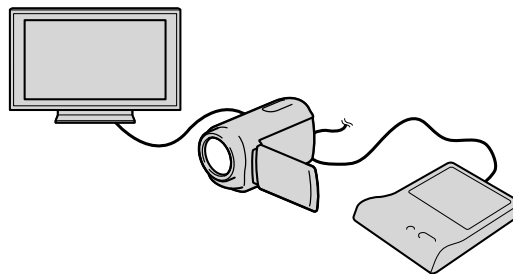

- ① Connect the AC Adaptor and the power cord (mains lead) to the DC IN jack of your camcorder and the wall outlet (wall socket) (p. 14).
- ② Turn on your camcorder, and connect the DVD writer to the Ψ (USB) jack of your camcorder with the USB cable of the DVD writer.
 - You can play back movies on the TV screen by connecting the camcorder to a TV (p. 36).
- ③ Insert a created disc into the DVD writer.

The movies on the disc appear as VISUAL INDEX on the camcorder screen.
- ④ Press the play button on the DVD writer.
 - You can also operate by the camcorder screen.
- ⑤ Touch [END] → [EJECT DISC] on the camcorder screen and remove the disc after the operation is completed.
- ⑥ Touch **OK** and disconnect the USB cable.

To play back a disc on the ordinary DVD player

Select the standard image quality (STD) on the screen to select the image quality of the disc to be created in step 2 of “To customize a disc with DISC BURN OPTION.”

Tips

- If you cannot play back created standard definition (STD) image quality discs on any DVD player, connect the camcorder to the DVD writer, and then play back.

Creating a high definition image quality (HD) disc with a DVD writer, etc., other than DVDirect Express

Use USB cable to connect your camcorder to a disc creation device, which is compatible with high definition image quality (HD) movies, such as a Sony DVD writer. Refer also to the instruction manuals supplied with the device to be connected.

Notes

- Connect your camcorder to the wall outlet (wall socket) using the supplied AC Adaptor for this operation (p. 14).
- Sony DVD writer may not be available in some countries/regions.

1 Connect the AC Adaptor and the power cord (mains lead) to the DC IN jack of your camcorder and the wall outlet (wall socket) (p. 14).

2 Turn on your camcorder, and connect a DVD writer, etc. to the  (USB) jack of your camcorder with the USB cable (supplied).

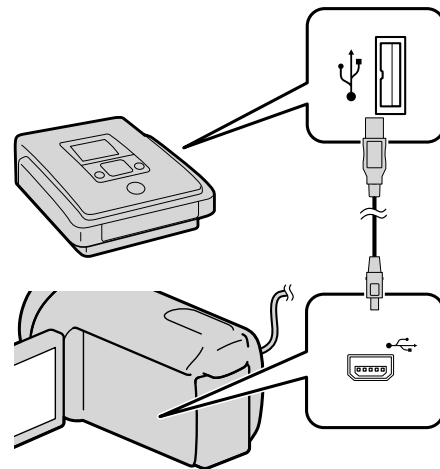

The [USB SELECT] screen appears on the camcorder screen.

- If the [USB SELECT] screen does not appear, touch **MENU** (MENU) → [Show others] → [USB CONNECT] (under  [OTHERS] category).

3 Touch the recording media that contains the images on the camcorder screen.

[ USB CONNECT]: Internal memory

[ USB CONNECT]: Internal hard disk

[ USB CONNECT]: Memory card

- The displayed recording media differ depending on the model.

4 Record movies on the connected device.

- For details, refer to the instruction manuals supplied with the device to be connected.

5 After the operation is completed, touch [END] → [YES] on the camcorder screen.

6 Disconnect the USB cable.

Creating a standard definition image quality (STD) disc with a recorder, etc.

You can dub images played back on your camcorder on a disc or video cassette, by connecting your camcorder to a disc recorder, a Sony DVD writer, etc., other than DVDirect Express, with the A/V connecting cable. Connect the device in either way of **1** or **2**. Refer also to the instruction manuals supplied with the devices to be connected.

⚡ Notes

- Connect your camcorder to the wall outlet (wall socket) using the supplied AC Adaptor for this operation (p. 14).
- Sony DVD writer may not be available in some countries/regions.
- High definition image quality (HD) movies will be dubbed with standard definition image quality (STD).

1 A/V connecting cable (supplied)

Connect the A/V connecting cable to the input jack of another device.

2 A/V connecting cable with S VIDEO (sold separately)

When connecting to another device via the S VIDEO jack, by using an A/V connecting cable with an S VIDEO cable (sold separately), higher quality images can be produced than with an A/V connecting cable. Connect the white and red plug (left/right audio) and the S VIDEO plug (S VIDEO channel) of the A/V connecting cable with an S VIDEO cable. If you connect the S VIDEO plug only, you will hear no sound. The yellow plug (video) connection is not necessary.

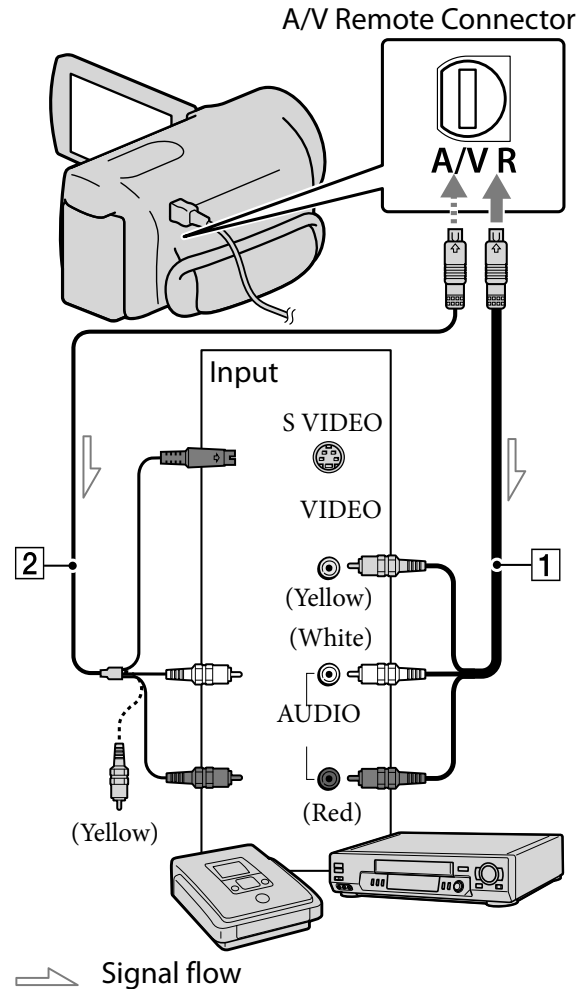

1 Insert the recording media in the recording device.

- If your recording device has an input selector, set it to the input mode.

2 Connect your camcorder to the recording device (a disc recorder, etc.) with the A/V connecting cable **1** (supplied) or an A/V connecting cable with S VIDEO **2** (sold separately).

- Connect your camcorder to the input jacks of the recording device.









3 Start playback on your camcorder, and record it on the recording device.

- Refer to the instruction manuals supplied with your recording device for details.
-

4 When dubbing is finished, stop the recording device, and then your camcorder.

- When you connect a monaural device, connect the yellow plug of the A/V connecting cable to the video input jack, and the white (left channel) or the red (right channel) plug to the audio input jack on the device.

Notes

- Since dubbing is performed via analog data transfer, the image quality may deteriorate.
- You cannot dub images to recorders connected with an HDMI cable.
- To hide the screen indicators (such as a counter, etc.) on the screen of the monitor device connected, touch **MENU** (MENU) → [Show others] → [OUTPUT SETTINGS] (under  [GENERAL SET] category) → [DISP OUTPUT] → [LCD PANEL] (the default setting) → **OK** →  → **X**.
- To record the date/time, coordinates (HDR-CX350VE/XR350VE), or camera settings data, touch **MENU** (MENU) → [Show others] → [PLAYBACK SET] (under  [PLAYBACK] category) → [DATA CODE] → a desired setting → **OK** →  → **X**. In addition, touch **MENU** (MENU) → [Show others] → [OUTPUT SETTINGS] (under  [GENERAL SET] category) → [DISP OUTPUT] → [V-OUT/PANEL] → **OK** →  → **X**.
- When the screen size of display devices (TV, etc.) is 4:3, touch **MENU** (MENU) → [Show others] → [OUTPUT SETTINGS] (under  [GENERAL SET] category) → [TV TYPE] → [4:3] → **OK** →  → **X**.

Using menus

Using the menu, you can perform useful functions and change various settings. If you make good use of menu operations, you can enjoy using your camcorder.

The camcorder has various menu items under each of eight menu categories.

M **MANUAL SETTINGS** (Items to adjust for scene condition) → p. 66

SHOOTING SET (Items for customized shooting) → p. 71

PHOTO SETTINGS (Items for recording photos) → p. 74

PLAYBACK (Items for playback) → p. 76

EDIT (Items for editing) → p. 78

OTHERS (Items for other settings) → p. 78

MANAGE MEDIA (Items for recording media) → p. 79

GENERAL SET (Other setup items) → p. 80

Operating menu

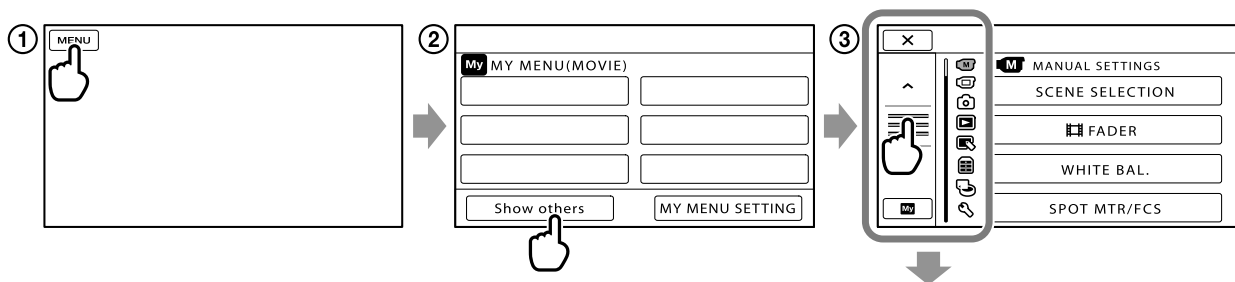

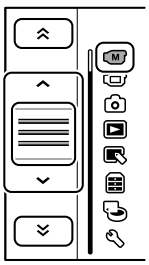

- ▲ / ▼ : The menu list moves from category to category.
- ▲ / ▼ : The menu list moves through 4 items at once.
- You can touch buttons and drag the screen to scroll the list of the menu.
- The selected category icon is displayed in orange.
- When you touch **My**, the screen returns to the MY MENU screen.

① Touch **MENU** (MENU).

② Touch [Show others] on the MY MENU screen.

- See the next page for details on MY MENU.

③ Touch the central part of the left side of screen to change the display.

④ Touch the menu item to be changed.

⑤ After changing the setting, touch **OK**.

To finish setting the menu, touch **X**.

To return to the previous menu screen, touch **↶**.

- **OK** may not be displayed depending on the menu item.

⚡ Notes

- You may not be able to set some menu items, depending on the recording or playback conditions.
- Grayed out menu items or settings are not available.

💡 Tips

- Depending on the menu items being changed, your camcorder switches between playback mode and recording mode (movie/photo).

Using MY MENU

You can use the menu items more easily by registering the menu items you use most often on MY MENU. You can register 6 menu items on each MY MENU of the MOVIE, PHOTO, and PLAYBACK.

Example: deleting [SPOT MTR/FCS] and registering [FADER]

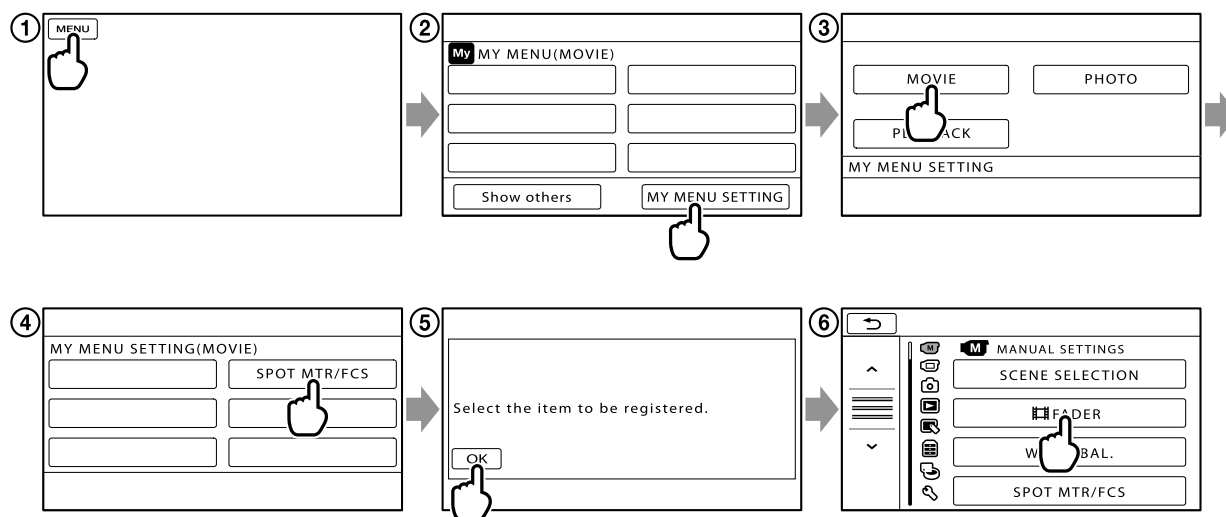



- ① Touch **MENU** (MENU).
- ② Touch [MY MENU SETTING].
- ③ Touch [MOVIE].
- ④ Touch [SPOT MTR/FCS].
- ⑤ Touch **OK**.
- ⑥ Touch [FADER] (under **M** [MANUAL SETTINGS] category).
- ⑦ When MY MENU is displayed, touch **×**.

Repeat the same steps above to register menu items on MY MENU, and enjoy using your “Handycam.”



💡 Tips

- When an external storage device is connected, the exclusive MY MENU appears.

Using the OPTION MENU

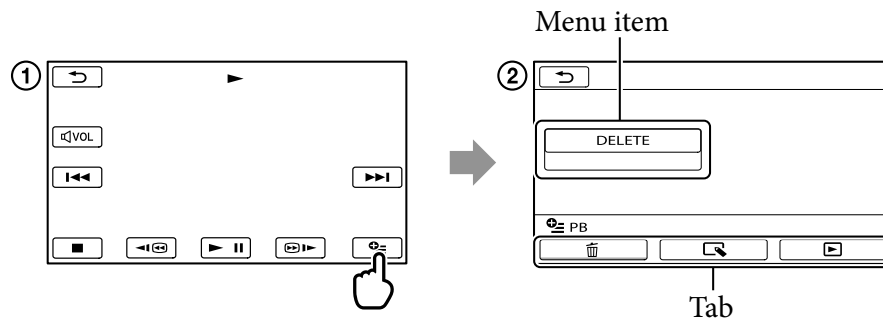
The OPTION MENU appears just like the pop-up window that appears when you right-click the mouse on a computer. When  is displayed at bottom-right of the screen, you can use the OPTION MENU. You touch , and the menu items you can change in the context appear.



- ① Touch  (OPTION).
- ② Touch the desired tab → the item to change the setting.
- ③ After completing the setting, touch .

Notes







- Grayed out menu items or settings are not available.
- When the item you want is not on the screen, touch another tab. (There may be no tab.)
- The tabs and items that appear on the screen depend on the recording/playback status of your camcorder at the time.

Menu lists



(MANUAL SETTINGS) category

SCENE SELECTION	66
 FADER	66
WHITE BAL.	67
SPOT MTR/FCS	68
SPOT METER	68
SPOT FOCUS	68
EXPOSURE	68
FOCUS	69
TELE MACRO	69
GOLF SHOT	69
SMTH SLW REC	70







(SHOOTING SET) category

 HDMI / STD SET	25
 REC MODE	25
GUIDEFAME	71
 STEADYSHOT	71
CONVERSION LENS	71
LOW LUX	72
FACE DETECTION	72
PRIORITY SETTING	72
SMILE DETECTION	72
SMILE SENSITIVITY	73
AUDIO REC SET	
BLT-IN ZOOM MIC	73
MICREF LEVEL	73
OTHER REC SET	
 DIGITAL ZOOM	73
AUTO BACK LIGHT	73
 X.V.COLOR	74
 WIDE SELECT	74













(PHOTO SETTINGS) category

 SELF-TIMER	74
 IMAGE SIZE	74
 STEADYSHOT	75
FLASH MODE	75
FLASH LEVEL	75
REDEYE REDUC	75
FILE NO.	76

(PLAYBACK) category

VISUAL INDEX	28
VIEW IMAGES	
DATE INDEX	31
 MAP*1	49
 FILM ROLL	31
 FACE	32
PLAYLIST	46
 HIGHLIGHT	32
 SCENARIO	33
PLAYBACK SET	
 HDMI / STD SET	25
DATA CODE	76

(EDIT) category

DELETE	
 DELETE	39
 DELETE	39
 SCENARIO ERASE	
ERASE	34
ERASE ALL	34
PROTECT	
 PROTECT	40
 PROTECT	40
 DIVIDE	41
PHOTO CAPTURE	42
MOVIE DUB	
DUB by select	44
DUB by date	44
 HDMI DUB ALL / STD DUB ALL	44
PHOTO COPY	
COPY by select	44
COPY by date	44
PLAYLIST EDIT	
 HDMI ADD / STD ADD	45
 HDMI ADD by date / STD ADD by date	46
 HDMI ERASE / STD ERASE	46
 HDMI ERASE ALL / STD ERASE ALL	46
 HDMI MOVE / STD MOVE	47



(OTHERS) category

YOUR LOCATION* ¹	49
USB CONNECT	
USB CONNECT* ²	58
USB CONNECT* ³	58
USB CONNECT	58
DISC BURN	Operating Guide
TV CONNECT Guide	36
MUSIC TOOL * ⁴	
EMPTY MUSIC	34
DOWNLOAD MUSIC	34
BATTERY INFO	78



(MANAGE MEDIA) category

MEDIA SETTINGS	
MOVIE MEDIA SET	17
PHOTO MEDIA SET	17
MEDIA INFO	79
MEDIA FORMAT	
INT. MEMORY* ²	79
HDD* ³	79
MEMORY CARD	79
REPAIR IMG.DB F.	
INT. MEMORY* ²	89, 94
HDD* ³	89, 94
MEMORY CARD	89, 94



(GENERAL SET) category

SOUND/DISP SET	
VOLUME	30, 80
BEEP	80
LCD BRIGHT	80
LCD BL LEVEL	80
LCD COLOR	81
DISPLAY SET	81
OUTPUT SETTINGS	
TV TYPE	81
COMPONENT	82
HDMI RESOLUTION	82
DISP OUTPUT	82

CLOCK/ LANG

CLOCK SET	15
AREA SET	82
AUTO CLOCK ADJ* ¹	51
AUTO AREA ADJ* ¹	51
SUMMERTIME	83
LANGUAGE SET	83
POWER SETTINGS	
A.SHUT OFF	83
POWER ON BY LCD	83
OTHER SETTINGS	
DEMO MODE	83
CALIBRATION	108
CTRL FOR HDMI	84
DROP SENSOR* ³	84
REC LAMP	84
REMOTE CTRL	84

*¹ HDR-CX350VE/XR350VE

*² HDR-CX300E/CX305E/CX350E/CX350VE/
CX370E

*³ HDR-XR350E/XR350VE

*⁴ HDR-CX300E/CX350E/CX350VE/CX370E/
XR350E/XR350VE

MANUAL SETTINGS

(Items to adjust for scene condition)

See “Using menus” (p. 61) on the operation. The default settings are marked with ►.

SCENE SELECTION

You can record images effectively in various situations.

► AUTO

Records images in average image quality without the [SCENE SELECTION] function.

TWILIGHT* (☾)

Maintains the darkening atmosphere of the distant surroundings in twilight scenes.



TWILIGHT PORT. (👤)

Enables to take photos of people and background using a flash.



SUNRISE&SUNSET* (☀)

Reproduces the atmosphere of scenes such as sunsets or sunrises.



FIREWORKS* (💣)

Takes spectacular shots of fireworks.



LANDSCAPE* (🏞)

Shoots distant subjects clearly. This setting also prevents your camcorder from focusing on glass or metal mesh in windows between the camcorder and the subject.

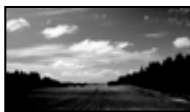

PORTRAIT (Soft portrait)



Brings out the subject such as people or flowers while creating a soft background.



SPOTLIGHT** (👤)

Prevents people's faces from appearing excessively white when subjects are lit by strong light.



BEACH** (🏖)

Takes the vivid blue of the ocean or a lake.



SNOW** (❄)

Takes bright pictures of a white landscape.



* Adjusted to focus on subjects farther away only.

** Adjusted not to focus on subjects a short distance away.

Notes

- Even if you set [TWILIGHT PORT.], the setting changes to [AUTO] in movie recording mode.
- If you set [SCENE SELECTION], [WHITE BAL.] setting is canceled.

FADER

You can record a transition with the following effects adding to the interval between scenes.

Select the desired effect in [STBY] (to fading in) or [REC] (to fading out) mode.

► OFF

Does not use an effect.

WHITE FADER

Fades in/out with the white effect.



BLACK FADER

Fades in/out with the black effect.



To cancel the fader before starting the operation, touch [OFF].

Tips

- When you press START/STOP, the setting is cleared.
- A movie recorded using [BLACK FADER] may be difficult to see in the VISUAL INDEX screen.

WHITE BAL. (White balance)



You can adjust the color balance to the brightness of the recording environment.



▶ AUTO

The white balance is adjusted automatically.

OUTDOOR (☀)

The white balance is appropriately adjusted for the following recording conditions:

- Outdoors
- Night views, neon signs and fireworks
- Sunrise or sunset
- Under daylight fluorescent lamps

INDOOR (☾)

The white balance is appropriately adjusted for the following recording conditions:

- Indoors
- At party scenes or studios where the lighting conditions change quickly
- Under video lamps in a studio, or under sodium lamps or incandescent-like color lamps

ONE PUSH (⏻)

The white balance will be adjusted according to the ambient light.

- ① Touch [ONE PUSH].
- ② Frame a white object such as a piece of paper, to fill the screen under the same lighting conditions as you will shoot the subject.
- ③ Touch [⏻].
⏻ flashes quickly. When the white balance has been adjusted and stored in the memory, the indicator stops flashing.

Notes

- Set [WHITE BAL.] to [AUTO] or adjust the color in [ONE PUSH] under white or cool white fluorescent lamps.
- When you select [ONE PUSH], keep framing white objects while ⏻ is flashing quickly.
- ⏻ flashes slowly if [ONE PUSH] could not be set.
- When [ONE PUSH] was selected, if ⏻ keeps flashing after touching **OK**, set [WHITE BAL.] to [AUTO].
- If you set [WHITE BAL.], [SCENE SELECTION] is set to [AUTO].

Tips

- If you have changed the battery pack while [AUTO] was selected, or taken your camcorder outdoors after inside use (or vice versa), aim your camcorder at a nearby white object for about 10 seconds for better color balance adjustment.
- When the white balance has been set with [ONE PUSH], if the lighting conditions changed by bringing your camcorder outdoors

from inside the house, or vice versa, you need to redo the [ONE PUSH] procedure to readjust the white balance.

SPOT MTR/FCS (Spot meter/focus)

You can adjust the brightness and focus for the selected subject simultaneously. This function enables you to use [SPOT METER] (p. 68) and [SPOT FOCUS] (p. 68) at the same time.

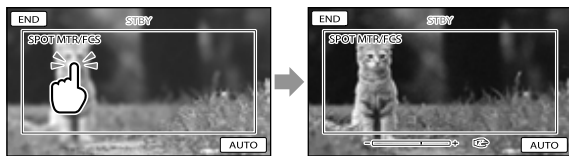

Touch the subject in the frame of which you want to adjust the brightness and focus. To adjust the brightness and focus automatically, touch [AUTO].

Notes

- [EXPOSURE] and [FOCUS] are automatically set to [MANUAL].

SPOT METER (Flexible spot meter)

You can adjust and fix the exposure to the subject, so that it is recorded in suitable brightness even when there is strong contrast between the subject and the background, such as subjects in the spotlight on stage.

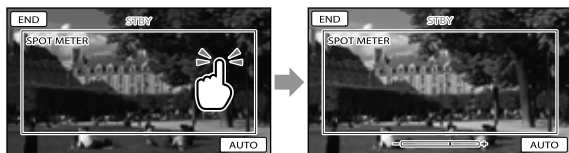

Touch the subject in the frame of which you want to adjust the exposure. To return the setting to automatic exposure,

touch [AUTO].

Notes

- [EXPOSURE] is automatically set to [MANUAL].

SPOT FOCUS

You can select and adjust the focal point to aim it at a subject not located at the center of the screen.

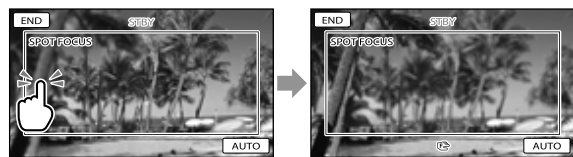

Touch the subject in the frame of which you want to adjust the focus.

To adjust the focus automatically, touch [AUTO].



Notes

- [FOCUS] is automatically set to [MANUAL].

EXPOSURE

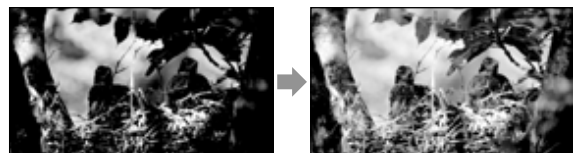
You can fix the brightness of a picture manually. Adjust the brightness when the subject is too bright or too dark.



Touch  /  to adjust the brightness. To adjust the exposure automatically, touch [AUTO].

FOCUS



You can adjust the focus manually. You can select this function also when you want to focus on a certain subject intentionally.



Touch (nearby subject)/ (distant subject) to adjust the focus.

To adjust the focus automatically, touch [AUTO].

⚡ Notes

- When you set [FOCUS] to [MANUAL], appears.
- The minimum possible distance between camcorder and subject while maintaining sharp focus is about 1 cm (about 13/32 in.) for wide angle and about 80 cm (about 31 1/2 in.) for telephoto.

💡 Tips

- appears when the focus cannot be adjusted any closer, and appears when the focus cannot be adjusted farther away.
- It is easier to focus on the subject by moving the power zoom lever towards T (telephoto) to adjust the focus, then towards W (wide angle) to adjust the zoom for recording. When you want to record a subject at close range, move the power zoom lever to W (wide angle), then adjust the focus.
- The focal distance information (distance at which the subject is focused on; used as a guide if it is dark and focus adjustment is difficult) appears for a few seconds in the following cases. (This information will not display correctly if a conversion lens (sold separately) is being used.)
 - When the focus mode is switched from automatic to manual
 - When you set focus manually

TELE MACRO



This is useful to shoot small subjects, such as flowers or insects. You can blur out backgrounds and the subject stands out clearer.

▶ OFF

Cancels TELE MACRO. (TELE MACRO is also canceled when you move the zoom lever to the W side.)

ON (T)

The zoom (p. 24) moves to the top of the T (telephoto) side automatically and allows recording subjects at a close distance down to about 25 cm (about 9 7/8 in.).



⚡ Notes

- When recording a distant subject, focusing may be difficult and can take some time.
- Adjust the focus manually ([FOCUS], p. 69) when it is hard to focus automatically.

GOLF SHOT



Divides 2 seconds of fast movement into frames which are then recorded as a movie and photos. You can view a series of movement when playing back, which is convenient in cases such as checking golf swing or tennis form.

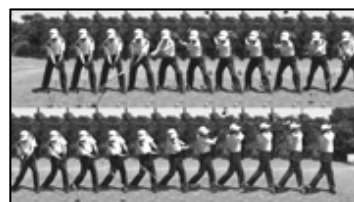

On the [GOLF SHOT] screen, frame the subject in the white guide frame in the center of the screen, then press START/STOP. The 0.5 second point before START/STOP is pressed is assumed as the moment of impact, and the period of 1.5 seconds before and 0.5 second after it (2 seconds total) is recorded. When impact sound is detected, the recording time period is automatically adjusted according to that moment.

⚡ Notes

- The size of photos becomes 1,920 × 1,080.
- You cannot record sound.
- Image quality is not as good as that of normal recording.
- You cannot use [GOLF SHOT] when you set the image quality to standard definition image quality (STD).

💡 Tips

- You can set the self-timer by touching  (OPTION). With [SELF-TIMER] set to [ON], press START/STOP to start countdown of the timer. The point when countdown reaches 0 is assumed as the moment of impact and motion before and after 0 is recorded.
- If camera shake is excessive, or there are moving objects in the background during recording, image analysis will not be performed effectively, and images may contain noise as a result. It is recommended that you record images under stable conditions (for example, using a tripod).
- Impact sound may be detected by the internal microphone even when an external microphone is attached.

SMTH SLW REC (Smooth slow rec)

Fast moving subjects and actions, which cannot be captured under the ordinary shooting conditions, can be shot in smooth moving slow-motion for about 3 seconds. Press START/STOP on the [SMTH SLW REC] screen.

An about-3-second movie is recorded as a 12-second-slow-motion movie. [Recording...] disappears, when recording is finished.

Touch  to cancel the smooth slow recording.

To change the setting

Touch  (OPTION), then select the setting you want to change.

[TIMING]

Select the recording start point after START/STOP is pressed. The default setting is [3sec AFTER].

The point when START/STOP is pressed.

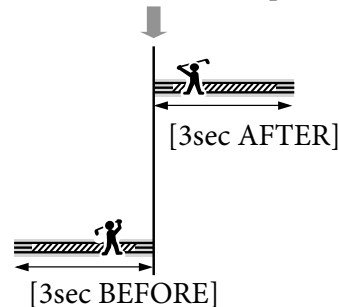

⚡ Notes

- You cannot record sound.
- Image quality is not as good as that of normal recording.

SHOOTING SET

(Items for customized shooting)

See “Using menus” (p. 61) on the operation. The default settings are marked with ►.

HD/STD SET

See page 25.

REC MODE (Recording mode)

See page 25.

GUIDEFAME

You can display the frame and check that the subject is horizontal or vertical. The frame is not recorded.

- OFF
Does not display the guide frame.
- ON
Displays the guide frame.

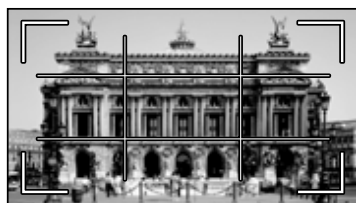

Tips

- Positioning the subject at the cross point of the guide frame makes a balanced composition.
- The outer frame of [GUIDEFAME] shows the display area of a TV which is not compatible with full pixel display.

STEADYSHOT

You can compensate for camera shake. Set [STEADYSHOT] to [OFF] () when using a tripod (sold separately), then the image becomes natural.



- ACTIVE
Provides a more powerful SteadyShot effect.
- STANDARD
Provides the SteadyShot effect under relatively stable recording conditions.
- OFF ()
The SteadyShot function is not used.

Notes

- If you change the setting of [STEADYSHOT], the imaging field will also change accordingly.
- You can magnify images up to 12 times using optical zooming, unless [STEADYSHOT] is set to [ACTIVE].

CONVERSION LENS

When using a conversion lens (sold separately), use this function to record using the optimum compensation for camera shake and focus for the lens.

- OFF
Select this when you do not use a conversion lens.
- WIDE CONVERSION ()
Select this when you use a wide-conversion lens.
- TELE CONVERSION ()
Select this when you use a tele-conversion lens.

Notes

- The built-in flash is not flashed when [CONVERSION LENS] is set to other than [OFF], you cannot also set [FLASH MODE] (p. 75).

LOW LUX

You can record bright color images, even in dim light.

▶ OFF

The LOW LUX function is not used.

ON

The LOW LUX function is used.

FACE DETECTION

Detects the faces of your subjects and adjusts the focus/color/exposure automatically. Also, it adjusts the image quality of face parts more finely, in the case of the high definition image quality (HD) movies.

▶ ON

Detects faces.

OFF

Does not detect faces.

Notes

- Faces may not be detected depending on recording conditions, subject conditions, and the setting of your camcorder.
- [FACE DETECTION] may not function properly depending on recording conditions. Set [FACE DETECTION] to [OFF] in this case.

Tips

- For better face detection performance, shoot the subject(s) under the following conditions:
 - Shoot in a sufficiently bright place
 - The subject(s) does not wear glasses, a hat or mask
 - The subject(s) faces directly towards the camera

- The detected faces are recorded in Face Index, however, some faces may not be. Also, there is a limit to the number of faces that can be recorded in Face Index. To play back from the Face Index, see page 32.

PRIORITY SETTING

Selects the priority subject for the face detection or the smile shutter.

Adjusts focus/color/exposure automatically for the selected faces.

▶ AUTO

Detects faces automatically.

CHILD PRIORITY

Detects with priority on a child's face.

ADULT PRIORITY

Detects with priority on an adult's face.

Tips

- When you specify the priority subject by touching the detection frame on the LCD screen, the face with a double-lined frame has priority (p. 26).

SMILE DETECTION

The shutter is released when the camcorder detects a smile (Smile Shutter).

▶ DUAL CAPTURE

Only during movie recording, the shutter is released automatically, when the camcorder detects a smile.

ALWAYS ON

The shutter is released when the camcorder detects a smile whenever the camcorder is in recording mode.

OFF

Smiles are not detected, so photos are not recorded automatically.

⚡ Notes

- Smiles may not be detected depending on recording conditions, subject conditions, and the setting of your camcorder.
- When [DUAL CAPTURE] is selected, 😊 appears on the screen in movie recording standby, and 😊 changes into 📷 when movie recording starts.

SMILE SENSITIVITY



Sets the smile detection sensitivity using the Smile Shutter function.

HIGH

Detects even a slight smile.

▶ MEDIUM

Detects a normal smile.

LOW

Detects a big smile.

AUDIO REC SET



■ BLT-IN ZOOM MIC (Built-in zoom microphone)

You can record a movie with vivid sound appropriate to the zoom position.

▶ OFF

The microphone does not record sound following zooming in or out.

ON (📶)

The microphone records sound following zooming in or out.

■ MICREF LEVEL (Microphone reference level)

You can select the microphone level for recording sound.

▶ NORMAL

Records various ambient sounds, converting them into the appropriate level.

LOW (⬆️)

Records ambient sound faithfully. Select [LOW] when you want to record an exciting and powerful sound in a concert hall, etc. (This setting is not suitable for recording conversations.)

OTHER REC SET



■ 📷 DIGITAL ZOOM

You can select the maximum zoom level. Note that the image quality decreases when you use the digital zoom.

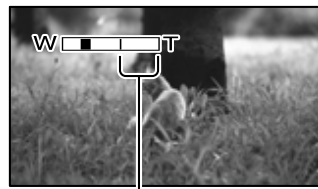

The zooming zone appears when you select [160×].

▶ OFF

Up to 17× zoom is performed.

160×

Up to 160× zoom is performed digitally.

⚡ Notes

- When [📷 STEADYSHOT] is set to other than [ACTIVE], up to 12× zoom is performed optically.

■ AUTO BACK LIGHT

Your camcorder adjusts the exposure for backlit subjects automatically.

▶ ON

Adjusts the exposure for backlit subjects automatically.

OFF

Does not adjust the exposure for backlit subjects.

■ X.V.COLOR

You can capture wider range of colors. Various colors such as the brilliant color of flowers and turquoise blue of the sea can be more faithfully reproduced. Refer to the instruction manuals of the TV.

▶ OFF

Records in ordinary color range.

ON ((COLOR))

Records in x.v.Color.

⚡ Notes

- Set [X.V.COLOR] to [ON] when the recorded movie will be played back on an x.v.Color-compliant TV.
- If the movie recorded with this function [ON] is played back on a non-x.v.Color-compliant TV, the color may not be reproduced correctly.
- [X.V.COLOR] cannot be set to [ON]:
 - When recording standard definition image quality (STD) movies
 - While recording a movie

■ WIDE SELECT

When recording standard definition image quality (STD) movies, you can select the horizontal to vertical ratio according to the TV connected. Refer also to the instruction manuals supplied with your TV.

▶ 16:9 WIDE

Records movies to the full screen on a 16:9 (wide) TV screen.

4:3 (4:3)

Records movies to the full screen on a 4:3 TV screen.

⚡ Notes

- Set [TV TYPE] correctly according to the TV connected for playback (p. 81).

PHOTO SETTINGS

(Items for recording photos)

See “Using menus” (p. 61) on the operation. The default settings are marked with ▶.

SELF-TIMER



Press PHOTO to start the count down. A photo is recorded after about 10 seconds.

▶ OFF

Cancels the self-timer.

ON (☺)

Starts the self-timer recording. To cancel the recording, touch [RESET].

💡 Tips

- You can also operate by pressing PHOTO on the Wireless Remote Commander (p. 115).

IMAGE SIZE



You can select a photo size to be shot.

▶ 7.1M (L7.1M)

Records photos clearly (3,072 × 2,304).

5.3M (L5.3M)

Records photos clearly in the 16:9 (wide) ratio (3,072 × 1,728).

1.9M (L1.9M)

Allows you to record more photos in relatively clear quality (1,600 × 1,200).



VGA(0.3M) (LVGA)

Allows the maximum number of photos to be recorded (640 × 480).

⚡ Notes

- The selected image size is effective when the (Photo) lamp is lit.
- See page 98 for the number of recordable photos.

STEADYSHOT

You can compensate for camera shake. Set [ STEADYSHOT] to [OFF] () when using a tripod (sold separately), then the image becomes natural.

▶ ON

The SteadyShot function is used.

OFF ()

The SteadyShot function is not used.

FLASH MODE

You can select the flash setting when you record photos using the built-in flash, or an external flash (sold separately) that is compatible with your camcorder.

▶ AUTO

Automatically flashes when there is insufficient ambient light.

ON ()

Always uses the flash regardless of the surrounding brightness.

OFF ()

Records without flash.

Notes

- The recommended distance to the subject when using the built-in flash is approximately 0.3 to 1.5 m (11 7/8 to 59 1/8 in.).
- Remove any dust from the surface of the flash before using it. Flash effect may be impaired if heat discoloration or dust obscures the lamp.
- The  /CHG (flash/charge) lamp (p. 12) flickers while charging the flash, and remains lit when the battery charge is complete.
- If you use the flash in bright places such as when shooting a backlit subject, the flash may not be effective.

- The built-in flash is not flashed when [CONVERSION LENS] (p. 71) is set to other than [OFF], you cannot also set [FLASH MODE].
- The built-in flash is not flashed in movie recording mode.

FLASH LEVEL

You can set this function when you record photos using the built-in flash, or an external flash (sold separately) that is compatible with your camcorder.

HIGH ()

Makes the flash level higher.

▶ NORMAL ()

LOW ()

Makes the flash level lower.

REDEYE REDUC (Redeye reduction)

You can set this function when you record photos using the built-in flash, or an external flash (sold separately) that is compatible with your camcorder. When you set [REDEYE REDUC] to [ON], then set [FLASH MODE] to [AUTO] or [ON],  appears. You can prevent red-eye by activating the pre-flash before the flash flashes.

▶ OFF

Does not prevent red-eye.

ON ()

Prevents red-eye.

Notes

- The redeye reduction may not produce the desired effect due to individual differences and other conditions.
- The redeye function does not work with automatic recording by [SMILE DETECTION].

FILE NO. (File number)

You can select the way to assign file number of photos.

► SERIES

Assigns file numbers of photos in sequence. The file number becomes larger each time you record a photo.

Even if the memory card is replaced with another one, the file number is assigned in sequence.

RESET

Assigns file numbers in sequence, following the largest file number existing on the recording medium.

When the memory card is replaced with another one, the file number is assigned for each memory card.

PLAYBACK

(Items for playback)

See “Using menus” (p. 61) on the operation.

VISUAL INDEX

See page 28.

VIEW IMAGES

■ DATE INDEX

See page 31.

■ MAP (HDR-CX350VE/XR350VE)

See page 47.

■ FILM ROLL

See page 31.

■ FACE

See page 32.

PLAYLIST

See page 45.

HIGHLIGHT

See page 32.

SCENARIO

See page 33.

PLAYBACK SET

■ / SET

See page 25.

■ DATA CODE

During playback, your camcorder displays the information (Date/time, Camera data, Coordinates) recorded automatically at the time of recording.

► OFF

Data code is not displayed.

DATE/TIME

Displays the date and time.

CAMERA DATA

Displays camera setting data.

COORDINATES*

Displays coordinates.

* HDR-CX350VE/XR350VE

DATE/TIME

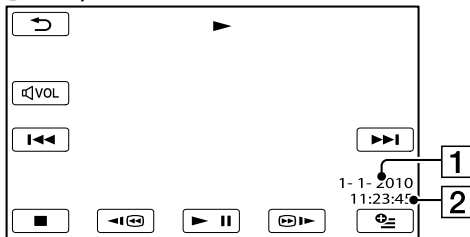

- 1 Date
- 2 Time

CAMERA DATA

Movie

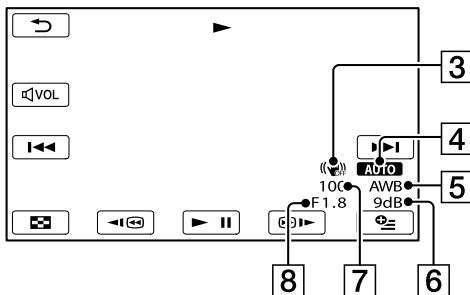

Photo

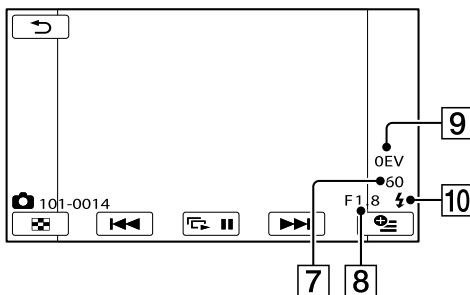

- 3 SteadyShot off
- 4 Brightness
- 5 White balance
- 6 Gain
- 7 Shutter speed

- 8 Aperture value
- 9 Exposure
- 10 Flash

COORDINATES (HDR-CX350VE/
XR350VE)

See page 50.

💡 Tips

- The data code is displayed on the TV screen if you connect your camcorder to a TV.
- The indicator toggles through the following sequences as you press DATA CODE on the Wireless Remote Commander: [DATE/TIME] → [CAMERA DATA] → [COORDINATES] (HDR-CX350VE/XR350VE) → [OFF] (no indication).
- Depending on the recording media condition, bars [---:---] appear.

EDIT

(Items for editing)

See “Using menus” (p. 61) on the operation.

DELETE 

See page 39.

SCENARIO ERASE 

See page 34.

PROTECT 

See page 40.

DIVIDE 

See page 41.

PHOTO CAPTURE 

See page 42.

MOVIE DUB 

See page 43.

PHOTO COPY 

See page 44.

PLAYLIST EDIT 

See page 45.

OTHERS

(Items for other settings)

See “Using menus” (p. 61) on the operation.
The default settings are marked with ►.

YOUR LOCATION (HDR-CX350VE/XR350VE) 

See page 47.

USB CONNECT 

See page 58.

TV CONNECT Guide 

See page 36.

**MUSIC TOOL (HDR-CX300E/
CX350E/CX350VE/CX370E/
XR350E/XR350VE)** 

See page 34.

BATTERY INFO 

You can check the estimated remaining capacity of the battery.

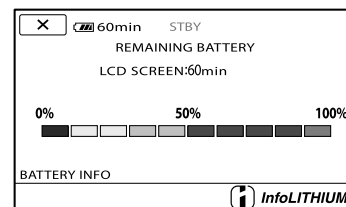

To close the battery information screen
Touch .

MANAGE MEDIA

(Items for recording media)

See “Using menus” (p. 61) on the operation.

MEDIA SETTINGS



See page 17.

MEDIA INFO



You can check the remaining recordable time for each recording mode of the recording media for movies and the approximate free and used media space of the recording media.

To turn off the display

Touch **✕**.

⚡ Notes

- Since there is a management file area, the used space is not displayed as 0 % even if you perform [MEDIA FORMAT] (p. 79).

💡 Tips

- Only the information of the medium selected on [MOVIE MEDIA SET] (p. 17) is displayed. Change the medium setting if necessary.

MEDIA FORMAT



Formatting deletes all the movies and photos to recover recordable free space. Select the recording media to be formatted, touch [YES] → [YES] → **OK**.

⚡ Notes

- Connect your camcorder to the wall outlet (wall socket) using AC Adaptor supplied for this operation (p. 14).
- To avoid the loss of important images, you should save them before formatting the recording media.
- Protected movies and photos will also be deleted.
- While [Executing...] is displayed, do not close the LCD screen, operate the buttons on the camcorder, disconnect the AC Adaptor, or eject

the memory card from your camcorder (The access lamp is lit or flashing while formatting memory card.).

To prevent data on the internal recording media from being recovered [EMPTY] allows you to write unintelligible data onto the internal recording media of the camcorder. In this way it may become more difficult to recover any original data. When you dispose of or transfer the camcorder, it is recommended that you perform [EMPTY].

When the internal recording media is selected on the [MEDIA FORMAT] screen, touch [EMPTY].

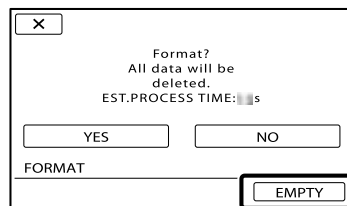

⚡ Notes

- Connect the AC Adaptor to the wall outlet (wall socket). You cannot perform [EMPTY] unless you connect the AC Adaptor to the wall outlet (wall socket).
- To avoid the loss of important images, they should be saved on a computer or other devices before performing [EMPTY].
- Disconnect all cables except the AC Adaptor. Do not disconnect the AC Adaptor during the operation.
- While deleting data, do not apply any vibrations or shocks to your camcorder.
- The actual performing time for deleting data is as follows;
 - HDR-CX300E/CX305E: about 2 minutes
 - HDR-CX350E/CX350VE: about 3 minutes
 - HDR-CX370E: about 6 minutes
 - HDR-XR350E/XR350VE: about 80 minutes
- If you stop performing [EMPTY] while [Executing...] appears, be sure to complete the operation by performing [MEDIA FORMAT]

or [EMPTY] when you use the camcorder next time.

REPAIR IMG.DB F.



See page 89, 94.

GENERAL SET



(Other setup items)

See “Using menus” (p. 61) on the operation. The default settings are marked with ►.

SOUND/DISP SET



■ VOLUME

You can adjust the volume of playback sound by touching  / .

■ BEEP



► ON

A melody sounds when you start/stop recording, or operate the touch panel.

OFF

Cancels the melody.

■ LCD BRIGHT

You can adjust the brightness of the LCD screen by touching  / .

Tips

- This adjustment does not affect the recorded images in any way.

■ LCD BL LEVEL (LCD backlight level)

You can select the brightness of the LCD screen's backlight.

► NORMAL

Standard brightness.

BRIGHT

Brightens the LCD screen.

Notes

- When you connect your camcorder to the wall outlet (wall socket) using the supplied AC Adaptor, [BRIGHT] is automatically selected for the setting.
- When you select [BRIGHT], battery life is slightly reduced during recording.

- If you open the LCD panel 180 degrees to face the screen outside and close the LCD panel to the camcorder body, the setting becomes [NORMAL] automatically.

Tips

- This adjustment does not affect the recorded images in any way.

LCD COLOR

You can adjust the color of the LCD screen by touching **−** / **+**.

Tips

- This adjustment does not affect the recorded images in any way.

DISPLAY SET

You can set the duration of displaying the icons or indicators on the LCD screen.

AUTO1

Displays for about 3 seconds. The rec & zoom buttons on the LCD is displayed.

AUTO2

Displays for about 3 seconds. The rec & zoom buttons on the LCD is not displayed.

ON

Always displays. The rec & zoom buttons on the LCD is not displayed.

Tips

- The icons or indicators are displayed in the following cases.
 - When you turn on your camcorder.
 - The LCD screen is touched (Except rec & zoom buttons on LCD).
 - When you switch your camcorder to the movie recording, photo recording, or playback modes.

OUTPUT SETTINGS



TV TYPE

You need to convert the signal depending on the TV connected when playing back movies and photos. The recorded movies and photos are played back as following illustrations.

▶ 16:9

Select this to view your movies on a 16:9 (wide) TV. The recorded movies and photos are played back as shown below.

Movies and photos recorded in 16:9 (wide) mode Movies and photos recorded in 4:3 mode

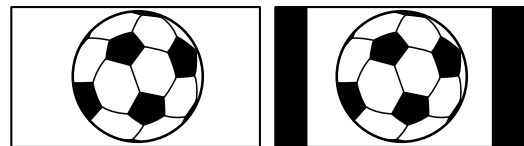

4:3

Select this to view your movies and photos on a 4:3 standard TV. The recorded movies and photos are played back as shown below.

Movies and photos recorded in 16:9 (wide) mode Movies and photos recorded in 4:3 mode



⚡ Notes

- Horizontal to vertical ratio of high definition image quality (HD) movies is 16:9.

■ COMPONENT

Select [COMPONENT] when connecting your camcorder to a TV with the component input jack.

576i

Select this when connecting your camcorder to a TV with the component input jack.

▶ 1080i/576i

Select this when connecting your camcorder to a TV that has the component input jack and is capable of displaying the 1080i signal.

■ HDMI RESOLUTION

Select the output image resolution when connecting your camcorder to a TV with an HDMI cable (sold separately).

HD CONTENTS

Set the output image resolution recorded with high definition image quality (HD).

▶ AUTO

Normal setting (outputs the signal according to the TV automatically).

1080p

Outputs the 1080p signal.

1080i

Outputs the 1080i signal.

720p

Outputs the 720p signal.

576p

Outputs the 576p signal.

STD CONTENTS

Set the output image resolution recorded with standard definition image quality (STD).

▶ AUTO

Normal setting (outputs the signal according to the TV automatically).

576p

Outputs the 576p signal.

576i

Outputs the 576i signal.

■ DISP OUTPUT (Display output)

You can set where the screen displays are to be output.

▶ LCD PANEL

Shows displays such as the time code on the LCD screen.

V-OUT/PANEL

Shows displays such as the time code on the LCD screen, and on the TV screen.

CLOCK/  LANG



■ CLOCK SET

See page 15.

■ AREA SET

You can adjust a time difference without stopping the clock. Set your local area when using your camcorder in other time zones. Refer to the world time difference on page 101.

■ AUTO CLOCK ADJ (Auto clock adjustment) (HDR-CX350VE/XR350VE)

See page 51.

■ AUTO AREA ADJ (Auto area adjustment) (HDR-CX350VE/XR350VE)

See page 51.

■ SUMMERTIME

You can change this setting without stopping the clock. Set to [ON] to move the time forward 1 hour.

- ▶ OFF
Does not set the summertime.
- ON
Sets the summertime.

■ LANGUAGE SET

You can select the language to be used on the LCD screen.

Tips

- Your camcorder offers [ENG[SIMP]] (simplified English) for when you cannot find your native tongue among the options.

POWER SETTINGS

■ A.SHUT OFF (Auto shut off)

You can set your camcorder to turn off automatically when you do not operate your camcorder for more than about 5 minutes.

- ▶ 5min
The camcorder turns off automatically.
- NEVER
The camcorder does not turn off automatically.

Notes

- When you connect your camcorder to a wall outlet (wall socket), [A.SHUT OFF] is automatically set to [NEVER].

■ POWER ON BY LCD

You can set your camcorder to turn on and off when you open and close the LCD screen.

- ▶ ON
The camcorder turns on and off when the LCD screen opens and closes.
- OFF
The camcorder does not turn on and off when the LCD screen opens and closes.

OTHER SETTINGS

■ DEMO MODE



When your camcorder is connected to a wall outlet (wall socket), a demonstration movie appear about 10 minutes after you turn on the  (Movie) lamp by pressing MODE.

- ▶ ON
The demonstration appears.
- OFF
The demonstration does not appear.

Notes

- In the default setting, the demonstration movie is in the VISUAL INDEX. If you delete the demonstration movie, you cannot recover it (HDR-CX350E/CX350VE/CX370E/XR350E/XR350VE).
- A movie you have recorded will be registered as the demonstration movie if it satisfies all of the following conditions.
 - The movie is protected
 - The movie is the first one displayed on the VISUAL INDEX screen
 - The movie is saved on the internal recording media
 - The movie is recorded with high definition image quality (HD)

Tips

- When you set this item to [ON] and touch , the demonstration starts playing.
- The demonstration will be suspended:
 - When you press START/STOP or PHOTO
 - When you touch the screen during the demonstration (The demonstration starts again after about 10 minutes)
 - When you turn on the  (Photo) lamp
 - When you press  (VIEW IMAGES)

■ CALIBRATION

See page 108.

■ DROP SENSOR (HDR-XR350E/ XR350VE)

Your camcorder detects that it is dropping, and protects the internal hard disk.

▶ ON

Activates the drop sensor. When it is detected that the camcorder is dropping, you may not be able to record or play back images correctly, to protect the internal hard disk. When dropping is detected,  appears.

OFF ()

Deactivates the drop sensor.

Notes

- Set the drop sensor to [ON] when you use the camcorder. Otherwise, if you drop the camcorder, you may damage the internal hard disk.
- In a non-gravity situation, the drop sensor activates. When you record images during an activity such as roller-coasting or skydiving, you can set [DROP SENSOR] to [OFF] so as not to activate the drop sensor.

■ CTRL FOR HDMI (Control for HDMI)

When connecting your camcorder to a “BRAVIA” Sync compatible TV with the HDMI cable (sold separately), you can play back movies on your camcorder by aiming the TV’s Remote Commander at the TV (p. 38).

▶ ON

Operates your camcorder using the TV’s Remote Commander.

OFF

Does not operate your camcorder using the TV’s Remote Commander.

■ REC LAMP (Recording lamp)

You can make the camera recording lamp on the front of your camcorder not to turn on.

▶ ON

The camera recording lamp lights up.

OFF

The camera recording lamp does not light up.

■ REMOTE CTRL (Remote control)

▶ ON

Select this when you use the supplied Wireless Remote Commander (p. 115).

OFF

Select this when you do not use supplied Wireless Remote Commander.

Tips

- Select [OFF] when you want to prevent your camcorder from responding to a command sent by another remote control unit.

? Troubleshooting

If you run into any problems using your camcorder, follow the steps below.

① Check the list (p. 85 to 95), and inspect your camcorder.



② Disconnect the power source, attach the power source again after about 1 minute, and turn the camcorder on.



③ Press RESET (p. 114) using a pointed object, and turn the camcorder on. If you press RESET, all settings, including the clock setting, are reset.



④ Contact your Sony dealer or local authorized Sony service facility.

- Your camcorder may be required to initialize or change the current internal recording media of your camcorder, depending on the problem. In the event of this, the data stored on the internal recording media will be deleted. Be sure to save the data on the internal recording media on other media (backup) before sending your camcorder for repair. We will not compensate you for any loss of internal recording media data.
- During repair, we may check a minimum amount of data stored on the internal recording media in order to investigate the problem. However, your Sony dealer will neither copy nor retain your data.
- Overall operations/Wireless Remote Commander..... p. 85
- Batteries/power sources p. 86
- LCD screen p. 87
- Memory card p. 87
- Recording..... p. 87
- Playback p. 89
- Playing back images stored on memory card on other devices..... p. 90

- Editing movies/photos on your camcorder..... p. 90
- Playback on the TV p. 90
- Dubbing/Connecting to other devices..... p. 91
- GPS (HDR-CX350VE/XR350VE) p. 91
- Connecting to a Computer..... p. 91
- Examples of functions that cannot be used simultaneously..... p. 91

Overall operations/Wireless Remote Commander

The power does not turn on.

- Attach a charged battery pack to the camcorder (p. 12).
- The plug of the AC Adaptor has been disconnected from the wall outlet (wall socket). Connect it to the wall outlet (wall socket) (p. 12).

The camcorder does not operate even when the power is set to on.

- It takes a few seconds for your camcorder to be ready to shoot after the power is turned on. This is not a malfunction.
- Disconnect the AC Adaptor from the wall outlet (wall socket) or remove the battery pack, then reconnect it after about 1 minute. If the functions still do not work, press RESET (p. 114) using a pointed object. (If you press RESET, all settings, including the clock setting, are reset.)
- The temperature of your camcorder is extremely high. Turn off your camcorder and leave it for a while in a cool place.
- The temperature of your camcorder is extremely low. Leave your camcorder with the power of your camcorder on. Turn off your camcorder and take it to a warm place. Leave the camcorder there for a while, then turn on your camcorder.

The menu settings have changed automatically.

- The following menu items return to the default settings in more than 12 hours after you close the LCD screen.
 - [SCENE SELECTION]
 - [WHITE BAL.]
 - [SPOT MTR/FCS]
 - [SPOT METER]
 - [SPOT FOCUS]
 - [EXPOSURE]
 - [FOCUS]
 - [LOW LUX]
 - [BLT-IN ZOOM MIC]
 - [MICREF LEVEL]
 - [AUTO BACK LIGHT]
 - [DROP SENSOR] (HDR-XR350E/XR350VE)
- The following menu items return to the default settings when you switch between movie recording and photo recording and playback modes.
 - [FADER]
 - [TELE MACRO]
 - [SELF-TIMER]

Your camcorder gets warm.

- Your camcorder may become warm during operation. This is not a malfunction.

The supplied Wireless Remote Commander does not function.

- Set [REMOTE CTRL] to [ON] (p. 84).
- Insert a battery into the battery holder with the +/- polarities correctly matching the +/- marks (p. 116).
- Remove any obstructions between the Wireless Remote Commander and the remote sensor.
- Point the remote sensor away from strong light sources such as direct sunlight or overhead lighting. Otherwise, the Wireless Remote Commander may not function properly.

Another DVD device malfunctions when you use the supplied Wireless Remote Commander.

- Select a commander mode other than DVD 2 for your DVD device, or cover the sensor of your DVD device with black paper.

Batteries/power sources

The power abruptly turns off.

- Use the AC Adaptor.
- In the default setting, when about 5 minutes have elapsed while you do not operate your camcorder, the camcorder is automatically turned off (A.SHUT OFF). Change the setting of [A.SHUT OFF] (p. 83), or turn on the power again.
- Charge the battery pack (p. 12).

The /CHG (flash/charge) lamp does not light while the battery pack is being charged.

- Close the LCD screen (p. 12).
- Attach the battery pack to the camcorder correctly (p. 12).
- Connect the power cord (mains lead) to the wall outlet (wall socket) properly.
- The battery charge is completed (p. 12).

The /CHG (flash/charge) lamp flashes while the battery pack is being charged.

- If the temperature of the battery pack is too high or too low, you may not be able to charge it (p. 105).
- Attach the battery pack to the camcorder correctly (p. 12). If the problem persists, disconnect the AC Adaptor from the wall outlet (wall socket) and contact your Sony dealer. The battery pack may be damaged.

The remaining battery time indicator does not indicate the correct time.

- The ambient temperature is too high or too low. This is not a malfunction.
- The battery pack has not been charged enough. Fully charge the battery again. If the problem persists, replace the battery pack with a new one (p. 106).
- The indicated time may not be correct depending on the environment of use.

The battery pack is quickly discharged.

- The ambient temperature is too high or low. This is not a malfunction.
- The battery pack has not been charged enough. Fully charge the battery again. If the problem persists, replace the battery pack with a new one (p. 106).

LCD screen

Menu items are grayed out.

- You cannot select grayed items in the current recording/playback situation.
- There are some functions you cannot activate simultaneously (p. 91).

The buttons do not appear on the touch panel.

- Touch the LCD screen lightly.
- Press DISPLAY on the Wireless Remote Commander (p. 115).

The buttons on the touch panel do not work correctly or do not work at all.

- Adjust the touch panel ([CALIBRATION]) (p. 108).

The buttons on the touch panel quickly disappear.

- Set [DISPLAY SET] to [ON] (p. 81).

Memory card

Operations using the memory card cannot be performed.

- If you use the memory card formatted on a computer, format it again on your camcorder (p. 79).

Images stored on the memory card cannot be deleted.

- The maximum number of images that you can delete on the index screen at one time is 100.
- You cannot delete the protected images.



The data file name is not indicated correctly or flashes.

- The file is damaged.
- The file format is not supported by your camcorder (p. 105).

Recording

Refer also to “Memory card” (p. 87).

Pressing START/STOP or PHOTO does not record images.

- The playback screen is displayed. Press MODE to turn on the  (Movie) or  (Photo) lamp (p. 20).
- Your camcorder is recording the image you have just shot on the recording media. You cannot make new recording during this period.
- The recording media is full. Delete unnecessary images (p. 39).
- Total number of movie scenes or photos exceeds the recordable capacity of your camcorder (p. 96, 98). Delete unnecessary images (p. 39).
- While [DROP SENSOR] is activated (p. 84), you may not record images (HDR-XR350E/XR350VE).

- The temperature of your camcorder is extremely high. Turn off your camcorder and leave it for a while in a cool place.
- The temperature of your camcorder is extremely low. Turn off your camcorder and take it to a warm place. Leave the camcorder there for a while, then turn on the camcorder.

Photos cannot be recorded.

- You cannot record photos together with:
 - [FADER]
 - [GOLF SHOT]
 - [SMTH SLW REC]
- When [REC MODE] is set to [HD FX], you cannot record photos while recording movies.

The access lamp remains lit or flashing even if recording was stopped.

- Your camcorder is recording the scene you have just shot on the memory card.

The imaging field looks different.

- The imaging field may look different depending on the condition of your camcorder. This is not a malfunction.

The flash does not work.

- You cannot record with the built-in flash while:
 - the (movie) lamp is on
 - [CONVERSION LENS] is set to other than [OFF]
- Even if auto flash or (Auto redeye reduction) is selected, you cannot use the flash with:
 - [SPOT MTR/FCS]
 - [SPOT METER]
 - [MANUAL] in [EXPOSURE]
 - [TWILIGHT], [SUNRISE&SUNSET], [FIREWORKS], [LANDSCAPE], [SPOTLIGHT], [BEACH] or [SNOW] in [SCENE SELECTION]

The actual recording time for movies is less than the expected recording time of the recording media.

- Depending on the recording conditions, the time available for recording may be shorter, for example when recording a fast moving object, etc. (p. 96).

The camcorder stops operating.

- The temperature of your camcorder is extremely high. Turn off your camcorder and leave it for a while in a cool place.
- The temperature of your camcorder is extremely low. Turn off your camcorder and take it to a warm place. Leave the camcorder there for a while, then turn on the camcorder.
- If you keep applying vibration on the camcorder, recording may stop.

There is a time difference between the point when START/STOP is pressed and the point that the recording movie is started or stopped actually.

- On your camcorder, there may be a slight time difference between the point where you press START/STOP and the actual point that recording movie starts/stops. This is not a malfunction.

The horizontal to vertical ratio of the movie (16:9 (wide)/4:3) cannot be changed.

- The horizontal to vertical ratio of high definition image quality (HD) movies is 16:9 (wide).

The auto focus does not function.

- Set [FOCUS] to [AUTO] (p. 69).
- The recording conditions are not suitable for auto focus. Adjust the focus manually (p. 69).

SteadyShot does not function.

- Set [STEADYSHOT] to [ACTIVE] or [STANDARD], [STEADYSHOT] to [ON] (p. 71, 75).
- Even if [STEADYSHOT] is set to [ACTIVE] or [STANDARD], [STEADYSHOT] to [ON], your camcorder may not be able to compensate for excessive vibrations.

The subjects passing by the screen very fast appear crooked.

- This is called the focal plane phenomenon. This is not a malfunction. Because of the way the image device (CMOS sensor) reads out image signals, the subjects passing by the lens rapidly might appear crooked depending on the recording conditions.

Horizontal stripes appear on the images.

- This occurs when recording images under a fluorescent lamp, sodium lamp, or mercury lamp. This is not a malfunction.

Black bands appear when you record a TV screen or computer screen.

- Set [STEADYSHOT] to an option except for [ACTIVE] (p. 71).

[LCD BL LEVEL] cannot be adjusted.

- You cannot adjust [LCD BL LEVEL] when:
 - The LCD panel is closed on your camcorder with the LCD screen facing out.
 - The power is supplied from the AC Adaptor.

Magnification changes when the recording mode is switched.

- You cannot use digital zoom when your camcorder is in the photo recording mode.

Sound is not recorded correctly.

- If you disconnect an external microphone, etc. during recording movies, sound may not be

recorded correctly.

- Connect the microphone again in the same way as when you start recording movies.

Playback

Images cannot be played back.

- Select the type of recording media you want to play back (p. 17).
- Select the image quality of the movie you want to play back (p. 25).
- Images recorded on other devices may not be played back. This is not a malfunction.

Photos cannot be played back.

- Photos cannot be played back if you have modified files or folders, or have edited the data on a computer. (The file name flashes in that case.) This is not a malfunction.

is indicated on an image on the VISUAL INDEX screen.

- This may appear on an image recorded on other devices, edited on a computer, etc.
- You removed the AC Adaptor or the battery pack while the recording media icon at the top right corner of the screen flashes, or before the access lamp is turned off after recording. This may damage your image data and is displayed.

is indicated on an image on the VISUAL INDEX screen.

- The image data base file may be damaged. Check the data base file by touching **MENU** (MENU) → [Show others] → [REPAIR IMG.DB F.] (under [MANAGE MEDIA] category) → the recording medium. If it still appears, delete the image with (p. 39).

No sound or only a quiet sound is heard during playback.

- Turn up the volume (p. 30).

- Sound is quiet when the LCD screen is closed facing out. Open the LCD screen.
- When you record sound with [MICREF LEVEL] (p. 73) set to [LOW], the recorded sound may be difficult to hear.
- Sounds cannot be recorded while shooting with [SMTH SLW REC] or [GOLF SHOT].

The demonstration movies cannot be played. (HDR-CX350E/CX350VE/CX370E/XR350E/XR350VE)

- Select the internal recording media for the recording media, and the high definition image quality (HD).
- The demonstration movie is deleted.

A movie is played back automatically.

- Movies play automatically as a demonstration movie when the filmed movie fulfills a certain condition on your camcorder (p. 83). This is not a malfunction.

Playing back images stored on memory card on other devices

Images cannot be played back or the memory card is not recognized.

- The playback device does not support playing back memory cards (p. 3).

Editing movies/photos on your camcorder

Unable to edit.

- Unable to edit because of the condition of the image.

Movies cannot be added in the Playlist.

- There is no free space in the recording media.
- You can add no more than 999 high definition image quality (HD) movies, or 99 standard definition image quality (STD) movies, to a

Playlist. Erase unnecessary movies from the Playlist (p. 46).

- You cannot add photos in the Playlist.

A movie cannot be divided.

- A movie that is too short cannot be divided.
- A protected movie cannot be divided.

A photo cannot be captured from a movie.

- The recording media where you want to save photos is full.

Playback on the TV

Neither image nor sound is played on the connected TV.

- When you are using the component A/V cable, set [COMPONENT] according to the requirements of the connected device (p. 82).
- When you are using the component video plug, make sure the red and white plugs of the A/V connecting cable are connected (p. 37).
- Images are not output from the HDMI OUT jack, if copyright protection signals are recorded in the images.
- When you are using the S VIDEO plug, make sure the red and white plugs of the A/V connecting cable are connected (p. 37).

The top, bottom, right, and left edges of images are trimmed slightly on a connected TV.

- The LCD screen of your camcorder can display recording images across the entire screen (full pixel display). However, this may cause slight trimming of the top, bottom, right, and left edges of images when played back on a TV which is not compatible with full pixel display.
- It is recommended you record images using the outer frame of [GUIDEFRA] (p. 71) as a guide.

The image appears distorted on the 4:3 TV.

- This happens when viewing an image recorded in the 16:9 (wide) mode on a 4:3 TV. Set [TV TYPE] correctly (p. 81) and play back the image.

Black bands appear at the top and bottom of the screen of the 4:3 TV.

- This happens when viewing an image recorded in the 16:9 (wide) mode on a 4:3 TV. This is not a malfunction.

Dubbing/Connecting to other devices

Images are not dubbed correctly.

- You cannot dub images using the HDMI cable (sold separately).
- The A/V connecting cable is not connected properly. Make sure to connect the cable to the input jack of another device (p. 59).

GPS (HDR-CX350VE/XR350VE)

The camcorder is not receiving a GPS signal.

- Your camcorder may not be able to receive radio signals from GPS satellites because of obstructions. Bring your camcorder to an open area, and set the GPS switch to ON again. See page 102 for details on locations or situations where radio signals may not reach.

The current location on the map of the camcorder is different from the actual current location.

- The margin of error of the radio signal from GPS satellites is large. The margin of error can be as wide as several-hundred meters at the maximum.

Connecting to a Computer

“PMB” cannot be installed.

- Check the computer environment or installation procedure required to install “PMB”.

“PMB” does not work correctly.

- Quit “PMB” and restart your computer.

The camcorder is not recognized by the computer.

- Disconnect devices from the USB jack of the computer other than the keyboard, mouse, and your camcorder.
- Disconnect the USB cable from the computer and your camcorder, and restart the computer, then connect the computer and your camcorder again in the correct order.

Examples of functions that cannot be used simultaneously

The following list shows examples of unworkable combinations of functions and menu items.

Cannot use	Because of following settings
INTELLIGENT AUTO	[GOLF SHOT], [SMTH SLW REC]
[FACE DETECTION]	[GOLF SHOT], [SMTH SLW REC], [DIGITAL ZOOM], [SPOT MTR/FCS], [SPOT METER], [SPOT FOCUS], [EXPOSURE], [FOCUS], [TWILIGHT], [SUNRISE&SUNSET], [FIREWORKS], [LANDSCAPE], [SPOTLIGHT], [BEACH], [SNOW], [WHITE BAL.], [FADER], [SELF-TIMER]

Cannot use	Because of following settings
[PRIORITY SETTING]/ [SMILE DETECTION]/ [SMILE SENSITIVITY]	[GOLF SHOT], [SMTH SLW REC], [DIGITAL ZOOM], [SPOT MTR/FCS], [SPOT METER], [SPOT FOCUS], [EXPOSURE], [FOCUS], [TWILIGHT], [SUNRISE&SUNSET], [FIREWORKS], [LANDSCAPE], [SPOTLIGHT], [BEACH], [SNOW], [WHITE BAL.], [FADER], [SELF-TIMER]
[SCENE SELECTION]	[GOLF SHOT], [SMTH SLW REC], [LOW LUX], [FADER], [TELE MACRO]

Self-diagnosis display/Warning indicators

If indicators appear on the LCD screen, check the following.

If the problem persists even after you have tried to fix a couple of times, contact your Sony dealer or local authorized Sony service facility. In this case, when you contact them, give them all the numbers of the error code beginning with C or E.

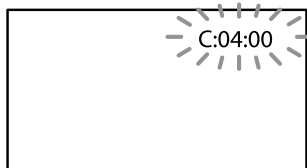

C:(or E:) □□:□□ (Self-diagnosis display)

C:04:□□

- The battery pack is not an “InfoLITHIUM” battery pack (V series). Use an “InfoLITHIUM” battery pack (V series) (p. 105).
- Connect the DC plug of the AC Adaptor to the DC IN jack of your camcorder securely (p. 12).

C:06:□□

- The battery pack temperature is high. Change the battery pack or place it in a cool place.

C:13:□□ / C:32:□□

- Remove the power source. Reconnect it and operate your camcorder again.

E:□□:□□

- Follow the steps from ② to ④ on page 85.

(Warning on the internal hard disk of the camcorder)

Fast flashing

- The internal hard disk of the camcorder is full.
- An error may have occurred with the internal hard disk of the camcorder.

(Battery level warning)

Slow flashing

- The battery pack is nearly used up.
- Depending on the operating environment or battery conditions, may flash, even if there are about 20 minutes remaining.

(Warning indicator pertaining to battery pack temperature)

- The battery pack temperature is high. Change the battery pack or place it in a cool place.

(High temperature warning)

Slow flashing

- The temperature of your camcorder is getting higher. Turn off your camcorder and leave it for a while in a cool place.

Fast flashing

- The temperature of your camcorder is extremely high. Turn off your camcorder and leave it for a while in a cool place.

(Low temperature warning)

Fast flashing

- The temperature of your camcorder is extremely low. Make the camcorder warm.

 (Warning indicator pertaining to memory card)

Slow flashing

- Free spaces for recording images are running out. For the type of memory card you can use with your camcorder, see page 18.
- No memory card is inserted (p. 18).

Fast flashing

- There are not enough free spaces for recording images. After storing the images on other media (p. 52), delete unnecessary images, or format the memory card (p. 79).
- The image data base file may be damaged. Check the data base file by touching **MENU** (MENU) → [Show others] → [REPAIR IMG.DB F.] (under  [MANAGE MEDIA] category) → the recording medium.
- The memory card is damaged.

 (Warning indicators pertaining to memory card formatting)

- The memory card is damaged.
- The memory card is not formatted correctly (p. 79).

 (Warning indicator pertaining to incompatible memory card)

- Incompatible memory card is inserted (p. 18).

 (Warning indicator pertaining to the write-protect of the memory card)

- Access to the memory card was restricted on another device.

 (Warning indicator pertaining to the flash)

Fast flashing

- There is something wrong with the flash.

 (Warning indicator pertaining to camera-shake warning)

- The amount of lights is not sufficient, so camera-shake easily occurs. Use the flash.
- The camcorder is unsteady, so camera-shake easily occurs. Hold the camcorder steady with both hands and record the image. However, note that the camera-shake warning indicator does not disappear.

 (Warning indicator pertaining to drop sensor)

- The drop sensor function (p. 84) is activated, and has detected that the camcorder has been dropped. Therefore, the camcorder is taking steps to protect the internal hard disk. Recording/playback may be disabled as a result.
- The drop sensor function does not guarantee the protection of the internal hard disk under all possible situations. Use the camcorder under stable conditions.

 (Warning indicator pertaining to photo recording)

- The recording media is full.
- Photos cannot be recorded during processing. Wait for a while, then record.
- When [ REC MODE] is set to [HD FX], you cannot record photos while recording movies.

 (Warning indicator pertaining to smile shutter)

- The smile shutter cannot be used with the current setting of the camcorder.

Tips

- You may hear a melody when some warning indicators appear on the screen.

Description of warning messages

If messages appear on the screen, follow the instructions.

Recording media

 Internal memory format error.

 HDD format error.

- The internal recording media of the camcorder is set differently from the default format. Performing [MEDIA FORMAT] (p. 79) may enable you to use your camcorder. This will delete all data in the internal recording media.
-

Data error.

- An error occurred during reading or writing the internal recording media of the camcorder.
 - If the message is preceded by a GPS indicator, there may be some trouble with the GPS receiver. Turn on your camcorder again. (HDR-CX350VE/XR350VE)
 - This may occur when you keep applying shock on the camcorder.
 - Movies recorded on other devices may not be played back.
-

The Image Database File is damaged. Do you want to create a new file?

HD movie management information is damaged. Create new information?

- The management file is damaged. When you touch [YES], a new management file is created. The old recorded images on the media cannot be played back (Image files are not damaged). If you execute [REPAIR IMG. DB F.] after creating new information, playing back the old recorded images may become possible. If it does not work, copy the image using the supplied software.
-

There is no HD movie management information. Create new information?

- You cannot record or play back movies because no high definition image quality (HD) movie management information exists. If you touch [YES], new management information is created and you can record or play back movies with high definition image quality (HD).
 - You can record standard definition image quality (STD) movies or photos.
-

Inconsistencies found in Image Database File. Do you want to repair the Image Database File?

The Image Database File is damaged. Do you want to repair the Image Database File?

Inconsistencies found in Image Database File. Cannot record or play HD movies. Do you want to repair the Image Database File?

- The management file is damaged, and you cannot record movies or photos. Touch [YES] to repair.
 - You can record photos on a memory card.
-

Buffer overflow

- You cannot record because the drop sensor senses a drop of the camcorder repeatedly. If you are at risk of dropping the camcorder constantly, set [DROP SENSOR] to [OFF], and you may be able to record the image again (p. 84).
-

Recovering data.

- Your camcorder tries to recover data automatically if the data writing was not performed properly.
-

Cannot recover data.

- Writing data onto the media of the camcorder has failed. Attempts were made to recover the data, but they were unsuccessful.
-

Reinsert the memory card.

- Reinsert the memory card a few times. If even then the indicator flashes, the memory card could be damaged. Try with another memory card.

This memory card is not formatted correctly.

- Format the memory card (p. 79). Note that if you format the memory card, all the recorded movies and photos are deleted.

Still picture folder is full. Cannot record still pictures.

- You cannot create folders exceeding 999MSDCF. You cannot create or delete created folders using your camcorder.
- Format the memory card (p. 79), or delete folders using your computer.

This memory card may not be able to record or play movies.

- Use a memory card recommended for your camcorder (p. 18).

This memory card may not be able to record or play images correctly.

- Use a memory card recommended for your camcorder (p. 18).

Do not eject the memory card during writing. Data may be damaged.

- Reinsert the memory card, and follow the instructions on the LCD screen.
-

Other

No further selection is possible.

- You can select only 100 images at one time for:
 - Deleting movies/photos
 - Protecting movies/photos, or releasing the protection
 - Dubbing movies
 - Copying photos
 - Editing the Playlist of high definition image quality (HD) movies

Data protected.

- You tried to delete protected data. Release the protection of the data.
-

Recording time of movies/number of recordable photos

“HD” stands for high definition image quality, and “STD” stands for standard image quality.

Expected time of recording and playback with each battery pack

Recording time

Approximate time available when you use a fully charged battery pack.

HDR-CX300E/CX305E/CX350E/ CX350VE/CX370E

(unit: minute)

Battery pack	Continuous recording time		Typical recording time	
	HD	STD	HD	STD
NP-FV50 (supplied)	125	165	60	80
NP-FV70	260	345	130	170
NP-FV100	515	680	255	340

HDR-XR350E/XR350VE

(unit: minute)

Battery pack	Continuous recording time		Typical recording time	
	HD	STD	HD	STD
NP-FV50 (supplied)	110	145	55	70
NP-FV70	235	300	115	150
NP-FV100	470	600	235	300

- Each recording time is measured when the [RECORD MODE] is set to HQ.
- Typical recording time shows the time when you repeat recording start/stop, switching the MODE lamp, and zooming.
- Times measured when using the camcorder at 25 °C (77 °F). 10 °C to 30 °C (50 °F to 86 °F) is recommended.
- The recording and playback time will be shorter when you use your camcorder in low

temperatures.

- The recording and playback time will be shorter depending on the conditions under which you use your camcorder.

Playing time

Approximate time available when you use a fully charged battery pack.

HDR-CX300E/CX305E/CX350E/ CX350VE/CX370E

(unit: minute)

Battery pack	HD	STD
Image quality		
NP-FV50 (supplied)	200	240
NP-FV70	415	490
NP-FV100	830	980

HDR-XR350E/XR350VE

(unit: minute)

Battery pack	HD	STD
Image quality		
NP-FV50 (supplied)	165	200
NP-FV70	345	415
NP-FV100	680	830

Expected recording time of movies

Internal memory

HDR-CX300E/CX305E

High definition image quality (HD) in h (hour) and m (minute)

Recording mode	Recording time
[HD FX]	1 h 25 m
[HD FH]	1 h 55 m
[HD HQ]	3 h 50 m
[HD LP]	6 h 35 m

Standard definition image quality (STD) in h (hour) and m (minute)

Recording mode	Recording time	
	HDR-CX350E	HDR-CX350VE
[STD HQ]	3 h 55 m	

HDR-CX350E/CX350VE

High definition image quality (HD) in h (hour) and m (minute)

Recording mode	Recording time	
	HDR-CX350E	HDR-CX350VE
[HD FX]	3 h	2 h 55 m
[HD FH]	3 h 55 m	3 h 50 m
[HD HQ]	7 h 50 m	7 h 40 m
[HD LP]	13 h 20 m	13 h

Standard definition image quality (STD) in h (hour) and m (minute)

Recording mode	Recording time	
	HDR-CX350E	HDR-CX350VE
[STD HQ]	8 h 5 m	7 h 50 m

HDR-CX370E

High definition image quality (HD) in h (hour) and m (minute)

Recording mode	Recording time
[HD FX]	6 h 5 m
[HD FH]	7 h 55 m
[HD HQ]	15 h 50 m
[HD LP]	26 h 55 m

Standard definition image quality (STD) in h (hour) and m (minute)

Recording mode	Recording time
[STD HQ]	16 h 15 m

Internal hard disk

HDR-XR350E/XR350VE

High definition image quality (HD) in h (hour) and m (minute)

Recording mode	Recording time	
	HDR-XR350E	HDR-XR350VE
[HD FX]	15 h 20 m	15 h 10 m
[HD FH]	19 h 50 m	19 h 40 m
[HD HQ]	39 h 40 m	39 h 30 m
[HD LP]	67 h 30 m	67 h 10 m

Standard definition image quality (STD) in h (hour) and m (minute)

Recording mode	Recording time	
	HDR-XR350E	HDR-XR350VE
[STD HQ]	40 h 50 m	40 h 40 m

Tips

- You can record movies of a maximum of 3,999 scenes with high definition image quality (HD), and 9,999 scenes with standard definition image quality (STD).
- The maximum continuous recording time of movies is approximately 13 hours.
- If you want to record up to the maximum recording time indicated in the table, you need to delete the demonstration movie on your camcorder (HDR-CX350E/CX350VE/CX370E/XR350E/XR350VE).
- Your camcorder uses the VBR (Variable Bit Rate) format to automatically adjust image quality to suit the recording scene. This technology causes fluctuations in the recording time of the media. Movies containing quickly moving and complex images are recorded at a higher bit-rate, and this reduces the overall recording time.

Memory card

High definition image quality (HD)

(unit: minute)

	AVC HD 24M (FX)	AVC HD 17M (FH)	AVC HD 9M (HQ)	AVC HD 5M (LP)
1GB	5 (5)	6 (6)	10 (9)	20 (15)
2GB	10 (10)	10 (10)	25 (20)	45 (35)
4GB	20 (20)	25 (25)	55 (40)	95 (75)
8GB	40 (40)	55 (55)	115 (80)	195 (155)
16GB	85 (85)	115 (115)	230 (165)	395 (315)
32GB	175 (175)	230 (230)	465 (335)	790 (630)

Standard definition image quality (STD)

(unit: minute)

	STD 9M (HQ)
1GB	10 (10)
2GB	25 (25)
4GB	55 (50)
8GB	115 (105)
16GB	235 (210)
32GB	475 (425)

⚡ Notes

- The recordable time may vary depending on the recording and subject conditions and [ REC MODE] (p. 25).
- The number in () is the minimum recordable time.

Expected number of recordable photos

Internal recording media

You can record the maximum 9,999 photos.

Memory card

	7.1M 
1GB	255
2GB	520
4GB	1000
8GB	2100
16GB	4250
32GB	8500

- The selected image size is effective when the  (Photo) lamp is lit.
- The number of recordable photos of memory card shown is for the maximum image size of your camcorder. The actual number of recordable photos is displayed on the LCD screen during recording (p. 112).
- The number of recordable photos of memory card may vary depending on the recording conditions.

⚡ Notes

- The unique pixel array of Sony's ClearVid and the image processing system (BIONZ) allow still image resolution equivalent to the sizes described.

💡 Tips

- You can also use memory card with a capacity of under 1 GB for recording photos.
- The following list shows the bit-rate, pixels and aspect ratio of each recording mode (movie + audio, etc.).
 - High definition image quality (HD):
 - FX: Max. 24Mbps 1,920 × 1,080 pixels/16:9
 - FH: Approx. 17Mbps (average) 1,920 × 1,080 pixels/16:9
 - HQ: Approx. 9Mbps (average) 1,440 × 1,080 pixels/16:9

- LP: Approx. 5Mbps (average) $1,440 \times 1,080$ pixels/16:9
- Standard definition image quality (STD):
 - HQ: Approx. 9Mbps (average) 720×576 pixels/16:9, 4:3
- The photo recording pixels and the aspect ratio.
 - Photo recording mode:
 - $3,072 \times 2,304$ dots/4:3
 - $3,072 \times 1,728$ dots/16:9
 - $1,600 \times 1,200$ dots/4:3
 - 640×480 dots/4:3
 - Dual recording:
 - $3,072 \times 1,728$ dots/16:9
 - $2,304 \times 1,728$ dots/4:3
 - Capturing a photo from a movie:
 - $1,920 \times 1,080$ dots/16:9
 - 640×360 dots/16:9
 - 640×480 dots/4:3



Using your camcorder abroad

Power supply

You can use your camcorder in any countries/regions using the AC Adaptor supplied with your camcorder within the AC 100 V to 240 V, 50 Hz/60 Hz range.

Viewing high definition image quality (HD) movies

In countries/regions where 1080/50i is supported, you can view the movies with the same high definition image quality (HD) as that of the recorded movies.

You need an PAL-system-based and 1080/50i compatible TV (or monitor) with component and AUDIO/VIDEO input jacks. A component A/V cable or an HDMI cable (sold separately) must be connected.

Viewing standard definition image quality (STD) movies



To view standard definition image quality (STD) movies, you need a PAL-system-based TV with AUDIO/VIDEO input jacks. An A/V connecting cable must be connected.

On TV color systems

Your camcorder is a PAL-system-based camcorder. If you want to view the playback image on a TV, it must be a PAL-system-based TV with an AUDIO/VIDEO input jack.

System	Used in
PAL	Australia, Austria, Belgium, China, Czech Republic, Denmark, Finland, Germany, Holland, Hong Kong, Hungary, Italy, Kuwait, Malaysia, New Zealand, Norway, Poland, Portugal, Singapore, Slovak Republic, Spain, Sweden, Switzerland, Thailand, United Kingdom, etc.
PAL-M	Brazil
PAL-N	Argentina, Paraguay, Uruguay
NTSC	Bahama Islands, Bolivia, Canada, Central America, Chile, Colombia, Ecuador, Guyana, Jamaica, Japan, Korea, Mexico, Peru, Surinam, Taiwan, the Philippines, the USA, Venezuela, etc.
SECAM	Bulgaria, France, Guiana, Iran, Iraq, Monaco, Russia, Ukraine, etc.

Setting to the local time

You can easily set the clock to the local time by setting a time difference when using your camcorder abroad. Touch **MENU** (MENU) → [Show others] → [CLOCK/  LANG] (under  [GENERAL SET] category) → [AREA SET] and [SUMMERTIME] (p. 82).

HDR-CX350VE/XR350VE

When [AUTO CLOCK ADJ] and [AUTO AREA ADJ] are set to [ON], the clock is set to the local time automatically by the GPS function (p. 82).

World time difference

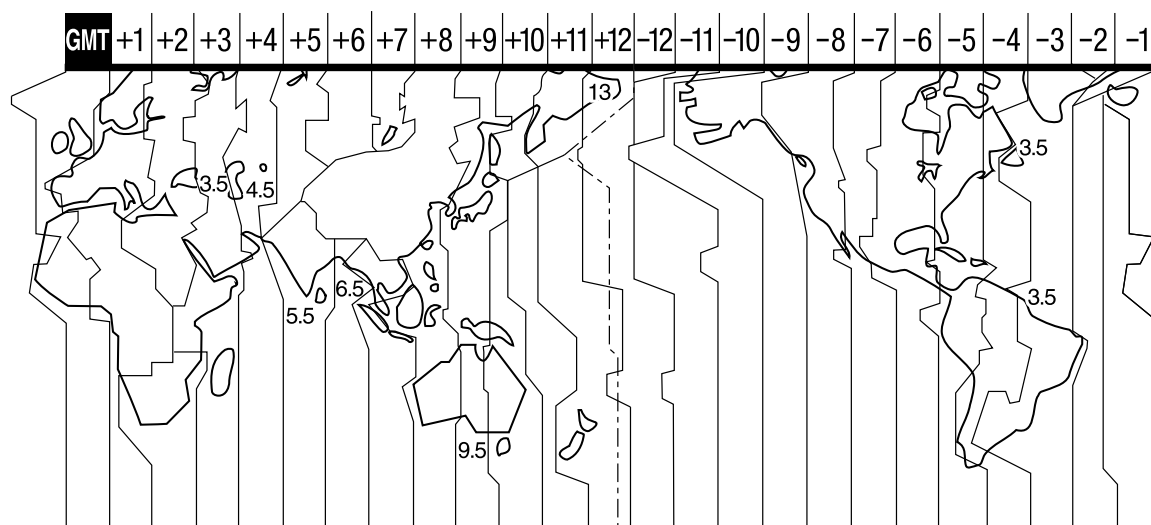

Time-zone differences	Area setting
GMT	Lisbon, London
+01:00	Berlin, Paris
+02:00	Helsinki, Cairo, Istanbul
+03:00	Moscow, Nairobi
+03:30	Tehran
+04:00	Abu Dhabi, Baku
+04:30	Kabul
+05:00	Karachi, Islamabad
+05:30	Calcutta, New Delhi
+06:00	Almaty, Dhaka
+06:30	Yangon
+07:00	Bangkok, Jakarta
+08:00	Hong Kong, Singapore, Beijing
+09:00	Seoul, Tokyo
+09:30	Adelaide, Darwin

Time-zone differences	Area setting
+10:00	Melbourne, Sydney
+11:00	Solomon Is
+12:00	Fiji, Wellington, Niue, Tokelau, Kwajalein
-11:00	Samoa
-10:00	Hawaii
-09:00	Alaska
-08:00	Los Angeles, Tijuana
-07:00	Denver, Arizona
-06:00	Chicago, Mexico City
-05:00	New York, Bogota
-04:00	Santiago
-03:30	St. John's
-03:00	Brasilia, Montevideo
-02:00	Fernando de Noronha
-01:00	Azores, Cape Verde Is.

Maintenance and precautions

About the AVCHD format

What is the AVCHD format?

The AVCHD format is a high definition digital video camera format used to record a high definition (HD) signal of either the 1080i specification*¹ or the 720p specification*² using efficient data compression coding technology. The MPEG-4 AVC/H.264 format is adopted to compress video data, and the Dolby Digital or Linear PCM system is used to compress audio data.

The MPEG-4 AVC/H.264 format is capable of compressing images at higher efficiency than that of the conventional image compressing format. The MPEG-4 AVC/H.264 format enables a high definition video signal shot on a digital video camera recorder to be recorded on 8 cm DVD discs, hard disk drive, flash memory, memory card, etc.

Recording and playback on your camcorder

Based on the AVCHD format, your camcorder records with the high definition image quality (HD) mentioned below. In addition to high definition image quality (HD), your camcorder is capable of recording a standard definition (STD) signal in the conventional MPEG-2 format.

Video signal*³: MPEG-4 AVC/H.264 1920 × 1080/50i, 1440 × 1080/50i

Audio signal: Dolby Digital 2ch

Recording media:

HDR-CX300E/CX305E/CX350E/
CX350VE/CX370E: Internal memory,
memory card

HDR-XR350E/XR350VE: Internal hard
disk, memory card

*¹ 1080i specification

A high definition specification which utilizes 1,080 effective scanning lines and the interlace system.

*² 720p specification

A high definition specification which utilizes 720 effective scanning lines and the progressive system.

*³ Data recorded in AVCHD format other than the above mentioned cannot be played on your camcorder.

About GPS (HDR-CX350VE/ XR350VE)

The GPS (Global Positioning System) is a system that calculates geographical location from highly accurate US space satellites. This system allows you to pinpoint your exact location on the earth. The GPS satellites are located in 6 orbits, 20,000 km above the earth. The GPS system consists of 24 or more GPS satellites. A GPS receiver receives radio signals from the satellites, and calculates the current location of the receiver based on the orbital information (almanac data) and travel time of the signals, etc.

Determining a location is called “triangulating.” A GPS receiver can determine the location’s latitude and longitude by receiving signals from 3 or more satellites.

- As the positions of GPS satellites vary constantly, it may take longer to determine the location or the receiver may not be able to determine the location at all, depending on the location and time you use the camcorder.
- “GPS” is a system for determining geographic location by triangulating radio signals from GPS satellites. Avoid using the camcorder

in places where radio signals are blocked or reflected, such as a shadowy place surrounded by buildings or trees, etc. Use the camcorder in open sky environments.

- You may not be able to record location information at locations or in situations where radio signals from the GPS satellites do not reach the camcorder as follows.
 - In tunnels, indoors or under the shade of buildings.
 - Between tall buildings or at narrow streets surrounded by buildings.
 - In underground locations, locations surrounded by dense trees, under an elevated bridge, or in locations where magnetic fields are generated, such as near high voltage cables.
 - Near devices that generate radio signals of the same frequency band as the camcorder: near 1.5 GHz band mobile telephones, etc.

On triangulating errors

- If you move to another location right after setting the GPS switch to ON, it may take a longer time for the camcorder to start triangulating, compared to when you stay in the same place.
- Error caused by the position of GPS satellites
The camcorder automatically triangulates your current location when the camcorder receives radio signals from 3 or more GPS satellites. The triangulating error allowed by the GPS satellites is about 30 m (98 feet). Depending on the environment of the location, the triangulating error can be greater. In this case, your actual location may not match the location on the map based on the GPS information. Meanwhile, the GPS satellites are controlled by the United States Department of Defense, and the degree of accuracy may be changed intentionally.
- Error during the triangulating process
The camcorder acquires location information every 10 seconds during triangulating. There is a slight time difference between when the location information is acquired and when the location information is recorded on an image,

therefore, the actual recording location may not match exactly the location on the map based on the GPS information.

On the restriction of use of GPS on an airplane

- During take off and landing of an airplane, set the GPS switch to OFF and turn off the camcorder, as you will be instructed to do by the on-board announcement. In other cases, use GPS in accordance with the regulations of the place or situation.

On the map data

- The camcorder contains map data for the following countries/regions. Europe, Japan, North America, Oceania, etc.
- Built-in map is powered by companies as follows; Map of Japan by Zenrin Co., Ltd., other areas by NAVTEQ.
- The map data included is as of the date of production of this manual.
- GPS maps will appear in 2-dimensional graphics except for certain landmarks in Japan, which will appear in 3D.
- The map always displays the north at the top.
- You cannot change the language on the map.
- You cannot update the map data
- The scale of the map is 25 m to 6,000 km.

On the geographic coordinate system

- The “WGS-84” geographic coordinate system is used.

On copyright

- The map data of the camcorder is copyrighted. Unauthorized copying or other usage of the map data may be contrary to the copyright laws.

On the navigation function

- The camcorder does not have a navigation function that uses GPS.

Australia

Copyright. Based on data provided under license from PSMA Australia Limited (www.pasma.com.au).

Austria

© Bundesamt für Eich- und Vermessungswesen
Croatia, Estonia, Latvia, Lithuania, Poland and
Slovenia

© EuroGeographics

France

source: Géoroute® IGN France & BD Carto®
IGN France

Germany

Die Grundlagendaten wurden mit
Genehmigung der zuständigen Behörden
entnommen.

Great Britain

Based upon Crown Copyright material.

Greece

© EuroGeographics; Copyright Geomatics Ltd.

Hungary

Copyright © 2003; Top-Map Ltd.

Italy

La Banca Dati Italiana è stata prodotta usando
quale riferimento anche cartografia numerica
ed al tratto prodotta e fornita dalla Regione
Toscana.

Japan

- 日本の地図の作成にあたっては、国土地理院長の承認を得て、同院発行の2万5千分の1地形図を使用しています。(承認番号 平20業使、第204-46号)
- 日本の地図の作成にあたっては、国土地理院長の承認を得て、同院の技術資料H-1-No.3「日本測地系における離島位置の補正量」を使用しています。(承認番号 国地企調発第78号 平成16年4月23日)

Norway

Copyright © 2000; Norwegian Mapping
Authority

Portugal

Source: IgeoE – Portugal

Spain

Información geográfica propiedad del CNIG

Sweden

Based upon electronic data © National Land
Survey Sweden.

Switzerland

Topografische Grundlage: © Bundesamt für
Landestopographie.

About the “Memory Stick” media

“Memory Stick” media are a compact, portable IC recording medium with a large data capacity.

You can use only “Memory Stick Duo” media, which are about the half size of standard “Memory Stick” media, with your camcorder.

However, we do not guarantee the operation of all types of “Memory Stick Duo” media on your camcorder.

Types of “Memory Stick” media	Recording/Playback
“Memory Stick Duo” media (with MagicGate)	—
“Memory Stick PRO Duo” media	○
“Memory Stick PRO-HG Duo” media	○*

- * This product does not support 8-bit parallel data transfer but it supports 4-bit parallel data transfer the same as with “Memory Stick PRO Duo” media.
- This product cannot record or play data that uses “MagicGate” technology. “MagicGate” is a copyright protection technology that records and transfers the contents in an encrypted format.
- “Memory Stick PRO Duo” media formatted by a computer (Windows OS/Mac OS) does not have guaranteed compatibility with your camcorder.
- Data read/write speed may vary depending on the combination of the “Memory Stick PRO Duo” media and “Memory Stick PRO Duo” media compliant product you use.
- Damaged or lost data may occur in the following cases (the data will not be compensated for):
 - If you eject the “Memory Stick PRO Duo” media, or turn off your camcorder while your camcorder is reading or writing image files on the “Memory Stick PRO Duo” media (while the access lamp is lit or flashing)
 - If you use the “Memory Stick PRO Duo”

media near magnets or magnetic fields

- It is recommended that you make a back-up of important data on the hard disk of a computer.
- Do not attach a label or the like on “Memory Stick PRO Duo” media or “Memory Stick Duo” media adaptor.
- Do not touch, or allow metallic objects to come into contact with the terminals.
- Do not bend, drop or apply strong force to the “Memory Stick PRO Duo” media.
- Do not disassemble or modify the “Memory Stick PRO Duo” media.
- Do not let the “Memory Stick PRO Duo” media get wet.
- Keep the “Memory Stick PRO Duo” media out of the reach of small children. There is danger that a child might swallow it.
- Do not insert anything other than “Memory Stick PRO Duo” media into the “Memory Stick Duo” media slot. Doing so may cause a malfunction.
- Do not use or keep the “Memory Stick PRO Duo” media in the following locations:
 - Places subject to extremely high temperature, such as a car parked outside in the summer
 - Places under direct sunlight
 - Places with extremely high humidity or subject to corrosive gases

On the “Memory Stick Duo” media adaptor

- When using “Memory Stick PRO Duo” media with “Memory Stick” media compliant device, be sure to insert the “Memory Stick PRO Duo” media into “Memory Stick Duo” media adaptor.
- When using “Memory Stick PRO Duo” media with “Memory Stick” media compliant device inserting “Memory Stick PRO Duo” media into “Memory Stick Duo” media adaptor, make sure the “Memory Stick PRO Duo” media are inserted facing in the correct direction. Note that improper use may cause a malfunction.
- When using “Memory Stick PRO Duo” media inserted into “Memory Stick Duo” media adaptor on “Memory Stick” media compliant device, make sure the “Memory Stick PRO Duo” media adaptor is inserted into the device

in the correct direction. If inserted in the wrong direction, the device may be damaged.

- Do not insert “Memory Stick Duo” media adaptor without “Memory Stick PRO Duo” media attached into “Memory Stick” media compliant device. Doing so may result in malfunctions of the device.

On image data compatibility

- Image data files recorded on “Memory Stick PRO Duo” media by your camcorder conform to the “Design rule for Camera File system” universal standard established by the JEITA (Japan Electronics and Information Technology Industries Association).
- On your camcorder, you cannot play back photos recorded on other devices (DCR-TRV900E or DSC-D700/D770) that do not conform to the universal standard. (These models are not sold in some regions.)
- If you cannot use “Memory Stick PRO Duo” media that have been used with another device, format it with your camcorder (p. 79). Note that formatting erases all information on the “Memory Stick PRO Duo” media.
- You may not be able to play back images with your camcorder:
 - When playing back image data modified on your computer
 - When playing back image data recorded with other devices

About the “InfoLITHIUM” battery pack

Your camcorder operates only with an “InfoLITHIUM” V series battery packs. “InfoLITHIUM” V series battery packs have the  mark.

What is an “InfoLITHIUM” battery pack?

- An “InfoLITHIUM” battery pack is a lithium-ion battery pack that has functions for communicating information related to operating conditions between your camcorder and an AC Adaptor/charger (sold separately).

- The “InfoLITHIUM” battery pack calculates the power consumption according to the operating conditions of your camcorder, and displays the remaining battery time in minutes.
- The battery pack NP-FV50 is compatible with “ActiFORCE.”
“ActiFORCE” is a new generation power system. Battery capacity, boost charge, and the speed and accuracy of battery time remaining calculations have been improved when compared with current “InfoLITHIUM” P-series battery.

To charge the battery pack

- Be sure to charge the battery pack before you start using your camcorder.
- We recommend charging the battery pack in an ambient temperature of between 10 °C to 30 °C (50 °F to 86 °F) until the /CHG (flash/charge) lamp turns off. If you charge the battery pack outside of this temperature range, you may not be able to charge it efficiently.

To use the battery pack effectively

- Battery pack performance decreases when the ambient temperature is 10 °C (50 °F) or below, and the length of time you can use the battery pack becomes shorter. In that case, do one of the following to use the battery pack for a longer time.
 - Put the battery pack in a pocket to warm it up, and install it on your camcorder right before you start taking shots.
 - Use a large capacity battery pack: NP-FV70/ NP-FV100 (sold separately).
- Frequent use of the LCD screen or a frequent playback, fast forward or reverse operation wears out the battery pack faster. We recommend using a large capacity battery pack: NP-FV70/ NP-FV100 (sold separately).
- Be sure to close the LCD screen when not recording or playing back on your camcorder. The battery pack is also consumed when your camcorder is in recording standby or playback pause.
- Have spare battery packs ready for 2 or 3 times the expected recording time, and make trial

recordings before making the actual recording.

- Do not expose the battery pack to water. The battery pack is not water resistant.

About the remaining battery time indicator

- When the power goes off even though the remaining battery time indicator indicates that the battery pack has enough power to operate, charge the battery pack fully again. Remaining battery time will be indicated correctly. Note, however, that the battery indication will not be restored if it is used in high temperatures for a long time, or if left in a fully charged state, or when the battery pack is frequently used. Use the remaining battery time indication as a rough guide only.
- The  mark that indicates low battery flashes even if there are still 20 minutes of battery time remaining, depending on the operating conditions or ambient temperature.

About storage of the battery pack

- If the battery pack is not used for a long time, fully charge the battery pack and use it up on your camcorder once a year to maintain proper function. To store the battery pack, remove it from your camcorder and put it in a dry, cool place.
- To discharge the battery pack on your camcorder completely, touch **MENU** (MENU) → [Show others] → [POWER SETTINGS] (under  [GENERAL SET] category) → [A.SHUT OFF] → [NEVER], and leave your camcorder in recording standby until the power goes off (p. 83).

About battery life

- Battery capacity decreases over time and through repeated use. If decreased usage time between charges becomes significant, it is probably time to replace it with a new one.
- Each battery’s life is governed by storage, operating and environmental conditions.

About x.v.Color

- x.v.Color is a more familiar term for the xvYCC standard proposed by Sony, and is a trademark of Sony.
- xvYCC is an international standard for color space in video. This standard can express a wider color range than the currently used broadcast standard.

About handling of your camcorder

On use and care

- Do not use or store the camcorder and accessories in the following locations:
 - Anywhere extremely hot, cold or humid. Never leave them exposed to temperatures above 60 °C (140 °F), such as under direct sunlight, near heaters or in a car parked in the sun. They may malfunction or become deformed.
 - Near strong magnetic fields or mechanical vibration. The camcorder may malfunction.
 - Near strong radio waves or radiation. The camcorder may not be able to record properly.
 - Near AM receivers and video equipment. Noise may occur.
 - On a sandy beach or anywhere dusty. If sand or dust gets in your camcorder, it may malfunction. Sometimes this malfunction cannot be repaired.
 - Near windows or outdoors, where the LCD screen, or the lens may be exposed to direct sunlight. This damages the LCD screen.
- Operate your camcorder on DC 6.8 V/7.2 V (battery pack) or DC 8.4 V (AC Adaptor).
- For DC or AC operation, use the accessories recommended in these operating instructions.
- Do not let your camcorder get wet, for example, from rain or sea water. If your camcorder gets wet, it may malfunction. Sometimes this malfunction cannot be repaired.
- If any solid object or liquid gets inside the casing, unplug your camcorder and have it checked by a Sony dealer before operating it any further.
- Avoid rough handling, disassembling,

modifying, physical shock, or impact such as hammering, dropping or stepping on the product. Be particularly careful of the lens.

- Keep the LCD screen closed when you are not using your camcorder.
- Do not wrap your camcorder with a towel, for example, and operate it. Doing so might cause heat to build up inside.
- When disconnecting the power cord (mains lead), pull it by the plug and not the cord.
- Do not damage the power cord (mains lead) such as by placing anything heavy on it.
- Do not use a deformed or damaged battery pack.
- Keep metal contacts clean.
- If the battery electrolytic liquid has leaked:
 - Consult your local authorized Sony service facility.
 - Wash off any liquid that may have contacted your skin.
 - If any liquid gets in your eyes, wash with plenty of water and consult a doctor.

When not using your camcorder for a long time

- To keep your camcorder in optimum state for a long time, turn it on and let it run by recording and playing back images about once a month.
- Use up the battery pack completely before storing it.

Moisture condensation

If your camcorder is brought directly from a cold place to a warm place, moisture may condense inside your camcorder. This may cause a malfunction to your camcorder.

- If moisture condensation has occurred
Leave your camcorder for about 1 hour without turning it on.
- Note on moisture condensation
Moisture may condense when you bring your camcorder from a cold place into a warm place (or vice versa) or when you use your camcorder in a humid place as follows:
 - You bring your camcorder from a ski slope into a place warmed up by a heating device.
 - You bring your camcorder from an air

conditioned car or room into a hot place outside.

- You use your camcorder after a squall or a shower.
- You use your camcorder in a hot and humid place.

- How to prevent moisture condensation

When you bring your camcorder from a cold place into a warm place, put your camcorder in a plastic bag and seal it tightly. Remove the bag when the air temperature inside the plastic bag has reached the surrounding temperature (after about 1 hour).

LCD screen

- Do not exert excessive pressure on the LCD screen, as it may cause uneven color and other damage.
- If your camcorder is used in a cold place, a residual image may appear on the LCD screen. This is not a malfunction.
- While using your camcorder, the back of the LCD screen may heat up. This is not a malfunction.

To clean the LCD screen

- If fingerprints or dust make the LCD screen dirty, it is recommended that you use a soft cloth to clean it.
- When you use the LCD Cleaning Kit (sold separately), do not apply the cleaning liquid directly to the LCD screen. Use cleaning paper moistened with the liquid.

On adjustment of the touch panel (CALIBRATION)

The buttons on the touch panel may not work correctly. If this happens, follow the procedure below. It is recommended that you connect your camcorder to the wall outlet (wall socket) using the supplied AC Adaptor during the operation.

- ① **MENU** (MENU) → [Show others] → [OTHER SETTINGS] (under  [GENERAL SET] category) → [CALIBRATION].

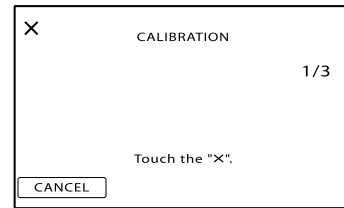

- ② Touch "X" displayed on the screen with the corner of memory card or the like 3 times. Touch [CANCEL] to cancel calibration.

⚡ Notes

- If you did not press the right spot, try the calibration again.
- Do not use a sharp-pointed object for calibration. Doing so may damage the LCD screen.
- You cannot calibrate the LCD screen if it is rotated, or closed with the screen facing out.

On handling the casing

- If the casing is soiled, clean the camcorder body with a soft cloth lightly moistened with water, and then wipe the casing with a dry soft cloth.
- Avoid the following to avoid damage to the finish:
 - Using chemicals such as thinner, benzine, alcohol, chemical cloths, repellent, insecticide and sunscreen
 - Handling the camcorder with above substances on your hands
 - Leaving the casing in contact with rubber or vinyl objects for a long period of time

About care and storage of the lens

- Wipe the surface of the lens clean with a soft cloth in the following instances:
 - When there are fingerprints on the lens surface
 - In hot or humid locations
 - When the lens is exposed to salty air such as at the seaside
- Store in a well-ventilated location subject to little dirt or dust.
- To prevent mold, periodically clean the lens as described above.

On charging the pre-installed rechargeable battery

Your camcorder has a pre-installed rechargeable battery to retain the date, time, and other settings even when the LCD screen is closed. The pre-installed rechargeable battery is always charged while your camcorder is connected to the wall outlet (wall socket) via the AC Adaptor or while the battery pack is attached. The rechargeable battery will be fully discharged in about 3 months if you do not use your camcorder at all. Use your camcorder after charging the pre-installed rechargeable battery.

However, even if the pre-installed rechargeable battery is not charged, the camcorder operation will not be affected as long as you are not recording the date.

How to charge the pre-installed rechargeable battery

Connect your camcorder to a wall outlet (wall socket) using the supplied AC Adaptor, and leave it with the LCD screen closed for more than 24 hours.

Note on disposal/transfer

Even if you delete all movies and still images, or perform [MEDIA FORMAT] (p. 79), data on the internal recording media may not be completely erased. When you transfer the camcorder, it is recommended that you perform [EMPTY] (p. 79) to prevent the recovery of your data. Also, when you dispose of the camcorder, it is recommended that you destroy the actual body of the camcorder.

Note on disposal/transfer of the memory card

Even if you delete data in the memory card or format the memory card on your camcorder or a computer, you may not delete data from the memory card completely. When you give the memory card to somebody, it is recommended that you delete data completely using data deletion software on a computer. Also, when you dispose of the memory card, it is recommended that you destroy the actual body of the memory card.

On trademarks

- “Handycam” and **HANDYCAM** are registered trademarks of Sony Corporation.
- “AVCHD” and “AVCHD” logotype are trademarks of Panasonic Corporation and Sony Corporation.
- “Memory Stick,” “,” “Memory Stick Duo,” “**MEMORY STICK DUO**,” “Memory Stick PRO Duo,” “**MEMORY STICK PRO DUO**,” “Memory Stick PRO-HG Duo,” “**MEMORY STICK PRO-HG DUO**,” “MagicGate,” “**MAGIC GATE**,” “MagicGate Memory Stick” and “MagicGate Memory Stick Duo” are trademarks or registered trademarks of Sony Corporation.
- “InfoLITHIUM” is a trademark of Sony Corporation.
- “x.v.Colour” is a trademark of Sony Corporation.
- “BIONZ” is a trademark of Sony Corporation.
- “BRAVIA” is a trademark of Sony Corporation.
- “DVDirect” is a trademark of Sony Corporation.
- “Blu-ray Disc” and the logo are trademarks.
- Dolby and the double-D symbol are trademarks of Dolby Laboratories.
- HDMI, the HDMI logo and High-Definition Multimedia Interface are trademarks or registered trademarks of HDMI Licensing LLC.
- Microsoft, Windows, Windows Vista, and DirectX are either registered trademarks or trademarks of Microsoft Corporation in the United States and/or other countries.
- Macintosh and Mac OS are registered trademarks of Apple Inc. in the U.S. and other countries.
- Intel, Intel Core, and Pentium are trademarks or registered trademarks of Intel Corporation or its subsidiaries in the United States and other countries.
- “PlayStation” is a registered trademark of Sony Computer Entertainment Inc..
- Adobe, the Adobe logo, and Adobe Acrobat are either registered trademarks or trademarks of Adobe Systems Incorporated in the United States and/or other countries.
- NAVTEQ and the NAVTEQ Maps logo are trademarks of NAVTEQ in the US and other countries.

- SDHC logo is a trademark.



- MultiMediaCard is a trademark of MultiMediaCard Association.

All other product names mentioned herein may be the trademarks or registered trademarks of their respective companies. Furthermore, ™ and ® are not mentioned in each case in this Handbook.

Notes on the License

ANY USE OF THIS PRODUCT OTHER THAN CONSUMER PERSONAL USE IN ANY MANNER THAT COMPLIES WITH THE MPEG-2 STANDARD FOR ENCODING VIDEO INFORMATION FOR PACKAGED MEDIA IS EXPRESSLY PROHIBITED WITHOUT A LICENSE UNDER APPLICABLE PATENTS IN THE MPEG-2 PATENT PORTFOLIO, WHICH LICENSE IS AVAILABLE FROM MPEG LA, L.L.C., 250 STEELE STREET, SUITE 300, DENVER, COLORADO 80206.

THIS PRODUCT IS LICENSED UNDER THE AVC PATENT PORTFOLIO LICENSE FOR THE PERSONAL AND NON-COMMERCIAL USE OF A CONSUMER TO

(i) ENCODE VIDEO IN COMPLIANCE WITH THE AVC STANDARD (“AVC VIDEO”) AND/OR

(ii) DECODE AVC VIDEO THAT WAS ENCODED BY A CONSUMER ENGAGED IN A PERSONAL AND

NON-COMMERCIAL ACTIVITY AND/OR WAS OBTAINED FROM A VIDEO PROVIDER LICENSED TO PROVIDE AVC VIDEO.

NO LICENSE IS GRANTED OR SHALL BE IMPLIED FOR ANY OTHER USE.

ADDITIONAL INFORMATION MAY BE OBTAINED FROM MPEG LA, L.L.C.

SEE <[HTTP://MPEGLA.COM](http://MPEGLA.COM)>

“C Library,” “Expat,” “zlib,” “libjpeg,” “dtoa,” and “pcre” software are provided in your camcorder.

We provide this software based on license agreements with their owners of copyright. Based on requests by the owners of copyright of these software applications, we have an obligation to inform you of the following. Please read the following sections.

Read “license1.pdf” in the “License” folder on the CD-ROM. You will find licenses (in English) of “C Library,” “Expat,” “zlib,” “libjpeg,” “dtoa,” and “pcre” software.

On GNU GPL/LGPL applied software

The software that is eligible for the following GNU General Public License (hereinafter referred to as “GPL”) or GNU Lesser General Public License (hereinafter referred to as “LGPL”) are included in the camcorder.

This informs you that you have a right to have access to, modify, and redistribute source code for these software programs under the conditions of the supplied GPL/LGPL.

Source code is provided on the web. Use the following URL to download it. When downloading the source code, select DCR-SX43 as the model for your camcorder.

<http://www.sony.net/Products/Linux/>

We would prefer you do not contact us about the contents of source code.

Read “license2.pdf” in the “License” folder on the CD-ROM. You will find licenses (in English) of “GPL,” and “LGPL” software.

To view the PDF, Adobe Reader is needed. If it is not installed on your computer, you can download it from the Adobe Systems web page:
<http://www.adobe.com/>

Screen indicators

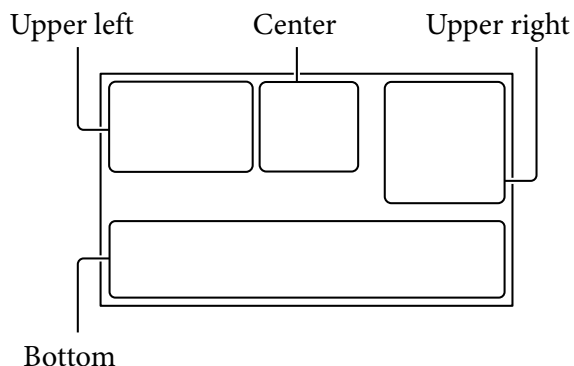

Upper left

Indicator	Meaning
	MENU button (61)
	Self-timer recording (74)
	GPS tracking status (48)
	Flash (75)/ REDEYE REDUC (75)
	MICREF LEVEL low (73)
	WIDE SELECT (74)
	BLT-IN ZOOM MIC (73)
	Remaining battery
	Recording folder
	Return button (61)

Center

Indicator	Meaning
[STBY]/[REC]	Recording status (20)
	Photo size (74)
	Slide show set (35)
	Warning (92)
	Playback mode (29)
	Drop sensor off (84)
	Drop sensor activated (84)







Upper right

Indicator	Meaning
	Recording image quality (HD/STD) and recording mode (FX/FH/HQ/LP) (25)
	Recording/playback/ editing media (17)
0:00:00	Counter (hour:minute: second) (29)
[00min]	Estimated recording remaining time (20)
	FADER (66)
9999	Approximate number of recordable photos and recording media (23)
	Playback folder (30)
100/112	Current playing movie or photo/Number of total recorded movies or photos (29)

Bottom

Indicator	Meaning
	[FACE DETECTION] set to [OFF] (72)
	SMILE DETECTION (72)
	LOW LUX (72)
	Manual focus (69)
	SCENE SELECTION (66)
	White balance (67)
	SteadyShot off (71)
	SPOT MTR/FCS (68)/ SPOT METER (68)/ EXPOSURE (68)
	TELE MACRO (69)
(COLOR)	X.V.COLOR (74)
	CONVERSION LENS (71)
	INTELLIGENT AUTO (24)

Parts and controls

Indicator	Meaning
	OPTION button (63)
	VIEW IMAGES button (28)
	Slide show button (35)
	MY LOCATION button (49)
 101-0005	Data file name (30)
	Protected image (40)
	Index button (30)

- Indicators and their positions are approximate and may differ from what you actually see.
- Some indicators may not appear, depending on your camcorder model.

Figures in () are reference pages.

HDR-CX300E/CX305E/CX350E/ CX350VE/CX370E

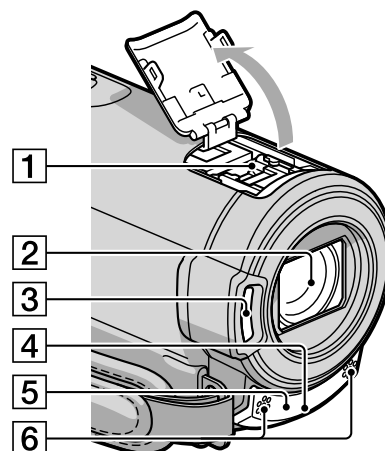

HDR-XR350E/XR350VE

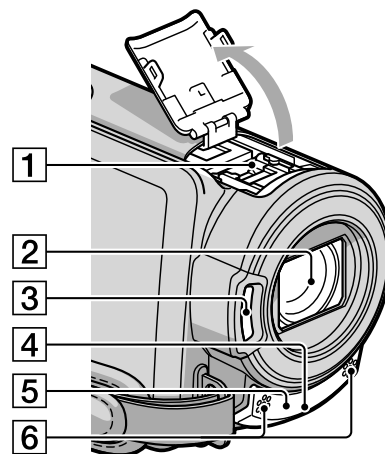

1 Active Interface Shoe



The Active Interface Shoe supplies power to accessories such as a video light, a flash, or a microphone (sold separately). The accessory can be turned on or off as you open or close the LCD screen of your camcorder. Refer to the operating instructions supplied with your accessory for details.

The Active Interface Shoe has a safety device for fixing the installed accessory securely. To connect an accessory, press down and push it to the end, and then tighten the screw. To

remove an accessory, loosen the screw, and then press down and pull out the accessory.

- When you open or close the shoe cover, slide it as indicated by the arrow.
- When you are recording movies with an external flash (sold separately) connected to the accessory shoe, turn off the power of the external flash to prevent charging noise being recorded.
- You cannot use an external flash (sold separately) and the built-in flash at the same time.
- When an external microphone (sold separately) is connected, it takes precedence over the built-in microphone.

2 Lens (G lens)

3 Flash

4 Camera recording lamp (84)

The camera recording lamp lights up in red during recording. The lamp flashes when the remaining recording media capacity or battery power is low.

5 Remote sensor/Infrared port

Point the Wireless Remote Commander (p. 115) towards the remote sensor to operate your camcorder.

6 Built-in microphone

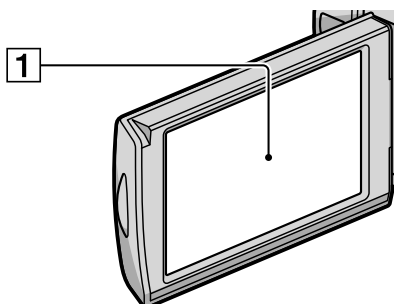

1 LCD screen/Touch panel (15, 27)

If you rotate the LCD panel 180 degrees, you can close the LCD panel with the LCD screen facing out. This is convenient during playback operations.

HDR-CX300E/CX305E/CX350E/ CX350VE/CX370E

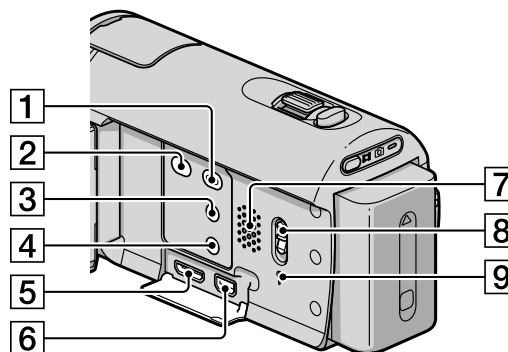

HDR-XR350E/XR350VE

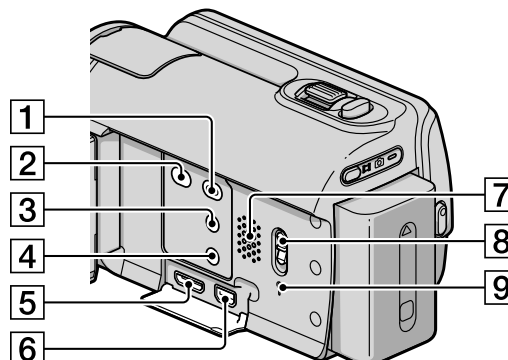

1 (VIEW IMAGES) button (28)

2 (DISC BURN) button (see Operating Guide)

3 (INTELLIGENT AUTO) button (24)

4 POWER button (15)

5 HDMI OUT jack (36)

6 (USB) jack (55, 58)

HDR-CX305E: output only

7 Speaker

8 GPS switch (HDR-CX350VE/XR350VE) (48)

9 RESET button

Press RESET using a pointed object.

Press RESET to initialize all the settings including the clock setting.

**HDR-CX300E/CX305E/CX350E/
CX350VE/CX370E**

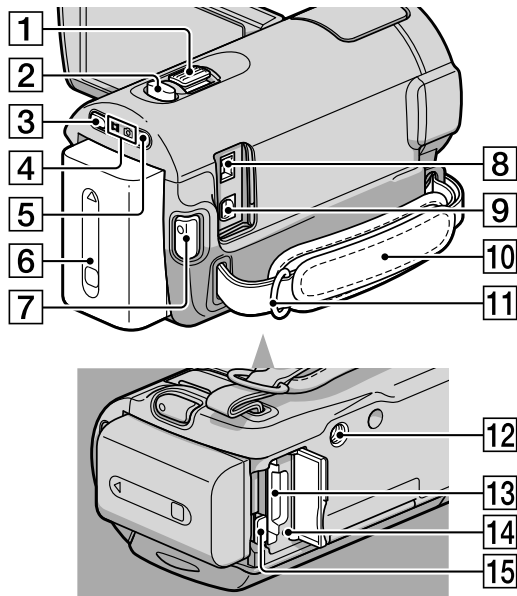

HDR-XR350E/XR350VE

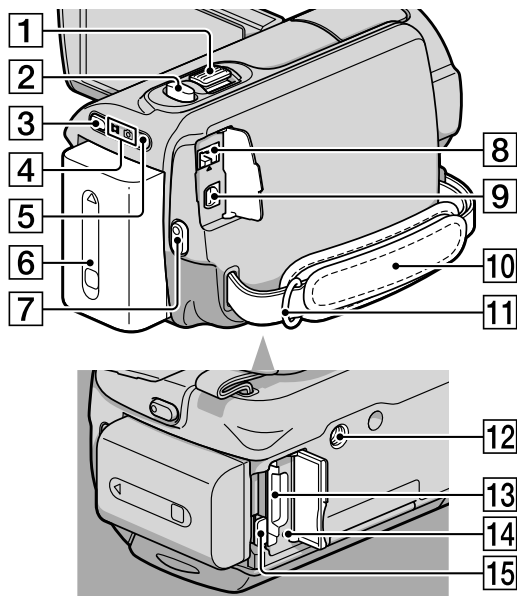

- 1 Power zoom lever (24, 34)
- 2 PHOTO button (23)
- 3 MODE button (20)
- 4 (Movie)/ (Photo) lamps (20)
- 5 /CHG (flash/charge) lamp (12)
- 6 Battery pack (12)

- 7 START/STOP button (20)
- 8 DC IN jack (12)
- 9 A/V Remote Connector (36)
- 10 Grip belt (20)
- 11 Hook for a shoulder belt
- 12 Tripod receptacle
Attach a tripod (sold separately) to the tripod receptacle using a tripod screw (sold separately: the length of the screw must be less than 5.5 mm (7/32 in.)).
- 13 Memory card slot (19)
- 14 Memory card Access lamp (19)
While the lamp is lit or flashing, the camcorder is reading or writing data.
- 15 PUSH (battery release) button (13)

Wireless Remote Commander

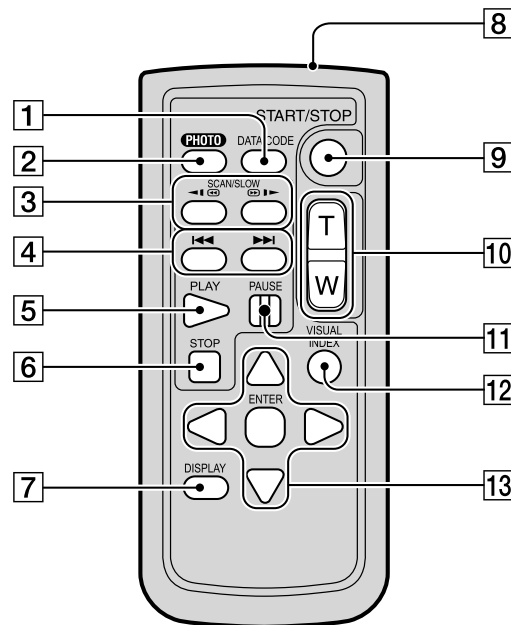

- 1 DATA CODE button (76)
Displays the date and time, camera setting data, or coordinates (HDR-CX350VE/ XR350VE) of the recorded images when you press this button during playback.
- 2 PHOTO button (23)
The on-screen image when you press this button will be recorded as a still image.

- 3 SCAN/SLOW buttons (29)
- 4 ◀▶/▶▶ (Previous/Next) buttons (29)
- 5 PLAY button
- 6 STOP button
- 7 DISPLAY button (21)
- 8 Transmitter
- 9 START/STOP button (20)
- 10 Power zoom buttons
- 11 PAUSE button
- 12 VISUAL INDEX button (29)
Displays a VISUAL INDEX screen during playback.
- 13 ◀▶/▲▼/ENTER buttons
When you press any of these buttons, the orange frame appears on the LCD screen. Select a desired button or an item with ◀▶/▲▼, then press ENTER to enter.

⚡ Notes

- Remove the insulation sheet before using the Wireless Remote Commander.

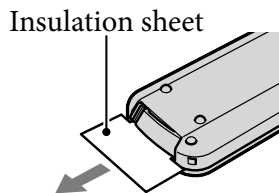

- Point the Wireless Remote Commander towards the remote sensor to operate your camcorder (p. 114).
- When no commands have been sent from the Wireless Remote Commander within a certain period, the orange frame disappears. When you press any of ◀▶/▲▼, or ENTER again, the frame appears at the position where it was displayed last.
- You cannot select some buttons on the LCD screen using ◀▶/▲▼.

To change the battery of the Wireless Remote Commander

- 1 While pressing on the tab, inset your fingernail into the slit to pull out the battery case.
- 2 Place a new battery with the + side facing up.
- 3 Insert the battery case back into the Wireless Remote Commander until it clicks.

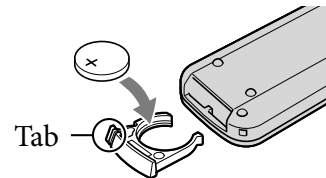

WARNING

Battery may explode if mistreated. Do not recharge, disassemble or dispose of in fire.

- When the lithium battery becomes weak, the operating distance of the Wireless Remote Commander may shorten, or the Wireless Remote Commander may not function properly. In this case, replace the battery with a Sony CR2025 lithium battery. Use of another battery may present a risk of fire or explosion.

Index

Symbols

1080i/576i.....	82
16:9.....	81
4:3.....	81
576i.....	82

A

A.SHUT OFF.....	83
A/V connecting cable.....	37, 59
Abroad.....	100
AREA SET.....	82
AUDIO REC SET.....	73
AUTO AREA ADJ.....	51
AUTO BACK LIGHT.....	73
AUTO CLOCK ADJ.....	51
AVCHD format.....	102

B

BATTERY INFO.....	78
Battery of the Wireless Remote Commander.....	116
Battery pack.....	12
BEACH.....	66
BEEP.....	80
BLACK FADER.....	67
BLT-IN ZOOM MIC.....	73
“BRAVIA” Sync.....	38

C

CALIBRATION.....	108
CAMERA DATA.....	77
Capturing a photo from a movie.....	42
Charging the battery pack.....	12
Charging the battery pack abroad.....	14, 100
CLOCK/LANG.....	82
CLOCK SET.....	15
COMPONENT.....	82
CONVERSION LENS.....	71
COORDINATES.....	50
Copy.....	44
Creating a disc.....	54
CTRL FOR HDMI.....	84

D

DATA CODE.....	16, 76
DATE/TIME.....	16, 77
Date Index.....	31
DELETE.....	39
DEMO MODE.....	83
DIGITAL ZOOM.....	73
Disc recorder.....	59
DISPLAY SET.....	81
DISP OUTPUT.....	82
DIVIDE.....	41
DOWNLOAD MUSIC.....	34
DROP SENSOR.....	84
Dual Rec.....	27
Dubbing.....	43
DVDirect Express.....	55
DVD writer.....	55, 58

E

EDIT.....	39
EMPTY.....	79
EMPTY MUSIC.....	34
EXPOSURE.....	68
External media.....	52

F

FACE DETECTION.....	72, 91
Face Index.....	32
FADER.....	66
FH.....	25
FILE NO.....	76
Film Roll Index.....	31
FIREWORKS.....	66
FLASH LEVEL.....	75
FLASH MODE.....	75
FOCUS.....	69
Format.....	79
Fully charged.....	12
FX.....	25

G

GENERAL SET.....	80
GOLF SHOT.....	69
GPS.....	47
GUIDEFRAAME.....	71

H

HD/STD SET.....	25
HDMI RESOLUTION.....	82
HIGHLIGHT.....	32
Highlight Playback.....	32
HQ.....	25

I

IMAGE SIZE.....	74
INDOOR.....	67
“InfoLITHIUM” battery pack.....	105
INTELLIGENT AUTO.....	24, 91

L

LANDSCAPE.....	66
LANGUAGE SET.....	16, 83
LCD BL LEVEL.....	80
LCD BRIGHT.....	80
LCD COLOR.....	81
LOW LUX.....	72
LP.....	25

M

Maintenance.....	102
MANAGE MEDIA.....	17, 79
MANUAL SETTINGS.....	66
Map Index.....	49
MEDIA FORMAT.....	79
MEDIA INFO.....	79
MEDIA SETTINGS.....	17
Memory card.....	18
“Memory Stick” media.....	18, 104
“Memory Stick PRO-HG Duo” media.....	18, 104
“Memory Stick PRO Duo” media.....	18, 104
Menus.....	61, 64
MICREF LEVEL.....	73
Mirror mode.....	27
Moisture condensation.....	107
MOVIE DUB.....	43
MOVIE MEDIA SET.....	17
Movies.....	20, 29
MPEG-4 AVC/H.264.....	102

MUSIC TOOL78
 MY MENU62
 MY MENU SETTING62

O

ONE PUSH67
 Operation flow.....6
 OPTION MENU63
 Original.....43
 OTHER REC SET.....73
 OTHERS78
 OTHER SETTINGS83
 OUTDOOR.....67
 OUTPUT SETTINGS.....81

P

PAL100
 PB zoom.....34
 PHOTO CAPTURE42
 PHOTO COPY44
 PHOTO MEDIA SET17
 Photos22, 30
 PHOTO SETTINGS.....74
 PLAYBACK.....76
 PLAYBACK SET76
 Playing.....28
 Playlist.....45
 PLAYLIST EDIT45
 PORTRAIT.....66
 Power on15
 POWER ON BY LCD83
 POWER SETTINGS83
 Precautions102
 PRIORITY SETTING72, 92
 PROTECT40

R

REC LAMP.....84
 REC MODE.....25
 Recording20
 Recording and playback time ...96
 Recording media.....17
 Recording time of movies/
 number of recordable photos...96
 REDEYE REDUC.....75

REMOTE CTRL84
 Repair85
 REPAIR IMG.DB F.....89, 94
 RESET114

S

Saving images in external
 media.....52
 SCENARIO.....33
 SCENARIO ERASE.....34
 SCENE SELECTION66, 92
 Screen indicators112
 Self-diagnosis display/Warning
 indicators92
 SELF-TIMER.....74
 SHOOTING SET71
 Slide show35
 SLIDE SHOW SET35
 SMILE DETECTION72, 92
 SMILE SENSITIVITY.....73, 92
 Smile Shutter27
 SMTH SLW REC.....70
 SNOW66
 SOUND/DISP SET.....80
 SPOT FOCUS68
 SPOTLIGHT66
 SPOT METER.....68
 SPOT MTR/FCS.....68
 STEADYSHOT71, 75
 SUMMERTIME.....83
 SUNRISE&SUNSET.....66
 Supplied items.....2

T

TELE MACRO69
 Telephoto24
 Thumbnail.....39
 Tripod.....115
 Troubleshooting.....85
 TV.....36
 TV color systems100
 TV CONNECT Guide36
 TV TYPE81
 TWILIGHT66
 TWILIGHT PORT.66

U

USB cable.....55, 58
 USB CONNECT55, 58

V

VBR.....96
 VIEW IMAGES28, 31
 VISUAL INDEX28
 Volume.....30, 80

W

Wall outlet (wall socket)12
 Warning messages94
 WHITE BAL.67
 WHITE FADER.....67
 Wide angle.....24
 WIDE SELECT74

X

x.v.Color..... 74, 107

Y

YOUR LOCATION.....49

Z

Zoom.....24, 34

Additional information on this product and answers to frequently asked questions can be found at our Customer Support Website.

<http://www.sony.net/>

日本語

■ AVCHDディスクの再生の互換性について

- DVDプレーヤーやDVDレコーダーはAVCHD規格に非対応のため、「PMB」や対応機器を使って作成したAVCHDのディスクを再生できません。
- AVCHDのディスクはDVDプレーヤーやDVDレコーダーに入れないでください。ディスクの取り出しができなくなることがあります。
- AVCHDのディスクは、AVCHD規格に対応したブルーレイディスクプレーヤー、レコーダーなどで再生できます。

English

■ Notes on compatibility of AVCHD disc

This camcorder captures high definition footage in the AVCHD format. High definition footage can be copied onto DVD media. However, DVD media containing AVCHD footage should not be used with DVD based players or recorders, as the DVD player/recorder may fail to eject the media and may erase its contents without warning. DVD media containing AVCHD footage may be played on a compatible Blu-ray Disc™ player/recorder or other compatible device.

Français

■ Remarques sur la compatibilité des disques AVCHD

Ce caméscope capture des vidéos haute définition en format AVCHD. Les vidéos haute définition peuvent être copiées sur support DVD. Toutefois, un support DVD contenant des vidéos AVCHD ne doit pas être utilisé sur des lecteurs ou graveurs de DVD; le lecteur/graveur de DVD risquerait de ne pas pouvoir éjecter le support et pourrait effacer le contenu de ce dernier sans avertissement. Un support DVD contenant des vidéos AVCHD peut être lu sur un lecteur/graveur de Blu-Ray Disc™ compatible ou sur tout autre appareil compatible.

Deutsch

■ Hinweise zur Kompatibilität von AVCHD-Discs

Dieser Camcorder zeichnet Filmmaterial hoher Auflösung im AVCHD-Format auf. Filmmaterial hoher Auflösung auf DVD-Medien kopiert werden. DVD-Medien, die AVCHD-Material enthalten, sollten jedoch nicht mit DVD-Spielern oder DVD-Aufnahmegeräten verwendet werden, da der DVD-Spieler bzw. das DVD-Aufnahmegerät das Medium unter Umständen nicht auswirft bzw. dessen Inhalt ohne vorherige Warnung löscht. DVD-Medien, die AVCHD-Material enthalten, können auf einem kompatiblen Blu-ray Disc™-Spieler/Aufnahmegerät oder einem anderen kompatiblen Gerät wiedergegeben werden.



English

END-USER LICENSE AGREEMENT FOR MAP DATA FOR SONY HANDYCAM® PRODUCTS**YOU SHOULD CAREFULLY READ THE FOLLOWING AGREEMENT BEFORE USING THIS SOFTWARE.**

IMPORTANT-READ CAREFULLY: This End-User License Agreement ("LICENSE") is a legal agreement between you and Sony Corporation ("SONY"), the licensor of the map data included in your Sony HANDYCAM product ("PRODUCT"). Such map data, including subsequent updates/updates, is referred to herein as the SOFTWARE. This LICENSE covers only the SOFTWARE. You may use the SOFTWARE only in connection with your use of the PRODUCT. By touching the "AGREE" button appearing on the screen of the PRODUCT in connection with this License, you agree to be bound by the terms of this LICENSE. If you do not agree to the terms of this LICENSE, SONY is unwilling to license the SOFTWARE to you. In such event, the SOFTWARE will not be available and you may not use the SOFTWARE.

SOFTWARE LICENSE

The SOFTWARE is protected by copyright laws and international copyright treaties, as well as other intellectual property laws and treaties. The SOFTWARE is licensed, not sold.

GRANT OF LICENSE

This LICENSE grants you the following rights on a non-exclusive basis: SOFTWARE. You may use the SOFTWARE on one unit of the PRODUCT. Personal Use. You may use the SOFTWARE for personal, non-commercial use only.

DESCRIPTION OF OTHER RIGHTS AND LIMITATIONS

Restrictions. You may not transfer or distribute any part of the SOFTWARE in any form for any purpose except as expressly permitted in this LICENSE. You may not use the SOFTWARE with any products, systems or applications other than with the PRODUCT. Except as otherwise provided in this LICENSE, you may not use and may not permit any third party to use the SOFTWARE separated from the PRODUCT (in whole or in part, including, but not limited to, reproductions, outputs or extractions or other works thereof in any form) for the purpose of rental or lease whether with any license fee or not. Some jurisdictions do not allow the restrictions of such rights, in such case the above restrictions may not apply to you.

Limitation on Reverse Engineering, Decompilation and Disassembly. You may not (i) extract the SOFTWARE from the PRODUCT, (ii) reproduce, copy, modify, port, translate or create derivative works of the SOFTWARE in whole or in part, or (iii) reverse engineer, decompile, disassemble the SOFTWARE by any means whatsoever in whole or in part for any purpose. Some jurisdictions do not allow the limitation of such rights, in such case the above limitation may not apply to you.

Trademarks and Notices: You may not remove, alter, cover or deface any trademarks or copyright notices on the SOFTWARE.

Data Files. The SOFTWARE may create data files automatically for use with the SOFTWARE. Any such data files will be deemed to be part of the SOFTWARE.

SOFTWARE Transfer. You may permanently transfer all of your rights under this LICENSE only as part of a sale or transfer of the PRODUCT, provided you retain no copies of the SOFTWARE, transfer all of the SOFTWARE (including all copies (only if permitted to copy under "Limitation on Reverse Engineering, Decompilation and Disassembly" Paragraph above), component parts, the media and printed materials, all versions and any upgrades of the SOFTWARE and this LICENSE), and the recipient agrees to the terms and conditions of this LICENSE.

Termination. Without prejudice to any other rights, SONY may terminate this LICENSE if you fail to comply with the terms and conditions of this LICENSE. In such event, you must stop using the SOFTWARE and all of its component parts. The provisions of this LICENSE "COPYRIGHT," "HIGH RISK ACTIVITIES," "EXCLUSION OF WARRANTY ON SOFTWARE," "LIMITATION OF LIABILITY," "PROHIBITION ON EXPORT," "SEVERABILITY" and "GOVERNING LAW AND JURISDICTION" Sections, "Confidentiality" Paragraph of this Section and this Paragraph shall survive any expiration or termination of this LICENSE.

Confidentiality. You agree to keep information contained in the SOFTWARE which is not publicly known confidential to yourself, and not to disclose such information to others without SONY's prior written approval.

COPYRIGHT

All title and copyright in and to the SOFTWARE (including but not limited to any map data, images, photographs, animation, video, audio, music, text and "applets", incorporated into the SOFTWARE), and any copies of the SOFTWARE, are owned by SONY, licensors and suppliers to SONY and their respective affiliates (such licensors and suppliers to SONY, together with their respective affiliates, are hereinafter collectively referred to as "SONY's Licensors"). All rights not specifically granted under this LICENSE are reserved by SONY or SONY's Licensors.

HIGH RISK ACTIVITIES

The SOFTWARE is not fault-tolerant and is not designed, manufactured or intended for use in hazardous environments requiring fail-safe performance, such as in the operation of nuclear facilities, aircraft navigation or communication systems, air traffic control, direct life support machines, or weapons systems, in which the failure of the SOFTWARE could lead to death, personal injury or severe physical or environmental damage ("High Risk Activities"). SONY, its affiliates, their respective suppliers and SONY's Licensors specifically disclaim any express or implied warranty of fitness for High Risk Activities.

EXCLUSION OF WARRANTY ON SOFTWARE

You expressly acknowledge and agree that use of the SOFTWARE is at your sole risk. The SOFTWARE is provided "AS IS" and without warranty of any kind and SONY, its affiliates, its and their respective suppliers and SONY's Licensors (in this section, SONY, its affiliates, their respective suppliers and SONY's Licensors shall be collectively referred to as "SONY") EXPRESSLY DISCLAIMS ALL WARRANTIES AND CONDITIONS, EXPRESS OR IMPLIED, ARISING BY LAW OR OTHERWISE, INCLUDING, BUT NOT LIMITED TO, THE IMPLIED WARRANTIES AND CONDITIONS OF QUALITY, NON-INFRINGEMENT, MERCHANTABILITY AND FITNESS FOR A PARTICULAR PURPOSE. SONY DOES NOT WARRANT THAT THE FUNCTIONS CONTAINED IN THE SOFTWARE WILL MEET YOUR REQUIREMENTS, OR THAT THE OPERATION OF THE SOFTWARE WILL BE UNINTERRUPTED OR ERROR FREE. SONY DOES NOT WARRANT OR MAKE ANY REPRESENTATIONS REGARDING THE USE, INABILITY TO USE OR THE RESULTS OF THE USE OF THE SOFTWARE IN TERMS OF ITS CORRECTNESS, ACCURACY, RELIABILITY, OR OTHERWISE. SOME JURISDICTIONS DO NOT ALLOW THE EXCLUSION OF IMPLIED WARRANTIES, IN SUCH CASE THE ABOVE EXCLUSIONS MAY NOT APPLY TO YOU.

You expressly understand that the data in the SOFTWARE may contain inaccurate or incomplete information due to the passage of time, changing circumstances, sources used and the nature of collecting comprehensive geographic data, any of which may lead to incorrect results.

LIMITATION OF LIABILITY

IN THIS SECTION SONY, ITS AFFILIATES, ITS AND THEIR RESPECTIVE SUPPLIERS AND SONY'S LICENSORS SHALL BE COLLECTIVELY REFERRED TO AS "SONY" TO THE MAXIMUM EXTENT PERMITTED UNDER APPLICABLE LAW. SONY SHALL NOT BE LIABLE FOR ANY CLAIM, DEMAND OR ACTION, IRRESPECTIVE OF THE NATURE OF THE CAUSE OF CLAIM, DEMAND OR ACTION, ALLEGING ANY LOSS OR DAMAGES, DIRECT OR INDIRECT, WHICH MAY RESULT FROM THE USE OR POSSESSION OF THE SOFTWARE, NOR FOR ANY LOSS OF PROFIT, REVENUE, CONTRACTS OR SAVINGS, NOR ANY OTHER DIRECT, INDIRECT, INCIDENTAL, SPECIAL OR CONSEQUENTIAL DAMAGES ARISING OUT OF YOUR USE OF OR INABILITY TO USE THE SOFTWARE, ANY DEFECT IN THE SOFTWARE, OR THE BREACH OF THE TERMS AND CONDITIONS, WHETHER IN AN ACTION IN CONTRACT OR TORT OR BASED ON A WARRANTY, EVEN IF SONY HAS BEEN ADVISED OF THE POSSIBILITY OF SUCH DAMAGES EXCEPT IN THE EVENT OF SONY'S GROSS NEGLIGENCE OR WILLFUL MISCONDUCT, OF DEATH OR PERSONAL INJURY, AND OF DAMAGES DUE TO THE DEFECTIVE NATURE OF THE PRODUCT. IN ANY CASE, SAVE FOR THE FOREGOING EXCEPTIONS, SONY'S ENTIRE LIABILITY UNDER ANY PROVISION OF THIS LICENSE SHALL BE LIMITED TO THE AMOUNT ACTUALLY PAID ALLOCABLE TO THE SOFTWARE. SOME JURISDICTIONS DO NOT ALLOW THE EXCLUSION OR LIMITATION OF CONSEQUENTIAL OR INCIDENTAL DAMAGES, SO THE ABOVE EXCLUSION OR LIMITATION MAY NOT APPLY TO YOU.

PROHIBITION ON EXPORT

YOU ACKNOWLEDGE THAT THE USE OF THE SOFTWARE IN SOME COUNTRIES, REGIONS, AREAS OR FACILITIES, OR THE EXPORT OF THE PRODUCTS FROM THE COUNTRY WHERE SUCH PRODUCTS ARE DESIGNED TO BE SOLD, MAY BE RESTRICTED OR PROHIBITED. YOU AGREE TO USE THE SOFTWARE OR EXPORT THE PRODUCTS IN ACCORDANCE WITH THE APPLICABLE LAWS, ORDINANCES, RULES AND REGULATIONS OF RELEVANT COUNTRIES, REGIONS, AREAS AND FACILITIES.

SEVERABILITY

If any part of this LICENSE is held invalid or unenforceable, the other parts will remain valid.

GOVERNING LAW AND JURISDICTION

This LICENSE shall be governed by the laws of Japan without giving effect to its conflict of laws provisions or the United Nations Convention for Contracts for the International Sale of Goods, which is expressly excluded. Any dispute arising out of this LICENSE shall be subject to the exclusive venue of the Tokyo District Court, and the parties hereby consent to the venue and jurisdiction of such court. THE PARTIES HEREBY WAIVE TRIAL BY JURY WITH RESPECT TO ANY MATTERS ARISING UNDER OR RELATING TO THIS LICENSE. SOME JURISDICTIONS DO NOT ALLOW THE EXCLUSION OF THE RIGHT OF TRIAL BY JURY, IN SUCH CASE THE ABOVE EXCLUSION MAY NOT APPLY TO YOU.

Entire Agreement

These terms and conditions constitute the entire agreement between SONY and you pertaining to the subject matter hereof, and supersedes in their entirety any and all previously existing written or oral agreements between us with respect to such subject matter.

Government End Users

If the SOFTWARE is being acquired by or on behalf of the United States government or any other entity seeking or applying rights similar to those customarily claimed by the United States government, such SOFTWARE is a "commercial item" as that term is defined at 48 C.F.R. ("FAR") 2.101, is licensed in accordance with this LICENSE, and such SOFTWARE delivered or otherwise furnished shall be provided with the following "Notice of Use" and shall be treated in accordance with such notice:

Notice of Use
Contractor (Manufacturer/Supplier) Name: SONY CORPORATION
Contractor (Manufacturer/Supplier) Address: 1-7-1 Konan, Minato-ku, Tokyo, Japan
These SOFTWARE are commercial items as defined in FAR 2.101 and are subject to the **END-USER LICENSE AGREEMENT FOR MAP DATA FOR SONY HANDYCAM® PRODUCTS** under which this SOFTWARE was provided.

If the Contracting Officer, federal government agency, or any federal official refuses to use the legend provided herein, the Contracting Officer, federal government agency, or any federal official must notify SONY prior to seeking additional or alternative rights in the Software.

Copyright and trademark information

©1993-2007 NAVTEQ
©2009 ZENRIN CO., LTD.
©Her Majesty the Queen in Right of Canada; ©Queen's Printer for Ontario; ©Canada Post Corporation; GeoBase®; ©Department of Natural Resources Canada; ©United States Postal Service *2007; USPS®; ZIP+4®



HANDYCAM®

SONY®

- PMB(Picture Motion Browser)
Ver.5.0 (for / pour Windows)
- "Handycam" Handbook
Guide pratique de "Handycam"
"ハンディカム"ハンドブック
- Product Registration
Enregistrement
製品カスタマー登録

for / pour Windows XP® SP3, Windows Vista®** SP2, Windows 7

*64-bit editions and Starter (Edition) are not supported.

*Les éditions 64 bits et Starter (Edition) ne sont pas prises en charge.

*64bit版は除きます。 **Starter(Edition):s not supported.

**Starter(Edition)ne sont pas prises en charge.



4 1 7 1 4 9 9 0 1 0

COMPACT
disc

ソフトウェア対応言語

Supported languages for software / Langues prises en charge par le logiciel

日本語 / English / Deutsch / Français / Italiano / Português /

Español / Svenska / русский / Nederlands /

繁體中文 / 简体中文 / 한국어

©2010 Sony Corporation All rights reserved. Sony Corporation Tous droits réservés. 4-171-499-01 Made in Japan / Fabriqué au Japon



Receive **15% off** your next purchase of select accessories.

Thank you for purchasing a Digital Imaging Product from Sony. Register your Sony® Digital Imaging Product within 30 days of purchase. Receive an electronic coupon good for a 15% discount on the purchase of select Sony® accessories at the online Sony Style® store*. Our automatic registration process below makes it easy to register your Sony Digital Imaging Product.

METHOD 1: Automatic USB Registration

For Windows® PC:

- 1) Turn on your PC.
- 2) Place the CD-ROM supplied with your product into your PC's CD drive.
- 3) When the installation menu appears, click 'Product Registration'.
- 4) Confirm the region and country/area information. Click 'Continue'.
- 5) Follow the instructions to connect your product to your PC and register.

For Mac®:

- 1) Turn on your Mac.
- 2) Place the CD-ROM supplied with your product into your Mac's CD drive.
- 3) Double-click on 'SONYPICTUTIL'.
- 4) Select the Mac folder and double-click 'Registration'.
- 5) Confirm the region and country/area information. Click 'Continue'.
- 6) Follow the instructions to connect your product to your Mac and register.

Or METHOD 2: Register online at <https://productregistration.sony.com>

Just visit this registration site and fill out the form to get your discount e-coupon.

* Offer valid until December 31, 2011.

For the full terms and conditions, visit <https://productregistration.sony.com>. Features, specifications and price are subject to change without notice. Offer subject to availability. Customer Support: If you have any questions or comments related to this product, please visit our Customer Support website at sony.com/support (if you do not have Internet access, please call 1-800-222-7669 or 1-800-222-SONY).

© 2010 Sony Electronics Inc.
All rights reserved.

Sony and the Sony logo, "make.believe" and Sony Style are trademarks of Sony. Windows is a trademark of Microsoft Corporation, Inc. Mac is a trademark of Apple Computers, Inc.



4-176-975-01

SONY
make.believe™



15% Off Eligible Accessories

See inside and go to

<https://productregistration.sony.com/>

for more details on the 15% savings.

HDR-XR550V/XR350V/CX550V/CX350V/CX300



Register your new Handycam® camcorder online today and save 15% on eligible accessories

Thank you for purchasing a Digital Imaging Product from Sony. Register your Sony® Digital Imaging Product within **30 days of purchase**. Receive an electronic coupon good for a 15% discount on the purchase of select Sony® accessories at the online Sony Style® store*. Our automatic registration process below makes it easy to register your Sony Digital Imaging Product.

METHOD 1: Automatic USB Registration

For Windows® PC:

- 1) Turn on your PC.
- 2) Place the CD-ROM supplied with your product into your PC's CD drive.
- 3) When the installation menu appears, click 'Product Registration'.
- 4) Confirm the region and country/area information. Click 'Continue'.
- 5) Follow the instructions to connect your product to your PC and register.

For Mac®:

- 1) Turn on your Mac.
- 2) Place the CD-ROM supplied with your product into your Mac's CD drive.
- 3) Double-click on 'SONYPICTUTIL'.
- 4) Select the Mac folder and double-click 'Registration'.
- 5) Confirm the region and country/area information. Click 'Continue'.
- 6) Follow the instructions to connect your product to your Mac and register.

Or METHOD 2: Register online at <https://productregistration.sony.com>

Just visit this registration site and fill out the form to get your discount e-coupon.

ORDER BY TELEPHONE AND STILL RECEIVE A 15% DISCOUNT ON ELIGIBLE ACCESSORIES

If you're unable to access the Sony Style web site, you can call our sales representatives anytime at 1-877-865-7669. You can place your order 24 hours a day, 7 days a week by phone or on the web using most major credit cards.

Save 15% off eligible accessories with this special e-coupon offer!

EXAMPLE of SAVINGS:

With 15% discount, the more you buy, the more you save!

NP-FV100 + GP-AVT1 + LCM-CXC + AC-VQV10

- **15%** = **OVER \$68 IN SAVINGS!**

15% Discount

Contents:

Power	04 - 05
Tripods	06 - 07
Shooting Grip/Kits	08 - 09
Cases	10 - 11
Water Housing/Microphones	12 - 13
Lenses/Filters	14 - 15
Lights/Cables/Media	16 - 17
DVDirect® Recorders	18 - 19

*Offer valid until December 31, 2011.

For the full terms and conditions, visit <https://productregistration.sony.com>. Features, specifications and price are subject to change without notice. Offer subject to availability. Customer Support: If you have any questions or comments related to this product, please visit our Customer Support website at sony.com/support (if you do not have Internet access, please call 1-800-222-7669 or 1-800-222-SONY).



Power

RECOMMENDED

InfoLITHIUM® High Capacity V Series Batteries

NP-FV100 \$159.99
 Typ. 6.8V, 26.5 Wh (3900 mAh)

NP-FV50 \$59.99
 Typ. 6.8V, 7.0 Wh (1030 mAh)

NP-FV70 \$99.99
 Typ. 6.8V, 14.0 Wh (2060 mAh)

- Offers longer battery life (compared to its predecessors)
- Faster re-charging when used with the Sony® AC-VQV10 AC adaptor/charger



ActiFORCE™ **InfoLITHIUM™** **V**
SERIES

To order by phone with 15% off e-coupon: 1-877-865-7669



RECOMMENDED

Travel Charger

BC-TRV \$59.99

- Compact AC charger for H, P, and V Series InfoLITHIUM® batteries
- Charging status indication lamp with 3-step LED
- Great for travel with a retracting AC plug
- Universal voltage AC 100-240V (50/60Hz)







AC Adaptor

AC-L200 \$49.99

- Supplies power when viewing images on your compatible TV or transferring images to your PC
- AC 100-240V (50/60Hz)



AC Adaptor/Charger

AC-VQV10 \$149.99

- Compatible with H, P, and V Series InfoLITHIUM batteries
- Dual battery slots for consecutive charging
- Selectable viewing of remaining battery life with LCD

ActiFORCE™



To order by phone with 15% off e-coupon: 1-877-865-7669



AV Remote Control Tripod

VCT-80AV \$179.99

- Adjusts from 24 7/8" to 65 7/8"
- Features a variable zoom
- Access major camcorder functions right from its grip
- Remote camcorder controls built into the tripod's handle
- Guide Frame feature helps position subjects correctly
- Slow Zoom feature for the slowest and steadiest zooms possible
- Features an oil fluid head for smooth tilts and pans



AV Remote Control Tripod

VCT-50AV \$79.99

- Extends from 18 1/8" to 46 1/8" in height
- Features a variable zoom
- Access major camcorder functions right from its grip
- Remote camcorder controls built into the tripod's handle
- Guide Frame feature helps position subjects correctly
- Slow Zoom feature for the slowest and steadiest zooms possible
- Features an oil fluid head for smooth tilts and pans



RECOMMENDED

AV Remote Control Tripod

VCT-60AV \$99.99

- Extends from 19" to 57 3/4" in height
- Features a variable zoom
- Access major camcorder functions right from its grip
- Remote camcorder controls built into the tripod's handle
- Guide Frame feature helps position subjects correctly
- Slow Zoom feature for the slowest and steadiest zooms possible
- Features an oil fluid head for smooth tilts and pans

Register online now at <https://productregistration.sony.com/>
to save 15% on these eligible items at SonyStyle.com

To order by phone with 15% off e-coupon: 1-877-865-7669



Lightweight Tripod

VCT-1500L \$129.99

- High-performance, compact aluminum tripod
- Legs collapse to allow for close-to-ground macro shooting
- Shoot from as low as 7 1/8" above the ground



Lightweight Tripod

VCT-R640 \$49.99

- Expands from 21 5/8" to 56 3/4" in height



Travel Tripod

VCT-R100 \$34.99

- Lightweight-yet-sturdy travel tripod
- Extends up to a generous 39 3/8"
- Folds down to a compact 14"



Travel Kit

VCT-MTK \$19.99

- Compact design for easy portability
- Extendable legs allow for a maximum height of 7 1/8"
- Comes with its own carrying pouch and cleaning cloth



AV Remote Commander® Control Unit

RM-AV2 \$49.99

- Provides remote control over basic camcorder functions, including Record Start/Stop, Power, Photo Capture and Zoom
- Two-step zoom feature for switching quickly between slow and variable zoom speeds
- Clips directly onto tripod's handle

To order by phone with 15% off e-coupon: 1-877-865-7669



RECOMMENDED

Shooting Grip with Mini Tripod

GP-AVT1 \$99.99

- Comfortable, ergonomic design
- Features a sturdy built-in tripod
- Free angle rotation for flexible shooting
- Offers an integrated Remote Commander® control for easy camcorder operation by both left and right handed users

Register online now at <https://productregistration.sony.com/>
to save 15% on these eligible items at [SonyStyle.com](https://www.sony.com)

To order by phone with 15% off e-coupon: 1-877-865-7669



Accessory Kit

ACC-FV50A \$69.99

- Includes Sony® LCS-X11 carrying case and NP-FV50 long-life InfoLITHIUM® rechargeable battery
- Save \$10 when bought together as a kit
- Compatible with HDR-XR350V/CX350V/CX300

ActiFORCE™ 



RECOMMENDED

Accessory Kit

ACC-FV70 \$114.99

- Includes Sony LCS-X30 carrying case and NP-FV70 long-life InfoLITHIUM rechargeable battery
- Saves you \$25 when bought together as a kit

ActiFORCE™ 



Accessory Kit

ACC-HDV7 \$129.99

- A great combination at a great value
- Includes Sony LCS-X21 carrying case, NP-FV70 long-life InfoLITHIUM rechargeable battery, and VMC-15MHD HDMI™ cable
- Saves you \$50 when bought together as a kit

ActiFORCE™ 

HDMI™
THE CONNECTING QUALITY STANDARD

To order by phone with 15% off e-coupon: 1-877-865-7669



Semi Soft Carrying Case

LCM-CXC \$49.99

- Exclusive carrying case for High Definition HDD Handycam® camcorders
- Durable, holster-style case attaches to belt for easy carrying
- Comes with spare battery pouch
- Memory Stick® media pocket
- Shoulder strap included
- Compatible with HDR-CX350V/CX300



LCM-AX1/B



LCM-AX1/R



LCM-AX1/G

RECOMMENDED

Semi Soft Carrying Case

LCM-AX1/B, /R, /G \$59.99

- Semi-hard exterior with soft interior
- Cradles your camcorder much like a jewelry box
- Features a movable divider and Memory Stick® media pockets
- Includes an adjustable shoulder strap
- Compatible with HDR-XR350V/CX350V/CX300



Bag-in-Bag Carrying Pouch

LCS-BBD/B, /R, /L \$19.99

- Provides an added layer of protection for your camcorder while it's being stowed inside your backpack, purse or other larger bag
- Body-hugging, snug-fit style
- 3 colors—black, red, blue
- Easy open/close
- Built-in handy strap

Register online now at <https://productregistration.sony.com/>
to save 15% on these eligible items at SonyStyle.com

To order by phone with 15% off e-coupon: 1-877-865-7669



Soft Holster Style Carrying Case

LCS-SRC \$49.99

- Durable, holster-style case can be worn on a waist belt
- Can be worn with the supplied shoulder strap
- Features quick access to camcorder via holster-style design
- Includes a small pouch for carrying an extra battery
- Web interface design for attaching battery pouch or case
- Compatible with HDR-XR550V/XR350V/CX550V



Soft Carrying Case

LCS-BBA \$34.99

- General purpose carrying case for Digital Handycam camcorder
- Small enough to slip easily into a larger accessory bag to serve as added protection
- Convenient wrist strap



Modular Carrying Case

LCS-MX100 \$49.99

- Designed to carry both a Digital Handycam® camcorder and Cyber-shot® camera at once
- Roomy Core Case features an adjustable partition, colored interior, and padded shoulder strap
- Smaller Sub Case holds a still camera or accessories and attaches easily to Core Case

Modular Interface Case



Soft Carrying Case

LCS-X30 \$39.99

- Designed for Digital Handycam camcorders and Cyber-shot cameras
- Features easy-access side pockets plus large outside pocket
- External loop for attaching accessory pouches or other small items
- Colored interior makes it easier to locate items



Soft Carrying Case

LCS-X20 \$29.99

- Designed for Digital Handycam camcorders and Cyber-shot cameras
- Stylish soft-sided case provides extra protection
- External loop for attaching accessory pouches or other small items



Water Housing



RECOMMENDED

Sports Pack

SPK-CXA \$299.99

- Stylish sports pack
- Records underwater sounds
- Hard-plastic housing shields camcorder from rain, snow and other moisture
- Offers waterproof protection up to 17 feet deep
- Built-in Stereo microphone allows for recording of audio—above and under water
- Compatible with HDR-CX350V/CX300

Water Housing/Microphones

To order by phone with 15% off e-coupon: 1-877-865-7669



Sports Pack

SPK-HCF \$279.99

- Hard-plastic housing shields camcorder from rain, snow and other moisture
- Use to take underwater videos while snorkeling or swimming
- Camcorder mounting shoe included
- Offers waterproof protection up to 17 feet deep
- Built-in Stereo microphone allows for recording of audio—above and under water
- Compatible with HDR-XR550V/XR350V/CX550V



Bluetooth® Wireless Microphone*

ECM-AW3 \$229.99

- Capture audio from up to 50m/150 feet away—without wires
- Talk back-and-forth with your video subject even from a distance
- Plugs into the camcorder's MIC in and earphone jacks, freeing up the Active Interface shoe for a video light or other compatible accessory
- Compatible with HDR-XR550V/CX550V



High-Fidelity Stereo Microphone

ECM-HST1 \$99.99

- Powered and controlled by the Handycam camcorder through a unique Active Interface Shoe
- High-quality stereo audio
- User-selectable audio coverage: Select 90 degrees for concentrating on a single speaker, or 120 degrees for picking up group conversations



RECOMMENDED

Bluetooth® Wireless Microphone*

ECM-HW2 \$229.99

- Record high-quality audio in your videos from up to 100m/325 feet away—without wires
- Interactive Communication feature
 - Talk directly to your subject as you're recording
 - Record just your subject's voice or both of your voices
 - Earphone jacks in both microphone and receiver units (earphones included)
- Works with your camcorder's 5.1ch Mix-mode (compatible with HDR-XR550V/CX550V)



Zoom Microphone

ECM-HGZ1 \$69.99

- Powered and controlled by the Handycam® camcorder through a unique Active Interface Shoe
- Zoom mode: Picks up sound in the direction the Handycam camcorder is zoomed
- Gun mode: Sharp sound is picked up from the object you focus on
- Mono microphone

*Interoperability and compatibility among Bluetooth devices vary.

Register online now at <https://productregistration.sony.com/> to save 15% on these eligible items at [SonyStyle.com](https://www.sonymystyle.com)

Download from www.Somanuals.com. All Manuals Search And Download.

To order by phone with 15% off e-coupon: 1-877-865-7669



High-Grade Wide Conversion Lens

VCL-HGA07B \$199.99

- Wide conversion lens for 37 mm/30 mm diameter camcorders
- Certified High Definition picture quality
- High-grade design with diamond-cut rim
- 30% wider (0.75X) coverage than supplied camcorder lens

High Grade

COMPARISON



With Built-In Lens



With Wide-Angle Lens

Simulated images for illustrative purposes.



High-Grade Tele Conversion Lens

VCL-HG1737C (37 mm) \$199.99

- 1.7X telephoto converter lens
- Fits 37mm diameter camcorders
- Lighter and smaller than existing 37mm high-grade lens
- Compatible with HDR-XR550V/CX550V

High Grade



WIDE ANGLE CAP™

High-Grade Wide-End Conversion Lens

VCL-HGE08B \$99.99

- 0.8X wide-angle converter lens for 37 mm/30 mm diameter camcorders
- Certified High Definition picture quality
- Lightest conversion lens for HD
- "1 action attachment" concept
- 25% wider coverage than supplied camcorder lens

High Grade



High-Grade Tele Conversion Lens

HVL-HG1730A (30 mm) \$199.99

- 1.7X telephoto converter lens for 30 mm diameter camcorders
- Helps make distant subjects appear closer
- Aluminum housing for superb durability
- Compatible with HDR-XR350V/CX350V/CX300

High Grade

COMPARISON



With Built-In Lens



With Tele-Conversion Lens

Simulated images for illustrative purposes.

Register online now at <https://productregistration.sony.com/>
to save 15% on these eligible items at SonyStyle.com

To order by phone with 15% off e-coupon: 1-877-865-7669



Polarizing Filter Kit

VF-30CPKB \$69.99

- Circular Polarizing Filter suppresses unwanted reflections off glass and water
- Multicoat Filter helps protect lens from dust and scratches
- Hard carrying case for protection
- Fits 30 mm diameter camcorders
- Compatible with HDR-XR350V/CX350V/CX300



Neutral Density Filter Kit

VF-30NKB \$39.99

- Improves contrast and detail in super-bright sunlight (such as at the beach)
- Includes lens protector and carrying case for protection
- Fits 30 mm diameter camcorders
- Compatible with HDR-XR350V/CX350V/CX300



Polarizing Filter Kit

VF-37CPKB \$69.99

- Circular Polarizing Filter suppresses unwanted reflections off glass and water (such as a swimming pool)
- Multicoat Filter protects lens from dust and scratches
- Hard carrying case for protection
- Compatible with HDR-XR550V/CX550V



Neutral Density Filter Kit

VF-37NKB \$39.99

- Neutral Density Filter improves contrast and detail in super-bright sunlight (such as at the beach or skiing)
- Protector Filter helps save lens from dust/scratches
- Hard carrying case for protection
- Compatible with HDR-XR550V/CX550V

To order by phone with 15% off e-coupon: 1-877-865-7669



Battery Video Light

HVL-10NH \$129.99

- High-power 10W video light compatible with all Handycam® camcorders
- Powered by rechargeable Ni-MH battery
- Accessory shoe adaptor included

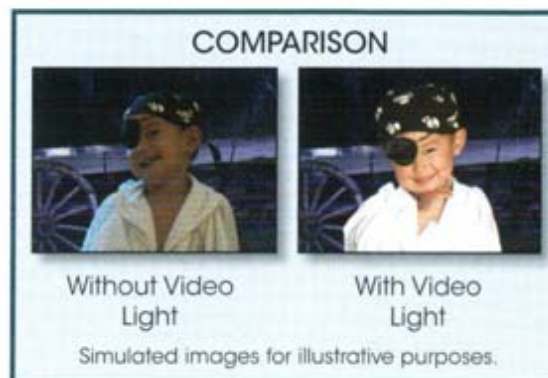

Flash/Video Light

HVL-HFL1 \$149.99

- Powered directly from and controlled by Handycam camcorder through unique Active Interface Shoe
- Flash range is 16 feet



Infrared Light/3-Watt Video Light

HVL-HIRL \$99.99

- Powered directly from and controlled by Handycam camcorder through unique Active Interface Shoe
- Nightshot® operation range: NightShot (Plus): 7m Super NightShot (Plus): 20m
- Compatible with HDR-XR550V/CX550V



RECOMMENDED

Video Light

HVL-HL1 \$39.99

- Powered directly from and controlled by Handycam camcorder through unique Active Interface Shoe
- 3W light
- Turns on automatically
- Color: graphite silver

Register online now at <https://productregistration.sony.com/>
to save 15% on these eligible items at www.sony.com

To order by phone with 15% off e-coupon: 1-877-865-7669



HDMI™ Cable (Mini-to-Full)

5ft (1.5m)

VMC-15MHD \$49.99

10ft (3m)

VMC-30MHD \$69.99

- Connects HD Handycam® camcorders to compatible components
- HDMI Mini (type C) to Full (type A) cable delivers uncompressed high-definition video and multichannel digital audio signals
- Gold-plated plugs for uncompromising quality
- 10ft (3m) or 5ft (1.5m) in length



High-Grade AV Cable

VMC-30FS \$39.99

- Multi function AV camcorder output terminal to RCA and S-video connectors
- Gold contacts for high signal integrity
- Ideal for Home Theatre Environment



USB Adaptor Cable

VMC-UAM1 \$19.99

- Use for "Direct Copy" from camcorder
- Connects USB mini A/B port on the camcorder and a USB A plug from storage devices



Memory Stick PRO Duo™ Media

32 GB* (30.0 GB avail.) Memory Stick PRO Duo
MS-MT32G \$249.99

16 GB* (14.9 GB avail.) Memory Stick PRO Duo
MS-MT16G \$89.99

8 GB* (7.35 GB avail.) Memory Stick PRO Duo
MS-MT8G \$49.99

- Memory Stick® media provides a convenient way to store digital videos and still images
- Certified for use with AVCHD™ recording (1920 x 1080)

*Available storage capacity may vary and a portion of the memory is used for data management functions.

1. Memory Stick PRO Duo™ media compatibility, capacity, transfer speeds, and other features vary by and are dependent upon the design of host hardware devices. See hardware specifications or www.sony.net/memorystick/support/e/ for compatibility information.



Memory Stick PRO-HG Duo™ "HX" Media

32 GB* (30.0 GB avail.)
Memory Stick PRO-HG Duo "HX"
MS-HX32G \$199.99

16 GB* (14.9 GB avail.)
Memory Stick PRO-HG Duo "HX"
MS-HX16G \$109.99

8 GB* (7.35 GB avail.)
Memory Stick PRO-HG Duo "HX"
MS-HX8G \$59.99

- Affordable option for transferring large files
- 20MB/second read speed for high-speed transfers¹
- Supplied USB adaptor allows ease of transfer to a wide range of computers (including PlayStation3)



DVDirect® Recorders



Camcorder
sold separately.

DVDirect Express DVD Recorder

VRD-P1 \$149.99

- One touch video transfer to DVD, via USB from Sony® Handycam® camcorder
- Records up to 6x speed: 30 minutes of SD video in 5 minutes
- Creates movie chapters on DVD
- No AC power required. Runs off USB power from Sony Handycam camcorder

To order by phone with 15% off e-coupon: 1-877-865-7669

RECOMMENDED

DVDirect Multi-function DVD Recorder²



DVD media
sold separately.

VRD-MC6 \$199.99

- Transfer SD home video from virtually any source to DVD without a PC
- Transfer HD home video from Sony® AVCHD™ Handycam® camcorders and AVCHD compatible Cyber-shot® cameras to DVD¹
- Accepts virtually any memory card (except CompactFlash® media) to transfer your digital photos to DVD as a slideshow or for photo storage
- 2.7" color LCD widescreen³ for photo/video preview



DVDirect Multi-function DVD Recorder/Player

VRD-MC10 \$299.99

- Transfer SD home video from virtually any source to DVD without a PC
- Transfer HD home video from Sony AVCHD Handycam camcorders and AVCHD compatible Cyber-shot cameras to DVD¹
- Transfer digital pictures to DVD from camera's memory card
- Connect to compatible TV and VRD-MC10 doubles as a DVD player² with Remote Commander® control

1. DVD media containing AVCHD footage may be played on a compatible Blu-ray Disc™ player/recorder, PC with supplied software or PLAYSTATION®3 devices. DVD media containing AVCHD footage should not be used with standard DVD based players, as the DVD player may fail to eject the media and may erase its contents without warning.

2. The VRD-MC10 and VRD-MC6 do not play commercial DVD movie discs.

3. Viewable area measured diagonally.

Register online now at <https://productregistration.sony.com/>
to save 15% on these eligible items at SonyStyle.com

To order: call 1.877.865.SONY (7669)

Sony Electronics Inc.
16530 Via Esprillo
San Diego, CA 92127

©2010 Sony Electronics Inc. All rights reserved. Reproduction in whole or in part is prohibited. Sony, Cyber-shot, Backstage Access, Backstage 101, Handycam, InfoLITHIUM, DVDirect, Actiforce, Active Interface Shoe, AVCHD, Memory Stick, Memory Stick Duo, Memory Stick PRO Duo, Memory Stick PRO-HG Duo, NightShot, Remote Commander, "make.believe", Sony Style, the Backstage 101 logo, the Actiforce logo, , the Wide Angle Cap logo, the Handycam logo, the VAIO logo and the Sony logo are trademarks or registered trademarks of Sony. Bluetooth is a trademark of Bluetooth SIG, Inc. HDMI and the HDMI logo are trademarks or registered trademarks of HDMI Licensing LLC. Playstation is a trademark of Sony Computer Entertainment. Blu-ray Disc is a trademark. All other trademarks are the property of their respective owners. Non-metric weights and measures are approximate and may vary. Features and specifications are subject to change without notice. All sample photos and screen representations are simulated. Offer is subject to availability and Sony may modify or terminate this offer at any time and for any reason.

4-168-956-01 • Printed in Japan

SONY
make.believe™



SONY®

Camcorder

LIMITED WARRANTY (US Only)

Sony Electronics Inc. ("Sony") warrants this product against defects in material or workmanship for the time periods and as set forth below. Pursuant to this Limited Warranty, Sony will, at its option, (i) repair the product using new or refurbished parts or (ii) replace the product with a new or refurbished product. For purposes of this Limited Warranty, "refurbished" means a product or part that has been returned to its original specifications. **In the event of a defect, these are your exclusive remedies.**

Labor: For a period of ninety days from the original date of purchase of the product ("Labor Warranty"), Sony will, at its option, repair or replace with new or refurbished product, product determined to be defective. If Sony elects to replace the product after this Labor Warranty has expired but while the Parts Warranty below is still in effect, it will do so for the applicable labor charge.

Parts: For a period of one year from the original date of purchase of product ("Parts Warranty"), Sony will supply new or refurbished replacement parts in exchange for parts determined to be defective.

This Limited Warranty covers only the hardware components packaged with the Product. It does not cover technical assistance for hardware or software usage and it does not cover any software products whether or not contained in the Product; any such software is provided "AS IS" unless expressly provided for in any enclosed software Limited Warranty. Please refer to the End User License Agreements included with the Product for your rights and obligations with respect to the software.

Instructions: To obtain warranty service, you must deliver the product, freight prepaid, in either its original packaging or packaging affording an equal degree of protection to the Sony authorized service facility specified. **It is your responsibility to backup any data, software or other materials you may have stored or preserved on your unit. It is likely that such data, software, or other materials will be lost or reformatted during service and Sony will not be responsible for any such damage or loss.** A dated purchase receipt is required. For specific instructions on how to obtain warranty service for your product,

Visit Sony's Web Site:
www.sony.com/support

Or call the Sony Customer Information Service Center
1-800-222-SONY (7669)

For an accessory or part not available from your authorized dealer, call:

1-800-488-SONY (7669)

Repair / Replacement Warranty: This Limited Warranty shall apply to any repair, replacement part or replacement product for the remainder of the original Limited Warranty period or for ninety (90) days, whichever is longer. Any parts or product replaced under this Limited Warranty will become the property of Sony.

This Limited Warranty only covers product issues caused by defects in material or workmanship during ordinary use; it does not cover product issues caused by any other reason, including but not limited to acts of God, misuse, limitations of technology, or modification of or to any part of the Sony product. This Limited Warranty does not cover Sony products sold AS IS or WITH ALL FAULTS or consumables (such as fuses or batteries). This Limited Warranty is invalid if the factory-applied serial number has been altered or removed from the product. This Limited Warranty is valid only in the United States.

LIMITATION ON DAMAGES: SONY SHALL NOT BE LIABLE FOR ANY INCIDENTAL OR CONSEQUENTIAL DAMAGES FOR BREACH OF ANY EXPRESS OR IMPLIED WARRANTY ON THIS PRODUCT.

DURATION OF IMPLIED WARRANTIES: EXCEPT TO THE EXTENT PROHIBITED BY APPLICABLE LAW, ANY IMPLIED WARRANTY OF MERCHANTABILITY OR FITNESS FOR A PARTICULAR PURPOSE ON THIS PRODUCT IS LIMITED IN DURATION TO THE DURATION OF THIS WARRANTY.

Some states do not allow the exclusion or limitation of incidental or consequential damages, or allow limitations on how long an implied warranty lasts, so the above limitations or exclusions may not apply to you. This Limited Warranty gives you specific legal rights and you may have other rights which vary from state to state.

4-557-156-13



Printed in Japan

Free Manuals Download Website

<http://myh66.com>

<http://usermanuals.us>

<http://www.somanuals.com>

<http://www.4manuals.cc>

<http://www.manual-lib.com>

<http://www.404manual.com>

<http://www.luxmanual.com>

<http://aubethermostatmanual.com>

Golf course search by state

<http://golfingnear.com>

Email search by domain

<http://emailbydomain.com>

Auto manuals search

<http://auto.somanuals.com>

TV manuals search

<http://tv.somanuals.com>