

Form 8987, Revised
(149)

Printed in U. S. A.

HISTORICAL COPY
DO NOT REMOVE

LIST OF PARTS



FOR FAMILY SHOPS

MACHINES

Nos. 66-4, 66-5 and 66-6

** REG. U. S. PAT. OFF. BY

THE SINGER MANUFACTURING COMPANY

INSTRUCTIONS FOR ORDERING

In ordering from this list, use ONLY the part NUMBER in the FIRST Column.

The number stamped on a Sewing Machine Part is in every case the number of the single part only.

Every combination of parts sent out as such has its specific number, which, although not stamped on the parts, must be used when ordering the combination.

Each number always indicates the SAME PART in whatever list it appears, or for whatever machine.

The letters after some of the numbers indicate the style of finish only, as follows:

- A-Hardened, Polished, Nickel Plated and Buffed.
- A.A-Buffed and Chromium Plated.
- A.B-Hardened, Polished, Buffed and Chromium Plated.
- A.C-Brown Baking Enamel Finish.
- A.D-Gray Baking Enamel Finish.
- A.E-Hardened, Bright Rumbled and Nickel Plated.
- A.F-Hardened, Bright Rumbled, Nickel Plated, Bright Rumbled and Chromium Plated.
- A.G-Alumilite, Plain.
- A.H-Alumilite Dyed.
- A.J-Polished, Nickel Plated and Chromium Plated.
- A.K-Hardened, Polished, Nickel Plated and Chromium Plated.
- A.L-Heat Treated for Toughness.
- B-Polished, Nickel Plated and Buffed.
- C-Hardened only.
- C.R-Hardened and Merlized.
- D-Polished Only.
- E-Soft, Not Polished.
- F-Hardened and Polished.
- F.J-Hardened, Polished and Nickel Plated.
- G-Bright Rumbled and Nickel Plated.
- H-Blued.
- J-Nickel Plated Only.
- K-Hardened and Nickel Plated.
- L-Brass Plated.
- M-Oxidized.
- N-Japanned, Dull.

INSTRUCTIONS FOR ORDERING - Continued

- P-Japanned, Bright.
- P.P-Wrinkle Finish.
- R-Merlized.
- S-Cadmium Plated.
- T-Copper Plated.
- T.A-Hardened, Polished, Copper and Nickel Plated and Buffed.
- T.B-Copper and Nickel Plated and Polished.
- T.J-Copper and Nickel Plated Only.
- T.K-Hardened, Copper and Nickel Plated.
- T.L-Copper and Brass Plated.
- T.M-Copper Plated and Oxidized.
- U-Zinc Plated.
- V-Silver Plated.
- W-Polished and Nickel Plated.
- X-Black Oxide, for Iron and Steel.
- X.C-Hardened and Black Oxide, for Iron and Steel.
- Y-Black Nickel Plated Only.
- Z-Chromium Plated.
- Z.A-Hardened, Polished, Nickel Plated, Buffed and Chromium Plated.
- Z.B-Polished, Nickel Plated, Buffed and Chromium Plated.
- Z.C-Hardened and Chromium Plated.
- Z.D-Polished and Chromium Plated.
- Z.G-Bright Rumbled, Nickel Plated, Bright Rumbled and Chromium Plated.
- Z.J-Nickel and Chromium Plated.
- Z.T-Copper and Chromium Plated.

These letters MUST BE USED when they appear in the list; and AFTER the number as in the list.

In this series:

- 1 to 1500, 50001 to 51500 and 140001 to 142000 are Screw Numbers.
- 1501 to 1800 and 51501 to 51800 are Nut Numbers.
- 1801 to 2000 and 51801 to 52000 are Roller Numbers.
- 2001 to 50000 and 52001 to 140000 and 142001 to 190000 are Sewing Machine Parts, 190001 and upward are numbers of Electrical Parts.

The figures in the second column refer only to the plates, illustrating the parts, and are NOT TO BE USED in ordering.

Parts marked with an asterisk (*) are furnished only when repairs are made at factory.

INDEX

	Page
Accessories.....	13
Attachment Set.....	13
Bias Gauge.....	13
Bobbin Winders.....	14
Braider.....	15
B.R. Family Sewing Machine Motors.....	22
Border Bow.....	15
Controllers.....	26
Controller Holder.....	28
Darning Foot (Spring).....	15
Edge Stitcher.....	16
Electrical Trimmings.....	39
Embroidery Attachment (for one thread).....	16
Embroidery Attachment (for two threads).....	17
Feed Cover Plates.....	18
Feller.....	18
Foot Controllers.....	30
Hemmers (Foot).....	13
Hemstitcher.....	19
Knee Lever Parts.....	29
Machine No. 66-4.....	5
Machine No. 66-5.....	10
Machine No. 66-6.....	12
Motor Parts.....	23
Numerical List of Parts.....	45
Obsolete Parts.....	43
Presser Feet.....	19
Quilter.....	19
Rufflers.....	19
Singerlight No. 193294.....	39
Singerlight No. 193518.....	42
Singerlight Lamp.....	42
Treadle Controllers (for Stands Nos. 25281, 25282 and 25294).....	33
Treadle Controllers (for Stands Nos. 46909, 46912 and 46913).....	36
Tubular Trimming Attachment.....	20
Tuck Folder.....	20
Under Braider.....	21

LIST OF PARTS COMPLETE FOR MACHINE No. 66-4

For Family Use. Has square seat on presser bar and oscillating hook bobbin case position bracket hinged to throw-out for the easy removal of the bobbin case.

No.	Plate	Name
*32616	----	Arm with 15404 and two 15405.....
2002	4376	" Dowel Pin.....
32683	9657	" Oil Tube, for oiling 32679....
32676	9659	" Rock Shaft with 50571E.....
32682	----	" " " 32676 with 1216C and 1520J.....
50571E	9657	Arm Rock Shaft Adjusting Screw...
8204	9657	" " " Center (upper)....
301C	9657	" " " Screw Center (low- er).....
55516	----	Arm Rock Shaft Screw Center (low- er) 301C with 1508J.....
1508J	9657	Arm Rock Shaft Screw Center (low- er) Nut.....
649E	9657	Arm Screw.....
32677	9659	" Shaft.....
32678	----	" " 32677 with 32679 and 32680.....
32681	----	Arm Shaft 32678 with 32503 and 32517.....
32503	4376	Arm Shaft Bushing.....
443A	9657	" " " Set Screw.....
32679	9657	" " Slide Block (two pieces)
32680	9657	" " " Retaining Clip
32633	9659	" Side Cover (embossed).....
51224B	9657	" " Thumb Screw.....
2007	4376	" Spool Pin.....
8879	4376	" " " washer (cloth)....
15282	4950	Balance Wheel, 2 1/4 in. pulley..
*32658	----	Bed.....
256B	9657	Clamp Stop Motion Clamp Screw....
248A	9657	" " " " Stop Screw

No.	Plate	Name
2020	4376	Clamp Stop Motion Clamp Washer...
32618	4376	" " " Flanged Bushing
11480	9657	" " " " "
		Set Screw.....
32619	----	Clamp Stop Motion complete, Nos. 248A, 256B, 1148C, 2020 and 32618
*32667	9659	Face Plate.....
32506	----	" " 32667 with 32630.....
107B	9657	" " Screw.....
32630	9657	" " Thread Guard with 125424
125424	9657	" " " Rivet Per 100.....
51224B	9657	Face Plate Thumb Screw.....
32507	4376	Feed Bar with 1944.....
1944	4376	" " Roller and Stud.....
315C	9657	" " Screw Center.....
15445	----	" " " 315C with 1519J.....
1519J	9657	Feed Bar Screw Center Nut.....
32562	9657	" Cam with 1285C.....
1285C	9657	" " Set Screw.....
32600	2934	" Dog, 12 teeth (16 teeth to the inch).....
191C	9657	Feed Dog Screw.....
32620	2933	" Forked Connection with 175J.
175J	9657	" " " Adjusting Screw.....
1381C	9658	Feed Forked Connection Hinge Screw (eccentric).....
1520J	9658	Feed Forked Connection Hinge Screw Nut.....
1832	9658	Feed Forked Connection Roller with 1085E.....
1085E	9658	Feed Forked Connection Roller Screw Stud.....
32510	4376	Feed Raising Bar with 1944.....
1301C	9658	" " " Hinge Screw.....
1944	4376	" " " Roller and Stud.
253B	9658	" Regulating Thumb Screw.....
8216	4376	" Regulator.....
8217	4376	" " Friction Washer...
42E	9658	" " Hinge Screw.....
32581	2933	" Rock Shaft.....
307C	9658	" " " Screw Center.....
56814	----	" " " " " 307C with 1513J.....
1513J	9658	Feed Rock Shaft Screw Center Nut.
51045C	9658	Machine Hinge Connection Set Screw.....

No.	Plate	Name
32668	2934	Needle Bar with 32519.....
66559	2934	" " Bushing.....
66655	----	" " " 66553 with 665J and 66639.....
1133E	2934	Needle Bar Bushing Set Screw.....
*32515	2934	" " Connecting Link with 51002E.....
32669	----	Needle Bar Connecting Link 32515 with 66559.....
32670	----	Needle Bar Connecting Link 32669 with 1130E and 32579.....
51002E	9658	Needle Bar Connecting Link Adjust- ing Screw.....
1130E	2934	Needle Bar Connecting Link Cap Screw.....
66559	2934	Needle Bar Connecting Stud with 1353C.....
1353C	2934	Needle Bar Connecting Stud Set Screw.....
32517	2934	Needle Bar Crank with 1036C and 1134C.....
1134C	2934	Needle Bar Crank Position Screw..
2136C	2934	" " Hole Plug.....
66639	2934	" " Thread Guard.....
665J	2934	" " " Screw....
66561	2934	" " Timing Gauge.....
2054	2934	" Clamp with 552C.....
552C	2934	" " Thumb Screw.....
32519	2934	" Stop Pin.....
32520	22676	Oscillating Hook.....
32626	----	" " 32520 with 32590.
32656	22676	" " Bell Crank.....
32657	----	" " " " 32656 with 50561C.....
50561C	22676	Oscillating Hook Bell Crank Hinge Screw.....
32522	22676	Oscillating Hook Bobbin.....
32590	22676	" " " Case with 1172F, 1173D and 32567.....
32659	22676	Oscillating Hook Bobbin Case Po- sition Bracket.....
32660	----	Oscillating Hook Bobbin Case Po- sition Bracket complete, Nos. 662D, 32528, 32598, 32599, 32659, 32661 to 32664, 50579D and 50580E.....
32661	22676	Oscillating Hook Bobbin Case Cushion Spring.....
662D	22676	Oscillating Hook Bobbin Case Cushion Spring Screw.....

No.	Plate	Name
32662	22678	Oscillating Hook Bobbin Case Position Bracket Hinge Stud.....
50611J	22678	Oscillating Hook Bobbin Case Position Bracket Hinge Stud Set Screw.....
32663	22678	Oscillating Hook Bobbin Case Position Bracket Latch.....
50579D	22678	Oscillating Hook Bobbin Case Position Bracket Latch Screw....
32598	22678	Oscillating Hook Bobbin Case Position Bracket Oil Pad (felt) Per 100.....
32599	22678	Oscillating Hook Bobbin Case Position Bracket Oil Pad Holder.
1172F	22678	Oscillating Hook Bobbin Case Tension Regulating Screw.....
32567	22678	Oscillating Hook Bobbin Case Tension Spring.....
1173D	22678	Oscillating Hook Bobbin Case Tension Spring Screw.....
32664	22678	Oscillating Hook Bobbin Ejector..
50580E	22678	" " " " Hinge Screw Stud.....
32528	22678	Oscillating Hook Bobbin Ejector Spring.....
32529	22678	Oscillating Hook Connecting Link.
1132C	22678	" " " " Hinge Screw.....
32594	22678	Oscillating Hook Crank with 1485J
1485J	22678	" " " Clamping Screw.....
32531	2933	Oscillating Hook Pitman with two 175J.....
175J	9657	Oscillating Hook Pitman Adjusting Screw.....
44C	22678	Oscillating Hook Pitman Screw Stud (left).....
1216C	22678	Oscillating Hook Pitman Screw Stud (right).....
216C	22678	Oscillating Hook Pitman Screw Stud (right) Cap Screw.....
1520J	9658	Oscillating Hook Pitman Screw Stud (right) Nut.....
32569	9659	Oscillating Hook Slide.....
32570	9658	" " " Friction Spring.....
226D	22678	Oscillating Hook Slide Friction Spring Screw.....
32665	2933	Presser Bar.....

No.	Plate	Name
32535	2936	Presser Bar Guide Bracket with 400K and 453C.....
400K	2936	Presser Bar Guide Bracket Adjusting Screw.....
453C	2936	Presser Bar Guide Bracket Set Screw.....
66564	9658	Presser Bar Lifter.....
85E	2936	" " " Screw.....
32675	9667	" " Spring.....
2070	2936	" " " Washer.....
32666	2934	" Foot.....
51224B	9657	" Thumb Screw.....
263B	9658	Pressure Regulating Thumb Screw..
32621	2936	Slack Thread Regulator.....
219E	2936	" " " Screw.....
2102	2936	Tension Disc.....
1560B	2936	" Regulating Thumb Nut.....
32572	2936	" Releasing Disc.....
32573	2936	" " Lever.....
97E	2936	" " " Hinge Screw
12329	2936	" " " Spring.....
32574	2936	" " Pin.....
1274J	2936	" Screw Stud.....
8238	2936	" Spring.....
32654	----	Tension complete, Nos. 1274J, 1560B, 8238, 32572, 32574 to 32576 and two 2102.....
26075	9658	Thread Cutter and Holder.....
8422	2936	" Guard (head of arm).....
32578	2936	" Take-up Crank.....
1036C	2936	" " " Set Screw...
32541	2936	" " Lever.....
32542	----	Thread Take-up Lever complete, Nos. 32541, 32543 and 32544...
32671	----	Thread Take-up Lever 32542 with 1131C and 32670.....
32543	2936	Thread Take-up Lever Hinge Stud..
32544	2936	" " " Link.....
1131C	2936	" " " " Hinge Screw.....
32575	2936	Thread Take-up Spring.....
32576	2936	" " " Regulator..
453C	2936	" " " " Set Screw.....
32602	2934	Throat Plate for 32600.....
691A	9658	" " Screw.....
*15404	----	Trade Mark.....
15405	----	" " Rivet.....

MACHINE No. 66-5

THIS MACHINE IS THE SAME AS NO. 66-4,
WITH THE ADDITION OF THE FOLLOWING:

HAND ATTACHMENT PARTS

No.	Plate	Name
94050	9669	Hand Attachment Body.....
94027	9669	" " " Bracket....
183E	9660	" " " " Screw
94028	9669	" " Crank Handle (wood)
94029	9660	" " " " Spindle
94030	9660	" " " " "
		Flange (loose).....
8280	9660	Hand Attachment Crank Hinge Pin..
94031	9669	" " " " Lever.....
94032	9660	" " " " Lock
		Pin.....
94033	9660	Hand Attachment Crank Lever Lock
		Pin Head.....
8282	9660	Hand Attachment Crank Lever Lock
		Pin Spring.....
94034	----	Hand Attachment Crank complete, Nos. 94028 to 94031.....
94046	9660	Hand Attachment Driver.....
94036	9660	" " " " Finger....
94041	----	" " " " 94036 with SS567E, 94039 and 94040..
94039	9660	Hand Attachment Driver Finger
		Driving Fad (rawhide).....
94040	9660	Hand Attachment Driver Finger
		Driving Pad Plate.....
SS567E	9660	Hand Attachment Driver Finger
		Driving Pad and Plate Binding
		Screw.....
94044	9660	Hand Attachment Driver Finger
		Hinge Pin.....
94037	9660	Hand Attachment Driver Finger
		Latch.....
SS565E	9660	Hand Attachment Driver Finger
		Latch Screw Stud.....
94038	9660	Hand Attachment Driver Finger
		Latch Spring.....
94051	9669	Hand Attachment Gear with 8282, 94032 and 94033.....

No.	Plate	Name
94016	9663	Hand Attachment Gear Cover.....
399A	9660	" " " " Screw.
SS599F	9660	" " " " Screw Stud..
94048	9660	" " " " Pinion.....
80028	9660	" " " " Dowel Pin
		Per 100.....
SS600F	9660	Hand Attachment Pinion Screw Stud
94052	----	Hand Attachment complete, Nos. SS565E, SS566C, SS599F, SS600F, 8280, 80028, 94016, 94027, 94034, 94037, 94038, 94041, 94044, 94046, 94048, 94050, 94051 and two each 183E and 399A.....
SS566C	9660	Hand Attachment Screw.....

SINGER Needles should be used
in SINGER Machines.
These Needles and their Containers
are marked with the
Company's Trade-Mark "SIMANCO."** 1

Needles in Containers marked
"FOR SINGER MACHINES"
are NOT **SINGER** made needles. 2

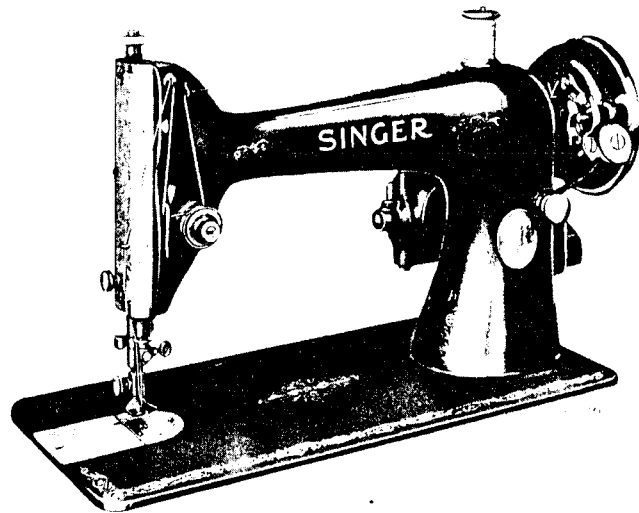

MACHINE No. 66-6

THIS MACHINE IS THE SAME AS NO. 66-4,
WITH THE FOLLOWING EXCEPTION:

No.	Plate	Name
32672	4951	Balance Wheel 3 1/4 in. pulley in place of 15282.....

ACCESSORIES

No.	Plate	Name
36569	----	Oiler with 36571.....
36570	----	" 36569, filled with oil.....
36571	----	" Spout 1 3/4 in. long.....
36807	9661	" " Washer (leather).....
120329	----	Machine Cover.....

ATTACHMENT SET

No.	Plate	Name
121461	----	Binder Folder.....
121463	----	" Foot.....
51104B	9658	" Screw.....
120565	9658	" " Washer.....
121464	22526	Binder complete, Nos. 51104B, 120565, 121461 and 121463.....
32522	22676	Bobbin (five).....
25527	22529	Cloth Guide.....
50053B	22684	" " Thumb Screw.....
35931	22684	Hemmer (adjustable).....
120842	22684	" (foot) 5/64 in. hem.....
-----	-----	Needles (six).....
25537	9669	Screw Driver (machine).....
120378	9669	" " (shuttle tension)...
8879	4376	Spool Pin Washer (cloth).....
36583	4942	Tucker.....
120359	----	Attachment Set, Nos. 8879, 25527, 25537, 35931, 36583, 50053B, 120378, 120842, 121464, five 32522 and six needles.....
120598	4942	Ruffler for one, six and twelve stitch ruffling.....
120607	----	Attachment Set complete, Nos. 120359 and 120598.....

BIAS GAUGE

No.	Plate	Name
25525	4958	Bias Gauge.....

No.	Plate	Name
121093	9658	Darning Foot Spring.....
121094	22526	Darning Foot (spring) complete, Nos. 121091 to 121093.....

EDGE STITCHER

No.	Plate	Name
36865	9661	Edge Stitcher.....

EMBROIDERY ATTACHMENT

FOR ONE THREAD

No.	Plate	Name
120876	4938	Driving Lever with 120877 and two 9859.....
22232	4938	Driving Lever Friction Washer....
26784	4938	" " Hinge Stud.....
26523	4938	" " Washer.....
26524	4938	Frame with 26525.....
26525	4938	" Block.....
26527	4938	Looper.....
468C	4938	" Set Screw.....
26528	4938	Scroll with 468C.....
26529	4938	" Carrier with 26531.....
22232	4938	" " Friction Washer...
26530	4938	" " Hinge Stud.....
26531	4938	" " Pin.....
26532	4938	" Cover.....
26533	4938	" Driving Lever with 26534...
26534	4938	" " Stud.....
26535	4938	Spool Pin, for Arm of Machine....
120877	4938	Thread Bracket.....
9859	4938	" " Rivet.....Per 100
26537	4938	" Eyelet.....
26785	4938	" Retaining Spring.....
240J	4938	" " Screw....
26538	22526	Embroidery Attachment complete, Nos. 240J, 26523, 26524, 26527 to 26530, 26532, 26533, 26535, 26537, 26784, 26785, 120876 and two 22232.....

EMBROIDERY ATTACHMENT

FOR TWO THREADS

No.	Plate	Name
35483	4937	Body.....
35484	4937	" Block.....
12152	4937	" " Rivet.....Per 100
35485	4937	Driving Lever.....
35486	4937	" " Arm (lower).....
35487	4937	" " " (upper).....
35488	4937	" " " Guide.....
35489	4937	" " " Hinge Stud....
35490	4937	" " " Spring.....
35491	4937	" " Hinge Stud.....
35492	4937	Thread Carrier (left).....
35493	4937	" " " Hinge Stud.
35494	4937	" " (right).....
50139B	4937	" " Hinge Screw
35495	4937	" " Friction Plate....
35496	4937	Embroidery Attachment, Nos. 190B, 12152, 35483 to 35488, 35490 to 35495, 35498, 50139B and two 35489.....
190B	9658	Embroidery Attachment Screw.....
35497	4936	Spool Bracket.....
35498	4936	" " Stud.....
1422B	4936	" " Tension Regulating Thumb Screw.....
35499	4936	Spool Bracket Tension Spring....
35500	4936	" " " " Po- sition Pin.....
35500	4936	Spool Bracket Thread Guide Pin...
35501	4936	" " Wire.....
35502	4936	" " " Hinge Stud....
35503	4936	" " " " Washer
35504	4936	Spool Bracket complete, Nos. 1422B, 35497, 35499, 35502, 35503 and two each 35500 and 35501.....
35505	----	Embroidery Attachment complete, Nos. 35496 and 35504.....

FEED COVER PLATES

No.	Plate	Name
32622	9663	Feed Cover Plate (flat top) for art work.....
32589	9663	Feed Cover Plate (oval top) for art work.....

FELLER

No.	Plate	Name
36835	9661	Feller (foot).....

HEMMERS (Foot)

No.	Plate	Name
25904	9661	Hemmer (foot) 1/16 in. hem for silk ties.....
36333	----	Hemmer (foot) 1/16 in. hem for chiffon and silk.....
120842	22684	Hemmer (foot) 5/64 in. hem.....
25895	9661	" " 1/8 in. hem for shirt work.....
35884	9661	Hemmer (foot) 3/16 in. hem.....
36469	9661	" " for chiffon and silk slotted for lace.....
6267	9661	Hemmer Folder.....
25888	9661	" Tongue.....

Note: When ordering Nos. 6267 or 25888 give width of hem and No. of Hemmer for which it is required.

HEMSTITCHER

No.	Plate	Name
120687	22526	Hemstitcher with yielding Presser Plate.....

PRESSER FEET

No.	Plate	Name
15429	22528	Presser Foot (left toe) for stitching on edge and inserting braid.....
125035	22528	Presser Foot (right toe) for stitching on edge and inserting braid.....
28831	9662	Presser Foot for darning.....
121614	9662	" " with 51282J and 121615 for blind stitch braiding for soutache braid.....
121615	9662	Presser Foot Braid Guide.....
Note: When ordering Nos. 121614 or 121615 send sample of braid for which it is required.		
51282J	9662	Presser Foot Braid Guide Screw...
36058	22528	" " with 665B and 36059 for blind stitch cording to turn small curves.....
36059	-----	Presser Foot Cord Guide.....
Note: When ordering Nos. 36058 or 36059 send sample of cord for which it is required.		
665B	2934	Presser Foot Cord Guide Screw....
36067	22528	" " for braiding for art work for braid 1/16 in. to 3/16 in. wide.....
Note: In ordering number 36067 state the size or send a sample of the braid for which it is required.		
121441	22528	Presser Foot for gathering.....

QUILTER

No.	Plate	Name
35932	22528	Quilter.....

RUFFLERS

No.	Plate	Name
120598	4942	Ruffler for one, six and twelve stitch ruffling.....
*121171	----	Ruffler Shirring Plate.....

RUFFLERS

No.	Plate	Name
*121172	----	Ruffler Shirring Plate Blade.....
121625	----	" " " " Rivet
51395W	9662	" " " Thumb Screw
121170	9662	Ruffler Shirring Plate (universal) complete, Nos. 51395W, 121171, 121172 and two 121625.....
121584	----	Ruffler 120598 with 121170.....

TUBULAR TRIMMING ATTACHMENT

No.	Plate	Name
35018	9669	Strip Delivery Blade.....
120824	4958	" Wire.....
35984	4958	Presser Foot (strip folding) with tube.....
35985	----	Tubular Trimming Attachment com- plete, for making 3/32 in., 1/8 in., and 5/32 in. trimmings, Nos. 35018, 35984 and 120824..

Note: When ordering No. 35985, state size re-
quired.

TUCK FOLDER

No.	Plate	Name
225923	2928	Folder.....
171A	9662	" Adjusting Screw.....
36090	2928	" Arm with 50069E.....
50066E	----	" Screw Stud.....
50067D	9662	" " " Cap Screw.....
19044	9662	" " " " " Spring Washer.....
1704B	9662	Folder Screw Stud Thumb Nut.....
202600	9662	" " " " " Washer
225926	2928	Space Gauge.....
50068E	9662	" " Screw Stud.....
1705B	9662	" " " " Thumb Nut.
202603	9662	" " " " " "
		Washer.....
36091	2928	Tuck Folder complete for small pieces of goods, Nos. 171A, 1704B, 1705B, 19044, 36090, 50066E, 50067D, 202600, 202603, 225923, 225926 and two 1483H.....

TUCK FOLDER

No.	Plate	Name
1483H	9662	Tuck Folder Thumb Screw.....
36092	9662	Presser Foot.....

UNDER BRAIDER

No.	Plate	Name
121547	22529	Under Braider.....

SINGER Needles should be used
in SINGER Machines.
These Needles and their Containers
are marked with the
Company's Trade-Mark "SIMANCO.***" 1

Needles in Containers marked
"FOR SINGER MACHINES"
are NOT **SINGER** made needles. 2

B. R. FAMILY SEWING MACHINE MOTORS

Motor Catalog No.	RATING			CONTROLLER PART NUMBERS			
	Volts	Cycles	Amperes	Convertible for Foot or Knee Control Sets Nos. 40, 47, 50, 401 and 402	Foot Control Only	Treadle Control for Stands Nos. 25281, 25282 and 25094	Treadle Control for Stands Nos. 46909, 46912 and 46913
B.R. 3	32	D.C. Only	1.4	194587	194583	194384	194381
B.R. 5	50	D.C. and 25 to 75	1.1	194587	194583	194384	194381
B.R. 6	95-100	D.C. and 25 to 75	0.6	194588	194584	194385	194382
B.R. 7	100-110	D.C. and 25 to 75	0.6	194588	194584	194385	194382
B.R. 8	115-125	D.C. and 25 to 75	0.5	194588	194584	194385	194382
B.R. 9	150-165	D.C. and 25 to 75	0.4	194589	194585	194386	194383
B.R. 10	200-220	D.C. and 25 to 75	0.3	194589	194585	194386	194383
B.R. 11	210-230	D.C. and 25 to 75	0.3	194589	194585	194386	194383
B.R. 12	230-250	D.C. and 25 to 75	0.3	194589	194585	194386	194383
B.R. 14	125-135	D.C. and 25 to 75	0.5	194588	194584	194385	194382
B.R. 15	130-145	D.C. and 25 to 75	0.5	194588	194584	194385	194382
B.R. 87	100-110	80 to 100	0.7	194588	194584	194385	194382
B.R. 90	200-220	80 to 100	0.4	194589	194585	194386	194383
B.R. 92	230-250	80 to 100	0.3	194589	194585	194386	194383

GUIDE FOR ORDERING

Example of a correct order:

"B.R. 7 Motor with Belt No. 193066 and Controller No. 194588" (Belt No. and Controller No. must be specified on order.)

This means a B.R. 7 Motor, 100-110 Volts for Foot or Knee Control for Sets Nos. 40, 47, 50, 401 and 402 and is comprised of the following: B.R. 7 Motor, Motor Bracket complete with screws, Three-Pin Terminal, (male-half), complete, Belt, Controller, with Lead

No.	Plate	Name
193476	----	Armature complete for B.R. 3 Motor.....
193477	----	Armature complete for B.R. 5 Motor
193318	20160	" " " B.R. 6 and B.R. 7 Motors.....
193478	----	Armature complete for B.R. 8 Motor
193479	----	" " " B.R. 9 Motor
193480	----	" " " B.R. 10 and B.R. 92 Motors.....
193481	----	Armature complete for B.R. 11 and B.R. 12 Motors.....
194635	----	Armature complete for B.R. 14 Motor.....
193482	----	Armature complete for B.R. 15 Motor.....
193483	----	Armature complete for B.R. 87 Motor.....
193484	----	Armature complete for B.R. 90 Motor.....
193230	21466	Armature Shaft Bearing Sleeve Cap (commutator end).....
194494	21466	Armature Shaft Grease Cup Body...
194490	21466	" " " " Wick (felt).....
194326	21466	Armature Shaft Grease Wick Spring
191097	21466	" Thrust Washer (commutator end) fibre.....
701400	21466	Armature Thrust Washer (pulley end) fibre.....
191098	21466	Armature Thrust washer (pulley end) peerless paper.....
193066	4950	Belt (moulded) for Spoked Balance Wheel No. 15282.....
193077	4951	Belt (moulded) for Disc Balance Wheel No. 32672.....
190782	21466	Brush (carbon) for 32 to 145 volts.....
192947	----	Brush (carbon) for 150 to 250 volts.....
193229	21466	Brush Cap.....
190083	21466	" Spring.....
193228	21466	" Tube.....
193238	21466	" " Terminal.....
190059	20160	Commutator complete.....
*193226	20160	End Cover (commutator end).....
*193227	20160	" " (pulley end).....

MOTOR PARTS

MOTOR PARTS

No.	Plate	Name
194295	-----	End Covers complete, Nos. 193226, 193227 and two each 194326, 194490 and 194494.....
Note: As the End Covers are line reamed in pairs no orders will be filled for End Covers separately. Agencies Orders will only be filled with End Covers complete No. 194295.		
51206R	21466	End Cover Screw.....
193236	21466	Fan.....
193440	-----	Field Coil complete for B.R. 3 Motor.....
193443	-----	Field Coil complete for B.R. 5 Motor.....
193446	-----	Field Coil complete for B.R. 6 Motor.....
193449	-----	Field Coil complete for B.R. 7 Motor.....
193452	-----	Field Coil complete for B.R. 8 Motor.....
193455	-----	Field Coil complete for B.R. 9 Motor.....
193458	-----	Field Coil complete for B.R. 10 and B.R. 11 Motors.....
193461	-----	Field Coil complete for B.R. 12 Motor.....
194636	-----	Field Coil complete for B.R. 14 Motor.....
193464	-----	Field Coil complete for B.R. 15 Motor.....
193467	-----	Field Coil complete for B.R. 87 Motor.....
193470	-----	Field Coil complete for B.R. 90 Motor.....
193473	-----	Field Coil complete for B.R. 92 Motor.....
190563	21466	Field Coil Retainer.....
192240	21466	" " Tube (paper).....
193438	20160	Field Core complete.....
193239	20160	" " Shield.....
193285	-----	" " " 193239 with 899380 and two 700792, for B.R. 7 Motor.....
193286	-----	Field Core Shield 193239 with 899381 and two 799792, for all B.R. Motors except B.R.7 Motor
192851	21470	Lead Cord complete with Three-Pin Terminal (female half) from lamp socket to three-pin terminal, for knee or treadle control.....

MOTOR PARTS

No.	Plate	Name
192641	9663	Motor Bracket.....
50632C	9664	" " Screw.....
190058	9664	" " " Retaining Washer (fibre).....
191417	9664	Motor Bracket Screw Washer.....
193287	-----	Motor Bracket complete, Nos. 50632C, 51208B, 190058, 191417, 192641 and 701513.....
51208B	9664	Motor Screw.....
701513	9664	" " Retaining Washer (fibre).....
•899380	-----	Name Plate for B.R. 7 Motor.....
•899381	-----	" " " all B.R. Motors except B.R. 7 Motor.....
700792	9664	Name Plate Rivet.....
193231	9664	Pulley (moulded).....
51207C	9664	" Set Screw.....
51093R	9664	Three-Pin Terminal (female half) Housing Screw.....
1768R	9664	Three-Pin Terminal (female half) Housing Screw Nut.....
192692	9664	Three-Pin Terminal (female half) Insert Clamp.....
194533	21470	Three-Pin Terminal (female half) complete for 192851, with two each 1768R, 51093R and three 192692.....
51582	9664	Three-Pin Terminal Body (male half) Post Thumb Nut.....
701719	9664	Three-Pin Terminal Body (male half) Post Washer.....
192797	9663	Three-Pin Terminal Body (male half) complete, with three each 51582 and 701719.....
145R	9664	Three-Pin Terminal Body (male half) Screw.....
190613	----	Tube filled with Singer Motor Lubricant packed in carton.....

CONTROLLERS (Bakelite)

CONVERTIBLE FOR FOOT OR KNEE CONTROL

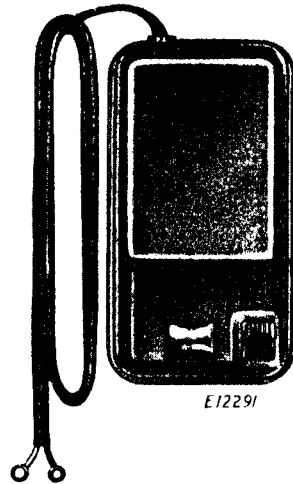

E12291

FOR SETS NOS. 40, 47, 50, 401 AND 402

No.	Plate	Name
194587	-----	Controller complete, for 32 to 55 volts, A.C. or D.C. Motor, Nos. 194321, 194569, 194573, 194579, 899287, two 964317 and four each 140099R and 194407.....
194588	-----	Controller complete, for 95 to 145 volts, A.C. or D.C. Motor, Nos. 194321, 194570, 194573, 194579, 899816, two 964317 and four each 140099R and 194407..
194589	-----	Controller complete, for 150 to 250 volts, A.C. or D.C. Motor, Nos. 194321, 194571, 194573, 194579, 899287, two 964317 and four each 140099R and 194407..
194572	21470	Controller Base.....
194569	-----	Controller Base 194572 with 192211, 194418, 194774, 194775 and two each 23258, 140100R, 140103R, 194404, 194514 and 931090, for 194587.....
194570	-----	Controller Base 194572 with 192140, 194418, 194774, 194775, and two each 23258, 140100R, 140103R, 194404, 194514 and 931090, for 194588.....

No.	Plate	Name
194571	-----	Controller Base 194572 with 192141, 194418, 194774, 194775 and two each 23258, 140100R, 140103R, 194404, 194514 and 931090, for 194589.....
194407	22521	Controller Base Cushion (rubber).
140099R	9664	" " Screw.....
194573	21470	" Cover.....
194321	22521	" Foot Pedal.....
194579	21470	Controller Lead complete.....
192211	9665	" Resistance Unit, for 32 to 55 volts.....
192140	9665	Controller Resistance Unit, for 95 to 145 volts.....
192141	9665	Controller Resistance Unit, for 150 to 250 volts.....
194774	9664	Controller Resistance Unit Adjusting Nut.....
194775	9664	Controller Resistance Unit Adjusting Nut Lock Spring.....
194416	9664	Controller Resistance Unit Bell Crank.....
51340C	9664	Controller Resistance Unit Bell Crank Hinge Screw.....
1607J	9664	Controller Resistance Unit Bell Crank Hinge Screw Nut.....
194404	22521	Controller Resistance Unit Bell Crank Spring.....
194402	22521	Controller Resistance Unit Bell Crank Spring Bracket.....
194418	-----	Controller Resistance Unit Bell Crank Spring Bracket 194402 with 194416, 194773 and two each 1607J and 51340C.....
140100R	9664	Controller Resistance Unit Bell Crank Spring Bracket Screw....
194514	9664	Controller Resistance Unit Bell Crank Spring Bracket Screw Insulating Disc.....
140103R	9664	Controller Resistance Unit Screw.
931090	9664	" " " "
		Washer (asbestos).....
23258	9664	Controller Resistance Unit Screw Washer (steel).....
194773	9664	Controller Resistance Unit Yoke..
51340C	9664	" " " "
		Hinge Screw.....
1607J	9664	Controller Resistance Unit Yoke Hinge Screw Nut.....

No.	Plate	Name
*899816	----	Name Plate for 194588.....
*899287	----	" " " 194587 and 194589.
964317	9664	" " Drive Screw.....

CONTROLLER HOLDER

No.	Plate	Name
136136	22520	Controller Holder with four wood screws 3/8 in. No. 4 Rd. Hd., for Bakelite Controllers Nos. 194587 to 194589.....

KNEE LEVER PARTS

FOR SETS NOS. 40, 47, 50, 401 AND 402

No.	Plate	Name
194437	22520	Knee Lever.....
194436	----	" " 194437 with 1611TM, 140107TM, 194438, 194470 and 194545.....
194549	22521	Knee Lever Connecting Link.....
140105TM	9666	" " " " Hinge Screw.....
1550TM	9666	Knee Lever Connecting Link Hinge Screw Nut.....
194438	22520	Knee Lever Extension.....
194550	22520	" " " Hinged Bracket
194551	22520	" " " " "
		Frame.....
194431	----	Knee Lever Extension Hinged Bracket Frame 194551 with 1550TM, 1708J, 140105TM, 140106J, 194434, 194549 and 194550.....
-----	-----	Knee Lever Extension Hinged Bracket Frame Wood Screw 5/8 in. No. 6 Rd. Hd.....
140106J	9666	Knee Lever Extension Hinged Bracket Hinge Screw.....
1708J	9666	Knee Lever Extension Hinged Bracket Hinge Screw Nut.....
194434	9666	Knee Lever Extension Hinged Bracket Spring.....

No.	Plate	Name
51224TM	9657	Knee Lever Extension Thumb Screw.
5480	9656	" " " " "
		Friction Washer.....
140107TM	9666	Knee Lever Hinge Screw.....
194545	9666	" " " " Friction Washer.....
1611TM	9666	Knee Lever Hinge Screw Nut.....
194470	9666	" " " " Washer....
194430	----	Knee Lever with Controller Operating Unit complete, Nos. 5480, 51224TM, 194431, 194436 and four wood screws 5/8 in. No. 6 Rd. Hd.....

SINGER Needles should be used
in SINGER Machines.
These Needles and their Containers
are marked with the
Company's Trade-Mark "SIMANCO."*** 1

Needles in Containers marked
"FOR SINGER MACHINES"
are NOT SINGER made needles. 2

FOOT CONTROLLERS (Bakelite)

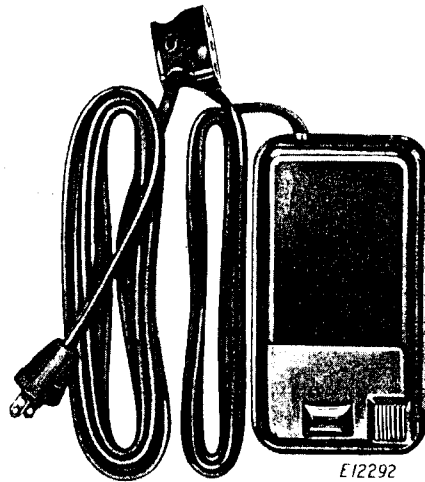

No.	Plate	Name
194583	-----	Controller complete, for 32 to 55 volts, A.C. or D.C. Motor, Nos. 194321, 194569, 194573, 194574, 899287, two 964317 and four each 140099R and 194407.....
194584	-----	Controller complete, for 95 to 145 volts, A.C. or D.C. Motor, Nos. 194321, 194570, 194573, 194574, 899815, two 964317 and four each 140099R and 194407.....
194585	-----	Controller complete, for 150 to 250 volts, A.C. or D.C. Motor, Nos. 194321, 194571, 194573, 194574, 899287, two 964317 and four each 140099R and 194407..
194572	21470	Controller Base.....
194569	-----	" " 194572 with 192211, 194418, 194774, 194775 and two each 23258, 140100R, 140103R, 194404, 194514 and 931090, for 194583.....
194570	-----	Controller Base 194572 with 192140, 194418, 194774, 194775 and two each 23258, 140100R, 140103R, 194404, 194514 and 931090, for 194584.....

No.	Plate	Name
194571	-----	Controller Base 194572 with 192141, 194418, 194774, 194775 and two each 23258, 140100R, 140103R, 194404, 194514 and 931090, for 194585.....
194407	22521	Controller Base Cushion (rubber).
140099R	9664	" " Screw.....
194573	21470	" Cover.....
194321	22521	" Foot Pedal.....
194574	21470	Controller Lead Cord complete with Three-Pin Terminal (female half) from lamp socket to three-pin terminal and controller.....
192211	9665	Controller Resistance Unit, for 32 to 55 volts.....
192140	9665	Controller Resistance Unit, for 95 to 145 volts.....
192141	9665	Controller Resistance Unit, for 150 to 250 volts.....
194774	9664	Controller Resistance Unit Adjusting Nut.....
194775	9664	Controller Resistance Unit Adjusting Nut Lock Spring.....
194416	9664	Controller Resistance Unit Bell Crank.....
51340C	9664	Controller Resistance Unit Bell Crank Hinge Screw.....
1607J	9664	Controller Resistance Unit Bell Crank Hinge Screw Nut.....
194404	22521	Controller Resistance Unit Bell Crank Spring.....
194402	22521	Controller Resistance Unit Bell Crank Spring Bracket.....
194418	-----	Controller Resistance Unit Bell Crank Spring Bracket 194402 with 194416, 194773 and two each 1607J and 51340C.....
140100R	9664	Controller Resistance Unit Bell Crank Spring Bracket Screw....
194514	9664	Controller Resistance Unit Bell Crank Spring Bracket Screw Insulating Disc.....
140103R	9664	Controller Resistance Unit Screw.
931090	9664	" " " "
		Washer (asbestos).. ..
23258	9664	Controller Resistance Unit Screw Washer (steel).....
194773	9664	Controller Resistance Unit Yoke..

No.	Plate	Name
51340C	9664	Controller Resistance Unit Yoke Hinge Screw.....
1607J	9664	Controller Resistance Unit Yoke Hinge Screw Nut.....
*899815	-----	Name Plate for 194584.....
*899287	-----	" " " 194583 and 194585.
964317	9664	" " Drive Screw.....
51093R	9664	Three-Pin Terminal (female half) Housing Screw.....
1768R	9664	Three-Pin Terminal (female half) Housing Screw Nut.....
192692	9664	Three-Pin Terminal (female half) Insert Clamp.....
194521	21470	Three-Pin Terminal (female half) complete for 194574, Nos. two each 1768R, 51093R and three 192692.....

SINGER Needles should be used
in SINGER Machines.
These Needles and their Containers
are marked with the
Company's Trade-Mark "SIMANCO.**" 1

Needles in Containers marked
"FOR SINGER MACHINES"
are NOT **SINGER** made needles. 2

TREADLE CONTROLLERS (Bakelite)



FOR STANDS NOS. 25281, 25282 AND 25294

No.	Plate	Name
194384	-----	Controller complete, for 32 to 55 volts, A.C. or D.C. Motor, Nos. 194426, 194455, 194491 and two 140102R.....
194385	-----	Controller complete, for 95 to 145 volts, A.C. or D.C. Motor, Nos. 194454, 194455, 194492 and two 140102R.....
194386	-----	Controller complete, for 150 to 250 volts, A.C. or D.C. Motor, Nos. 194426, 194455, 194493 and two 140102R.....
194322	9665	Controller Base.....
194491	----	" " 194322 with 23258, 192211, 193908, 194422, 194479, 194774, 194775, two each 140100R, 140103R, 194421, 194514 and 931090, for 194384.

TREADLE CONTROLLERS

No.	Plate	Name
194492	-----	Controller Base 194322 with 23258, 192140, 193908, 194422, 194479, 194774, 194775, two each 140100R, 140103R, 194421, 194514 and 931090, for 194385.....
194493	-----	Controller Base 194322 with 23258, 192141, 193908, 194422, 194479, 194774, 194775, two each 140100R, 140103R, 194421, 194514 and 931090, for 194386.....
198001	9667	Controller Bracket for Cabinet Tables.....
198002	----	Controller Bracket for Cover Sets
51119J	9666	" " Screw.....
194323	9665	" Cover.....
194454	----	" " 194323 with 899691 and two 964317, for 194385....
194426	----	Controller Cover 194323 with 899287 and two 964317, for 194384 and 194386.....
140102R	9666	Controller Cover Screw.....
194455	----	Controller Lead complete.....
193908	9666	" " Clamp.....
194479	9666	" " Insulation.
192866	9666	" Pitman Rod Connection.
192211	9665	" Resistance Unit for 32 to 55 volts.....
192140	9665	Controller Resistance Unit for 95 to 145 volts.....
192141	9665	Controller Resistance Unit for 150 to 250 volts.....
194774	9664	Controller Resistance Unit Adjusting Nut.....
194775	9664	Controller Resistance Unit Adjusting Nut Lock Spring.....
194416	9664	Controller Resistance Unit Bell Crank.....
194324	9666	Controller Resistance Unit Bell Crank Connecting Link.....
140101C	9666	Controller Resistance Unit Bell Crank Connecting Link Hinge Screw.....
1607J	9664	Controller Resistance Unit Bell Crank Connecting Link Hinge Screw Nut.....
51340C	9664	Controller Resistance Unit Bell Crank Hinge Screw.....
1607J	9664	Controller Resistance Unit Bell Crank Hinge Screw Nut.....

TREADLE CONTROLLERS

No.	Plate	Name
194421	9666	Controller Resistance Unit Bell Crank Spring.....
194402	22521	Controller Resistance Unit Bell Crank Spring Bracket.....
194422	-----	Controller Resistance Unit Bell Crank Spring Bracket 194402 with 51340C, 140101C, 194324, 194416, 194773 and two 1607J..
140100R	9664	Controller Resistance Unit Bell Crank Spring Bracket Screw....
194514	9664	Controller Resistance Unit Bell Crank Spring Bracket Screw Insulating Disc.....
140103R	9664	Controller Resistance Unit Screw.
931090	9664	" " " "
		Washer (asbestos).....
23258	9664	Controller Resistance Unit Screw Washer (steel).....
194773	9664	Controller Resistance Unit Yoke..
*899691	----	Name Plate for 194454.....
*899287	----	" " " 194426.....
964317	9664	" " Drive Screw.....

SINGER Needles should be used
in SINGER Machines.
These Needles and their Containers
are marked with the
Company's Trade-Mark "SIMANCO.**" 1

Needles in Containers marked
"FOR SINGER MACHINES"
are NOT **SINGER** made needles. 2

TREADLE CONTROLLERS (Bakelite)

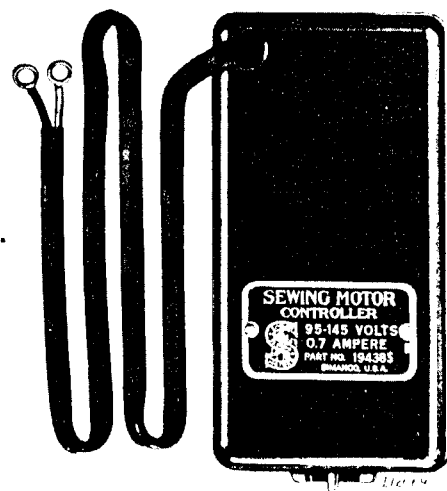

FOR STANDS NOS. 46909, 46912 AND 46913

No.	Plate	Name
194381	-----	Controller complete, for 32 to 55 volts, A.C. or D.C. Motor, Nos. 194423, 194426, 194491 and two 140102R.....
194382	-----	Controller complete, for 95 to 145 volts, A.C. or D.C. Motor, Nos. 194423, 194425, 194492 and two 140102R.....
194383	-----	Controller complete, for 150 to 250 volts, A.C. or D.C. Motor, Nos. 194423, 194426, 194493 and two 140102R.....
194322	9665	Controller Base.....
194491	----	" " 194322 with 23258, 192211, 193908, 194422, 194479, 194774, 194775, two each 140100R, 140103R, 194421, 194514 and 931090.....

No.	Plate	Name
194492	-----	Controller Base 194322 with 23258, 192140, 193908, 194422, 194479, 194774, 194775, two each 140100R, 140103R, 194421, 194514 and 931090.....
194493	-----	Controller Base 194322 with 23258, 192141, 193908, 194422, 194479, 194774, 194775, two each 140100R, 140103R, 194421, 194514 and 931090.....
198162	9667	Controller Bracket for 198164....
194399	----	" " " 194468....
198164	----	" " 198162 with 198163 and three 51119R, for Stands Nos. 46909 and 46912...
194468	----	Controller Bracket 194399 with 126R and 1549R, for Stand No. 46913.....
198163	9667	Controller Bracket Clamp for 198164.....
51119R	9666	Controller Bracket clamp Screw for 198164.....
126R	9666	Controller Bracket Screw for 194468.....
1549R	9666	Controller Bracket Screw Nut for 194468.....
194323	9665	Controller Cover.....
194425	----	" " 194323 with 899688 and two 964317, for 194382....
194426	----	Controller Cover 194323 with 899287 and two 964317, for 194381 and 194383.....
140102R	9666	Controller Cover Screw.....
194423	9667	Controller Lead complete, from controller to three-pin terminal.....
193908	9666	Controller Lead Clamp.....
194479	9666	" " " Insulation.
198169	9666	" Pitman Rod Connection for Stands Nos. 46909 and 46912
193828	9666	Controller Pitman Rod Connection for Stand No. 46913.....
192211	9665	Controller Resistance Unit for 32 to 55 volts.....
192140	9665	Controller Resistance Unit for 95 to 145 volts.....
192141	9665	Controller Resistance Unit for 150 to 250 volts.....
194774	9664	Controller Resistance Unit Adjusting Nut.....

No.	Plate	Name
194775	9664	Controller Resistance Unit Adjusting Nut Lock Spring.....
194416	9664	Controller Resistance Unit Bell Crank.....
194324	9666	Controller Resistance Unit Bell Crank Connecting Link.....
140101C	9666	Controller Resistance Unit Bell Crank Connecting Link Hinge Screw.....
1607J	9664	Controller Resistance Unit Bell Crank Connecting Link Hinge Screw Nut.....
51340C	9664	Controller Resistance Unit Bell Crank Hinge Screw.....
1607J	9664	Controller Resistance Unit Bell Crank Hinge Screw Nut.....
194421	9666	Controller Resistance Unit Bell Crank Spring.....
194402	22521	Controller Resistance Unit Bell Crank Spring Bracket.....
194422	-----	Controller Resistance Unit Bell Crank Spring Bracket 194402 with 51340C, 140101C, 194324, 194416, 194773 and two 1607J..
140100R	9664	Controller Resistance Unit Bell Crank Spring Bracket Screw....
194514	9664	Controller Resistance Unit Bell Crank Spring Bracket Screw Insulating Disc.....
140103R	9664	Controller Resistance Unit Screw.
931090	9664	" " " " " "
23258	9664	Washer (asbestos)..... Controller Resistance Unit Screw Washer (steel).....
194773	9664	Controller Resistance Unit Yoke..
792R	9666	" Screw.....
*899688	----	Name Plate for 194425.....
*899287	----	" " " 194426.....
964317	9664	" " Drive Screw.....

ELECTRICAL TRIMMINGS

No.	Plate	Name
192912	9667	Controller Lead Tube.....
192919	9666	" " " Clamp.....

SINGERLIGHTS

SINGERLIGHT No. 193294

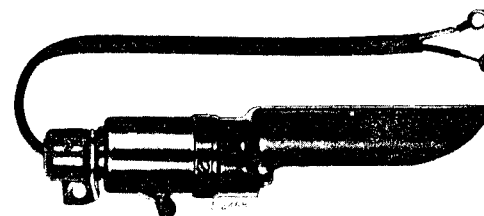

No.	Plate	Name
*193495	-----	Singerlight Bracket.....
193941	21456	" " " 193495 with 193942.....
*193254	21456	Singerlight Lamp Contact Lead Terminal.....
51203	21456	Singerlight Lamp Contact Lead Terminal Screw (brass).....
*193253	21456	Singerlight Lamp Contact Plunger.
*193251	21456	" " " " " "
		Bushing.....
*193252	21456	Singerlight Lamp Contact Plunger Spring.....
*193288	-----	Singerlight Lead.....
*194525	-----	" " Identification Tube (red).....
*194526	-----	Singerlight Lead Identification Tube (yellow).....
193829	21456	Singerlight Lead Strain Relief Disc.....
192954	-----	Singerlight Lead Terminal Clip Body.....
192955	-----	Singerlight Lead Terminal Clip Body Cap.....
50566	21456	Singerlight Lead Terminal Screw (brass).....
193289	21457	Singerlight Lead complete, Nos. 193288, 194525, 194526 and two each 192954 and 192955.....
193940	21456	Singerlight Nipple.....

SINGERLIGHTS

No.	Plate	Name
*193937	-----	Singerlight Nipple Cap with 193938.....
193936	21456	Singerlight Nipple Cap 193937 with 50564J.....
*193938	-----	Singerlight Nipple Cap Insert....
50564J	21456	" " " Set Screw.
193512	21456	" " Insulating Collar.....
51602R	21456	Singerlight Nipple Nut.....
701909	21456	" " " Insulating Washer (fibre).....
193509	21456	Singerlight Nipple Washer (felt).
193272	21457	" Shade.....
193421	-----	" " 193272 with 193401.....
193437	21456	Singerlight Shade Friction Washer
*193267	21456	" " Position Pin...
193401	21457	" " Reflector.....
*194596	-----	" Socket Body with 193255 and two 193251.....
*194594	-----	Singerlight Socket Body 194596 with 51226R, 193254, 193256 to 193258, 194597 and two each 51203, 193252, 193253 and 193267
*194593	-----	Singerlight Socket Body 194594 with 194305.....
194592	21457	Singerlight Socket and Switch complete, Nos. 193829, 193936, 194593, two 50566 and three 51385R.....
*193942	21456	Singerlight Steady Pin.....
*193259	21456	" Toggle Switch Contact
*194598	-----	" " " Frame..
51226R	21456	" " " Screw.....
*194599	-----	Singerlight Toggle Switch Operating Lever.....
*193265	21456	Singerlight Toggle Switch Operating Lever Hinge Pin.....
*194597	-----	Singerlight Toggle Switch complete. Nos. 193259, 193262, 193265, 193387, 193765, 194598 and 194599.....
*194304	21457	Singerlight Toggle Switch Shell..
*194305	-----	" " " " 194304 with 51602R, 193512 and 193940.....
51385R	21456	Singerlight Toggle Switch Shell Screw.....

SINGERLIGHTS

No.	Plate	Name
*193258	21456	Singerlight Toggle Switch Spring Contact (left).....
*193257	21456	Singerlight Toggle Switch Spring Contact (right).....
51203	21456	Singerlight Toggle Switch Spring Contact (right) Screw (brass).
*193256	21456	Singerlight Toggle Switch Spring Contact Lead Terminal.....
*193255	21456	Singerlight Toggle Switch Spring Contact Lead Terminal Stud....
*193387	21456	Singerlight Toggle Switch Toggle Lever.....
*193262	21456	Singerlight Toggle Switch Toggle Lever Spring.....
*193765	21456	Singerlight Toggle Switch Toggle Lever Spring Washer.....
*193294	-----	Singerlight (moulded, less lamp) complete, Nos. 691A, 97359, 193289, 193421, 193437, 193941, 194592, 701909 and two 193509.
691A	9658	Singerlight Screw.....
97359	21456	" " Retaining Washer (fibre).....Per 100

SINGER Needles should be used
in SINGER Machines.
These Needles and their Containers
are marked with the
Company's Trade-Mark "SIMANCO.***" 1

Needles in Containers marked
"FOR SINGER MACHINES"
are NOT **SINGER** made needles. 2

SINGERLIGHT No. 193518

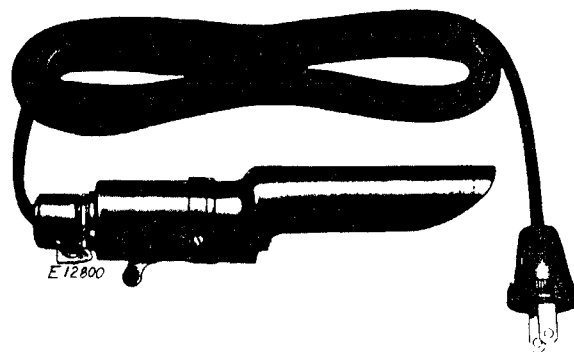

THIS SINGERLIGHT IS THE SAME AS NO. 193294,
WITH THE FOLLOWING EXCEPTIONS:

No.	Plate	Name
*193439	-----	Singerlight Lead Cord (8 ft. long) in place of 193288.....
194022	-----	Singerlight Lead Cord 193439 with 194518 in place of 193289.....
194518	21470	Singerlight Lead Cord Plug (rub- ber).....
193518	-----	Singerlight (moulded, less lamp) complete, Nos. 691A, 97359, 193421, 193437, 193941, 194022, 194592, 701909 and two 193509..

SINGERLIGHT LAMP

No.	Plate	Name
194120	21457	Singerlight Lamp.....

Note: When ordering No. 194120, state voltage
required.

OBSOLETE PARTS

No.	Plate	Name
8203	9667	Arm Rock Shaft with 122E.....
122E	9668	" " " Adjusting Screw...
32617	2933	" Shaft.....
286B	9668	" Side Cover Thumb Screw, use 51224B.....
120360	----	Attachment Set complete, Nos. 120290 and 120359, use 120607.
36594	9668	Binder, use 121464.....
287B	9668	Cloth Guide Thumb Screw, use 50053B.....
28521	----	Embroidery Attachment Driving Lever with 26536, use 120876..
28536	----	Embroidery Attachment Thread Bracket, obsolete, superseded by 120877, not interchangeable
8505	4376	Face Plate Thread Guard Rivet, use 125424.....Per 100
1136B	9668	Face Plate Thumb Screw, use 51224B
35996	9668	Hemmer (foot) 5/64 in. hem, use 120842.....
35857	----	Hemmer (foot) 1/8 in. hem, use 120842.....
28915	9661	Hemstitcher, use 120687.....
50390C	9668	Machine Hinge Connection Set Screw, use 51045C.....
930E	2934	Needle Bar Connecting Link Ad- justing Screw.....
1259C	2934	Needle Bar Crank Set Screw.....
32536	2936	Presser Bar Lifter.....
3100	2933	" " Spring.....
25979	9668	" Foot (double toe) for gathering, use 121441.....
36055	22528	Presser Foot with 665B and 36056, use 121614.....
36056	----	Presser Foot Braid Guide, obso- lete, superseded by 121615, not interchangeable.....
665B	2934	Presser Foot Braid Guide Screw, use 51282J.....
286B	9668	Presser Foot Thumb Screw, use 51224B.....
25515	9668	Quilter.....
120290	8313	Ruffler, for one and five stitch ruffling, use 120598.....
120334	----	Ruffler 120290 with 35960, use 121584.....

NUMERICAL LIST OF PARTS

No.	Plate	Name
42E	9658	Feed Regulator Hinge Screw.....
44C	22678	Oscillating Hook Pitman Screw Stud (left).....
50B	22685	Bobbin Winder Worm Wheel and Thread Guide Cam Screw Stud (eccentric) for 32629 and 32674.....
85E	2936	Presser Bar Lifter Screw.....
97E	2936	Tension Releasing Lever Hinge Screw.....
107B	9657	Face Plate Screw.....
122E	9668	Arm Rock Shaft Adjusting Screw for 8203, obsolete.....
126R	9666	Controller Bracket Screw for 194468.....
145R	9664	Three-Pin Terminal Body (male half) Screw.....
171A	9662	Tuck Folder Adjusting Screw for 36091.....
175J	9657	Feed Forked Connection Adjusting Screw for 32620.....
175J	9657	Oscillating Hook Pitman Adjusting Screw for 32531.....
190B	22684	Bobbin Winder Bracket Screw.....
183E	9660	Hand Attachment Body Bracket Screw for 94052.....
190B	9658	Corder Screw.....
190B	9658	Embroidery Attachment Screw for 35496.....
191C	9657	Feed Dog Screw.....
216C	22678	Oscillating Hook Pitman Screw Stud (right) Cap Screw.....
219E	2936	Slack Thread Regulator Screw....
226D	22678	Oscillating Hook Slide Friction Spring Screw.....
240J	4938	Embroidery Attachment Thread Re- taining Spring Screw for 26538
248A	9657	Clamp Stop Motion Clamp Stop Screw for 32619.....
253B	9658	Feed Regulating Thumb Screw.....
256B	9657	Clamp Stop Motion Clamp Screw for 32619.....
263B	9658	Pressure Regulating Thumb Screw..
286B	9668	Arm Side Cover Thumb Screw, obso- lete, use 51224B.....
286B	9668	Presser Foot Thumb Screw, obso- lete, use 51224B.....

NUMERICAL LIST OF PARTS

No.	Plate	Name
287B	9668	Cloth Guide Thumb Screw, obsolete, use 50053B.....
289B	4958	Braider Thumb Screw.....
301C	9657	Arm Rock Shaft Screw Center (lower) for 55516.....
307C	9658	Feed Rock Shaft Screw Center for 56814.....
315C	9657	Feed Bar Screw Center for 15445..
399A	9660	Hand Attachment Gear Cover Screw for 94052.....
400K	2936	Presser Bar Guide Bracket Adjusting Screw for 32535.....
443A	9657	Arm Shaft Bushing Set Screw.....
453C	2936	Presser Bar Guide Bracket Set Screw for 32535.....
453C	2936	Thread Take-up Spring Regulator Set Screw.....
468C	4938	Embroidery Attachment Looper Set Screw for 26528.....
552C	2934	Needle Clamp Thumb Screw for 2054
SS565E	9660	Hand Attachment Driver Finger Latch Screw Stud for 94052....
SS566C	9660	Hand Attachment Screw for 94052..
SS567E	9660	Hand Attachment Driver Finger Driving Pad and Plate Binding Screw for 94041.....
571C	22685	Bobbin Winder Spindle Worm for 32655.....
SS599F	9660	Hand Attachment Gear Screw Stud for 94052.....
SS600F	9660	Hand Attachment Pinion Screw Stud for 94052.....
649E	9657	Arm Screw.....
662D	22676	Oscillating Hook Bobbin Case Cushion Spring Screw for 32660
665J	2934	Needle Bar Thread Guard Screw for 66655.....
665B	2934	Presser Foot Braid Guide Screw for 36055, obsolete, use 51282J
665B	2934	Presser Foot Cord Guide Screw for 36058.....
691A	9658	Singerlight Screw for 193294 and 193518.....
691A	9658	Throat Plate Screw.....
792R	9666	Controller Screw.....
930E	2934	Needle Bar Connecting Link Adjusting Screw, obsolete.....
1036C	2936	Thread Take-up Crank Set Screw for 32517.....

NUMERICAL LIST OF PARTS

No.	Plate	Name
1085E	9658	Feed Forked Connection Roller Screw Stud for 1832.....
1130E	2934	Needle Bar Connecting Link Cap Screw for 32670.....
1131C	2936	Thread Take-up Lever Link Hinge Screw for 32671.....
1132C	22678	Oscillating Hook Connecting Link Hinge Screw.....
1133E	2934	Needle Bar Bushing Set Screw....
1134C	2934	" " Crank Position Screw for 32517.....
1136B	9668	Face Plate Thumb Screw, obsolete, use 51224B.....
1148C	9657	Clamp Stop Motion Flanged Bushing Set Screw for 32619.....
1172F	22678	Oscillating Hook Bobbin Case Tension Regulating Screw for 32590.....
1173D	22678	Oscillating Hook Bobbin Case Tension Spring Screw for 32590...
1216C	22678	Oscillating Hook Pitman Screw Stud (right) for 32682.....
1259C	2934	Needle Bar Crank Set Screw, obsolete.....
1274J	2936	Tension Screw Stud for 32654.....
1285C	9657	Feed Cam Set Screw for 32562.....
1301C	9658	" Raising Bar Hinge Screw....
1353C	2934	Needle Bar Connecting Stud Set Screw for 66559.....
1381C	9658	Feed Forked Connection Hinge Screw (eccentric).....
1422B	4936	Embroidery Attachment Spool Bracket Tension Regulating Thumb Screw for 35504.....
1483H	9662	Tuck Folder Thumb Screw for 36091
1485J	22678	Oscillating Hook Crank Clamping Screw for 32594.....
1508J	9657	Arm Rock Shaft Screw Center (lower) Nut for 55516.....
1513J	9658	Feed Rock Shaft Screw Center Nut for 56814.....
1519J	9657	Feed Bar Screw Center Nut for 15445.....
1520J	9658	Feed Forked Connection Hinge Screw Nut.....
1520J	9658	Oscillating Hook Pitman Screw Stud (right) Nut for 32682....
1528J	22685	Bobbin Winder Worm Wheel and Thread Guide Cam Screw Stud Nut for 32629 and 32674.....

NUMERICAL LIST OF PARTS

No.	Plate	Name
1549R	9666	Controller Bracket Screw Nut for 194468.....
1550TM	9666	Knee Lever Connecting Link Hinge Screw Nut for 194431.....
1560B	2936	Tension Regulating Thumb Nut for 32654.....
1607J	9664	Controller Resistance Unit Bell Crank Connecting Link Hinge Screw Nut for 194422.....
1607J	9664	Controller Resistance Unit Bell Crank Hinge Screw Nut for 194418 and 194422.....
1607J	9664	Controller Resistance Unit Yoke Hinge Screw Nut for 194418....
1611TM	9666	Knee Lever Hinge Screw Nut for 194436.....
1704B	9662	Tuck Folder Screw Stud Thumb Nut for 36091.....
1705B	9662	Tuck Folder Space Gauge Screw Stud Thumb Nut for 36091.....
1708J	9666	Knee Lever Extension Hinged Bracket Hinge Screw Nut for 194431.....
1768R	9664	Three-Pin Terminal (female half) Housing Screw Nut for 194521 and 194533.....
1832	9658	Feed Forked Connection Roller with 1085E.....
1944	4376	Feed Bar Roller and Stud for 32507.....
1944	4376	Feed Raising Bar Roller and Stud for 32510.....
2002	4376	Arm Dowel Pin.....
2007	4376	" Spool Pin.....
2020	4376	Clamp Stop Motion Clamp Washer for 32619.....
2054	2934	Needle Clamp with 552C.....
2070	2936	Presser Bar Spring Washer.....
2102	2936	Tension Disc for 32654.....
2749	22685	Bobbin Winder Worm Wheel and Thread Guide Cam Friction Washer for 32629 and 32674....
3100	2933	Presser Bar Spring, obsolete....
4604	2934	Corder Bow Rivet for 26399 Per 100.....
5480	9666	Knee Lever Extension Thumb Screw Friction Washer for 194430....
6267	9661	Hemmer Folder.....
8203	9667	Arm Rock Shaft with 122E,obsolete

NUMERICAL LIST OF PARTS

No.	Plate	Name
8204	9657	Arm Rock Shaft Center (upper)....
8216	4376	Feed Regulator.....
8217	4376	" " Friction Washer...
8238	2936	Tension Spring for 32654.....
8280	9660	Hand Attachment Crank Hinge Pin for 94052.....
8282	9660	Hand Attachment Crank Lever Lock Pin Spring for 94051.....
8422	2936	Thread Guard (head of arm).....
8505	4376	Face Plate Thread Guard Rivet, obsolete, use 125424...Per 100
8879	4376	Arm Spool Pin Washer (cloth)....
8879	4376	Spool Pin Washer (cloth) for 120359.....
9859	4938	Embroidery Attachment Thread Bracket Rivet for 120876 Per 100.....
12152	4937	Embroidery Attachment Body Block Rivet for 35496.....Per 100
12329	2936	Tension Releasing Lever Spring...
15072	22685	Bobbin Winder Bobbin Position Pin for 32550.....Per 100
15282	4950	Balance Wheel 2 1/4 in. pulley for 66-4 and 66-5 Machines....
15286	22685	Bobbin Winder Frame Spring for 32629 and 32674.....
15287	22685	Bobbin Winder Friction Ring (rubber) for 32629 and 32674.....
15288	22685	Bobbin Winder Pulley for 32655...
15291	22685	" " Stop Latch Spring for 32629 and 32674.....
15366	22685	Bobbin Winder Thread Guide Spring for 32629 and 32674.....
15376	22684	Bobbin Winder Adjusting Arm for 32629 and 32674.....
*15404	----	Trade Mark for 32616.....
15405	----	" " Rivet for 32616.....
15413	22684	Bobbin Winder Frame for 32655....
15416	22685	" " Worm Wheel and Thread Guide Cam for 32629 and 32674.....
15429	22528	Presser Foot (left toe) for stitching on edge and inserting braid.....
15445	----	Feed Bar Screw Center 315C with 1519J.....
19044	9662	Tuck Folder Screw Stud Cap Screw Spring Washer for 36091.....
21360	2934	Needle Bar Hole Plug.....

NUMERICAL LIST OF PARTS

No.	Plate	Name
32672	4951	Balance Wheel 3 1/4 in. pulley for 66-6 Machine.....
32673	9659	Bobbin Winder Bracket (belt cover) for 32674.....
32674	----	Bobbin Winder (automatic) complete for 66-6 Machine, Nos. 50B, 1528J, 2749, 15286, 15287, 15291, 15366, 15376, 15416, 32625, 32628, 32655, 32673, 50058B, 50059B, 50061B and 50230B.....
32675	9667	Presser Bar Spring.....
32676	9659	Arm Rock Shaft with 50571E, for 32682.....
32677	9659	Arm Shaft for 32678.....
32678	----	" " 32677 with 32679 and 32680, for 32681.....
32679	9657	Arm Shaft Slide Block (two pieces) for 32678.....
32680	9657	Arm Shaft Slide Block Retaining Clip for 32678.....
32681	----	Arm Shaft 32678 with 32503 and 32517.....
32682	----	Arm Rock Shaft 32676 with 1216C and 1520J.....
32683	9657	Arm Oil Tube for oiling 32679....
35018	9669	Tubular Trimming Attachment Strip Delivery Blade for 35985.....
35483	4937	Embroidery Attachment Body for 35496.....
35484	4937	Embroidery Attachment Body Block for 35496.....
35485	4937	Embroidery Attachment Driving Lever for 35496.....
35486	4937	Embroidery Attachment Driving Lever Arm (lower) for 35496....
35487	4937	Embroidery Attachment Driving Lever Arm (upper) for 35496....
35488	4937	Embroidery Attachment Driving Lever Arm Guide for 35496.....
35489	4937	Embroidery Attachment Driving Lever Arm Hinge Stud for 35496
35490	4937	Embroidery Attachment Driving Lever Arm Spring for 35496....
35491	4937	Embroidery Attachment Driving Lever Hinge Stud for 35496....
35492	4937	Embroidery Attachment Thread Carrier (left) for 35496.....
35493	4937	Embroidery Attachment Thread Carrier (left) Hinge Stud for 35496.....

NUMERICAL LIST OF PARTS

No.	Plate	Name
35494	4937	Embroidery Attachment Thread Carrier (right) for 35496.....
35495	4937	Embroidery Attachment Thread Carrier Friction Plate for 35496.....
35496	4937	Embroidery Attachment Nos. 190B, 12152, 35483 to 35489, 35490 to 35495, 35498, 50139B and two 35489, for 35505.....
35497	4936	Embroidery Attachment Spool Bracket for 35504.....
35498	4936	Embroidery Attachment Spool Bracket Stud for 35496.....
35499	4936	Embroidery Attachment Spool Bracket Tension Spring for 35504.....
35500	4936	Embroidery Attachment Spool Bracket Tension Spring Position Pin for 35504.....
35500	4936	Embroidery Attachment Spool Bracket Thread Guide Pin for 35504.....
35501	4936	Embroidery Attachment Spool Bracket Wire for 35504.....
35502	4936	Embroidery Attachment Spool Bracket Wire Hinge Stud for 35504.....
35503	4936	Embroidery Attachment Spool Bracket Wire Hinge Stud Washer for 35504.....
35504	4936	Embroidery Attachment Spool Bracket complete for 35505, Nos. 1422B, 35497, 35499, 35502, 35503 and two each 35500 and 35501.....
35505	----	Embroidery Attachment complete for two threads, Nos. 35496 and 35504.....
35857	----	Hemmer (foot) 1/8 in. hem, obsolete, use 120842.....
35884	9661	Hemmer (foot) 3/16 in. hem.....
35931	22684	Hemmer (adjustable) for 120359....
35932	22528	Quilter.....
35960	4383	Ruffler Shirring Plate for 120334 and 120601, obsolete, use 121170
35963	4383	Under Braider, obsolete, use 121547
35984	4958	Tubular Trimming Attachment Presser Foot (strip folding) with tube for 35985.....

NUMERICAL LIST OF PARTS

No.	Plate	Name
32543	2936	Thread Take-up Lever Hinge Stud for 32542.....
32544	2936	Thread Take-up Lever Link for 32542.....
32550	22685	Bobbin Winder Spindle with 15072, for 32655.....
32562	9657	Feed Cam with 1285C.....
32567	22678	Oscillating Hook Bobbin Case Tension Spring for 32590.....
32569	9659	Oscillating Hook Slide.....
32570	9658	" " " Friction Spring.....
32572	2936	Tension Releasing Disc for 32654.
32573	2936	" " Lever.....
32574	2936	" " Pin for 32654..
32575	2936	Thread Take-up Spring for 32654..
32576	2936	" " " Regulator for 32654.....
32578	2936	Thread Take-up Crank for 32670...
32581	2933	Feed Rock Shaft.....
32589	9663	" Cover Plate (oval top) for art work.....
32590	22676	Oscillating Hook Bobbin Case with 1172F, 1173D and 32567, for 32626.....
32594	22678	Oscillating Hook Crank with 1485J
32598	22678	" " Bobbin Case Position Bracket Oil Pad (felt) for 32660.....Per 100
32599	22678	Oscillating Hook Bobbin Case Position Bracket Oil Pad Holder for 32660.....
32600	2934	Feed Dog, 12 teeth (16 teeth to the inch) for 32602.....
32602	2934	Throat Plate for 32600.....
32604	2933	Bobbin Winder Bracket (belt cover) for 32629.....
*32616	----	Arm with 15404 and two 15405....
32617	2933	Arm Shaft, obsolete.....
32618	4376	Clamp Stop Motion Flanged Bushing for 32619.....
32619	----	Clamp Stop Motion complete, Nos. 248A, 256B, 1148C, 2020 and 32618
32620	2933	Feed Forked Connection with 175J.
32621	2936	Slack Thread Regulator.....
32622	9663	Feed Cover Plate (flat top) for art work.....
32625	22685	Bobbin Winder Stop Latch for 32629 and 32674.....

NUMERICAL LIST OF PARTS

No.	Plate	Name
32626	----	Oscillating Hook 32520 with 32590
32628	22685	Bobbin Winder Thread Guide for 32629 and 32674.....
32629	----	Bobbin Winder (automatic) complete for 66-4 and 66-5 Machine, Nos. 50B, 1528J, 2749, 15286, 15287, 15291, 15366, 15376, 15416, 32604, 32625, 32628, 32655, 50058B, 50059B, 50061B and 50230B.....
32630	9657	Face Plate Thread Guard with 125424, for 32506.....
32633	9659	Arm Side Cover (embossed).....
32654	----	Tension complete, Nos. 1274J, 1530B, 8238, 32572, 32574 to 32576 and two 2102.....
32655	----	Bobbin Winder Frame 15413 with 571C, 15288 and 32550, for 32629 and 32674.....
32656	22676	Oscillating Hook Bell Crank for 32657.....
32657	----	Oscillating Hook Bell Crank 32656 with 50561C.....
*32658	----	Bed.....
32659	22676	Oscillating Hook Bobbin Case Position Bracket for 32660.....
32660	----	Oscillating Hook Bobbin Case Position Bracket complete, Nos. 662D, 32528, 32598, 32599, 32659, 32661 to 32664, 50579D and 50580E.....
32661	22676	Oscillating Hook Bobbin Case Cushion Spring for 32660.....
32662	22678	Oscillating Hook Bobbin Case Position Bracket Hinge Stud for 32660.....
32663	22678	Oscillating Hook Bobbin Case Position Bracket Latch for 32660.....
32664	22678	Oscillating Hook Bobbin Ejector for 32660.....
32665	2933	Presser Bar.....
32666	2934	" Foot.....
*32667	9659	Face Plate for 32506.....
32668	2934	Needle Bar with 32519.....
32669	----	Needle Bar Connecting Link 32515 with 66559, for 32670.....
32670	----	Needle Bar Connecting Link 32669 with 1130E and 32578, for 32671
32671	----	Thread Take-up Lever 32542 with 1131C and 32670.....

NUMERICAL LIST OF PARTS

No.	Plate	Name
22232	4938	Embroidery Attachment Driving Lever Friction Washer for 26538.....
22232	4938	Embroidery Attachment Scroll Carrier Friction Washer for 26538.....
2325E	9664	Controller Resistance Unit Screw Washer (steel) for 194491 to 194493 and 194569 to 194571...
25510	4958	Braider.....
25515	9668	Quilter, obsolete.....
25525	4958	Bias Gauge.....
25527	22529	Cloth Guide for 120359.....
25537	9669	Screw Driver (machine) for 120359
25538	9663	" " (shuttle tension) obsolete, use 120378.....
*25789	1950	Corder Bow Tip for 26399.....
*25794	1950	Presser Foot for 26399.....
25888	9661	Hemmer Tongue.....
25895	9661	Hemmer (foot) 1/8 in. hem, for shirt work.....
25904	9661	Hemmer (foot) 1/16 in. hem, for silk ties.....
25979	9668	Presser Foot (double toe) for gathering, obsolete, use 121441
26075	9658	Thread Cutter and Holder.....
*26398	1950	Corder Bow for 26399.....
26399	1950	Corder (bow) complete for top cording, Nos. 4604, 25789, 25794 and 26395.....
26521	----	Embroidery Attachment Driving Lever with 26536, obsolete, use 120876.....
26523	4938	Embroidery Attachment Driving Lever Washer for 26538.....
26524	4938	Embroidery Attachment Frame with 26525, for 26538.....
26525	4938	Embroidery Attachment Frame Block for 26524.....
26527	4938	Embroidery Attachment Loper for 26538.....
26528	4938	Embroidery Attachment Scroll with 469C, for 26538.....
26529	4938	Embroidery Attachment Scroll Carrier with 26531, for 26538..
26530	4938	Embroidery Attachment Scroll Carrier Hinge Stud for 26538..
26531	4938	Embroidery Attachment Scroll Carrier Pin for 26529.....

NUMERICAL LIST OF PARTS

No.	Plate	Name
26532	4938	Embroidery Attachment Scroll Cover for 26538.....
26533	4938	Embroidery Attachment Scroll Driving Lever with 26534, for 26538.....
26534	4938	Embroidery Attachment Scroll Driving Lever Stud for 26533..
26535	4938	Embroidery Attachment Spool Pin for Arm of Machine for 26538..
26536	----	Embroidery Attachment Thread Bracket for 26521, obsolete, superseded by 120877, not interchangeable.....
26537	4938	Embroidery Attachment Thread Eyelet for 26538.....
26538	22526	Embroidery Attachment complete for one thread, Nos. 240J, 26523, 26524, 26527 to 26530, 26532, 26533, 26535, 26537, 26784, 26785, 120876 and two 22232.....
26784	4938	Embroidery Attachment Driving Lever Hinge Stud for 26538....
26785	4938	Embroidery Attachment Thread Retaining Spring for 26538.....
28831	9662	Presser Foot for darning.....
28915	9661	Hemstitcher, obsolete, use 120687
32503	4376	Arm Shaft Bushing for 32691.....
32506	----	Face Plate 32667 with 32630.....
32507	4376	Feed Bar with 1944.....
32510	4376	" Raising Bar with 1944.....
*32515	2934	Needle Bar Connecting Link with 51002E, for 32669.....
32517	2934	Needle Bar Crank with 10360 and 1134C, for 32681.....
32519	2934	Needle Stop Pin for 32669.....
32520	22676	Oscillating Hook for 32626.....
32522	22676	" " Bobbin.....
32522	22676	Bobbin (five) for 120359.....
32528	22678	Oscillating Hook Bobbin Ejector Spring for 32660.....
32529	22678	Oscillating Hook Connecting Link.
32531	2933	" " Pitman with two 175J.....
32535	2936	Presser Bar Guide Bracket with 400K and 453C.....
32536	2936	Presser Bar Lifter, obsolete....
32541	2936	Thread Take-up Lever for 32542...
32542	----	Thread Take-up Lever complete for 32671, Nos. 32541, 32543 and 32544.....

No.	Plate	Name
35985	----	Tubular Trimming Attachment complete for making 3/32 in., 1/8 in. and 5/32 in. trimmings, Nos. 35018, 35984 and 120824..
35996	9668	Hemmer (foot) 5/64 in. hem, obsolete, use 120842.....
36055	22528	Presser Foot with 665B and 36056, obsolete, use 121614.....
36056	-----	Presser Foot Braid Guide for 36055, obsolete, superseded by 121615, not interchangeable...
36058	22528	Presser Foot with 665B and 36059, for blind stitch cording to turn small curves.....
36059	-----	Presser Foot Cord Guide for 36058
36067	22528	" " for braiding, for art work, for braid 1/16 in. to 3/16 in. wide.....
36090	2928	Tuck Folder Arm with 50068E, for 36091.....
36091	2928	Tuck Folder complete for small pieces of goods, Nos. 171A, 1704B, 1705B, 19044, 36090, 50066E, 50067D, 202600, 202603, 225923, 225926 and two 1483H..
36092	9662	Tuck Folder Presser Foot.....
36333	----	Hemmer (foot) 1/16 in. hem, for chiffon and silk.....
36469	9661	Hemmer (foot) for chiffon and silk, slotted for lace.....
36569	9663	Oiler with 36571, for 36570.....
36570	----	" 36569, filled with oil (Accessories).....
36571	9663	Oiler Spout 1 3/4 in. long for 36569.....
36583	4942	Tucker for 120359.....
36594	9668	Binder, obsolete, use 121464.....
36807	9661	Oil Spout Washer (leather) Accessories.....
36835	9661	Feller (foot).....
36865	9661	Edge Stitcher.....
50053B	22684	Cloth Guide Thumb Screw for 120359.....
50058B	22684	Bobbin Winder Adjusting Arm Screw for 32629 and 32674.....
50059B	22684	Bobbin Winder Frame Hinge Screw for 32629 and 32674.....
50061B	22685	Bobbin Winder Thread Guide Hinge Screw for 32629 and 32674.....

No.	Plate	Name
50066E	-----	Tuck Folder Screw Stud for 36091.
50067D	9662	Tuck Folder Screw Stud Cap Screw for 36091.....
50068E	9662	Tuck Folder Space Gauge Screw Stud for 36090.....
50139B	4937	Embroidery Attachment Thread Carrier (right) Hinge Screw for 35496.....
50230B	22685	Bobbin Winder Stop Latch Hinge Screw for 32629 and 32674.....
50380C	9668	Machine Hinge Connection Set Screw, obsolete, use 51045C...
50561C	22676	Oscillating Hook Bell Crank Hinge Screw for 32657.....
50564J	21456	Singerlight Nipple Cap Set Screw for 193936.....
50566	21456	Singerlight Lead Terminal Screw (brass) for 194592.....
50571E	9657	Arm Rock Shaft Adjusting Screw for 32676.....
50579D	22678	Oscillating Hook Bobbin Case Position Bracket Latch Screw for 32660.....
50580E	22678	Oscillating Hook Bobbin Ejector Hinge Screw Stud for 32660....
50611J	22678	Oscillating Hook Bobbin Case Position Bracket Hinge Stud Set Screw.....
50632C	9664	Motor Bracket Screw for 193287...
510C2E	9658	Needle Bar Connecting Link Adjusting Screw for 32515.....
51045C	9658	Machine Hinge Connection Set Screw.....
51093R	9664	Three-Pin Terminal (female half) Housing Screw for 194521 and 194533.....
51104B	9658	Binder Screw for 121464.....
51119R	9666	Controller Bracket Clamp Screw for 198164.....
51119J	9666	Controller Bracket Screw.....
51203	21456	Singerlight Lamp Contact Lead Terminal Screw (brass) for 194594.....
51203	21456	Singerlight Toggle Switch Spring Contact (right) Screw (brass) for 194594.....
51206R	21466	End Cover Screw.....
51207C	9664	Pulley Set Screw.....
51208B	9664	Motor Screw for 193287.....

No.	Plate	Name
192641	9663	Motor Bracket for 193287.....
192692	9664	Three-Pin Terminal (female half) Insert Clamp for 194521 and 194533.....
192797	9663	Three-Pin Terminal Body (male half) complete with three each 51582 and 701719.....
192851	21470	Lead Cord complete with Three-Pin Terminal (female half) from lamp socket to three-pin terminal for knee or treadle control.....
192866	9666	Controller Pitman Rod Connection.
192912	9667	" Lead Tube (Electrical Trimmings).....
192918	9666	Controller Lead Tube Clamp (Electrical Trimmings).....
192947	----	Brush (carbon) for 150 to 250 volts.....
192954	----	Singerlight Lead Terminal Clip Body for 193289.....
192955	----	Singerlight Lead Terminal Clip Body Cap for 193289.....
193066	4950	Belt (moulded) for Spoked Balance Wheel No. 15292.....
193077	4951	Belt (moulded) for Disc Balance Wheel No. 32672.....
*193226	20160	End Cover (commutator end) for 194295.....
*193227	20160	End Cover (pulley end) for 194295
193228	21466	Brush Tube.....
193229	21466	Brush Cap.....
193230	21466	Armature Shaft Bearing Sleeve Cap (commutator end).....
193231	9664	Pulley (moulded).....
193236	21466	Fan.....
193238	21466	Brush Tube Terminal.....
193239	20160	Field Core Shield for 193285 and 193286.....
*193251	21456	Singerlight Lamp Contact Plunger Bushing for 194596.....
*193252	21456	Singerlight Lamp Contact Plunger Spring for 194594.....
*193253	21456	Singerlight Lamp Contact Plunger for 194594.....
*193254	21456	Singerlight Lamp Contact Lead Terminal for 194594.....
*193255	21456	Singerlight Toggle Switch Spring Contact Lead Terminal Stud for 194596.....

No.	Plate	Name
*193256	21456	Singerlight Toggle Switch Spring Contact Lead Terminal for 194594.....
*193257	21456	Singerlight Toggle Switch Spring Contact (right) for 194594....
*193258	21456	Singerlight Toggle Switch Spring Contact (left) for 194594.....
*193259	21456	Singerlight Toggle Switch Contact for 194597.....
*193262	21456	Singerlight Toggle Switch Toggle Lever Spring for 194597.....
*193265	21456	Singerlight Toggle Switch Operating Lever Hinge Pin for 194597
*193267	21456	Singerlight Shade Position Pin for 194594.....
193272	21457	Singerlight Shade for 193421.....
193285	----	Field Core Shield 193239 with 899380 and two 700792 for B.R. 7 Motor.....
193286	----	Field Core Shield 193239 with 899381 and two 700792 for all B.R. Motors except B.R.7 Motor
193287	----	Motor Bracket complete, Nos. 50632C, 51208B, 190058, 191417, 192641 and 701513.....
*193288	----	Singerlight Lead for 193289.....
193289	21457	Singerlight Lead complete for 193294, Nos. 193288, 194525, 194526 and two each 192954 and 192955.....
*193294	----	Singerlight (moulded, less lamp) complete, Nos. 691A, 97359, 193289, 193421, 193437, 193941, 194592, 701909 and two 193509..
193318	20160	Armature complete for B.R. 6 and B.R. 7 Motors.....
*193387	21456	Singerlight Toggle Switch Toggle Lever for 194597.....
193401	21457	Singerlight Shade Reflector for 193421.....
193421	----	Singerlight Shade 193272 with 193401 for 193294 and 193518..
193437	21456	Singerlight Shade Friction Washer for 193294 and 193518.....
193438	20160	Field Core complete.....
*193439	----	Singerlight Lead Cord (3 ft. long) for 194022.....
193440	----	Field Coil complete for B.R. 3 Motor.....

NUMERICAL LIST OF PARTS

No.	Plate	Name
120378	9669	Screw Driver (shuttle tension) for 120359.....
120565	9658	Binder Screw Washer for 121464...
120598	4942	Ruffler for one, six and twelve stitch ruffling for 120601, 120607 and 121584.....
120601	----	Ruffler 120598 with 35960, obsolete, use 121584.....
120607	----	Attachment Set complete, Nos. 120359 and 120598.....
120687	22526	Hemstitcher with yielding Presser Plate.....
120824	4958	Tubular Trimming Attachment Strip Wire for 35985.....
120842	22684	Hemmer (foot) 5/64 in. hem for 120359.....
120862	9663	Oil Can, 1 1/3 fluid oz. (filled with household oil). Accessories.....
120878	4938	Embroidery Attachment Driving Lever with 120877 and two 9859 for 26538.....
120877	4938	Embroidery Attachment Thread Bracket for 120876.....
121091	----	Darning Foot for 121094.....
121092	----	" " Shank for 121094....
121093	9658	" " Spring for 121094...
121094	22526	Darning Foot (spring) complete, Nos. 121091 to 121093.....
121170	9662	Ruffler Shirring Plate (universal) complete for 121584, Nos. 51395W, 121171, 121172 and two 121625.....
*121171	----	Ruffler Shirring Plate for 121170
*121172	----	" " " Blade for 121170.....
121441	22528	Presser Foot for gathering.....
121461	-----	Binder Folder for 121464.....
121463	-----	" Foot for 121464.....
121464	22526	Binder complete for 120359, Nos. 51104B, 120565, 121461 and 121463.....
121547	22529	Under Braider.....
121584	-----	Ruffler 120598 with 121170.....
121614	9662	Presser Foot with 51282J and 121615 for blind stitch braiding for soutache braid.....
121615	9662	Presser Foot Braid Guide for 121614.....
121625	----	Ruffler Shirring Plate Blade Rivet for 121170.....
125035	22528	Presser Foot (right toe) for stitching on edge and inserting braid.....

NUMERICAL LIST OF PARTS

No.	Plate	Name
125424	9657	Face Plate Thread Guard Rivet for 32630.....Per 100
136136	22520	Controller Holder with four wood screws 3/8 in. No. 4 Rd. Hd., for Bakelite Controllers, Nos. 194587 to 194589.....
140099R	9664	Controller Base Screw for 194583 to 194585 and 194587 to 194589
140100R	9664	Controller Resistance Unit Bell Crank Spring Bracket Screw for 194491 to 194493 and 194569 to 194571.....
140101C	9666	Controller Resistance Unit Bell Crank Connecting Link Hinge Screw for 194422.....
140102R	9666	Controller Cover Screw for 194381 to 194386.....
140103R	9664	Controller Resistance Unit Screw for 194491 to 194493 and 194569 to 194571.....
140105TM	9666	Knee Lever Connecting Link Hinge Screw for 194431.....
140106J	9666	Knee Lever Extension Hinged Bracket Hinge Screw for 194431
140107TM	9666	Knee Lever Hinge Screw for 194436
190058	9664	Motor Bracket Screw Retaining Washer (fibre) for 193287.....
190059	20160	Commutator complete.....
190083	21466	Brush Spring.....
190563	21466	Field Coil Retainer.....
190613	-----	Tube filled with Singer Motor Lubricant packed in carton.....
190782	21466	Brush (carbon) for 32 to 145 volts.....
191097	21466	Armature Thrust Washer (commutator end) fibre.....
191098	21466	Armature Thrust Washer (pulley end) peerless paper.....
191417	9664	Motor Bracket Screw Washer for 193287.....
192140	9665	Controller Resistance Unit for 95 to 145 volts for 194492 and 194570.....
192141	9665	Controller Resistance Unit for 150 to 250 volts for 194493 and 194571.....
192211	9665	Controller Resistance Unit for 32 to 55 volts for 194491 and 194569.....
192240	21466	Field Coil Tube (paper).....

NUMERICAL LIST OF PARTS

No.	Plate	Name
51224B	9657	Arm Side Cover Thumb Screw.....
51224B	9657	Face Plate Thumb Screw.....
51224TM	9657	Knee Lever Extension Thumb Screw for 194430.....
51224B	9657	Presser Foot Thumb Screw.....
51226R	21456	Singerlight Toggle Switch Frame Screw for 194594.....
51282J	9662	Presser Foot Braid Guide Screw for 121614.....
51340C	9664	Controller Resistance Unit Bell Crank Hinge Screw for 194418 and 194422.....
51340C	9664	Controller Resistance Unit Yoke Hinge Screw for 194418.....
51385R	21456	Singerlight Toggle Switch Shell Screw for 194592.....
51395W	9662	Ruffler Shirring Plate Thumb Screw for 121170.....
51582	9664	Three-Pin Terminal Body (male half) Post Thumb Nut for 192797.....
51602R	21456	Singerlight Nipple Nut for 194305
55516	-----	Arm Rock Shaft Screw Center (low- er) 301C with 1508J.....
56814	-----	Feed Rock Shaft Screw Center 307C with 1513J.....
66558	2934	Needle Bar Bushing for 66655.....
66559	2934	" " Connecting Stud with 1353C, for 32669.....
66561	2934	Needle Bar Timing Gauge.....
66564	9656	Presser Bar Lifter.....
66639	2934	Needle Bar Thread Guard for 66655
66655	----	" " Bushing 66558 with 665J and 66639.....
80028	9660	Hand Attachment Pinion Dowel Pin for 94052.....Per 100
94016	9663	Hand Attachment Gear Cover for 94052.....
94027	9669	Hand Attachment Body Bracket for 94052.....
94028	9669	Hand Attachment Crank Handle (wood) for 94034.....
94029	9660	Hand Attachment Crank Handle Spindle for 94034.....
94030	9660	Hand Attachment Crank Handle Spindle Flange (loose) for 94034.....
94031	9669	Hand Attachment Crank Lever for 94034.....

NUMERICAL LIST OF PARTS

No.	Plate	Name
94032	9660	Hand Attachment Crank Lever Lock Pin for 94051.....
94033	9660	Hand Attachment Crank Lever Lock Pin Head for 94051.....
94034	----	Hand Attachment Crank complete for 94052, Nos. 94028 to 94031
94036	9660	Hand Attachment Driver Finger for 94041.....
94037	9660	Hand Attachment Driver Finger Latch for 94052.....
94038	9660	Hand Attachment Driver Finger Latch Spring for 94052.....
94039	9660	Hand Attachment Driver Finger Driving Pad (rawhide) for 94041.....
94040	9660	Hand Attachment Driver Finger Driving Pad Plate for 94041...
94041	----	Hand Attachment Driver Finger 94036 with SS567E, 94039 and 94040, for 94052.....
94044	9660	Hand Attachment Driver Finger Hinge Pin for 94052.....
94046	9660	Hand Attachment Driver for 94052.
94048	9660	" " Pinion for 94052.
94050	9669	" " Body for 94052...
94051	9669	" " Gear with 8282, 94032 and 94033, for 94052....
94052	----	Hand Attachment complete for 66-5 Machine, Nos. SS565E, SS566C, SS599F, SS600F, 8280, 80028, 94016, 94027, 94034, 94037, 94038, 94041, 94044, 94046, 94048, 94050, 94051 and two each 183E and 399A.....
97359	21456	Singerlight Screw Retaining Wash- er (fibre) for 193294 and 193518.....Per 100
120290	8313	Ruffler for one and five stitch ruffling for 120334 and 120360, obsolete, use 120598.....
120329	----	Machine Cover (Accessories)....
120334	----	Ruffler 120290 with 35960, obso- lete, use 121584.....
120359	----	Attachment Set Nos. 8879, 25527, 25537, 35931, 36583, 50053B, 120378, 120842, 121464, five 32522 and six needles for 120360 and 120607.....
120360	----	Attachment Set complete, Nos. 120290 and 120359, obsolete, use 120607.....

NUMERICAL LIST OF PARTS

No.	Plate	Name
193443	-----	Field Coil complete for B.R. 5 Motor.....
193446	-----	Field Coil complete for B.R. 6 Motor.....
193449	-----	Field Coil complete for B.R. 7 Motor.....
193452	-----	Field Coil complete for B.R. 8 Motor.....
193455	-----	Field Coil complete for B.R. 9 Motor.....
193458	-----	Field Coil complete for B.R. 10 and B.R. 11 Motors.....
193461	-----	Field Coil complete for B.R. 12 Motor.....
193464	-----	Field Coil complete for B.R. 15 Motor.....
193467	-----	Field Coil complete for B.R. 87 Motor.....
193470	-----	Field Coil complete for B.R. 90 Motor.....
193473	-----	Field Coil complete for B.R. 92 Motor.....
193476	-----	Armature complete for B.R.3 Motor
193477	-----	" " " B.R.5 Motor
193478	-----	" " " B.R.8 Motor
193479	-----	" " " B.R.9 Motor
193480	-----	" " " B.R. 10 and B.R. 92 Motors.....
193481	-----	Armature complete for B.R 11 and B.R. 12 Motors.....
193482	-----	Armature complete for B.R. 15 Motor.....
193483	-----	Armature complete for B.R. 87 Motor.....
193484	-----	Armature complete for B.R. 90 Motor.....
*193495	-----	Singerlight Bracket for 193941...
193509	21456	Singerlight Nipple Washer (felt) for 193294 and 193518.....
193512	21456	Singerlight Nipple Insulating Collar for 194305.....
193518	-----	Singerlight (moulded, less lamp) complete, Nos. 691A, 97359, 193421, 193437, 193941, 194022, 194592, 701909 and two 193509..
*193765	21456	Singerlight Toggle Switch Toggle Lever Spring washer for 194597
193828	9666	Controller Pitman Rod Connection for Stand No. 46913.....

NUMERICAL LIST OF PARTS

No.	Plate	Name
193829	21456	Singerlight Lead Strain Relief Disc for 194592.....\$
193908	9666	Controller Lead Clamp for 194491 to 194493.....
193936	21456	Singerlight Nipple Cap 193937 with 50564J, for 194592.....
*193937	-----	Singerlight Nipple Cap with 193938, for 193936.....
*193938	-----	Singerlight Nipple Cap Insert for 193937.....
193940	21456	Singerlight Nipple for 194305....
193941	21456	Singerlight Bracket 193495 with 193942, for 193294 and 193518.
*193942	21456	Singerlight Steady Pin for 193941
194022	-----	Singerlight Lead Cord 193439 with 194518, for 193578.....
194120	21457	Singerlight Lamp.....
194295	-----	End Cover complete, Nos. 193226, 193227 and two each 194326, 194490 and 194494.....
*194304	21457	Singerlight Toggle Switch Shell for 194305.....
*194305	-----	Singerlight Toggle Switch Shell 194304 with 51602R, 193512 and 193940, for 194593.....
194321	22521	Controller Foot Pedal for 194583 to 194585 and 194587 to 194589
194322	9665	Controller Base for 194491 to 194493.....
194323	9665	Controller Cover for 194425, 194426 and 194454.....
194324	9666	Controller Resistance Unit Bell Crank Connecting Link for 194422.....
194326	21466	Armature Shaft Grease Wick Spring for 194295.....
194381	-----	Controller (bakelite) complete for Treadle Control for Stands Nos. 46909, 46912 and 46913 for 32 to 55 volts, A.C. or D.C. Motor, Nos. 194423, 194426, 194491 and two 140102R.....
194382	-----	Controller (bakelite) complete for Treadle Control for Stands, Nos. 46909, 46912 and 46913, for 95 to 145 volts, A.C. or D.C. Motor, Nos. 194423, 194425, 194492 and two 140102R.....

NUMERICAL LIST OF PARTS

No.	Plate	Name
194383	-----	Controller (bakelite) complete for Treadle Control for Stands, Nos. 46909, 46912 and 46913 for 150 to 250 volts, A.C. or D.C. Motor, Nos. 194423, 194426, 194493 and two 140102R.....
194384	-----	Controller (bakelite) complete for Treadle Control for Stands, Nos. 25281, 25282 and 25294, for 32 to 55 volts, A.C. or D.C. Motor, Nos. 194426, 194455, 194491 and two 140102R.....
194385	-----	Controller (bakelite) complete for Treadle Control for Stands, Nos. 25281, 25282 and 25294, for 95 to 145 volts, A.C. or D.C. Motor, Nos. 194454, 194455, 194492 and two 140102R.....
194386	-----	Controller (bakelite) complete for Treadle Control for Stands, Nos. 25281, 25282 and 25294, for 150 to 250 volts, A.C. or D.C. Motor, Nos. 194426, 194455, 194493 and two 140102R.....
194399	-----	Controller Bracket for 194468....
194402	22521	Controller Resistance Unit Bell Crank Spring Bracket for 194418 and 194422.....
194404	22521	Controller Resistance Unit Bell Crank Spring for 194569 to 194571.....
194407	22521	Controller Base Cushion (rubber) for 194583 to 194585 and 194587 to 194589.....
194416	9664	Controller Resistance Unit Bell Crank for 194418 and 194422...
194418	-----	Controller Resistance Unit Bell Crank Spring Bracket 194402 with 194416, 194773 and two each 1607J and 51340C, for 194569 to 194571.....
194421	9666	Controller Resistance Unit Bell Crank Spring for 194491 to 194493.....
194422	----	Controller Resistance Unit Bell Crank Spring Bracket 194402 with 51340C, 140101C, 194324, 194416, 194773 and two 1607J, for 194491 to 194493.....

NUMERICAL LIST OF PARTS

No.	Plate	Name
194423	9667	Controller Lead complete, from controller to three-pin terminal, for 194381 to 194383.....
194425	----	Controller Cover 194323 with 899608 and two 964317, for 194382.....
194426	----	Controller Cover 194323 with 899287 and two 964317, for 194391, 194383, 194384 and 194386.....
194430	----	Knee Lever with Controller Operating Unit complete, for Sets Nos. 40, 47, 50, 401 and 402, Nos. 5480, 51224TM, 194431, 194436 and four wood screws 5/8 in. No. 6 Rd. Hd.....
194431	----	Knee Lever Extension Hinged Bracket Frame 194551 with 1550TM, 1708J, 140105TM, 140106J, 194434, 194549 and 194550, for 194430.....
194434	9666	Knee Lever Extension Hinged Bracket Spring for 194431.....
194436	----	Knee Lever 194437 with 1611TM, 140107TM, 194438, 194470 and 194545, for 194430.....
194437	22520	Knee Lever for 194436.....
194438	22520	Knee Lever Extension for 194436..
194454	-----	Controller Cover 194323 with 899691 and two 964317, for 194385.....
194455	-----	Controller Lead complete for 194384 to 194386.....
194468	-----	Controller Bracket 194399 with 126R and 1549R, for Stand No. 46913.....
194470	9666	Knee Lever Hinge Screw Washer for 194436.....
194479	9666	Controller Lead Clamp Insulation for 194491 to 194493.....
194490	21466	Armature Shaft Grease Cup Wick (felt) for 194295.....
194491	-----	Controller Base 194322 with 23258, 192211, 193908, 194422, 194479, 194774, 194775, two each 140100R, 140103R, 194421, 194514 and 931090, for 194381 and 194384.....

No.	Plate	Name
194492	-----	Controller Base 194322 with 23258, 192140, 193908, 194422, 194479, 194774, 194775, two each 140100R, 140103R, 194421, 194514 and 931090, for 194382 and 194385.....
194493	-----	Controller Base 194322 with 23258, 192141, 193908, 194422, 194479, 194774, 194775, two each 140100R, 140103R, 194421, 194514 and 931090, for 194383 and 194386.....
194494	21466	Armature Shaft Grease Cup Body for 194295.....
194514	9664	Controller Resistance Unit Bell Crank Spring Bracket Screw Insulating Disc for 194491 to 194493 and 194569 to 194571...
194518	21470	Singerlight Lead Cord Plug (rubber) for 194022.....
194521	21470	Three-Pin Terminal (female half) complete for 194574, Nos. two each 1768R, 51093R and three 192692.....
*194525	-----	Singerlight Lead Identification Tube (red) for 193289.....
*194526	-----	Singerlight Lead Identification Tube (yellow) for 193289.....
194533	21470	Three-Pin Terminal (female half) complete for 192851 with two each 1768R, 51093R and three 192692.....
194545	9666	Knee Lever Hinge Screw Friction Washer for 194436.....
194549	22521	Knee Lever Connecting Link for 194431.....
194550	22520	Knee Lever Extension Hinged Bracket for 194431.....
194551	22520	Knee Lever Extension Hinged Bracket Frame for 194431.....
194569	-----	Controller Base 194572 with 192211, 194418, 194774, 194775 and two each 23258, 140100R, 140103R, 194404, 194514 and 931090, for 194583 and 194587.
194570	-----	Controller Base 194572 with 192140, 194418, 194774, 194775 and two each 23258, 140100R, 140103R, 194404, 194514 and 931090, for 194584 and 194588.

No.	Plate	Name
194571	-----	Controller Base 194572 with 192141, 194418, 194774, 194775 and two each 23258, 140100R, 140103R, 194404, 194514 and 931090, for 194585 and 194589.
194572	21470	Controller Base for 194569 to 194571.....
194573	21470	Controller Cover for 194583 to 194585 and 194537 to 194589...
194574	21470	Controller Lead Cord complete with Three-Pin Terminal (female half) from lamp socket to three-pin terminal and controller for 194583 to 194585..
194579	21470	Controller Lead complete for 194587 to 194589.....
194583	-----	Controller (bakelite) complete, for Foot Control, for 32 to 55 volts, A.C. or D.C. Motor, Nos. 194321, 194569, 194573, 194574, 899287, two 964317 and four each 140099R and 194407.....
194584	-----	Controller (bakelite) complete, for Foot Control, for 95 to 145 volts, A.C. or D.C. Motor, Nos. 194321, 194570, 194573, 194574, 899815, two 964317 and four each 140099R and 194407..
194585	-----	Controller (bakelite) complete, for Foot Control, for 150 to 250 volts, A.C. or D.C. Motor, Nos. 194321, 194571, 194573, 194574, 899287, two 964317 and four each 140099R and 194407..
194587	-----	Controller (bakelite) complete, convertible for Foot or Knee Control for Sets Nos. 40, 47, 50, 401 and 402 for 32 to 55 volts, A.C. or D.C. Motor, Nos. 194321, 194569, 194573, 194579, 899287, two 964317 and four each 140099R and 194407.....
194588	-----	Controller (bakelite) complete, convertible for Foot or Knee Control for Sets Nos. 40, 47, 50, 401 and 402 for 95 to 145 volts, A.C. or D.C. Motor, Nos. 194321, 194570, 194573, 194579, 899816, two 964317 and four each 140099R and 194407.....

NUMERICAL LIST OF PARTS

No.	Plate	Name
194589	-----	Controller (bakelite) complete, convertible for Foot or Knee Control for Sets Nos. 40, 47, 50, 401 and 402 for 150 to 250 volts, A.C. or D.C. Motor, Nos. 194321, 194571, 194573, 194579, 899287, two 964317 and four each 140099R and 194407..
194592	21457	Singerlight Socket and Switch complete, for 193294 and 193518, Nos. 193829, 193936, 194593, two 50566 and three 51385R.....
*194593	-----	Singerlight Socket Body 194594 with 194305, for 194592.....
*194594	-----	Singerlight Socket Body 194596 with 51226R, 193254, 193256 to 193258, 194597 and two each 51203, 193252, 193253 and 193267, for 194593.....
*194596	-----	Singerlight Socket Body with 193255 and two 193251, for 194594.....
194597	-----	Singerlight Toggle Switch complete, for 194594, Nos. 193259, 193262, 193265, 193387, 193765, 194598 and 194599.....
*194598	-----	Singerlight Toggle Switch Frame for 194597.....
*194599	-----	Singerlight Toggle Switch Operating Lever for 194597.....
194635	-----	Armature complete for B.R. 14 Motor.....
194636	-----	Field Coil complete for B.R. 14 Motor.....
194773	9664	Controller Resistance Unit Yoke for 194418 and 194422.....
194774	9664	Controller Resistance Unit Adjusting Nut for 194991 to 194493 and 194569 to 194571...
194775	9664	Controller Resistance Unit Adjusting Nut Lock Spring for 194491 to 194493 and 194569 to 194571.....
198001	9667	Controller Bracket for Cabinet Tables.....
198002	-----	Controller Bracket for Cover Sets
198162	9667	" " " 198164....
198163	9667	" " Clamp for 198164

NUMERICAL LIST OF PARTS

No.	Plate	Name
198164	-----	Controller Bracket 198162 with 198163 and three 51119R, for Stands, Nos. 46909 and 46912..
198169	9666	Controller Pitman Rod Connection for Stands, Nos. 46909 and 46912.....
202600	9662	Tuck Folder Screw Stud Thumb Nut Washer for 36091.....
202603	9662	Tuck Folder Space Gauge Screw Stud Thumb Nut Washer for 36091.....
225923	2928	Tuck Folder for 36091.....
225926	2928	" " Space Gauge for 36091
700792	9664	Name Plate Rivet for 193285 and 193286.....
701400	21466	Armature Thrust Washer (pulley end) fibre.....
701513	9664	Motor Screw Retaining Washer (fibre) for 193287.....
701719	9664	Three-Pin Terminal Body (male half) Post Washer for 192797..
701909	21456	Singerlight Nipple Nut Insulating Washer (fibre) for 193294 and 193513.....
*899287	-----	Name Plate for 194426, 194583, 194585, 194587 and 194589.....
*899380	-----	Name Plate for B.R. 7 Motor for 193285.....
899381	-----	Name Plate for all B.R. Motors except B.R. 7 Motor for 193286
*899688	-----	Name Plate for 194425.....
*899691	-----	" " " 194454.....
*899815	-----	" " " 194584.....
*899816	-----	" " " 194589.....
931090	9664	Controller Resistance Unit Screw Washer (asbestos) for 194491 to 194493 and 194569 to 194571
964317	9664	Name Plate Drive Screw for 194425, 194426, 194454, 194583 to 194585 and 194587 to 194589.....

SINGER Needles should be used
in SINGER Machines.
These Needles and their Containers
are marked with the
Company's Trade-Mark "SIMANCO.**" 1

Needles in Containers marked
"FOR SINGER MACHINES"
are NOT **SINGER** made needles. 2

ILLUSTRATIONS

OF

PARTS

PLATE 1950—FULL SIZE

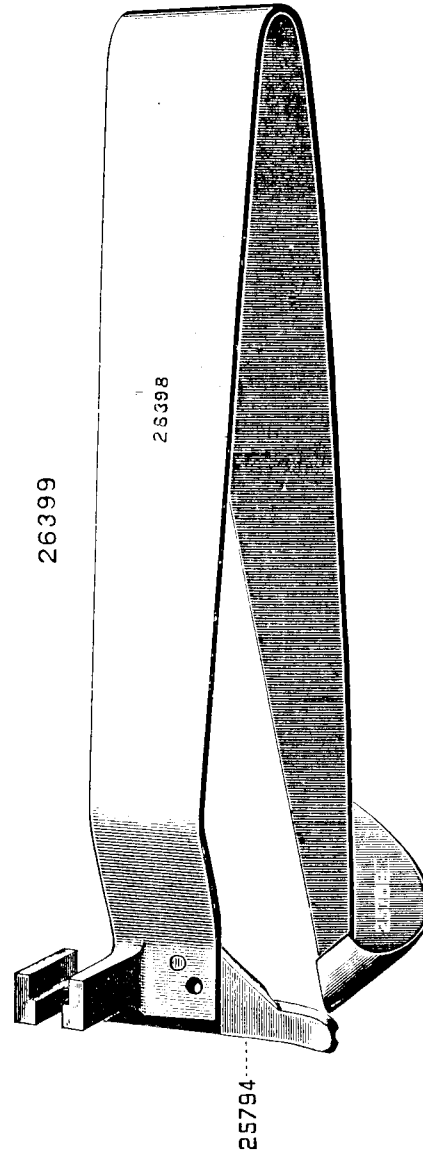

2928—ONE-HALF SIZE

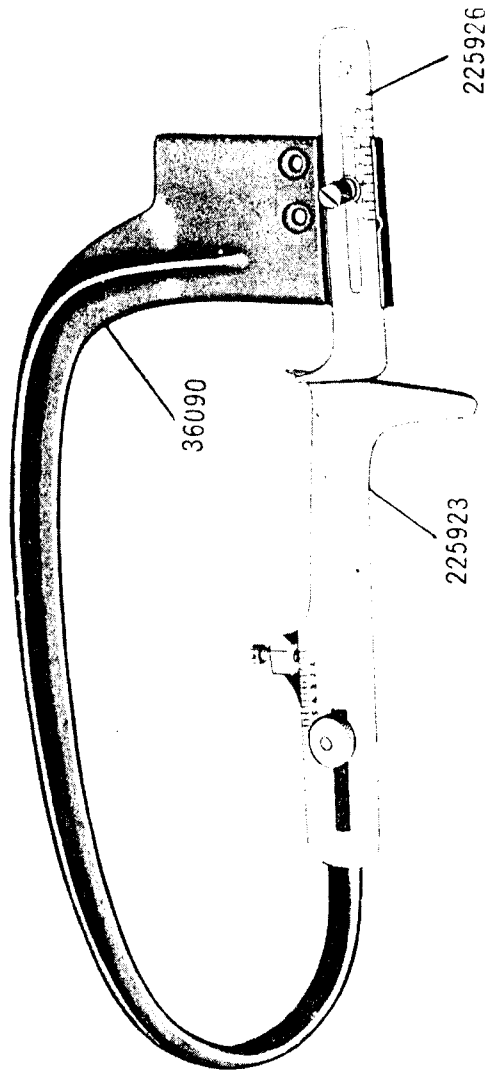

PLATE 2933—ONE-HALF SIZE

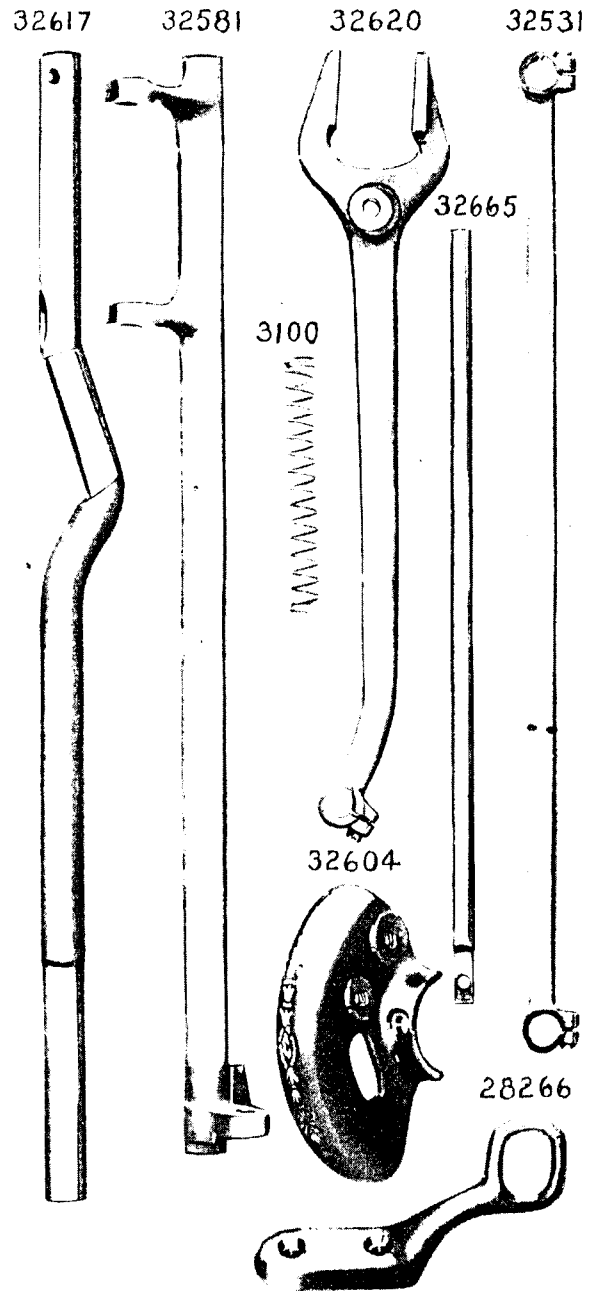

PLATE 2934—FULL SIZE

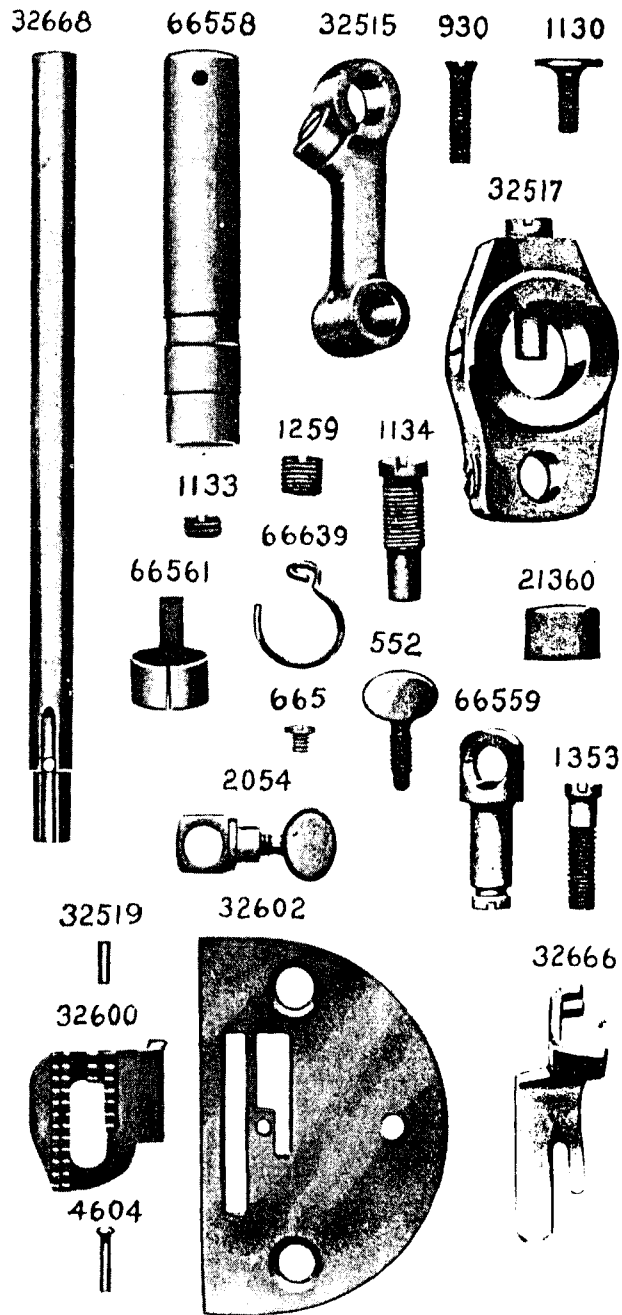

PLATE 2936—FULL SIZE

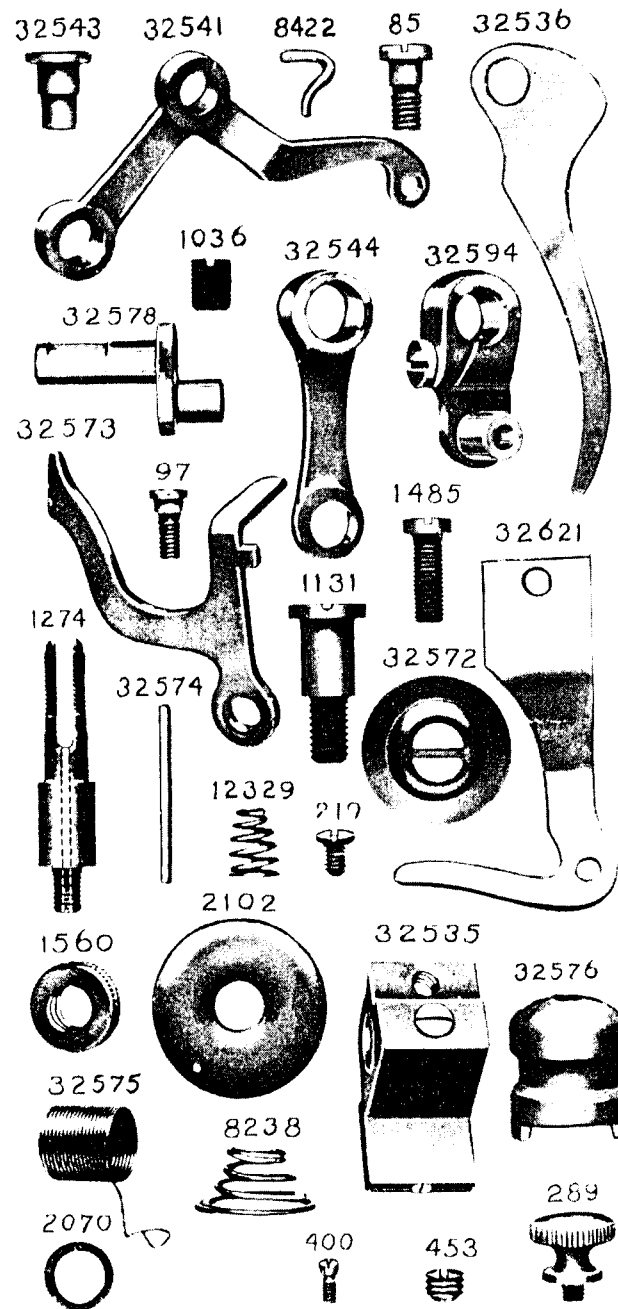

PLATE 4376—FULL SIZE

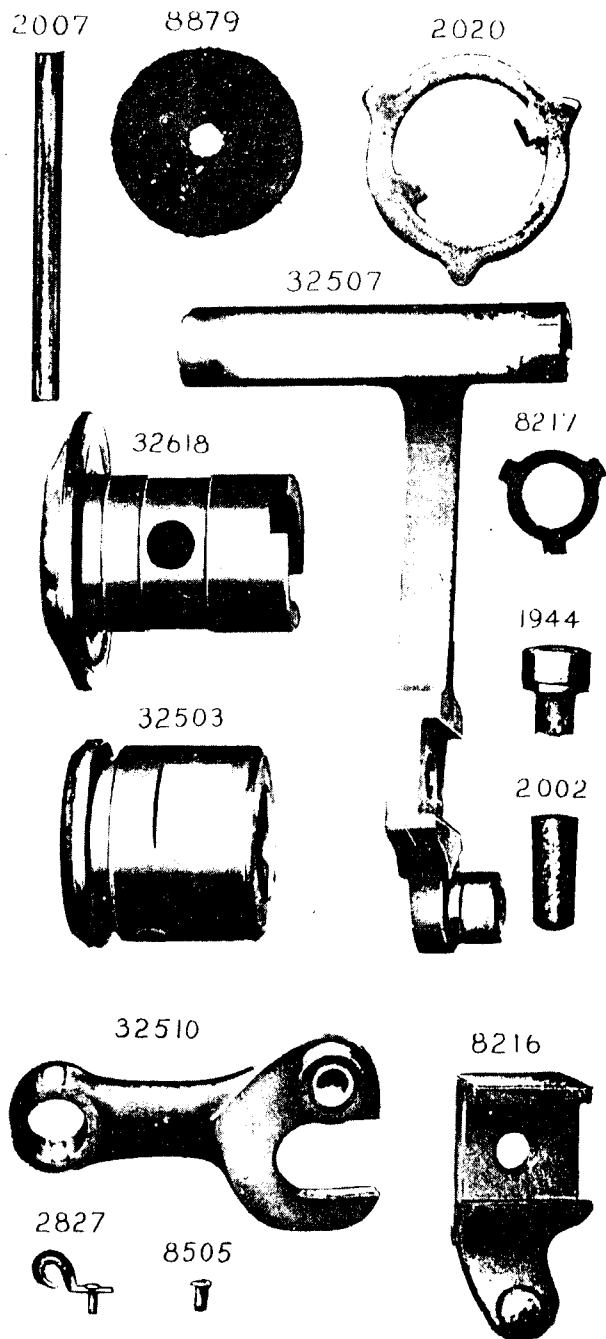

PLATE 4383—FULL SIZE

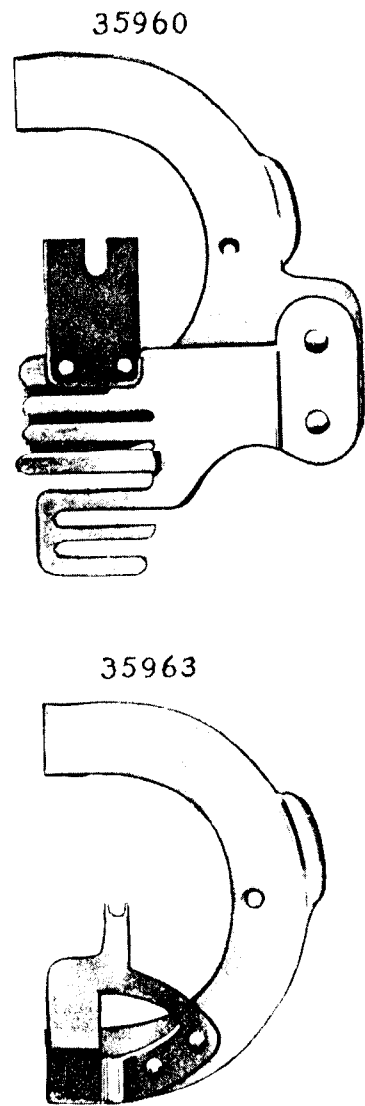

PLATE 4936 - FULL SIZE

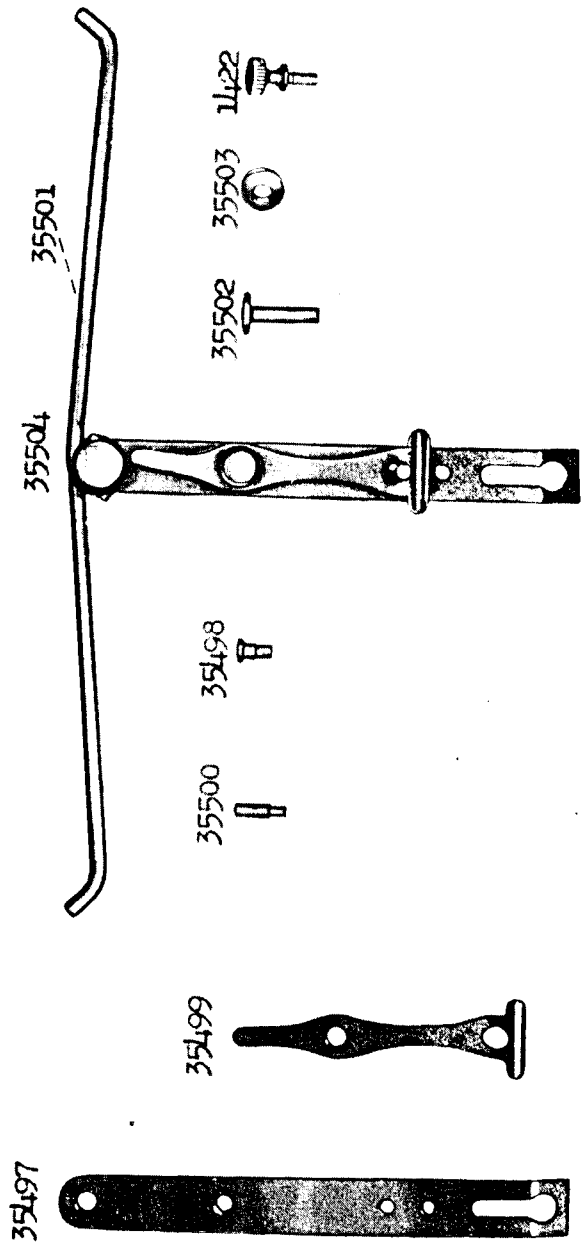

PLATE 4937 - FULL SIZE

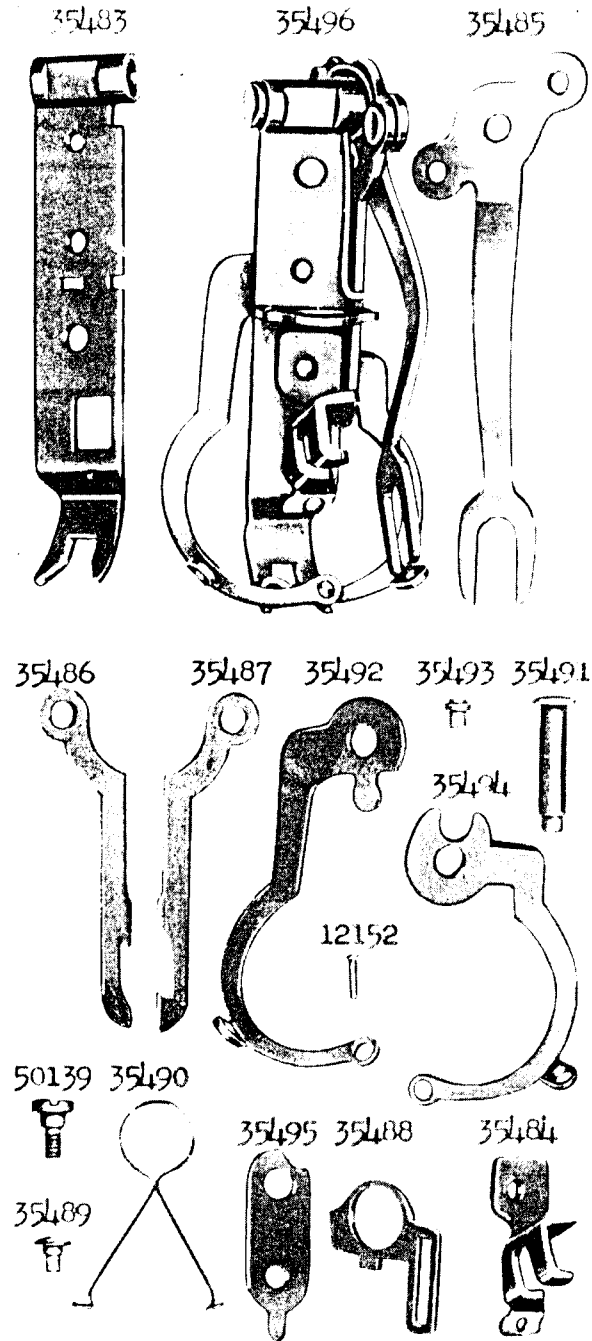

PLATE 4938 - FULL SIZE

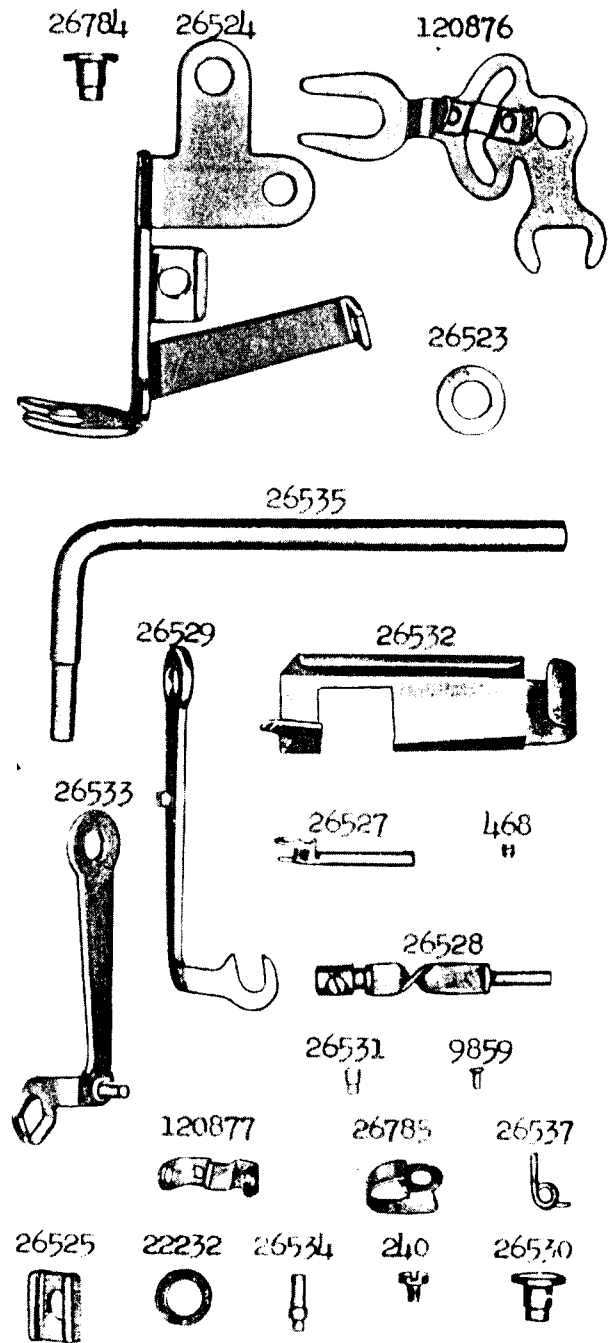

PLATE 4942 - FULL SIZE

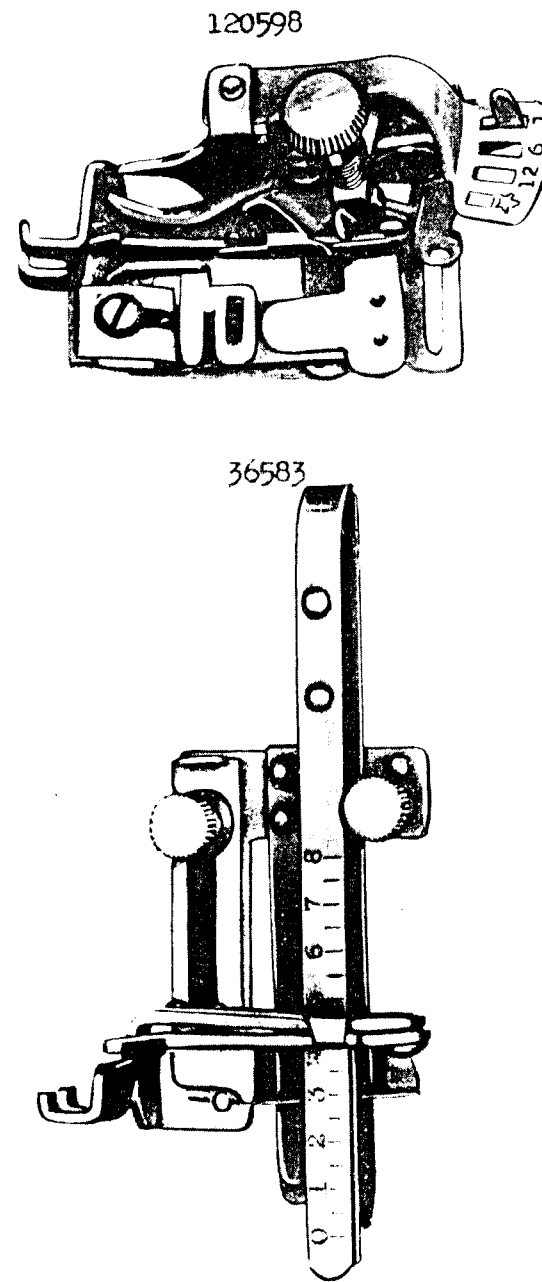
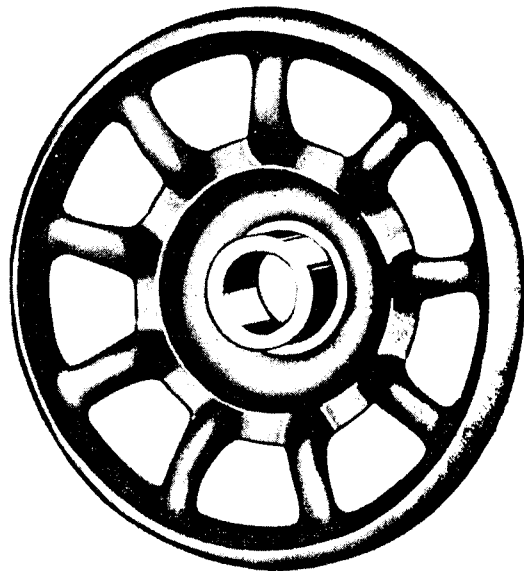

PLATE 4950—ONE-HALF SIZE

15282



193066

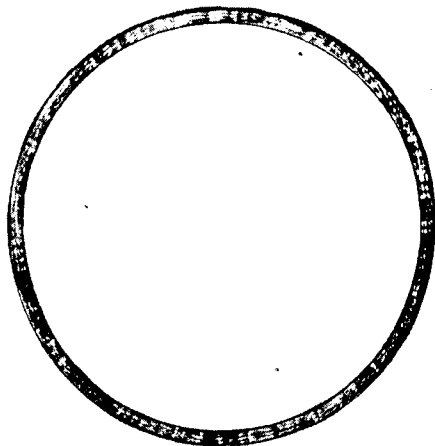
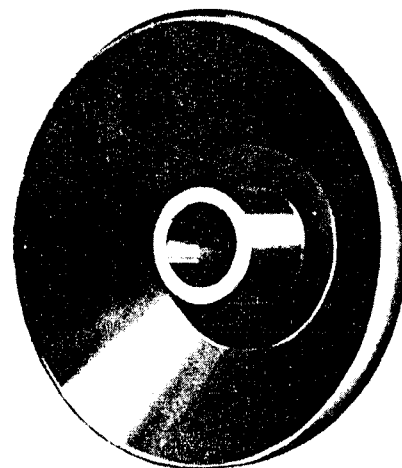

PLATE 4951—ONE-HALF SIZE

32672



193077

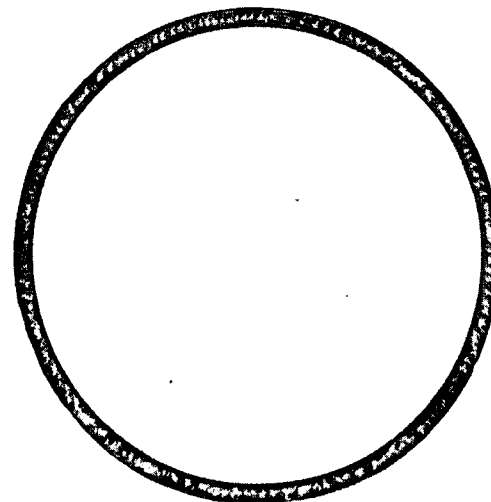
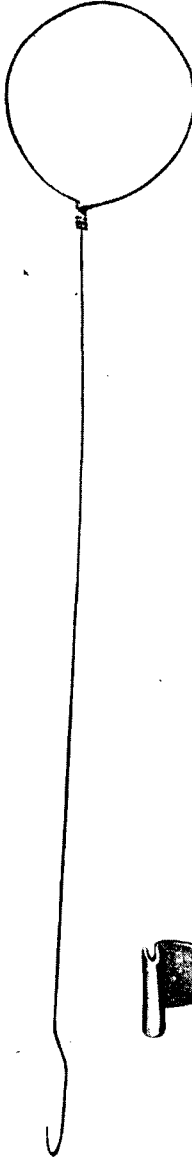
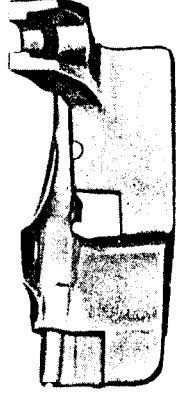

PLATE 4958 - FULL SIZE

120824



35984



25510



289



25525



PLATE 8313 - FULL SIZE

120290

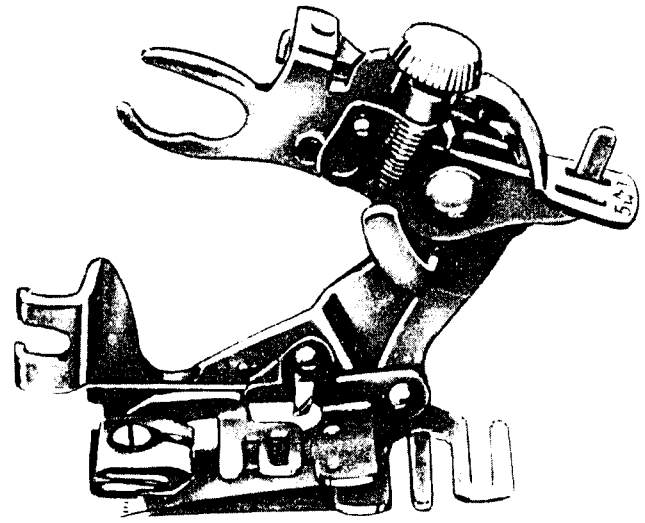

120598

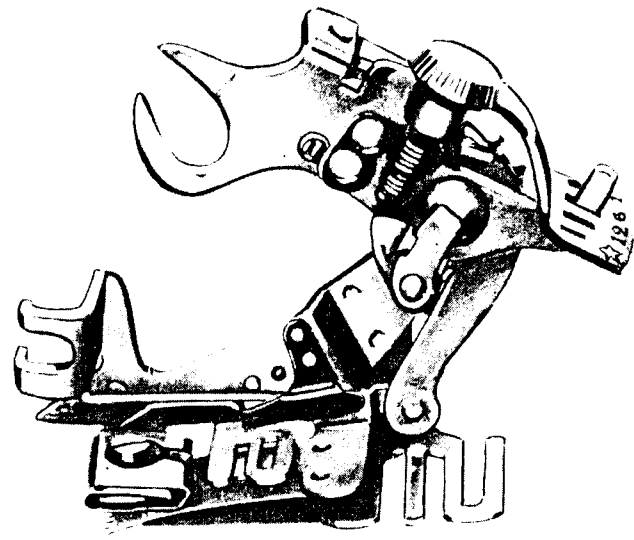

PLATE 9657 - FULL SIZE

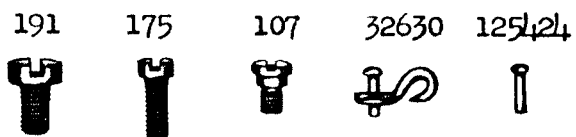
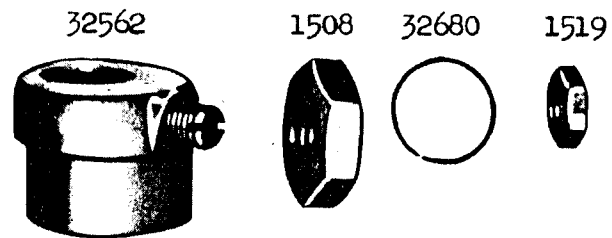
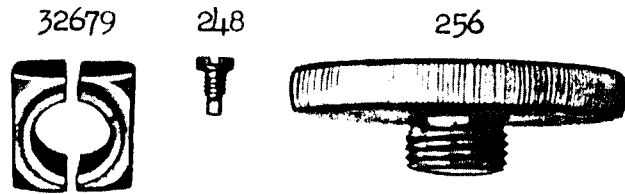
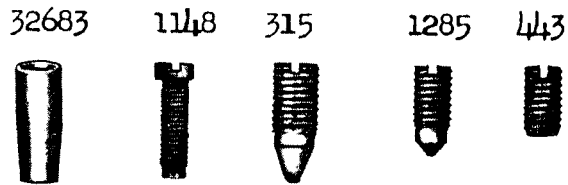
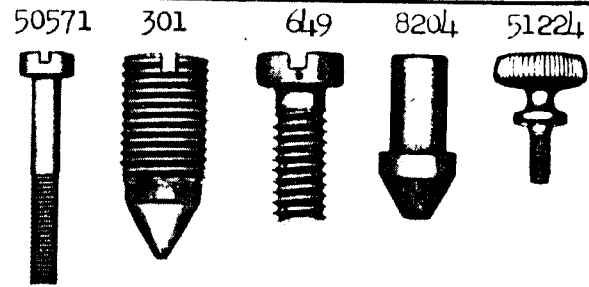

PLATE 9658 - FULL SIZE

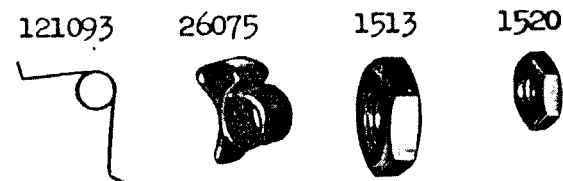
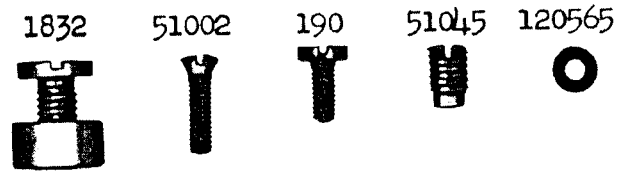
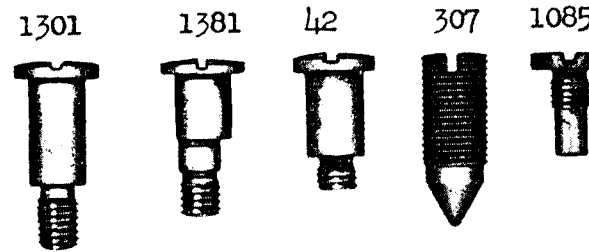
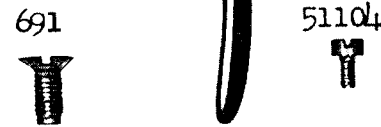
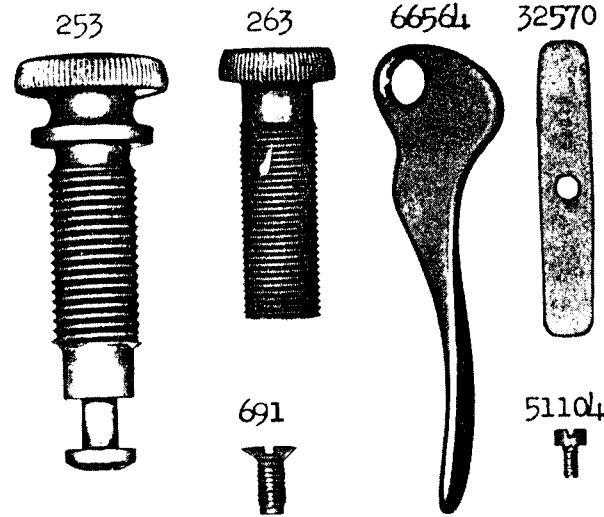

PLATE 9659 - ONE-HALF SIZE

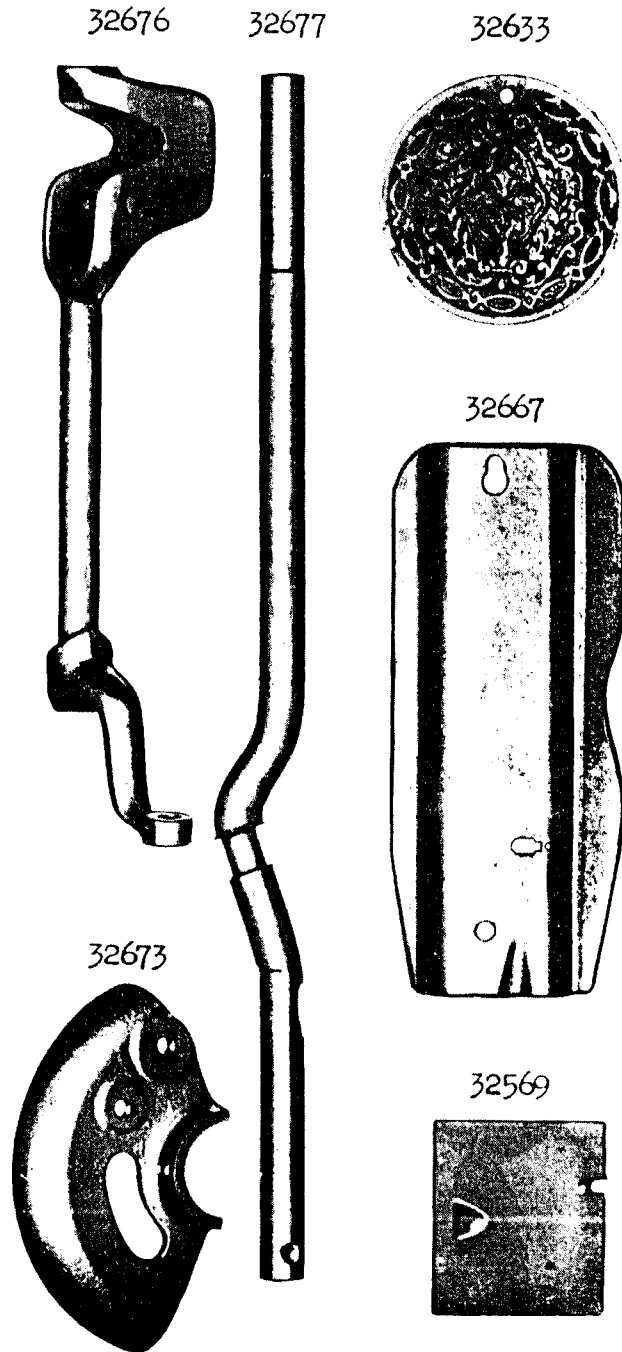

PLATE 9660 - FULL SIZE

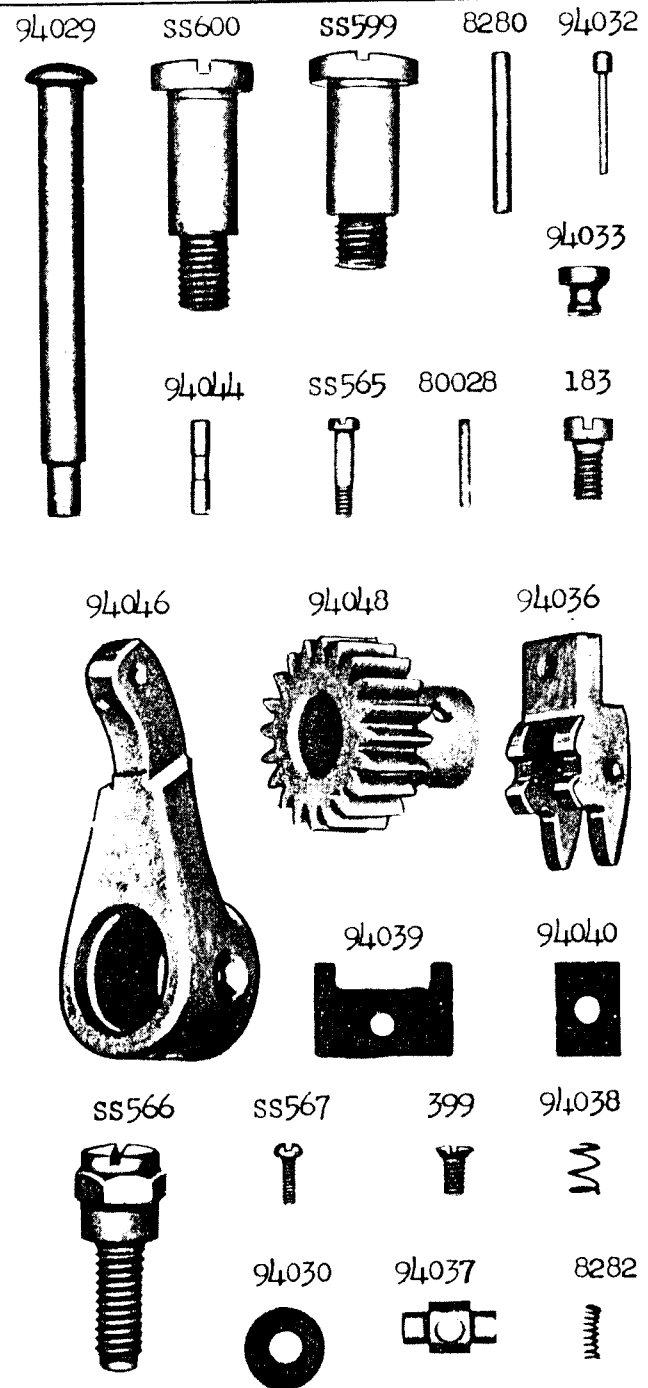
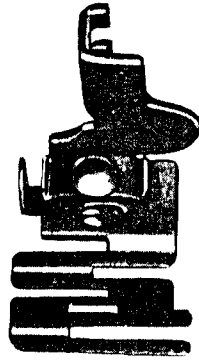

PLATE 9661 - FULL SIZE

25904



36865



36835



25895



35884



36469



36807



6267



25888



28915

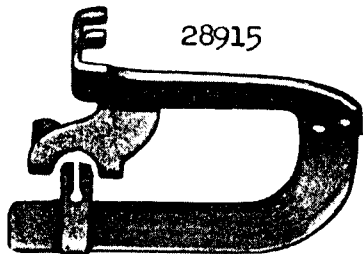

PLATE 9662 - FULL SIZE

36092



28831



121614 51282



W

121615

121170

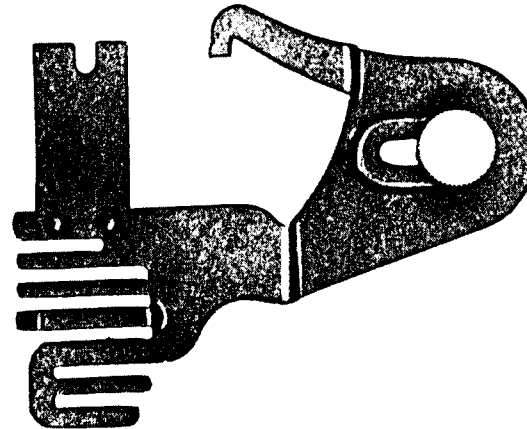

1483



171



51395



50067



50068



1704



1705



19044



202600



202603



PLATE 9663 - ONE-HALF SIZE

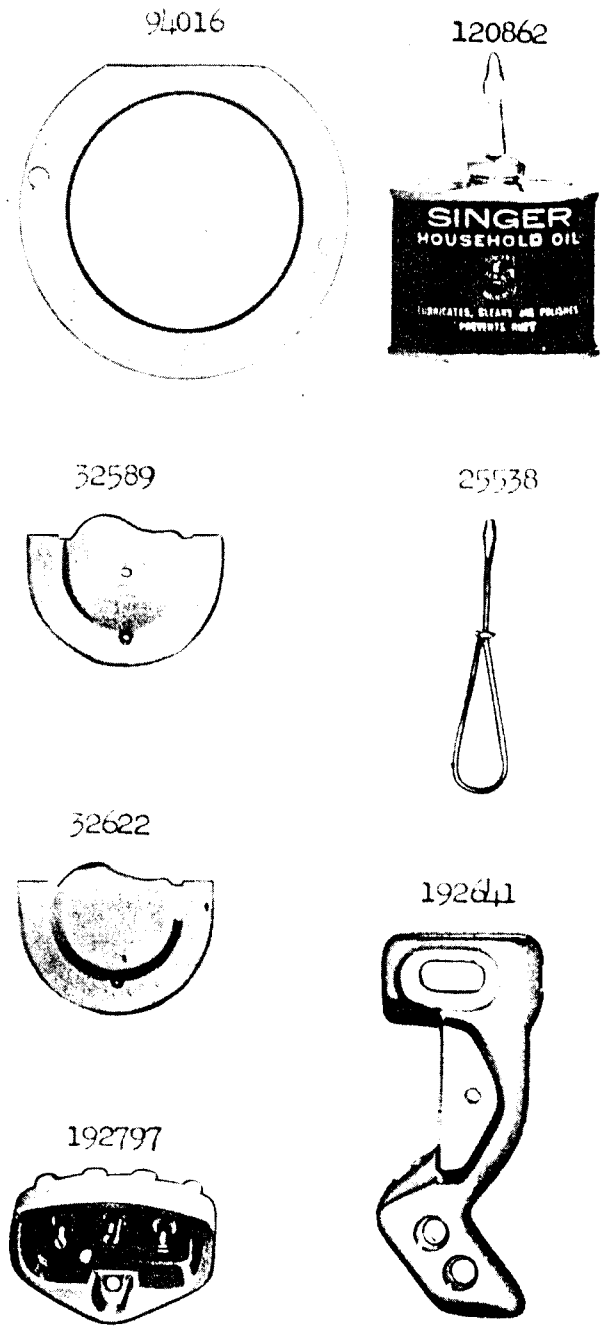

PLATE 9664 - FULL SIZE

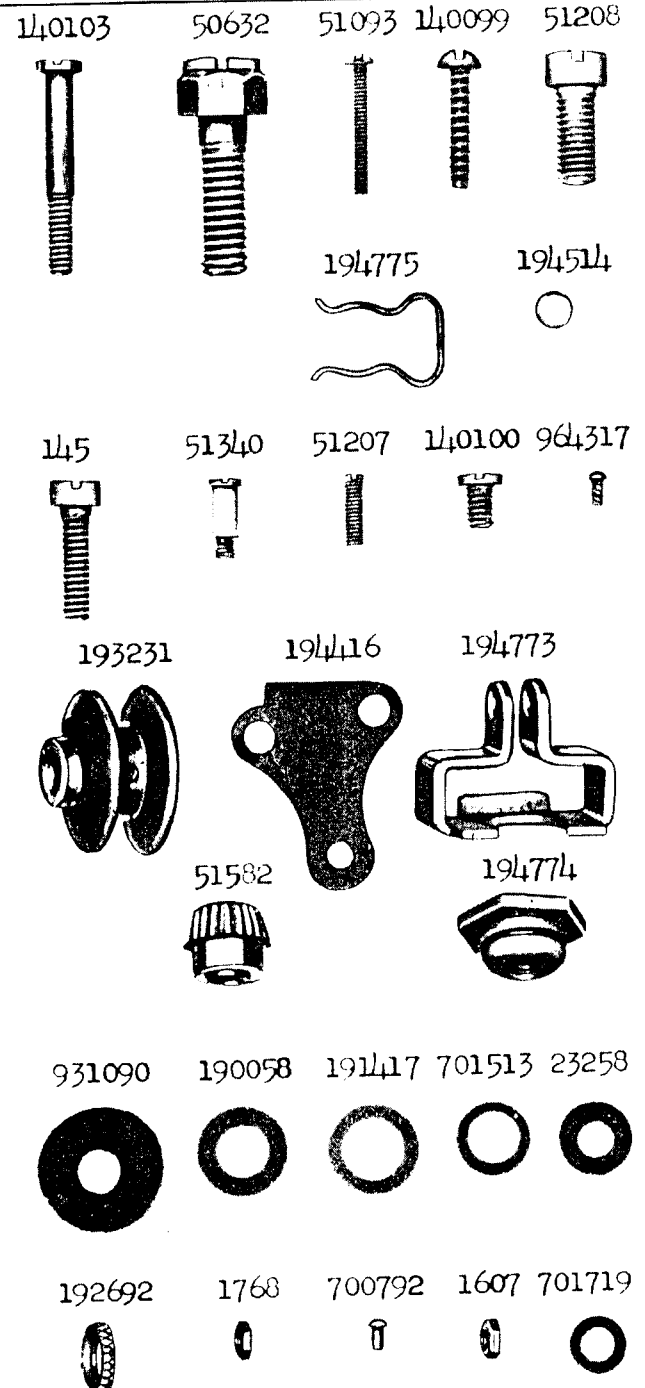
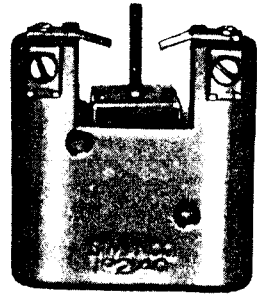
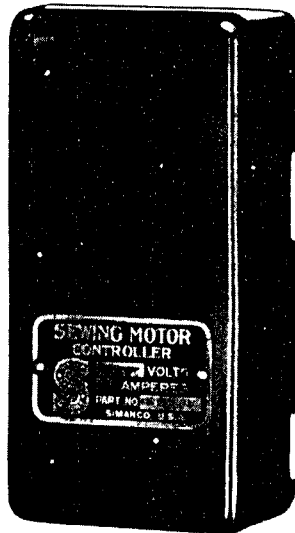

PLATE 9665 - ONE-HALF SIZE

- 192211 - 32 to 55 volts - Green
- 192140 - 95 to 145 volts - White
- 192141 - 150 to 250 volts - Blue



194323



194322

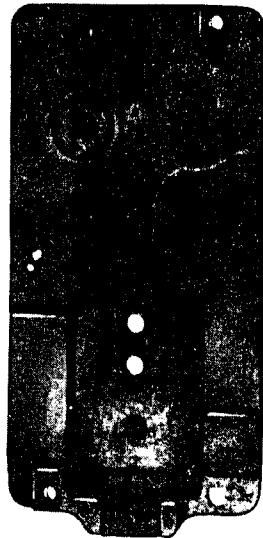
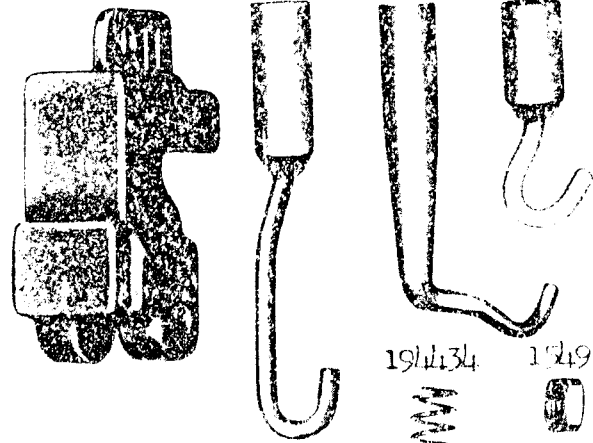

PLATE 9666 - FULL SIZE

- 194324
- 192366
- 178169
- 192483



- 194434
- 1949



193908

194479

1550



192918

194421

126

140101

140102

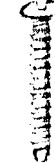
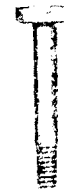

140106

140105

140107

7119

792



5480

194545

194470

1708

1611

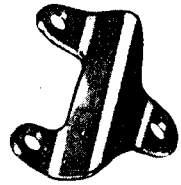

PLATE 9667 - ONE-HALF SIZE

192912

198163

198162



198001



8203

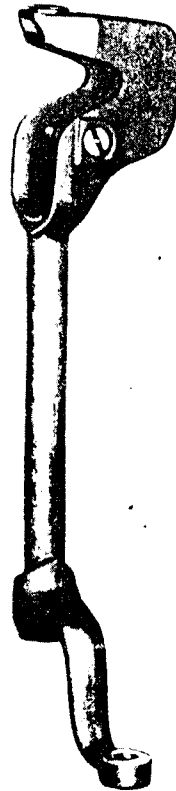

194423

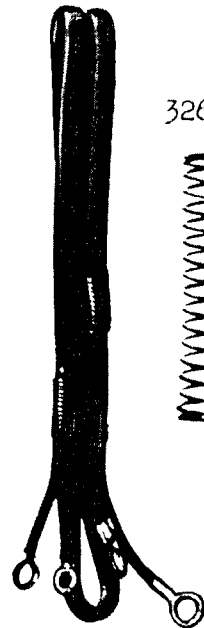

32675



PLATE 9668 - FULL SIZE

25515

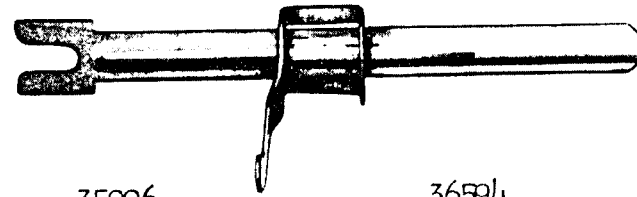

35996



36994

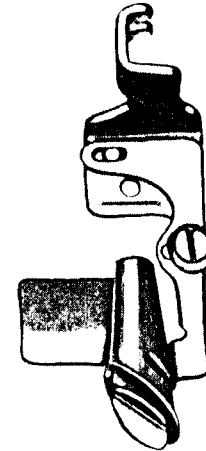

25979



122



1136



50380



286



287



PLATE 9669 - ONE-HALF SIZE

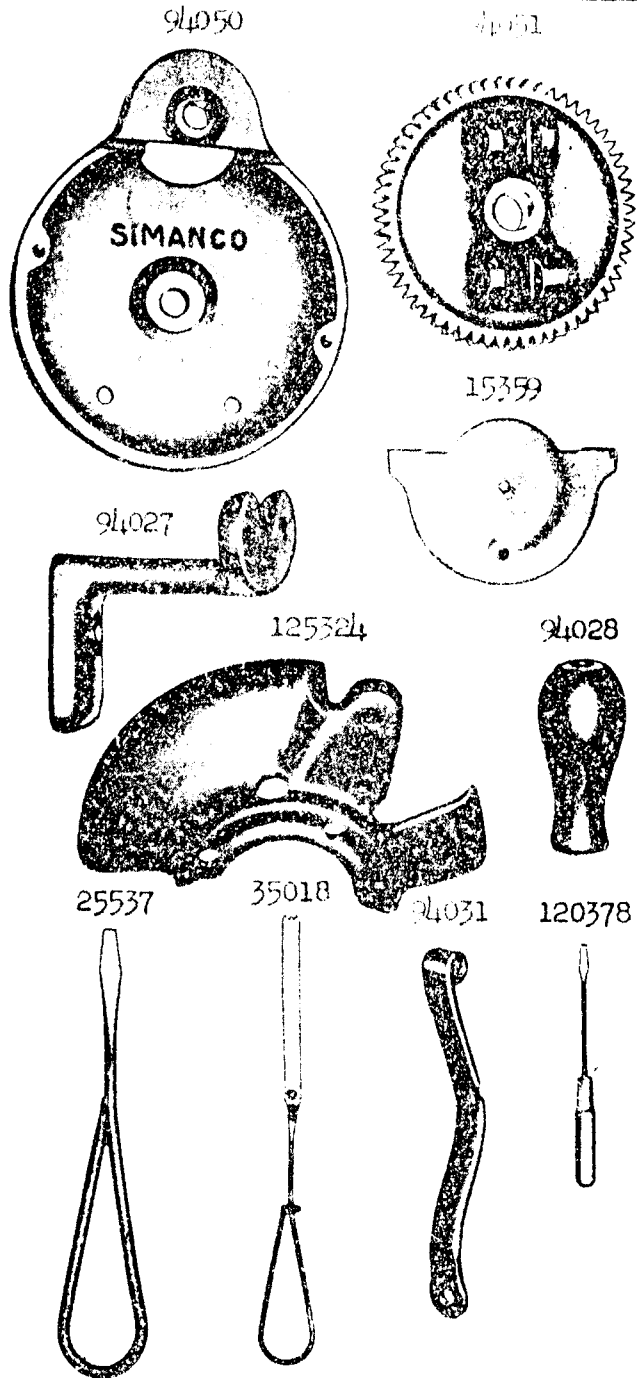

PLATE 20160—ONE-HALF SIZE

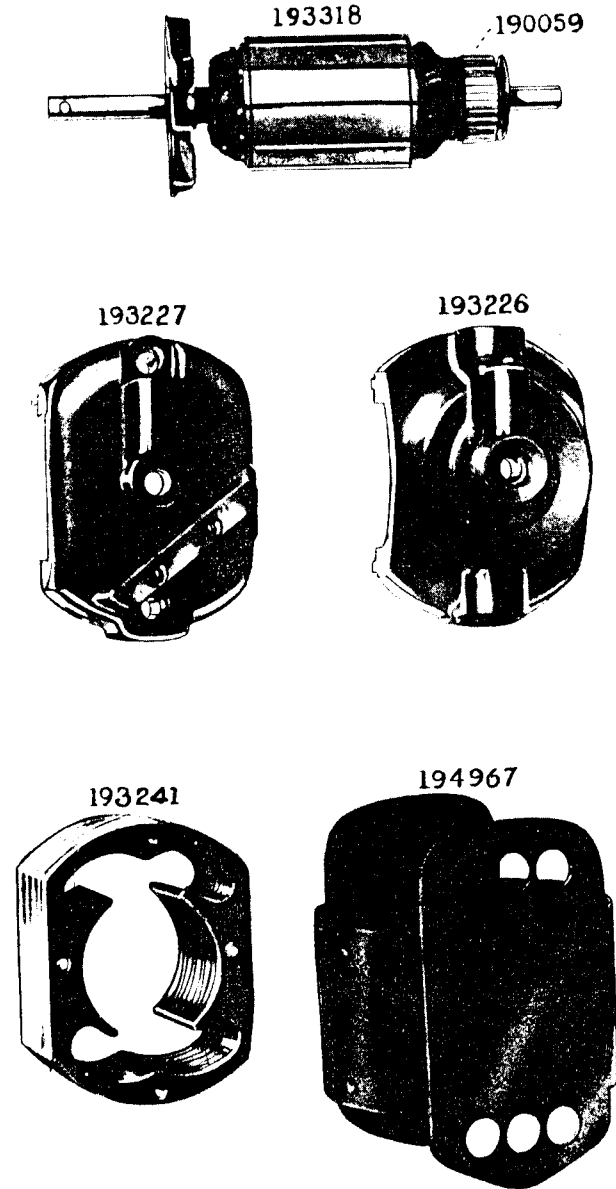

PLATE 21466 - FULL SIZE

193225 51206 193228 190782 194494

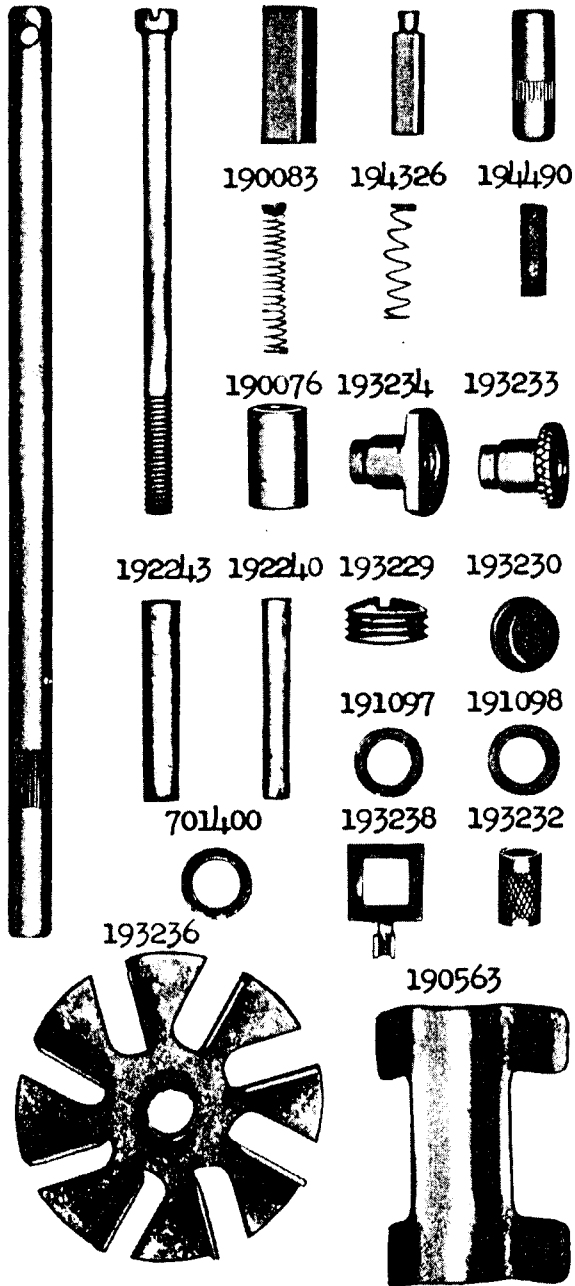

PLATE 21470 - ONE-FOURTH SIZE

192851 194574 194579

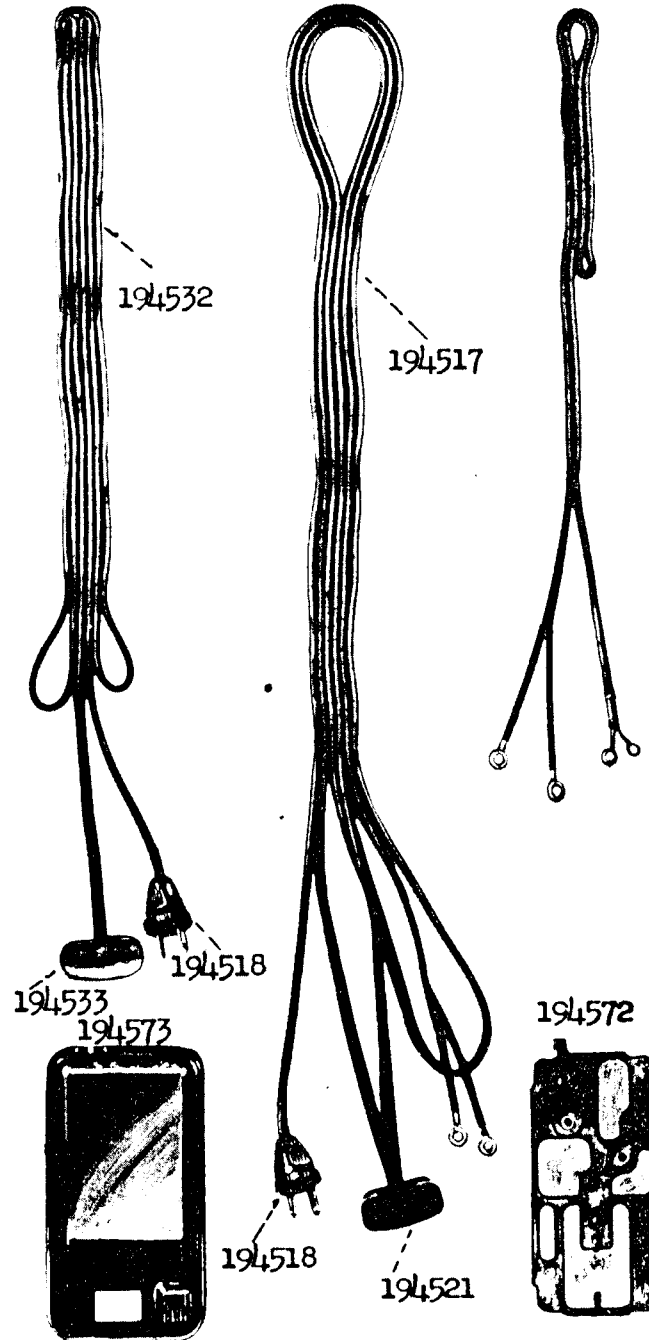
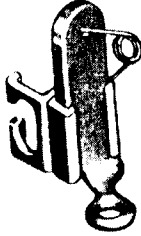
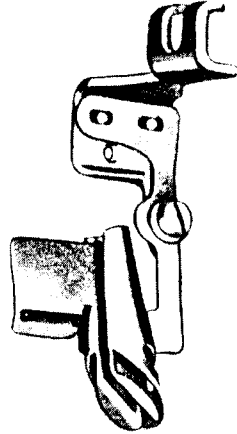

PLATE 22526 - FULL SIZE

121094



121464



26538

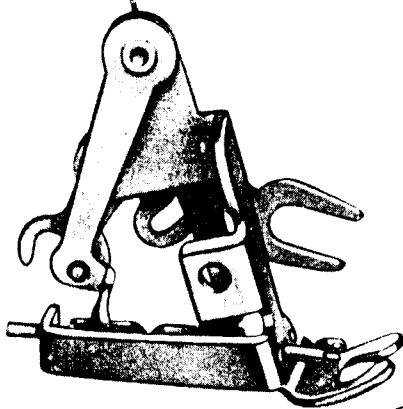

121541

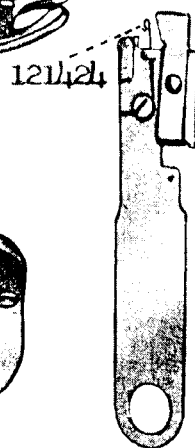

121424

120687

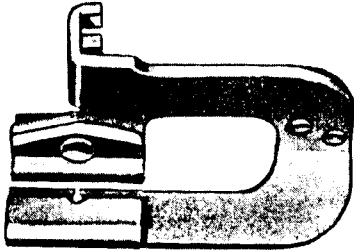
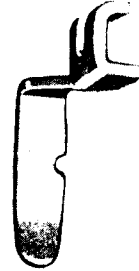

PLATE 22528 - FULL SIZE

15429



25978



36055

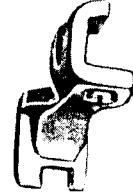

36058



36067

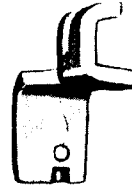

125035



121441

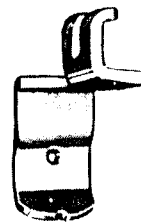

35932

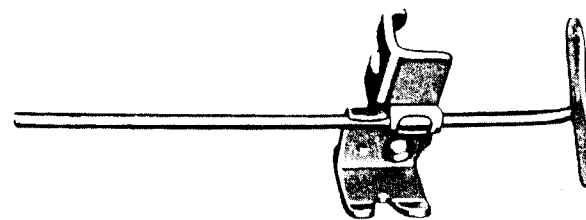

Free Manuals Download Website

<http://myh66.com>

<http://usermanuals.us>

<http://www.somanuals.com>

<http://www.4manuals.cc>

<http://www.manual-lib.com>

<http://www.404manual.com>

<http://www.luxmanual.com>

<http://aubethermostatmanual.com>

Golf course search by state

<http://golfingnear.com>

Email search by domain

<http://emailbydomain.com>

Auto manuals search

<http://auto.somanuals.com>

TV manuals search

<http://tv.somanuals.com>