

LIST OF PARTS



MACHINES

Nos. 96-13 to 96-15

THE SINGER MANUFACTURING COMPANY

INDEX

	PAGE
ACCESSORIES	30
BOBBIN WINDER No. 41916	31
" " " 41348	32
" " " 225436	33
FOOT LIFTER PARTS	34
IRON BASE	30
KNEE LIFTER PARTS	35
KNIFE GRINDER	36
MACHINE No. 96-13	7
" " 96-14	14
" " 96-15	22
NUMERICAL LIST OF PARTS	39
OBSOLETE PARTS	37
TAPE HOLDER	31
THREAD UNWINDER	37

COPYRIGHT, U.S.A., 1917 AND 1921, BY THE SINGER MANUFACTURING CO.
ALL RIGHTS RESERVED FOR ALL COUNTRIES

INSTRUCTIONS FOR ORDERING

In ordering from this list, use **ONLY** the part NUMBER in the **FIRST** column.

The number stamped on a Sewing Machine part is in every case the number of the single part only.

Every combination of parts sent out as such has its specific number, which, although not stamped on the parts, must be used when ordering the combination.

Each number always indicates the **SAME PART** in whatever list it appears, or for whatever machine.

The letters after some of the numbers indicate the style of finish only, as follows:

- A. Hardened, Polished and Plated.
- B. Polished and Plated
- C. Hardened only.
- D. Polished only.
- E. Soft, not Polished.
- F. Hardened and Polished.
- G.
- H. Blued.
- J. Plated only.
- K. Hardened and Plated.
- L. Brass or Gilt.
- M. Oxidized.
- P. Japanned.
- R. Parkerized

These letters **MUST BE USED** *when* they appear in the list, and **AFTER** the number *as* in the list.

In this series

- 1 to 1500 and 50001 to 51500 are Screw Numbers.
- 1501 to 1800 are Nut Numbers.
- 1801 to 2000 are Roller Numbers.
- 2001 to 50000 and 52001 and upward are numbers of Machine Parts.

The figures in the second column refer only to the plates, illustrating the parts, and are **NOT TO BE USED** in ordering.

Parts marked with an asterisk (*) are furnished only when repairs are made at factory

LIST OF PARTS COMPLETE

FOR

MACHINE No. 96-13

FOR EYELET ROW STITCHING. DROP FEED.

NO.	PLATE	NAME
*52381	---	Arm with two 56015.....
16532	5900	" Dowel Pin.....
24131	5900	" Oil Tube with 29599, for oiling 24036
52084	5900	" " " " " " " " 24040
11119	5900	" " " " " " " " 52022
12454	5900	" " " " " " " " 52024
24131	5900	" " " " " " " " 12430
		for 52043.....
29599	5900	Arm Oil Tube Packing (felt).....
116E	5875	" Screw (back).....
854E	5942	" " (front).....
52382	5946	" Shaft (horizontal).....
52059	5894	" " " Flanged Bushing
		(back).....
56006	5900	Arm Shaft (horizontal) Flanged Bushing
		(back) Oil Pad (braided cotton).....
448c	5875	Arm Shaft (horizontal) Flanged Bushing
		(back) Set Screw.....
52078	5894	Arm Shaft (horizontal) Flanged Bushing
		(front).....
56006	5900	Arm Shaft (horizontal) Flanged Bushing
		(front) Oil Pad (braided cotton).....
435c	5899	Arm Shaft (horizontal) Flanged Bushing
		(front) Set Screw.....
54897	5900	Arm Shaft (horizontal) Front Bearing Oil
		Cup.....
52060	5898	Arm Shaft (horizontal) Gear with two
		1036c.....
52074	5894	Arm Shaft (horizontal) Gear Case (two
		pieces) with 121E and 50234D.....
50234D	5899	Arm Shaft (horizontal) Gear Case Plug
		Screw.....
121E	5899	Arm Shaft (horizontal) Gear Case Screw
1036c	5948	" " " " Set Screw..
144D	5875	" " " " Screw.....
52062	5898	" " (upright).....
56099	5898	" " " Bushing (lower)....

NO.	PLATE	NAME
432c	5898	Arm Shaft (upright) Bushing (lower) Set Screw.....
56100	5898	Arm Shaft (upright) Bushing (upper)....
1149c	5875	" " " " " Set Screw.....
56013	5898	Arm Shaft (upright) Gear (lower) with two 1253c.....
1253c	5869	Arm Shaft (upright) Gear (lower) Set Screw.....
56101	5898	Arm Shaft (upright) Gear (upper) with two 1253c.....
1253c	5869	Arm Shaft (upright) Gear (upper) Set Screw.....
56015	5900	Arm Shaft (upright) Oil Tube (lower)....
56015	5900	" " " " " (upper)....
12480	5894	" Side Cap.....
219d	5875	" " " Screw.....
12193	5894	" " Cover.....
50053d	5899	" " " Thumb Screw.....
12403	5900	" Spool Pin and Thread Eyelet.....
8879	5936	" " " Washer (cloth).....
52042	5896	" Top Cover.....
52043	5896	" " " 52042 with 12403 and 24131
158d	5899	" " " Screw.....
52005	5893	Balance Wheel (power) light rim, 2 $\frac{3}{8}$ in. pulley, with two 448c.....
52081	5893	Balance Wheel (stand) heavy rim, 2 $\frac{1}{4}$ in. pulley, with two 448c.....
52063	5894	Balance Wheel Oil Cover.....
210d	5875	" " " " Screw.....
448c	5875	" " Set Screw.....
*52383	---	Bed.....
12431	---	" Slide.....
12432	5894	Bed Slide complete, Nos. 4307, 12431 and two 725e.....
4307	5894	Bed Slide Spring.....
725e	5875	" " " Screw.....
52051	---	Face Plate.....
52052	5894	Face Plate complete, Nos. 52051, 52053, 56086 and two 226d.....
190d	5875	Face Plate Screw.....
52053	5900	" " Thread Guard (lower).....
226d	5900	" " " " " Screw
56086	5900	" " " " (upper).....
226d	5900	" " " " " Screw
50190d	5899	" " Thumb Screw.....
52452	5896	Feed Bar.....

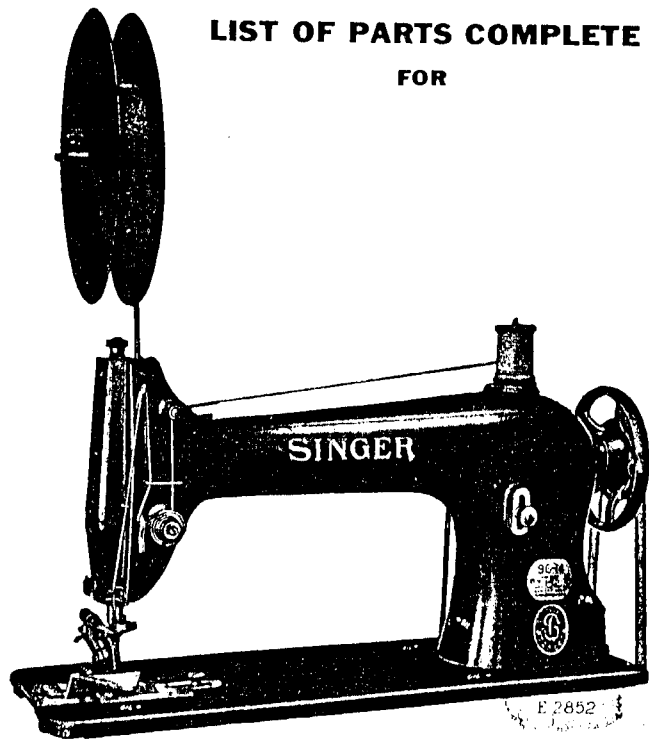
NO.	PLATE	NAME
313c	5875	Feed Bar Screw Centre.....
1519e	5942	" " " " Nut.....
3033	5897	" Connecting Link.....
375c	5897	" " " Hinge Screw.....
1518e	5897	" " " " " Nut
52073	5897	" " " " Stud.....
50083c	5897	" " " " " Set Screw.....
12436	7699	Feed Dog.....
50117e	5875	" " Screw.....
20283	5947	" and Feed Lifting Eccentric with 446c
446c	5899	" " " " Set Screw
24036	5896	" " " " Sleeve...
20284	5947	" Forked Connection.....
375c	5897	" " " Hinge Screw....
1518e	5897	" " " " " Nut
52384	5946	" Lifting Rock Shaft.....
52385	---	Feed Lifting Rock Shaft complete, Nos. 12376 and 52384.....
12430	5896	Feed Lifting Rock Shaft Connecting Rod with 12204 and two 966e.....
*12204	---	Feed Lifting Rock Shaft Connecting Rod Cap.....
966e	5899	Feed Lifting Rock Shaft Connecting Rod Cap Screw.....
375c	5897	Feed Lifting Rock Shaft Connecting Rod Hinge Screw.....
1518e	5897	Feed Lifting Rock Shaft Connecting Rod Hinge Screw Nut.....
12376	5897	Feed Lifting Rock Shaft Crank with 157j and 1813.....
157j	5897	Feed Lifting Rock Shaft Crank Clamping Screw.....
1813	5897	Feed Lifting Rock Shaft Crank Roller and Stud.....
50191c	5899	Feed Lifting Rock Shaft Screw Centre... ..
1513j	5942	" " " " " Nut
52074	5897	" Regulator with 50083c.....
1128e	5897	" " Hinge Screw.....
818d	5897	" " Thumb Screw.....
52359	5948	" " " " Stop.....
52386	5946	" Rock Shaft.....
52387	---	Feed Rock Shaft complete, Nos. 29633 and 52386.....
29633	5897	Feed Rock Shaft Crank with 157j.....
157j	5897	" " " " Clamping Screw..
50191c	5899	" " " Screw Centre.....

NO.	PLATE	NAME
1513J	5942	Feed Rock Shaft Screw Centre Nut.....
25866	6449	Guide.....
732D	5875	" " Thumb Screw.....
52455	7700	Needle Bar (hollow).....
52305	5948	" " Bushing (lower) with 29532..
1133E	5948	" " " " Set Screw....
52014	5948	" " " (upper).....
1133E	5948	" " " " Set Screw....
24040	5948	" " Connecting Link with 794E..
794E	5948	" " " " Adjusting Screw.....
775E	5948	Needle Bar Connecting Link Cap Screw
24041	5948	" " " Stud with 207E..
207E	5948	" " " " Clamping Screw.....
24052	5947	Needle Bar Crank with 858c, 1036c, 1037c and 1065c.....
1065c	5875	Needle Bar Crank Position Screw.....
858c	5875	" " " Set Screw.....
29532	5948	" " Oil Cup.....
52415	7700	" " Thread Guard.....
229D	5948	" " " " Screw.....
52307	5948	" " Clamp with 808F.....
808F	5948	" " Screw.....
12391	5896	Presser Bar (hollow).....
52338	5936	" " Guide Bracket with 223c and 453c.....
453c	5936	Presser Bar Guide Bracket Set Screw....
52016	5936	" " Lifter.....
689c	5936	" " " Screw.....
1520E	5936	" " " " Nut.....
12327	5936	" " Lifting and Releasing Lever Bracket.....
11167	5896	Presser Bar Spring.....
11170	5936	" " " Washer.....
688J	5875	Pressure Regulating Thumb Screw.....
1896	7701	Roller, $\frac{7}{8}$ in. diam., fine, with 386D and 1528D, for 12265.....
51824	7709	Roller, $\frac{3}{4}$ in. diam., coarse, with 388D and 1550H, for 52457.....
1986	7709	Roller, $\frac{7}{8}$ in. diam., fine, with 652D and 1528D, for 52461.....
12256	7701	Roller Arm for 12265.....
52456	7709	" " " 52457.....
52460	7709	" " " 52461.....
410F	7701	" " Adjusting Screw.....
1547J	7701	" " " " Nut.....

NO.	PLATE	NAME
2206	7701	Roller Arm Bracket.....
316F	7701	" " " " Screw Centre.....
1547J	7701	" " " " " Nut....
2205	7701	" " Lock Spring.....
176D	7701	" " " " " Screw.....
1549J	7701	" " " " " Nut.....
12265	7701	Roller Presser complete, $\frac{1}{8}$ in. fine roller, Nos. 176D, 440F, 1549J, 1896, 2205, 2206, 12256, two 316F and three 1547J
52457	---	Roller Presser complete, $\frac{3}{8}$ in. coarse roller, Nos. 176D, 440F, 1549J, 2205, 2206, 51824, 52456, two 316F and three 1547J
52461	7709	Roller Presser complete, $\frac{3}{8}$ in. fine roller, Nos. 176D, 440F, 1549J, 1986, 2205, 2206, 52460, two 316F and three 1547J
190D	5875	Roller Presser Screw.....
386D	7701	" " Screw for 1896.....
388D	7709	" " " 51824.....
652D	7701	" " " 1986.....
1528D	7701	" " Nut for 1896 and 1986.....
1550H	7709	" " " " 51824.....
52121	---	Rotating Hook.....
52123	---	" " 52121 with 52090 and four 1053D.....
52089	5898	Rotating Hook 52123 with 40274 and three each 1253c and 1367D.....
52478	---	Rotating Hook 52089 with 52474.....
40264	5869	" " Bobbin.....
52472	---	" " " Case.....
40392	5869	" " " " Latch.....
40409	5869	" " " " " Lever
2974	5869	" " " " " "
		Fulcrum Pin.....
2975	5869	Rotating Hook Bobbin Case Latch Spring
592E	5869	" " " " " " Stop Screw.....
40393	---	Rotating Hook Bobbin Case Hinge, Nos. 2974, 40392 and 40409.....
*52475	---	Rotating Hook Bobbin Case Locating Plate.....
*52476	---	Rotating Hook Bobbin Case Locating Plate Rivet.....
591F	5869	Rotating Hook Bobbin Case Tension Reg- ulating Screw.....
40394	5869	Rotating Hook Bobbin Case Tension Spring.....

NO.	PLATE	NAME
1380b	5869	Rotating Hook Bobbin Case Tension Spring Screw
52473	7710	Rotating Hook Bobbin Case complete, Nos. 591F, 592E, 1380b, 2975, 40393, 40394 and 52472
52474	—	Rotating Hook Bobbin Case 52473 with 52477
52477	7710	Rotating Hook Bobbin Case Holder with 52475 and two 52476
52018	5869	Rotating Hook Bobbin Case Holder Position Bracket
704j	5869	Rotating Hook Bobbin Case Holder Position Bracket Screw
40274	5869	Rotating Hook Section
1367d	5869	" " " Screw
1253c	5869	" " Set Screw
52388	5946	" " Shaft
56106	5898	" " " Bushing (back)
52045	5898	" " " " " Pack- ing (cotton)
1143c	7700	Rotating Hook Shaft Bushing (back) Set Screw
56107	5898	Rotating Hook Shaft Bushing (front)
52045	5898	" " " " " Pack- ing (cotton)
1148c	5898	Rotating Hook Shaft Bushing (front) Set Screw
56013	5898	Rotating Hook Shaft Gear with two 1253c
52072	5894	" " " " Case (two pieces) with 121E and 50234d
50234d	5899	Rotating Hook Shaft Gear Case Plug Screw
121E	5899	Rotating Hook Shaft Gear Case Screw
1253c	5869	" " " " Set Screw
52090	5898	" " Thread Guard
1053d	5869	" " " " Screw
52337	5936	Slack Thread Regulator
223c	5936	" " " Screw
52046	5947	Spool Holder Base
389d	5942	" " " Screw
204296	5947	" " " Wire
200079u	5942	" " " " Hinge Screw
52047	5947	Spool Holder complete, Nos. 52046, 200079u and 204296
2102	7700	Tension Disc
1560c	7700	" Regulating Thumb Nut
32572	7700	" Releasing Disc

NO.	PLATE	NAME
43944	5936	Tension Releasing Lever
12398	5936	" " " Hinge Pin
12329	5936	" " " Spring
32574	7700	" " Pin
2103	5899	" Spring
50304c	5899	" Stud
50305c	5899	" " Set Screw
52397	—	Tension complete, Nos. 1560c, 2103, 32572, 32574, 50304c, 52083, 52394 and two 2102
52027	7700	Thread Guard (side of arm)
52454	5900	" Retainer
460c	7700	" " Set Screw
52021	5948	" Take-up Crank
1037c	5948	" " Position Screw
1036c	5948	" " Set Screw
52022	5948	" " Lever with 52130
52023	5948	" " " Hinge Pin
52024	5948	" " " Link
11204	5948	" " " " " Hinge Pin
435c	5899	" " " " " " " Set Screw
52130	5948	Thread Take-up Lever Thread Eyelet Bushing
52025	—	Thread Take-up Lever complete, Nos. 52022 to 52024
52394	5948	Thread Take-up Spring
52083	5899	" " " Regulator with 50305c
448c	5875	Thread Take-up Spring Regulator Set Screw
24444	—	Throat Plate, large oblong needle hole
24443	7699	" " small oblong needle hole
691F	5875	" " Screw
44212	7711	Drip Pan with four 1 in. wire nails



**LIST OF PARTS COMPLETE
FOR**

MACHINE No. 96-14

**FOR STITCHING TOP FACINGS TO SHOE LINING, ALSO
FOR SIDE AND BACK STAYS, DROP FEED**

NO.	PLATE	NAME
*52416	—	Arm with two 56015
16532	5900	" Dowel Pin
24131	5900	" Oil Tube with 29599, for oiling 24036
52081	5900	" " " " " " 24040
11119	5900	" " " " " " 52022
12454	5900	" " " " " " 52024
24131	5900	" " " " " " 12430
		for 52013
29599	5900	Arm Oil Tube Packing (felt)
116e	5875	" Screw (back)

NO.	PLATE	NAME
854e	5942	Arm Screw (front)
52382	5946	" Shaft (horizontal)
52059	5894	" " Flanged Bushing (back)
56006	5900	Arm Shaft (horizontal) Flanged Bushing (back) Oil Pad (braided cotton)
448c	5875	Arm Shaft (horizontal) Flanged Bushing (back) Set Screw
52078	5894	Arm Shaft (horizontal) Flanged Bushing (front)
56006	5900	Arm Shaft (horizontal) Flanged Bushing (front) Oil Pad (braided cotton)
435c	5899	Arm Shaft (horizontal) Flanged Bushing (front) Set Screw
54897	5900	Arm Shaft (horizontal) Front Bearing Oil Cup
52060	5898	Arm Shaft (horizontal) Gear with two 1036c
52071	5894	Arm Shaft (horizontal) Gear Case (two pieces) with 121e and 50234d
50234d	5899	Arm Shaft (horizontal) Gear Case Plug Screw
121e	5899	Arm Shaft (horizontal) Gear Case Screw
1036c	5948	" " " " Set Screw
144d	5875	" " " " Screw
52062	5898	" " (upright)
56099	5898	" " " Bushing (lower)
432c	5898	" " " " " Set Screw
56100	5898	Arm Shaft (upright) Bushing (upper)
1149c	5875	" " " " " Set Screw
55013	5898	Arm Shaft (upright) Gear (lower) with two 1253c
1253c	5869	Arm Shaft (upright) Gear (lower) Set Screw
56101	5898	Arm Shaft (upright) Gear (upper) with two 1253c
1253c	5869	Arm Shaft (upright) Gear (upper) Set Screw
56015	5900	Arm Shaft (upright) Oil Tube (lower)
56015	5900	" " " " (upper)
12480	5894	" Side Cap
219d	5875	" " " Screw
12193	5894	" " Cover
50053d	5899	" " " Thumb Screw
12403	5900	" Spool Pin and Thread Eyelet

NO.	PLATE	NAME
8879	5936	Arm Spool Pin Washer (cloth).....
52042	5896	" Top Cover.....
52043	5896	" " " 52042 with 12403 and 24131.....
158d	5899	Arm Top Cover Screw.....
52005	5893	Balance Wheel (power) light rim, 2 $\frac{3}{8}$ in. pulley, with two 448c.....
52081	5893	Balance Wheel (stand) heavy rim, 2 $\frac{1}{8}$ in. pulley, with two 448c.....
52063	5894	Balance Wheel Oil Cover.....
210d	5875	" " " " Screw.....
448c	5875	" " Set Screw.....
*52383	-----	Bed.....
52417	-----	" Slide.....
52418	7702	Bed Slide complete, Nos. 52417, 52464 and two 665e.....
52464	7710	Bed Slide Spring.....
665e	7710	" " " " Screw.....
120063	7703	Edge Guide.....
50190d	5899	" " Thumb Screw.....
52051	-----	Face Plate.....
52052	5894	Face Plate complete, Nos. 52051, 52053, 56086 and two 226d.....
190d	5875	Face Plate Screw.....
52053	5900	" " Thread Guard (lower).....
226d	5900	" " " " " Screw
56086	5900	" " " " (upper).....
226d	5900	" " " " " Screw
50190d	5899	" " Thumb Screw.....
52452	5896	Feed Bar.....
313c	5875	" " Screw Centre.....
1519e	5942	" " " " Nut.....
3033	5897	" Connecting Link.....
375c	5897	" " " Hinge Screw....
1518e	5897	" " " " " Nut.....
52073	5897	" " " " Stud.....
50083c	5897	" " " " " Set Screw.....
12436	7699	Feed Dog.....
50117e	5875	" " Screw.....
20283	5947	" and Feed Lifting Eccentric with 446e
446c	5899	" " " " Set Screw
24036	5896	" " " " Sleeve...
20284	5947	" Forked Connection.....
375c	5897	" " " Hinge Screw....
1518e	5897	" " " " " Nut.....
52384	5946	" Lifting Rock Shaft.....

NO.	PLATE	NAME
52385	-----	Feed Lifting Rock Shaft complete, Nos. 12376 and 52384.....
12430	5896	Feed Lifting Rock Shaft Connecting Rod with 12204 and two 966e.....
*12204	-----	Feed Lifting Rock Shaft Connecting Rod Cap.....
966e	5899	Feed Lifting Rock Shaft Connecting Rod Cap Screw.....
375c	5897	Feed Lifting Rock Shaft Connecting Rod Hinge Screw.....
1518e	5897	Feed Lifting Rock Shaft Connecting Rod Hinge Screw Nut.....
12376	5897	Feed Lifting Rock Shaft Crank with 157j and 1813.....
157j	5897	Feed Lifting Rock Shaft Crank Clamping Screw.....
1813	5897	Feed Lifting Rock Shaft Crank Roller and Stud.....
50191c	5899	Feed Lifting Rock Shaft Screw Centre...
1513j	5942	" " " " " " Nut
52074	5897	" Regulator with 50083c.....
1128e	5897	" " Hinge Screw.....
818d	5897	" " Thumb Screw.....
52359	5948	" " " " Stop.....
52386	5946	" Rock Shaft.....
52387	-----	Feed Rock Shaft complete, Nos. 29633 and 52386.....
29633	5897	Feed Rock Shaft Crank with 157j.....
157j	5897	" " " " Clamping Screw..
50191c	5899	" " " Screw Centre.....
1513j	5942	" " " " " Nut.....
52455	7700	Needle Bar (hollow).....
52305	5948	" " Bushing (lower) with 29532..
1133e	5948	" " " " Set Screw....
52014	5948	" " " (upper).....
1133e	5948	" " " Set Screw....
24040	5948	" " Connecting Link with 794e..
794e	5948	" " " " Adjusting Screw.....
775e	5948	Needle Bar Connecting Link Cap Screw
24041	5948	" " " Stud with 207e
207e	5948	" " " Clamping Screw.....
24052	5947	Needle Bar Crank with 858c, 1036c, 1037c and 1065c.....
1065c	5875	Needle Bar Crank Position Screw.....

NO.	PLATE	NAME
858c	5875	Needle Bar Crank Set Screw.....
20532	5948	" " Oil Cup.....
52415	7700	" " Thread Guard.....
229d	5948	" " " " Screw.....
52307	5948	" Clamp with 808F.....
808F	5948	" " Screw.....
12391	5896	Presser Bar (hollow).....
52338	5936	" " Guide Bracket with 223c and 453c.....
453c	5936	Presser Bar Guide Bracket Set Screw....
52016	5936	" " Lifter.....
689c	5936	" " " " Screw.....
1520E	5936	" " " " Nut.....
12327	5936	" " Lifting and Releasing Lever Bracket.....
11167	5896	Presser Bar Spring.....
11170	5936	" " " Washer.....
688J	5875	Pressure Regulating Thumb Screw.....
1903	7701	Roller, 1¼ in. diam., coarse, with 652D and 1528d, for 52414.....
51824	7709	Roller, 1/8 in. diam., coarse, with 388d and 1550H, for 52457.....
1886	7709	Roller, 1¼ in. diam., coarse, with 386D and 1528d, for 52458.....
1986	7709	Roller, 3/8 in. diam., fine, with 652D and 1528d, for 52461.....
52453	7701	Roller Arm for 52414 and 52458.....
52456	7709	" " " 52457.....
52460	7709	" " " 52461.....
440F	7701	" " Adjusting Screw.....
1547J	7701	" " " " Nut.....
4282	7701	" " Bracket for 52414 and 52458.....
2206	7701	" " " " 52457 and 52461.....
316F	7701	" " " " Screw Centre.....
1547J	7701	" " " " " Nut....
2205	7701	" " Lock Spring.....
176d	7701	" " " " Screw.....
1549J	7701	" " " " " Nut.....
52414	7701	Roller Presser complete, 1¼ in. coarse roller, Nos. 176d, 440F, 1549J, 1903, 2205, 4282, 52453, two 316F and three 1547J.....
52457	---	Roller Presser complete, 1/8 in. coarse roller, Nos. 176d, 440F, 1549J, 2205, 2206, 51824, 52456, two 316F and three 1547J

NO.	PLATE	NAME
52458	7709	Roller Presser complete, 1¼ in. coarse roller, Nos. 176d, 440F, 1549J, 1886, 2205, 4282, 52453, two 316F and three 1547J.....
52461	7709	Roller Presser complete, 3/8 in. fine roller, Nos. 176d, 440F, 1549J, 1986, 2205, 2206, 52460, two 316F and three 1547J
190d	5875	Roller Presser Screw.....
386d	7701	" " Screw for 1886.....
388d	7709	" " " 51824.....
652d	7701	" " " 1903 and 1986.....
1528d	7701	" " Nut for 1886, 1903 and 1986
1550H	7709	" " " " 51824.....
52121	---	Rotating Hook.....
52123	---	" " 52121 with 52090 and four 1053d.....
52089	5898	Rotating Hook 52123 with 40274 and three each 1253c and 1367d.....
52478	---	Rotating Hook 52089 with 52474.....
40264	5869	" " Bobbin.....
52472	---	" " " Case.....
40392	5869	" " " " Latch.....
40409	5869	" " " " " Lever
2974	5869	" " " " " " "
		Fulcrum Pin.....
2975	5869	Rotating Hook Bobbin Case Latch Spring
592E	5869	" " " " " Stop Screw.....
40393	---	Rotating Hook Bobbin Case Hinge, Nos. 2974, 40392 and 40409.....
*52475	---	Rotating Hook Bobbin Case Locating Plate.....
*52476	---	Rotating Hook Bobbin Case Locating Plate Rivet.....
591F	5869	Rotating Hook Bobbin Case Tension Reg- ulating Screw.....
40394	5869	Rotating Hook Bobbin Case Tension Spring.....
1380d	5869	Rotating Hook Bobbin Case Tension Spring Screw.....
52473	7710	Rotating Hook Bobbin Case complete, Nos. 591F, 592E, 1380d, 2975, 40393, 40394 and 52472.....
52474	---	Rotating Hook Bobbin Case 52473 with 52477.....
52477	7710	Rotating Hook Bobbin Case Holder with 52475 and two 52476.....

NO.	PLATE	NAME
52018	5869	Rotating Hook Bobbin Case Holder Position Bracket.....
701J	5869	Rotating Hook Bobbin Case Holder Position Bracket Screw.....
40274	5869	Rotating Hook Section.....
1367D	5869	" " " Screw.....
1253C	5869	" " Set Screw.....
52388	5946	" " Shaft.....
56106	5898	" " " Bushing (back).....
52045	5898	" " " " " Pack- ing (cotton).....
1143C	7700	Rotating Hook Shaft Bushing (back) Set Screw.....
56107	5898	Rotating Hook Shaft Bushing (front).....
52045	5898	" " " " " Pack- ing (cotton).....
1148C	5898	Rotating Hook Shaft Bushing (front) Set Screw.....
56013	5898	Rotating Hook Shaft Gear with two 1253C
52072	5894	" " " Case (two pieces) with 121E and 50234D.....
50234D	5899	Rotating Hook Shaft Gear Case Plug Screw.....
121E	5899	Rotating Hook Shaft Gear Case Screw....
1253C	5869	" " " " Set Screw....
52090	5898	" " Thread Guard.....
1053D	5869	" " " " Screw.....
52337	5936	Slack Thread Regulator.....
223C	5936	" " " " Screw.....
52046	5947	Spool Holder Base.....
389D	5942	" " " " Screw.....
204296	5947	" " " " Wire.....
200079H	5942	" " " " Hinge Screw.....
52047	5947	Spool Holder complete, Nos. 52046, 200079H and 204296.....
120067	7704	Strip Guide.....
120068	7704	" " (adjustable) with 291F.....
120069	7704	" " " " Bar.....
120070	7704	" " " " Plate.....
50169D	7704	" " " " " Screw
50169D	7704	" " " " " Screw.....
291F	7704	" " " " Thumb Screw..
120071	7704	Strip Guide (adjustable) complete, Nos. 120067 to 120070 and six 50169D.....
1423D	7704	Strip Guide Screw.....
2102	7700	Tension Disc.....
1560C	7700	" Regulating Thumb Nut.....

NO.	PLATE	NAME
32572	7700	Tension Releasing Disc.....
43944	5936	" " Lever.....
12398	5936	" " " Hinge Pin.....
12329	5936	" " " Spring.....
32574	7700	" " Pin.....
2103	5899	" Spring.....
50304C	5899	" Stud.....
50305C	5899	" " Set Screw.....
52397	-----	Tension complete, Nos. 1560C, 2103, 32572, 32574, 50304C, 52083, 52394 and two 2102.....
52027	7700	Thread Guard (side of arm).....
52454	5900	" Retainer.....
460C	7700	" " Set Screw.....
52021	5948	" Take-up Crank.....
1037C	5948	" " " Position Screw...
1036C	5948	" " " Set Screw.....
52022	5948	" " Lever with 52130.....
52023	5948	" " " Hinge Pin.....
52024	5948	" " " Link.....
11204	5948	" " " " Hinge Pin...
435C	5899	" " " " " " Set Screw.....
52130	5948	Thread Take-up Lever Thread Eyelet Bushing.....
52025	-----	Thread Take-up Lever complete, Nos. 52022 to 52024.....
52394	5948	Thread Take-up Spring.....
52083	5899	" " " Regulator with 50305C.....
448C	5875	Thread Take-up Spring Regulator Set Screw.....
12438	7699	Throat Plate, large oblong needle hole...
20192	-----	" " small oblong needle hole...
691F	5875	" " Screw.....
44212	7711	Drip Pan with four 1 in. wire nails.....

LIST OF PARTS COMPLETE

FOR

MACHINE No. 96-15

FOR EDGE AND UNDER EDGE TRIMMING FOR BOOTS AND SHOES. HORIZONTAL TRIMMER, OPERATED BY ECCENTRIC ON THE ROTARY HOOK. ROLLER PRESSER.

NO.	PLATE	NAME
*52381		Arm with two 56015.....
16532	5900	" Dowel Pin.....
24131	5900	" Oil Tube with 29599, for oiling 24036
52084	5900	" " " " " " " 24040
11119	5900	" " " " " " " 52022
12454	5900	" " " " " " " 52024
24131	5900	" " " " " " " 12430
		for 52043.....
29599	5900	Arm Oil Tube Packing (felt).....
116E	5875	" Screw (back).....
854E	5942	" " (front).....
52382	5946	" Shaft (horizontal).....
52059	5894	" " " Flanged Bushing (back).....
56006	5900	Arm Shaft (horizontal) Flanged Bushing (back) Oil Pad (braided cotton).....
448c	5875	Arm Shaft (horizontal) Flanged Bushing (back) Set Screw.....
52078	5894	Arm Shaft (horizontal) Flanged Bushing (front).....
56006	5900	Arm Shaft (horizontal) Flanged Bushing (front) Oil Pad (braided cotton).....
435c	5899	Arm Shaft (horizontal) Flanged Bushing (front) Set Screw.....
54897	5900	Arm Shaft (horizontal) Front Bearing Oil Cup.....
52060	5898	Arm Shaft (horizontal) Gear with two 1036c.....
52071	5894	Arm Shaft (horizontal) Gear Case (two pieces) with 121E and 50234D.....
50234D	5899	Arm Shaft (horizontal) Gear Case Plug Screw.....
121E	5899	Arm Shaft (horizontal) Gear Case Screw.....
1036c	5948	" " " " Set Screw.....

NO.	PLATE	NAME
144D	5875	Arm Shaft (horizontal) Screw.....
52062	5898	" " (upright).....
56099	5898	" " " Bushing (lower)....
432c	5898	" " " " " Set Screw.....
56100	5898	Arm Shaft (upright) Bushing (upper)....
1149c	5875	" " " " " Set Screw.....
56013	5898	Arm Shaft (upright) Gear (lower) with two 1253c.....
1253c	5869	Arm Shaft (upright) Gear (lower) Set Screw.....
56101	5898	Arm Shaft (upright) Gear (upper) with two 1253c.....
1253c	5869	Arm Shaft (upright) Gear (upper) Set Screw.....
56015	5900	Arm Shaft (upright) Oil Tube (lower)....
56015	5900	" " " " " (upper)....
12480	5894	" Side Cap.....
219D	5875	" " " Screw.....
12193	5894	" " Cover.....
50053D	5899	" " " Thumb Screw.....
12403	5900	" Spool Pin and Thread Eyelet.....
8879	5936	" " " Washer (cloth).....
52042	5896	" Top Cover.....
52043	5896	" " " 52042 with 12403 and 24131
158D	5899	" " " Screw.....
52005	5893	Balance Wheel (power) light rim, 2 1/8 in. pulley, with two 448c.....
52081	5893	Balance Wheel (stand) heavy rim, 2 1/8 in. pulley, with two 448c.....
52063	5894	Balance Wheel Oil Cover.....
210D	5875	" " " " Screw.....
448c	5875	" " " Set Screw.....
*52419	—	Bed.....
12431	—	" Slide.....
12432	5894	Bed Slide complete, Nos. 4307, 12431 and two 725E.....
4307	5894	Bed Slide Spring.....
725E	5875	" " " Screw.....
52051	—	Face Plate.....
52052	5894	Face Plate complete, Nos. 52051, 52053, 56086 and two 226D.....
190D	5875	Face Plate Screw.....
52053	5900	" " Thread Guard (lower).....
226D	5900	" " " " " Screw.....
56086	5900	" " " " (upper).....

NO.	PLATE	NAME
226b	5900	Face Plate Thread Guard (upper) Screw.
50190d	5899	" " Thumb Screw.
52452	5896	Feed Bar.
313c	5875	" " Screw Centre.
1519e	5942	" " " " Nut.
3033	5897	" Connecting Link.
375c	5897	" " " Hinge Screw.
1518e	5897	" " " " " Nut
52073	5897	" " " " Stud.
50083c	5897	" " " " " Set Screw.
24162	7705	Feed Dog, 10 teeth (16 teeth to the inch)
50117e	5875	" " Screw.
20283	5947	" and Feed Lifting Eccentric with 446c
446c	5899	" " " " " Set Screw
24036	5896	" " " " " Sleeve.
20284	5947	" Forked Connection.
375c	5897	" " " " Hinge Screw.
1518e	5897	" " " " " Nut
52384	5946	" Lifting Rock Shaft.
52385	—	Feed Lifting Rock Shaft complete, Nos. 12376 and 52384.
12430	5896	Feed Lifting Rock Shaft Connecting Rod with 12204 and two 966e.
*12204	—	Feed Lifting Rock Shaft Connecting Rod Cap.
966e	5899	Feed Lifting Rock Shaft Connecting Rod Cap Screw.
375c	5897	Feed Lifting Rock Shaft Connecting Rod Hinge Screw.
1518e	5897	Feed Lifting Rock Shaft Connecting Rod Hinge Screw Nut.
12376	5897	Feed Lifting Rock Shaft Crank with 157j and 1813.
157j	5897	Feed Lifting Rock Shaft Crank Clamping Screw.
1813	5897	Feed Lifting Rock Shaft Crank Roller and Stud.
50191c	5899	Feed Lifting Rock Shaft Screw Centre.
1513j	5942	" " " " " Nut
52074	5897	" Regulator with 50083c.
1128e	5897	" " Hinge Screw.
818d	5897	" " Thumb Screw.
52359	5948	" " " " Stop.
52386	5946	" Rock Shaft.
52387	—	Feed Rock Shaft complete, Nos. 29633 and 52386.

NO.	PLATE	NAME
29633	5897	Feed Rock Shaft Crank with 157j.
157j	5897	" " " " Clamping Screw
50191c	5899	" " " " Screw Centre.
1513j	5942	" " " " " Nut.
24164	7706	Knife with Guide (corner bent up) for under trimming.
24165	—	Knife with Guide (corner bent up) and Holder (sectional) complete, for under trimming, Nos. 24164, 24174 and two 1096f.
24586	7706	Knife without Guide (corner bent up) for under trimming.
24587	—	Knife without Guide (corner bent up) and Holder (sectional) complete, for under trimming, Nos. 24174, 24586 and two 1096f.
24605	7706	Knife with Guide (corner flush with top) for under trimming.
24606	—	Knife with Guide (corner flush with top) and Holder (sectional) complete, for under trimming, Nos. 24174, 24605 and two 1096f.
24607	7706	Knife without Guide (corner flush with top) for under trimming.
24608	—	Knife without Guide (corner flush with top) and Holder (sectional) complete, for under trimming, Nos. 24174, 24607 and two 1096f.
24166	7706	Knife, for edge trimming.
24167	—	Knife and Holder (sectional) complete, for edge trimming, Nos. 24166, 24174 and two 1096f.
24168	7707	Knife Driving Lever with 24177.
52420	—	Knife Driving Lever complete, Nos. 104d, 24168, 24173 and 52421.
24170	7707	Knife Driving Lever Centre Plate.
24171	7707	" " " " " Cap
934j	7707	" " " " " " "
756j	7707	Screw.
52421	7707	Knife Driving Lever Centre Plate Screw
24173	7707	" " " " Fork.
104d	7707	" " " " " Swivel.
24334	7707	" " " " " Screw.
242j	7707	" " " " " Shield.
24174	7706	" " " " " Screw.
1098c	7707	" Holder.
		" " Adjusting Screw.

NO.	PLATE	NAME
886c	7707	Knife Holder Adjusting Screw Binding Screw.....
24175	7707	Knife Holder Bushing.....
24176	7707	" " Position Spring.....
24177	7707	" " " Stud.....
24188	---	" " Regulator, Nos. 886c and 1098c.....
1095k	7707	Knife Holder Screw.....
1097k	7707	" " Stop Screw.....
1096f	7706	" Screw.....
52468	7710	Needle Bar (hollow) with 857u.....
52305	5948	" " Bushing (lower) with 29532..
1133e	5948	" " " " Set Screw...
52014	5948	" " " (upper).....
1133e	5948	" " " " Set Screw...
24040	5948	" " Connecting Link with 794e..
794e	5948	" " " " Adjusting Screw.....
775e	5948	Needle Bar Connecting Link Cap Screw..
24041	5948	" " " Stud with 207e..
207e	5948	" " " " Clamping Screw.....
24052	5947	Needle Bar Crank with 858c, 1036c, 1037c and 1065c.....
1065c	5875	Needle Bar Crank Position Screw.....
858c	5875	" " " Set Screw.....
29532	5948	" " Oil Cup.....
857u	7710	" Set Screw.....
12391	5896	Presser Bar (hollow).....
52338	5936	" " Guide Bracket with 223c and 453c.....
453c	5936	Presser Bar Guide Bracket Set Screw....
52016	5936	" " Lifter.....
689c	5936	" " " Screw.....
1520e	5936	" " " " Nut.....
12327	5936	" " Lifting and Releasing Lever Bracket.....
11167	5896	Presser Bar Spring.....
11170	5936	" " " Washer.....
688j	5875	Pressure Regulating Thumb Screw.....
1903	7701	Roller, 1¼ in. diam., coarse, with 652b and 1528b, for 52414.....
51824	7709	Roller, 1½ in. diam., coarse, with 388b and 1550u, for 52457.....
1923	7709	Roller, 1¼ in. diam., coarse, with 652b and 1528b, for 52459.....

NO.	PLATE	NAME
1986	7709	Roller, 7/8 in. diam., fine, with 652b and 1528b, for 52461.....
52453	7701	Roller Arm for 52414.....
52456	7709	" " " 52457.....
12257	7709	" " " 52459.....
52460	7709	" " " 52461.....
410f	7701	" " Adjusting Screw.....
1547j	7701	" " " " Nut.....
4282	7701	" " Bracket for 52414.....
2206	7701	" " " " 52457 and 52461..
46037	7709	" " " " 52459.....
316f	7701	" " " Screw Centre.....
1547j	7701	" " " " " Nut...
2205	7701	" " Lock Spring.....
176d	7701	" " " " Screw.....
1549j	7701	" " " " " Nut.....
52414	7701	Roller Presser complete, 1¼ in. coarse roller, Nos. 176b, 440f, 1549j, 1903, 2205, 4282, 52453, two 316f and three 1547j.....
52457	---	Roller Presser complete, 1/16 in. coarse roller, Nos. 176b, 440f, 1549j, 2205, 2206, 51824, 52456, two 316f and three 1547j.....
52459	7709	Roller Presser complete, 1¼ in. coarse roller, Nos. 176b, 440f, 1549j, 1923, 2205, 12257, 46037, two 316f and three 1547j.....
52461	7709	Roller Presser complete, 7/8 in. fine roller, Nos. 176b, 440f, 1549j, 1986, 2205, 2206, 52460, two 316f and three 1547j.....
190b	5875	Roller Presser Screw.....
388b	7709	" Screw for 51824.....
652b	7701	" " " 1903, 1923 and 1986....
1528b	7701	" " Nut for 1903, 1923 and 1986
1550u	7709	" " " for 51824.....
52470	---	Rotating Hook.....
52471	---	" " 52470 with 52090 and four 1053b.....
52422	7700	Rotating Hook 52471 with 40274, 50429c and three 1367b.....
52479	---	Rotating Hook 52422 with 52474.....
40264	5869	" " Bobbin.....
52472	---	" " " Case.....
40392	5869	" " " " Latch.....
40409	5869	" " " " " Lever

NO.	PLATE	NAME
2974	5869	Rotating Hook Bobbin Case Latch Lever Fulerum Pin.....
2975	5869	Rotating Hook Bobbin Case Latch Spring
592E	5869	" " " " " Stop Screw.....
40393	—	Rotating Hook Bobbin Case Hinge, Nos. 2974, 40392 and 40409.....
*52475	—	Rotating Hook Bobbin Case Locating Plate
*52476	—	" " " " " " " Rivet.....
591F	5869	Rotating Hook Bobbin Case Tension Reg- ulating Screw.....
40394	5869	Rotating Hook Bobbin Case Tension Spring.....
1380D	5869	Rotating Hook Bobbin Case Tension Spring Screw.....
52473	7710	Rotating Hook Bobbin Case complete, Nos. 591F, 592E, 1380D, 2975, 40393, 40394 and 52472.....
52474	—	Rotating Hook Bobbin Case 52473 with 52477.....
52477	7710	Rotating Hook Bobbin Case Holder with 52475 and two 52476.....
52018	5869	Rotating Hook Bobbin Case Holder Posi- tion Bracket.....
704J	5869	Rotating Hook Bobbin Case Holder Posi- tion Bracket Screw.....
52423	7700	Rotating Hook Key.....
40274	5869	" " Section.....
1367D	5869	" " " Screw.....
50429C	7700	" " Set Screw.....
52424	7702	" " Shaft with 52423.....
56106	5898	" " Bushing (back)....
52045	5898	" " " " " Pack- ing (cotton).....
1143C	7700	Rotating Hook Shaft Bushing (back) Set Screw.....
56107	5898	Rotating Hook Shaft Bushing (front)....
52045	5898	" " " " " Pack- ing (cotton).....
1148C	5898	Rotating Hook Shaft Bushing (front) Set Screw.....
56013	5898	Rotating Hook Shaft Gear with two 1253C
52072	5894	" " " " Case (two pieces) with 121E and 50234D.....
50234D	5899	Rotating Hook Shaft Gear Case Plug Screw.....

NO.	PLATE	NAME
121E	5899	Rotating Hook Shaft Gear Case Screw...
1253C	5869	" " " " Set Screw....
52090	5898	" " Thread Guard.....
1053D	5869	" " " " Screw.....
52337	5936	Slack Thread Regulator.....
223C	5936	" " " Screw.....
52046	5947	Spool Holder Base.....
389D	5942	" " " Screw.....
204296	5947	" " " Wire.....
200079H	5942	" " " " Hinge Screw....
52047	5947	Spool Holder complete, Nos. 52046, 200079H and 204296.....
2102	7700	Tension Disc.....
1560C	7700	" Regulating Thumb Nut.....
32572	7700	" Releasing Disc.....
43944	5936	" " Lever.....
12398	5936	" " " Hinge Pin.....
12329	5936	" " " Spring.....
32574	7700	" " Pin.....
2103	5899	" Spring.....
50304C	5899	" Stud.....
50305C	5899	" " Set Screw.....
52397	—	Tension complete, Nos. 1560C, 2103, 32572, 32574, 50304C, 52083, 52394 and and two 2102.....
52027	7700	Thread Guard (side of arm).....
52454	5900	" Retainer.....
460C	7700	" " Set Screw.....
52021	5948	" Take-up Crank.....
1037C	5948	" " " Position Screw...
1036C	5948	" " " Set Screw.....
52022	5948	" " Lever with 52130.....
52023	5948	" " " Hinge Pin.....
52024	5948	" " " Link.....
11204	5948	" " " " Hinge Pin....
435C	5899	" " " " " " " Set Screw.....
52130	5948	Thread Take-up Lever Thread Eyelet Bushing.....
52025	—	Thread Take-up Lever complete, Nos. 52022 to 52024.....
52394	5948	Thread Take-up Spring.....
52083	5899	" " " Regulator with 50305C.....
448C	5875	Thread Take-up Spring Regulator Set Screw.....
24180	—	Throat Plate Body.....

NO.	PLATE	NAME
24336	7705	Throat Plate Needle Hole Strip, large oblong needle hole.....
24337	—	Throat Plate Needle Hole Strip, small oblong needle hole.....
934J	7707	Throat Plate Needle Hole Strip Screw...
52128	—	Throat Plate with Trimming Attachment, Nos. 1095K, 1097K, 24165, 24170, 24175, 24176, 24180, 24188, 24334, 24336 or 24337, 52120, two each 242J, 756J, 24171 and six 934J.....
52425	7705	Throat Plate with Trimming Attachment complete, Nos. 24162, 24166 and 52428
1094F	7707	Throat Plate Screw.....
44212	7711	Drip Pan with four 1 in. wire nails.....

IRON BASE

NO.	PLATE	NAME
19219	5943	Bed Frame Cushion (leather).....
158c	5943	“ “ “ Screw.....
19220	5943	“ “ “ Spring.....
19226	5943	“ “ Hinge Connection.....
19398	—	“ “ “ “ 19226 with 211F and 19397.....
19397	5943	Bed Frame Hinge Connection Cap.....
211F	5943	“ “ “ “ “ Screw.....
16555	5943	“ “ “ Plate.....
14010	5943	“ “ “ “ Rivet.....
20067	819	Bed Frame with two each 16555, 19398, four each 19219, 19220, six each 14010, wood screws 1 1/4 in. No. 12 and eight 158c.....

ACCESSORIES

NO.	PLATE	NAME
12361	5943	Machine Hinge Connection.....
44139	5943	“ “ Plate.....
44140	—	Machine Hinge complete, Nos. 12361, 44139 and wood screw 1 1/4 in. No. 14
12405	5943	Machine Rest (felt).....
28084	—	“ “ Pin.....
36578	5901	Oiler (copper plated) with 36579.....
36579	5901	“ Spout, 3 1/2 in. long, with 120117...
120117	5901	“ “ Washer (leather).....
26026	5901	Screw Driver (large).....
26485	5901	“ “ (small).....

NO.	PLATE	NAME
8909	5901	Wrench for 1513 and 1518.....
8908	5901	“ “ 1519 and 1520.....
4822	5901	“ “ 1528, 1547 and 1549.....

TAPE HOLDER

(8 IN. DISC)

FOR 96-14 MACHINE

NO.	PLATE	NAME
26061	7708	Bracket Wire with Disc.....
26062	7708	Disc (adjustable) with 286D and 35925...
35925	—	“ Hub.....
286D	5875	“ Thumb Screw.....
26063	7708	Tape Holder (straight) 8 in. disc, complete, Nos. 26061 and 26062.....
190D	5875	Tape Holder Set Screw.....

BOBBIN WINDER

(SWINGING AUTOMATIC, LEFT HAND)

NO.	PLATE	NAME
41913	5902	Bracket with 457c.....
41583	5902	Frame with 457c.....
34105	5902	“ Hinge Pin.....
457c	5899	“ “ “ Set Screw.....
41914	5902	“ Spring.....
41585	5902	Pulley with 171D.....
171D	5899	“ Set Screw.....
41586	5902	Spindle.....
41587	5902	Stop Latch.....
42614	5902	“ “ Hinge Stud.....
457c	5899	“ “ “ “ Set Screw.....
7958	7700	“ “ Stop Pin.....
41588	5902	“ “ Tripping Arm with 185H.....
185H	5899	“ “ “ “ Clamping Screw.....
41591	5902	Tension Bracket with 460c.....
41592	5902	Tension Bracket complete, Nos. 12403, 24131, 41591, 41593 to 41595 and two 2455.....
24131	5900	Tension Bracket Oil Tube with 29599....
29599	5900	“ “ “ “ Packing (felt)..
180D	5875	“ “ Screw.....
12403	5900	“ “ Spool Pin and Thread Eyelet.....
8879	5936	Tension Bracket Spool Pin Washer (cloth)
2455	2834	“ Disc.....

NO.	PLATE	NAME
41593	5936	Tension Spring
41594	5936	" Stud
460c	7700	" " Set Screw
41595	5936	" Thread Guide
41915	5902	Bobbin Winder, Nos. 880E, 7958, 25446, 34105, 41583, 41585 to 41588, 41913, 41914 and 42614
41916	—	Bobbin Winder (swinging automatic, left hand) complete, Nos. 41592 and 41915
880E	5899	Bobbin Winder Screw
25446	5900	" " Washer

BOBBIN WINDER

(SWINGING AUTOMATIC, RIGHT HAND)

NO.	PLATE	NAME
41339	2833	Base
41340	2833	Frame
1429D	2834	" Hinge Screw
41341	2833	" Spring
207D	2834	" " Screw
41342	2833	Pulley with 200F
200F	2834	" Set Screw
41343	2834	Spindle
27306	2834	Spool Pin
27307	2833	" Stand
27308	2833	Spool Stand complete, Nos. 418E, 1562J, 2106, 10141, 11241, 27306, 27307 and two each 2455 and wood screws 1 in. No. 10
11241	2833	Spool Washer (cloth)
41344	2834	Stop Latch
41345	2834	" " Finger
152F	2834	" " " Screw
1430D	2834	" " Hinge Screw
1550H	2834	" " " Nut
41346	2834	" " Lever
1430D	2834	" " " Hinge Screw
2455	2834	Tension Disc
1562J	2834	" Regulating Thumb Nut
418E	2834	" Screw Stud
10141	2834	" Spring
2106	2834	" Thread Guide
60456	—	Bobbin Winder, Nos. 152F, 207D, 1429D, 1550H, 41339 to 41346 and three 1430D

NO.	PLATE	NAME
41347	2833	Bobbin Winder, Nos. 60456 and two each 9331 and wood screws 1 in. No. 10 R. H. B.
41348	—	Bobbin Winder (swinging automatic, right hand) complete, Nos. 27308 and 41347
9331	2834	Bobbin Winder Washer

BOBBIN WINDER

(SWINGING AUTOMATIC, RIGHT HAND)
FOR POWER TABLE

NO.	PLATE	NAME
*225451	—	Bobbin Holder
225463	3469	" Winder and Tension Bracket Base
225453	3470	Frame with 202277 and 225438
225454	3471	" Hinge Pin
202277	3471	" Oil Packing (wick)
225438	3471	" " Well Cap
225455	3471	" Spring
225456	3471	" " Plunger
202473	3470	Pulley with 200380c
200380c	3471	" Set Screw
*225443	—	Spindle
225452	3470	" 225443 with 225451
225444	3471	Stop Latch
200056E	3471	" " Screw
225458	3471	" " Thumb Lever
225459	3471	" " " Hinge Stud
225460	3471	" " " Joint Stud
202478	3471	" " Trip Lever
200299H	3471	" " " Hinge Screw
225461	3471	Tension Bracket with 201499B
200082D	3471	" " Screw
202104	3471	" " Washer
2102	3471	" Disc
202407	3471	" Spring
201499H	3471	" Stud
201572B	3471	" " Thumb Nut
225462	—	Tension Bracket complete, Nos. 201572B, 202407, 225461 and two 2102
225436	3469	Bobbin Winder (swinging automatic, right hand) complete, Nos. 200056E, 200082D, 200299H, 202104, 202473, 202478, 225444, 225452 to 225456, 225458 to 225460, 225462, 225463 and two wood screws 3/4 in. No. 13 R. H. B.

FOOT LIFTER PARTS

NO.	PLATE	NAME
5596	5947	Bell Crank.....
56848	—	“ “ 5596 with 5599 and 5601.....
5599	5947	“ “ Bracket.....
178E	5875	“ “ “ Screw.....
5601	5943	“ “ Hinge Pin.....
5735	5943	“ “ Spring.....
5598	5947	Bell Crank complete, Nos. 5735 and 56848
5670	—	Chain, length 26 in. to 35 in.....
NOTE: When ordering No. 5670 give length required.		
4879	5947	Chain Connecting Link.....
12237	5946	Lifting Lever with 448c.....
52028	5947	“ “ Connecting Rod.....
12416	5936	“ “ “ “ Joint.....
76D	5875	“ “ “ “ “ Hinge Screw.....
1521E	5942	Lifting Lever Connecting Rod Lock Nut
802D	5875	“ “ Hinge Screw.....
12241	5936	“ “ Link.....
766D	5875	“ “ “ Hinge Screw.....
12240	5936	“ “ Pin.....
448C	5875	“ “ “ Set Screw.....
2763	819	Rock Shaft.....
12242	819	“ “ Hanger with two wood screws 1 in. No. 10.....
6337	819	Rock Shaft Lifting Bracket with two 356c.....
12243	819	Rock Shaft Lifting Bracket Hook.....
7125	819	“ “ “ “ “ “.....
356C	5875	“ “ “ “ “ “ Set Screw.....
356C	5875	Rock Shaft Lifting Bracket Set Screw..
2770	819	“ “ Stop Dog with 356c.....
356C	5875	“ “ “ “ Set Screw.....
4880	819	Rock Shaft complete, Nos. 2763, 2770, 7125, 12243 and two each 6337 and 12242.....
4881	819	Treadle.....
4882	5947	“ Shaft.....
4883	5947	“ Spring.....
4884	819	“ Stand.....
4885	819	Treadle complete, Nos. 4879, 4881 to 4884 and two wood screws 1 in. No. 16.....

NO.	PLATE	NAME
52319	—	Foot Lifter complete, Nos. 76D, 766D, 802D, 1521E, 4880, 4885, 5598, 5670, 12237, 12240, 12241, 12416, 52028 and two 178E.....

KNEE LIFTER PARTS

NO.	PLATE	NAME
5596	5947	Bell Crank.....
56848	—	“ “ 5596 with 5599 and 5601.....
5599	5947	“ “ Bracket.....
178E	5875	“ “ “ Screw.....
5601	5943	“ “ Hinge Pin.....
5735	5943	“ “ Spring.....
5598	5947	Bell Crank complete, Nos. 5735 and 56848
12237	5946	Lifting Lever with 448c.....
52028	5947	“ “ Connecting Rod.....
12416	5936	“ “ “ “ Joint.....
76D	5875	“ “ “ “ “ Hinge Screw.....
1521E	5942	Lifting Lever Connecting Rod Lock Nut
802D	5875	“ “ Hinge Screw.....
12241	5936	“ “ Link.....
766D	5875	“ “ “ Hinge Screw.....
12240	5936	“ “ Pin.....
448C	5875	“ “ “ Set Screw.....
2763	7711	Rock Shaft.....
7539	7711	“ “ Hanger with two wood screws 1 in. No. 10.....
2765	7711	Rock Shaft Knee Arm.....
2766	7711	“ “ “ “ Hub with 356c...
356C	5875	“ “ “ “ “ Set Screw...
2768	—	Rock Shaft Knee Arm complete, Nos. 2765 to 2767.....
2767	7711	Rock Shaft Knee Plate with 356c.....
356C	5875	“ “ “ “ Set Screw.....
6337	7711	“ “ Lifting Bracket with two 356c
2778	7711	“ “ “ “ Hook.....
356C	5875	“ “ “ “ “ Set Screw
356C	5875	“ “ “ “ Set Screw...
2770	7711	“ “ Stop Dog with 356c.....
356C	5875	“ “ “ “ Set Screw.....
12250	7711	Rock Shaft complete, Nos. 2763, 2768, 2778, 6337 and two each 2770 and 7539
52320	—	Knee Lifter complete (power table) Nos. 76D, 766D, 802D, 1521E, 5598, 12237, 12240, 12241, 12250, 12416, 52028 and two 178E.....

KNIFE GRINDER

FOR 96-15 MACHINE

NO.	PLATE	NAME
27565	1104	Emery Wheel, 2 in. diam.
1508c	1105	" " Clamping Nut
27822	1105	" " " Washer
27567	1105	" " Shaft
27568	1105	" " Oil Hole Cover (rubber)
27569	1105	" " Pulley
310F	1105	" " Screw Centre
1516d	1105	" " " " Nut
27564	1104	Frame with 27574
899d	1105	Knife Clamping Screw
27657	---	" Holder Body for 27658
27679	---	" " " " 27681
27680	---	" " " " 27682
27658	1105	Knife Holder complete, Nos. 899d, 27657 and 27660
27681	6255	Knife Holder complete for 24164, 24166, 24586, 24605 and 24607, Nos. 899d, 11833, 27660 and 27679
27682	6255	Knife Holder complete, Nos. 899d, 11833, 27660 and 27680
27323	1105	Knife Holder Guide Bar
27572	1104	" " " " Bracket with 27574
310F	1105	Knife Holder Guide Bar Bracket Screw Centre
1516d	1105	Knife Holder Guide Bar Bracket Screw Centre Nut
27573	1105	Knife Holder Guide Bar Bracket Spring
27574	1105	" " " " " Hook
27659	1105	" " Stop Collar with 237F
237F	1105	" " " " Set Screw
27660	6255	" Position Pin for 27658
27660	6255	" " " (lower) for 27681 and 27682
11833	6255	Knife Position Pin (upper) for 27681 and 27682
261d	1105	Knife Regulating Thumb Screw
27662	1104	Wrench for 1508 and 1516
*60583	---	Knife Grinder, Nos. 261d, 1508c, 27323, 27564, 27565, 27567, 27569, 27572, 27573, 27659, 27822, two 27568 and four each 310F and 1516d

NO.	PLATE	NAME
27661	---	Knife Grinder complete, Nos. 27662, 60583, either 27658, 27681 or 27682 and three wood screws 1 in. No. 10

THREAD UNWINDERFOR TWO LARGE SPOOLS OR TWO LARGE CONES OF
THREAD

NO.	PLATE	NAME
27623	2837	Spool Pin
155c	5875	" " Set Screw
41530	2837	" Rest
41531	---	" " 41530 with 1149c and two each 155c and 27623
1149c	5875	Spool Rest Set Screw
27940	2837	" Stand with 453c
41514	2837	" Weight, 4 in. diam., with 41515
41515	5900	" " Centre Pin
27739	2837	Thread Cone (wood)
41631	2837	" Guard with 208E and two 41569
41569	5899	" " Eyelet
41637	2837	" " Rod (lower)
41638	2837	" " " (upper)
41639	2837	" " " Coupling with two 456c
456c	5899	" " " " Set Screw
41640	---	Thread Guard Rod complete, 30 in. long, Nos. 41637 to 41639
453c	5936	Thread Guard Rod Set Screw
208E	5899	" " Screw
41533	2837	Thread Unwinder complete, Nos. 27940, 41531, 41631, 41640, two each 27739, 41514 and three wood screws 1 in. No. 12

OBSOLETE PARTS

NO.	PLATE	NAME
52304	5948	Needle Bar (hollow)
52076	5869	Rotating Hook with 40274, 40398, two 1253c and three each 1053d and 1367d, use 52089
40398	5869	Rotating Hook Thread Guard
52091	---	Rotating Hook 52089 with 40408, for 96-13 and 96-14 Machines, use 52124
52124	---	Rotating Hook 52089 with 52442, for 96-13 and 96-14 Machines, use 52478
40431	---	Rotating Hook Bobbin Case, use 52472

OBSOLETE PARTS

NO.	PLATE	NAME
40395	5869	Rotating Hook Bobbin Case complete, Nos. 591e, 592e, 1380b, 2975, 40393, 40394 and 40431, use 52473.....
40408	---	Rotating Hook Bobbin Case 40395 with 40396, use 52442.....
52442	---	Rotating Hook Bobbin Case 40395 with 52443, use 52474.....
40396	5869	Rotating Hook Bobbin Case Holder, use 52443.....
52443	7700	Rotating Hook Bobbin Case Holder.....
52430	---	" " 52422 with 40408, for 96-15 Machine, use 52466.....
52466	---	Rotating Hook 52422 with 52442, for 96-15 Machine, use 52479.....
210958	5900	Thread Retaining Collar.....
210993	5900	" " Sleeve.....
52398	5900	" " Spring.....
52378	5900	" " Stud.....
52379	---	Thread Retainer complete, Nos. 52378, 52398, 210958 and 210993.....

NUMERICAL LIST OF PARTS
FOR
MACHINES
Nos. 96-13 to 96-15

NUMERICAL LIST OF PARTS

NO.	PLATE	NAME
	76D 5875	Lifting Lever Connecting Rod Joint Hinge Screw for 52319 and 52320.....
104D	7707	Knife Driving Lever Fork Swivel Screw for 52420.....
116E	5875	Arm Screw (back).....
121E	5899	" Shaft (horizontal) Gear Case Screw for 52071.....
121E	5899	Rotating Hook Shaft Gear Case Screw for 52072.....
144D	5875	Arm Shaft (horizontal) Screw.....
152F	2834	Bobbin Winder Stop Latch Finger Screw for 60456.....
155C	5875	Thread Unwinder Spool Pin Set Screw for 41531.....
157J	5897	Feed Lifting Rock Shaft Crank Clamping Screw for 12376.....
157J	5897	Feed Rock Shaft Crank Clamping Screw for 29633.....
158D	5899	Arm Top Cover Screw.....
158C	5943	Bed Frame Cushion Screw for 20067.....
171D	5899	Bobbin Winder Pulley Set Screw for 41585
176D	7701	Roller Arm Lock Spring Screw for 12265, 52414, 52457 to 52459 and 52461.....
178E	5875	Bell Crank Bracket Screw for 52319 and 52320.....
180D	5875	Bobbin Winder Tension Bracket Screw...
185H	5899	" " Stop Latch Tripping Arm Clamping Screw for 41588.....
190D	5875	Face Plate Screw.....
190D	5875	Roller Presser Screw.....
190D	5875	Tape Holder Set Screw for 26063.....
200F	2834	Bobbin Winder Pulley Set Screw for 41342
207D	2834	" " Frame Spring Screw for 60456.....
207E	5948	Needle Bar Connecting Stud Clamping Screw for 24041.....
208E	5899	Thread Unwinder Thread Guard Screw for 41631.....
210D	5875	Balance Wheel Oil Cover Screw.....
211F	5943	Bed Frame Hinge Connection Cap Screw for 19398.....
219D	5875	Arm Side Cap Screw.....
223C	5936	Slack Thread Regulator Screw for 52338

NO.	PLATE	NAME
226d	5900	Face Plate Thread Guard (lower) Screw for 52052.....
226d	5900	Face Plate Thread Guard (upper) Screw for 52052.....
229d	5948	Needle Bar Thread Guide Screw for 96-13 and 96-14 Machines.....
237F	1105	Knife Grinder Knife Holder Stop Collar Set Screw for 27659.....
242j	7707	Knife Driving Lever Shield Screw for 52428.....
261d	1105	Knife Grinder Knife Regulating Thumb Screw for 60583.....
286d	5875	Tape Holder Disc Thumb Screw for 26062
291F	7704	Strip Guide (adjustable) Thumb Screw for 120068.....
310F	1105	Knife Grinder Emery Wheel Shaft Screw Centre for 60583.....
310F	1105	Knife Grinder Knife Holder Guide Bar Bracket Screw Centre for 60583.....
313c	5875	Feed Bar Screw Centre.....
316F	7701	Roller Arm Bracket Screw Centre for 12265, 52414, 52457 to 52459 and 52461
356c	5875	Rock Shaft Knee Arm Hub Set Screw for 2766.....
356c	5875	Rock Shaft Knee Plate Set Screw for 2767
356c	5875	“ “ Lifting Bracket Hook Set Screw for 6337.....
356c	5875	Rock Shaft Lifting Bracket Set Screw for 6337.....
356c	5875	Rock Shaft Stop Dog Set Screw for 2770
375c	5897	Feed Connecting Link Hinge Screw.....
375c	5897	“ Forked Connection Hinge Screw...
375c	5897	“ Lifting Rock Shaft Connecting Rod Hinge Screw.....
386d	7701	Roller Screw for 1886 and 1896.....
388d	7709	“ “ “ 51824.....
389d	5942	Spool Holder Base Screw.....
418E	2834	Bobbin Winder Tension Screw Stud for 27308.....
432c	5898	Arm Shaft (upright) Bushing (lower) Set Screw.....
435c	5899	Arm Shaft (horizontal) Flanged Bushing (front) Set Screw.....
435c	5899	Thread Take-up Lever Link Hinge Pin Set Screw.....
440F	7701	Roller Arm Adjusting Screw for 12265, 52414, 52457 to 52459 and 52461.....

NO.	PLATE	NAME
446c	5899	Feed and Feed Lifting Eccentric Set Screw for 20283.....
448c	5875	Arm Shaft (horizontal) Flanged Bushing (back) Set Screw.....
448c	5875	Balance Wheel Set Screw for 52005 and 52081.....
448c	5875	Lifting Lever Pin Set Screw for 12237...
448c	5875	Thread Take-up Spring Regulator Set Screw.....
453c	5936	Presser Bar Guide Bracket Set Screw for 52338.....
453c	5936	Thread Unwinder Thread Guard Rod Set Screw for 27940.....
456c	5899	Thread Unwinder Thread Guard Rod Coupling Set Screw for 41639.....
457c	5899	Bobbin Winder Frame Hinge Pin Set Screw for 41583.....
457c	5899	Bobbin Winder Stop Latch Hinge Stud Set Screw for 41913.....
460c	7700	Bobbin Winder Tension Stud Set Screw for 41591.....
460c	7700	Thread Retainer Set Screw.....
591F	5869	Rotating Hook Bobbin Case Tension Regulating Screw for 40395 and 52473.....
592E	5869	Rotating Hook Bobbin Case Latch Stop Screw for 40395 and 52473.....
652d	7701	Roller Screw for 1903, 1923 and 1986.....
665E	7710	Bed Slide Spring Screw for 52418.....
688J	5875	Pressure Regulating Thumb Screw.....
689c	5936	Presser Bar Lifter Screw.....
691F	5875	Throat Plate Screw for 96-13 and 96-14 Machines.....
704J	5869	Rotating Hook Bobbin Case Holder Position Bracket Screw.....
725E	5875	Bed Slide Spring Screw for 12432.....
732d	5875	Guide Thumb Screw for 96-13 Machine..
756J	7707	Knife Driving Lever Centre Plate Screw for 52428.....
766d	5875	Lifting Lever Link Hinge Screw for 52319 and 52320.....
775E	5948	Needle Bar Connecting Link Cap Screw..
794E	5948	“ “ “ “ Adjusting Screw for 24040.....
802d	5875	Lifting Lever Hinge Screw for 52319 and 52320.....
808F	5948	Needle Clamp Screw for 52307.....

NO.	PLATE	NAME
818D	5897	Feed Regulator Thumb Screw.....
854E	5942	Arm Screw (front).....
857H	7710	Needle Set Screw for 52468.....
858C	5875	" Bar Crank Set Screw for 24052...
880E	5899	Bobbin Winder Screw for 41915.....
886C	7707	Knife Holder Adjusting Screw Binding Screw for 24188.....
899D	1105	Knife Grinder Knife Clamping Screw for 27658, 27681 and 27682.....
934D	7707	Knife Driving Lever Centre Plate Cap Screw for 52428.....
934J	7707	Throat Plate Needle Hole Strip Screw for 52428.....
966E	5899	Feed Lifting Rock Shaft Connecting Rod Cap Screw for 12430.....
1036C	5948	Arm Shaft (horizontal) Gear Set Screw for 52060.....
1036C	5948	Thread Take-up Crank Set Screw for 24052.....
1037C	5948	Thread Take-up Crank Position Screw for 24052.....
1053D	5869	Rotating Hook Thread Guard Screw for 52076, 52123 and 52471.....
1065C	5875	Needle Bar Crank Position Screw for 24052.....
1094F	7707	Throat Plate Screw for 96-15 Machine...
1095K	7707	Knife Holder Screw for 52428.....
1096F	7706	" Screw for 24165, 24167, 24587, 24606 and 24608.....
1097K	7707	Knife Holder Stop Screw for 52428.....
1098C	7707	" " Adjusting Screw for 24188
1128E	5897	Feed Regulator Hinge Screw.....
1133E	5948	Needle Bar Bushing (lower) Set Screw...
1133E	5948	" " " (upper) Set Screw...
1143C	7700	Rotating Hook Shaft Bushing (back) Set Screw.....
1148C	5898	Rotating Hook Shaft Bushing (front) Set Screw.....
1149C	5875	Arm Shaft (upright) Bushing (upper) Set Screw.....
1149C	5875	Thread Unwinder Spool Rest Set Screw for 41531.....
1253C	5869	Arm Shaft (upright) Gear (lower) Set Screw for 56013.....
1253C	5869	Arm Shaft (upright) Gear (upper) Set Screw for 56101.....

NO.	PLATE	NAME
1253C	5869	Rotating Hook Set Screw for 52076 and 52089.....
1253C	5869	Rotating Hook Shaft Gear Set Screw for 56013.....
1367D	5869	Rotating Hook Section Screw for 52076, 52089 and 52422.....
1380D	5869	Rotating Hook Bobbin Case Tension Spring Screw for 40395 and 52473.....
1423D	7704	Strip Guide Screw for 96-14 Machine....
1429D	2834	Bobbin Winder Frame Hinge Screw for 60456.....
1430D	2834	Bobbin Winder Stop Latch Hinge Screw for 60456.....
1430D	2834	Bobbin Winder Stop Latch Lever Hinge Screw for 60456.....
1508C	1105	Knife Grinder Emery Wheel Clamping Nut for 60583.....
1513J	5942	Feed Lifting Rock Shaft Screw Centre Nut
1513J	5942	" Rock Shaft Screw Centre Nut.....
1516D	1105	Knife Grinder Emery Wheel Shaft Screw Centre Nut for 60583.....
1516D	1105	Knife Grinder Knife Holder Guide Bar Bracket Screw Centre Nut for 60583...
1518E	5897	Feed Connecting Link Hinge Screw Nut
1518E	5897	" Forked Connection Hinge Screw Nut
1518E	5897	" Lifting Rock Shaft Connecting Rod Hinge Screw Nut.....
1519E	5942	Feed Bar Screw Centre Nut.....
1520E	5936	Presser Bar Lifter Screw Nut.....
1521E	5942	Lifting Lever Connecting Rod Lock Nut for 52319 and 52320.....
1528D	7701	Roller Screw Nut for 1886, 1896, 1903, 1923 and 1986.....
1517J	7701	Roller Arm Adjusting Screw Nut for 12265, 52414, 52457 to 52459 and 52461
1517J	7701	Roller Arm Bracket Screw Centre Nut for 12265, 52414, 52457 to 52459 and 52461.....
1549J	7701	Roller Arm Lock Spring Screw Nut for 12265, 52414, 52457 to 52459 and 52461
1550H	2834	Bobbin Winder Stop Latch Hinge Screw Nut for 60456.....
1550H	7709	Roller Screw Nut for 51824.....
1560C	7700	Tension Regulating Thumb Nut for 52397
1562J	2834	Bobbin Winder Tension Regulating Thumb Nut for 27308.....

NO.	PLATE	NAME
1813	5897	Feed Lifting Rock Shaft Crank Roller and Stud for 12376.....
1886	7709	Roller, 1¼ in. diam., coarse, with 386d and 1528d, for 52458.....
1896	7701	Roller, ¾ in. diam., fine, with 386d and 1528d, for 12265.....
1903	7701	Roller, 1¼ in. diam., coarse, with 652d and 1528d, for 52414.....
1923	7709	Roller, 1¼ in. diam., coarse, with 652d and 1528d, for 52459.....
1986	7709	Roller, ¾ in. diam., fine, with 652d and 1528d, for 52461.....
2102	7700	Tension Disc for 52397 and 225462.....
2103	5899	" Spring for 52397.....
2106	2834	Bobbin Winder Tension Thread Guide for 27308.....
2205	7701	Roller Arm Lock Spring for 12265, 52414, 52457 to 52459 and 52461.....
2206	7701	Roller Arm Bracket for 12265, 52457 and 52461.....
2455	2834	Bobbin Winder Tension Disc for 27308 and 41592.....
2763	819	Rock Shaft for 4880 and 12250..... Nos. 2765 to 2767 FOR 2768
2765	7711	Rock Shaft Knee Arm.....
2766	7711	" " " " Hub with 356c....
2767	7711	" " " " Plate with 356c.....
2768	-----	Rock Shaft Knee Arm complete for 12250, Nos. 2765 to 2767.....
2770	819	Rock Shaft Stop Dog with 356c, for 4880 and 12250.....
2778	7711	Rock Shaft Lifting Bracket Hook for 12250.....
2974	5869	Rotating Hook Bobbin Case Latch Lever Fulcrum Pin for 40393.....
2975	5869	Rotating Hook Bobbin Case Latch Spring for 40395 and 52473.....
3033	5897	Feed Connecting Link.....
4282	7701	Roller Arm Bracket for 52414 and 52458.....
4307	5891	Bed Slide Spring for 12432.....
4822	5901	Wrench for 1528, 1547 and 1549 (Accessories).....
4879	5947	Chain Connecting Link for 4885.....
4880	819	Rock Shaft complete for 52319, Nos. 2763, 2770, 7125, 12243 and two each 6337 and 12242.....

NO.	PLATE	NAME
Nos. 4881 TO 4884 FOR 4885		
4881	819	Treadle.....
4882	5947	" Shaft.....
4883	5947	" Spring.....
4884	819	" Stand.....
4885	819	Treadle complete for 52319, Nos. 4879, 4881 to 4884 and two wood screws 1 in. No. 16.....
5596	5947	Bell Crank for 56848.....
5598	5947	Bell Crank complete for 52319 and 52320, Nos. 5735 and 56848.....
5599	5947	Bell Crank Bracket for 56848.....
5601	5943	" " Hinge Pin for 56848.....
5670	-----	Chain, length, 26 in. to 35 in., for 52319..
5735	5943	Ball Crank Spring for 5598.....
6337	819	Rock Shaft Lifting Bracket with two 356c, for 4880 and 12250.....
7125	819	Rock Shaft Lifting Bracket Hook for 4880
7539	7711	Rock Shaft Hanger with two wood screws 1 in. No. 10, for 12250.....
7958	7700	Bobbin Winder Stop Latch Stop Pin for 41915.....
8879	5936	Arm Spool Pin Washer (cloth).....
8879	5936	Bobbin Winder Tension Bracket Spool Pin Washer (cloth) for 41916.....
8908	5901	Wrench for 1519 and 1520 (Accessories)..
8909	5901	" " 1513 and 1518 (Accessories)..
9331	2834	Bobbin Winder Washer for 41347.....
10141	2834	" " Tension Spring for 27308
11119	5900	Arm Oil Tube with 29599, for oiling 52022
11167	5896	Presser Bar Spring.....
11170	5936	" " " Washer.....
11204	5948	Thread Take-up Lever Link Hinge Pin...
11241	2833	Bobbin Winder Spool Washer (cloth) for 27308.....
11833	6255	Knife Grinder Knife Position Pin (upper) for 27681 and 27682.....
12193	5894	Arm Side Cover.....
*12204	-----	Feed Lifting Rock Shaft Connecting Rod Cap for 12430.....
12237	5946	Lifting Lever with 448c, for 52319 and 52320.....
12240	5936	Lifting Lever Pin for 52319 and 52320...
12241	5936	" " Link for 52319 and 52320..
12242	819	Rock Shaft Hanger with two wood screws 1 in. No. 10, for 4880.....

NO.	PLATE	NAME
12243	819	Rock Shaft Lifting Bracket Hook for 4880
12250	7711	Rock Shaft complete for 52320, Nos. 2763, 2768, 2778, 6337 and two each 2770 and 7539
12256	7701	Roller Arm for 12265
12257	7709	" " " 52459
12265	7701	Roller Presser complete, $\frac{7}{8}$ in. fine roller, for 96-13 Machine, Nos. 176b, 440f, 1549j, 1896, 2205, 2206, 12256, two 316f and three 1547j
12327	5936	Presser Bar Lifting and Releasing Lever Bracket
12329	5936	Tension Releasing Lever Spring
12361	5943	Machine Hinge Connection for 44140
12376	5897	Feed Lifting Rock Shaft Crank with 157j and 1813, for 52385
12391	5896	Presser Bar (hollow)
12398	5936	Tension Releasing Lever Hinge Pin
12403	5900	Arm Spool Pin and Thread Eyelet for 52043
12403	5900	Bobbin Winder Tension Bracket Spool Pin and Thread Eyelet for 41592
12405	5943	Machine Rest, felt (Accessories)
12416	5936	Lifting Lever Connecting Rod Joint for 52319 and 52320
12430	5896	Feed Lifting Rock Shaft Connecting Rod with 12204 and two 966e
12431	---	Bed Slide for 12432
12432	5894	Bed Slide complete for 96-13 and 96-15 Machines, Nos. 4307, 12431 and two 725e
12436	7699	Feed Dog for 96-13 and 96-14 Machines
12438	7699	Throat Plate, large oblong needle hole, for 96-14 Machine
12454	5900	Arm Oil Tube with 29599, for oiling 52024
12480	5894	" Side Cap
14010	5943	Bed Frame Hinge Plate Rivet for 20067
16532	5900	Arm Dowel Pin
16555	5943	Bed Frame Hinge Plate for 20067
19219	5943	" " Cushion (leather) for 20067
19220	5943	" " Cushion Spring for 20067
19226	5943	" " Hinge Connection for 19398
19397	5943	" " " " Cap for 19398
19398	---	Bed Frame Hinge Connection 19226 with 211e and 19397, for 20067

NO.	PLATE	NAME
20067	819	Bed Frame with two each 16555, 19398, four each 19219, 19220, six each 14010, wood screws $1\frac{1}{4}$ in. No. 12 and eight 158c
20192	---	Throat Plate, small oblong needle hole, for 96-14 Machine
20283	5947	Feed and Feed Lifting Eccentric with 446c
20284	5947	" Forked Connection
24036	5896	" and Feed Lifting Eccentric Sleeve
24040	5948	Needle Bar Connecting Link with 794e
24041	5948	" " " Stud with 207e
24052	5947	" " Crank with 858c, 1036c, 1037c and 1065c
24131	5900	Arm Oil Tube with 29599, for oiling 24036
24131	5900	" " " " " " " 12430 for 52043
24131	5900	Bobbin Winder Tension Bracket Oil Tube with 29599, for 41592
24162	7705	Feed Dog, 10 teeth (16 teeth to the inch) for 52425
24164	7706	Knife with Guide (corner bent up) for under trimming, for 24165
24165	---	Knife with Guide (corner bent up) and Holder (sectional) complete, for under trimming, for 52428, Nos. 24164, 24174 and two 1096e
24166	7706	Knife, for edge trimming, for 24167 and 52425
24167	---	Knife and Holder (sectional) complete, for edge trimming, for 96-15 Machine, Nos. 24166, 24174 and two 1096e
24168	7707	Knife Driving Lever with 24177, for 52420
24170	7707	" " " Centre Plate for 52428
24171	7707	" " " " " Cap for 52428
24173	7707	Knife Driving Lever Fork Swivel for 52420
24174	7706	" Holder for 24165, 24167, 24587, 24606 and 24608
24175	7707	Knife Holder Bushing for 52428
24176	7707	" " Position Spring for 52428
24177	7707	" " " Stud for 24168
24180	---	Throat Plate Body for 52428
24188	---	Knife Holder Regulator for 52428, Nos. 886c and 1098c
24334	7707	Knife Driving Lever Shield for 52428
24336	7705	Throat Plate Needle Hole Strip, large oblong needle hole, for 52428

NO.	PLATE	NAME
24337	—	Throat Plate Needle Hole Strip, small oblong needle hole, for 52428.....
24443	7699	Throat Plate, small oblong needle hole, for 96-13 Machine.....
24444	—	Throat Plate, large oblong needle hole, for 96-13 Machine.....
24586	7706	Knife without Guide (corner bent up) for under trimming, for 24587.....
24587	—	Knife without Guide (corner bent up) and Holder (sectional) complete, for under trimming, for 96-15 Machine, Nos. 24174, 24586 and two 1096F.....
24605	7706	Knife with Guide (corner flush with top) for under trimming, for 24606.....
24606	—	Knife with Guide (corner flush with top) and Holder (sectional) complete, for under trimming, for 96-15 Machine, Nos. 24174, 24605 and two 1096F.....
24607	7706	Knife without Guide (corner flush with top) for under trimming, for 24608.....
24608	—	Knife without Guide (corner flush with top) and Holder (sectional) complete, for under trimming, for 96-15 Machine, Nos. 24174, 24607 and two 1096F.....
25446	5900	Bobbin Winder Screw Washer for 41915.....
25886	6449	Guide for 96-13 Machine.....
26026	5901	Screw Driver, large (Accessories).....
26061	7708	Tape Holder Bracket Wire with Disc for 26063.....
26062	7708	Tape Holder Disc (adjustable) with 286D and 35925, for 26063.....
26063	7708	Tape Holder (straight) 8 in. disc, complete, for 96-14 Machine, Nos. 26061 and 26062.....
26485	5901	Screw Driver, small (Accessories).....
27306	2834	Bobbin Winder Spool Pin for 27308.....
27307	2833	" " " Stand for 27308.....
27308	2833	Bobbin Winder Spool Stand complete for 41348, Nos. 418E, 1562J, 2106, 10141, 11241, 27306, 27307 and two each 2455 and wood screws 1 in. No. 10.....
27323	1105	Knife Grinder Knife Holder Guide Bar for 60583.....
27564	1104	Knife Grinder Frame with 27574, for 60583.....
27565	1104	" " Emery Wheel, 2 in. diam., for 60583.....

NO.	PLATE	NAME
Nos. 27567 to 27569 FOR 60583		
27567	1105	Knife Grinder Emery Wheel Shaft.....
27568	1105	" " " " Oil Hole Cover (rubber).....
27569	1105	Knife Grinder Emery Wheel Shaft Pulley.....
27572	1104	" " Knife Holder Guide Bar Bracket with 27574, for 60583.....
27573	1105	Knife Grinder Knife Holder Guide Bar Bracket Spring for 60583.....
27574	1105	Knife Grinder Knife Holder Guide Bar Bracket Spring Hook for 27564 and 27572.....
27623	2837	Thread Unwinder Spool Pin for 41531.....
27657	—	Knife Grinder Knife Holder Body for 27658.....
27658	1105	Knife Grinder Knife Holder complete for 27661, Nos. 899D, 27657 and 27660.....
27659	1105	Knife Grinder Knife Holder Stop Collar with 237F, for 60583.....
27660	6255	Knife Grinder Knife Position Pin for 27658.....
27660	6255	" " " " " (lower) for 27681 and 27682.....
27661	—	Knife Grinder complete for 96-15 Machine, Nos. 27662, 60583, either 27658, 27681 or 27682 and three wood screws 1 in. No. 10.....
27662	1104	Wrench for 1508 and 1516 for 27661.....
27679	—	Knife Grinder Knife Holder Body for 27681.....
27680	—	Knife Grinder Knife Holder Body for 27682.....
27681	6255	Knife Grinder Knife Holder complete for 24164, 24166, 24586, 24605 and 24607 for 27661, Nos. 899D, 11833, 27660 and 27679.....
27682	6255	Knife Grinder Knife Holder complete for 27661, Nos. 899D, 11833, 27660 and 27680.....
27739	2837	Thread Unwinder Thread Cone (wood) for 41533.....
27822	1105	Knife Grinder Emery Wheel Clamping Nut Washer for 60583.....
27940	2837	Thread Unwinder Spool Stand with 453C, for 41533.....
28084	—	Machine Rest Pin (Accessories).....
29532	5948	Needle Bar Oil Cup for 52305.....

NO.	PLATE	NAME
29599	5900	Arm Oil Tube Packing (felt) for 11119, 12454, 24131 and 52084.....
29599	5900	Bobbin Winder Tension Bracket Oil Tube Packing (felt) for 24131.....
29633	5897	Feed Rock Shaft Crank with 1574, for 52387.....
32572	7700*	Tension Releasing Disc for 52397.....
32574	7700	" " Pin for 52397.....
34105	5902	Bobbin Winder Frame Hinge Pin for 41915.....
35925	-----	Tape Holder Disc Hub for 26062.....
36578	5901	Oiler (copper plated) with 36579 (Accessories).....
36579	5901	Oiler Spout, 3 1/2 in. long, with 120117, for 36578.....
40264	5869	Rotating Hook Bobbin.....
40274	5869	" " Section for 52076, 52089 and 52422.....
40392	5869	Rotating Hook Bobbin Case Latch for 40393.....
40393	-----	Rotating Hook Bobbin Case Hinge for 40395 and 52473, Nos. 2974, 40392 and 40409.....
40394	5869	Rotating Hook Bobbin Case Tension Spring for 40395 and 52473.....
40395	5869	Rotating Hook Bobbin Case complete, Nos. 591F, 592E, 1380D, 2975, 40393, 40394 and 40431, obsolete, use 52473.....
40396	5869	Rotating Hook Bobbin Case Holder for 40408, obsolete, use 52443.....
40398	5869	Rotating Hook Thread Guard for 52076, obsolete.....
40408	---	Rotating Hook Bobbin Case 40395 with 40396, for 52091, obsolete, use 52442.....
40409	5869	Rotating Hook Bobbin Case Latch Lever for 40393.....
40431	---	Rotating Hook Bobbin Case for 40395, obsolete, use 52472.....
		Nos. 41339 to 41346 for 60456
41339	2833	Bobbin Winder Base.....
41340	2833	" " Frame.....
41341	2833	" " Spring.....
41342	2833	" " Pulley with 200F.....
41343	2834	" " Spindle.....
41344	2834	" " Stop Latch.....
41345	2834	" " " " Finger.....
41346	2834	" " " " Lever.....

NO.	PLATE	NAME
41347	2833	Bobbin Winder for 41348, Nos. 60456 and two each 9331 and wood screws 1 in. No. 10 R. H. B.....
41348	---	Bobbin Winder (swinging automatic, right hand) complete, Nos. 27308 and 41347.....
41514	2837	Thread Unwinder Spool Weight, 4 in. diam., with 41515, for 41533.....
41515	5900	Thread Unwinder Spool Weight Centre Pin for 41514.....
41530	2837	Thread Unwinder Spool Rest for 41531.....
41531	---	" " " " 41530 with 1149c and two each 155c and 27623, for 41533.....
41533	2837	Thread Unwinder complete, for two large spools or two large cones of thread, Nos. 27940, 41531, 41631, 41640, two each 27739, 41514 and three wood screws 1 in. No. 12.....
41569	5899	Thread Unwinder Thread Guard Eyelet for 41631.....
41583	5902	Bobbin Winder Frame with 457c, for 41915.....
		Nos. 41585 to 41588 for 41915
41585	5902	Bobbin Winder Pulley with 171D.....
41586	5902	" " Spindle.....
41587	5902	" " Stop Latch.....
41588	5902	" " " " Tripping Arm with 185H.....
41591	5902	Bobbin Winder Tension Bracket with 460c, for 41592.....
41592	5902	Bobbin Winder Tension Bracket complete for 41916, Nos. 12403, 24131, 41591, 41593 to 41595 and two 2455.....
		Nos. 41593 to 41595 for 41592
41593	5936	Bobbin Winder Tension Spring.....
41594	5936	" " " Stud.....
41595	5936	" " " Thread Guide.....
41631	2837	Thread Unwinder Thread Guard with 208E and two 41569, for 41533.....
		Nos. 41637 to 41639 for 41640
41637	2837	Thread Unwinder Thread Guard Rod (lower).....
41638	2837	Thread Unwinder Thread Guard Rod (upper).....

NO.	PLATE	NAME
41639	2837	Thread Unwinder Thread Guard Rod Coupling with two 456c.....
41640	----	Thread Unwinder Thread Guard Rod complete for 41533, 30 in. long, Nos. 41637 to 41639.....
41913	5902	Bobbin Winder Bracket with 457c, for 41915.....
41914	5902	Bobbin Winder Frame Spring for 41915..
41915	5902	Bobbin Winder for 41916, Nos. 880e, 7958, 25446, 34105, 41583, 41585 to 41588, 41913, 41914 and 42614.....
41916	----	Bobbin Winder (swinging automatic, left hand) complete, Nos. 41592 and 41915
42614	5902	Bobbin Winder Stop Latch Hinge Stud for 41915.....
43944	5936	Tension Releasing Lever.....
44139	5943	Machine Hinge Plate for 44140.....
44140	----	Machine Hinge complete, Nos. 12361, 44139 and wood screw 1¼ in. No. 14 (Accessories).....
44212	7711	Drip Pan with four 1 in. wire nails.....
46037	7709	Roller Bracket for 52459.....
50053b	5899	Arm Side Cover Thumb Screw.....
50083c	5897	Feed Connecting Link Hinge Stud Set Screw for 52074.....
50117e	5875	Feed Dog Screw.....
50169b	7704	Strip Guide (adjustable) Bar Plate Screw for 120071.....
50169b	7704	Strip Guide (adjustable) Bar Screw for 120071.....
50190b	5899	Edge Guide Thumb Screw for 96-14 Machine.....
50190b	5899	Face Plate Thumb Screw.....
50191c	5899	Feed Lifting Rock Shaft Screw Centre...
50191c	5899	" Rock Shaft Screw Centre.....
50234b	5899	Arm Shaft (horizontal) Gear Case Plug Screw for 52071.....
50234b	5899	Rotating Hook Shaft Gear Case Plug Screw for 52072.....
50304c	5899	Tension Stud for 52397.....
50305c	5899	" " Set Screw for 52083.....
50429c	7700	Rotating Hook Set Screw for 52422.....
51824	7709	Roller, ⅝ in. diam., coarse, with 388b and 1550n, for 52457.....
52005	5893	Balance Wheel (power) light rim, 2 ⅜ in. pulley, with two 448c.....
52014	5948	Needle Bar Bushing (upper).....

NO.	PLATE	NAME
52016	5936	Presser Bar Lifter.....
52018	5869	Rotating Hook Bobbin Case Holder Position Bracket.....
52021	5948	Thread Take-up Crank.....
		Nos. 52022 to 52024 for 52025
52022	5948	Thread Take-up Lever with 52130.....
52023	5948	" " " Hinge Pin.....
52024	5948	" " " Link.....
52025	----	Thread Take-up Lever complete, Nos. 52022 to 52024.....
52027	7700	Thread Guard (side of arm).....
52028	5947	Lifting Lever Connecting Rod for 52319 and 52320.....
52042	5896	Arm Top Cover for 52043.....
52043	5896	" " " 52042 with 12403 and 24131.....
52045	5898	Rotating Hook Shaft Bushing (back) Packing (cotton).....
52045	5898	Rotating Hook Shaft Bushing (front) Packing (cotton).....
52046	5947	Spool Holder Base for 52047.....
52047	5947	Spool Holder complete, Nos. 52046, 200079n and 204296.....
52051	----	Face Plate for 52052.....
52052	5894	Face Plate complete, Nos. 52051, 52053, 56086 and two 220b.....
52053	5900	Face Plate Thread Guard (lower) for 52052.....
52059	5894	Arm Shaft (horizontal) Flanged Bushing (back).....
52060	5898	Arm Shaft (horizontal) Gear with two 1036c.....
52062	5898	Arm Shaft (upright).....
52063	5894	Balance Wheel Oil Cover.....
52071	5894	Arm Shaft (horizontal) Gear Case (two pieces) with 121e and 50234b.....
52072	5894	Rotating Hook Shaft Gear Case (two pieces) with 121e and 50234b.....
52073	5897	Feed Connecting Link Hinge Stud.....
52074	5897	" Regulator with 50083c.....
52076	5869	Rotating Hook with 40274, 40398, two 1253c and three each 1053b and 1367b, obsolete, use 52089.....
52078	5894	Arm Shaft (horizontal) Flanged Bushing (front).....

NO.	PLATE	NAME
52081	5893	Balance Wheel (stand) heavy rim, 2 1/4 in. pulley, with two 448c.....
52083	5899	Thread Take-up Spring Regulator with 50305c, for 52397.....
52084	5900	Arm Oil Tube with 29599, for oiling 24010
52089	5898	Rotating Hook 52123 with 40274 and three each 1253c and 1367d, for 52091, 52124 and 52478.....
52090	5898	Rotating Hook Thread Guard for 52123 and 52471.....
*52091	---	Rotating Hook 52089 with 40408, for 96-13 and 96-14 Machines, obsolete, use 52124
52121	---	Rotating Hook for 52123.....
52123	---	" " 52121 with 52090 and four 1053b, for 52089.....
52124	---	Rotating Hook 52089 with 52442, for 96-13 and 96-14 Machines, obsolete, use 52478.....
52130	5948	Thread Take-up Lever Thread Eyelet Bushing for 52022.....
52304	5948	Needle Bar (hollow) obsolete.....
52305	5948	" " Bushing (lower) with 29532..
52307	5948	" Clamp with 808F, for 96-13 and 96-14 Machines.....
52319	---	Foot Lifter complete, Nos. 76d, 766d, 802d, 1521E, 4880, 4885, 5598, 5670, 12237, 12240, 12241, 12416, 52028 and two 178E.....
52320	---	Knee Lifter complete (power table) Nos. 76d, 766d, 802d, 1521E, 5598, 12237, 12240, 12241, 12250, 12416, 52028 and two 178E.....
52337	5936	Slack Thread Regulator.....
52338	5936	Presser Bar Guide Bracket with 223c and 453c.....
52359	5948	Feed Regulator Thumb Screw Stop.....
52378	5900	Thread Retaining Stud for 52379, obsolete
52379	---	Thread Retainer complete, Nos. 52378, 52398, 210958 and 210993, obsolete...
*52381	---	Arm with two 56015, for 96-13 and 96-15 Machines.....
52382	5946	Arm Shaft (horizontal).....
*52383	---	Bed for 96-13 and 96-14 Machines.....
52384	5946	Feed Lifting Rock Shaft for 52385.....
52385	---	Feed Lifting Rock Shaft complete, Nos. 12376 and 52384.....
52386	5946	Feed Rock Shaft for 52387.....

NO.	PLATE	NAME
52387	---	Feed Rock Shaft complete, Nos. 29633 and 52386.....
52388	5946	Rotating Hook Shaft for 96-13 and 96-14 Machines.....
52394	5948	Thread Take-up Spring for 52397.....
52397	---	Tension complete, Nos. 1560c, 2103, 32572, 32574, 50304c, 52083, 52394 and two 2102.....
52398	5900	Thread Retaining Spring for 52379, obsolete.....
52414	7701	Roller Presser complete, 1 1/4 in. coarse roller, for 96-14 and 96-15 Machines, Nos. 176d, 440F, 1549J, 1903, 2205, 4282, 52453, two 316F and three 1547J
52415	7700	Needle Bar Thread Guard for 96-13 and 96-14 Machines.....
*52416	---	Arm with two 56015, for 96-14 Machine..
52417	---	Bed Slide for 52418.....
52418	7702	Bed Slide complete for 96-14 Machine, Nos. 52417, 52464 and two 665E.....
*52419	---	Bed for 96-15 Machine.....
52420	---	Knife Driving Lever complete for 52428, Nos. 104d, 24168, 24173 and 52421....
52421	7707	Knife Driving Lever Fork for 52420.....
52422	7700	Rotating Hook 52471 with 40274, 50429c and three 1367d, for 52430, 52466 and 52479.....
52423	7700	Rotating Hook Key for 52424.....
52424	7702	" " Shaft with 52423, for 96-15 Machine.....
52425	7705	Throat Plate with Trimming Attachment complete for 96-15 Machine, Nos. 24162, 24166 and 52428.....
52428	---	Throat Plate with Trimming Attachment for 52425, Nos. 1095k, 1097k, 24165, 24170, 24175, 24176, 24180, 24188, 24334, 24336 or 24337, 52420, two each 242j, 756j, 24171 and six 934j.....
52430	---	Rotating Hook 52422 with 40408, for 96-15 Machine, obsolete, use 52466...
52442	---	Rotating Hook Bobbin Case 40395 with 52443, for 52466, obsolete, use 52474..
52443	7700	Rotating Hook Bobbin Case Holder for 52442, obsolete.....
52452	5896	Feed Bar.....
52453	7701	Roller Arm for 52414 and 52458.....
52454	5900	Thread Retainer.....

NO.	PLATE	NAME
52455	7700	Needle Bar (hollow) for 96-13 and 96-14 Machines
52456	7709	Roller Arm for 52457
52457	—	Roller Presser complete, $\frac{9}{16}$ in. coarse roller, Nos. 176D, 440F, 1549J, 2205, 2206, 51824, 52456, two 316F and three 1547J
52458	7709	Roller Presser complete, $1\frac{1}{4}$ in. coarse roller, for 96-14 Machine, Nos. 176D, 440F, 1549J, 1886, 2205, 4282, 52453, two 316F and three 1547J
52459	7709	Roller Presser complete, $1\frac{1}{4}$ in. coarse roller, for 96-15 Machine, Nos. 176D, 440F, 1549J, 1923, 2205, 12257, 46037, two 316F and three 1547J
52460	7709	Roller Arm for 52461
52461	7709	Roller Presser complete, $\frac{7}{8}$ in. fine roller, Nos. 176D, 440F, 1549J, 1986, 2205, 2206, 52460, two 316F and three 1547J
52464	7710	Bed Slide Spring for 52418
52466	—	Rotating Hook 52422 with 52442, for 96-15 Machine, obsolete, use 52479
52468	7710	Needle Bar (hollow) with 857H, for 96-15 Machine
52470	—	Rotating Hook for 52471
52471	—	“ “ 52470 with 52090 and four 1053D, for 52422
52472	—	Rotating Hook Bobbin Case for 52473
52473	7710	Rotating Hook Bobbin Case complete for 52474, Nos. 591F, 592E, 1380D, 2975, 40393, 40394 and 52472
52474	—	Rotating Hook Bobbin Case 52473 with 52477, for 52478 and 52479
*52475	—	Rotating Hook Bobbin Case Location Plate for 52477
*52476	—	Rotating Hook Bobbin Case Location Plate Rivet for 52477
52477	7710	Rotating Hook Bobbin Case Holder with 52475 and two 52476, for 52474
52478	—	Rotating Hook 52089 with 52474, for 96-13 and 96-14 Machines
52479	—	Rotating Hook 52422 with 52474, for 96-15 Machine
54897	5900	Arm Shaft (horizontal) Front Bearing Oil Cup
56006	5900	Arm Shaft (horizontal) Flanged Bushing (back) Oil Pad (braided cotton)

NO.	PLATE	NAME
56006	5900	Arm Shaft (horizontal) Flanged Bushing (front) Oil Pad (braided cotton)
56013	5898	Arm Shaft (upright) Gear (lower) with two 1253c
56013	5898	Rotating Hook Shaft Gear with two 1253c
56015	5900	Arm Shaft (upright) Oil Tube (lower) for 52381 and 52416
56015	5900	Arm Shaft (upright) Oil Tube (upper) for 52381 and 52416
56086	5900	Face Plate Thread Guard (upper) for 52052
56099	5898	Arm Shaft (upright) Bushing (lower)
56100	5898	“ “ “ “ (upper)
56101	5898	“ “ “ “ Gear (upper) with two 1253c
56106	5898	Rotating Hook Shaft Bushing (back)
56107	5898	“ “ “ “ (front)
56848	—	Bell Crank 5596 with 5599 and 5601, for 5598
60456	—	Bobbin Winder for 41347, Nos. 152F, 207D, 1429D, 1550H, 41339 to 41346 and three 1430D
*60583	—	Knife Grinder for 27661, Nos. 261D, 1508C, 27323, 27564, 27565, 27567, 27569, 27572, 27573, 27659, 27822, two 27568 and four each 310F and 1516D
120063	7703	Edge Guide for 96-14 Machine Nos. 120067 to 120070 for 120071
120067	7704	Strip Guide
120008	7704	“ “ (adjustable) with 291F
120069	7704	“ “ “ “ Bar
120070	7704	“ “ “ “ Plate
120071	7704	Strip Guide (adjustable) complete for 96-14 Machine, Nos. 120067 to 120070 and six 50169D
120117	5901	Oiler Spout Washer (leather) for 36579
200056E	3471	Bobbin Winder Stop Latch Screw for 225436
200079H	5942	Spool Holder Base Wire Hinge Screw for 52047
200082D	3471	Bobbin Winder Tension Bracket Screw for 225436
200299H	3471	Bobbin Winder Stop Latch Trip Lever Hinge Screw for 225436
200380C	3471	Bobbin Winder Pulley Set Screw for 202473

NO.	PLATE	NAME
201499b	3471	Bobbin Winder Tension Stud for 225461
201572b	3471	" " " " Thumb Nut for 225462.....
202104	3471	Bobbin Winder Tension Bracket Screw Washer for 225436.....
202277	3471	Bobbin Winder Frame Oil Packing (wick) for 225453.....
202407	3471	Bobbin Winder Tension Spring for 225462
202473	3470	" " Pulley with 200380c, for 225436.....
202478	3471	Bobbin Winder Stop Latch Trip Lever for 225436.....
204296	5947	Spool Holder Base Wire for 52047.....
210958	5900	Thread Retaining Collar for 52379, obso- lete.....
210993	5900	Thread Retaining Sleeve for 52379, obso- lete.....
225436	3469	Bobbin Winder (swinging automatic, right hand) complete, for power table, Nos. 200056e, 200082b, 200299u, 202104, 202473, 202478, 225444, 225452 to 225456, 225458 to 225460, 225462, 225463 and two wood screws 3/4 in. No. 13 R. H. B.....
225438	3471	Bobbin Winder Frame Oil Well Cap for 225453.....
*225443	---	Bobbin Winder Spindle for 225452.....
225444	3471	" " Stop Latch for 225436....
*225451	---	" " Bobbin Holder for 225452
Nos. 225452 to 225456 for 225436		
225452	3470	Bobbin Winder Spindle 225443 with 225451.....
225453	3470	Bobbin Winder Frame with 202277 and 225438.....
225454	3471	Bobbin Winder Frame Hinge Pin.....
225455	3471	" " " Spring.....
225456	3471	" " " " Plunger....
Nos. 225458 to 225460 for 225436		
225458	3471	Bobbin Winder Stop Latch Thumb Lever
225459	3471	" " " " " "
		Hinge Stud.....
225460	3471	Bobbin Winder Stop Latch Thumb Lever Joint Stud.....
225461	3471	Bobbin Winder Tension Bracket with 201499b, for 225462.....

NO.	PLATE	NAME
225462	---	Bobbin Winder Tension Bracket complete for 225436, Nos. 201572b, 202407, 225461 and two 2102.....
225463	3469	Bobbin Winder and Tension Bracket Base for 225436.....

ILLUSTRATIONS OF PARTS

FOR

MACHINES

Nos. 96-13 to 96-15

PLATE 819—ONE-FOURTH SIZE

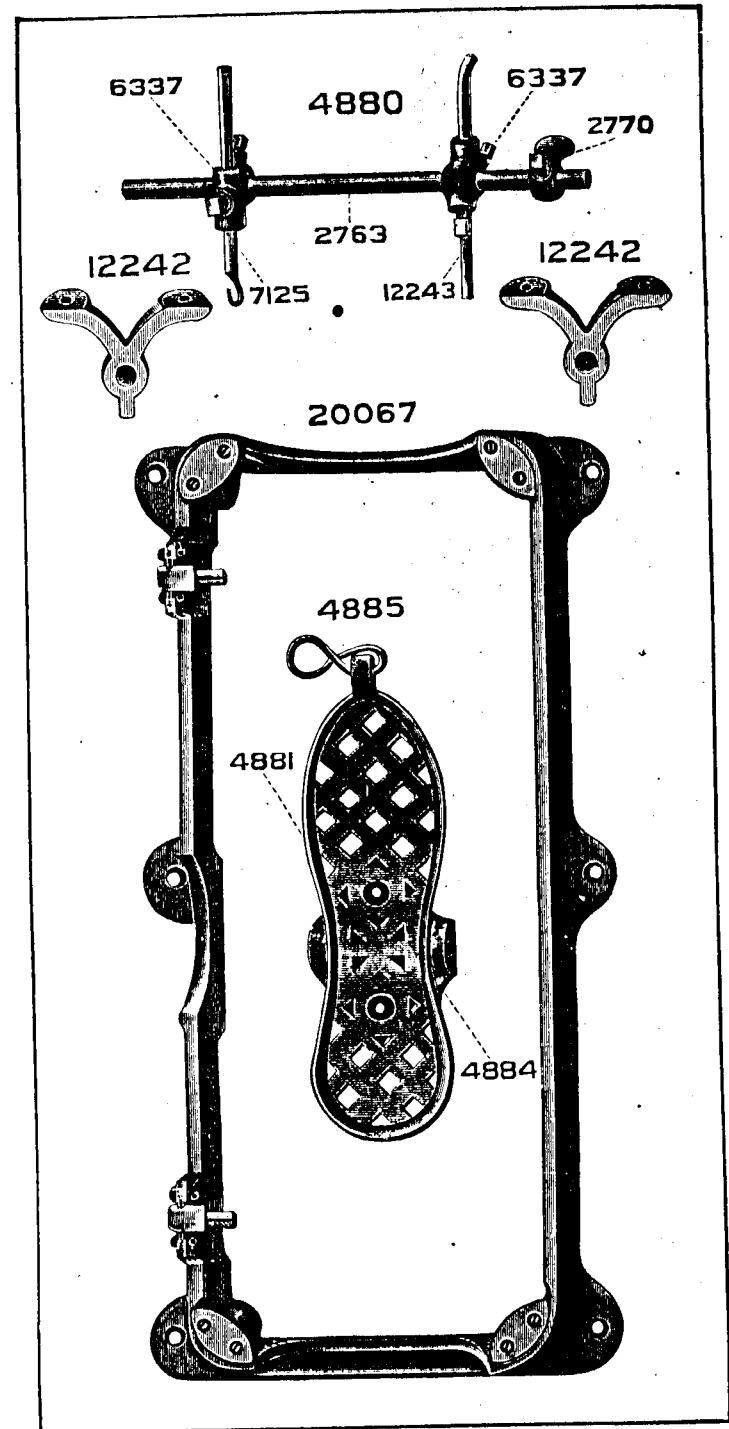


PLATE 1104—ONE-HALF SIZE

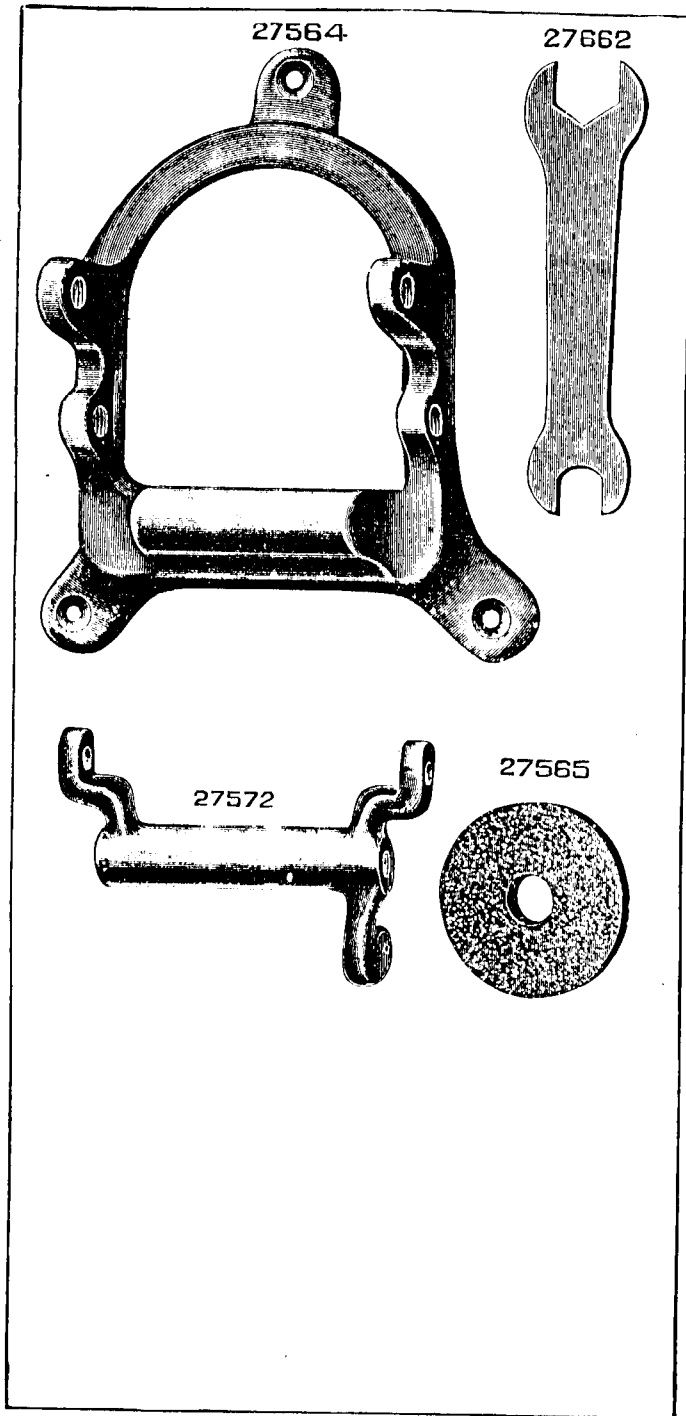


PLATE 1105—FULL SIZE

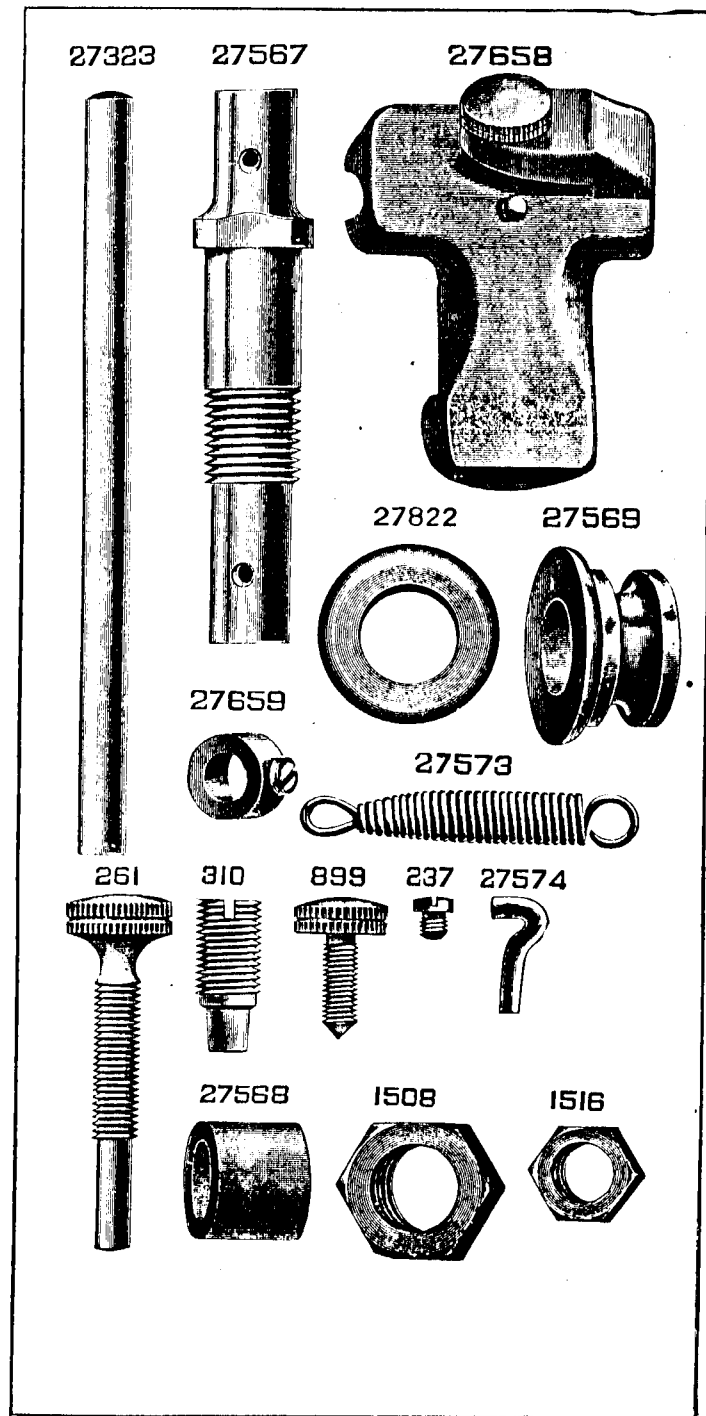


PLATE 2833--ONE-HALF SIZE

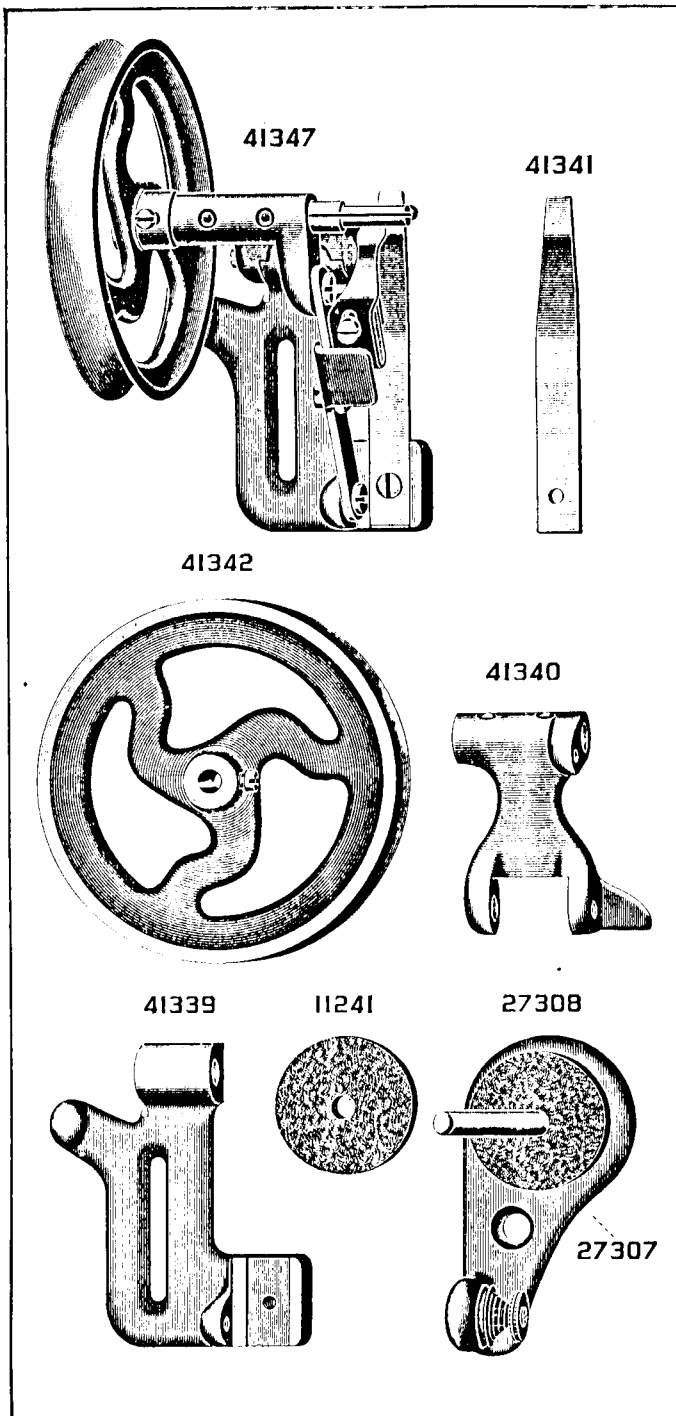


PLATE 2834--FULL SIZE

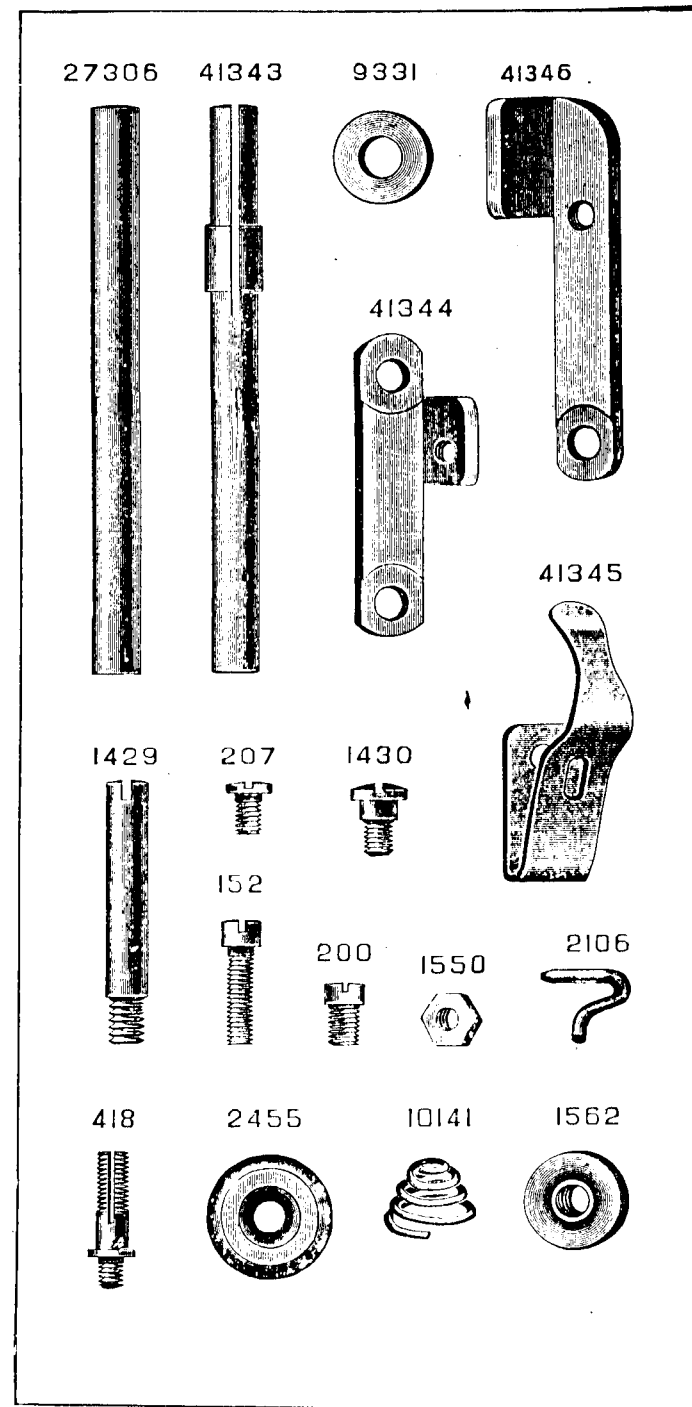


PLATE 2837 -ONE-FOURTH SIZE

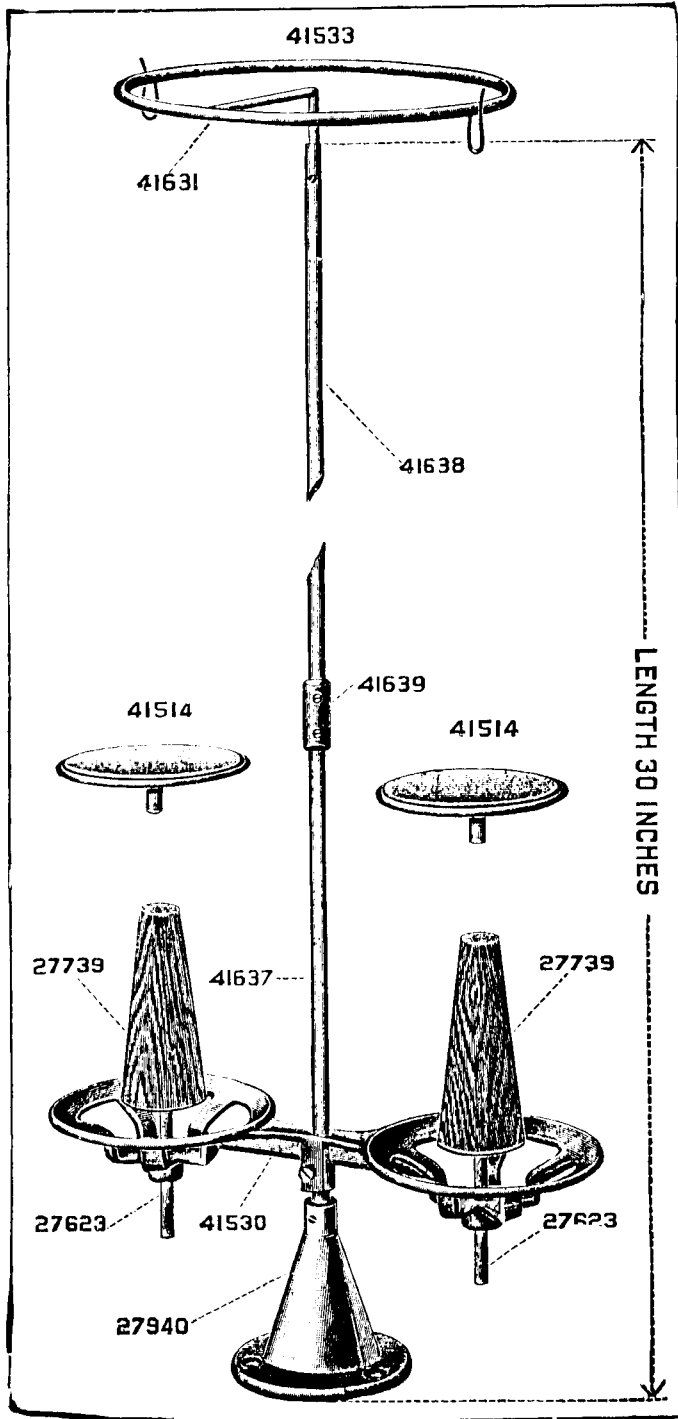


PLATE 3469 -ONE-FOURTH SIZE

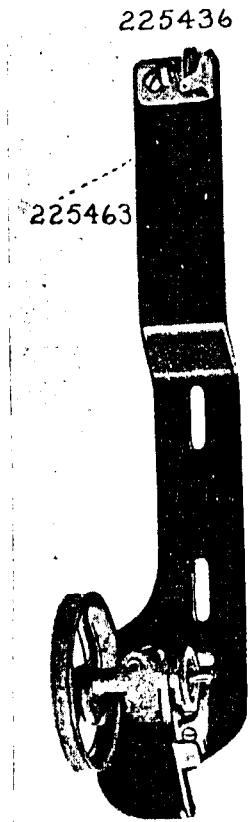
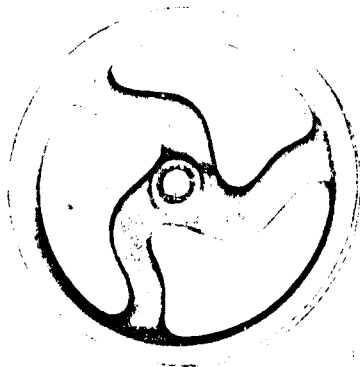
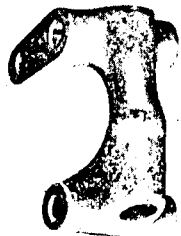


PLATE 3470—ONE-HALF SIZE

202473



225453



225452

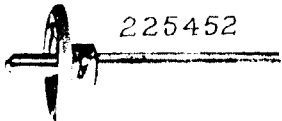
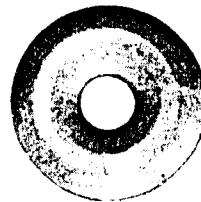
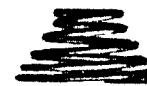


PLATE 3471—FULL SIZE

2102



202407



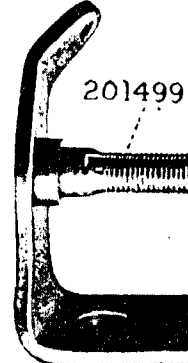
201572



200082 202478 200299



225461



202104



225459



201499

225460



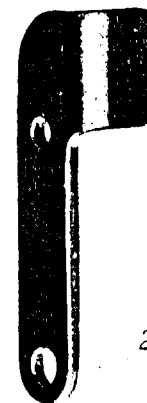
200056 200380



225455 225454



225458



225444



225456



202277 225438



PLATE 5869—FULL SIZE

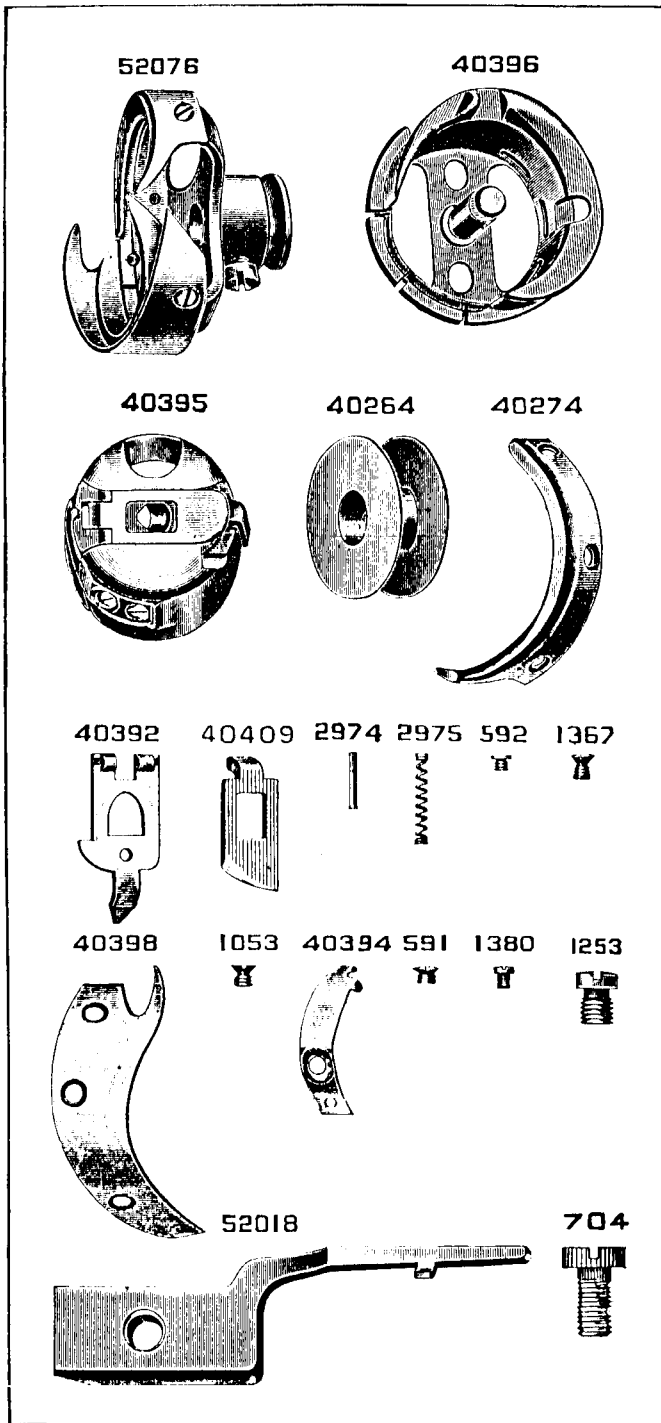


PLATE 5875—FULL SIZE

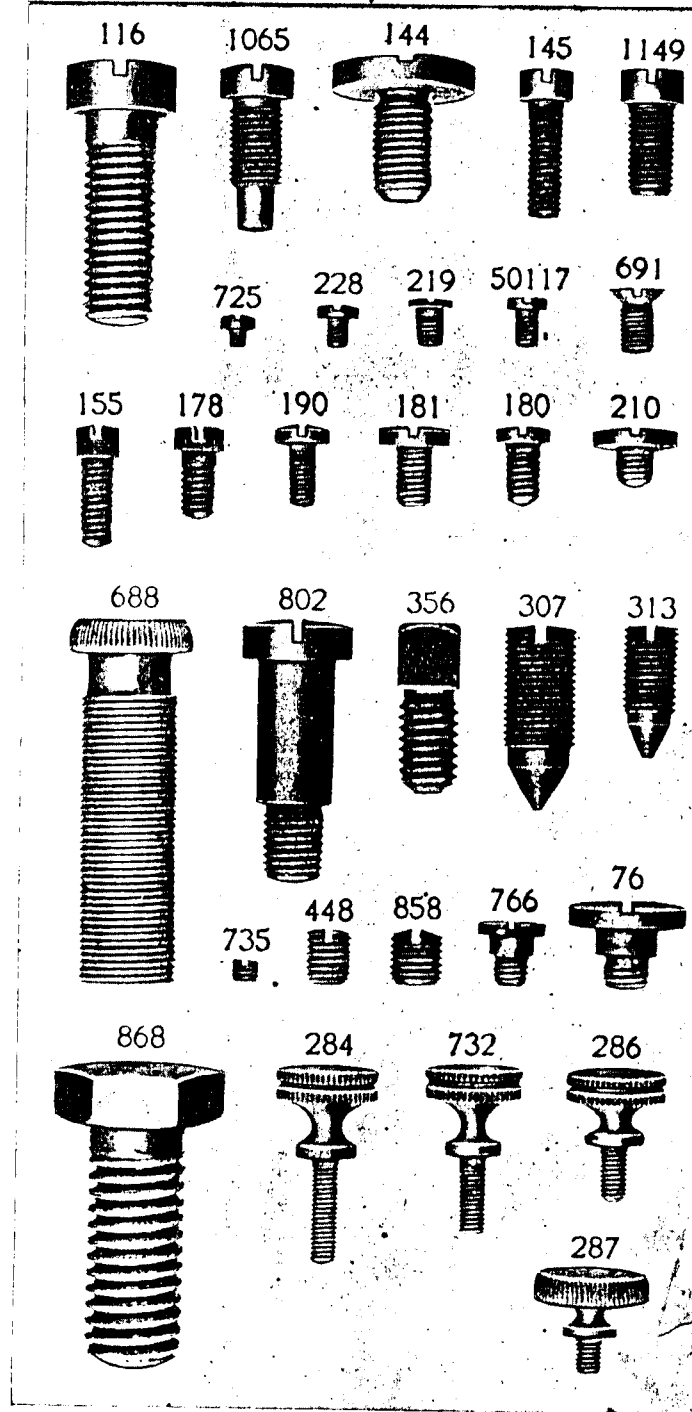
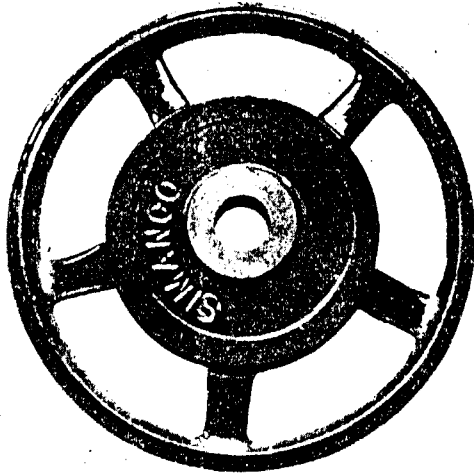


PLATE 5893—ONE-HALF SIZE

52005



52081

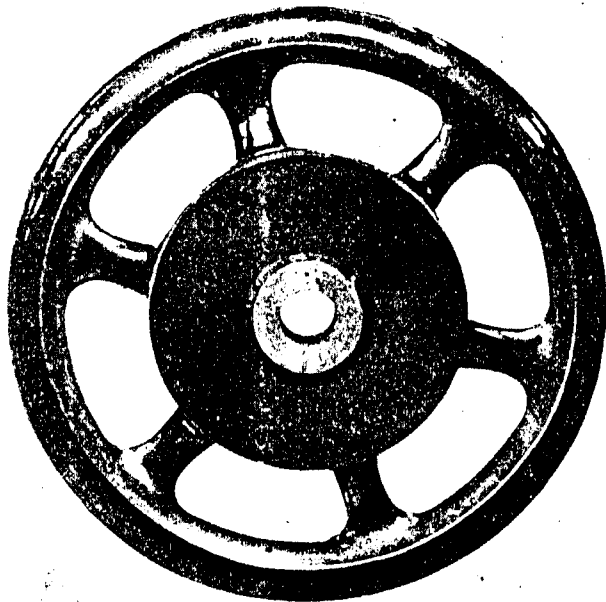
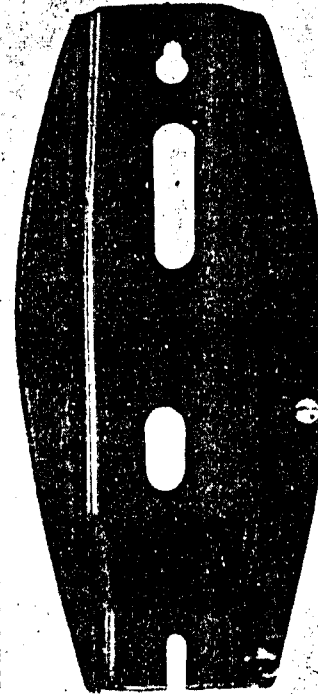
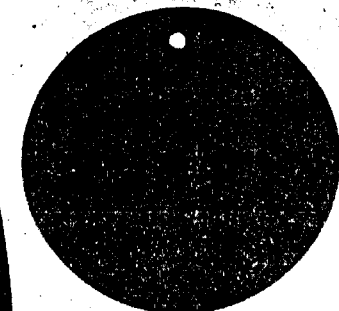


PLATE 5894—ONE-HALF SIZE

52052



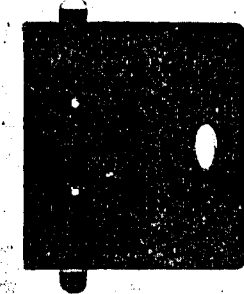
12193



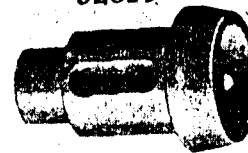
4307



12432



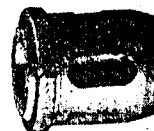
52059



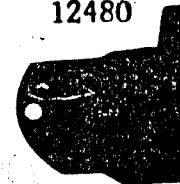
52063



52078



12480



52072



52071

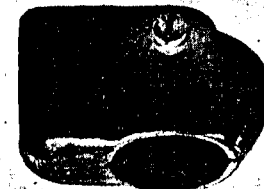


PLATE 5896—ONE-HALF SIZE

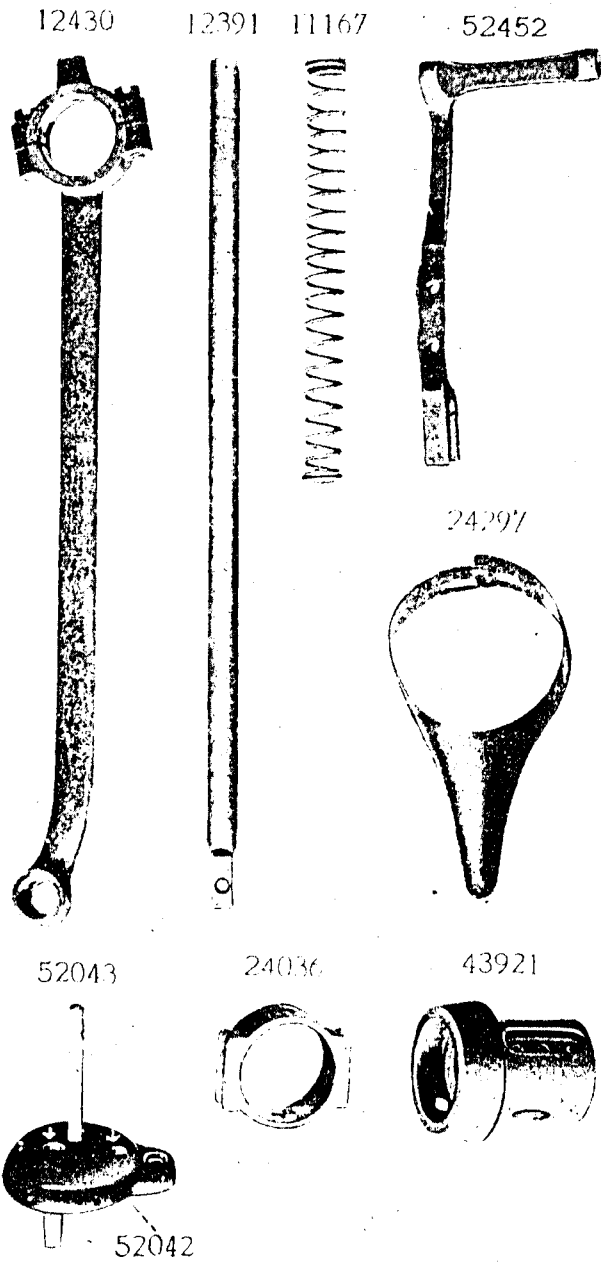


PLATE 5897—FULL SIZE

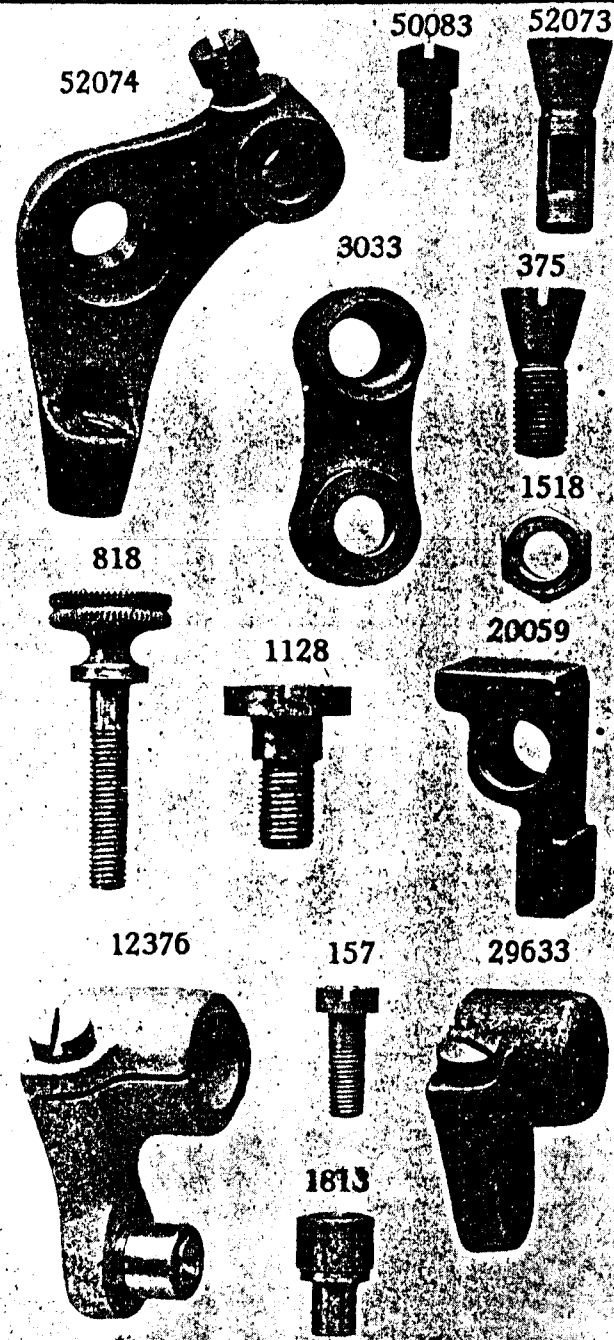
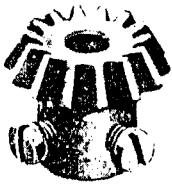


PLATE 5898--FULL SIZE

52062



56101



56100



447



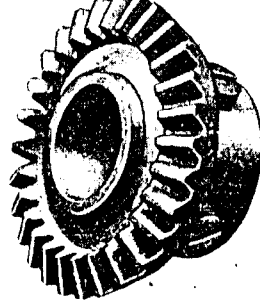
56099



56013



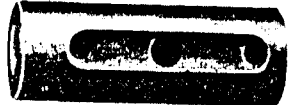
52060



56106



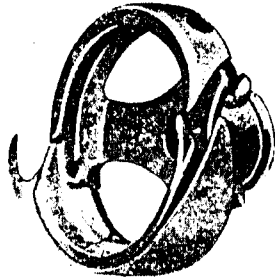
56107



52045



52089



52090

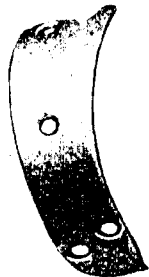


PLATE 5898--FULL SIZE

50304



52083



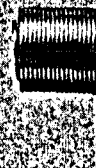
50305



52082



52348



2103



41569



50190



50053



50234



1443



590



121



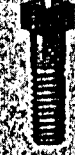
880



127



966



158



432



1148

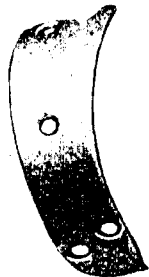
52045



52089



52090



435



446



171



185



208



50191



PLATE 5900—FULL SIZE

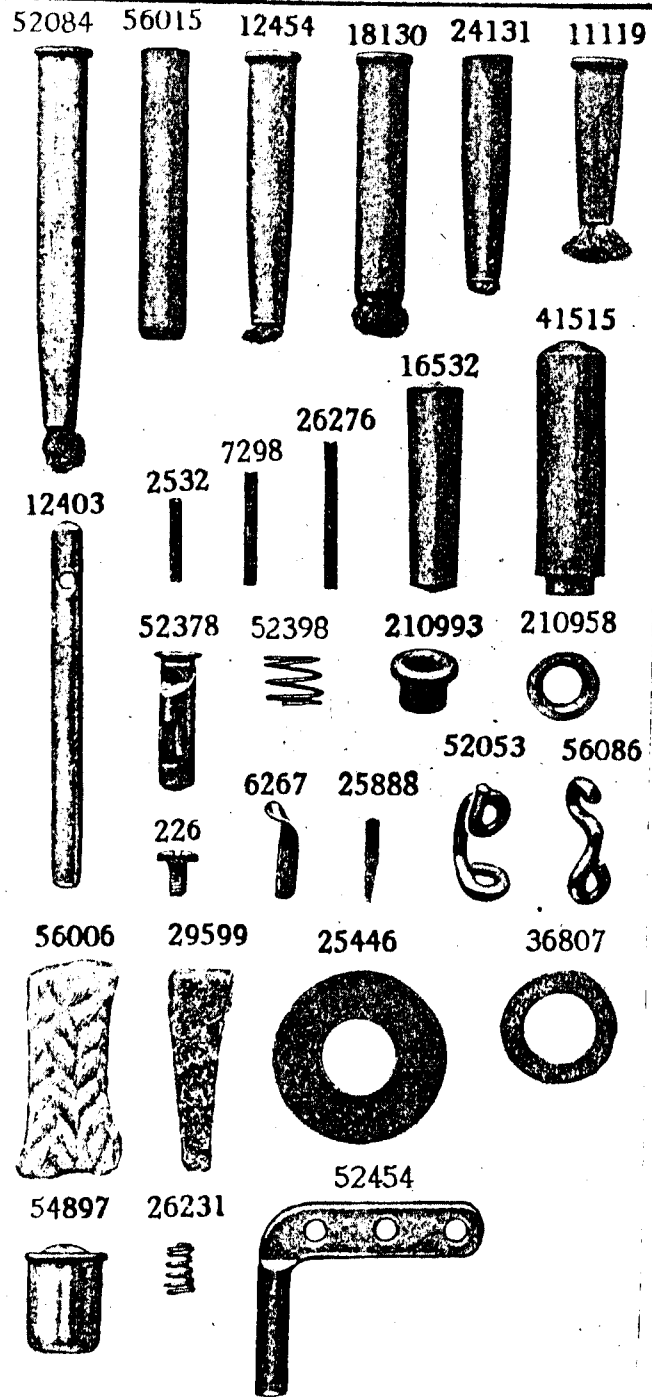


PLATE 5901—ONE-HALF SIZE

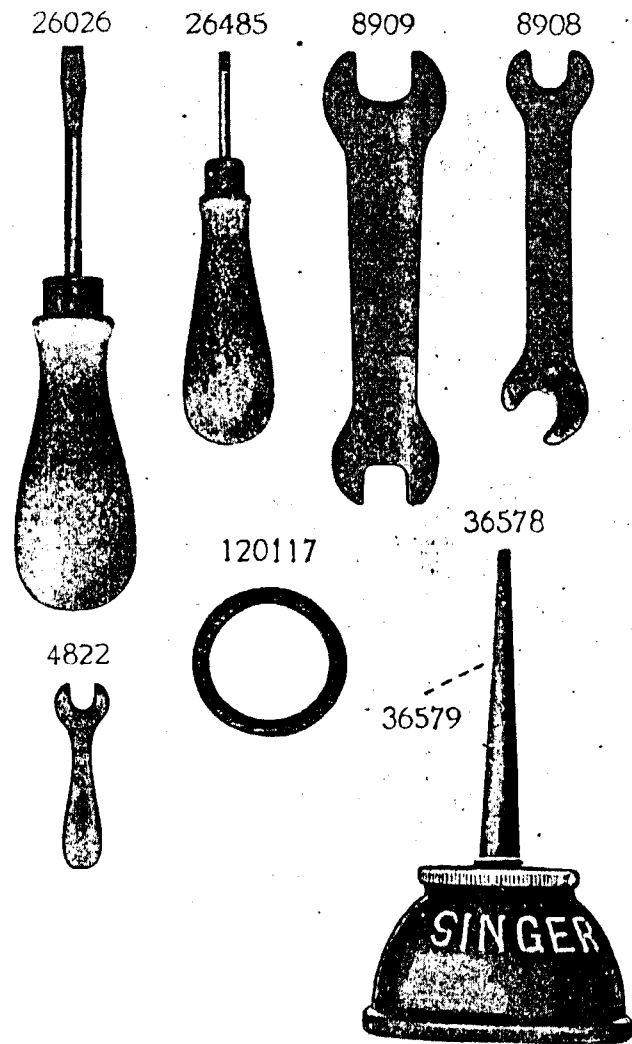


PLATE 5902—ONE-HALF SIZE

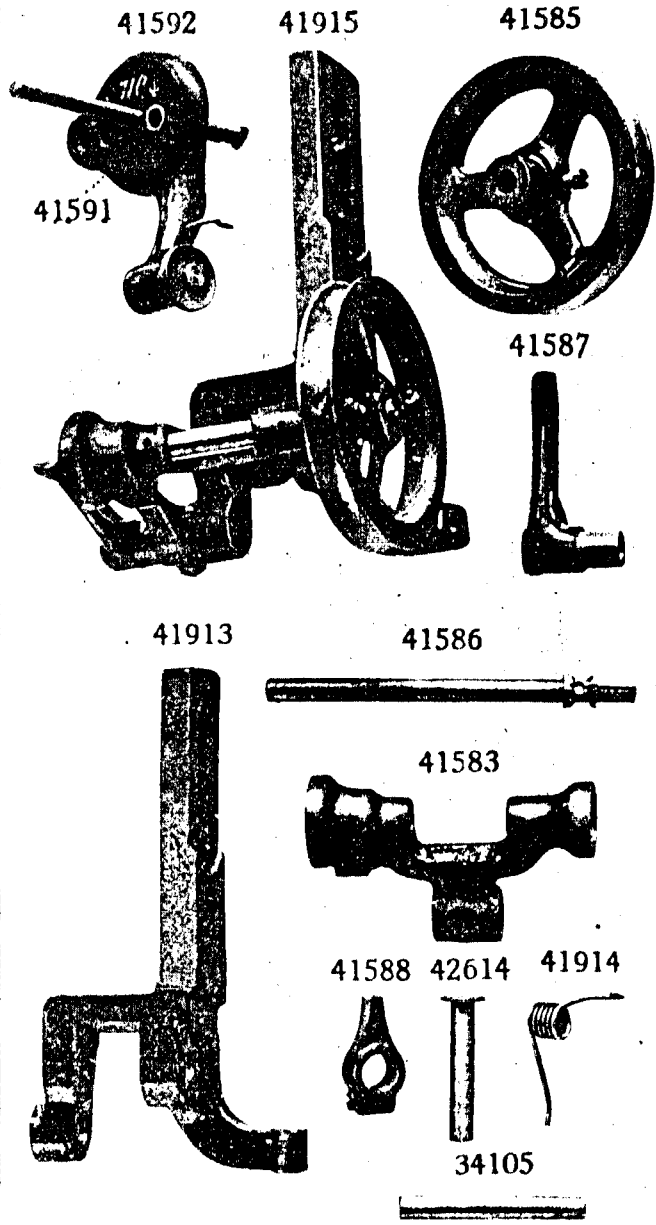


PLATE 5936—FULL SIZE

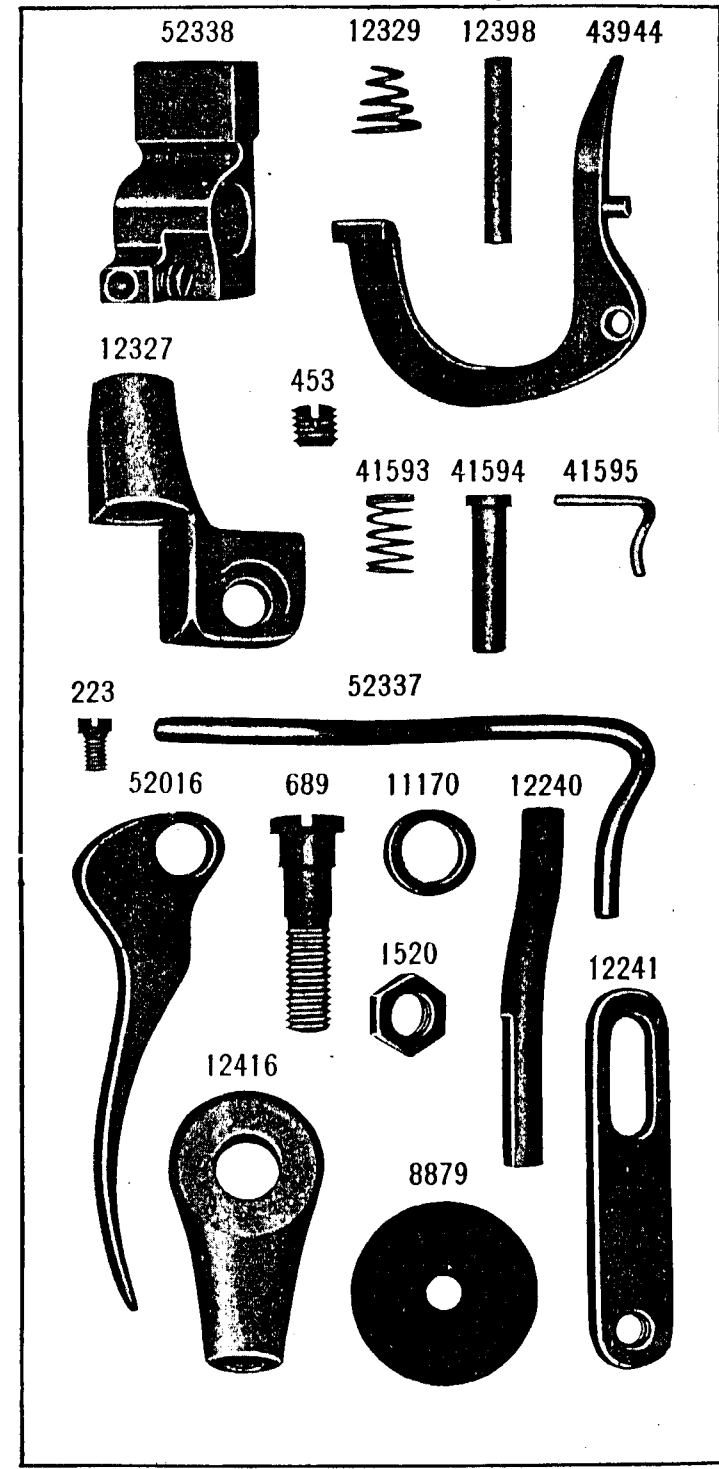


PLATE 5942—FULL SIZE

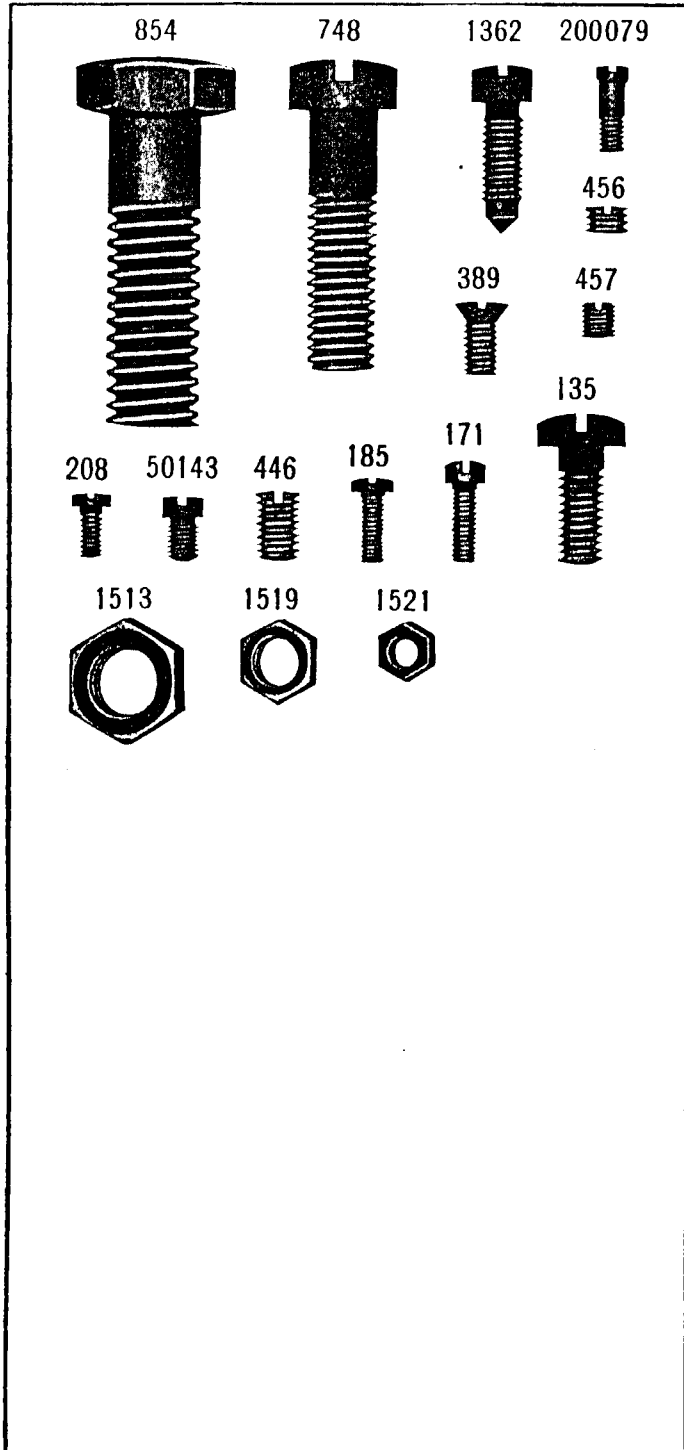


PLATE 5943—FULL SIZE

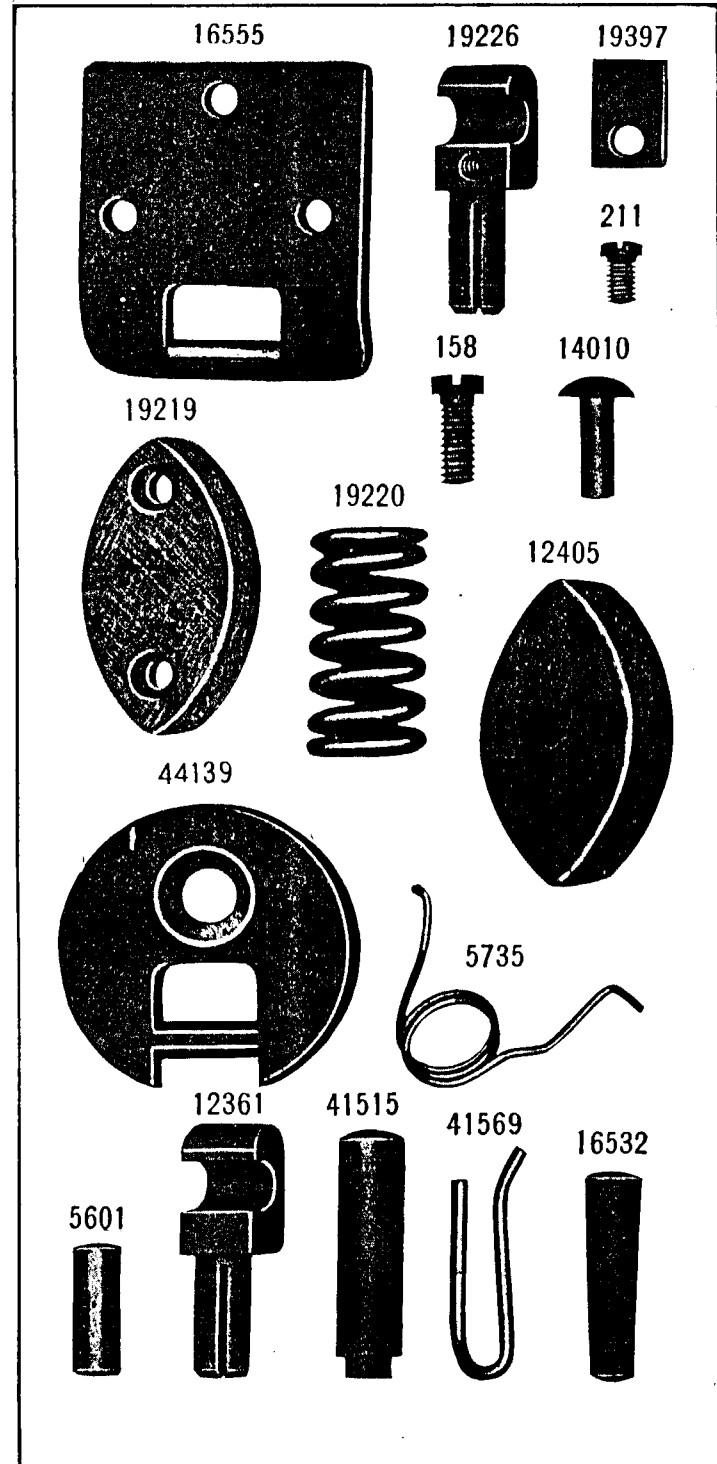


PLATE 5946 ONE-FOURTH SIZE

52382 52386 52384 52388 12237

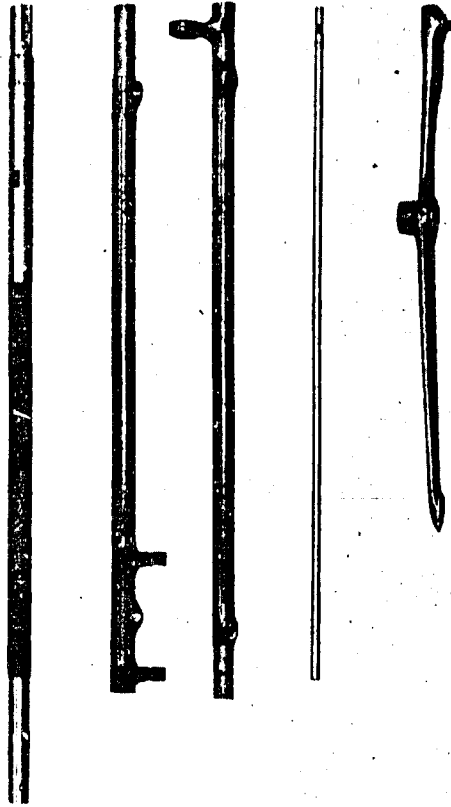


PLATE 5947 ONE-HALF SIZE

20284 24052 20283

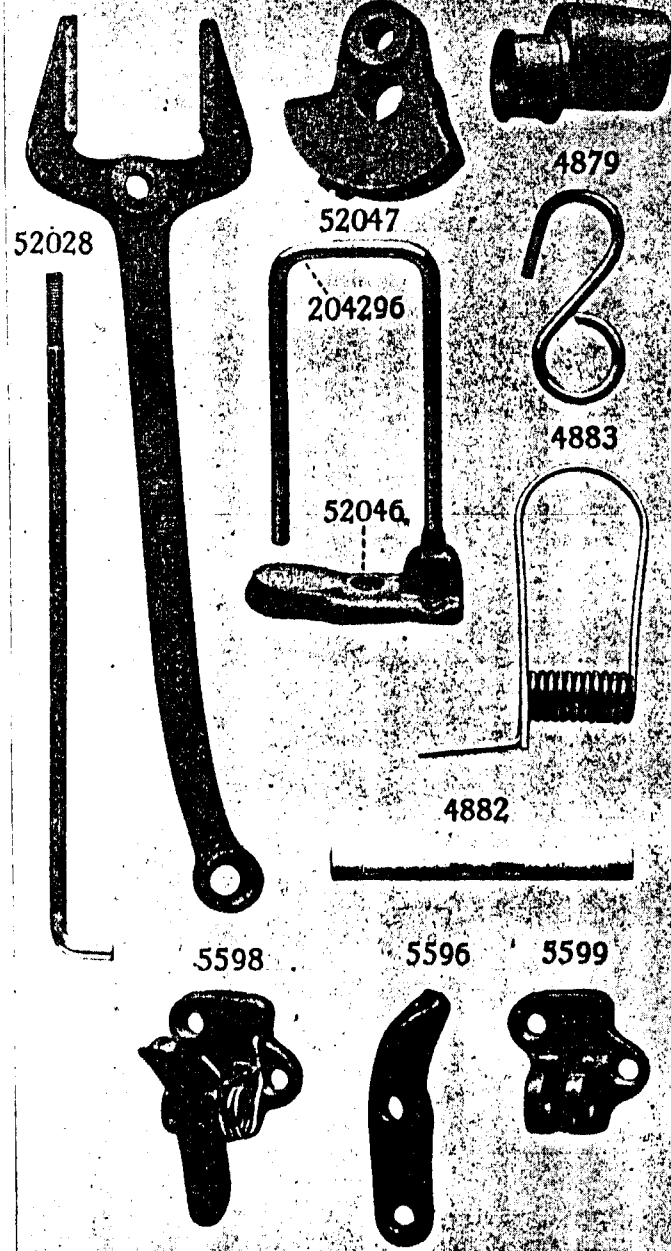


PLATE 5948—FULL SIZE

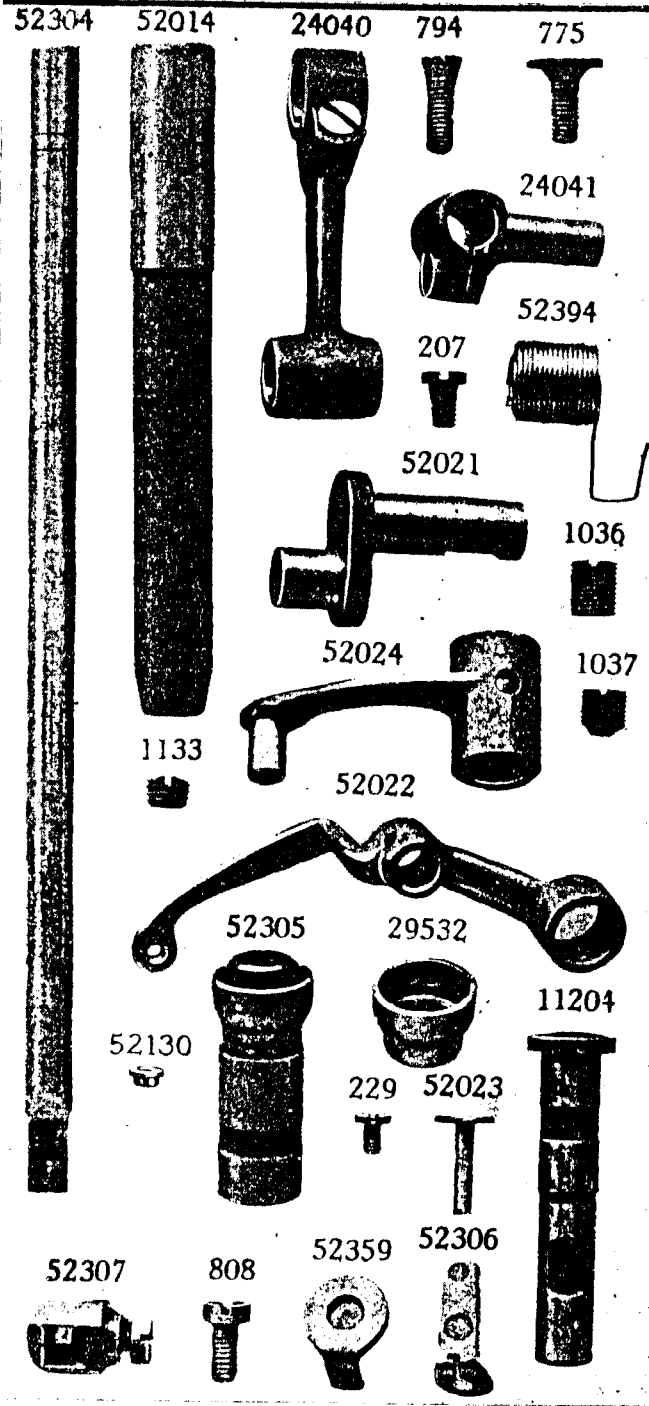


PLATE 6255—FULL SIZE

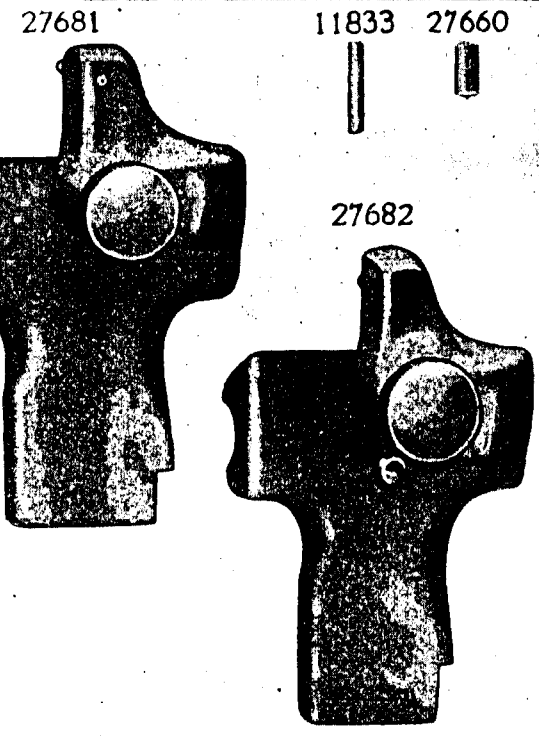


PLATE 6449—FULL SIZE

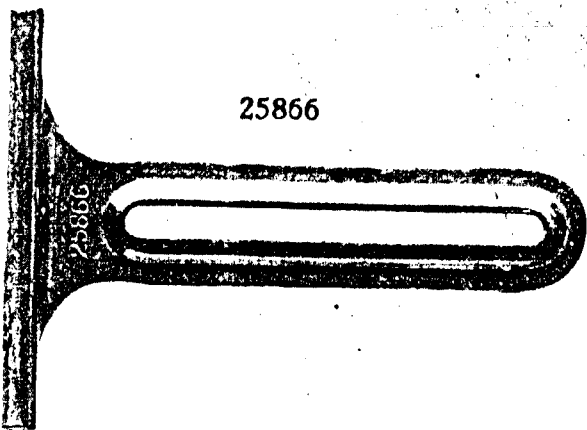
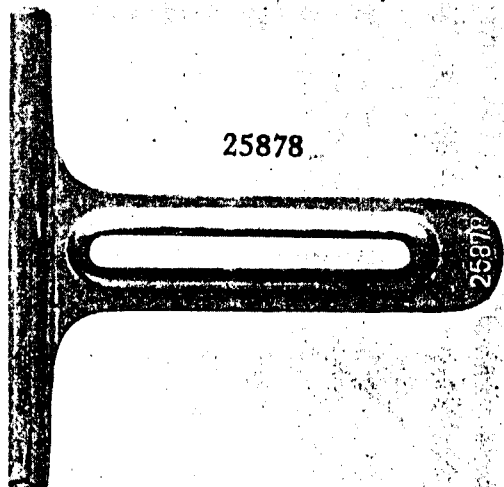


PLATE 7699—FULL SIZE

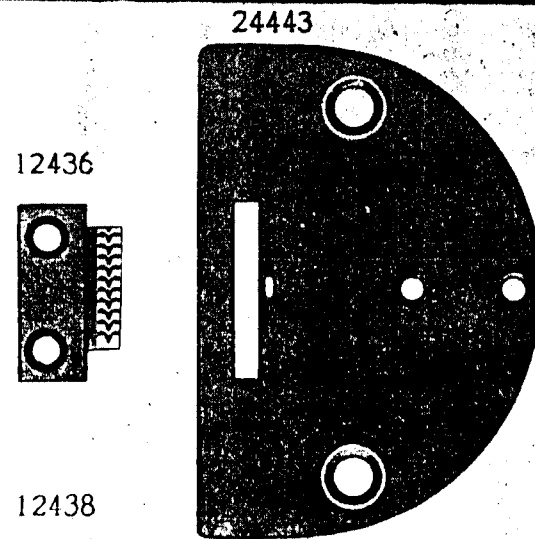
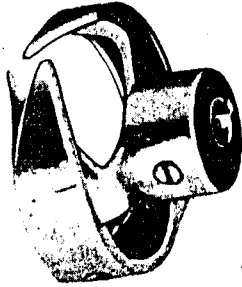


PLATE 7700—FULL SIZE

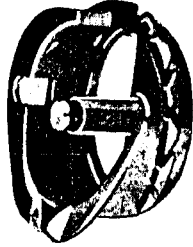
52455



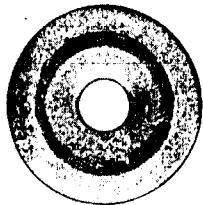
52422



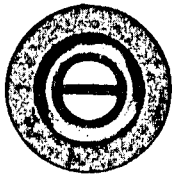
52443



2102



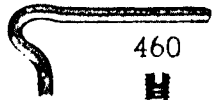
32572



32574



52027



460



1560



52423



7958



52415



1143

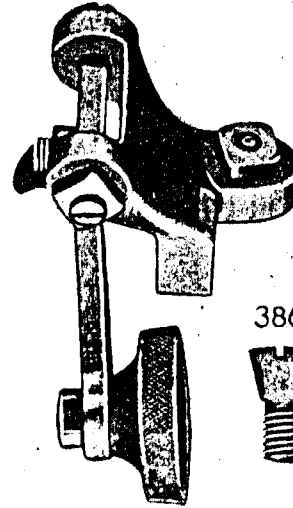


50429

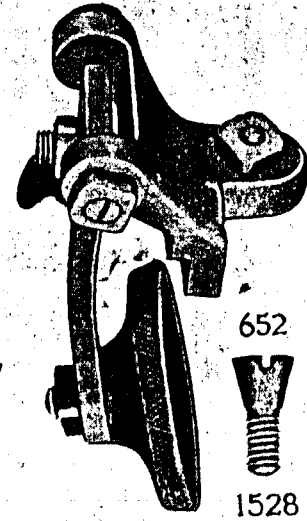


PLATE 7701—FULL SIZE

12265



52414



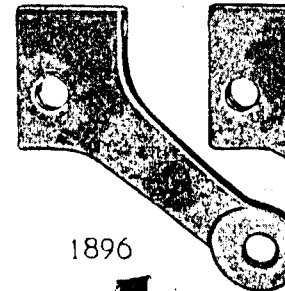
386



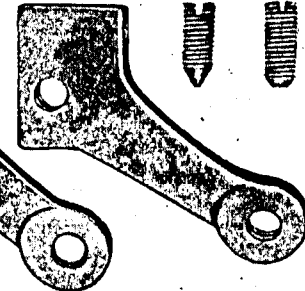
652



12256



52453



316



440



1528



1547



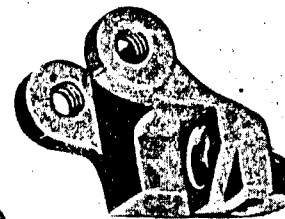
1903



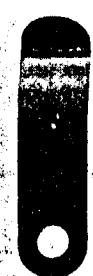
1896



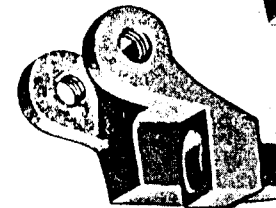
4282



2205



2206



1549



176



PLATE 7702—ONE-HALF SIZE

52424

52418

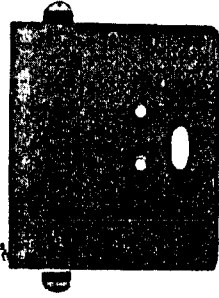


PLATE 7703—FULL SIZE

120063

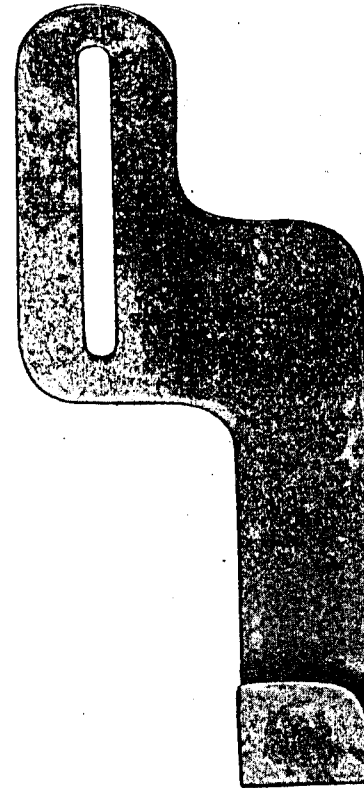
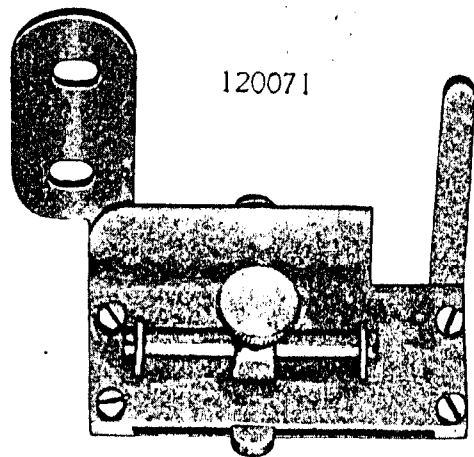
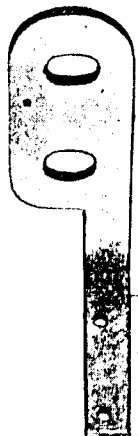


PLATE 7704—FULL SIZE



120067



120068



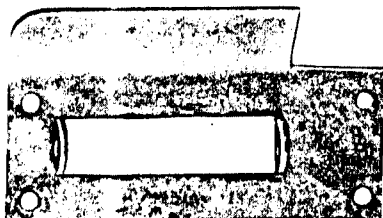
120069



291



120070



1423



50169

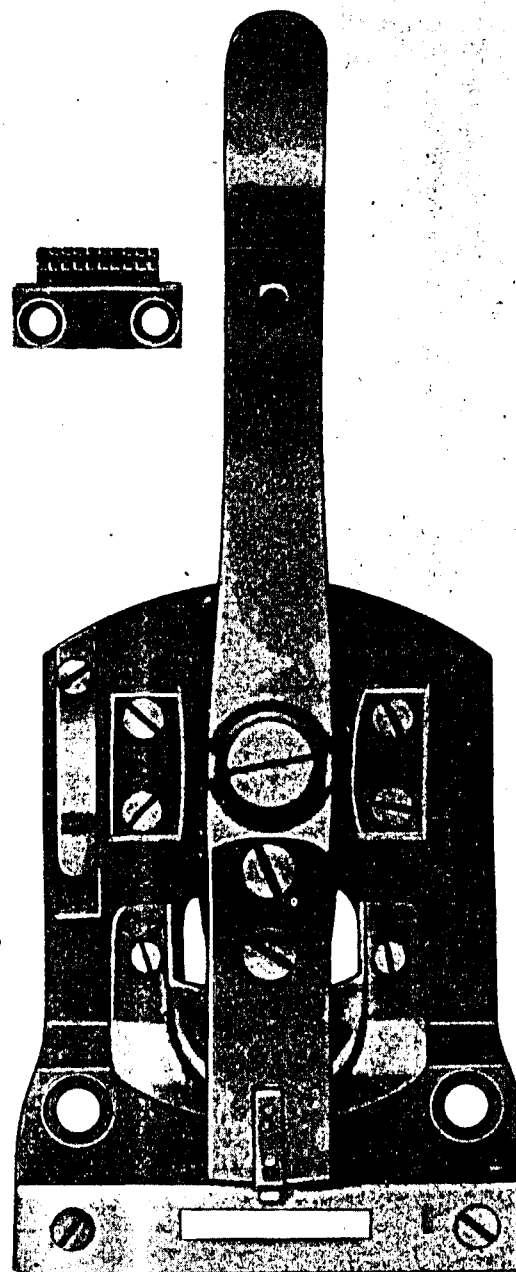


PLATE 7705—FULL SIZE

24162



52425



24336



PLATE 7706—FULL SIZE

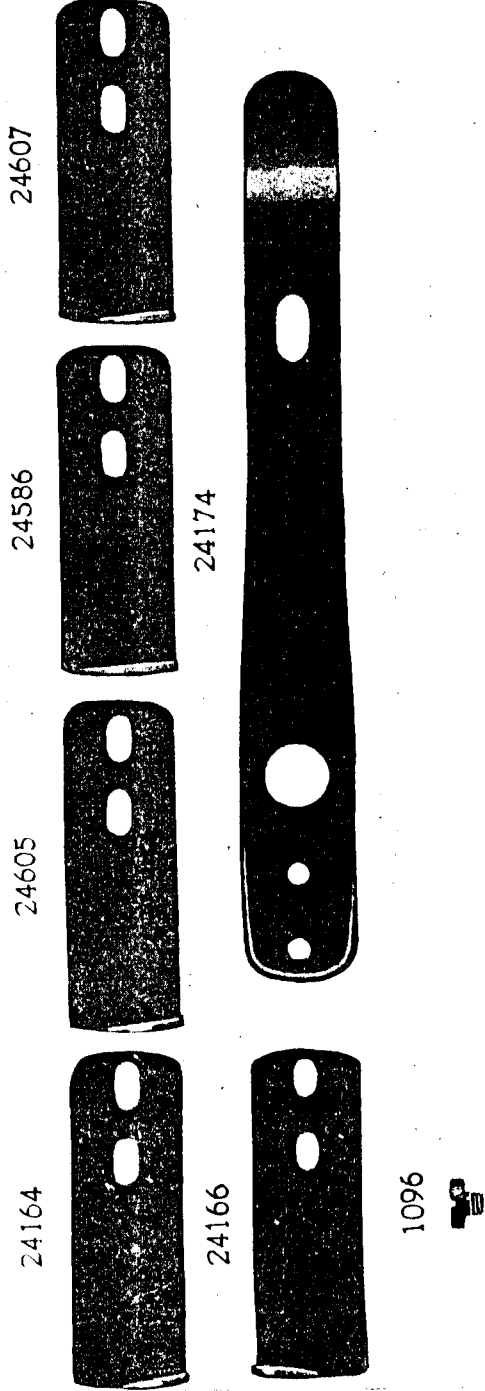


PLATE 7707—FULL SIZE

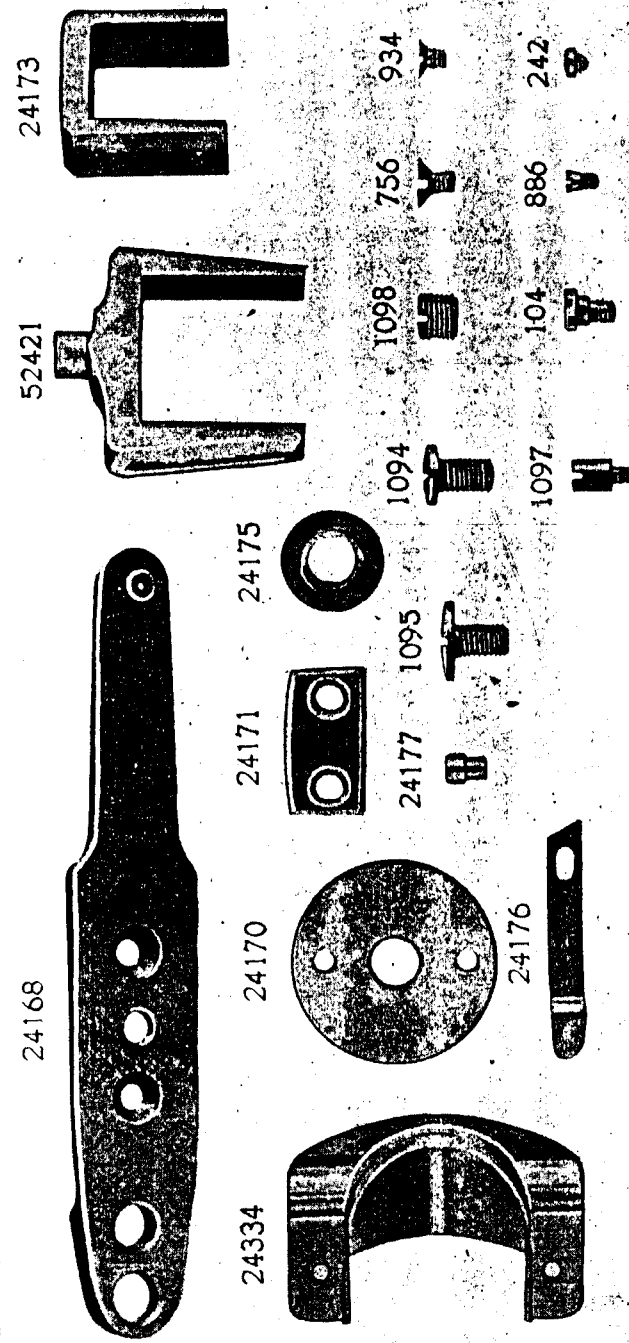


PLATE 7708—ONE-HALF SIZE

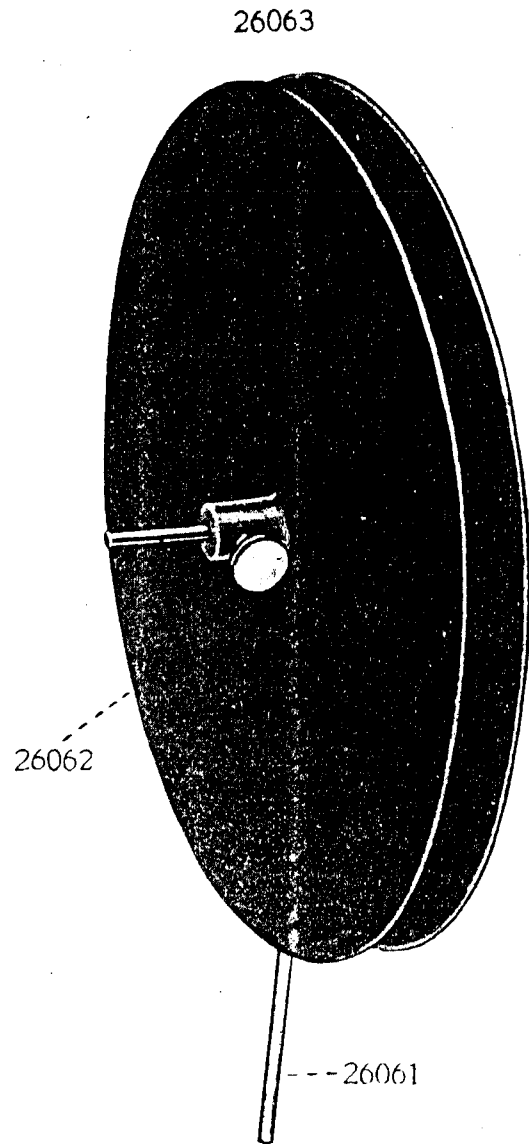


PLATE 7709—FULL SIZE

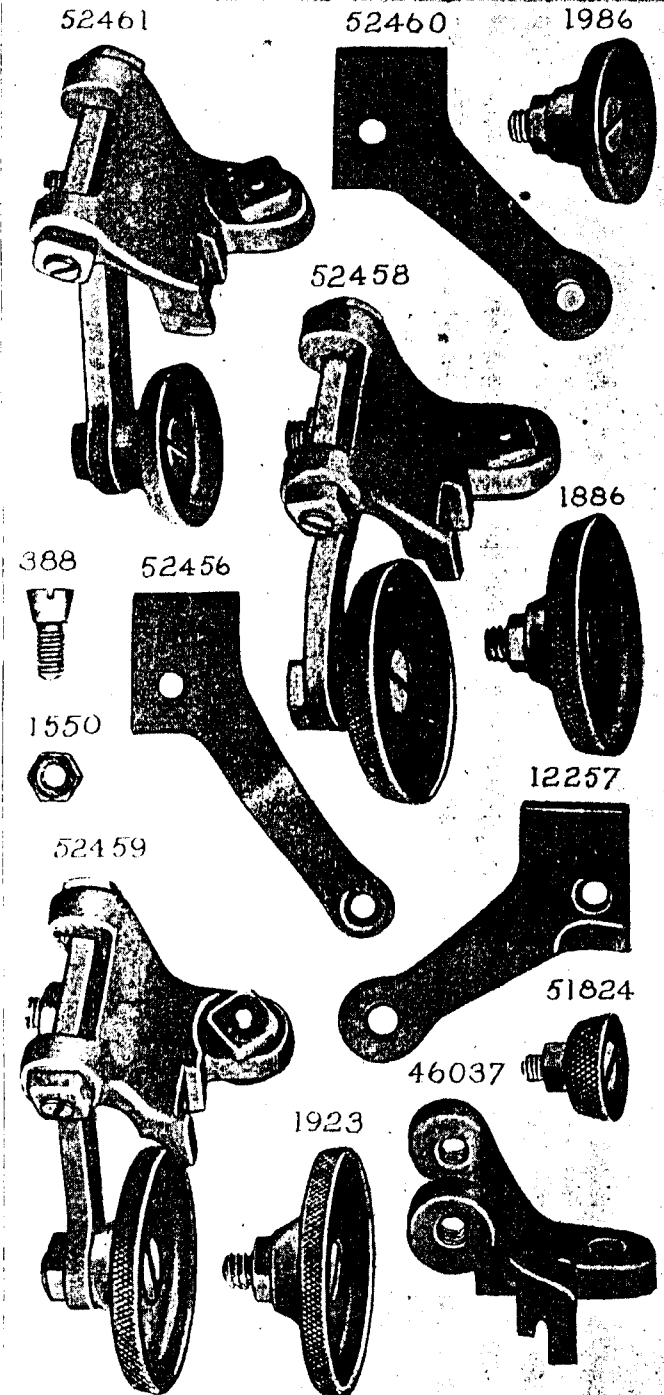


PLATE 7710—FULL SIZE

52468

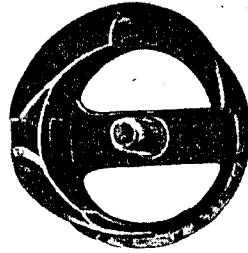


857

52473



52477



52464



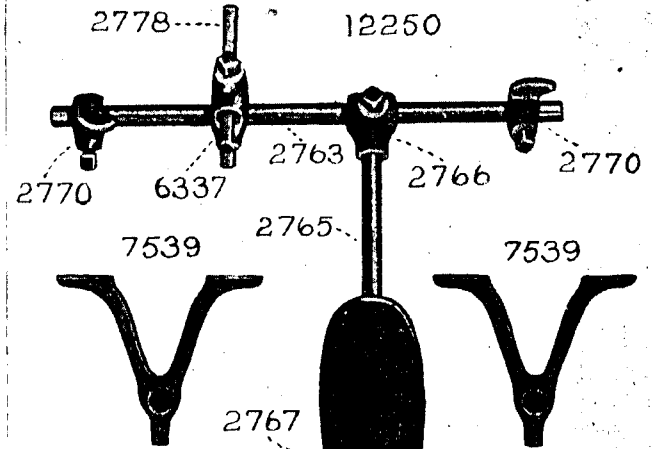
665



PLATE 7711—ONE-FOURTH SIZE

2778

12250



7539

2765

7539

2767

44212

Free Manuals Download Website

<http://myh66.com>

<http://usermanuals.us>

<http://www.somanuals.com>

<http://www.4manuals.cc>

<http://www.manual-lib.com>

<http://www.404manual.com>

<http://www.luxmanual.com>

<http://aubethermostatmanual.com>

Golf course search by state

<http://golfingnear.com>

Email search by domain

<http://emailbydomain.com>

Auto manuals search

<http://auto.somanuals.com>

TV manuals search

<http://tv.somanuals.com>