

# SANYO

## DSR-C100

### INSTRUCTION MANUAL MANUEL D'INSTRUCTIONS MANUAL DE INSTRUCCIONES

**Digital Recording Camera**  
**Caméra d'enregistrement numérique**  
**Cámara de grabación digital**

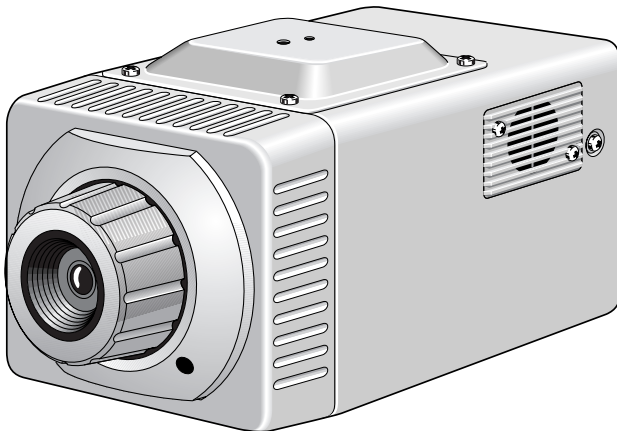

#### **About this manual**

Before installing and using this unit, please read this manual carefully. Be sure to keep it handy for later reference.

#### **À propos de ce manuel**

Avant d'installer et d'utiliser cet appareil, veuillez lire ce manuel attentivement. Assurez-vous de le garder à portée de la main pour référence ultérieure.

#### **Acerca de este manual**

Antes de instalar y usar este aparato, lea detenidamente este manual. Asegúrese de guardarlo a mano para futuras referencias.

# CONTENTS

INFORMATION TO USER.....	3	HARD DISK CAPACITY SETTINGS (HDD SET).....	24
PRECAUTIONS .....	4	■ Hard disk initialization .....	24
FEATURES .....	5	■ Changing the alarm capacity .....	25
ACCESSORIES .....	5	SUMMER TIME SETTINGS (SUMMER TIME/DAYLIGHT SET).....	26
PART NAMES AND FUNCTIONS.....	6	KEY WORD SETTING (KEY WORD SET) 28	
■ Front panel.....	6	■ Entering a file ID (1 character).....	29
■ Rear Panel .....	7	■ Setting a camera ID (5 characters).....	30
■ Control terminals.....	8	■ Entering a comments (up to 36 characters) .....	31
WARNING DISPLAYS .....	9	■ Entering a password for deleting files (CHANGE PASSWORD (DELETE)).....	32
INSTALLING AND HANDLING THE Ni-Cd BACKUP BATTERY .....	11	■ Setting a password for initializing the hard disk (CHANGE PASSWORD (INITIAL)) .....	34
■ Installing the Ni-Cd battery.....	12	■ Correcting characters .....	36
■ WARNING .....	12	CHECKING THE CAMERA SETTING STATUS .....	37
■ DANGER .....	12	SETTING THE RECORDING METHOD ....	39
CONNECTIONS.....	13	Pre-alarm recording flow .....	41
■ Basic connections .....	13	Screen displays .....	42
■ Connection to a computer .....	14	■ Pre-alarm recording .....	42
HARD DISK.....	15	■ Post-alarm recording .....	43
■ Hard disk recording areas.....	15	■ Backup recording.....	44
■ Protecting the hard disk.....	16	Suspicion recording flow .....	45
■ The built-in hard disk, cooling fan and Ni-Cd battery are consumable.....	16	■ Suspicion recording .....	46
FROM RECORDING TO PLAYBACK .....	17	■ Remaining number of shots for suspicion recording .....	47
HARD DISK STANDBY MODE.....	18	PLAYING BACK AND SAVING RECORDED IMAGES.....	49
■ Setting to standby mode .....	18	■ Playback screen and image saving flow .....	50
■ Canceling standby mode.....	18	ALARM Playback .....	51
MENU SETTINGS .....	21	SUSPICION Playback .....	55
■ Menu screen display .....	21		
SETTING THE CLOCK (CLOCK SET).....	22		
SYSTEM SETTINGS (SYSTEM SET) .....	23		

ARCHIVE Playback .....	57	■ Deleting all images of an ARCHIVE SHOT.....	78
EXTENSION Playback.....	59	■ Deleting all images in the EXTENSION recording area.....	79
<b>FUNCTION OPERATIONS</b> .....	<b>61</b>	■ Deleting all images of an EXTENSION SHOT.....	80
■ Function operations for ALARM recording images.....	61	<b>OPERATIONS USING A COMPUTER.....</b>	<b>81</b>
■ Function operations for SUSPICION recording images.....	62	<b>REPLACING THE HARD DISK DRIVE .....</b>	<b>82</b>
■ Function operations for ARCHIVE recording images.....	63	<b>SPECIFICATIONS.....</b>	<b>83</b>
■ Function operations for EXTENSION recording images.....	64	■ Camera unit .....	83
Image enlargement (ZOOM) .....	65	■ Dimensions .....	84
■ Enlarging images to any one of six sizes.....	65	■ Ni-Cd Battery.....	85
■ Changing the image enlargement position .....	66	■ AC Adaptor .....	85
Setting date/time/information (ON SCREEN DISPLAY) .....	67		
Image copying (COPY) .....	68		
■ Saving images recorded at times such as during an emergency situation to the archive recording area of the hard disk.....	68		
■ Saving images recorded at times such as during an emergency situation onto a memory card.....	70		
■ Formatting the memory card .....	72		
Deleting Images (DELETE).....	73		
■ Deleting all images in the ALARM recording area .....	73		
■ Deleting all images in the PRE-ALARM (PRE1) recording area.....	74		
■ Deleting all images in the SUSPICION recording area .....	75		
■ Deleting all images of a SUSPICION group.....	76		
■ Deleting all images in the ARCHIVE recording area .....	77		

# INFORMATION TO USER

## Safety Guard



**THIS SYMBOL INDICATES THAT THERE ARE IMPORTANT OPERATING AND MAINTENANCE INSTRUCTIONS IN THE LITERATURE ACCOMPANYING THIS UNIT.**

### WARNING:

**TO PREVENT THE RISK OF FIRE OR ELECTRIC SHOCK, DO NOT EXPOSE THIS APPLIANCE TO RAIN OR MOISTURE.**

### For the customers in Canada

This Class B digital apparatus complies with Canadian ICES-003.

### Pour la clientèle canadienne

Cet appareil numérique de la Classe B est conforme à la norme NMB-003 du Canada.

This installation should be made by a qualified service person and should conform to all local codes.

### Declaration of Conformity

Model Number : DSR-C100  
Trade Name : SANYO  
Responsible party : SANYO FISHER COMPANY  
Address : 21605 Plummer Street,  
Chatsworth, California 91311  
Telephone No. : (818) 998-7322

- This device complies with Part 15 of the FCC Rules. Operation is subject to the following two conditions:
  - (1) this device may not cause harmful interference, and
  - (2) this device must accept any interference received, including interference that may cause undesired operation.

This equipment has been tested and found to comply with the limits for a Class B digital device, pursuant to Part 15 of the FCC Rules.

These limits are designed to provide reasonable protection against harmful interference in a residential installation. This equipment generates, uses, and can radiate radio frequency energy and, if not installed and used in accordance with the instructions, may cause harmful interference to radio communications.

However, there is no guarantee that interference will not occur in a particular installation. If this equipment does cause harmful interference to radio or television reception, which can be determined by turning the equipment off and on, the user is encouraged to try to correct the interference by one or more of the following measures:

- Reorient or relocate the receiving antenna.
- Increase the separation between the equipment and receiver.
- Connect the equipment into an outlet on a circuit different from that to which the receiver is connected.
- Consult the dealer or an experienced radio/TV technician for help.

This device complies with Part 15 of the FCC Rules. Operation is subject to the following two conditions: (1) This device may not cause harmful interference, and (2) this device must accept any interference received, including interference that may cause undesired operation.

Changes or modifications not expressly approved by **Sanyo** may void the user's authority to operate this camera.

# PRECAUTIONS

## ■ In case of problems

Do not use the camera if smoke or a strange odor comes from the unit, or if it seems not to function correctly. Disconnect the power cord immediately, and consult your dealer (or a Sanyo Authorized Service Centre).

## ■ Do not open or modify

Do not open the cabinet, as it may be dangerous and cause damage to the unit. For internal settings and repairs, consult your dealer (or a Sanyo Authorized Service Centre).

## ■ Do not put objects inside the unit

Make sure that no metal objects or flammable substance get inside the camera. If used with a foreign object inside, it could cause a fire, short-circuits or damages.

If water or other liquid gets inside the camera, disconnect the power cord immediately, and consult your dealer (or a Sanyo Authorized Service Centre). Be careful to protect the camera from rain, seawater, etc.

## ■ Be careful when handling the unit

To prevent damage, do not drop the camera or subject it to strong shock or vibration.

## ■ Install away from electric or magnetic fields

If installed close to a TV, radio transmitter, magnet, electric motor, transformer, or audio speakers, the magnetic field they generate may distort the image.

## ■ Protect from humidity and dust

To prevent damage to the camera, do not install it where there is greasy smoke or steam, where the dampness may get too high, or where there is a lot of dust.

## ■ Protect from high temperatures

Do not install close to stoves or other heat generating devices, such as spotlights, or where the camera could be subject to direct sunlight, as that could cause deformation, discoloration or other damage.

Be careful when installing close to the ceiling in a kitchen or boiler room, as the temperature may rise to high levels.

Install where the temperature range will stay between 5 °C and 40 °C. (no condensation)

## ■ Cleaning

- Dirt can be removed from the cabinet by wiping it with a soft cloth. To remove stains, wipe with a soft cloth moistened with a neutral detergent solution and wrung dry, then wipe dry with a dry soft cloth.
- Do not use solvents, thinner or other chemical product on the cabinet, as that may cause deformation and paint peeling. Before using a chemical cloth, make sure to read all accompanying instructions. Make sure that no plastic or rubber material comes in contact with the cabinet for a long period of time, as that may cause damage or paint peeling.



### IMPORTANT NOTE:

The EPA certified RBRC<sup>®</sup> Battery Recycling Seal on the nickel-cadmium (Ni-Cd) battery indicates SANYO is voluntarily participating in an industry program to collect and recycle these batteries at the end of their useful life, when taken out of service in the United States or Canada. The RBRC program provides a convenient alternative to placing used Ni-Cd batteries into the trash or the municipal waste stream, which may be illegal in your area. Please call 1-800-822-8837 for information on Ni-Cd battery recycling and disposal bans/restrictions in your area. SANYO's involvement in this program is part of our commitment to preserving our environment and conserving our natural resources.

# FEATURES

## ■ Equipped with a 3.5-inch hard disk

The images are recorded directly to the camera's hard disk. The saved images can then be manipulated using a CompactFlash card and a personal computer.

## ■ The following four recording modes are available.

### ● Pre-alarm recording

This is normal recording. The images are saved in the pre-alarm area of the hard disk.

### ● Post-alarm recording

When a hold-up switch which is connected to the **H** (HOLD-UP) terminal at the rear of the camera is operated, post-alarm recording starts, and the recorded images are saved in those of the post-alarm area of the hard disk.

### ● Backup recording

If there is 20 minutes or more of available recording time remaining in the alarm recording area of the hard disk when the first post-alarm recording session ends, backup recording then starts.

### ● Suspicion recording

When a suspicion switch which is connected to the **S** (SUSPICION) terminal at the rear of the camera is operated, images such as those of suspicious individuals are saved in the suspicion area of the hard disk.

## ■ Multi-playback function

The captured images in hard disk can then be played back in an instant. Special playback functions such as multi-screen display, reverse playback, frame jogging and zooming are all possible. In addition, images can easily be copied (saved) as required.

## ■ RS-232C connector/USB connector equipped as standard

A computer can be connected to allow image data to be transmitted at high speeds.

# ACCESSORIES

## ① AC adaptor

## ② Relay connector

## ③ Ni-Cd battery (for backup)

## ④ Application software (CD-ROM)

## ● Power cord

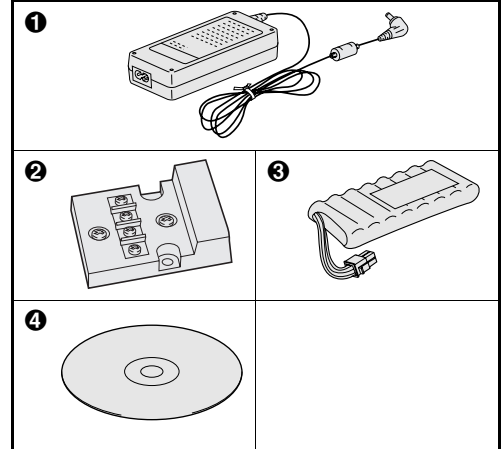

# PART NAMES AND FUNCTIONS

## ■ Front panel

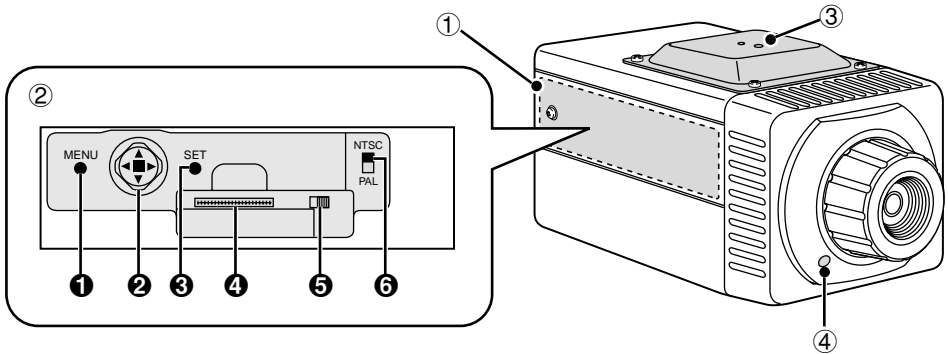

### ① Operation panel cover

Remove this cover in order to use the **MENU** button and **CURSOR** button to operate the camera.

#### ● Removing the operation panel cover

Use a screwdriver to loosen the fixing screws, and then slide the operation panel cover to the left to remove it.

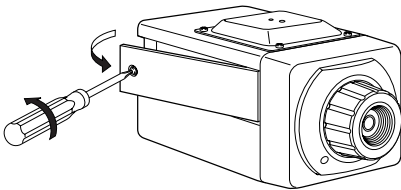

**Note:** Be careful not to drop the operation panel cover when removing it.

### ② Operation panel

#### ① MENU button

This button is used to display menu screens.

#### ② CURSOR button

This button is used to select items in the menu screens and to change settings. In addition, it is used to select images to be played back and to select playback functions.

#### ③ SET button

This button is used to accept items selected in the menu screens and setting values.

#### ④ Extension port

This port is used to copy images to removable media such as a CompactFlash card.

#### ⑤ EJECT button (See page 70)

#### ⑥ NTSC/PAL select switch

This switch is used to select the video format.

**NTSC:** NTSC format

**PAL:** PAL format

**Note:** This switch must be set before the power is turned on. If it is set after the power is turned on, the setting will be ignored.

# PART NAMES AND FUNCTIONS

## ■ Front Panel

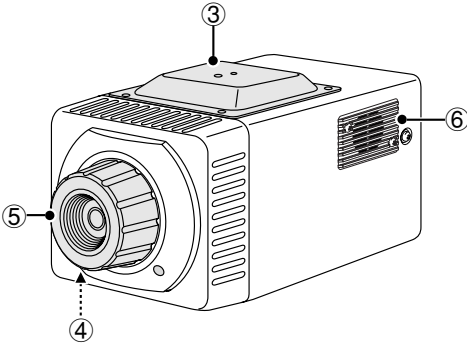

## ■ Rear Panel

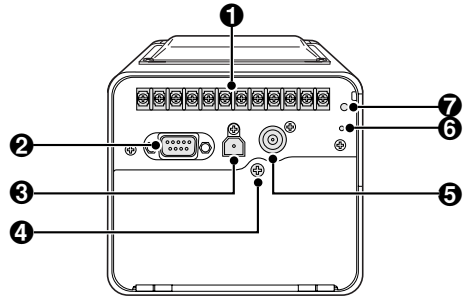

### ③ Camera mounting bracket

The camera mounting bracket is provided with mounting holes (1/4" – 20 UNC). At the time of shipment from the factory, the bracket is attached to the top of the camera, but it can also be attached to the bottom of the camera. Use whichever attachment position is suitable for the place and method of use.

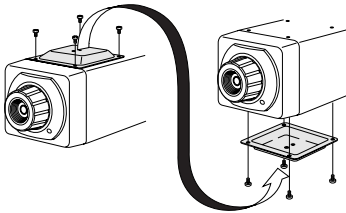

**Note:** If installing the camera to a ceiling, always be sure to check the strength of the installation location (it must be able to bear a weight of at least 10 kg). It is recommended that you use the model VA-WH-1 mounting bracket (sold separately) to install the camera. Contact the place where you purchased the camera for further details.

### ④ Caution indicator (See page 9)

Flashes or lights to indicate the operating status of the camera.

### ⑤ Lens

### ⑥ Cooling fan

A cooling fan is provided in order to prevent the inside of the camera from overheating. If the cooling fan stops, stop the camera and check the cause of the problem.

### ① Control terminals

These terminals are used to connect extra items such as hold-up and suspicion switches, a warning indicator or a 13.8 V DC power supply.

### ② RS-232C connector (RS-232C)

This connector is used to connect the camera to a computer in order to transfer images from the camera to the computer.

### ③ USB connector (USB)

This connector is used to connect a computer in order to transfer images from the camera to the computer.

If the RS-232C connector and USB connector are both connected at the same time, the USB connector has priority for image data transfer.

### ④ Rear cover fixing screw

This screw is used when replacing the hard disk or the Ni-Cd backup battery.

**Note:** Never open the rear cover while power is being supplied to the camera. Always be sure to set the hard disk to standby mode before opening the rear cover. (See page 11)



## ■ Control terminals

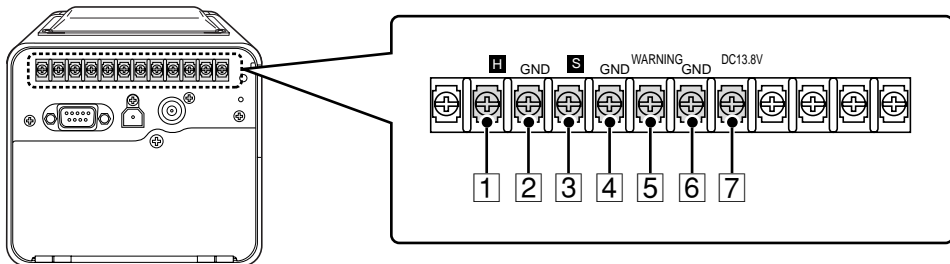

### 5 VIDEO OUT terminal (BNC plug)

This terminal is used to connect the camera to a component such as a monitor or camera control unit.

### 6 RESET button

Press the RESET button if an abnormality occurs with the camera. Settings are not changed when the camera is reset in this way.

### 7 Warning indicator

- The warning indicator lights when the camera power is turned on.
- It flashes when there is a hard disk error or if there is a problem with the backup battery.

	Terminal	Signal	Input/output voltage
1	H (HOLD-UP)	Alarm switch input signal	2.5 V or higher when alarm switch off/ 0.4 V or lower when alarm switch on
2	GND	Alarm switch and suspicion switch ground	0 V
3	S (SUSPICION)	Suspicion switch input signal	2.5 V or higher when suspicion switch off/ 0.4 V or lower when suspicion switch on
4	GND	Warning ground	0 V
5	WARNING	Warning signal output	3.3 V or higher when warning generated
6	GND	Power supply ground	0 V
7	DC 13.8 V	Power supply input	13.8 V DC

# WARNING DISPLAYS

There is a caution indicator and a warning indicator on the front and back of the camera. These indicators operate to notify you of the operating status of the camera and of any cautions and warnings. In addition, text messages indicating warnings are also displayed on the monitor screen in conjunction with the flashing speed of the indicators.

A separate indicator can be connected to the WARNING terminal to let you check the same warning statuses as shown by the built-in warning indicator.

If the warning indicator continues flashing, it indicates that there is a problem with the camera.

If this happens, maintain the camera in the same status and contact the place of purchase.

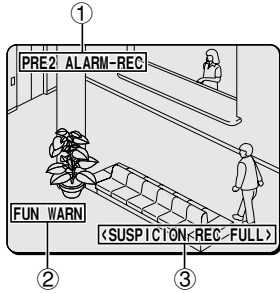
Monitor display	Indicator			Camera status
	Warning	Caution (ON)	Caution (OFF)	
	Off	Off	Off	Hard disk at standby
	Lights	Lights	Off	When MAIN MENU screen displayed When SETTINGS screen displayed During playback During pre-alarm or post-alarm recording
	Lights	Fast flashes	Off	During suspicion recording
	Slow flashes	Lights	Off	<ul style="list-style-type: none"> <li>① When post-alarm recording is complete and pre-alarm 2 recording has started (suspicion recording possible)</li> <li>② When the cooling fan has stopped (alarm/suspicion recording possible)</li> <li>③ When suspicion recording is complete (alarm recording possible)</li> </ul>
	Slow flashes	Slow flashes	Off	When computer connected When computer connected (during data transmission) (*)

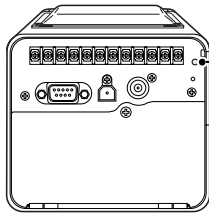

Warning indicator

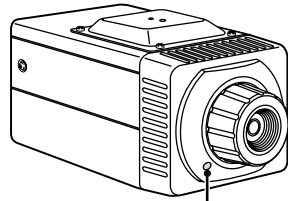

Caution indicator

Monitor display	Indicator			Camera status
	Warning	Caution (ON)	Caution (OFF)	
	Fast flashes	Fast flashes	Off	<p>④ When there is 20 minutes or less of recording time remaining in the post-alarm recording area, or When post-alarm 2 recording is complete (suspicion recording possible)</p> <p>⑤ When there is a problem with the camera hardware (recording is not possible)</p> <p>⑥ When there is a problem with the hard disk (recording is not possible)</p> <p>⑦ When Ni-Cd battery is not installed or not connected (NO BATT) When there is a problem with the Ni-Cd battery (LOW BATT)</p> <hr/> <p>When time setting has not been carried out</p> <p>During hard disk initialization (✱)</p> <p>During memory card initialization</p>

**Note:** If you do not need the caution indicator to operate (lighting or flashing), you can set it to remain off at all times by setting CAUTION LED to "OFF" in the SYSTEM SET screen.  
However, the ✱ mark indicates times when the caution indicator flashes regardless of the CAUTION LED setting.

# INSTALLING AND HANDLING THE Ni-Cd BACKUP BATTERY

---

The Ni-Cd battery which is supplied with the camera is used as a backup power supply for the clock and the hard disk.

The battery has not been charged. Before turning on the camera power, install the battery by referring to the points below. If any problems with battery operation or leakages of battery fluid occur, contact the place of purchase.

## Note:

- Once the camera's power has been turned on and left on for 24 hours, the battery will be charged sufficiently to provide 30 days of backup operation.
- If the battery is used continuously for long periods, leakage of battery fluid may occur. The interior of the battery compartment is lined with absorbent material to absorb any fluid which should happen to leak from the battery, so if replacing the battery after a leak has occurred, be sure to replace this absorbent material also.
- Always be sure to use the accessory AC adapter. If you use some other commercially-available AC adapter, detection of problems with the backup battery will not be possible, and damage to the hard disk may result.
- If the camera power supply is turned off or a power outage occurs after the battery has only been charging for a short time, it may cause the clock setting to be re-initialized. If this happens, the camera will not operate.
- Never open the rear cover while power is being supplied to the camera. Always be sure to set the hard disk to the standby condition before opening the rear cover. (See page **18**)

## (Warning displays)

- When the camera power is turned on after the battery has been replaced, "**LOW BATT**" will appear on the monitor screen, and charging of the battery will start automatically.
- Approximately 1 hour of charging time is needed before the "**LOW BATT**" display disappears from the monitor screen. If the "**LOW BATT**" display does not disappear after one hour or more has passed, it may indicate a problem with the battery.
- If "**LOW BATT**" appears on the monitor screen while the camera is in use, the warning indicator will flash and recording of images will be halted. This may also indicate a problem with the battery, so replace the battery at such times.
- If the battery has not been installed, or if the battery terminal contacts are not complete, "**NO BATT**" will appear on the monitor display. If this happens, check the battery once more.

## ■ Installing the Ni-Cd battery

- 1 Loosen the rear cover fixing screw (A) and open the cover. (The screw cannot be removed from the cover.)
- 2 Insert the battery into the battery compartment so that the Ni-Cd battery label is facing upward.

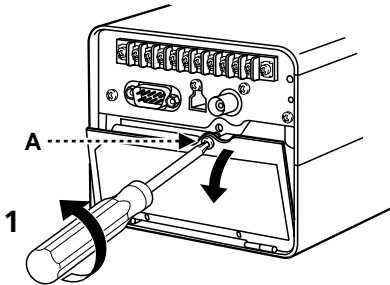

- 3 Connect the battery plug to the connector.
- 4 Close the rear cover and tighten the rear cover fixing screw (A).

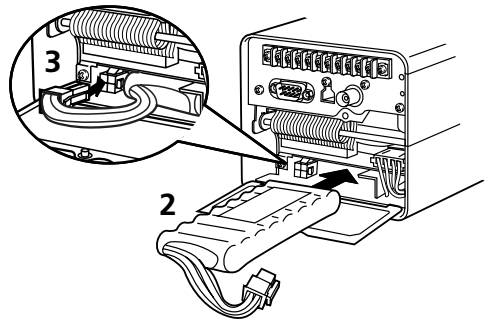

## ■ WARNING

- Do not short the battery terminals and do not attempt to disassemble or modify the battery.
- Do not drop the battery or subject it to strong shocks.
- Do not place the battery into fire, as it may explode.
- Do not expose the battery to moisture.
- Do not place the battery into water or let the terminals of the battery get wet.

## ■ DANGER

The following precautions must be observed at all times, otherwise the battery may leak, overheat or explode.

- Never peel off or scratch the outer tube.
- Do not use in any other appliance except for this camera.
- Do not carry the battery by holding the connectors or lead wires.

If the fluid inside the battery gets into eyes, it may cause blindness. Do not rub the eyes, wash the affected area immediately with clean water, and then seek medical advice.

If the fluid inside the battery gets onto the skin or clothing, it may injure the skin, so wash the affected area immediately with clean water.

# CONNECTIONS

Carefully read the documentation which is provided with each of the components being connected. Be careful to connect components correctly, as incorrect connections could cause fire or other damage.

## Basic connections

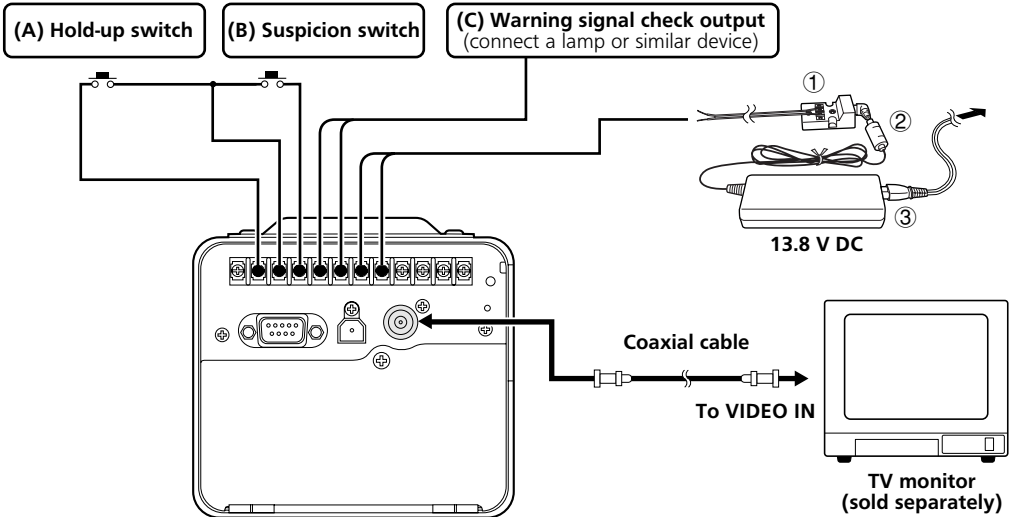

**Connect all required devices to the control terminals before turning on the power.**

- (A) Connect a commercially-available hold-up switch (H/GND).
- (B) Connect a commercially-available suspicion switch (S/GND).
- (C) Connect a commercially-available monitoring lamp to the warning signal output terminal. This will light or flash in the same way as the warning indicator on the rear of the camera for checking purposes.

## Connecting the power supply

- ① Connect a commercially-available cable to the relay connector (supplied), and then connect the cable to the power supply connector (13.8 V/GND) of the camera.
- ② Insert the plug of the AC adaptor (supplied) into the relay connector terminal.
- ③ Insert one end of the power cord (supplied) into the AC adaptor, and insert the other end into a wall outlet.

### Note:

- The cable that is connected to the relay connector can be up to a maximum of 30 meters in length, but it should not be bound up with any other cables.
- Use UL NISPT-2 (2/18AWG, 105° CM, VW-1) cables which are listed in UL as the connection cables.

## ■ Connection to a computer

If the camera is connected to a computer, you can then use the accessory application software to perform operations such as data transfer and printing of images by the computer.

The method of connecting the power supply and peripheral devices is the same as described in "Basic connections".

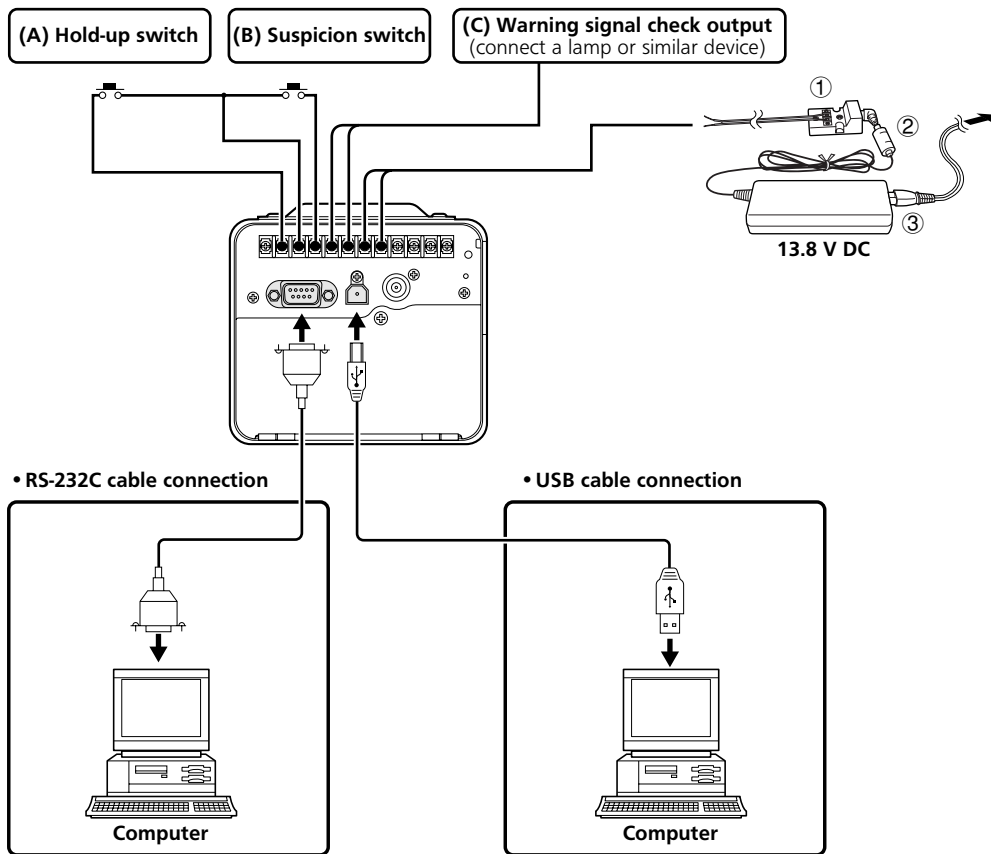

### Note:

- When connecting an RS-232C cable, it may be necessary to use a separate conversion adaptor depending on the type of computer being used.
- When connecting a USB cable, take note of the differences in the shapes of the connectors at the computer end and at the camera end.
- Only connect a cable to the USB connector when using the application software. If the USB cable is connected to the camera at other times, normal operations such as recording cannot be carried out.

# HARD DISK

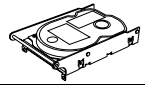

## ■ Hard disk recording areas

The camera records the images being viewed onto the hard disk.

The hard disk is divided into six areas (① ~ ④). The folder and file structure on the hard disk is as shown below.

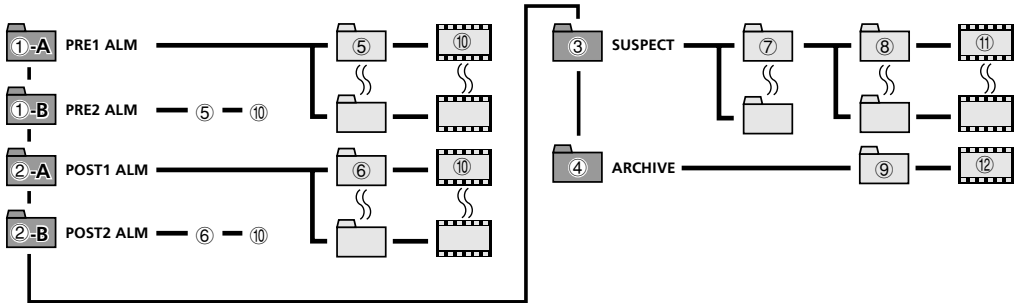

### ① Pre-alarm recording area

- A PRE1 ALM:** Pre-alarm images are recorded.
- B PRE2 ALM:** Backup pre-alarm images are recorded.

### ② Post-alarm recording area

- A POST1 ALM:** Post-alarm images are recorded.
- B POST2 ALM:** Backup post-alarm images are recorded.

### ③ Suspicion recording area

Images are recorded in this area during suspicion recording.

### ④ Archiving area

This area is used to store copies of images which have been recorded during alarm playback and suspicion playback.

### ⑤ Pre-alarm recording image folders (PRE1, 2 ALM)

A new folder is created every five minutes.

### ⑥ Post-alarm recording image folders (POST1, 2 ALM)

A new folder is created every five minutes.

### ⑦ Suspicion recording image folder 1

If the number of images saved in image folder 2 during suspicion recording reaches 99, then the next image folder 1 is created.

### ⑧ Suspicion recording image folders 2

A new image folder 2 is created each time suspicion recording is carried out. Up to 99 image folders can be created.

### ⑨ Archiving image folders

This folder is used to store copies of images which have been recorded during alarm playback and suspicion playback.

### ⑩ Pre-alarm and post-alarm recorded image files (PRE1, 2 ALM, POST1, 2 ALM)

Image files recorded during a five-minute period are saved in a single one of these folders.

### ⑪ Suspicion recording image files (SUSPECT)

Up to 900 image files (1 FPS: 15 minutes, 3FPS: 5 minutes) are created during suspicion recording. Once 900 images have been saved, the next image folder 2 is created.

### ⑫ Archive recorded image files (ARCHIVE)

Only one image folder is created in the archive recording area. Up to 500 archive recording images can be created and stored in this image folder.



## ■ Protecting the hard disk

When you have finished using the camera, set the hard disk to standby mode before turning off the power. If the camera power is turned off at the following times when recording or playback is in progress, damage to the hard disk may result. (See page 18)

- When the Ni-Cd battery has not been charged for long enough
- When camera operation is stopped immediately after the battery has been replaced

## Checking the hard disk

A hard disk check is carried out automatically when the camera power is turned on in order to see if there are any problems with the formatting of the hard disk. If a problem with the hard disk is detected, "**CHECKING DISK!**" is displayed on the monitor screen. If this happens, reformat the hard disk, or if the hard disk contains images that you need to save, contact the place of purchase for assistance.

The hard disk is sensitive to dust, vibration and shocks, and it should also not be used in the vicinity of items which generate magnetic fields. Be sure to observe the following in order to minimize the risk of data losses.

- Do not subject the hard disk to shocks.
- Do not use the camera in places which are unstable or subject to vibration.
- Do not move the camera while the power is still turned on.
- Do not disconnect the power cord from the power supply while recording or playback is in progress.
- Do not use the camera in places which are prone to sudden changes in temperature (changes of more than 10 °C in one hour).
- If moving the camera to a place which has high humidity or which is subject to large fluctuations in humidity, condensation may form inside the camera. If the camera is used while there is condensation inside the camera, it may result in camera malfunctions.
- Do not install the camera in places which are subject to vibration, such as inside vehicles or trains.

## ■ The built-in hard disk, cooling fan and Ni-Cd battery are consumable.

- These parts should generally be replaced after 2 years of operation at an ambient temperature of 25 °C. This replacement period is a guide only, and is not a guarantee that performance will be maintained during the whole of the time.
- If the ambient temperature is 40 °C, the Ni-Cd battery should generally be replaced after one year.

# FROM RECORDING TO PLAYBACK

When using this camera for recording and playback for the first time, follow the steps given below. Refer to the reference pages given for more details on each step.

## 1 Turn on the power. (See page 13)

The camera itself does not have a power switch. Connect the accessory AC adaptor and relay connector, and then insert the power plug into a wall outlet.

## 2 Set the date and time. (See page 22)

Recording is not possible until the time has been set.

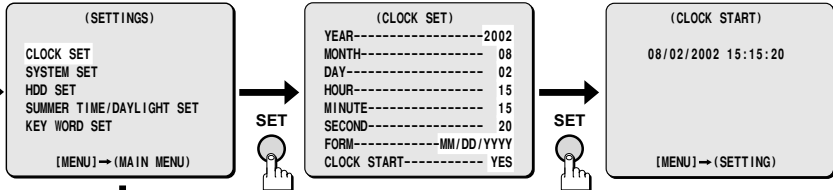

## 3 Record the images. (See page 39)

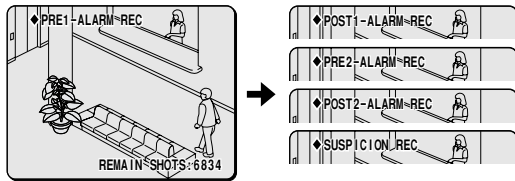

## 4 Selection

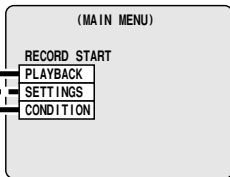

## 7 Set the hard disk to the standby condition when you have finished using the camera. (See page 18)



## 5 Play back the recorded images. (See page 49)

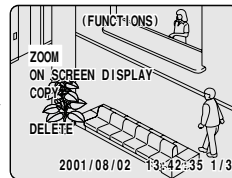
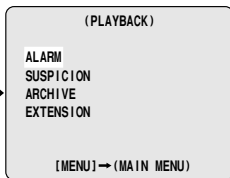

## 6 View details of the time and the hard disk recording capacity. (See page 37)

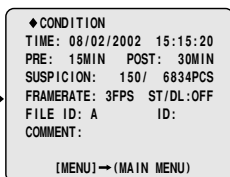

# HARD DISK STANDBY MODE

When shooting or recording ends, switch the hard disk to standby mode.

## ■ Setting to standby mode

### 1 Press the **MENU** button.

The MAIN MENU screen will be displayed.

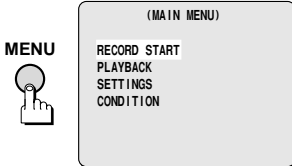

### 2 While pressing the **MENU** button, press the **SET** button.

After the current image has been recorded on the hard disk, the disk will change to standby mode. During recording, the message "DISK CLOSING" will be displayed for approximately 2 seconds.

Furthermore, the warning indicator and caution indicator will both switch off while the hard disk is in standby mode.

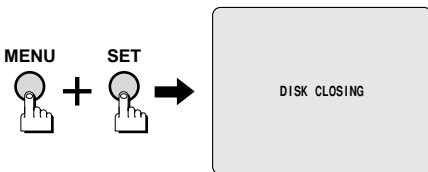

#### Note:

- The caution indicator will flash until the hard disk changes to standby mode. None of the setting details will change when the hard disk is in standby mode.
- This operation (DISK CLOSING) cannot be carried out using the camera control unit (sold separately).

## ■ Canceling standby mode

If you press the **MENU** button, the MAIN MENU screen will be displayed.

To start pre-alarm recording, select RECORD START and then press the **SET** button. Furthermore, if the MAIN MENU screen remains displayed for 30 seconds, the camera will change automatically to pre-alarm recording.

### Press the **MENU** button.

Pre-alarm recording will then start.

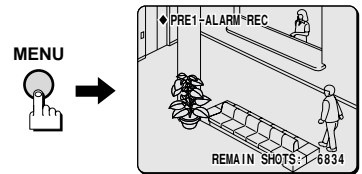

**Note:** The warning indicator and caution indicator will both flash while the hard disk contents are being checked. When pre-alarm recording starts, the caution indicator will light.

MEMO .....

.....

.....

.....

.....

.....

.....

.....

.....

.....

.....

.....

.....

.....

.....

.....

---

# MENU SETTINGS

---

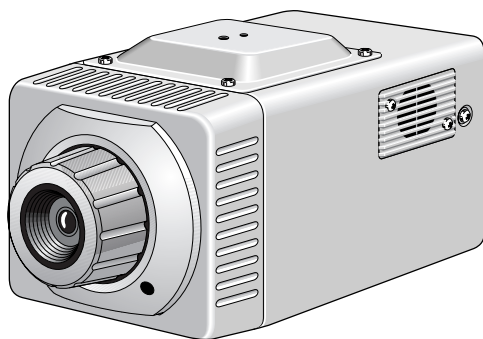



# SETTING THE CLOCK (CLOCK SET)

You need to set the date and time in order to use the camera. The recording functions of this camera cannot be used if the date and time have not been set. In addition, if the accessory Ni-Cd battery (for backup) which is used for running the clock and for hard disk backups has been replaced, you must reset the clock.

- The setting time is displayed when "CONDITION" is selected from the MAIN MENU screen.

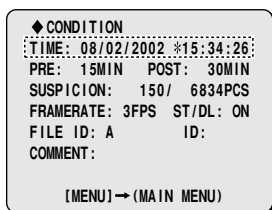

**Note:** The clock is set when the camera is first used, but if summer time has been set, the time will advance by one hour automatically during the summer time application period, so you may need to reset the clock.

**Setting example: To set the clock to 15:15:20 on 2 August 2002**

Press the **MENU** button to return to the SETTING screen.

**1** Use the **CURSOR (▼)** button to select "SETTINGS" and then press the **SET** button.  
The SETTINGS screen will be displayed.

**2** Use the **CURSOR (▼)** button to select "CLOCK SET" and then press the **SET** button.  
The CLOCK SET screen will be displayed.

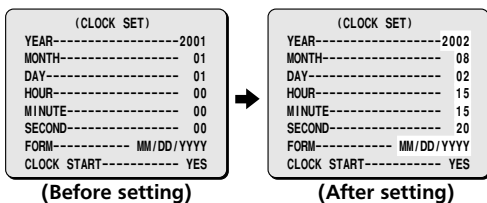

**3** Use the **CURSOR (▼)** button to select "YEAR ... 2001" and then use the **CURSOR (◀ or ▶)** button to set the year to "2002".

**4** Use the **CURSOR (▼)** button to select "MONTH ... 01" and then use the **CURSOR (◀ or ▶)** button to set the month to "08".

**5** Use the **CURSOR (▼)** button to select "DAY ... 01" and then use the **CURSOR (◀ or ▶)** button to set the day to "02".

**6** Use the **CURSOR (▼)** button to select "HOUR ... 00" and then use the **CURSOR (◀ or ▶)** button to set the hour to "15".

**7** Use the **CURSOR (▼)** button to select "MINUTE ... 00" and then use the **CURSOR (◀ or ▶)** button to set the minutes to "15".

**8** Use the **CURSOR (▼)** button to select "SECOND ... 00" and then use the **CURSOR (◀ or ▶)** button to set the seconds to "20".

**9** Use the **CURSOR (▼)** button to select "FORM ... MM/DD/YYYY" and then use the **CURSOR (◀ or ▶)** button to set the desired format.

- YYYY/MM/DD: Year/Month/Day
- MM/DD/YYYY: Month/Day/Year
- DD/MM/YYYY: Day/Month/Year

**10** Use the **CURSOR (▼)** button to select "CLOCK START ... YES" and then press the **SET** button.

The CLOCK START screen will be displayed, and the date and time which have been set will appear on the screen. The camera will return to recording mode after approximately 30 seconds.

If you select "NO", the clock setting will not be changed, and the screen will return to the SETTINGS screen.

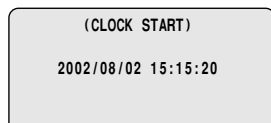

# SYSTEM SETTINGS (SYSTEM SET)

Several different system settings can be made as indicated below. When these settings are made, the screen display appears as shown in the accompanying illustrations.

- ① Setting the backlight compensation
- ② Setting the front caution indicator to stay off during recording
- ③ Changing the frame rate for suspicion recording
- ④ Setting the overwriting conditions and warning displays or suspicion recordings
- ⑤ Changing the flickerless setting

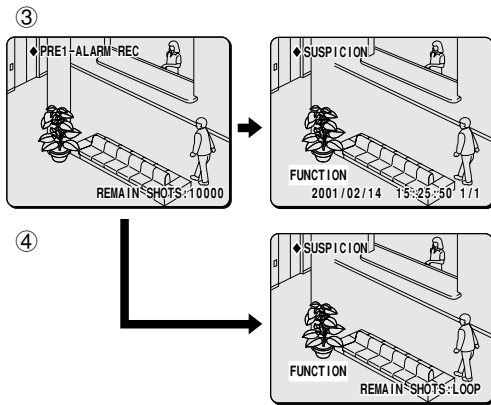

Press the **MENU** button to return to the **SETTING** screen.

- 1** Use the **CURSOR (▼)** button to select **"SETTINGS"** and then press the **SET** button.  
The **SETTINGS** screen will be displayed.
- 2** Use the **CURSOR (▼)** button to select **"SYSTEM SET"** and then press the **SET** button.  
The **SYSTEM SET** screen will be displayed.
  - The various items can be selected by pressing the **SET** button.

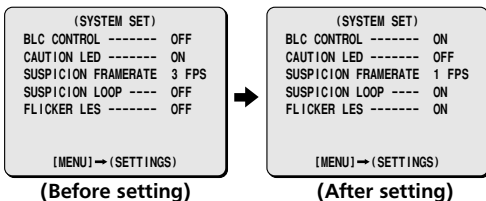

- 3** Use the **CURSOR (▼)** button to select **"BLC CONTROL ... OFF"** and then use the **CURSOR (◀ or ▶)** button to select **"ON"**.  
**ON:** Backlight compensation is carried out.  
**OFF:** Backlight compensation is not carried out.

- 4** Use the **CURSOR (▼)** button to select **"CAUTION LED ... ON"** and then use the **CURSOR (◀ or ▶)** button to select **"OFF"**.  
**ON:** The caution indicator lights.  
**OFF:** The caution indicator stays switched off.  
The screen display will also disappear during recording.

- 5** Use the **CURSOR (▼)** button to select **"SUSPICION FRAMERATE ... 3"** and then use the **CURSOR (◀ or ▶)** button to select **"1"**.  
**1 FPS:** Images are recorded at the rate of 1 per second.  
**3 FPS:** Images are recorded at the rate of 3 per second.

- 6** Use the **CURSOR (▼)** button to select **"SUSPICION LOOP ... OFF"** and then use the **CURSOR (◀ or ▶)** button to select **"ON"**.  
**ON:** Old images are deleted and overwritten.  
**OFF:** A warning is given and old images are not overwritten. (See page 47)

- 7** Use the **CURSOR (▼)** button to select **"FLICKER LESS ... OFF"** and then use the **CURSOR (◀ or ▶)** button to select **"ON"**.  
**ON:** Image flickering is reduced.  
**OFF:** Image flickering is not reduced.

- 8** When all settings have been completed, press the **MENU** button to return to the **SETTINGS** screen.



# HARD DISK CAPACITY SETTINGS (HDD SET)

Hard disk initialization settings are shown in Figure 1. This section explains how to change the hard disk recording capacity and how to initialize the hard disk.

## ■ Hard disk initialization

If the hard disk is initialized, all data which has been recorded on the hard disk up to that point will be erased. When initializing the hard disk, always be sure to transfer any recorded image data to a computer before doing the initialization.

Hard disk initialization requires a password to be entered before the initialization is carried out, in order to protect the image data. See page 32 for details on setting the password.

Press the **MENU** button to return to the SETTING screen.

- 1 Use the **CURSOR** (**▲** or **▼**) button to select **"SETTINGS"** and then press the **SET** button.

The SETTINGS screen will be displayed.

- 2 Use the **CURSOR** (**▲** or **▼**) button to select **"HDD SET"** and then press the **SET** button.

The HDD SET screen will be displayed.

- 3 Use the **CURSOR** (**▲** or **▼**) button to select **"INITIALIZE"** and then press the **SET** button.

The INITIALIZE screen will be displayed, and you will be prompted to enter the password.

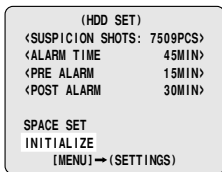

(Fig. 1)

- 4 Use the **CURSOR** button and the **SET** button to select the password characters from the character palette.

"\*" characters will appear in the password entry box.

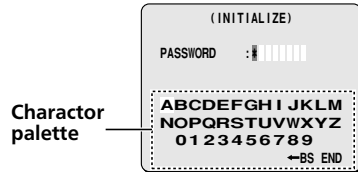

- 5 Use the **CURSOR** (**▲** or **▼**) button to select **"END"** and then press the **SET** button.

The HDD INITIALIZE screen will be displayed.

- 6 Use the **CURSOR** button to set the capacity of the alarm recording area.

**Example:**

- ① Set the **PRE ALARM** item to 45 minutes.
  - ② Set the **POST ALARM** item to 20 minutes.
- The **"SUSPICION SHOTS"** and **"ALARM TIME"** settings will be made automatically.

- 7 Use the **CURSOR** (**▲** or **▼**) button to select **"INITIALIZE"** and then use the **CURSOR** (**◀** or **▶**) button to select **"YES"** and then press the **SET** button.

The hard disk will be initialized, and the display will then return to the SETTINGS screen.

If you select **"NO"**, the display will return to the HDD SET screen.

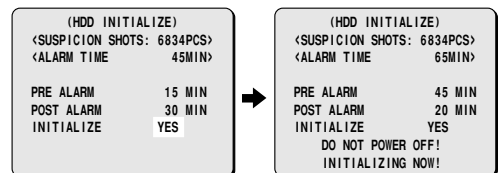

# HARD DISK CAPACITY SETTINGS (HDD SET)

## ■ Changing the alarm capacity

After the hard disk has been initialized and when no post-alarm images have yet been recorded in the pre-alarm recording area of the hard disk, "SPACE SET" will be displayed on the screen.

If "SPACE SET" is displayed on the screen, you can then change the alarm capacity. If images have been recorded in the post-alarm recording area, then the alarm capacity cannot be changed. Delete the alarm images or initialize the hard disk before changing the alarm recording area capacity.

- 1** Use the **CURSOR (▲ or ▼)** button to select "SETTINGS" and then press the **SET** button.

The SETTINGS screen will be displayed.

- 2** Use the **CURSOR (▲ or ▼)** button to select "HDD SET" and then press the **SET** button.

The HDD SET screen will be displayed.

- 3** Use the **CURSOR (▲ or ▼)** button to select "SPACE SET" and then press the **SET** button.

The SPACE SET screen will be displayed.

- 4** Use the **CURSOR** button to reset the capacity of the alarm recording area.

**Example:**

- ① Set the **PRE ALARM** item to 30 minutes.
- ② Set the **POST ALARM** item to 40 minutes.

The "SUSPICION SHOTS" and "ALARM TIME" settings will be made automatically.

**Note:** If some images have already been recorded in the suspicion recording area, the setting time for the alarm recording capacity will change.

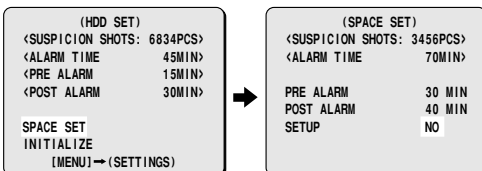

- 5** Use the **CURSOR (▲ or ▼)** button to select "SETUP" and then use the **CURSOR (◀ or ▶)** button to select "YES" and then press the **SET** button.

The capacity of the alarm recording area will be changed, and the SPACE SET screen will be displayed.

If you select "NO", the display will return to the HDD SET screen.

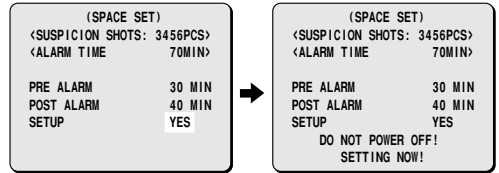

# SUMMER TIME SETTINGS (SUMMER TIME/DAYLIGHT SET)

Summer time settings include the time when summer time is to start and when it is to end. When summer time has been set, the setting time will change automatically between standard time and summer time. When image that have been recorded while summer time is active are being played back, a “\*” will appear in front of the time display.

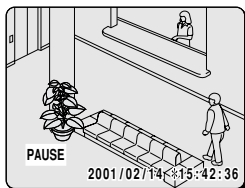

**Setting example:** Start time: 2 p.m. on the last Sunday in March  
End time: 2 p.m. on the 4th Sunday in October

**1** Use the CURSOR (▼) button to select “SETTINGS” and then press the SET button.  
The SETTINGS screen will be displayed.

**2** Use the CURSOR (▲ or ▼) button to select “SUMMER TIME/DAYLIGHT SET” and then press the SET button.  
The SUMMER TIME/DAYLIGHT SET screen will be displayed.

(SUMMER TIME/DAYLIGHT SET)				
MODE	-----			OFF
	(START)	(END)		
WEEK	1ST	LAST		
	SUN	SUN		
MONTH	04	10		
HOUR	02	02		
MINUTE	00	00		

**3** Use the CURSOR (◀ or ▶) button to set “MODE ... ON”.  
The “START” setting will be displayed.

(SUMMER TIME/DAYLIGHT SET)				
MODE	-----			ON
	(START)	(END)	START	
WEEK	1ST	LAST	1ST	
	SUN	SUN	SUN	
MONTH	04	10	04	
HOUR	02	02	02	
MINUTE	00	00	00	

(Start time setting)

**4** Use the CURSOR (▼) button to select “START”.

**5** Use the CURSOR (▼) button to select “WEEK 1ST”, and then use the CURSOR (◀ or ▶) button to select “LAST”.  
Display: 1ST, 2ND, 3RD, 4TH, LAST

**6** Use the CURSOR (▼) button to select “WEEK SUN”.  
Display: SUN, MON, TUE, WED, THU, FRI, SAT

**7** Use the CURSOR (▼) button to select “MONTH 04” and then use the CURSOR (◀ or ▶) button to set the month to “03”.  
Display: 1, 2, 3 ... 12

**8** Use the CURSOR (▼) button to select “HOUR 02” and then use the CURSOR (◀ or ▶) button to set the hour to “14”.  
Display: 00, 01, 02, 03 ... 22, 23

**9** Use the CURSOR (▼) button to select “MINUTE 00”.  
Display: 00, 01, 02, 03 ... 58, 59

(SUMMER TIME/DAYLIGHT SET)				
MODE	-----			ON
	(START)	(END)	START	
WEEK	LAST	LAST	LAST	
	SUN	SUN	SUN	
MONTH	03	10	03	
HOUR	14	02	14	
MINUTE	00	00	00	

# SUMMER TIME SETTINGS (SUMMER TIME/DAYLIGHT SET)

(End time setting)

**10** Use the CURSOR (▲ or ▼) button to select "START", and then use the CURSOR (◀ or ▶) button to select "END".

**11** Use the CURSOR (▼) button to select "WEEK LAST", and then use the CURSOR (◀ or ▶) button to select "4TH".

**12** Use the CURSOR (▼) button to select "WEEK SUN".

**13** Use the CURSOR (▼) button to select "MONTH 10".

**14** Use the CURSOR (▼) button to select "HOUR 02" and then use the CURSOR (◀ or ▶) button to set the hour to "14".

**15** Use the CURSOR (▼) button to select "MINUTE 00".

**16** When all settings have been completed, press the MENU button to return to the SETTINGS screen.

Keep pressing the MENU button to return to the MAIN MENU screen.

(SUMMER TIME/DAYLIGHT SET)						
MODE	-----					ON
	(START)	(END)	:	END:		
WEEK	1ST	LAST	:	LAST:		
	SUN	SUN	:	SUN:		
MONTH	04	10	:	10:		
HOUR	02	02	:	02:		
MINUTE	00	00	:	00:		

(SUMMER TIME/DAYLIGHT SET)						
MODE	-----					ON
	(START)	(END)	:	END		
WEEK	LAST	LAST	:	4TH		
	SUN	SUN	:	SUN		
MONTH	03	10	:	10		
HOUR	14	14	:	14		
MINUTE	00	00	:	00		

## Notes on summer time settings

When changing the current time setting using the CLOCK SET screen, you cannot change it to a time which is within one hour after the time when summer time has been set to start. If you try to set the time in this way, the time displayed will be changed automatically to a setting which is one hour after the time that you have actually set.

Furthermore, if you change the current time to a time which is at least one hour before the time when summer time has been set to end, the time will be displayed exactly as you have set it.

**For example:** If summer time has been set to start at 2.00 and you change the current time setting to 2.30 (the time becomes 3.30), then time settings between 2.00 and 2.59 will be carried out automatically.

**For example:** If summer time has been set to end at 2.00 and you change the current time setting to 1.30 (the time becomes 1.30), then in this case you cannot set the time to between 1.00 and 1.59.

(SUMMER TIME/DAYLIGHT SET)						
MODE	-----					ON
	(START)	(END)	:	START:		
WEEK	1ST	LAST	:	FAST:		
	SUN	SUN	:	SUN:		
MONTH	04	10	:	04:		
HOUR	02	02	:	02:		
MINUTE	00	00	:	00:		

(CLOCK SET)	
YEAR	-----2002
MONTH	-----08
DAY	-----02
HOUR	-----02
MINUTE	-----30
SECOND	-----00
FORM	----MM/DD/YYYY
CLOCK START	----- YES

(CLOCK START)	
2002/08/02 #3:30:00	
[MENU]→(SETTING)	

**Note:** If the start time (START) and end time (END) settings are the same, the time will not change between standard time and summer time, and the ST/DL setting in the CONDITION will be set to "OFF".

# KEY WORD SETTING (KEY WORD SET)

These settings are useful for identifying image data when transferring it to a computer. In addition, the key word setting status and the settings for the alarm recording area on the hard disk can be confirmed at the CONDITION screen. You can also set passwords to protect important image data.

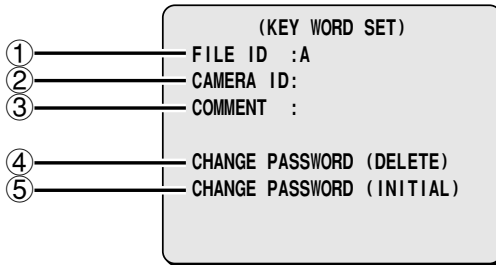

- ① **FILE ID:** The file ID is initially set to "A". You can set a single character to appear at the front of the file when transferring images which have been recorded by this camera to a computer.
- ② **CAMERA ID:** When this camera is one of several cameras being used, up to five characters can be specified as the identifying name for the camera. This is useful for identifying image data.
- ③ **COMMENT:** When this camera is one of several cameras being used, you can enter a comment of up to 36 characters to describe the setting-up location for the camera.
- ④ **CHANGE PASSWORD (DELETE):** If necessary, you can set a password which must be entered in order to delete files. This password can be up to eight characters long.
- ⑤ **CHANGE PASSWORD (INITIAL):** You can set a password which must be entered in order to initialize the hard disk. This password can be up to eight characters long. When the hard disk is initialized, all data on the hard disk is deleted, so it is highly recommended that this password be set by the camera operator.

## About passwords

When using the camera for the first time, you can use the **CURSOR** button to select "END" from the character palette and then press the **SET** button to continue editing and deleting images without having to set a password. You only have to set a password if you think that a password might be needed.

# KEY WORD SETTING (KEY WORD SET)

## ■ Entering a file ID (1 character)

Example: To enter "P" as the file ID

- 1 Use the CURSOR (▲ or ▼) button to select "SETTINGS" and then press the SET button.

The SETTINGS screen will be displayed.

- 2 Use the CURSOR (▲ or ▼) button to select "KEY WORD SET" and then press the SET button.

The KEY WORD SET screen will be displayed.

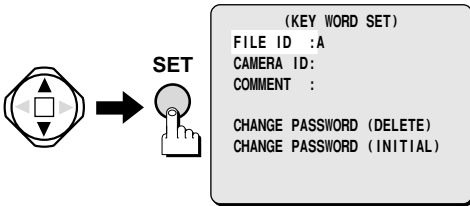

- 3 Use the CURSOR (▼) button to select "FILE ID" and then press the SET button.

You can then set the file ID in the KEY WORD SET screen.

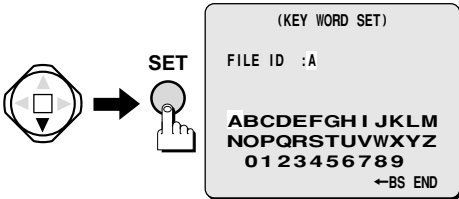

- 4 Use the CURSOR button to select the letter "P" from the character palette and then press the SET button.

When the character has been set, the cursor will move automatically to "END".

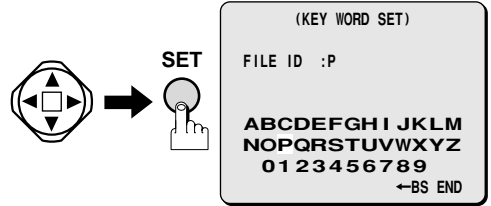

- 5 Press the SET button.

The display will return to the KEY WORD SET screen.

- 6 When all settings have been completed, press the MENU button to return to the KEY WORD SET screen.

Keep pressing the MENU button to return to the MAIN MENU screen.

## ■ Setting a camera ID (5 characters)

Example: To set the camera ID to "HALL1"

- 1** Use the CURSOR (▼ or ▲) button to select "SETTINGS" and then press the SET button.

The SETTINGS screen will be displayed.

- 2** Use the CURSOR (▲ or ▼) button to select "KEY WORD SET" and then press the SET button.

The KEY WORD SET screen will be displayed.

- 3** Use the CURSOR (▼) button to select "CAMERA ID" and then press the SET button.

You can then set the camera ID in the KEY WORD SET screen.

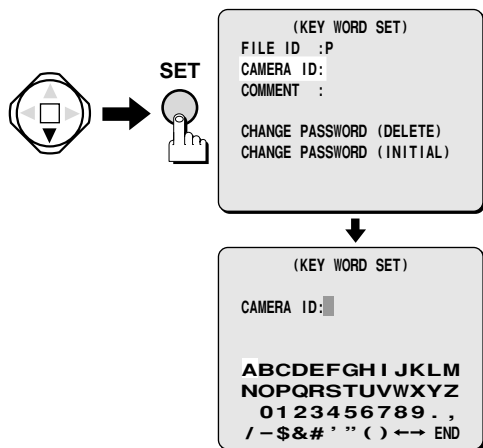

- 4** Use the CURSOR button to select the characters "H" in order from the character palette, and then press the SET button.

Enter "ALL1" in same way.

When five characters have been selected, the cursor will move automatically to "END".



- 5** Press the SET button.

The display will return to the KEY WORD SET screen.

- 6** When all settings have been completed, press the MENU button to return to the SETTINGS screen.

Keep pressing the MENU button to return to the MAIN MENU screen.

# KEY WORD SETTING (KEY WORD SET)

## ■ Entering a comments (up to 36 characters)

Example: Entering "SANYO DIGITAL RECORDING CAMERA" as a comment

**1** Use the **CURSOR** (▼ or ▲) button to select "SETTINGS" and then press the **SET** button.

The SETTINGS screen will be displayed.

**2** Use the **CURSOR** (▲ or ▼) button to select "KEY WORD SET" and then press the **SET** button.

The KEY WORD SET screen will be displayed.

**3** Use the **CURSOR** (▼) button to select "COMMENT" and then press the **SET** button.

You can then set the comment in the KEY WORD SET screen.

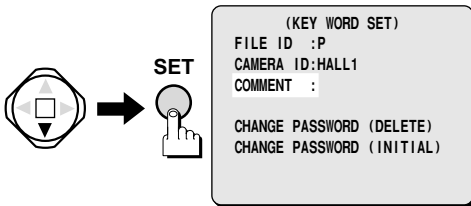

**4** Use the **CURSOR** button and the **SET** button to select "SANYO DIGITAL RECORDING CAMERA" from the character palette.

① Use the **CURSOR** button to select "S" and then press the **SET** button. Enter "ANYO" in the same way.

② Use the **CURSOR** button to select the blank character below the letter "N" and then press the **SET** button.

A space will be inserted after "SANYO". Enter "DIGITAL RECORDING CAMERA" in the same way. Enter spaces in the first line in order to move to the second line.

③ Use the **CURSOR** button to select "END" and then press the **SET** button. The display will return to the KEY WORD SET screen.

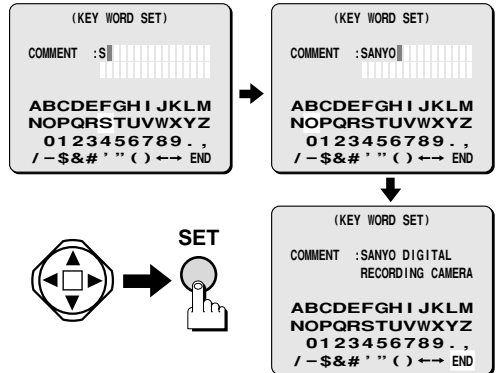

**5** When all settings have been completed, press the **MENU** button to return to the **KEY WORD SET (for after setting)** screen.

Keep pressing the **MENU** button to return to the MAIN MENU screen.



## ■ Entering a password for deleting files (CHANGE PASSWORD (DELETE))

This password is used when "DELETE" is selected from the FUNCTIONS screen during image playback (ALARM, SUSPICION, ARCHIVE and EXTENSION).

The passwords are not set in the initial settings.

**Example: Set the password to "CAMERA".**

**1** Use the CURSOR (▼ or ▲) button to select "SETTINGS" and then press the SET button.

The SETTINGS screen will be displayed.

**2** Use the CURSOR (▲ or ▼) button to select "KEY WORD SET" and then press the SET button.

The KEY WORD SET screen will be displayed.

**3** Use the CURSOR (▼) button to select "CHANGE PASSWORD (DELETE)" and then press the SET button.

The cursor will move to the "OLD PASSWORD" box in the CHANGE PASSWORD-DELETE screen.

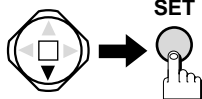
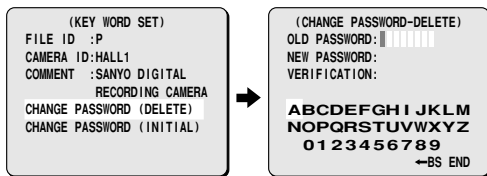

**4** Use the CURSOR (▼) button to select "END" and then press the SET button.

The initial setting "END" will be cleared and the cursor will move to the "NEW PASSWORD" box.

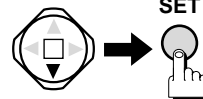
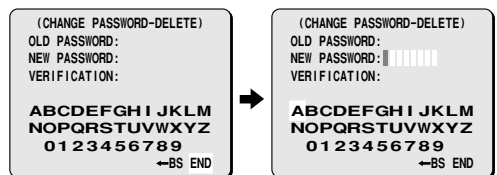

**5** Use the CURSOR button to select "C" and then press the SET button.

The selected letter will appear as "\*". Enter "AMERA" in the same way.

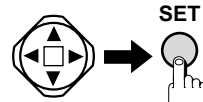
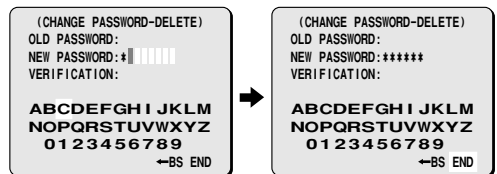

# KEY WORD SETTING (KEY WORD SET)

- 6** Use the **CURSOR (▼)** button to select **"END"** and then press the **SET** button.

The password (CAMERA) will appear as **"\*\*\*\*\*"** and the cursor will move to the **"VERIFICATION"** box.

This prompts you to verify that the password you have entered is correct.

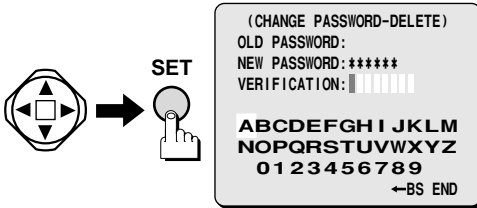

- 7** Use the **CURSOR** button and the **SET** button to enter **"CAMERA"** once more, and then select **"END"** and press the **SET** button.

The display will return to the **KEY WORD SET** screen and the password for deleting images will be set to **"CAMERA"**.

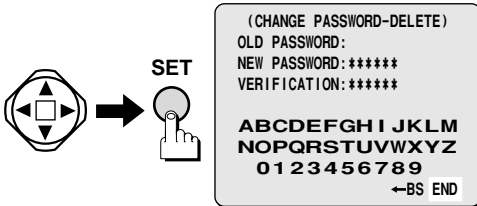

- 8** When all settings have been completed, press the **MENU** button to return to the **SETTINGS** screen.

Keep pressing the **MENU** button to return to the **MAIN MENU** screen.

## ■ Setting a password for initializing the hard disk (CHANGE PASSWORD (INITIAL))

This password is used when "INITIALIZE" is selected from the HDD SET screen.

**Example:** To change the initial setting of "END" to "CMR"

- 1 Use the CURSOR (▼ or ▲) button to select "SETTINGS" and then press the SET button.

The SETTINGS screen will be displayed.

- 2 Use the CURSOR (▲ or ▼) button to select "KEY WORD SET" and then press the SET button.

The KEY WORD SET screen will be displayed.

- 3 Use the CURSOR (▼) button to select "CHANGE PASSWORD (INITIAL)" and then press the SET button.

The cursor will move to the "OLD PASSWORD" box in the CHANGE PASSWORD-INITIALIZE screen.

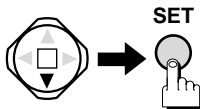
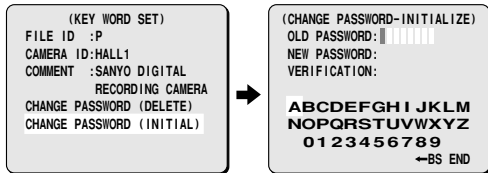

- 4 Use the CURSOR (▼) button to select "END" and then press the SET button.

The initial setting "END" will be cleared and the cursor will move to the "NEW PASSWORD" box.

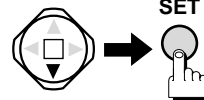
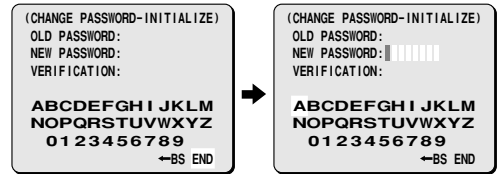

- 5 Use the CURSOR button to select "C" and then press the SET button.

The selected letter will appear as "\*". Enter "MR" in the same way.

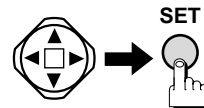
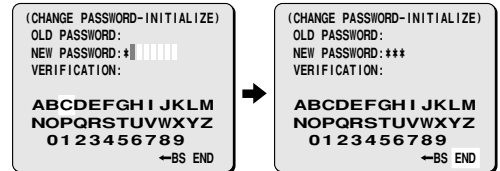

# KEY WORD SETTING (KEY WORD SET)

## 6 Use the CURSOR (▼) button to select "END" and then press the SET button.

The password (CMR) will appear as "\*\*\*" and the cursor will move to the "VERIFICATION" box.

This prompts you to verify that the password you have entered is correct.

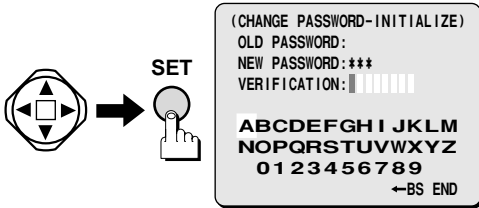

## 7 Use the CURSOR button and the SET button to enter "CMR" once more, and then select "END" and press the SET button.

The display will return to the KEY WORD SET screen and the password for initializing the hard disk will be set to "CMR".

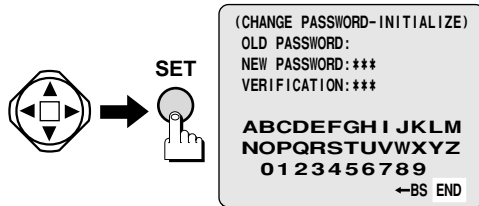

## 8 When all settings have been completed, press the MENU button to return to the SETTINGS screen.

Keep pressing the MENU button to return to the MAIN MENU screen.

## ■ Correcting characters

The following two character palettes are used:

☞ For CAMERA ID and COMMENT settings

```
(KEY WORD SET)
CAMERA ID:HALL1

ABCDEFGHIJKL
NOPQRSTUVWXYZ
0123456789. ,
/ - $ & # ' " ( ) ←→ END
```

☞ For PASSWORD or CAMERA ID setting

```
(CHANGE PASSWORD-DELETE)
OLD PASSWORD: █
NEW PASSWORD: █
VERIFICATION: █

ABCDEFGHIJKL
NOPQRSTUVWXYZ
0123456789
←BS END
```

Example: If DIGITAL has been entered as DIHITAL (using COMMENT palettes)

**1** Use the CURSOR button to select ← (or →) from the character palette.

```
(KEY WORD SET)
COMMENT :SANYO DIHITAL
          RECORDING CAMERA

ABCDEFGHIJKL
NOPQRSTUVWXYZ
0123456789. ,
/ - $ & # ' " ( ) ←→ END
```

**2** Keep pressing the SET button to select "H".  
The correction cursor (█) will move to "H".

```
(KEY WORD SET)
COMMENT :SANYO DIGITAL
          RECORDING CAMERA
          ←-----
ABCDEFGHIJKL
NOPQRSTUVWXYZ
0123456789. ,
/ - $ & # ' " ( ) ←→ END
```

**3** Use the CURSOR button to select "G" from the character palette and then press the SET button.

```
(KEY WORD SET)
COMMENT :SANYO DIGITAL
          RECORDING CAMERA

ABCDEFGHIJKL
NOPQRSTUVWXYZ
0123456789. ,
/ - $ & # ' " ( ) ←→ END
```

**4** Use the CURSOR button to select "END" from the character palette and then press the SET button.

When inserting spaces between characters, move the cursor to the blank character below the letter "N" and then press the SET button.

# CHECKING THE CAMERA SETTING STATUS

The principal settings can be viewed on-screen. To check the settings, use the **CURSOR** (▲ or ▼) button to select "**CONDITION**" from the MAIN MENU screen and then press the **SET** button.

- Press the **MENU** button to return to the MAIN MENU screen.

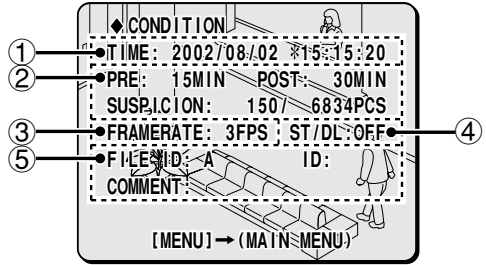
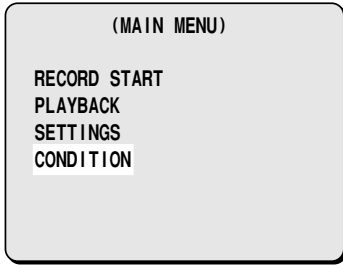

## ① Checking the CLOCK SET settings

This shows the current time that has been set. A "\*" in front of the time indicates that it is summer time.

## ② Checking the HDD SET settings

This shows the recording time for the alarm recording area, and also shows the remaining number of images that can be recorded.

- **PRE:** Shows the number of minutes of recording time for the pre-alarm recording area
- **POST:** Shows the number of minutes of recording time for the post-alarm recording area
- **SUSPICION:** Shows the recording number of images that can be recorded (left) in the suspicion recording area and the total recording number set (right)

## ③ Checking the SYSTEM SET settings

**FRAMERATE:** Shows the frame rate for suspicion recording

- **1 FPS:** 1 still image recording per second
- **3 FPS:** 3 still images recording per second

## ④ Checking the SUMMER TIME/DAYLIGHT SET settings

**ON:** Summer time is currently being used  
**OFF:** Summer time is not currently being used.

## ⑤ Checking the KEY WORD SET settings

- **FILE ID:** Shows the file ID that has been set
- **CAMERA ID:** Shows the camera ID that has been set
- **COMMENT:** Shows the comment which has been set

---

# SETTING THE RECORDING METHOD

---

**Note:**

- **Illumination**

The shutter speed for this camera is set automatically in accordance with the brightness of the object being recorded. If the object being recorded is moving and the resulting images are out of focus, increase the amount of illumination.

- **Image quality**

The images on the monitor screen comply with a digital image format (VGA equivalent: 640 x 480 dots), so the resolution will appear less sharp than images which are displayed on a computer screen.

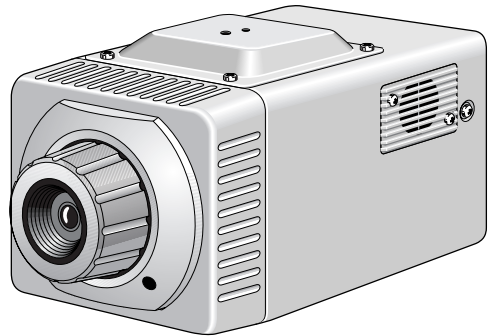

# SETTING THE RECORDING METHOD

**Before using this camera, make sure that you set the current date and time. Recording will not be possible if they have not been set. (See page 22)**

The images which are recorded by this camera (three images per second) are saved onto the hard disk. The initial settings for the hard disk are shown in the illustration, but each of the settings can be changed if required.

For details on changing the hard disk settings, refer to "HDD SET" in the SETTINGS screen. (See page 24)

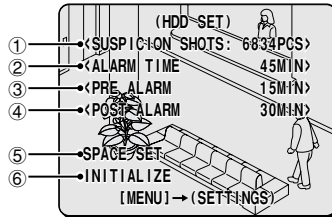

- ① Number of images that can be stored in the suspicion recording area
- ② Total recording time available in the alarm recording area
- ③ Recording time available in the pre-alarm recording area
- ④ Recording time available in the post-alarm recording area
- ⑤ Used for changing the alarm time (automatic or number of suspicion images)
- ⑥ Used for hard disk initialization

## The two available methods of recording the captured images are alarm recording and suspicion recording.

If the **H** (HOLD-UP) switch at the rear of the camera is not operated while recording images in the alarm recording area, then once recording has continued for the full length of time that has been set, it starts again automatically from the beginning of the hard disk and the images which are already on the hard disk are overwritten. This operation is continually repeated until recording is stopped.

For example, if new images are recorded at the beginning of the hard disk over the top of old images, then once 2 minutes and 30 seconds of new images have been recorded, 5 minutes' worth of old images will be deleted automatically.

## Alarm recording

Alarm recording can be divided into pre-alarm recording, post-alarm recording and backup recording. For each method, images are recorded in the alarm recording area of the hard disk. The recording time can be set to between 10 and 90 minutes.

### Pre-alarm (PRE1) recording

This is the normal method used for recording images. When "RECORD START" is selected, pre-alarm recording starts automatically. Images are recorded in the pre-alarm (PRE1) recording area of the hard disk. For example, if the ALARM TIME recording period is set to the initial setting of 45 minutes, continuous recording to the pre-alarm area for 45 minutes occurs if no post-alarm recording is carried out. However, if the **H** (HOLD-UP) switch at the rear of the camera is turned on, the images recorded during the first 30 minutes of the 45-minute pre-alarm recording period are deleted, and this space then becomes the post-alarm recording area (POST ALARM 30 min) and is used for post-alarm recording. The pre-alarm recording area (PRE ALARM 15 MIN) is maintained according to the settings.

### Post-alarm (POST-1) recording

A switch must be connected to the **H** (HOLD-UP) terminal at the rear of the camera for post-alarm recording to be carried out. Post-alarm recording is then carried out while the hold-up (H) switch is turned on.

If the switch which is connected to the **H** terminal is pressed and held during pre-alarm recording, the recording mode changes from pre-alarm recording to post-alarm recording. The images are recorded in the post-alarm (POST1) recording area of the hard disk.



---

## Backup recording

If there is 20 minutes or more of available recording time remaining in the post-alarm recording area of the hard disk after post-alarm (POST1) recording is completed, pre-alarm 2 (PRE2) recording [which is distinct from pre-alarm (PRE1) recording] starts automatically. If the hold-up (H) switch is then pressed, post-alarm 2 (POST2) recording [which is distinct from post-alarm (POST1) recording] starts.

The recording time for backup recording is set automatically according to the ratio between the pre-alarm 2 (PRE2) and the post-alarm 2 (POST2) recording times.

### Note:

If any of the following occur, “**ALARM REC FULL**” will be displayed on the screen and recording in the alarm recording area will no longer be possible.

At such times, transfer the image data to a computer and clear the images from the alarm recording area, or re-initialize the hard disk.

- If the pre-alarm and post-alarm recording areas become full
- When post-alarm 2 (POST2) recording is complete, because this is the final recording area used
- If the available recording time for alarm recording is reduced to 20 minutes or less.

## Suspicion recording

This recording method is used at times such as when a suspicious individual is noticed. A switch must be connected to the **S** (SUSPICION) terminal at the rear of the camera for suspicion recording to be carried out. If the switch which is connected to the **S** terminal is pressed during pre-alarm recording, the recording mode changes from pre-alarm recording to suspicion recording. The images are recorded in the suspicion recording area of the hard disk. The number of images that can be recorded is set automatically to between 11,565 and 502 images, depending on the alarm recording time setting.

# SETTING THE RECORDING METHOD

## Pre-alarm recording flow

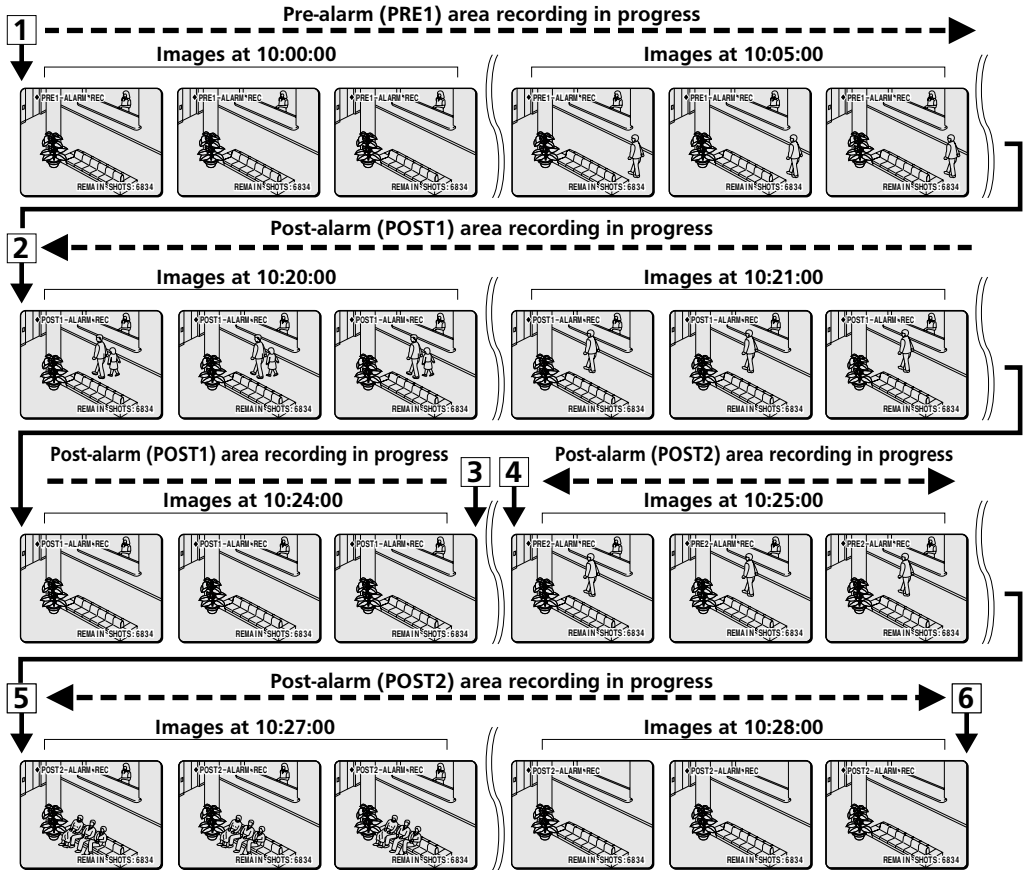

**1** Pre-alarm (PRE1) recording starts from 10:00:00

Images are stored to the pre-alarm recording area.

**2** An emergency situation develops at 10:20:00, and you want to record images in the post-alarm area.

Post-alarm (POST1) recording starts when the hold-up switch is pressed and held.

**3** Post-alarm recording is stopped at 10:25:00.

Post-alarm (POST1) recording stops when the hold-up switch is released.

**4** Backup recording starts.

If there is 20 minutes or more of available recording time remaining in the alarm recording area of the hard disk, pre-alarm (PRE2) recording starts automatically at 10:25:00.

**5** An emergency situation develops again at 10:27:00 and you want to record images in the post-alarm2 area.

Post-alarm (POST2) recording starts when the alarm switch is pressed and held.

**6** Post-alarm recording is stopped at 10:29:00.

When the hold-up switch is released, "ALARM REC FULL" appears on the screen and recording stops.

## Screen displays

### ① Display during recording

- During recording, the screen display will switch off after 30 seconds have passed. You can make the screen display re-appear by pressing the **SET** or **CURSOR** button.
- The screen display can be set to switch off immediately from the start of recording. To do this, set **"CAUTION LED"** on the SYSTEM SET screen to **OFF**. To re-display the screen, set it back to **ON**. (See page 23)

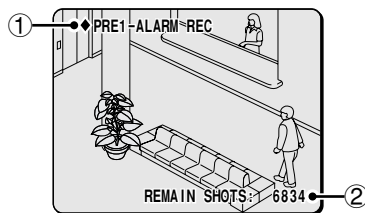

### ② Number of suspicion recording images

## ■ Pre-alarm recording

1

### Press the **MENU** button.

The MAIN MENU screen will be displayed.

If the MAIN MENU screen remains displayed for about 30 seconds, pre-alarm recording will then start automatically.

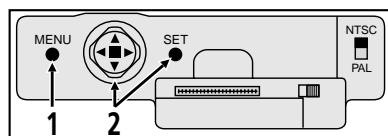

MENU



(MAIN MENU)

RECORD START  
PLAYBACK  
SETTINGS  
CONDITION

2

### Use the **CURSOR** (▲ or ▼) button to select **"RECORD START"** and then press the **SET** button.

**"PRE1-ALARM REC"** will be displayed and pre-alarm (PRE1) recording will start.

The warning indicator and caution indicator both light during pre-alarm recording.



SET

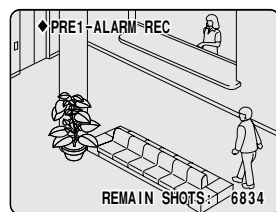

**Note:** Pre-alarm recording will continue with the images being recorded in the pre-alarm (PRE1) area of the hard disk until the hold-up switch or suspicion switch at the back of the camera is pressed.

3

### Press the **MENU** button to stop recording.

The display will return to the MAIN MENU screen.

# SETTING THE RECORDING METHOD

## ■ Post-alarm recording

- 1** Press the **MENU** button.  
The MAIN MENU screen will be displayed.

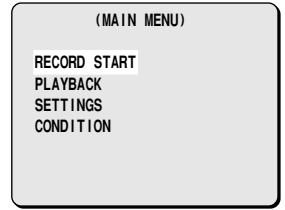

- 2** Use the **CURSOR** (▲ or ▼) button to select **"RECORD START"** and then press the **SET** button.

The warning indicator and caution indicator both light during post-alarm recording.

"**PRE1-ALARM REC**" will be displayed and pre-alarm (PRE1) recording will then start.

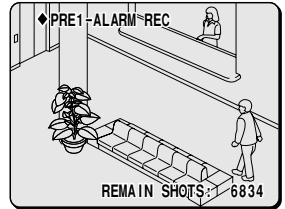

- 3** Press and hold the **H (HOLD-UP)** switch (rear panel).

"**POST1-ALARM REC**" will be displayed and post-alarm 1 (POST1) recording will start.

Post-alarm recording will stop when the hold-up switch is released, or when the post-alarm recording time which was initially set has passed.

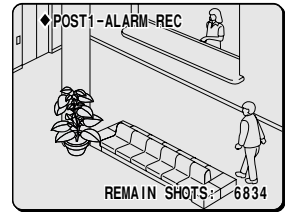

- 4** Release the **H (HOLD-UP)** switch to stop recording.

- If there is 20 minutes or more of available recording time remaining in the post-alarm recording area, pre-alarm 2 (PRE2) recording starts automatically.
- When the recording area becomes full, "**ALARM REC FULL**" will be displayed and recording will no longer be possible.

## ■ Backup recording

If there is 20 minutes or more of available recording time remaining in the post-alarm recording area of the hard disk after post-alarm recording is completed, backup recording (pre-alarm 2 (PRE2) recording) starts automatically. It follows from this that if there is not 20 minutes or more of time remaining, backup recording is not carried out.

### 1 Pre-alarm 2 (PRE2) recording starts automatically.

"PRE2-ALARM REC" is displayed.

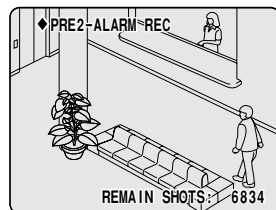

### 2 If an emergency situation develops, press and hold the H (HOLD-UP) switch.

"POST2-ALARM REC" will be displayed and post-alarm 2 (POST2) recording will start.

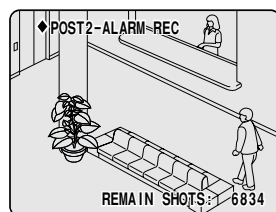

### 3 When the emergency situation has ended, release the H (HOLD-UP) switch.

"ALARM REC FULL" will be displayed and alarm recording will end.

#### Note:

When post-alarm 2 (POST2) recording has ended, there will not be any more space available for recording, and so it will not be possible to continue alarm recording. To re-start pre-alarm recording, transfer the image data to a computer and then carry out either one of the following two operations.

- Select "**DELETE**" from the FUNCTIONS screen, and delete all of the image data. (See page 73)
- Select "**INITIALIZE**" from the HDD SET sub-screen of the SETTINGS screen and re-initialize the hard disk. (See page 24)

## Free Manuals Download Website

<http://myh66.com>

<http://usermanuals.us>

<http://www.somanuals.com>

<http://www.4manuals.cc>

<http://www.manual-lib.com>

<http://www.404manual.com>

<http://www.luxmanual.com>

<http://aubethermostatmanual.com>

Golf course search by state

<http://golfingnear.com>

Email search by domain

<http://emailbydomain.com>

Auto manuals search

<http://auto.somanuals.com>

TV manuals search

<http://tv.somanuals.com>