

Rinnai

FLAME FIRES



Rinnai
FLAME FIRES

FLAME FIRES



RINNAI FLAME FIRES OFFER THE LOOK AND FEEL OF TRADITIONAL HEARTH FIRES, ADDING AMBIENCE AND WARMTH TO YOUR HOME.

ASPIRATION

4 - 5

State of the art technology including full electronics, power flueing, convenient timers, temperature control and design options.

CONSTELLATION

6 - 7

Traditional design open convector flame fire providing a nostalgic look but with inbuilt modern technology.

ROYALE ETR & MANUAL

8 - 9

Classic design featuring both freestanding and inbuilt models with electronic timers and remote control operation or manual operation.

SLIMFIRE 25

10 - 11

A compact slim line flame fire ideal for homes with smaller rooms or heating requirements.

INSTALLATION FLEXIBILITY

12

FIREPLACE PACKAGES

13

FLUEING & ACCESSORIES

14 - 15

SPECIFICATIONS

16



ASPIRATION

WHEN ONLY THE BEST WILL DO, THE RINNAI ASPIRATION FLAME FIRE IS YOUR ONLY CHOICE. COMPRISING MANY FEATURES UNIQUE TO THE AUSTRALIAN MARKET, THE ASPIRATION EMBODIES STATE OF THE ART TECHNOLOGY WITH GREAT AESTHETICS. THESE INCLUDE FULL ELECTRONIC THERMOSTATIC OPERATION, HIGH EFFICIENCY HEATING UTILISING RINNAI'S FLEXIBLE POWER FLUEING SYSTEM AND EVEN A CHOICE OF MODERN FASCIA DESIGNS AND FINISHES.



BENEFITS

- **Power Flueing.** For flexibility of flueing installation options including through wall, under-floor, through ceiling and out the side whilst reducing installation costs (see page 14).
- **Dual Digital Timers.** The convenience to program when you want your appliance to operate throughout the whole week, mornings and evenings.
- **Pre-Heat Mode.** Ensures the room is at your desired temperature by the time programmed into the timer. No need to program an earlier time... it's automatic!
- **Thermostatically Controlled.** The added convenience of set'n'forget operation.
- **7 Different Flame Patterns.** Flame function overrides the thermostat and maintains a constant flame picture when you just want the ambience of a fire.
- **3 Speed Fan.** For added comfort and even temperature distribution.
- **Inbuilt Zero Clearance.** Provides heat protection to surrounding structures allowing greater flexibility and reduced installation costs.
- **Remote Control.** Featuring on/off function, temperature control and flame picture control.



Full Function Remote Control



Slimline Metal Fascia
Stainless Steel

MODEL OPTIONS

The Aspiration flame fire is available with a choice of fascias and finishes:

- Slimline Metal Fascias – Metallic Black or Stainless Steel
- Radius Full Glass Fascias – Black or Silver tint

Dress guards are also available as an accessory for added peace of mind.



Radius Full Glass Fascia
Black

Must be installed with a Rinnai flue system (sold separately - see page 14).

CONSTELLATION

THE NOSTALGIC IMAGE OF FIREPLACES IS BROUGHT TO LIFE WITH THE RINNAI CONSTELLATION FLAME FIRE. IN A TRIBUTE TO YESTERYEAR, RINNAI HAVE DESIGNED THIS OPEN CONVECTOR DECORATIVE FIRE WITH A CHOICE OF BURN MEDIUMS AND FASCIAS WHICH CAN BE MIXED AND MATCHED TO YOUR NEEDS. COMPLETE WITH THE LATEST ELECTRONIC TECHNOLOGY, YOU CAN ENJOY THE AMBIENCE AND ROMANCE OF AN OPEN FIRE AT THE TOUCH OF A BUTTON - THE BEST OF BOTH WORLDS!



BENEFITS

- **Ceramat® Burner.** Unique to Rinnai, assists in the creation of gentle flickering flames adding realism and ambience to the fire.
- **Flame Modulation.** Allows you to adjust the flame picture to your needs between low and high.
- **2 Speed Fan.** For added comfort and even heat distribution.
- **Electronic Ignition.** Provides simple one touch operation for ease of use.
- **Inbuilt Memory.** Records your previous setting and automatically commences at that level each time until reset.
- **Timer Function.** Allows the appliance to shut off 30 minutes after the timer button is pushed on the remote control.
- **Partial-Installation Option.** Allows the flueing for the appliance to be installed during the building and framing stage. Installation of the actual fire is at completion, minimising potential mess or damage to the appliance.
- **Inbuilt Zero Clearance.** Provides heat protection to surrounding structures allowing greater flexibility and reduced installation costs.
- **Remote Control.** Lets you enjoy the ambience of your flame fire without leaving the comfort of your chair.



Remote Control



Metallic Black Fascia
with Black Coals

MODEL OPTIONS

The Constellation flame fire is available in two standard configurations:

- Metallic Black with Black Coals
- Stainless Steel with River Stones

Should you ever wish to change the look of your Constellation flame fire, both the coals and river stones, as well as both fascias can be ordered separately.

Rock Panels kindly supplied by Norstone Pty Ltd.
For further information please visit www.norstone.com.au or phone 02 9944 6711.

® Ceramat is a registered trademark of Schott AG (Germany).
Must be installed with a Rinnai flue system (sold separately - see page 14).



Stainless Steel Fascia
with River Stones

ROYALE ETR & MANUAL

THE ROYALE ETR IS ONE OF THE MOST TECHNOLOGICALLY ADVANCED FLAME FIRES IN THE WORLD TODAY. IT BOASTS MANY FEATURES UNIQUE TO RINNAI AS WELL AS OTHER STANDARD FEATURES THAT OTHERS CHARGE FOR AS OPTIONS IF AVAILABLE. THE ROYALE MANUAL IS THE ULTIMATE IN EASY OPERATION COMPLETE WITH PUSH BUTTON IGNITION, 3 HEAT SETTINGS AND 2 SPEED FAN.



ROYALE ETR BENEFITS

- **Powerful Heat Output.** An even spread of fan forced warm air throughout the room.
- **Dual Digital Timers.** The convenience to program when you want your appliance to operate throughout the whole week, mornings and evenings.
- **Flame Function.** Overrides the thermostat and maintains a constant flame picture when you just want the ambience of a fire.
- **Electronic Ignition.** Provides simple one touch operation for ease of use.
- **Thermostatically Controlled.** The added convenience of set'n'forget operation.
- **Child Lock.** For added safety and peace of mind.
- **Remote Control.** Lets you enjoy the comfort and ambience of your flame fire from your armchair.

MODEL OPTIONS

- Inbuilt - Metallic Black or Titanium
- Freestanding - Metallic Black or Titanium

ROYALE MANUAL BENEFITS

- **Inbuilt or Freestanding Configurations.** Depending on your installation requirements.
- **Powerful Heat Output.** An even spread of fan forced warm air throughout the room.
- **Electronic Ignition.** Provides simple one touch operation for ease of use.
- **Radius Glass Fascia.** Provides a panoramic view of the flame for added ambience.
- **2 Speed Fan.** For added comfort and even temperature distribution.
- **3 Heat Settings.** Allows you to adjust comfort levels whilst always maintaining a flame picture.

MODEL OPTIONS

- Inbuilt - Metallic Black
- Freestanding - Metallic Black

Clearances (Freestanding) 100mm from rear wall. 400mm from a corner.
400mm from sides and top. 1000mm directly in front.
Mandatory dress guards not shown for flame illustration purposes.
Must be installed with a Rinnai flue system (sold separately - see page 15).



Royale ETR Controls
Electronic with Timers and Remote



Inbuilt Royale ETR Titanium
with an Agnews Fireplace Package



Freestanding
Royale ETR Titanium

SLIMFIRE 25

A TRUE SUCCESS STORY, THE RINNAI SLIMFIRE 25 WAS DESIGNED SPECIFICALLY TO MEET AUSTRALIAN CONDITIONS AND LIFESTYLES. COMPLETE WITH A SLIM-LINE FLAT GLASS FRONT AND REALISTIC FLAME AND LOG APPEARANCE, THIS CONTEMPORARY FLAME FIRE IS AN EASY WAY TO UPGRADE THE LOOK OF YOUR EXISTING LIVING AREA, OR A GREAT ADDITION TO A NEW HOME. RINNAI ALSO HAVE A RANGE OF 3 AND 4 SIDED MANTLES AND FASCIAS TO FURTHER ENHANCE YOUR DÉCOR.



BENEFITS

- **Powerful Heat Output.** Ideal for small to medium sized lounge or family rooms.
- **No Additional Flue Required.** When installed into an existing and sound masonry fireplace saving installation costs. A complete flue kit is also available for other applications.
- **Electronic Ignition.** Provides simple one touch operation for ease of use.
- **2 Speed Fan.** For added comfort and even temperature distribution.
- **3 Heat Settings.** Allow you to adjust comfort levels whilst always maintaining a flame picture.

MODEL OPTIONS

- Metallic Black
- Stainless Steel

RENOVATORS DELIGHT!

The Slimfire is the perfect product for renovations. Specifically designed to replace old 70's space heaters, the Slimfire rear flue usually enables a straight swap over.

The Slimfire is also great for older homes fitted directly into a masonry fireplace often with no flue required.

CONSOLE KIT

Designed for convenience, the Slimfire Console is ideal for situations where a false fireplace is not desired or where there is no masonry fireplace, providing flexibility and reduced installation costs.

Perfect as a replacement for older style gas space heaters, the Slimfire Console may be able to utilise existing in-wall flueing.

The console kit is available as an optional accessory with the Slimfire 25. The flue required is a conventional 10 x 2 inch twin skin, plus a wall connection elbow and housing available from plumbing stores.

Mandatory dress guards not shown for flame illustration purposes.



Electronic Ignition



Stainless Steel Fascia



Slimfire Console Kit
Metallic Black Fascia

INSTALLATION FLEXIBILITY

NO FIREPLACE, NO PROBLEM

Not all households have an existing masonry fire place, but this doesn't mean you can't install a Rinnai flame fire. Royale Inbuilt, Slimfire 25 and Constellation models can be installed into decorative fireplaces as demonstrated in the photos below.

Due to it's advanced flue system design, the Aspiration can be installed just about anywhere, whether a fireplace exists or not.

BEFORE



BUILD A FRAME



SLIP IN THE ZERO BOX



DROP IN THE FLUE



PLASTER AND PAINT

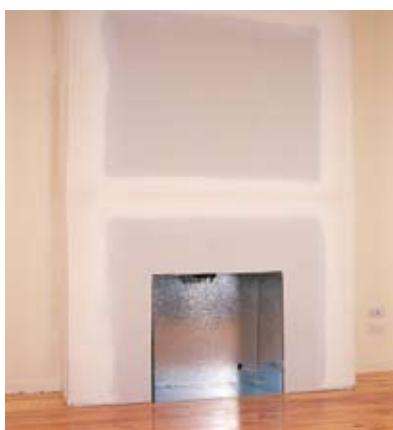

THE FINISHING TOUCH



Royale Inbuilt in Decorative Fireplace

FRAME DIMENSIONS

	Height	Width	Depth	Zero Box Order Code
Royale Inbuilt	745mm	810mm	440mm (min.)	ZEROR1 (Metallic Black)
				ZEROR2T (Titanium)
Slimfire 25	675mm	685mm	370mm (min.)	ZEROS (Metallic Black)
				ZEROS2 (Stainless Steel)
Aspiration	600mm	860mm	450 or 500mm*	Not Required
Constellation	665mm + Hearth Height	1000mm	450mm	Not Required

*Depth depends on flueing option, see installation instructions for full details

FIREPLACE PACKAGES



INSPIRATION MANTLES

The new Inspiration mantles and fascias enable you to maximise the impact of your Rinnai Slimfire. Easy to install, the mantles come standard in beech or dark cherry finish. Our 3-sided fascias allow you to position the unit directly into a fireplace or at floor level, while the 4-sided fascia raises the unit from floor level. Both fascias are designed to be used with and without mantles, and are sold separately. The Inspiration packages are stocked and distributed by Rinnai Stockists.

	Height	Width	Colour	Order Code
Inspiration Mantle	1150mm	1360mm	Dark Cherry	INSPMC
			Beech	INSPMB
Inspiration 3-sided Fascia	970mm	970mm	Duracote™ (Polished Silver)	INSP3FD
			Black	INSP3FB
Inspiration 4-sided Fascia	970mm	970mm	Duracote™ (Polished Silver)	INSP4FD
			Black	INSP4FB

Note: If not installing with a Zero Clearance box option, a separate 50mm plinth must also be ordered (see Page 15).



Inspiration 3-sided Black Fascia and Beech Mantle



Inspiration 4-sided Duracote™ Fascia and Dark Cherry Mantle



Inspiration 3-sided Black Fascia and Dark Cherry Mantle



Inspiration 4-sided Duracote™ Fascia

FLUEING & ACCESSORIES

ASPIRATION - FLAME FIRE

	Description	Order Code
1	Direct Flue Kit	ASPDFK
2A	Vertical 'On Wall' Kit* Co-Ax Pipe 900mm# Roof Cowl	ASPKIT03 ESPIPE900 ESROOFCOWL
2B	Vertical 'On Wall' Kit* Co-Ax Pipe 900mm# Bend (2 x 45°) Roof Cowl	ASPKIT03 ESPIPE900 ESBEND ESROOFCOWL
3A	Direct Flue Kit Co-Ax Pipe 900mm# Bend (2 x 45°) Condensate Trap Roof Cowl	ASPDFK ESPIPE900 ESBEND ESCONDK ESROOFCOWL
3B	Direct Flue Kit Co-Ax Pipe 900mm# 2 Sets of Bends (2 x 45°) Condensate Trap Wall Terminal Kit	ASPDFK ESPIPE900 ESBEND x 2 ESCONDK ESWTKIT
4	Vertical 'On Wall' Kit* Co-Ax Pipe 900mm# Wall Terminal Kit	ASPKIT03 ESPIPE900 ESWTKIT
5	Vertical 'On Wall' Kit* Co-Ax Pipe 900mm# Bend (2 x 45°) Wall Terminal Kit	ASPKIT03 ESPIPE900 ESBEND ESWTKIT

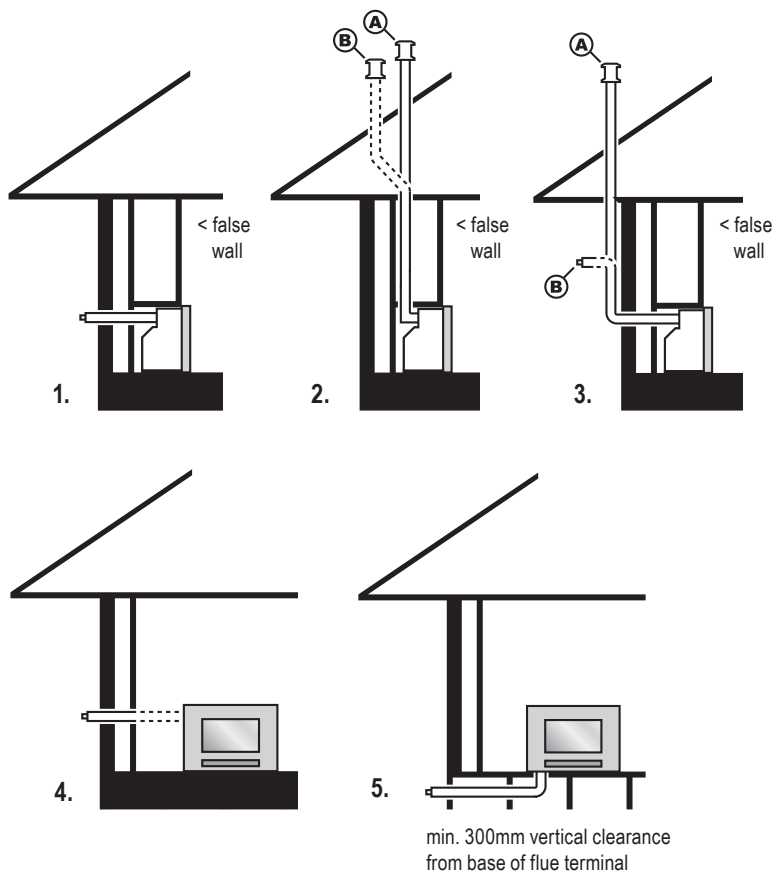

Fascias Slimline Metallic Black Fascia Slimline Stainless Steel Fascia	Order Code FLFASPFBB FLFASPFSS	Fascias Radius Glass Black Fascia Radius Glass Silver Fascia	Order Code FLFASPFBBG FLFASPFBSG
---	---	---	---

*includes condensate trap
#order lengths as required

CONSTELLATION - OPEN CONVECTOR

	Description	Order Code
1	Installation Kit (3.6m) includes Adaptor, Cowl & Gal. Flue Pipe 900mm	OFKIT
2	Installation Kit (3.6m) includes Adaptor, Cowl & Gal. Flue Pipe 900mm Bend (2 x 45°)	OFKIT OFBEND
3	Installation Kit (3.6m) includes Adaptor, Cowl & Gal. Flue Pipe 900mm	OFKIT

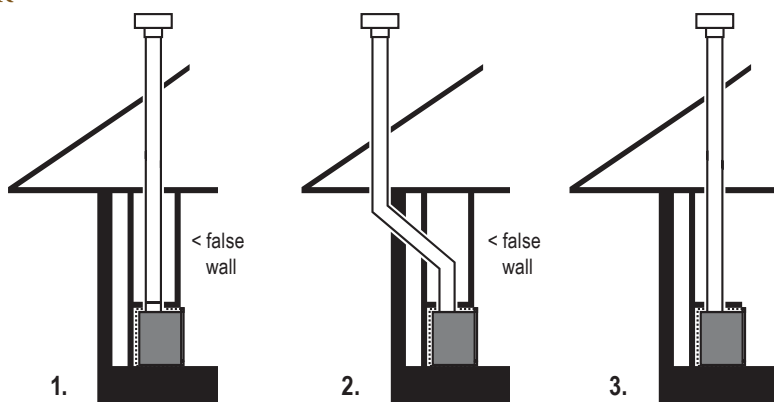

Fascias Metallic Black Fascia Stainless Steel Fascia	Order Code FLFCONFB FLFCONFSS	Accessories Black Coals River Stones 900mm Twin Skin Flue	Order Code FLFCONFBG FLFCONBBSG OFFPIPE900
---	--	---	--

Please note: Minimum flue length required is 3.6 metres

ROYALE ETR & MANUAL - FLAME FIRES

	Description	Order Code
1A	Vertical Twin Skin Flue Kit (3.6m)	FLFKIT05*
1B	Vertical Twin Skin Flue Kit (3.6m) Twin Skin Offset	FLFKIT05* FLFBEND*
2	Thru-wall Twin Skin Flue Kit (3.6m) inc. 1x900mm Powder Coated & 3x900mm Galvanised Twin Skin Flues, Cowl & Wall Penetration Kit	FLFKIT03*
3	Flexiliner Flue Kit (5.0m)	FLEXLINER05
4A	Vertical Twin Skin Flue Kit (3.6m)	FLFKIT05B
4B	Vertical Twin Skin Flue Kit (3.6m) Twin Skin Offset	FLFKIT05B FLFBENDB

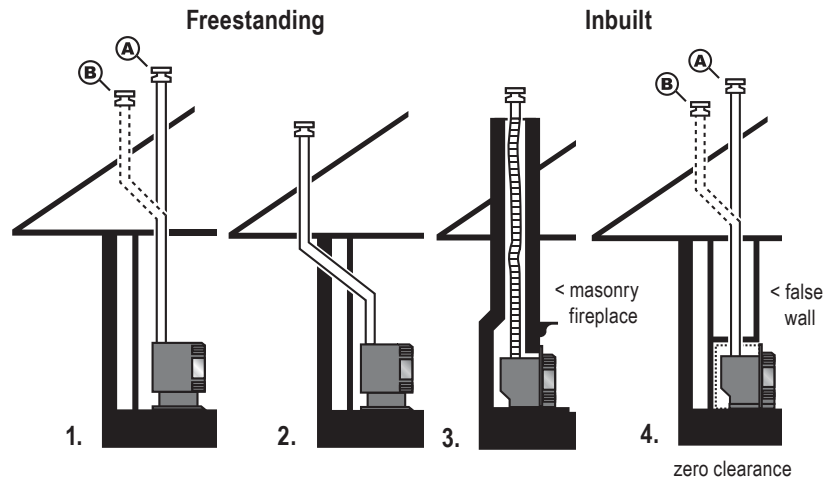

Freestanding Accessories	Order Code	Inbuilt Accessories	Order Code
450mm Twin Skin Flue	FLF0450M*	Flue Adaptor Plate	FLFAD
900mm Twin Skin Flue	FLF0900M*	50mm Plinth	FLFRP*
45° Twin Skin Offset	FLFBEND*	45° Twin Skin Offset	FLFBENDB
900mm Galvanised Flue Ext Twin Skin	FLFEXT03	40mm Ext Top Surround (Black Only)	FLFRSEXTB

For Thru-Wall double storey applications, please order the 3.6 metre Thru-Wall Twin Skin Kit (FLFKIT03) and additional lengths of 900mm Galvanised Flue Extensions (FLFEXT03) as required.

*Nominate Metallic Black or Titanium

SLIMFIRE 25 - FLAME FIRE

	Description	Order Code
1	Flexiliner Flue Kit	FLEXLINER03
2A	Vertical Twin Skin Flue Kit	FLFKIT05
2B	Vertical Twin Skin Flue Kit Twin Skin Offset	FLFKIT05 FLFBEND
3	Vertical Twin Skin Flue Kit Thru-wall Twin Skin Flue Kit	FLFKIT05 FLFKIT03

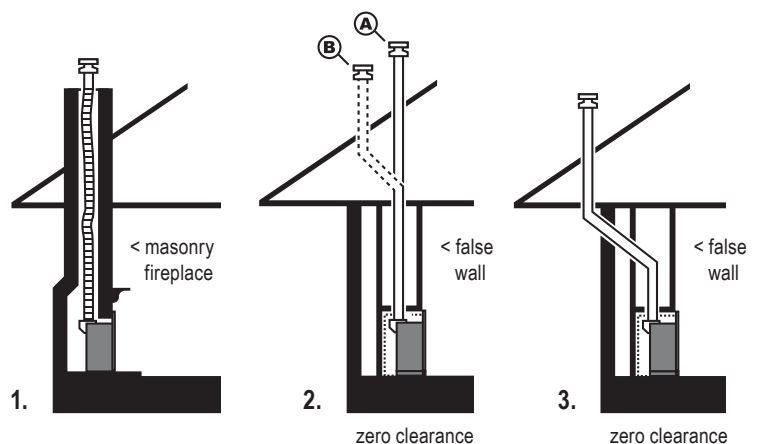

Fascias & Console Kits	Order Code	Accessories	Order Code
Metallic Black Fascia	FLFSFB	Fluebox Adaptor	FLFAD1
Stainless Steel Fascia	FLFSFSS	50mm Plinth (Masonry Fireplaces only)	FLFSP*
Metallic Black Console Kit	FLFSCB	90mm Ext Top 3-sided Surround (Black only)	FLFSBEXT
Stainless Steel Console Kit	FLFSCSS		

#Nominate Metallic Black or Stainless Steel

















RINNAI AUSTRALIA PTY. LTD.

10-11 Walker Street Braeside VIC 3195

ABN 74 005 138 769

		telephone	facsimile
Technical HelpLine & Spare Parts	National (Mon-Fri 8.00am to 6.00pm EST)	1300 366 388	1300 300 141
Product Sales & Service	National	1300 555 545	1300 555 655
Brochure Request Line	National (Mon-Sun)	13 14 19	
Showrooms	Sydney (Mon-Fri)	62 Elizabeth Street Wetherill Park NSW 2164	
	Melbourne (Mon-Fri)	10 - 11 Walker Street Braeside VIC 3195	
	Adelaide (Mon-Fri)	40 - 42 Tikalara Street Regency Park SA 5010	
	Perth (Mon-Sun)	Home Base Expo 55 Salvado Road Subiaco WA 6008	

FLAME FIRE SPECIFICATIONS

Model	Dimensions (mm)			Inbuilt Fireplace Dimensions Min-Max (mm)			Star Rating AS4553	Colours	Gas Input - MJ/h		kW Output	'Heats up to' Capacity (m ²)				
	H	W	D	H	W	D			Low	High		Very Cold	Cold	Cool	Mild	
 Aspiration Slimline Metal	680	900	450	660	860	450*		Metallic Black	8	31.5†	6.0	47	56	74	85	
								Stainless Steel								
 Aspiration Radius Glass	680	900	480	660	860	450*		Black	8	31.5†	6.0	47	56	74	85	
								Silver								
 Constellation Black Coals	680	1025	422	665	1000	450	N/A	Metallic Black	24	38	N/A	N/A	N/A	N/A	N/A	
 Constellation River Stones	680	1025	432	665	1000	450		Stainless Steel								
 Royale ETR Freestanding	755	650	560	N/A	N/A	N/A		Metallic Black	8	35	7.4	66	79	106	122	
							Titanium									
 Royale ETR Inbuilt	695	910	565	595-675	600-800	Min. 405		Metallic Black	8	33	6.6	58	69	93	109	
							Titanium									
 Royale Manual Freestanding	755	650	560	N/A	N/A	N/A		Metallic Black	16	35	7.1	66	79	106	122	
 Royale Manual Inbuilt	690	910	565	595-675	600-800	Min. 405		Metallic Black								
 Slimfire 25 Inbuilt	645	750	385	550-630	595-700	Min. 360		Metallic Black	7.7	25	5.0	42	50	68	77	
								Stainless Steel								
WARRANTY		Free Parts		Free Labour			Please note: 240V power is required on all models. A power cord and plug is fitted. If hardwiring is required, consult a licensed electrician. Dimensions are subject to production tolerances and may vary slightly from those given. Rinnai Australia Pty. Ltd. reserves the right to make modifications and change specifications without notice.									
		Heat Exchanger	10 Years pro-rata*		1 Year											
		Fan	2 Years		1 Year											
		All Other Parts	1 Year		1 Year											

*Heat exchanger: full replacement parts cost in the first year, reducing 10% per year thereafter.

†Suitable for direct, vertical or horizontal flueing. 500mm required for down and out applications. See installation instructions for full details.

‡Installed with a direct flue with extended flueing, 24.5 MJ/h input but with a higher efficiency.

Phone 13 14 19 for a free brochure on the products listed below.

- Continuous Flow Hot Water
- Solar Hot Water
- Electric Hot Water
- Commercial Hot Water
- Outdoor Entertaining
- Space Heating
- Portable Heating
- Gas Clothes Dryers

Alternatively visit our website: www.rinnai.com.au or e-mail: enquiry@rinnai.com.au

35/07_MAR

Free Manuals Download Website

<http://myh66.com>

<http://usermanuals.us>

<http://www.somanuals.com>

<http://www.4manuals.cc>

<http://www.manual-lib.com>

<http://www.404manual.com>

<http://www.luxmanual.com>

<http://aubethermostatmanual.com>

Golf course search by state

<http://golfingnear.com>

Email search by domain

<http://emailbydomain.com>

Auto manuals search

<http://auto.somanuals.com>

TV manuals search

<http://tv.somanuals.com>