

Panasonic®

■ This product is eligible for the AVCCAM
3 Year Warranty Repair Program. For
details, see page 5.

Operating Instructions **Vol.1**

Memory Card Camera-Recorder

Model No. **AG-HMC80P**

Volume **1**

Note that Operation Instructions Vol.1 describes basic operations of the Memory Card Camera-Recorder.
For instructions on advanced operations of the Memory Card Camera-Recorder, refer to Operating Instructions Vol.2 (pdf file) contained in the supplied CD-ROM.

AVCCAM

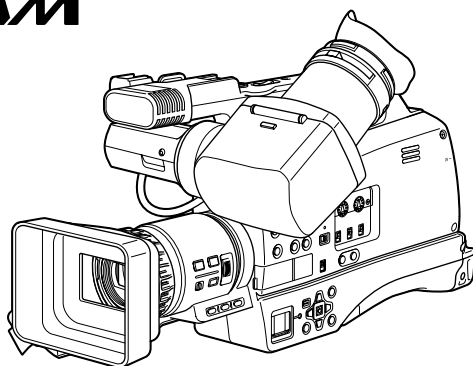

AVCHD™

DV



HDMI™
HIGH DEFINITION MULTIMEDIA INTERFACE



Before operating this product, please read the instructions carefully and save this manual for future use.

SS0710TU2090 -PS 

Printed in Japan



Download from Www.Somanuals.com. All Manuals Search And Download.

ENGLISH

VQT2Y43-1

Read this first!

 indicates safety information.

	CAUTION RISK OF ELECTRIC SHOCK DO NOT OPEN	
<p>CAUTION: TO REDUCE THE RISK OF ELECTRIC SHOCK, DO NOT REMOVE COVER (OR BACK). NO USER-SERVICEABLE PARTS INSIDE. REFER TO SERVICING TO QUALIFIED SERVICE PERSONNEL.</p>		



The lightning flash with arrowhead symbol, within an equilateral triangle, is intended to alert the user to the presence of uninsulated "dangerous voltage" within the product's enclosure that may be of sufficient magnitude to constitute a risk of electric shock to persons.



The exclamation point within an equilateral triangle is intended to alert the user to the presence of important operating and maintenance (servicing) instructions in the literature accompanying the appliance.

WARNING:

- To reduce the risk of fire or electric shock, do not expose this equipment to rain or moisture.
- To reduce the risk of fire or electric shock hazard, keep this equipment away from all liquids. Use and store only in locations which are not exposed to the risk of dripping or splashing liquids, and do not place any liquid containers on top of the equipment.

WARNING:

Always keep memory cards (optional accessory) or accessories (coin battery, XLR audio adaptor cap) out of the reach of babies and small children.

CAUTION:

To reduce the risk of fire or electric shock and annoying interference, use the recommended accessories only.

CAUTION:

Do not jar, swing, or shake the unit by its handle while the conversion lens or another accessory is attached. Due to the added weight of the conversion lens, any strong jolt to the handle may damage the unit or result in personal injury.

CAUTION:

This apparatus can be operated at a voltage in the range of 100-240 V AC. Voltages other than 120 V are not intended for U.S.A. and Canada. Operation at a voltage other than 120 V AC may require the use of a different AC plug. Please contact either a local or foreign Panasonic authorized service center for assistance in selecting an alternate AC plug.

CAUTION:

The mains plug of the power supply cord shall remain readily operable.

The AC receptacle (mains socket outlet) shall be installed near the equipment and shall be easily accessible.

To completely disconnect this equipment from the AC mains, disconnect the power cord plug from the AC receptacle.

CAUTION:

- Danger of explosion or fire if battery is mistreated.
- Do not leave the battery in an automobile exposed to direct sunlight for a long period of time with doors and windows closed.
- Do not disassemble the battery or dispose of it in fire.
- Do not store in temperatures over 60°C (140°F).

For Battery Pack

- Use specified charger.
- Replace only with same or specified type.

For Battery of Remote Controller

- Replace battery with part No. CR2025 only.
- Do not recharge the battery.

CAUTION:

In order to maintain adequate ventilation, do not install or place this unit in a bookcase, built-in cabinet or any other confined space.

To prevent risk of electric shock or fire hazard due to overheating, ensure that curtains and any other materials do not obstruct the ventilation.

CAUTION:

Do not lift the unit by its handle while the tripod is attached. When the tripod is attached, its weight will also affect the unit's handle, possibly causing the handle to break and hurting the user. To carry the unit while the tripod is attached, take hold of the tripod.

CAUTION:

Excessive sound pressure from earphones and headphones can cause hearing loss.

CAUTION:

Do not leave the unit in direct contact with the skin for long periods of time when in use. Low temperature burn injuries may be suffered if the high temperature parts of this unit are in direct contact with the skin for long periods of time. When using the equipment for long periods of time, make use of the tripod.

FCC NOTICE (USA)

Declaration of Conformity

Model Number: AG-HMC80P

Trade Name: Panasonic

Responsible Party: Panasonic Corporation of North America One Panasonic Way, Secaucus, NJ 07094

Support contact: 1-800-524-1448

This device complies with Part 15 of the FCC Rules.

Operation is subject to the following two conditions:

(1) This device may not cause harmful interference, and (2) this device must accept any interference received, including interference that may cause undesired operation.

To assure continued compliance, follow the attached installation instructions and do not make any unauthorized modifications.

CAUTION:

This equipment has been tested and found to comply with the limits for a Class B digital device, pursuant to Part 15 of the FCC Rules. These limits are designed to provide reasonable protection against harmful interference in a residential installation. This equipment generates, uses and can radiate radio frequency energy and, if not installed and used in accordance with the instructions, may cause harmful interference to radio communications. However, there is no guarantee that interference will not occur in a particular installation. If this equipment does cause harmful interference to radio or television reception, which can be determined by turning the equipment off and on, the user is encouraged to try to correct the interference by one of the following measures:

- Reorient or relocate the receiving antenna.
- Increase the separation between the equipment and receiver.
- Connect the equipment into an outlet on a circuit different from that to which the receiver is connected.
- Consult the dealer or an experienced radio/TV technician for help.

The user may find the booklet "Something About Interference" available from FCC local regional offices helpful.

FCC Warning:

To assure continued FCC emission limit compliance, follow the attached installation instructions and the user must use only shielded interface cables when connecting to host computer or peripheral devices. Also any unauthorized changes or modifications to this equipment could void the user's authority to operate this device.

NOTIFICATION (Canada)

This class B digital apparatus complies with Canadian ICES-003.



A lithium ion/polymer battery that is recyclable powers the product you have purchased. Please call 1-800-8-BATTERY for information on how to recycle this battery.

For USA-California Only

This product contains a CR Coin Cell Lithium Battery which contains Perchlorate Material – special handling may apply.

See www.dtsc.ca.gov/hazardouswaste/perchlorate.

Note:

Camera-Recorder

The rating plate is on the underside of the camera recorder.

AC Adaptor

The rating plate is on the underside of the AC Adaptor. Disconnect the AC mains plug from the AC mains socket when not in use.

IMPORTANT SAFETY INSTRUCTIONS

- 1) Read these instructions.
- 2) Keep these instructions.
- 3) Heed all warnings.
- 4) Follow all instructions.
- 5) Do not use this apparatus near water.
- 6) Clean only with dry cloth.
- 7) Do not block any ventilation openings. Install in accordance with the manufacturer's instructions.
- 8) Do not install near any heat sources such as radiators, heat registers, stoves, or other apparatus (including amplifiers) that produce heat.
- 9) Do not defeat the safety purpose of the polarized or grounding-type plug. A polarized plug has two blades with one wider than the other. A grounding-type plug has two blades and a third grounding prong. The wide blade or the third prong are provided for your safety. If the provided plug does not fit into your outlet, consult an electrician for replacement of the obsolete outlet.
- 10) Protect the power cord from being walked on or pinched particularly at plugs, convenience receptacles, and the point where they exit from the apparatus.
- 11) Only use attachments/accessories specified by the manufacturer.
- 12) Use only with the cart, stand, tripod, bracket, or table specified by the manufacturer, or sold with the apparatus. When a cart is used, use caution when moving the cart/apparatus combination to avoid injury from tip-over.
- 13) Unplug this apparatus during lightning storms or when unused for long periods of time.
- 14) Refer all servicing to qualified service personnel. Servicing is required when the apparatus has been damaged in any way, such as power-supply cord or plug is damaged, liquid has been spilled or objects have fallen into the apparatus, the apparatus has been exposed to rain or moisture, does not operate normally, or has been dropped.



Conforms to ANSI/UL Std. 60065

■ **About batteries that you can use with this unit**
(Correct as of August 2010)

The battery that can be used with this unit is VW-VBG260/VW-VBG6.

- The unit has a function for distinguishing batteries which can be used safely. The dedicated battery (VW-VBG260/VW-VBG6) supports this function. The only batteries suitable for use with this unit are genuine Panasonic products and batteries manufactured by other companies and certified by Panasonic. (Batteries which do not support this function cannot be used). Panasonic cannot in any way guarantee the quality, performance or safety of batteries which have been manufactured by other companies and are not genuine Panasonic products.

It has been found that counterfeit battery packs which look very similar to the genuine product are made available to purchase in some markets. Some of these battery packs are not adequately protected with internal protection to meet the requirements of appropriate safety standards. There is a possibility that these battery packs may lead to fire or explosion. Please be advised that we are not liable for any accident or failure occurring as a result of use of a counterfeit battery pack. To ensure that safe products are used we would recommend that a genuine Panasonic battery pack is used.

AVCCAM 3 Year Warranty Repair Program ^{*1}

Thank you for purchasing this Panasonic AVCCAM device.
 Register as a user for this device to receive a special service warranty up to three years of free warranty repairs.

Customers who register as users on the website will receive an extended warranty repair valid for up to three years.



	1 st year	2 nd year	3 rd year
AVCCAM device ^{*2}	Basic warranty ^{*3}	Extended warranty repair ^{*4}	

^{*1}: Please note that this extended warranty is not available in some countries/regions. ^{*2}: Not all models eligible for extended warranty coverage. ^{*3}: The basic warranty period may vary depending on the country/region. ^{*4}: Not all repair work is covered by this extended warranty.



Details about user registration and the extended warranty: http://panasonic.biz/sav/pass_e

-
- SDHC Logo is a trademark of SD-3C, LLC.
 - “AVCHD” and the “AVCHD” logo are trademarks of Panasonic Corporation and Sony Corporation.
 - This product has been manufactured under license from Dolby Laboratories.
Dolby and the double-D symbol are trademarks of Dolby Laboratories.
 - HDMI, the HDMI logo, and High-Definition Multimedia Interface are trademarks or registered trademarks of HDMI Licensing LLC in the United States and or other countries.
 - Microsoft® and Windows® are trademarks or registered trademarks of Microsoft Corporation in the United States and/or other countries.
 - Screenshots are used in accordance with Microsoft Corporation guidelines.
 - Apple®, Macintosh®, and Mac OS® are trademarks or registered trademarks of Apple Inc. in the United States and/or other countries.
 - Other model names, company names, and product names listed in these operating instructions are trademarks or registered trademarks of their respective companies.
 - This product is licensed under the AVC Patent Portfolio License for the personal and non-commercial use of a consumer, and no license is granted or shall be implied for any use other than the personal uses detailed below.
 - To encode video in compliance with the AVC standard (“AVC Video”)
 - To decode AVC Video that was encoded by a consumer engaged in a personal and non-commercial activity
 - To decode AVC Video that was obtained from a video provider licensed to provide AVC Video
 - Additional information may be obtained from MPEG LA, LLC (<http://www.mpegla.com>).
 - Separate license contracts must be obtained from MPEG LA where SD Memory Cards containing information recorded with this product are to be distributed to end users for commercial purposes. “End user” refers to persons or organizations handling such contents for personal use.

Note concerning illustrations in these instructions

- Illustrations (camera-recorder, menu screens, etc.) in these operating instructions differ slightly from the actual camera-recorder.

References

- References are shown as (Page 00).

Terminology

- Both SD Memory Cards and SDHC Memory Cards as referred to as “SD Memory Cards” in these operating instructions.
- Video that is created during a single recording operation is referred to as a “clip” in these operating instructions.

Volume 1 (This Book)

Read this first!	2	Basic Operations	30
IMPORTANT SAFETY INSTRUCTIONS	4	Turn on/off the camera	30
Operating precautions	8	Tally lamp	30
Precaution for use	10	Using the cursor button	31
SD Memory Cards compatible with this product	12	Basic operations	31
CLASS (SD speed class 6)	14	Menu screen operations	31
SDHC Memory Cards	14	Playback mode (PB mode only)	31
Compatibility of recorded video	15	Using the viewfinder	32
About AVCHD	15	Using the viewfinder	32
About DV	15	Using as a LCD monitor	33
		Emphasizing outlines	33
		Adjusting the screen display	34
Outline	16	Setting the calendar	35
Using this Camera	16	Setting the time zone	35
Shooting and playing back with this camera	16	Setting the clock	35
Editing and saving with external devices	17	Basic shooting operations	36
Accessories	18	Preparing for recording	36
Optional accessories	19	SD Memory Card ACCESS lamp	36
Using tele conversion lenses, wide conversion lenses	19	Shooting in auto mode	37
Description of parts	20	Checking photos taken (REC CHECK)	38
Front side and rear side	20	Using the zoom function	39
Right Side	21	Digital zoom function	39
Left side	22	Using the setup menus	40
Remote control	23	Using the menus	40
		Using the Function Menu	41
		Initializing the menu settings	41
		Setup menu structure	42
Preparation	24	CAMERA mode menu	42
Recharging the battery	24	PHOTO mode menu	43
Recharging	24	DV IN mode menu	43
Power sources	26	PB mode menu	44
Using the battery	26	Thumbnail menu (DV mode only)	44
Using the AC adaptor	26		
Adjusting the grip belt	27	Specifications	45
Attaching the shoulder strap	27		
Detaching and attaching the lens hood	28	Index	48
Fitting the eye cup	28		
The remote control	29		
Insert the battery	29		
Remote control usable range	29		

Volume 2 (CD)

Chapter 1: Operations in AVCHD mode
Chapter 2: Operations in DV mode
Chapter 3: Screen displays and setting menus

Chapter 4: Reference

Before calling for service/Updating the firmware/
Cleaning/Cleaning the eye piece/Storage
Precautions/Software information/Recording
format/How to handle data recorded on SD
Memory Card

Operating precautions

Do not allow any water to get into the camera-recorder when using it in the rain or snow or at the beach.

- Failure to heed this caution will cause the camera-recorder or a card to malfunction (and may result in irreparable damage).

Keep the camera-recorder away from equipment (such as TV sets and video game machines) that generate magnetic fields.

- Using the camera-recorder on top of or near a TV set may cause distortion in the images and/or sound due to the electromagnetic waves that the set emits.
- The powerful magnetic fields generated by speakers or large motors may damage your recordings or distort the images.
- The electromagnetic waves emitted from a microcomputer will adversely affect the camera-recorder, causing the images and/or sound to be distorted.
- If the camera-recorder is so adversely affected by products that generate magnetic fields that it no longer operates properly, turn it off and remove the battery or unplug the AC adaptor from the power outlet. Then install the battery again or reconnect the AC adaptor. After this, turn the camera-recorder back on.

Do not use the camera-recorder near radio transmitters or high-voltage equipment.

- Using the camera-recorder near a radio transmitter or high-voltage equipment may adversely affect the recorded images and/or sound.

Do not allow any sand or dust to get into the camera-recorder when using it at the beach and other similar places.

- Sand and dust can damage the camera-recorder or a card. (Be especially careful when inserting or removing a card.)

AC adaptor and battery

- If the CHARGE lamp continues to blink even when the battery temperature is normal, there may be something wrong with the battery or AC adaptor. Contact your dealer.
- The battery takes longer to charge when it is warm.
- The AC adaptor can interfere with radio reception so keep radios at least 1 meter away from it.

- The AC adaptor may make some noise when you are using it, but this is normal.

Take precautions not to drop the camera when moving it.

- Strong impacts may damage the camera and cause it to stop working.
- Handle the camera with care, using the hand strap or shoulder strap to carry it.

Do not spray the camera with insect sprays or other volatile substances.

- These can warp the camera or cause the finish to come off.
- Do not leave the camera-recorder in contact with rubber or PVC products for extended periods of time.

After use, remove the battery and disconnect the AC power supply cable.

Battery characteristics

This camera-recorder uses a rechargeable lithium-ion battery that uses its internal chemical reaction to generate electrical energy. This reaction is easily influenced by the ambient temperature and humidity, and the battery's effective operating time is reduced as the temperature rises or falls. In very low temperatures, the battery may last only 5 minutes.

Protective circuitry functions if you use the battery where it is very hot and you will have to wait before you can use it again.

Remove the battery after use.

Completely remove the battery. (The battery continues to be used even if you have turned the camera off.) The battery can over discharge if you leave it in the camera and it may become impossible to recharge it.

Disposing of spent batteries

The battery will become unchargeable. Rather than throwing the battery into the garbage, take it to a store that can assist in recycling it.

What to remember when throwing memory cards away or transferring them to others

Formatting memory cards or deleting data using the functions of the unit or a computer will merely change the file management information: it will not completely erase the data on the cards. When throwing these cards away or transferring them to others, either physically destroy them or use a data deletion program for computers (commercially available) to completely erase the data. Users are responsible for managing the data on their memory cards.

Liquid crystal displays

- Images or letters can get burned onto the viewfinder's LCD monitor if they are displayed for a long time, but you can fix this by leaving the camera off for several hours.
- The pixels of the LCD monitor are controlled to obtain high precision with 99.99 % of the effective pixels. This leaves less than 0.01 % of pixels that may not light or may remain on all the time. These phenomena are normal and will have no effect on the images you shoot.
- Condensation may form if you use the camera where temperatures fluctuate. Wipe dry with a soft, dry cloth.
- The viewfinder's LCD monitor may appear dim after immediately turning on a cold camera, but will brighten as the camera warms up.

Do not point the lens or viewfinder at the sun.

Doing so may damage the parts inside.

Protective caps for the connectors

Keep the protective caps fitted over any connectors that are not being used.

Precaution for use

Always take some trial shots before actual shooting.

- When shooting important events (such as weddings), always take some trial shots and check that the sound and images have been recorded properly before actual shooting.

Be sure to check and set the calendar and time zone.

- These settings affect the control of the recorded contents. Before making a recording, set and check the calendar and time zone. (Page 35)

Panasonic makes no guarantees for your recordings.

- Please understand that Panasonic makes no guarantees for your recordings in cases where images and/or sound were not recorded as you intended due to problems with the camera-recorder or SD/SDHC Memory Cards.

Respect copyrights

- Copyright laws forbid the use of video and audio material you have recorded for any purpose other than your own personal enjoyment. Remember that restrictions apply to the shooting of certain material even if it is intended for private use.

Media that can be used in this unit

- SD/SDHC Memory Cards can be used in this unit. For details, refer to page 12.
- SDXC Memory Cards cannot be used with this product.

Tripod receptacle

The tripod receptacle is a hole used to mount a tripod for the unit. (For details on mounting the tripod, refer to the operating instructions for the tripod.)

- Compatible with the ISO1222 (1/4) standard.
- The tripod mounting hole is 5.5 mm deep. Do not force the tripod screw beyond this depth. You can damage the camera-recorder if you use any screw other than 1/4-20UNC.

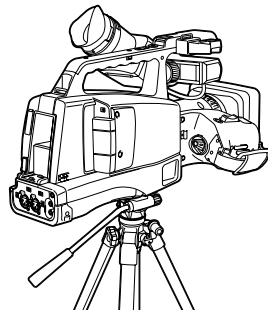
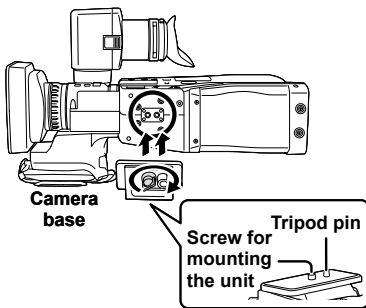

- When using the tripod, operations can be performed more easily using a remote control connected to the CAM REMOTE jack.

Connecting the IEEE1394 cable

Always heed the following instructions when connecting the IEEE1394 cable (not included.) (If it is connected incorrectly, this may lead to the failure of this camera or external devices.)

- Connect or disconnect the IEEE1394 cable after switching off the power of all connected devices. Devices with an earth terminal should be earthed (or connected to a shared GND) when using them.
- When connecting this camera to devices with a 4-pin terminal, connect this camera's terminal (6-pin) in advance.
- The terminal of the IEEE1394 cable has an orientation.
- When connecting the cable to an external device with a 6-pin IEEE1394 terminal, connect it as per with the following configuration.

✓ (Correct)

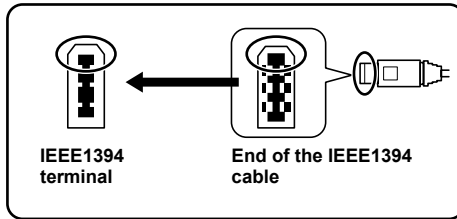

× (Incorrect)

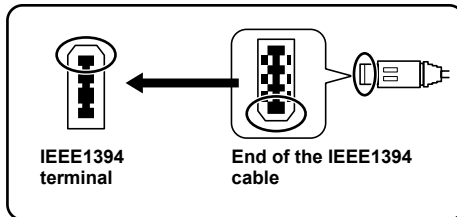

For other usage notes, see page 8.

Precaution for use (continued)

SD Memory Cards compatible with this product

AVCHD mode

It is recommended that you use SD Memory Cards or SDHC Memory Cards* of SD speed class 2 or above, or the following Panasonic SD Memory Cards (correct as of August 2010).

* Speed class 4 or above is required for recording in PH mode or HA mode. SDXC Memory Cards cannot be used with this product.

Card type	Recording capacity	Recording/playback	Photo shooting Loading metadata
SD Memory Card	8 MB 16 MB	Cannot be used.	Can be used.
	32 MB 64 MB 128 MB 256 MB	Successful operation cannot be guaranteed. Recording may be suddenly terminated with certain SD Memory Cards.	
	512 MB	RP-SDV512	
	1 GB	RP-SDV01G RP-SDM01G	
	2 GB	RP-SDV02G RP-SDM02G RP-SDP02G	
	SDHC Memory Card	4 GB	
6 GB		RP-SDM06G	
8 GB		RP-SDV08G RP-SDM08G RP-SDW08G RP-SDP08G	
12 GB		RP-SDM12G RP-SDP12G	
16 GB		RP-SDV16G RP-SDM16G RP-SDW16G RP-SDP16G	
32 GB		RP-SDV32G RP-SDW32G RP-SDP32G	

- Please see our support page at the following website for the latest information not included in these operating instructions.
<http://pro-av.panasonic.net/>
- This product is compatible with SD Memory Cards formatted under the SD-standard FAT12 and FAT16 formats, and with SDHC Memory Cards formatted under the FAT32 format.
- Only SDHC Memory Cards may be used for capacities of 4 GB or greater.
- 4 GB (or greater) memory cards without the SDHC logo are not based on the SD standard.
- Use this product to format the SD Memory Cards to be used. Formatting memory cards on computers or other devices may cause recording to take longer than normal, or may cause cards to become incompatible with this product. (Page 28 of Vol.2) (Use this product to reformat any cards that have already been formatted on computers, etc.)
- Always install the relevant special adapter when using microSD/microSDHC cards with this product. (The product will not operate correctly if only the adapter is inserted – always insert a memory card into the adapter first.)
- MultiMediaCards cannot be used with this product.

DV mode

When shooting in DV mode, it is necessary to use SD Memory Cards or SDHC Memory Cards* of speed class 6 or above.

It is recommended that you use the following Panasonic SD Memory Cards (as of August 2010).

* SDXC Memory Cards cannot be used with this product.

Card type	Recording capacity	Recording/playback
SD Memory Card	8 MB 16 MB	Cannot be used.
	32 MB 64 MB 128 MB 256 MB	Cannot be used.
	512 MB	RP-SDV512
	1 GB	RP-SDV01G
	2 GB	RP-SDV02G
	SDHC Memory Card	4 GB
8 GB		RP-SDV08G RP-SDW08G
16 GB		RP-SDV16G RP-SDW16G
32 GB		RP-SDV32G RP-SDW32G

- Please see our support page at the following website for the latest information not included in these operating instructions.
<http://pro-av.panasonic.net/>
- This product is compatible with SD Memory Cards formatted under the SD-standard FAT12 and FAT16 formats, and with SDHC Memory Cards formatted under the FAT32 format.
- Only SDHC Memory Cards may be used for capacities of 4 GB or greater.
- 4 GB (or greater) memory cards without the SDHC logo are not based on the SD standard.
- Use this product to format the SD Memory Cards to be used. Formatting memory cards on computers or other devices may cause recording to take longer than normal, or may cause cards to become incompatible with this product. (Page 76 of Vol.2) (Use this product to reformat any cards that have already been formatted on computers, etc.)
- Always install the relevant special adapter when using microSD/microSDHC Memory cards with this product. (The product will not operate correctly if only the adapter is inserted – always insert a memory card into the adapter first.)
- MultiMediaCards cannot be used with this product.

Precaution for use (continued)

This product (SDHC-compatible device) is compatible both with SD Memory Cards and with SDHC Memory Cards. SDHC Memory Cards may be used with SDHC Memory Card-compatible devices, but cannot be used with devices that are only compatible with SD Memory Cards. (Always check the relevant product's operating instructions when using SDHC Memory Cards with other devices.)

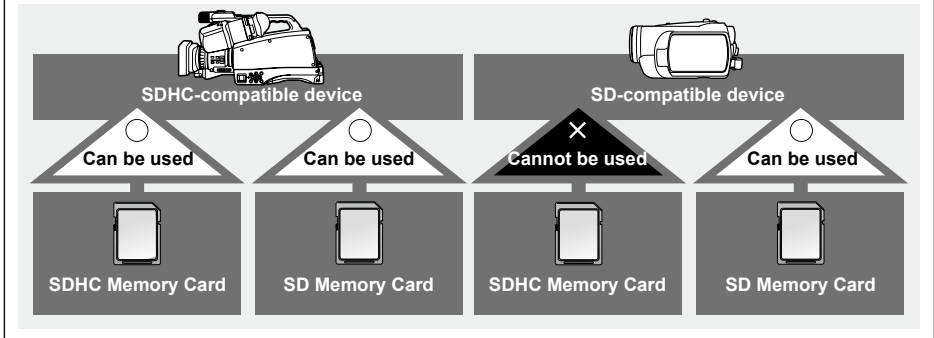

CLASS 6 (SD speed class 6)

This refers to a class 6 speed standard (SD speed class) for the continuous writing of data between SD-compatible devices and SD Memory Cards, as designated by the SD standards.

When the use of an SD speed class 6 card is recommended for SD-compatible products, this indicates that stable recording operation can be achieved when using SD Memory Cards of class 6 and above.

- Speed class 4 or above is required for recording in AVCHD mode, or 6 or above for DV mode when shooting with this camera.

Cautions for usage

- Do not allow dirt, water, or other substances to come into contact with the connector part on the reverse of the card.
- Do not leave the card in the following places:
 - In direct sunlight or in places of high humidity, e.g. close to heating equipment
 - In highly humid or dusty locations
 - In locations with high variations in temperature (condensation may appear on card)
 - In places subject to static electricity or electromagnetic waves
- Store cards in bags or cases after use.

SDHC Memory Cards

- SDHC Memory Cards cannot be used with non-SDHC-compatible equipment.
- Ensure that all equipment is SDHC-compatible when using card with other devices.



Compatibility of recorded video

Shooting video in AVCHD mode

- Recorded video cannot be used with non-AVCHD-compatible equipment. For details, please see your product's operating instructions.
- Recorded video cannot be played back on non-compatible (non-AVCHD-compatible) equipment.
- Playback may not always be possible on all AVCHD-compatible equipment. Please use this product for playback in such instances.

Shooting video in DV mode

- It is not compatible with AV devices fitted with a Panasonic SD Memory Card slot (DIGA, VERA, TV, digital video camera).
- Video is recorded in AVI Type 2 file format and can be played back on computers using AVI Type2-compatible media players.

About AVCHD

- AVCHD is a standard for the recording and playback of highly detailed, high-definition video.
- Video is compressed in the MPEG-4 AVC/H.264 formats, and audio is recorded in Dolby Digital.

About DV

- It uses the AVI Type 2 file format and can play back with the DV compatible mode.
- Sound is recorded using the 2 ch uncompressed linear PCM system.

Using this Camera

This camera is mounted with a 1/4.1-type MOS sensor x 12, and is a shoulder type camera recorder that uses SD/SDHC memory cards for recording media.

It can record and play back SD images (DV mode) in addition to recording and playing back HD images (AVCHD mode) with 1080 and 720 scan lines.

Shooting and playing back with this camera

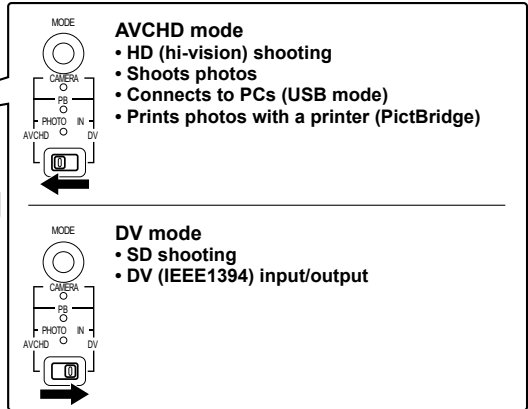
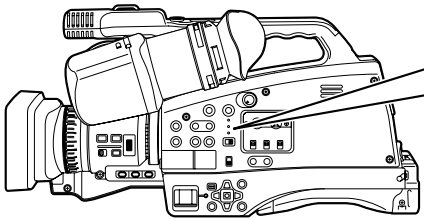

■ AVCHD mode

- Video shooting (CAMERA mode)
Shooting in auto mode (Page 37)
Shooting in manual mode (Page 5 of Vol.2)
- Photo shooting (PHOTO mode)
Shooting photos (Page 31 of Vol.2)
- Playback (PB mode)
Playing back clips (Page 40 of Vol.2)
Playing back photos (Page 42 of Vol.2)
- Other functions
Connecting to a computer (USB mode)
(Page 53 of Vol.2)
Printing photos on a printer (PictBridge)
(Page 47 of Vol. 2)

■ DV mode

- Video shooting (CAMERA mode)
Shooting in auto mode (Page 37)
Shooting in manual mode (Page 54 of Vol.2)
- Playback (PB mode)
Playing back clips (Page of 84 Vol.2)
- Other functions (DV IN mode)
DV (IEEE1394) output and input (Pages 73,
90 of Vol.2)

Editing and saving with external devices

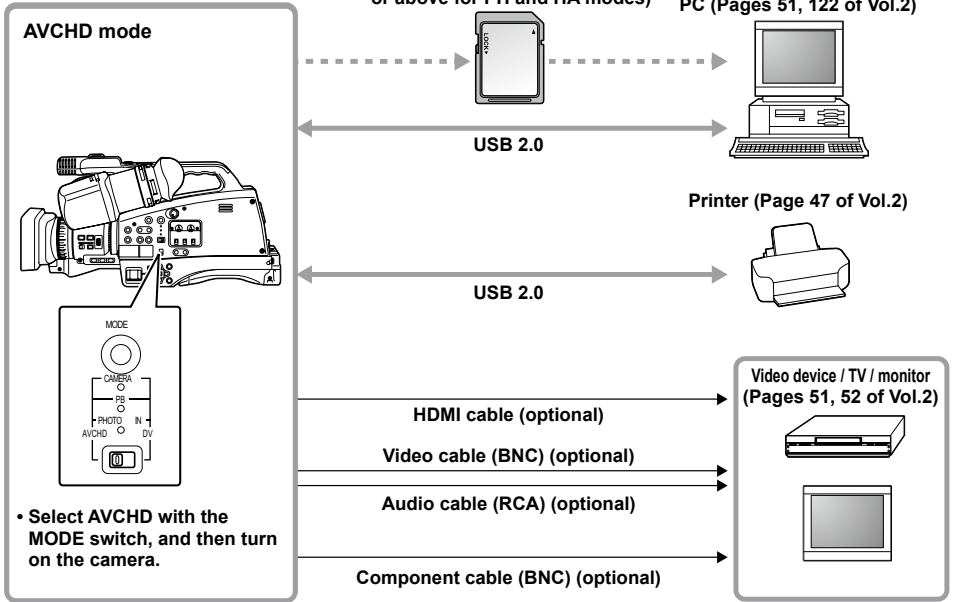

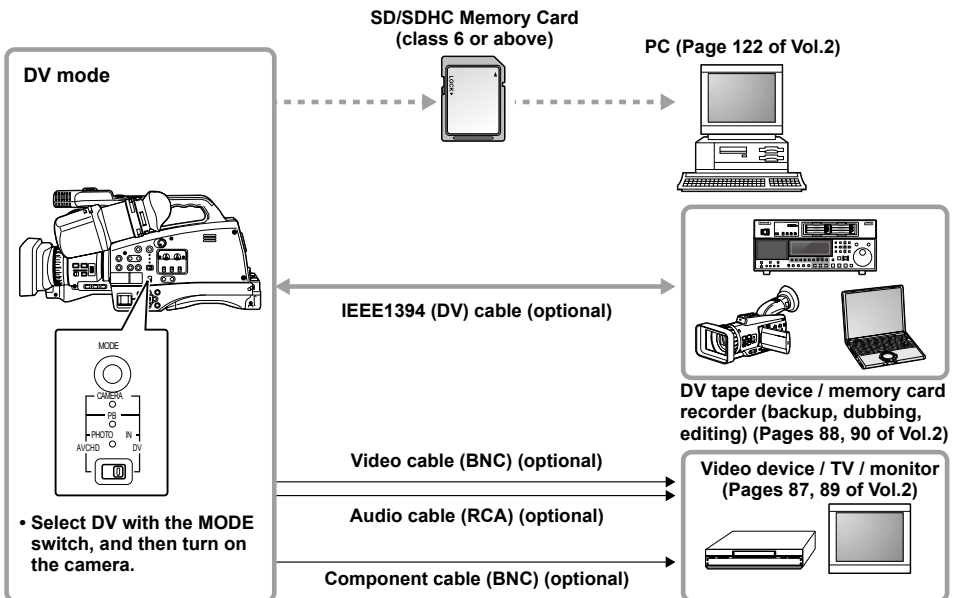

* There is no DV (1394) input/output function.





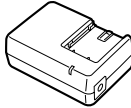

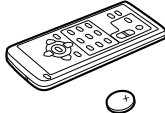
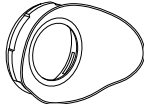
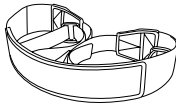
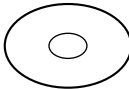
* There are no USB connection and HDMI output functions.

Accessories

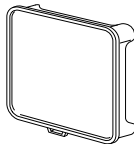
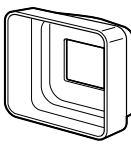
<p>Battery*1</p> 	<p>AC Adaptor</p> 	<p>AC power supply cable/ DC cable</p> 	<p>Wireless remote control and battery (CR2025)</p> 
<p>Eye cup</p>  <p>→ See "Fitting the eye cup". (Page 28)</p>	<p>Shoulder strap</p>  <p>→ See "Attaching the shoulder strap". (Page 27)</p>	<p>CD-ROM</p> 	

The following accessories are attached to the unit.

<p>Lens hood cap</p> 	<p>Lens hood</p> 	<p>Lens hood (inner)</p> 	<p>Grip belt</p> 
<p>XLR audio adaptor cap</p> 			

*1 For part numbers for the battery, see "Optional accessories". (Page 19)

- Please consult a retailer when purchasing additional accessories.
- After removing the package contents, discard the packaging materials appropriately.
- Some of the supplied accessories may not be manufactured in Japan.

Optional accessories

• Battery

VW-VBG260 (7.2 V, 2640/2500 (typ./min.) mAh: equivalent to accessory battery)

VW-VBG6 (7.2 V, 5800/5400 (typ./min.) mAh: compatible with supplied battery charger)

• Tele conversion lens

VW-T4314H (See below for attachment instructions.)

• Wide conversion lens

VW-W4307H (See below for attachment instructions.)

Using tele conversion lenses, wide conversion lenses

Remove both the lens hood and lens hood (inner) before attaching an optional VW-T4314H tele conversion lens or VW-W4307H wide conversion lens. For details on removing the lens hood, see page 28.

Removing and attaching the lens hood (inner)

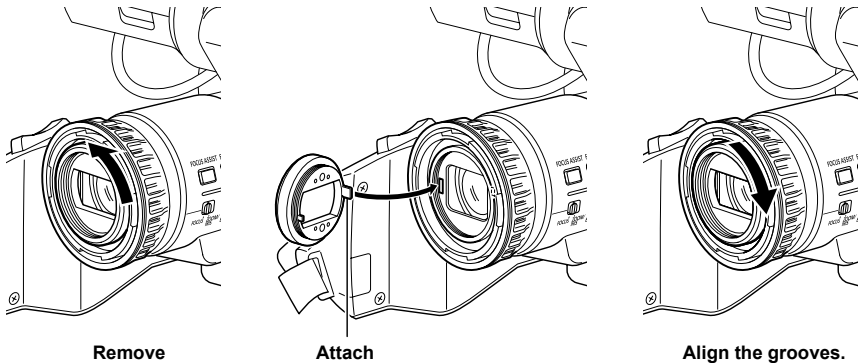

- Attach the ND filter and MC protector to the front of the lens hood (inner).

- Although you can attach both a filter and a conversion lens at the same time (such as attaching both an ND filter and a tele conversion lens), we do not recommend it, as the corners of images may appear darker (vignetting) during wide-angle zoom. (If you do attach both at the same time, remove the lens hood (inner) first.)

Description of parts

Front side and rear side

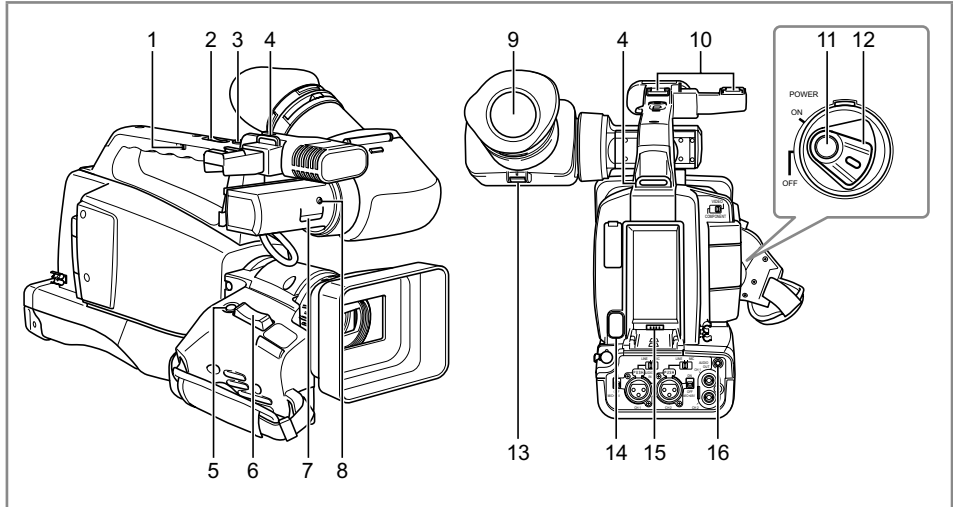

- | | |
|---|-------------------------------------|
| 1 Handle zoom switch (Page 39) | 9 Viewfinder (Page 32) |
| 2 Handle zoom lever (Page 39) | 10 Accessory shoe |
| 3 Handle START/STOP button (Pages 10, 59 of Vol.2) | 11 START/STOP button (Page 37) |
| 4 Shoulder belt installation hole (Page 27) | 12 POWER switch (Page 30) |
| 5 REC CHECK/PHOTO SHOT button (Page 38, Page 31 of Vol.2) | 13 Lock button (Page 33) |
| 6 Zoom lever (Page 39) | 14 Battery release button (Page 26) |
| 7 Remote control sensor (Page 29) | 15 Battery compartment (Page 26) |
| 8 Tally lamp (FRONT) (Page 30) | 16 Tally Lamp (REAR) (Page 30) |

Right Side

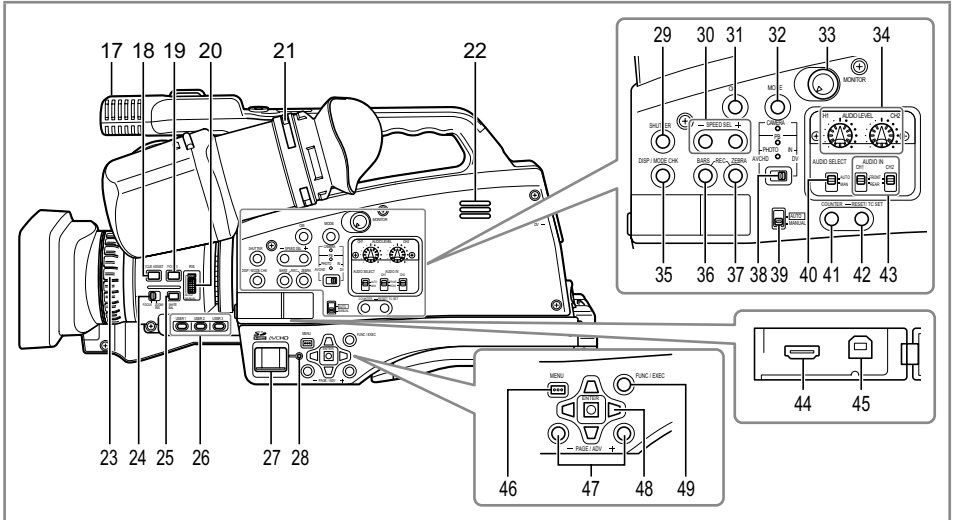

- 17 Built-in microphone
- 18 FOCUS ASSIST button (Pages 6, 55 of Vol.2)
- 19 FOCUS button (Pages 5, 54 of Vol.2)
- 20 IRIS dial (Pages 6, 55 of Vol.2)
- 21 Diopter adjustment lever (Page 32)
- 22 Speakers
- 23 FOCUS ring (Pages 5, 54 of Vol.2)
- 24 RING switch (Pages 5, 54 of Vol.2)
- 25 WHITE BAL button (Pages 7, 56 of Vol.2)
- 26 USER1 - 3 button (Pages 12, 61, 107 of Vol.2)
- 27 Memory Card cover (Page 36)
- 28 ACCESS lamp (Page 36)
- 29 SHUTTER button (Pages 15, 65 of Vol.2)
- 30 SPEED SEL +/- button (Pages 15, 65 of Vol.2)
- 31 OIS button (Pages 11, 60 of Vol.2)
- 32 MODE button (Page 31, Pages 31, 40, 42, 90 of Vol.2)
- 33 MONITOR LEVEL knob (Page 42 of Vol.2)
- 34 AUDIO LEVEL knob (Pages 20, 70 of Vol.2)
- 35 DISP/MODE CHK button (Pages 11, 60 of Vol.2)
- 36 BARS button (Pages 12, 61 of Vol.2)
- 37 ZEBRA button (Pages 10, 59 of Vol.2)
- 38 MODE switch (Page 37)
- 39 AUTO/MANUAL switch (Page 37, Pages 5, 54 of Vol.2)
- 40 AUDIO SELECT switch (Pages 20, 70 of Vol.2)
- 41 COUNTER button (Pages 25, 73 of Vol.2)
- 42 RESET/TC SET button (Pages 25, 73 of Vol.2)
- 43 AUDIO IN CH1/CH2 switch (Pages 18, 68 of Vol.2)
- 44 HDMI terminal (Page 52 of Vol.2)
- 45 USB2.0 terminal (Page 51 of Vol.2)
- 46 MENU button (Page 40)
- 47 PAGE/ADV +/- button (Pages 35, 37 of Vol.2)
- 48 Cursor button (Page 31)
- 49 FUNC/EXEC button (Page 41)

Left side

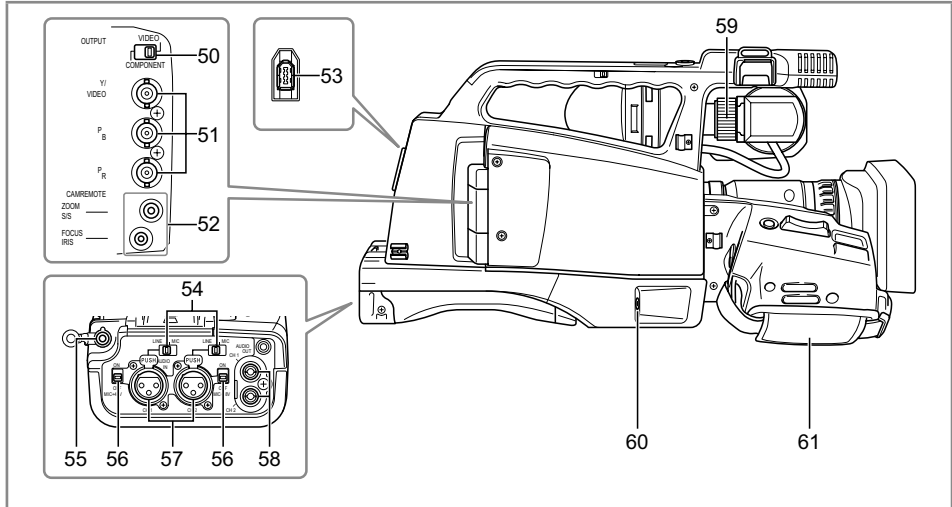

50 OUTPUT switch (Pages 52, 89 of Vol.2)

51 VIDEO terminal (BNC)/ COMPONENT OUT (Y/Pb/Pr) terminal (BNC) (Pages 52, 89 of Vol.2)

52 CAM REMOTE jacks*

FOCUS/IRIS (3.5 mini jack)

You can connect a remote control unit to control the FOCUS and IRIS (aperture). IRIS (aperture) control beyond OPEN is performed via gain adjustment, and can be set up to the standard gain setting.

ZOOM S/S (2.5 mm super mini jack)

You can connect a remote control unit to control zoom and start/stop of recording.

53 DV terminal (Page 88 of Vol.2)

54 Input audio selection switch (Pages 19, 69 of Vol.2)

55 PHONES (headphone) terminal (Pages 50, 86 of Vol.2)

56 MIC + 48 V ON/OFF switch (Pages 19, 69 of Vol.2)

57 XLR input (CH1/CH2) terminal (Pages 19, 69 of Vol.2)

58 AUDIO OUT (CH1/CH2) terminal (Pages 52, 87, 89 of Vol.2)

59 Left and right position lock ring (Page 32)

60 EXT MIC terminal (Pages 50, 86 of Vol.2)

61 Grip belt (Page 27)

* Do not connect any equipment except the remote controller to the remote control jack. Connecting any equipment other than the remote control may cause the image brightness to change and/or the images to appear out of focus.

Remote control

To use the remote control, set the IR REMOTE item on the OTHER FUNCTIONS menu to ON. The default setting for this item is OFF. (Page 110 of Vol.2)

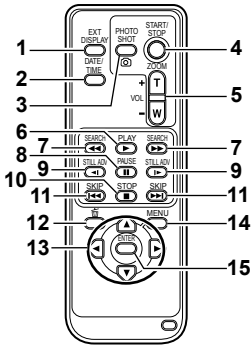

Remote control usable range (Page 29)

- 1 **EXT. DISPLAY button** (Pages 49, 85 of Vol.2)
- 2 **DATE/TIME button** (Pages 49, 85 of Vol.2)
- 3 **PHOTO SHOT button** (Page 31 of Vol.2)

Performs only the PHOTO SHOT function of the REC CHECK/PHOTO SHOT button on the camera.

- 4 **START/STOP button** (Page 37)
- 5 **ZOOM/VOL buttons** (Page 39)
- The sound volume of the camera cannot be adjusted using the remote control.
- 6 **PLAY button** (Pages 41, 84 of Vol.2)
- 7 **SEARCH buttons** (Pages 40, 41, 84 of Vol.2)
- 8 **PAUSE button** (Pages 40, 41, 84 of Vol.2)
- 9 **STILL ADV buttons** (Pages 41, 84 of Vol.2)
- 10 **STOP button** (Pages 40, 84 of Vol.2)
- 11 **SKIP buttons** (Pages 40, 84 of Vol.2)
- 12 **🗑️ button**

Does not function with this camera.

13 OPERATION buttons

Same function as the cursor button (menu operation) on the camera.

14 MENU button

Same function as the MENU button on the camera.

15 ENTER button

Confirms menu and item selections.

Preparation

Recharging the battery

Recharging

The battery does not come ready charged when the camera is purchased. Charge the battery before use.

It is recommended that you keep one extra battery as a spare.

1 Connect the power cable to the AC adaptor.

Disconnect the DC cable.
(Battery cannot be charged if DC cable is connected.)

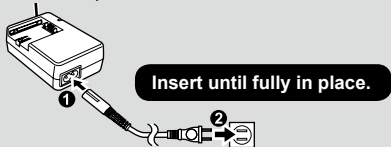

2 Insert the battery.

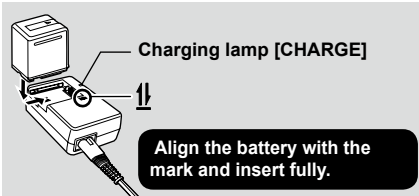

■ Charging lamp

On: Charging in progress

Off: Charging complete

Flashing: See below

■ If charging lamp is flashing

Check that there is no dirt, dust, or other substances attached to the connectors on the battery or AC adaptor, and ensure that the adapter has been connected correctly.

- If there is dirt or dust on the connectors, disconnect the power plug from the socket before cleaning.
- If the charging lamp continues to flash, there may be a fault with the battery or the AC adaptor. Please consult with the place of purchase.

■ Charging time and available recording time (Approx.)

Battery model	Voltage/capacity	Charging time	Maximum continuous recording time
VW-VBG260 (included)	7.2 V/ 2640/2500 (typ./min.) mAh	Approx. 170 min.	Approx. 85 min.
VW-VBG6 (optional)	7.2 V/ 5800/5400 (typ./min.) mAh	Approx. 350 min.	Approx. 170 min.

- The figures in the table above are guidelines for use in normal temperature conditions (temperature 25 °C (77 °F), humidity 60 %). Charging may take longer in higher or lower temperatures.
- Charging may take longer if the battery has not been in use for a long period of time.
- The maximum continuous recording times given here assume that the camera is recording in DV mode with no external devices connected.
- Available recording time may vary according to usage conditions.
- Charging times are based on charging batteries from an empty state.

■ Remaining battery capacity displays



When using Panasonic-manufactured batteries compatible with this product, the remaining battery capacity is displayed in minutes.

 90min.

Time remaining will be displayed after a brief pause.

- The battery display will change



as battery capacity decreases.  will be displayed in red when less than 3 minutes are remaining, and  will flash when the battery is empty.

- Remaining battery capacity may not be displayed correctly when using in high or low temperatures, or when the battery has not been used for a long period of time. To ensure that remaining battery capacity is displayed correctly, use the battery completely from a fully-charged state, and charge the battery again. (Remaining battery capacity may still not be displayed correctly if the battery has been used for long periods in high or low temperatures, or if the battery has been recharged a large number of times.)
- The remaining battery capacity display is a guideline and may change according to usage conditions.
- The remaining battery capacity display will momentarily disappear when switching between modes, when conducting REC CHECK operations or when changing the LCD brightness since the capacity is recalculated at these times.
- Not displayed when using AC adaptor.
- The maximum time display for the remaining battery capacity is 999 minutes.
- If the remaining battery capacity exceeds 999 minutes, the remaining time is displayed in green. This display does not change until the remaining time reaches 999 minutes or below.

- **Keep metal objects (such as necklaces and hairpins) away from the battery.**

Short-circuiting may occur across the terminals, causing the battery to heat up, and you may seriously burn yourself if you touch the battery in this state.

- The battery becomes hot while it is being used or charged. The camera-recorder itself also becomes hot during use.
- The recordable time reduces if you repeatedly start and stop recording.
- The battery takes longer to charge when it is warm.
- The AC adaptor can interfere with radio reception so keep radios at least 1 meter away from it.
- The AC adaptor may make some noise when you are using it, but this is normal.
- Battery cannot be recharged when the DC cable is connected to the AC adaptor.

Power sources

Using the battery

Installation

Insert the battery until it clicks into place.

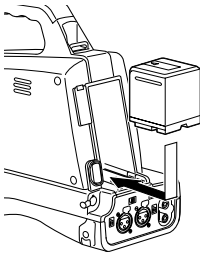

Removal

- 1 Set the POWER switch to OFF, and check that the mode lamp is off.
- 2 Remove the battery while pressing the battery release button.
 - The lock can be released and the battery removed.

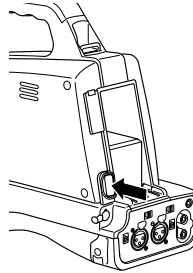

Using the AC adaptor

Installation

- 1 Connect the DC cable to the AC adaptor.
- 2 Plug the AC power supply cable into the power outlet.
- 3 Insert the DC cable's battery connector until it clicks into place.

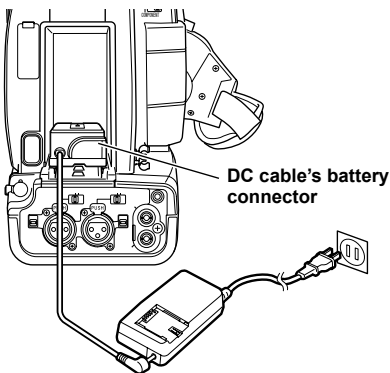

Removal

- 1 Set the POWER switch to OFF, and check that the mode lamp is off.
- 2 Remove the DC cable's battery connector while pressing the battery release button.
- 3 Disconnect the AC power supply cable from the power outlet.

- Battery cannot be recharged when the DC cable is connected to the AC adaptor.
- Disconnect the AC power supply cable from the power outlet when the unit is not going to be used.

CAUTION:

- This apparatus can be operated at a voltage in the range of 110 – 240 V AC. Voltages other than 120 V are not intended for U.S.A. and Canada. Operation at a voltage other than 120 V AC may require the use of a different AC plug. Please contact either a local or foreign Panasonic authorized service center for assistance in selecting an alternate AC plug.

Adjusting the grip belt

Adjust the grip belt to suit your hand, and hold it correctly.

1 Open the belt cover and loosen the belt.

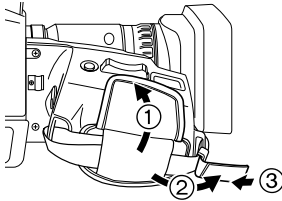

- When loosening the belt, please take care so that the belt does not come away from the grip belt stopper.

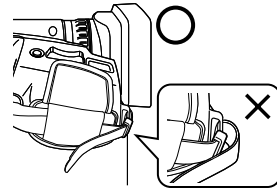

Grip belt stopper

2 Work your hand through the grip belt and fasten the belt.

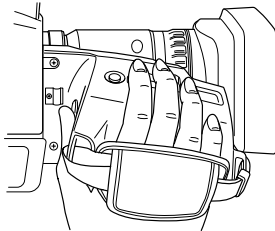

- Slip your hand through the belt as far as it goes.
- Tighten up the belt so that your hand remains firmly in place.

Attaching the shoulder strap

Attach the shoulder strap and use it as a precaution against dropping the camera.

1 Thread the belt through the shoulder belt installation hole.

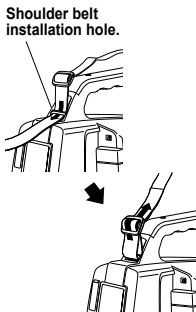

2 Install the belt on the other shoulder belt installation hole.

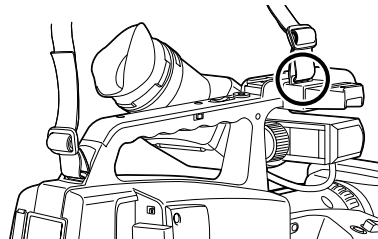

- Thread the belt through the fastener after threading through the shoulder belt installation hole. At least 2 cm of the belt must extend from the fastener.

Detaching and attaching the lens hood

Detaching the lens hood

- Turn the lens hood counterclockwise to detach it.

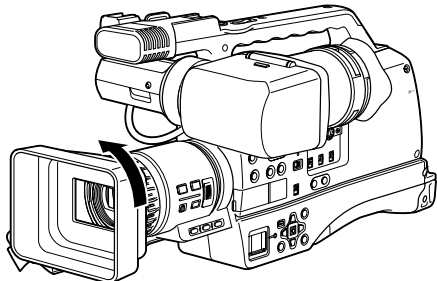

Attaching the lens hood

- Orient the lens hood with the arrow mark on top, rotate the hood counterclockwise (approx. 14°) to align the arrow with the one on the camera, and then slide the hood onto the camera.
- Rotate the lens hood clockwise to attach it.
- Be sure to attach the lens hood cap to protect the lens when not in use.

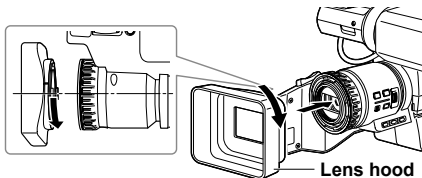

Attaching the lens hood cap

The lens can be covered by attaching the lens hood cap provided to the lens hood.

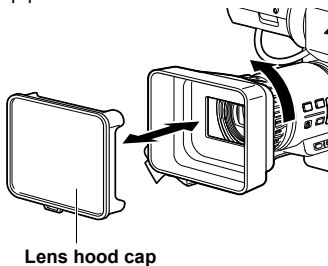

Fitting the eye cup

To attach the eye cup, align the projections on the eye cup holder and eye cup, and fit the holder and eye cup together.

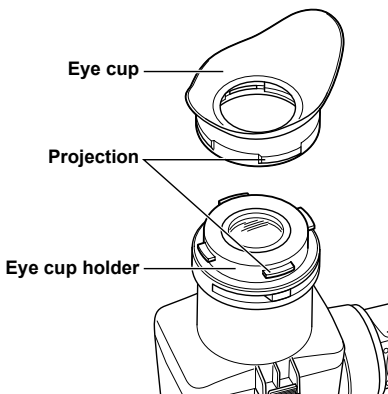

- Turning the eye cup after attaching it to its holder may cause the holder to become disengaged.

The remote control

Insert the battery

- 1 Push the catch in the direction shown by arrow ① to remove the holder.

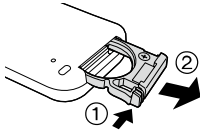

- 2 Insert the battery with the “+” marked side facing up.

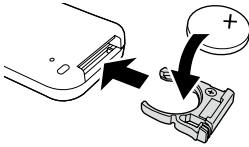

- 3 Return the holder to its original position.

- When the battery (CR2025) has run out, replace it with a new one. (The battery lasts about one year, depending on the frequency of use.) If the remote control unit fails to work even when it is operated near the camera-recorder's remote control sensor, the battery has run out.
- **Keep the battery out of the reach of children.**

Remote control usable range

The distance between the remote control and the unit's remote control sensor: Within approx. 5 m
Angle: Approximately 15° upward, approximately 10° downward, approximately 15° leftward, or approximately 15° rightward (Except when optional accessories are attached)

Remote control sensor

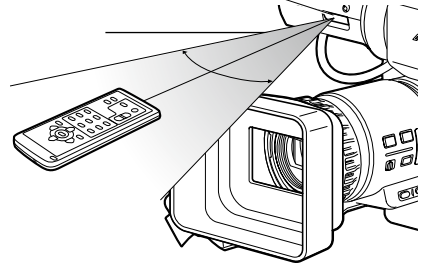

- The remote control is intended for indoor operation. Outdoors or under strong light, the unit may not operate properly even within the usable ranges.
- The default setting for this item is OFF. To use the remote control, set the IR REMOTE item on the OTHER FUNCTIONS menu to ON. (Page 110 of Vol.2)

Basic Operations

Turn on/off the camera

While pressing the lock release button, move the POWER switch to ON or OFF.

Turn on the camera:

The mode lamp (CAMERA) lights red (camera mode), and the camera enters recording standby mode.

Turn off the camera:

The mode lamp (CAMERA) goes out.

• Energy-saving mode

Depending on the setting made for the POWER SAVE item of the OTHER FUNCTIONS screen in the settings menu, the following will apply if no designated operations* are performed for approximately five minutes in the recording standby modes of CAMERA mode and PHOTO mode (when an SD Memory Card has been inserted while using the battery).

ON: The camera recorder turns off automatically.

OFF: Does not switch OFF the camera.

* See the setup menus, POWER SAVE (Page 111 of Vol.2) for details.

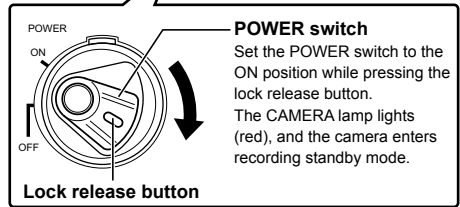
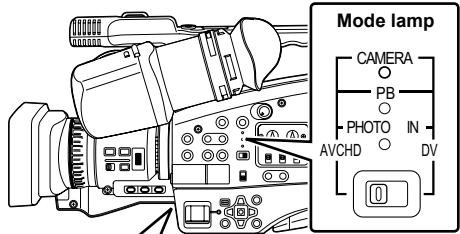

Tally lamp

You can set the tally lamp to light in the following situations by setting the REC LAMP item (Page 110 of Vol.2) in the OTHER FUNCTIONS screen to OFF.

The tally lamp light can be switched to FRONT, REAR or BOTH with the setting menu. For more details, refer to the setting menu REC LAMP item (Page 110 of Vol.2).

- Battery is low (flashes 4 times per second)
- Available SD Memory Card capacity is low (flashes 4 times per second)
- Remaining battery capacity is low (flashes once per second)
- Remaining memory of the SD Memory Card is low (flashes once per second)

In addition, the location set for the REC LAMP item will flash when receiving commands from the remote control.

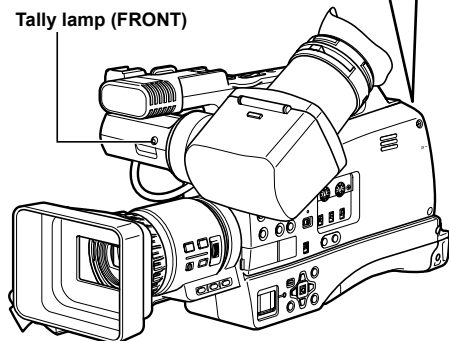
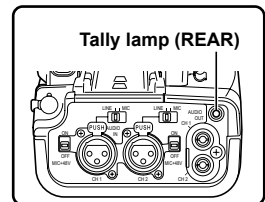

Using the cursor button

This unit has a cursor button for selecting menu items and performing play back operations.

Basic operations

The following describes operations on the menu screen and selection of files on the thumbnail view screen etc.

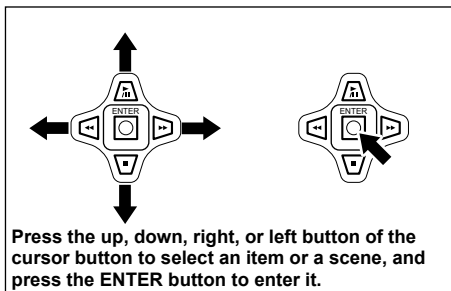
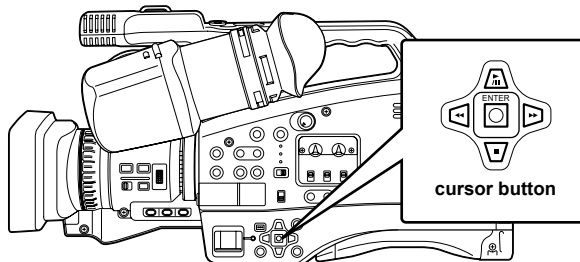

Select an item by pressing the up, down, right, or left button of the cursor button and enter the selection by pressing the ENTER button.

Menu screen operations

- 1 Press the MENU button to display the menu.**
 - The thumbnail menu is displayed when in DV or PB mode. Press and hold the MENU button to display the normal menu.
- 2 Select an item by pressing the ENTER button.**
 - Perform the same operation to select additional items or to set numerical values.
- 3 Press the MENU button to exit the menu screen.**

Playback mode (PB mode only)

- 1 Press the MODE button and switch to PB mode.**
- 2 Select a clip or photo to play back with the cursor button, and press the ENTER button.**
- 3 Operate by pressing the up, down, right, or left button of the cursor button.**

Using the viewfinder

This camera has a viewfinder which uses a retractable 69 mm (2.7 inch) LCD.

- The brightness and hue may differ between the images appearing on the viewfinder (LCD monitor) and those displayed on a TV monitor. To see how the final images will appear, check them on a TV monitor.

Using the viewfinder

- 1 Set the POWER switch to ON, and check that images appear in the viewfinder.**

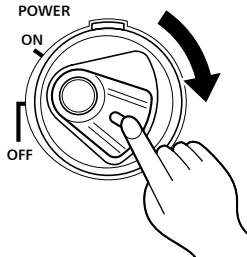

- 2 Adjust the angle of the viewfinder to a convenient viewing position.**

- The viewfinder can be rotated 180° towards the lens and 90° towards the opposite direction.

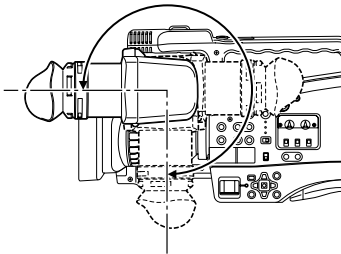

You can record yourself.

- 3 Loosen the left and right position lock ring, and adjust the horizontal position.**

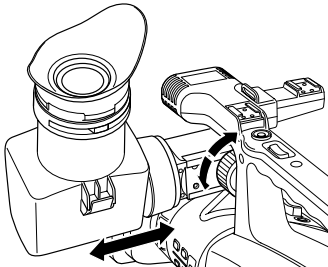

- When you have decided the position, tighten and secure the left and right position lock ring.

- 4 Adjust the diopter adjustment lever until images in the viewfinder are clear.**

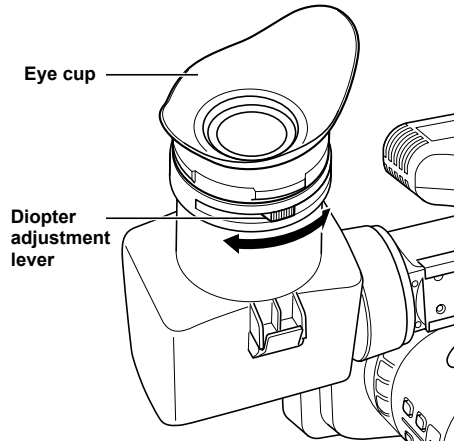

Do not point the viewfinder directly at the sun.

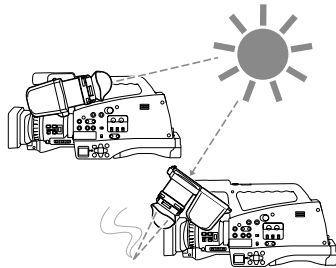

- Doing so may damage internal components.
- When using the camera with the viewfinder opened, sunlight passing through the EVF lens may be magnified. Flammable objects placed in the area of magnified light may ignite.

Using as a LCD monitor

Open the eye piece to use as a LCD monitor.

Opening the eye piece

Open the eye piece while pressing the lock button at the same time.

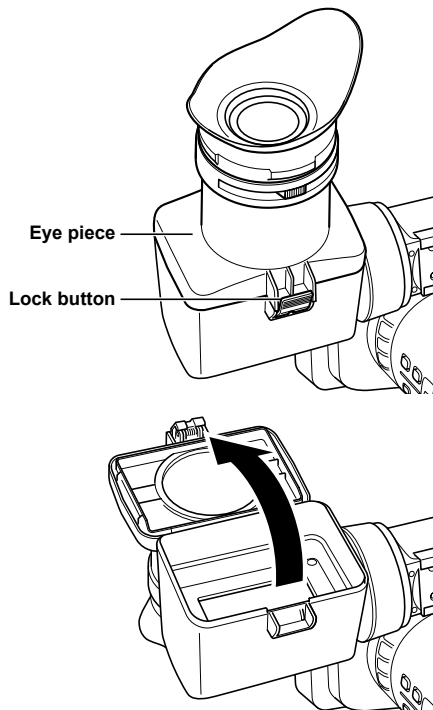

Closing the eye piece

Close the eye piece by pressing it until it clicks into place.

- Rotating the viewfinder with the eye piece open may result in damage to the eye piece or your fingers getting caught.

Emphasizing outlines

When EVF DTL is assigned to one of the USER buttons 1 to 3, you can press that button to emphasize the outlines of images in the viewfinder and make focus alignment easier.

Emphasizing the outlines does not effect the images you shoot.

- 1 Set the POWER switch to ON.** (Page 30)
- 2 Press the MENU button.**
 - Menu operation (Page 40)
 - Operations may also be performed using buttons on the remote control that correspond to those on the camera. For details, see "Description of parts (Remote control)". (Page 23)
- 3 Select either the USER1 SW, USER2 SW or the USER3 SW item in the setting menu SW&DISP SETUP screen, and press the ENTER button.**
- 4 Select EVF DTL and press the ENTER button.**
EVF DTL is assigned to the selected USER button.

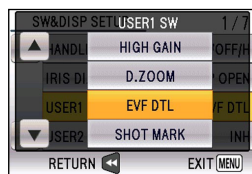

- 5 In CAMERA mode or PHOTO mode, press the USER button assigned to EVF DTL.** "EVF DTL ON" appears in the center of the screen for about 2 seconds. To release the setting, press the USER button assigned to EVF DTL again, and "EVF DTL OFF" appears in the center of the screen for approximately 2 seconds.

Adjusting the screen display

- 1 Set the **POWER** switch to **ON**. (Page 30)
- 2 Press the **MENU** button.
 - Menu operation (Page 40)
 - Operations may also be performed using buttons on the remote control that correspond to those on the camera. For details, see "Description of parts (Remote control)". (Page 23)
- 3 Select **YES** for the **EVF SET** item in the setting menu **SW&DISP SETUP** screen, and press the **ENTER** button.

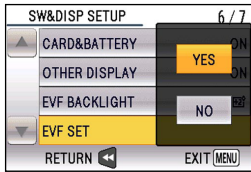

- The viewfinder display can be in color or black and white. (See the setup menus, SW&DISP SETUP screen, EVF COLOR.) The resolution is the same for both of them.
- The menu will be displayed in color even if black and white is selected.

- 4 Press the up or down button of the cursor button to select the item you want to set, and then press the **ENTER** button.

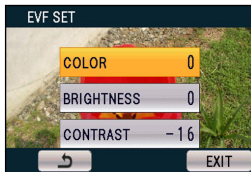

- 5 Press the left or right button of the cursor button to adjust the numerical value of the selected item.

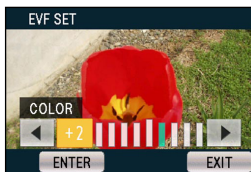

- 6 Select **ENTER** and press the **ENTER** button.
 - Select **EXIT** and press the **ENTER** or the **MENU** button to finish configurations.

Setting the calendar

The CLOCK SET value is recorded in the contents (clip), and affects the sequence of playback of the thumbnails. The "SET DATE AND TIME" message appears when you turn on the camera for the first time. Before carrying out recording, be sure to check and set CLOCK SET and TIME ZONE. This shows you how to adjust the calendar to 14:30 on May 13, 2010.

Setting the time zone

1 Set the POWER switch to ON. (Page 30)

2 Press the MENU button.

- Menu operation (Page 40)
- Operations may also be performed using buttons on the remote control that correspond to those on the camera. For details, see "Description of parts (Remote control)". (Page 23)

3 Select YES for the TIME ZONE item in the setting menu OTHER FUNCTIONS screen, and then press the ENTER button.

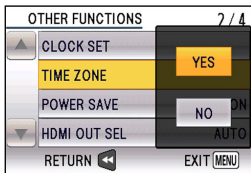

4 Press the up or down of the cursor button to select the difference from Greenwich Mean Time.

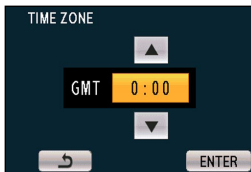

- The factory default setting is +0:00.

5 Select ENTER and press the ENTER button.

- The clock can vary in accuracy, so check that the time is correct before shooting.
- When using the camera overseas, do not set the CLOCK SET option to the local time, but enter the time difference from Greenwich Mean Time using the TIME ZONE option instead. (Page 111 of Vol.2)

Setting the clock

1 Set the POWER switch to ON. (Page 30)

2 Press the MENU button.

- Menu operation (Page 40)
- Operations may also be performed using buttons on the remote control that correspond to those on the camera. For details, see "Description of parts (Remote control)". (Page 23)

3 Select YES for the CLOCK SET item in the setting menu OTHER FUNCTIONS screen, and then press the ENTER button.

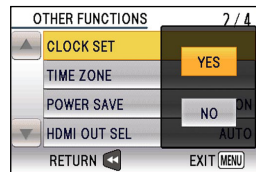

4 Select the item you want to set with the left or right button of the cursor button, and press up or down to set numerical values.



5 Repeat the procedure from step 4 to set the remaining items.

- The date can be set to any date between January 1, 2010 and December 31, 2036.
- "--.--.--" is displayed for any date beyond December 31, 2036.
- The time is displayed in 24-hour format.

6 Select EXIT when you are finished configuring items, and press the ENTER or MENU button to finish setting.

Basic shooting operations

Preparing for recording

1 Set the camera's power switch to OFF.

(Page 30)

- Check that the mode lamp is off.

2 Slide the card cover upwards to open.

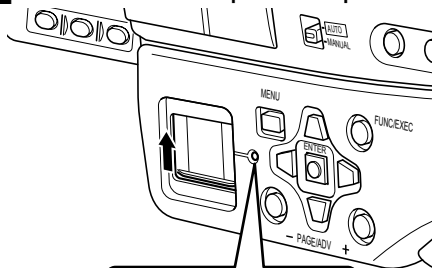

ACCESS lamp

• Flashes during SD Memory Card access (recognition, recording, playback, deletion, etc.). For details, see "SD Memory Card ACCESS lamp".

3 Fully insert an SD Memory Card into the card slot.

- Insert the card in the direction shown until it clicks into place.

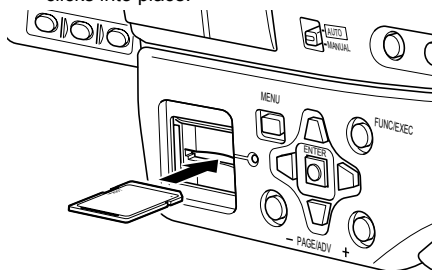

4 Close the SD Memory Card cover.

- Ensure that the cover firmly clicks into place.

- Do not perform any of the following operations while the SD Memory Card ACCESS lamp is flashing.

Performing these operations may damage the SD Memory Card or its contents, or cause the camera to fail to operate correctly.

- Opening the card door and removing the SD Memory Card
- Switching off the power
- Removing the battery
- Connecting or disconnecting the USB connection cable
- Shaking or striking the camera
- Always format SD Memory Cards that have been used in other devices when first using them with this camera. (Pages 28, 76 of Vol.2)
- If "CHECK CARD" is displayed on the viewfinder, please remove the SD Memory Card and insert it again.

SD Memory Card ACCESS lamp

This lamp lights or flashes during memory card access.

Lit: Card inserted, read/write possible

Flashing (fast): Recognizing

Flashing (slow): Accessing (during recording/playback/reading)

Off: Card not inserted, unformatted card inserted, write protected card inserted

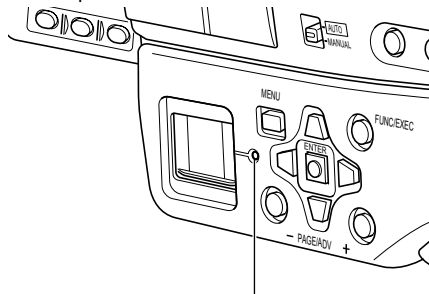

SD Memory Card access lamp

Shooting in auto mode

1 Select the recording mode (AVCHD mode or DV mode) with the **MODE** switch.

2 Turn the **POWER** switch to **ON**. (Page 30)

- Check that the mode lamp (CAMERA) is lighted red.

3 Switch the **AUTO/MANUAL** switch to **AUTO** to select auto mode.

- **A** appears in the upper area of the viewfinder.
- The focus, shutter speed, gain, iris, and white balance are adjusted automatically. In addition, if the AUTO SW item in the setting menu SW&DISP SETUP screen is set to FACE DETECT ON, focus is automatically aligned on faces detected in the image and brightness is adjusted for optimal results. **A** appears when FACE DETECT ON is set.
- Up to 15 face detection frames can be displayed on the screen at one time. Larger frames and frames closer to the center have priority.
- When FACE FRAMING is set to ALL and multiple subjects are detected, only the frame on which focus is aligned is displayed in orange. All other frames are displayed in gray.
- Primary (priority) frames
The primary frame is displayed in orange. Focus is automatically aligned to the primary frame, and the brightness is adjusted. When you press the REC CHECK/PHOTO SHOT button halfway in PHOTO mode, focus is aligned to the primary frame. When focus is aligned, the primary frame turns green.

4 Press the **START/STOP** button (Red) to start shooting.

- Press again to enter recording standby mode.
- Shooting is not possible when a menu screen is displayed. First, close the menu screen, and then press the START/STOP button.
- Shooting stops when the SD Memory Card cover is opened during shooting.

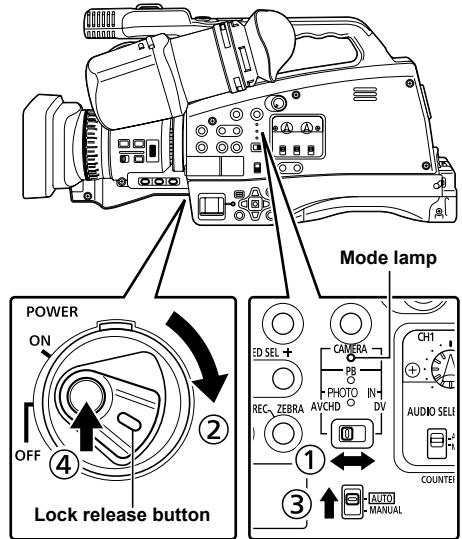

(Continued on the next page)

- The images shot from when shooting starts until it is stopped are recorded as one clip.
- When recording is paused after a short period, a small amount of time may be required after pressing the START/STOP button to stop recording before writing to the SD Memory Card is terminated.
This means that operations cannot be accepted if the START/STOP button is pressed immediately.
- The camera will read information from the SD Memory Card immediately after the card is inserted. Press the START/STOP button to begin recording after [] (pause: green) is displayed in the operation status display. (Page 92 of Vol.2)

AVCHD mode:

- The camera's factory default setting is PH mode 1080/60i recording.
(To view current setting status: Page 11 of Vol.2)
- The upper limit for the number of clips which can be recorded on a single SD Memory Card is 900. (However, this number may exceed 900 clips at times such as when shooting immediately after the POWER switch has been set to ON.)
- Mosaic-like noise may appear on the playback screen under the following shooting conditions:
 - When there are complex patterns in the background
 - When the camera is moved in large motions or when it is moved very quickly
 - When a fast-moving subject has been recorded (and especially when HE has been set as the recording mode)

DV mode:

- The camera's factory default setting is 480/60i recording.
 - The upper limit for the number of clips which can be recorded on a single SD Memory Card is 999.
-

Checking photos taken (REC CHECK)

Press the REC CHECK/PHOTO SHOT button (Page 20) while in recording standby mode. The last two seconds of video and audio will be played, and the camera returns to recording standby mode.

- Only the POWER and START/STOP buttons are operable during REC CHECK.
- The REC CHECK images are also recorded when a device is connected to the camera and backup images have been recorded.
- The REC CHECK function does not work when PB has been selected as the operation mode or when connected to a computer.
- This function also does not work after recording if the REC FORMAT has been changed, or if the camera has been set to CAMERA mode after having switched to another mode (PB, PHOTO, etc.).
- This function does not work if the SD Memory Card is removed and reinserted.

Using the zoom function

This camera has a 12 x optical zoom function. Use the zoom lever, handle zoom lever or assign zoom functions to the FOCUS ring to perform zoom operations.

Zoom lever

Press the T side of the zoom lever to zoom in, or the W side to zoom out.

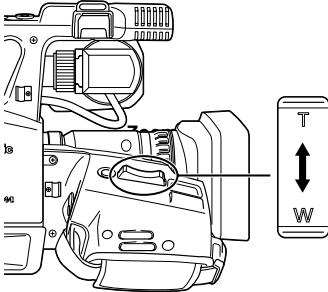

Handle zoom lever

Press the T side of the handle zoom lever to zoom in, or the W side to zoom out.

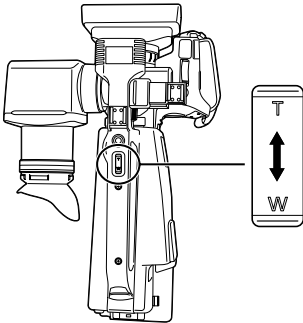

The handle zoom lever speed can be switched between 3 levels with the handle zoom switch.

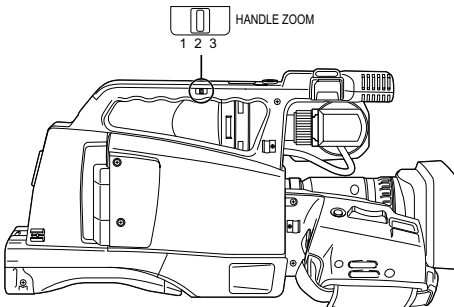

- With the HANDLE ZOOM item in the setting menu SW&DISP SETUP screen, you can reset the speed allocated to the handle zoom switch (Factory default settings are 1: low-speed (L); 2: medium-speed (M); and 3 high-speed (H)).

On the remote control

Press the ZOOM/VOL buttons to zoom.

- Zoom speed is fixed at medium.

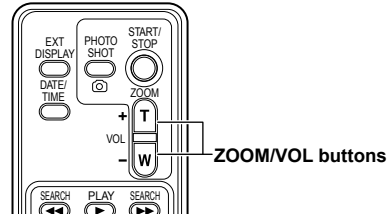

- To use the remote control, set the IR REMOTE item on the OTHER FUNCTIONS menu to ON. (Page 110 of Vol.2)

- When using a macro range and AF or MF on the focus control information display appears in reverse black and white, zooming may cause the image to become unfocused.

Digital zoom function

By setting D.ZOOM to any of the USER 1 - 3 buttons, you can use the camera's digital zoom function. (Page 107 of Vol.2)

With each press of the USER button to which D.ZOOM has been allocated, the digital zoom ratio will be switched between OFF (x 1)→(x 2)→(x 5)→(x 10)→OFF.

- The higher the zoom ratio setting, the poorer the image quality.
- For all settings other than OFF (x 1), the current zoom ratio will be displayed in the viewfinder.
- The digital zoom function can only be used with the following recording formats.
AVCHD mode : 1080/60i, 720/60P
DV mode: 480/60i
- The digital zoom function cannot be used in PHOTO mode.
- The digital zoom function cannot be used with interval recording.

Using the setup menus

Use the setup menus to change the settings to suit the scenes you are shooting or what you are recording.

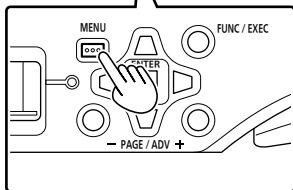
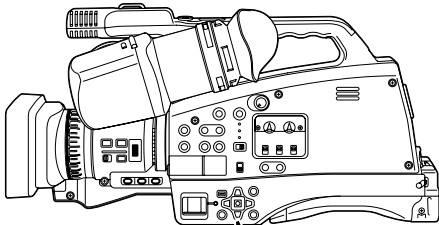

Using the menus

- The menu items indicated in the gray characters cannot be changed its settings.

1 When the unit is in other than playback or recording mode, press the MENU button.

The following is displayed on the viewfinder.

- Press and hold the MENU button when set to PB mode (thumbnail display) of DV mode.

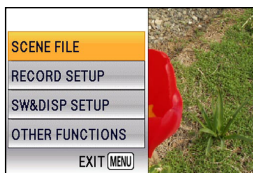

2 Select the function you want to set with the up or down button of the cursor button, and press the ENTER button.

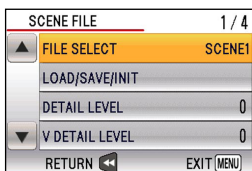

3 Select the item you want to set with the up or down button of the cursor button, and press the ENTER button.

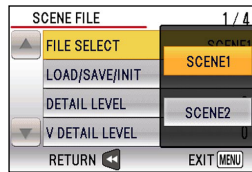

- To return to a previous screen, press the left button of the cursor button.

4 Select the up or down button on the cursor button to set numerical values, and press the ENTER button.

- To change numerical values, press the up, down, left or right button on the cursor button to change the values.
- To return to a previous screen, press the left button on the cursor button.

5 Repeat steps 3 – 4 to set any other items.

To complete settings, select EXIT and press the ENTER or the MENU button.

6 Repeat steps 2 – 4 to set any other functions.

To complete settings, select EXIT and press the ENTER or the MENU button.





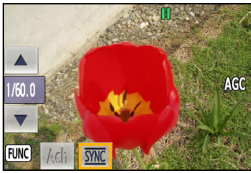

Using the Function Menu

The Function Menu is an expanded function of the setting menu that allows you to configure WHITE BALANCE, SYNCRO SCAN, SELF TIMER, I.EXPOSURE, and SKIN TONE DTL settings.

- 1 Press the FUNC/EXEC button while in CAMERA or PHOTO mode.**
The items that appear may vary depending on the mode and settings.
- 2 Select the left or right button of the cursor button, and press ENTER.**
- 3 To change numerical values, press the up or down button of the cursor button to select the values, and then press ENTER.**



You can set the following items in the Function Menu.

Icon	Item	Display mode	Page
 	WHITE BALANCE	It is not displayed when in AUTO mode.	Pages 7, 56 of Vol.2
	SYNCRO SCAN	It is not displayed when in AUTO mode.	Pages 17, 67 of Vol.2
	SELF TIMER	PHOTO	Page 105 of Vol.2
	I.EXPOSURE	It is not displayed when in AUTO mode.	Page 102 of Vol.2
	SKIN TONE DTL	It is not displayed when in AUTO mode.	Page 102 of Vol.2

- 4 Press the ENTER button when the item has been set.**

- 5 Press the FUNC/EXEC button to close the Function Menu.**

■ Operation in the thumbnail display screen (AVCHD mode only)

Each press of the FUNC/EXEC button moves the cursor in the thumbnail display screen of PB mode.

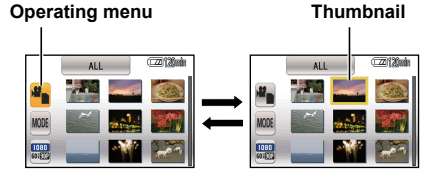

Cursor moves.

Initializing the menu settings

You can return the setting values for each item to their factory default settings with the MENU INIT item in the setting menu OTHER FUNCTION screen.

To initialize menu settings, set this item to YES, and then press the ENTER button.

Setting values for the following items are not initialized.

- Time code values
- User information values
- CLOCK SET and TIME ZONE
- OPERATION TIME

Setup menu structure

CAMERA mode menu

Video recording menu

- SCENE FILE
(Page 101 of Vol.2)
 - FILE SELECT
 - LOAD/SAVE/INIT
 - DETAIL LEVEL
 - V DETAIL LEVEL
 - DETAIL CORING
 - CHROMA LEVEL
 - CHROMA PHASE
 - COLOR TEMP
 - MASTER PED
 - A.IRIS LEVEL
 - DRS
 - GAMMA
 - KNEE
 - MATRIX
 - SKIN TONE DTL

RECORD SETUP (Page 103 of Vol.2)

- REC FORMAT
- ASPECT CONV
(DV mode only)
- PREREC MODE
- TIME STAMP
- INTERVAL REC
- TC MODE
- TCG
- TC PRESET
- UB MODE
(DV mode only)
- UB PRESET
- MIC GAIN1
- MIC GAIN2
- META CARD READ
(AVCHD mode only)
- META DATA REC
(AVCHD mode only)
- USER CLIP NAME
(AVCHD mode only)
- META DATA PROP
(AVCHD mode only)
- CLIP COUNTER SET
(AVCHD mode only)
- META INITIAL SET
(AVCHD mode only)

SW&DISP SETUP (Page 107 of Vol.2)

- HANDLE ZOOM
- IRIS DIAL
- USER1 SW
- USER2 SW
- USER3 SW
- FOCUS ASSIST SW
- RING SW
- AUTO SW
- SMOOTH ZOOM STOP
- CAM GAIN LIMIT
- FACE FRAMING
- ZEBRA DETECT
- MARKER
- SAFETY ZONE
- REC COUNTER
- VIDEO OUT OSD
- DATE/TIME
- DATE FORMAT
- LEVEL METER
- LENS STATUS
- CARD & BATTERY
- OTHER DISPLAY
- EVF BACKLIGHT
- EVF SET
- SELF SHOOT
- EVF COLOR

OTHER FUNCTIONS (Page 110 of Vol.2)

- CARD FORMAT
- IR REMOTE
- DV CONTROL
(DV mode only)
- DV CMD SEL
(DV mode only)
- REC LAMP
- BEEP SOUND
- CLOCK SET
- TIME ZONE
- POWER SAVE
- HDMI OUT SEL
(AVCHD mode only)
- CMPNT OUT SEL
(AVCHD mode only)
- DOWNCON MODE
(AVCHD mode only)
- TV ASPECT
- VIDEO SETUP
- AUDIO OUT
- MENU INIT
- LANGUAGE
- OPERATION TIME

- OPTION MENU
(DV mode only)*
(Page 113 of Vol.2)
 - 1394 STATUS
 - 1394 CONFIG

* Display it by pressing the MENU button while pressing down the DISP/MODE CHK button.

PHOTO mode menu

- Photo recording menu
 - CAMERA SETUP (Page 102 of Vol.2)
 - I.EXPOSURE
 - DETAIL LEVEL
 - CHROMA LEVEL
 - A.IRIS LEVEL
 - SKIN TONE DTL
 - PICTURE (Page 105 of Vol.2)
 - PICTURE SIZE
 - QUALITY
 - ASPECT RATIO
 - SELF TIMER
 - SHTR SOUND
 - SW&DISP SETUP (Page 107 of Vol.2)
 - HANDLE ZOOM
 - IRIS DIAL
 - USER1 SW
 - USER2 SW
 - USER3 SW
 - FOCUS ASSIST SW
 - RING SW
 - AUTO SW
 - SMOOTH ZOOM STOP
 - CAM GAIN LIMIT
 - FACE FRAMING
 - ZEBRA DETECT
 - MARKER
 - GUIDE LINES
 - HISTOGRAM
 - VIDEO OUT OSD
 - DATE/TIME
 - DATE FORMAT
 - LENS STATUS
 - CARD & BATTERY
 - OTHER DISPLAY
 - EVF BACKLIGHT
 - EVF SET
 - SELF SHOOT
 - EVF COLOR
 - OTHER FUNCTIONS (Page 110 of Vol.2)
 - CARD FORMAT
 - IR REMOTE
 - REC LAMP
 - BEEP SOUND
 - CLOCK SET
 - TIME ZONE
 - POWER SAVE
 - HDMI OUT SEL
 - CMPNT OUT SEL
 - TV ASPECT
 - MENU INIT
 - LANGUAGE
 - OPERATION TIME

DV IN mode menu

- DV IN menu
 - RECORD SETUP (Page 103 of Vol.2)
 - 1394 TC REGEN
 - TC MODE
 - TCG
 - TC PRESET
 - 1394 UB REGEN
 - UB MODE
 - UB PRESET
 - DV IN PRESET
 - PLAY SETUP (Page 106 of Vol.2)
 - REPEAT PLAY
 - RESUME PLAY
 - SW&DISP SETUP (Page 107 of Vol.2)
 - USER1 SW
 - USER2 SW
 - USER3 SW
 - REC COUNTER
 - VIDEO OUT OSD
 - DATE/TIME
 - DATE FORMAT
 - LEVEL METER
 - CARD & BATTERY
 - OTHER DISPLAY
 - EVF BACKLIGHT
 - EVF SET
 - EVF COLOR
 - OTHER FUNCTIONS (Page 110 of Vol.2)
 - CARD FORMAT
 - IR REMOTE
 - BEEP SOUND
 - CLOCK SET
 - TIME ZONE
 - POWER SAVE
 - TV ASPECT
 - VIDEO SETUP
 - AUDIO OUT
 - MENU INIT
 - LANGUAGE
 - OPERATION TIME
 - OPTION MENU (DV mode only)* (Page 113 of Vol.2)
 - 1394 STATUS
 - 1394 CONFIG

* Display it by pressing the MENU button while pressing down the DISP/MODE CHK button.

Setup menu structure (continued)

PB mode menu

Clip playback menu

- PLAY SETUP (Page 106 of Vol.2)
 - REPEAT PLAY
 - RESUME PLAY
- OPERATION (Page 106 of Vol.2)
 - CLIP PROTECT (AVCHD mode only)
 - DELETE (AVCHD mode only)
- SW&DISP SETUP (Page 107 of Vol.2)
 - USER1 SW
 - USER2 SW
 - USER3 SW
 - INDICATOR (AVCHD mode only)
 - VIDEO OUT OSD
 - DATE/TIME
 - DATE FORMAT
 - LEVEL METER
 - CARD & BATTERY
 - OTHER DISPLAY
 - EVF BACKLIGHT
 - EVF SET
 - EVF COLOR
- OTHER FUNCTIONS (Page 110 of Vol.2)
 - CARD FORMAT (AVCHD mode only)
 - CARD STATUS (AVCHD mode only)
 - IR REMOTE
 - BEEP SOUND
 - CLOCK SET
 - TIME ZONE
 - HDMI OUT SEL (AVCHD mode only)
 - CMPNT OUT SEL (AVCHD mode only)
 - DOWNCON MODE (AVCHD mode only)
 - TV ASPECT
 - VIDEO SETUP
 - AUDIO OUT
 - SYSTEM INFO (AVCHD mode only)
 - LANGUAGE
 - OPERATION TIME

Photo playback menu (AVCHD mode only)

- PICT. SETUP (Page 106 of Vol.2)
 - SCENE PROTECT
 - DPOF SET
 - DELETE
- SW&DISP SETUP (Page 107 of Vol.2)
 - USER1 SW
 - USER2 SW
 - USER3 SW
 - VIDEO OUT OSD
 - DATE/TIME
 - DATE FORMAT
 - CARD & BATTERY
 - OTHER DISPLAY
 - EVF BACKLIGHT
 - EVF SET
 - EVF COLOR
- OTHER FUNCTIONS (Page 110 of Vol.2)
 - CARD FORMAT
 - CARD STATUS
 - IR REMOTE
 - BEEP SOUND
 - CLOCK SET
 - TIME ZONE
 - HDMI OUT SEL
 - CMPNT OUT SEL
 - TV ASPECT
 - SYSTEM INFO
 - LANGUAGE
 - OPERATION TIME

Thumbnail menu (DV mode only)

DV thumbnail menu

- THUMBNAIL (Page 114 of Vol.2)
 - MODE
 - INDICATOR
- OPERATION (Page 114 of Vol.2)
 - DELETE
 - REPAIR CLIP
- OTHER FUNCTIONS (Page 114 of Vol.2)
 - CARD FORMAT
 - CARD STATUS
 - SYSTEM INFO

Specifications

[General]

Supply voltage: DC 7.2 V (when the battery is used) DC 7.3 V (when the AC adaptor is used) Power consumption: 11 W (recording)
--

 indicates safety information.

Ambient operating temperature

0 °C to 40 °C (32 °F to 104 °F)

Ambient operating humidity

10 % to 80 % (no condensation)

Weight

Approx. 3.2 kg (7.06 lb)
(excluding battery and accessories)

Dimensions (W x H x D)

267 mm x 233 mm x 458 mm
(10-1/2 inches x 9-3/16 inches x 18-5/16 inches)
(excluding the projection part)

[Camera]

Pickup devices

1/4.1-type MOS solid-state image sensor x 3

Total pixels

Approx. 3.05 megapixels x 3

Effective pixels (video)

Approx. 2.51 megapixels x 3 (16:9)

Effective pixels (still image)

Approx. 2.32 megapixels x 3 (4:3),
Approx. 2.65 megapixels x 3 (3:2),
Approx. 2.51 megapixels x 3 (16:9)

Lens

Optical image stabilizer lens,
Motorized 12 x zoom, F1.8 to 2.8
(f=4.0 mm to 48 mm)

35 mm equivalent (video):

40.8 mm to 490 mm (16:9)

35 mm equivalent (still image):

41.3 mm to 496 mm (3:2),
40.8 mm to 490 mm (16:9),
45.0 mm to 540 mm (4:3)

Color separation optical system

Prism system

Filter diameter

43 mm

ND filter

Automatic ON/OFF interlock with iris

Closest shooting distance

Approx. 0.9 m

Gain settings

Video recording: 0 dB to 24 dB (variable in 1 dB step, up to 34 dB when HIGH GAIN is assigned to a USER button)

Still image recording: 0 dB to 18 dB (variable in 1 dB step)

Shutter speed settings

CAMERA mode:

Preset

60i/60P mode:

1/60, 1/100, 1/120, 1/250, 1/500, 1/1000,
1/2000 seconds

30P mode:

1/30, 1/50, 1/60, 1/120, 1/250, 1/500,
1/1000, 1/2000 seconds

24P mode:

1/24, 1/50, 1/60, 1/120, 1/250, 1/500,
1/1000, 1/2000 seconds

Synchronous scan settings:

60i/60P mode: 1/60.0 seconds to
1/250.0 seconds

30P mode: 1/30.0 seconds to
1/250.0 seconds

24P mode: 1/24.0 seconds to 1/250.0 seconds

Slow shutter speed settings:

60i/60P mode: 1/2, 1/4, 1/8, 1/15,
1/30 seconds

30P mode: 1/2, 1/4, 1/8, 1/15 seconds

24P mode: 1/2, 1/3, 1/6, 1/12 seconds

PHOTO mode:

1/2, 1/4, 1/8, 1/15, 1/30, 1/60, 1/100, 1/120,
1/180, 1/250, 1/350, 1/500, 1/750, 1/1000,
1/1500, 1/2000 seconds

Minimum subject luminance

Approx. 1 lx (with slow shutter speed of 1/2, and 34 dB gain)

Digital zoom

2 x /5 x /10 x (Assigned to the USER button, for switching zoom levels)

Can only be used with 1080/60i, 720/60P, 480/60i

Lens hood

Large-sized lens hood with wide angle of view

[Recording/playback (video)]

AVCHD Mode:

Recording Format

AVCHD specifications

Compression method

MPEG-4 AVC/H.264

Recording media

SD Memory Card:

512 MB, 1 GB, 2 GB

(FAT12 and FAT16 format)

SDHC Memory Card:

4 GB, 6 GB, 8 GB, 12 GB, 16 GB, 32 GB

(FAT32 format)

* Class 4 or higher is required for recording in PH mode or HA mode.

SD/SDHC Memory Cards with a memory size from 8 MB to 32 GB can be used to record metadata.

Specifications (continued)

Recording format (Recording mode: resolution)

PH mode: 1080/60i, 1080/30P (over 60i),
1080/24P (Native recording),
720/60P, 720/30P (over 60P),
720/24P (Native recording)

HA mode: 1080/60i
HG mode: 1080/60i
HE mode: 1080/60i

Transmission rate

PH mode: Approx. 21 Mbps (VBR)
HA mode: Approx. 17 Mbps (VBR)
HG mode: Approx. 13 Mbps (VBR)
HE mode: Approx. 6 Mbps (VBR)

DV mode:

Recording Format

DV format compliant

File format

AVI Type2

Recording media

SD Memory Card:
512 MB, 1 GB, 2 GB
(FAT12 and FAT16 system compliant)

SDHC Memory Card:
4 GB, 8 GB, 16 GB, 32 GB
(FAT32 system compliant)

* Class 6 or higher is required.

Recording format

480/60i
480/30P (over 60i)
480/24P (over 60i)

[Recording/playback (still image)]

Compression method

JPEG (DCF/Exif 2.2-compliant),
DPOF-compatible

Recording media

SD Memory Card:
8 MB, 16 MB, 32 MB, 64 MB, 128 MB,
512 MB, 1 GB, 2 GB
(FAT12 and FAT16 format)

SDHC Memory Card:
4 GB, 6 GB, 8 GB, 12 GB, 16 GB, 32 GB
(FAT32 format)

Recording pixels

Aspect ratio [4:3]:
3520×2640 pixels, 3264×2448 pixels,
2560×1920 pixels, 640×480 pixels

Aspect ratio [3:2]:
3984×2656 pixels, 3264×2176 pixels,
2592×1728 pixels

Aspect ratio [16:9]:
4224×2376 pixels, 3328×1872 pixels,
2560×1440 pixels

[Video System]

AVCHD Mode:

Video signals

1080/60i, 720/60p

Video output

HDMI output

HDMI (Type A connector)×1
1080/60i, 720/60p, 480/60p
(Not compatible with VIERA Link)

Analog component output × 3 (BNC)

Y: 1.0 V [p-p], 75 Ω

P_B/P_R: 0.7 V [p-p], 75 Ω

Composite output × 1 (BNC)

1.0 V [p-p], 75 Ω

* Shares analog component terminal (Y terminal) (SW switching)

Analog component signals and composite signals cannot be output at the same time.

DV Mode:

Video signal

480/60i

Video output

Analog component output × 3 (BNC)

Y: 1.0 V [p-p], 75 Ω

P_B/P_R: 0.7 V [p-p], 75 Ω

Composite output × 1 (BNC)

1.0 V [p-p], 75 Ω

* Shares analog component terminal (Y terminal) (SW switching)

Analog component signals and composite signals cannot be output at the same time.

[Audio System]

AVCHD Mode:

Compression method

Recording/playback: Dolby Digital/2 ch

Sampling frequency

48 kHz

Encoding

16 bit

Compressed bit-rate

PH mode: 384 kbps

HA/HG/HE mode: 256 kbps

DV mode:

Compression method

Recording/playback: Linear PCM (Digital 2-ch)

Sampling frequency

48 kHz

Encoding

16 bit

[Audio IN/OUT]**XLR input**

XLR (3-pin) × 2 (CH1 and CH2)
 LINE/MIC selectable, High impedance
 LINE: 0 dBu
 MIC: -50 dBu/-60 dBu (selectable in menu)
 MIC + 48 V ON/OFF selectable

AUDIO output

Pin jack × 2 (CH1, CH2)
 Output: 316 mV, 600 Ω

Internal microphone

Stereo microphone

External microphone input

-70 dBV (Mic sensitivity: -50 dB equivalent,
 0 dB=1 V/Pa 1 kHz)
 Stereo mini jack (3.5 mm diameter)
 (Not compatible with plug-in power microphone)

HDMI (AVCHD mode only)

2 ch (Linear PCM), 5.1 ch (Dolby Digital)

PHONES (Headphone)

Stereo mini jack (3.5 diameter) × 1, 100 Ω
 -16 dBV (32 Ω load, during MONITOR VR MAX)

Internal speaker

20 mm (round) × 1

[Other inputs/outputs]**USB**

Card reader function
 (no copyright protection support)
 USB Type B connector
 USB 2.0-compliant, PictBridge-compatible

CAM REMOTE

Super mini jack (2.5 mm diameter) (ZOOM S/S)
 Mini jack (3.5 mm diameter) (FOCUS, IRIS)

DV (DV mode only)

6-pin (IEEE1394 format compliant), digital input/
 output

[Viewfinder]**LCD monitor**

69 mm (2.7 inch) wide-type LCD color monitor
 (approx. 230,000 pixels)

[AC adaptor]

Power Source:	110 V - 240 V AC, 50 Hz/60 Hz 22 W
Power Output:	7.3 V DC, 1.75 A (Camera-recorder) 8.4 V DC, 1.3 A (Charge)

 indicates safety information.

Weight

140 g (0.31 lb)

Dimensions (W x H x D)

103 mm × 36 mm × 62 mm
 (4-1/16 inches × 1-13/32 inches × 2-7/16 inches)

Weight and dimensions are approximate.
 Specifications are subject to change without notice.

Index

Number

1394 TC preset mode 73

A

AC adaptor **8, 24, 26**
Aperture 6, 55
Audio input 18, 68
Auto focus 5, 54
Auto mode **37**
Available recording time **24**
AVCHD **15**

B

Backlight compensation 12, 61
Battery **8, 24, 26**
Black balance 7, 56

C

Charging time **24**
Clip metadata 23
Clip
 Play back 40, 84
 Shooting 54
Color bar 12, 61
COMPONENT OUT terminal 52, 89
Cursor button **31**

D

Delete
 Clip 44, 81
 Photo 44
Digital zoom **39**
DPOF 46
Dubbing 90
DV **15**

F

Focus 31
Format 28, 76
Frame-playback 41, 84

G

Gain 6, 55

H

HDMI terminal 52

I

IEEE1394 **11, 73**

M

Manual focus 5, 54
Manual mode 5, 54
Maximum number of photos 33

N

Nonlinear editing 53

O

Optical Image Stabilizer 11, 60

P

Photo
 Playback 37, 42
 Shooting 31
PictBridge 47
Protect
 Clip 45
 Photo 45

R

Recording format 121
Recording mode **37**
Recording pixels 32
Remaining battery capacity displays **25**
Remote control **29**
Repair 30, 82
Repeat playback 49, 85
Resume play 49, 85

S

Screen display 91
SD Memory Card **12, 13, 14, 28, 76**
SD Memory Card ACCESS lamp **36**
SD speed class **14**
SDHC Memory Card **12, 13, 14**
Self-portrait shooting 10, 59
Setup menu **40**
 CAMERA SETUP screen 102
 OPERATION screen 106
 OPTION MENU screen 113
 OTHER FUNCTIONS screen 110
 PICT. SETUP screen 106
 PICTURE screen 105
 PLAY SETUP screen 106
 RECORD SETUP screen 103
 SCENE FILE screen 101
 SW&DISP SETUP screen 107
Setup menu structure **42**
Shot mark 13, 49, 62, 85
Shutter speed 15, 65
Slideshow 42
Synchro scan 17, 67

Bold and italicized page numbers (***00***) indicate pages in Volume 1, while the other page numbers (00) indicate pages in Volume 2.

T	
Tally lamp	30
Thumbnail	35, 79
THUMBNAIL menu	
OPERATION menu	114
OTHER FUNCTIONS menu	114
THUMBNAIL menu	114
Tripod receptacle	10
U	
USER button	12, 61
Using scene files	21, 71
V	
Video compatibility	41
VIDEO OUT terminal	52, 89
Viewfinder	32
W	
White balance	7, 56
Z	
Zoom	39

Information on Disposal in other Countries outside the European Union



This symbol is only valid in the European Union.

If you wish to discard this product, please contact your local authorities or dealer and ask for the correct method of disposal.



Panasonic Solutions Company

3 Panasonic Way, Secaucus, NJ 07094 Tel: 877-803-8492
www.panasonic.com/broadcast e-mail: MediaProServices.PSC@us.panasonic.com

Panasonic Canada Inc.

5770 Ambler Drive, Mississauga, Ontario L4W 2T3 Tel: 905-624-5010

Panasonic de México S.A. De C.V.

Casa Matriz: Moras No.313 Col. Tlacoquemecatl Del Valle Del.Benito Juárez México, D.F., C.P.03200
Tel: 55-5488-1000 Fax: 55-5575-6783

Panasonic Latin America, S.A.

P.O.Box 0816-03164 Panama, Republic of Panama Tel: +507-229-2955 Fax: 507-229-5352

Panasonic do Brasil Ltda.

Rua Cubatão, 320-6º andar-Paraíso CEP 04013-001- São Paulo -SP Tel: 11-3889-4000 Fax: 11-3889-4004

Free Manuals Download Website

<http://myh66.com>

<http://usermanuals.us>

<http://www.somanuals.com>

<http://www.4manuals.cc>

<http://www.manual-lib.com>

<http://www.404manual.com>

<http://www.luxmanual.com>

<http://aubethermostatmanual.com>

Golf course search by state

<http://golfingnear.com>

Email search by domain

<http://emailbydomain.com>

Auto manuals search

<http://auto.somanuals.com>

TV manuals search

<http://tv.somanuals.com>