

Panasonic®

Operating Instructions

Camera-Recorder

Model No. AG-DVC20P

Mini **DV** NTSC

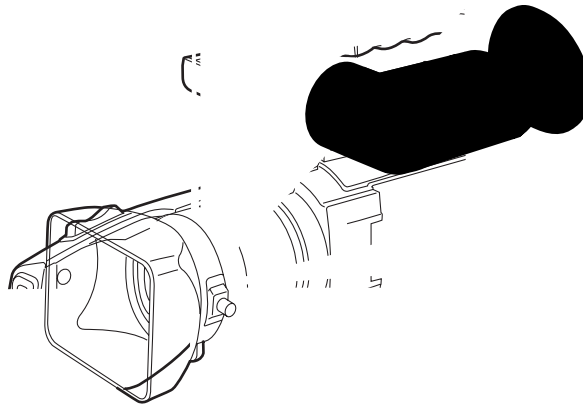

Before operating this product, please read the instructions carefully and save this manual for future use.

IMPORTANT

“Unauthorized recording of copyrighted television programmes, video tapes and other materials may infringe the rights of copyright holders and contravene copyright laws.”



CAUTION

RISK OF ELECTRIC SHOCK
DO NOT OPEN



CAUTION: TO REDUCE THE RISK OF ELECTRIC SHOCK, DO NOT REMOVE COVER (OR BACK). NO USER SERVICEABLE PARTS INSIDE. REFER TO SERVICING TO QUALIFIED SERVICE PERSONNEL.



The lightning flash with arrowhead symbol, within an equilateral triangle, is intended to alert the user to the presence of uninsulated “dangerous voltage” within the product’s enclosure that may be of sufficient magnitude to constitute a risk of electric shock to persons.



The exclamation point within an equilateral triangle is intended to alert the user to the presence of important operating and maintenance (service) instructions in the literature accompanying the appliance.

WARNING:

- TO REDUCE THE RISK OF FIRE OR SHOCK HAZARD, DO NOT EXPOSE THIS EQUIPMENT TO RAIN OR MOISTURE.
- TO REDUCE THE RISK OF FIRE OR SHOCK HAZARD, KEEP THIS EQUIPMENT AWAY FROM ALL LIQUIDS. USE AND STORE ONLY IN LOCATIONS WHICH ARE NOT EXPOSED TO THE RISK OF DRIPPING OR SPLASHING LIQUIDS, AND DO NOT PLACE ANY LIQUID CONTAINERS ON TOP OF THE EQUIPMENT.

CAUTION:

TO REDUCE THE RISK OF FIRE OR SHOCK HAZARD AND ANNOYING INTERFERENCE, USE THE RECOMMENDED ACCESSORIES ONLY.

CAUTION:

THE AC RECEPTACLE (MAINS SOCKET OUTLET) SHALL BE INSTALLED NEAR THE EQUIPMENT AND SHALL BE EASILY ACCESSIBLE. TO COMPLETELY DISCONNECT THIS EQUIPMENT FROM THE AC MAINS, DISCONNECT THE POWER CORD PLUG FROM THE AC RECEPTACLE.

CAUTION:

Danger of explosion or fire if battery is mistreated.

For Battery Pack

- Replace only with same or specified type.
- Do not disassemble or dispose of in fire.
- Do not store in temperatures over 60 °C (140 °F).
- Use specified charger.

For Battery of Remote Controller

- Replace battery with part No. CR2025 only.
- Do not recharge the battery.
- Do not disassemble or dispose of in fire.
- Do not store in temperatures over 60 °C (140 °F).

Camera-Recorder

The rating plate is on the underside of the Camera-Recorder

AC Adapter

The rating plate is on the underside of the AC Adapter. Disconnect the AC mains plug from the AC mains socket when not in use.

CAUTION:

In order to maintain adequate ventilation, do not install or place this unit in a bookcase, built-in cabinet or any other confined space.

To prevent risk of electric shock or fire hazard due to overheating, ensure that curtains and any other materials do not obstruct the ventilation.

CAUTION:

TO PREVENT ELECTRIC SHOCK, MATCH WIDE BLADE OF PLUG TO WIDE SLOT, FULLY INSERT.

 indicates safety information.

Caution regarding laser beams

The CCD may be damaged if it is subjected to light from a laser beam. When using the camera-recorder in locations where laser irradiation equipment is used, be careful not to allow the laser beam to shine directly on the lens.

Do not continuously record the same scene for a long time.

This camera is designed for making video movies.

If you continuously record the same scene for a long time, like a surveillance camera, the camera may suffer internal damage.

FCC NOTICE (USA)

Declaration of Conformity

Model Number: AG-DVC20P
Trade Name: PANASONIC
Responsible Party: Panasonic Corporation of North America One Panasonic Way, Secaucus, NJ07094
Support contact: Panasonic Broadcast & Television Systems Company 1-800-524-1448

This device complies with Part 15 of FCC Rules.

Operation is subject to the following two conditions:

(1) This device may not cause harmful interference, and (2) this device must accept any interference received, including interference that may cause undesired operation.

To assure continued compliance, follow the attached installation instructions and do not make any unauthorized modifications.

CAUTION:

This equipment has been tested and found to comply with the limits for a Class B digital device, pursuant to Part 15 of the FCC Rules. These limits are designed to provide reasonable protection against harmful interference in a residential installation. This equipment generates, uses and can radiate radio frequency energy and, if not installed and used in accordance with the instructions, may cause harmful interference to radio communications. However, there is no guarantee that interference will not occur in a particular installation. If this equipment does cause harmful interference to radio or television reception, which can be determined by turning the equipment off and on, the user is encouraged to try to correct the interference by one of the following measures:

- ▣ Reorient or relocate the receiving antenna.
- ▣ Increase the separation between the equipment and receiver.
- ▣ Connect the equipment into an outlet on a circuit different from that to which the receiver is connected.
- ▣ Consult the dealer or an experienced radio/TV technician for help.

The user may find the booklet "Something About Interference" available from FCC local regional offices helpful.

FCC Warning:

To assure continued FCC emission limit compliance, the user must use only shielded interface cables when connecting to host computer or peripheral devices. Also, any unauthorized changes or modifications to this equipment could void the user's authority to operate this device.

NOTIFICATION (Canada)

This class B digital apparatus complies with Canadian ICES-003.
Cet appareil numérique de la classe B est conforme à la norme NMB-003 du Canada.

 indicates safety information.



A lithium ion/polymer battery that is recyclable powers the product you have purchased.
Please call 1-800-8-BATTERY for information on how to recycle this battery.

Important Safeguards

1. **Read Instructions** — All the safety and operating instructions should be read before the unit is operated.
2. **Retain Instructions** — The safety and operating instructions should be retained for future reference.
3. **Heed Warnings** — All warnings on the unit and in the operating instructions should be adhered to.
4. **Follow Instructions** — All operating and maintenance instructions should be followed.
5. **Cleaning** — Unplug this video unit from the wall outlet before cleaning. Do not use liquid or aerosol cleaners. Use a dry cloth for cleaning.
6. **Attachments** — Do not use attachments not recommended by the video product manufacturer as they may be hazardous.
7. **Water and Moisture** — Do not use this video unit near water — for example near a bath tub, wash bowl, kitchen sink, or laundry tub, in a wet basement, or near a swimming pool, and the like.
8. **Accessories** — Do not place this video unit on an unstable cart, stand, tripod, bracket, or table. The video unit may fall, causing serious injury to a child or adult, and serious damage to the unit. Use only with a cart, stand, tripod, bracket, or table recommended by the manufacturer, or sold with the video unit. Any mounting of the unit should follow the manufacturer's instructions and should use a mounting accessory recommended by the manufacturer.

An appliance and cart combination should be moved with care. Quick stops, excessive force, and uneven surfaces may cause the appliance and cart combination to overturn.
9. **Ventilation** — Slots and openings in the cabinet are provided for ventilation and to ensure reliable operation of the video unit and to protect it from overheating. These openings must not be blocked or covered.

Never place the video unit on a bed, sofa, rug, or other similar surface, or near or over a radiator or heat register. This video unit should not be placed in a built-in installation such as a bookcase or rack unless proper ventilation is provided or the manufacturer's instructions have been adhered to.
10. **Power Sources** — This video unit should be operated only from the type of power source indicated on the marking label. If you are not sure of the type of power supply to your home, consult your appliance dealer or local power company. For video units intended to be operated from battery power, or other sources, refer to the operating instructions.
11. **Grounding or Polarization** — This video unit may be equipped with either a polarized 2-wire AC (Alternating Current) line plug (a plug having one blade wider than the other) or 3-wire grounding type plug, a plug having a third (grounding) pin.

The 2-wire polarized plug will fit into the power outlet only one way. This is a safety feature. If you are unable to insert the plug fully into the outlet, try reversing the plug. If the plug still fails to fit, contact your electrician to replace your obsolete outlet. Do not defeat the safety purpose of the polarized plug.

The 3-wire grounding type plug will fit into a grounding type power outlet. This is a safety feature. If you are unable to insert the plug into the outlet, contact your electrician to replace your obsolete outlet. Do not defeat the safety purpose of the grounding type plug.
12. **Power-Cord Protection** — Power-supply cords should be routed so that they are not likely to be walked on or pinched by items placed upon or against them, paying particular attention to cords of plugs, convenience receptacles, and the point where they exit from the unit.



Important Safeguards (continued)

13. Outdoor Antenna Grounding — If an outside antenna or cable system is connected to the video unit, be sure the antenna or cable system is grounded so as to provide some protection against voltage surges and buildup static charges. Part 1 of the Canadian Electrical Code, in USA Section 810 of the National Electrical Code, provides information with respect to proper grounding of the mast and supporting structure, grounding of the lead-in wire to an antenna discharge unit, size of grounding conductors, location of antenna discharge unit, connection to grounding electrodes, and requirements for the grounding electrode.

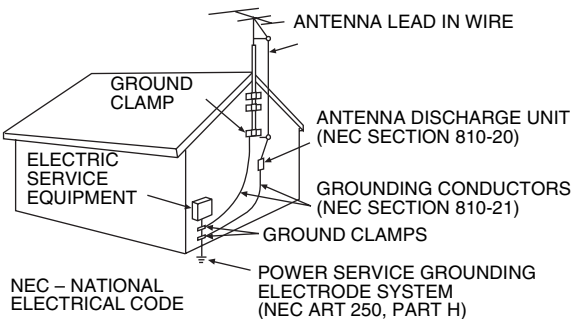

14. Lightning — For added protection of this video unit receiver during a lightning storm, or when it is left unattended and unused for long periods of time, unplug it from the wall outlet and disconnect the antenna or cable system. This will prevent damage to the video unit due to lightning and power-line surges.

15. Power Lines — An outside antenna system should not be located in the vicinity of overhead power lines or other electric light or power circuits, or where it can fall into such power lines or circuits. When installing an outside antenna system, extreme care should be taken to keep from touching such power lines or circuits as contact with them might be fatal.

16. Overloading — Do not overload wall outlets and extension cords as this can result in a risk of fire or electric shock.

17. Objects and Liquids — Never push objects of any kind into this video unit through openings as they may touch dangerous voltage points or short out parts that could result in a fire or electric shock. Never spill liquid of any kind onto the video unit.

18. Servicing — Do not attempt to service this video unit yourself as opening or removing covers may expose you to dangerous voltage or other hazards. Refer all servicing to qualified service personnel.

19. Damage Requiring Service — Unplug this video unit from the wall outlet and refer servicing to qualified service personnel under the following conditions:

- When the power-supply cord or plug is damaged.
- If any liquid has been spilled onto, or objects have fallen into the video unit.
- If the video unit has been exposed to rain or water.
- If the video unit does not operate normally by following the operating instructions. Adjust only those controls that are covered by the operating instructions, as an improper adjustment of other controls may result in damage and will often require extensive work by a qualified technician to restore the video unit to its normal operation.
- If the video unit has been dropped or the cabinet has been damaged.
- When the video unit exhibits a distinct change in performance – this indicates a need for service.

20. Replacement Parts — When replacement parts are required, be sure the service technician has used replacement parts specified by the manufacturer or have the same characteristics as the original part. Unauthorized substitutions may result in fire, electric shock or other hazards.

21. Safety Check — Upon completion of any service or repairs to this video unit, ask the service technician to perform safety checks to determine that the video unit is in safe operating order.

Contents

Important Safeguards	4
----------------------------	---

Before using

Standard Accessories.....	7
Optional Accessories.....	7
Parts identification and handling.....	7
Lens cap and grip belt	9
Attaching the shoulder strap.....	9
Using the LCD monitor	9
Using the viewfinder	10
Power supply	10
Charging time and recordable time.....	11
Inserting/removing a cassette.....	12
Turning the camera on.....	13
Selecting a mode.....	13
Using the screen display.....	13
Switching the language.....	14
Using the menu screen.....	14
Setting date and time.....	15
Adjusting LCD monitor/viewfinder.....	15
Using the remote control.....	16

Record mode

Check before recording	18
Recording on a tape	19
Check the recording.....	19
Blank search function	19
Zoom in/out function	20
Adjusting the Microphone Sensitivity Level	20
Recording yourself.....	21
Backlight compensation function	21
Night view functions.....	21
Soft skin mode.....	22
Tele-macro function.....	22
Fade in/fade out function	22
Wind noise reduction function.....	22
Recording images for wide-screen TVs.....	23
Image stabilizer function	23
Recording in various situations (Scene mode).....	23
Recording in natural colors (White balance).....	24
Manual focus adjustment.....	25
Manual shutter speed/aperture adjustment	25

Playback mode

Playing back tape	26
Slow-motion playback/frame-by-frame playback.....	26
Variable-speed search function	27
Playback on TV.....	27

Edit mode

Copying onto a DVD recorder or a VCR (Dubbing).....	28
Using the DV Cable for Recording (Digital Dubbing).....	29
Audio dubbing.....	30

Menu

Menu list	31
Menus related to taking pictures.....	32
Menus related to playback.....	32
Other menus	32

Others

Indications.....	33
Warning/alarm indications	33
Functions cannot be used simultaneously.....	34
Before requesting repair (Problems and solutions)	34
Cautions for Use	36
Explanation of terms.....	39

Specifications

Specifications.....	40
---------------------	----

■ Carefully read the Operating Instructions and use the Camera-Recorder correctly.

- Injury or material damage resulting from any kind of use that is not in accordance with the operating procedures explained in these Operating Instructions are the sole responsibility of the user.

Try out the Camera-Recorder.

Be sure to try out the Camera-Recorder before recording your first important event and check that it records properly and functions correctly.

The manufacturer is not liable for loss of recorded contents.

The manufacturer shall in no event be liable for the loss of recordings due to malfunction or defect of this Camera-Recorder, its accessories or cassettes.

Carefully observe copyright laws.

Recording of pre-recorded tapes or discs or other published or broadcast material for purposes other than your own private use may infringe copyright laws. Even for the purpose of private use, recording of certain material may be restricted.

- The Camera-Recorder uses copyright-protected technologies and is protected by the patented technologies and intellectual properties of Japan and the U.S. To use these copyright-protected technologies, authorization of the Macrovision Company is required. It is prohibited to disassemble or modify the Camera-Recorder.

- All other company and product names in the operating instructions are trademarks or registered trademarks of their respective corporations.

Pages for reference

Pages for reference are indicated by dashes either side of a number, for example: -00-

The menu operation flow is indicated by >> in the description.

Before using

Standard Accessories

The followings are the accessories supplied with this product.

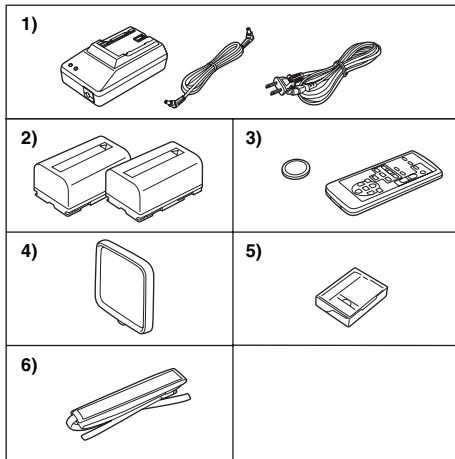

- 1) AC adapter, DC input lead, AC mains lead -10-
- 2) Battery pack -10-, -11-
- 3) Remote control, coin-type battery (CR2025) -16-
- 4) Lens cap -9-
- 5) Digital video head cleaner -36-
- 6) Shoulder strap -9-

Optional Accessories

- 1) AC adapter (AG-B15P)
- 2) Battery pack (lithium / CGR-D16A/1B / 1600mAh)
- 3) Wide conversion lens (AG-LW4307P)

Parts identification and handling

■ Camera

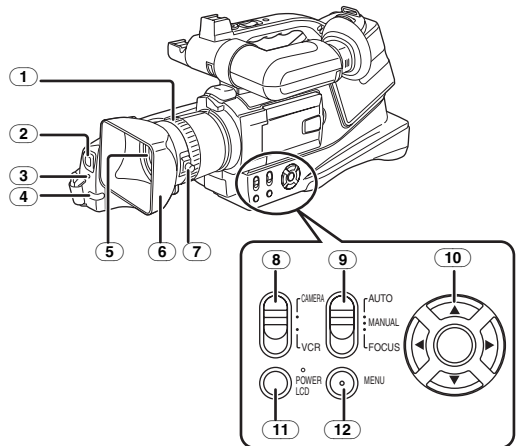

- 1) Focus ring -25-
- 2) White balance sensor -24-
- 3) Recording lamp -32-
- 4) Remote control sensor -16-
- 5) Lens
- 6) Lens hood
- 7) Lens hood attachment knob

- Do not attach other conversion lenses in front of the lens hood; there is no mount to be used for the attachment.
- When you wish to attach the wide conversion lens (AJ-LW4307P; optional), MC protector, or ND filter in the Filter Kit (optional), first of all, loosen the lens hood attachment knob 1. If the MC protector or ND filter is used, the lens hood can be mounted on the filter.
- When you attach the lens hood back, unite the marks and fasten the lens hood attachment knob 1.

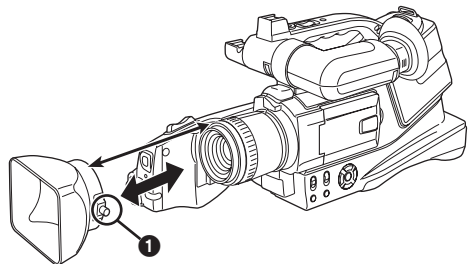

- If you push the [W/T] lever toward [W] during recording with the filter or conversion lens attached to the camera-recorder, 4 corners of the image may become dark (vignetting). For details, please refer to the operating instructions of your accessories.
- Be sure to keep the lens hood attached to the camera-recorder so as to shut out unnecessary light.

- 8) Mode switch [CAMERA/VCR] -13-, -19-, -26-
- 9) Mode selector switch [AUTO/MANUAL/FOCUS] -18-, -23-
- 10) Cursor buttons -13-, -14-
 - /[ENTER] button
 - ▲/Playback/Pause button [▶/||]
 - ◀/Rewind/Review button [◀◀]
 - ▼/Stop button [■]
 - ▶/Fast forward/cue button [▶▶]
- 11) Power LCD button [POWER LCD] -15-
Power LCD lamp
- 12) Menu button [MENU] -14-

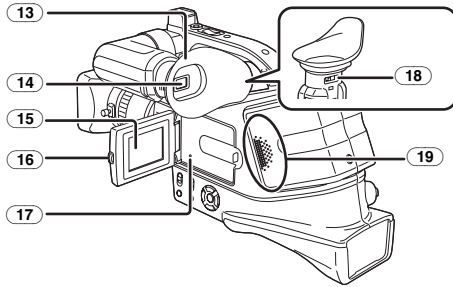

- 13 Eyecup -38-
- 14 Viewfinder -10-, -38-

Due to limitations in LCD production technology, there may be some tiny bright or dark spots on the Viewfinder screen. However, this is not a malfunction and does not affect the recorded picture.

- 15 LCD monitor -9-, -38-

Due to limitations in LCD production technology, there may be some tiny bright or dark spots on the LCD monitor screen. However, this is not a malfunction and does not affect the recorded picture.

- 16 LCD monitor open button [PUSH OPEN] -9-
- 17 Reset button -33-, -36-
- 18 Eyepiece corrector knob -10-
- 19 Speaker -26-

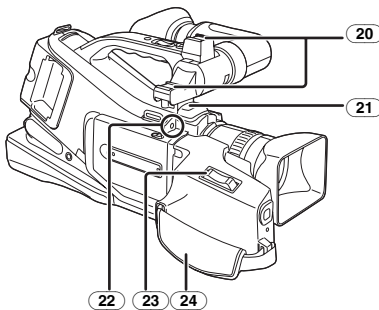

- 20 Smart accessory shoes
 - The External Stereo Microphone (optional), etc. can be attached here.
- 21 Microphone (built-in, stereo) -20-
- 22 External microphone socket [EXT MIC]
 - Connect with an external microphone or audio equipment. (When this socket is in use, the built-in microphone does not operate.)
- 23 Zoom lever [W/T] -20-, -26-
- 24 Grip belt -9-

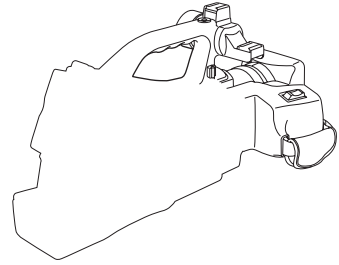

- 25 Shoulder strap holders -9-
- 26 Sub zoom lever [W/T] -20-, -26-
- 27 Sub recording start/stop button -19-
- 28 Battery eject button [PUSH] -11-
- 29 Battery holder -11-
- 30 Headphone socket [PHONES]
- 31 Cassette holder -12-
- 32 Cassette compartment cover -12-
- 33 Cassette eject lever [OPEN/EJECT] -12-

- 34 DC Input socket [DC IN] -10-
- 35 DV terminal [DV] -29-
 - Connect this to the digital video equipment.
- 36 S-Video output socket [S-VIDEO OUT] -27-, -28-
- 37 Video output socket [VIDEO OUT] -27-, -28-
- 38 Audio output sockets [AUDIO OUT] -27-, -28-
- 39 Power lamp -13-
- 40 Recording start/stop button -19-
- 41 Off/On switch [OFF/ON] -13-
- 42 Tripod receptacle

This is a hole for attaching the camera to optional tripod. (Please carefully read the operating instructions for how to attach the tripod to the camera.)

Lens cap and grip belt

■ Attach the lens cap

To protect the lens surface, attach the lens cap.

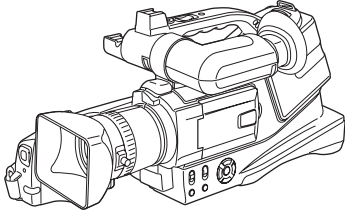

■ Adjust the grip belt

Adjust the length of the Grip Belt to the size of your hand.

1 Detach the tip of the grip belt.

2 Adjust the length.

3 Reattach the grip belt.

Attaching the shoulder strap

We recommend that you attach the shoulder strap before going out of doors to record so as to avoid dropping the camera-recorder.

1 Pull the end of the shoulder strap through the shoulder strap holder on the camera-recorder.

2 Fold the tip of the shoulder strap, run it through the shoulder strap length adjuster, and pull it.

- Pull it out more than 2 cm **1** from the shoulder strap length adjuster so that it cannot slip off.

Using the LCD monitor

You can record the image while viewing it on the LCD monitor opened.

1 Press the [PUSH OPEN] button and, at the same time, bring the LCD Monitor out about 90° in the direction of the arrow.

- The viewfinder will go off.

2 Adjust the angle of the LCD monitor as you prefer.

- It can rotate up to 180° **1** towards the lens or 90° **2** towards the viewfinder.

- The brightness and color level of the LCD monitor can be adjusted from the menu.
- If it is forcibly opened or rotated, the camera may be damaged or fail.
- When the LCD monitor is rotated by 180° towards the lens (when recording yourself), the LCD monitor and the viewfinder will be simultaneously activated.

Using the viewfinder

■ Using the viewfinder

- 1 Pull out the viewfinder and turn it upward/downward by pinching the viewfinder extension knob.

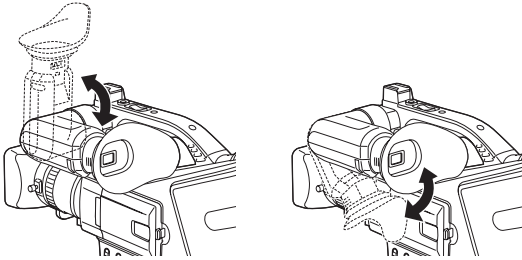

■ Adjusting the field of view

- 1 Adjust the focus by sliding the eyepiece corrector knob.

- You can adjust the brightness of the viewfinder from the menu.

Power supply

■ Charging the battery

When this product is purchased, the battery is not charged. Charge the battery before using this product.

- Battery charging time (-11-)
- We recommend using Panasonic batteries.
- If you use other batteries, we cannot guarantee the quality of this product.
- If the DC input lead is connected to the AC adapter, then the battery will not get charged. Remove the DC input lead from the AC adapter.

- 1 Connect the AC mains lead to the AC adapter and the AC mains socket.
- 2 Put the battery on the battery mount by aligning the mark, and then securely plug it in.

■ Charging lamp

Lights up: Charging

Goes off: Charging completed

Flashing: The battery is over discharged (discharged excessively). In a while, the lamp will light up and normal charging will start.

When the battery temperature is excessively high or low, the [CHARGE] lamp flashes and the charging time will be longer than normal.

■ Connecting to the AC outlet

- 1 Connect the AC mains lead to the AC adapter and the AC mains socket.
- 2 Connect the DC Input Lead to the [DC IN] Socket on the camera-recorder.
- 3 Connect the DC input lead to the AC adapter.
 - Do not use the power cord for other equipment since the power cord is exclusively designed for the camera-recorder. Or do not use the power cord of other equipment for the camera-recorder.

■ Fitting the battery

Push the battery against the battery holder and slide it until it clicks.

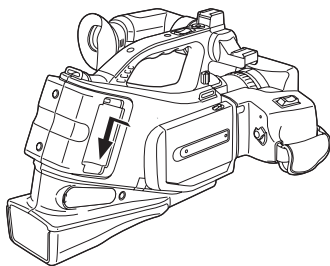

■ Removing the battery

While pushing the [PUSH] button, slide the battery to remove it.

- Hold the battery with your hand so it does not fall.

Charging time and recordable time

The times shown in the table below show the times at a temperature of 25 °C (77 °F) and a humidity of 60%. This is just a guide. If the temperature is higher or lower than the specified value, the charging time will become longer.

- Ⓐ Charging time
- Ⓑ Maximum continuously recordable time
- Ⓒ Intermittent recordable time

(The intermittent recordable time refers to recordable time when the recording and stopping operations are repeated.)
 “1h 30 min” indicates 1 hour 30 minutes.

- The times shown in the table are rough estimates. The times indicate the recordable times when the viewfinder is used. The times in parentheses indicate the recordable times when the LCD monitor is used.

- The recordable time will become shorter in the following cases:
 - When you use both the viewfinder and the LCD monitor simultaneously while rotating the LCD monitor frontward to record yourself, using the 0 lux night view function, etc.
 - When you use this camera with the LCD monitor lit up by pressing the [POWER LCD] button.
- The batteries heat up after use or charging. The main unit of the camera-recorder being used will also heat up. This is normal.
- Along with the reduction of the battery capacity, the display will change: → → → → . If the battery discharges, then () will flash.

Inserting/removing a cassette

- 1 Slide the [OPEN/EJECT] lever and open the cassette cover.**

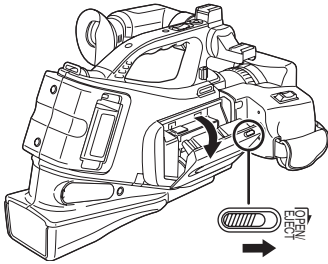

- When the cover is fully opened, the cassette holder will come out.

- 2 After the cassette holder is opened, insert/remove the cassette.**

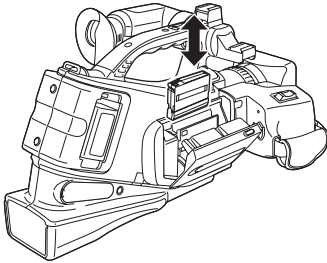

- When inserting a cassette, orient it as shown in the figure, and then securely insert it as far as it goes.
- When removing, pull it straight out.

- 3 Push the [PUSH] mark ① in order to close the cassette holder.**

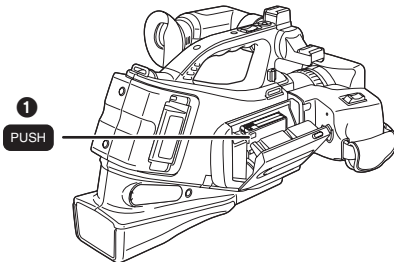

- 4 Only after the cassette holder is completely housed, close the cassette cover.**

- After using, make sure to rewind the cassette completely, remove it, and put it in a case. Store the case in an upright position. (-38-)
- When condensation is formed on the lens or the main unit of the camera-recorder, even if no condensation alarm is indicated, condensation may have formed on the heads or the cassette tape. Do not open the cassette cover. (-36-)

■ When the cassette holder does not come out

- Close the cassette cover completely, and then open it again completely.
- Check if the battery has run down.

■ When the cassette holder cannot be housed

- Set the [OFF/ON] switch to [OFF], then to [ON] again.
- Check if the battery has run down.

■ Inserting/removing the cassette

- When the cassette holder is in action, do not touch anything except the [PUSH] mark.
- When inserting a previously recorded cassette, use the blank search function to find the position where you want to continue recording. If you overwrite-record on a previously recorded cassette, be sure to find the position where you continue recording.
- Close the cassette cover tightly.
- When closing the cassette cover, do not get anything, such as a cable, caught in the cover.

■ Accidental erasure prevention

If the accidental erasure prevention slider ① of a cassette is opened (slide in the direction of the [SAVE] arrow), the cassette cannot be recorded. When recording, close the accidental erasure prevention slider of the cassette (slide in the direction of the [REC] arrow).

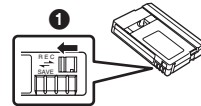

Turning the camera on

When the camera is turned on with the lens cap fitted, the automatic white balance adjustment may not function properly. Please turn the camera on after removing the lens cap.

How to turn on the power

1 Set the [OFF/ON] switch to [ON].

- The power lamp lights up.

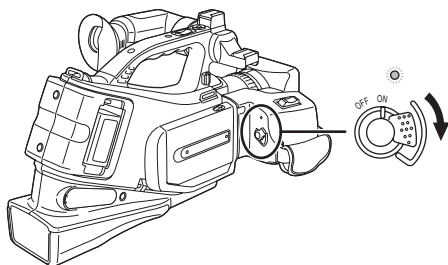

How to turn off the power

1 Set the [OFF/ON] switch to [OFF].

- The power lamp goes off.

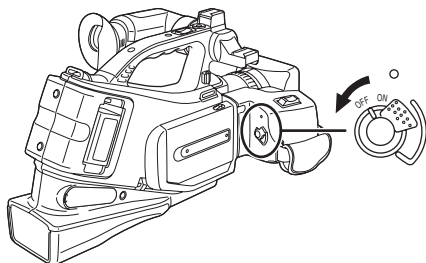

Selecting a mode

1 Set the mode switch to [CAMERA] or [VCR].

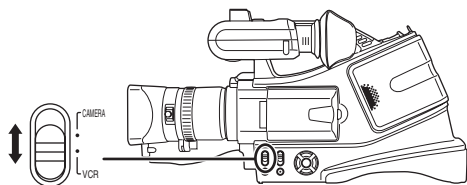

[CAMERA]: **Tape recording mode**
Use this when you record the image on a tape.

[VCR]: **Tape playback mode**
Use this to play back a tape.

Using the screen display

Press the [ENTER] button at the center of cursor buttons, and icons will be displayed on the screen. Each press switches the display as follows depending on the mode.

(In the Tape playback mode, the icons will be automatically displayed on the screen.)

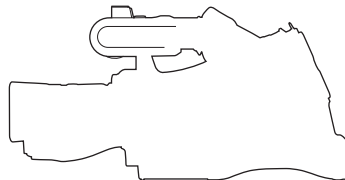

1) Tape recording mode ([AUTO/MANUAL/FOCUS] switch is set to [AUTO])

▲	Tele-macro	-22-
▼	Soft skin mode	-22-
◀	Fade	-22-
▶	Backlight compensation	-21-
▲	Night view/0 Lux night view	-21-
▼	Recording check	-19-

2) Tape recording mode ([AUTO/MANUAL/FOCUS] switch is set to [MANUAL])

▼	White balance Shutter speed Iris or gain value	-24-
▶	Select/Adjust	-24-
◀	Select/Adjust	-24-

3) Tape playback mode

▲	Playback/pause	-26-
▼	Stop	-26-
◀	Rewind (review playback)	-26-
▶	Fast forward (cue playback)	-26-

Switching the language

You can switch the language on the screen display or the menu screen.

1 Set [LANGUAGE] >> select the desired language.

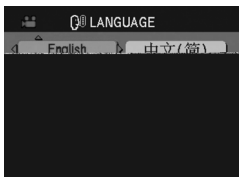

Using the menu screen

For each individual menu, please refer to -37-.

1 Press the [MENU] button.

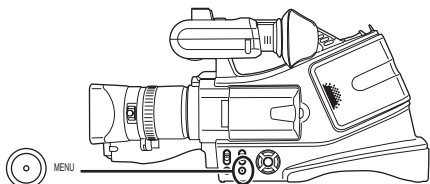

- The menu corresponding to the mode selected by the mode switch is displayed.
- Do not switch the mode switch when the menu is displayed.

2 Press the [▲] or [▼] button in order to select the top menu.

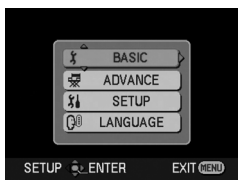

3 Press the [▶] or [ENTER] button to set the selection.



4 Press the [▲] or [▼] button to select the sub-menu.

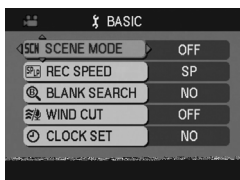

5 Press the [▶] or [ENTER] button to set the selection.



6 Press the [▲] or [▼] button in order to select the item to be set.

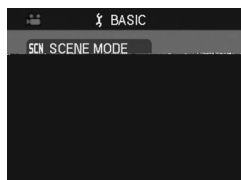

7 Press the [ENTER] button to determine the setting.



■ To exit the menu screen

Press the [MENU] button.

■ To get back to the previous screen

Press the [◀] button.



■ About the menu setting

- The menu screen does not appear during recording. And you cannot record when the menu screen appears.

■ Operating with remote control

The menu screen transition is the same as when the buttons on the main unit are used.

1 Press the [MENU] button.

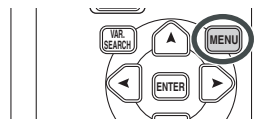

2 Select a menu item.

- Use the direction buttons (▲, ◀, ▶, ▼) and [ENTER] button in place of the cursor buttons on the main unit.

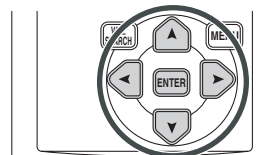

3 Press the [MENU] button to exit the menu screen.



Setting date and time

If the screen shows the incorrect date/time, then adjust it.

● Set to Tape Recording Mode.

1 Set [BASIC] >> [CLOCK SET] >> [YES].

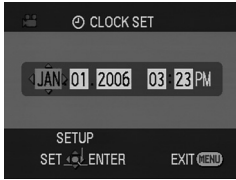

2 Press the [◀] or [▶] button in order to select the item to be set. Then press the [▲] or [▼] button to set the desired value.

- The year will change as follows:
2000, 2001, ..., 2089, 2000, ...
- The 24-hour clock is used.

3 Press the [ENTER] button to determine the setting.

- The clock function starts at [00] seconds.

■ About date/time

- The date and time function are driven by a built-in lithium battery.
- Make sure to check the time before recording because the built-in clock is not very accurate.

■ Recharging the built-in lithium battery

- If [☹] or [-] is indicated when the camera is turned on, then the built-in lithium battery runs down. Connect the AC adapter to the camera or place the battery on the camera, and the built-in lithium battery will be recharged. Leave the camera as is for approx. 24 hours, and the battery will drive the date and time for approx. 6 months. (Even if the [OFF/ON] switch is set to [OFF], the battery is still being recharged.)

Adjusting LCD monitor/viewfinder

■ Adjusting the brightness and color level

1 Set [SETUP] >> [LCD SET] or [EVF SET] >> [YES].



2 Press the [▲] or [▼] button in order to select the item to be adjusted.

[LCD SET]

☼: Brightness of the LCD monitor

⊗: Color level of the LCD monitor
[EVF SET]

EVF☼: Brightness of the viewfinder

3 Press the [◀] or [▶] button to move the bar indication representing the brightness.

4 Press the [MENU] or [ENTER] button to complete the settings.

- In order to adjust the brightness of the viewfinder, close the LCD monitor, and the viewfinder will be activated.
- When the LCD monitor is rotated by 180° towards the lens, the brightness of the LCD monitor cannot be adjusted.
- These settings will not affect the images actually recorded.

■ In order to increase the brightness of the entire LCD monitor

1 Press the [POWER LCD] button.

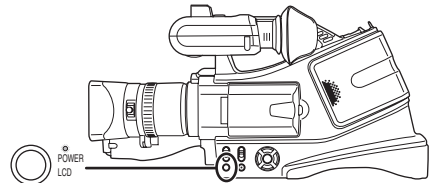

- The [POWER LCD] lamp lights up.
- If the [POWER LCD] button is pressed, the entire LCD monitor will become approx. twice as bright as the normal.

● Press this button again, and the lamp will go off and the brightness will revert back to the original brightness.

● This will not affect the images to be recorded.

● If you turn on the camera when the AC adapter is used, the [POWER LCD] function will not be activated.

Using the remote control

Remote control

Using the remote control supplied will enable controlling almost all the functions of this camera to be controlled.

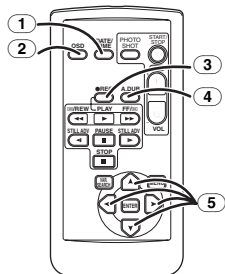

- ① Date/time button [DATE/TIME] -32-
- ② On-screen display button [OSD] -27-
- ③ Record button [REC] -29-
- ④ Audio dubbing button [A.DUB] -30-
- ⑤ Direction buttons [A, <, >, V] * -14-

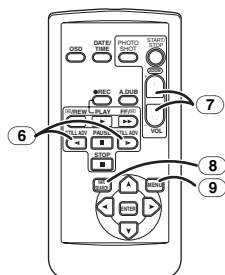

- ⑥ Slow/frame-by-frame forward button [<1, 1>] (<1: reverse, 1>: forward) -26-
- ⑦ Zoom/volume button [ZOOM/VOL] *
- ⑧ Search button [VAR. SEARCH] -27-
- ⑨ Menu button [MENU] * -14-

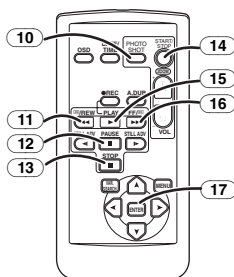

- ⑩ Photoshot button [PHOTO SHOT] (not operable)
- ⑪ Rewind/review button [◀◀]
- ⑫ Pause button [||]
- ⑬ Stop button [■]
- ⑭ Recording start/stop button [START/STOP] *
- ⑮ Playback button [▶]
- ⑯ Fast forward/cue button [▶▶]
- ⑰ Enter button [ENTER] * -13-, -14-

* means that these buttons function in the same manner as the corresponding buttons on the camera-recorder.

Install a coin-type battery

Install the coin-type battery supplied in the remote control before using it.

- 1 While pressing the stopper ①, pull out the battery holder.

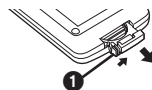

- 2 Set the coin-type battery (CR2025) with its (+) mark facing upward and get the battery holder back in place.

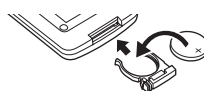

Warning

Keep the coin-type battery out of the reach of children. Never put Coin-Type battery in mouth. If swallowed call your doctor.

Remote control usable range

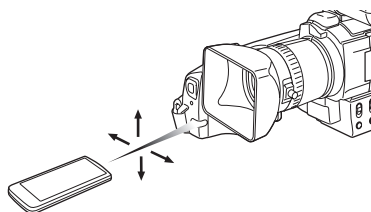

- The distance between the remote control and the camera:
Within approx. 5 m (15 feet)
Angle: Approx. 10° up and 15° down, left, and right

■ Selecting the remote control mode

If 2 cameras are used simultaneously, set the mode for one pair of camera-recorder and remote control to [VCR1] and that of the other pair to [VCR2]. This will prevent interference between the 2 pairs. (The default setting is [VCR1]. When the coin-type battery is replaced, the setting will revert to the default [VCR1].)

1 Setting on the camera:

Set [SETUP] >> [REMOTE] >> [VCR1] or [VCR2].

2 Setting on the remote control:

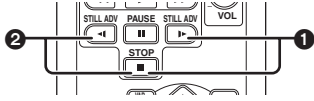

[VCR1]:

Press [▶] and [■] simultaneously. ①

[VCR2]:

Press [◀] and [■] simultaneously. ②

■ Concerning the coin-type battery

- When the coin-type battery runs down, replace it with a new battery (part number: CR2025). The battery is normally expected to last about 1 year, but it depends on operation frequency.
 - Keep the coin-type battery out of the reach of children.
-
- If the remote control mode of the camera and that of the remote control do not match with each other, "REMOTE" will appear. When the remote control is operated for the first time after the camera is turned on, "CHECK REMOTE MODE" (-33-) will appear and operation is impossible. Set the same remote control mode.
 - The remote control is intended for indoor operation. Outdoors or under strong light, the camera-recorder may not operate properly even within the usable ranges.
 - Within a 1 m (3 feet) range, you can operate the remote control from beside the remote control sensor (LCD monitor side) of the camera-recorder.

Record mode

Check before recording

Check the following by trying recording before important events such as weddings in order to verify that the image recording and audio recording work properly and that you know how to use the camera-recorder.

■ **Holding the camera-recorder for recording** Normal recording.

- When walking while recording, keep both eyes open so that you can see where you are going and what is happening around you.
- Place the camera-recorder on your right shoulder and hold it firmly with both hands.
- Hold the eyecup of the viewfinder as close as possible to your right eye.
- Take a firm stance with the legs slightly apart.
- For stable images, it is recommended to use a tripod (optional) whenever possible.

Low-angle recording.

Adjust the angle of the LCD monitor according to the position in which the camera-recorder is held.

- If the camera-recorder is not held firmly in stable position, the picture in the LCD monitor cannot be watched properly.
- For easier low-angle recording, the sub recording start/stop button and the sub zoom lever on the front of the camera-recorder can be used.

Recording from a high position.

For more stable pictures.

- Stabilize the camera-recorder by resting your elbows on a table or another stable horizontal surface.

■ **Check points**

- Remove the lens cap. (-9)
(When the camera is turned on with the lens cap fitted, the automatic white balance adjustment may not function properly. Please turn the camera on after removing the lens cap.)
- Grip belt adjustment (-9)
- Power supply (-10)
- Insert a cassette (-12)
- Setting date/time (-15)
- Adjustment of LCD monitor/viewfinder (15)

■ Recording mode

You can switch the tape recording mode.

●Set to Tape Recording/Playback Mode.

1 Set [BASIC] or [ADVANCE] >> [REC SPEED] >> [SP] or [LP].

If the LP mode is selected, the recording time will be 1.5 times the SP mode, but some functions will be disabled.

- We recommend using the SP mode for important recording.
- In order to fully exhibit the performances of the LP mode, we recommend using Panasonic cassettes marked LP mode.
- It is not possible to dub audio onto image recorded in the LP mode. (-30-)
- In the LP mode, the picture quality will not be degraded in comparison with the SP mode, but mosaic noise may appear on the playback image or some functions may be disabled.
 - Playback on other digital video equipment or on digital video equipment without the LP mode
 - Playback of the image on other digital video equipment recorded in the LP mode
 - Slow/frame-by-frame playback

Recording on a tape

Remove the lens cap. (-9-)

(When the camera-recorder is turned on with the lens cap fitted, the automatic white balance adjustment may not function properly. Please turn the camera on after removing the lens cap.)

●Set to Tape Recording Mode.

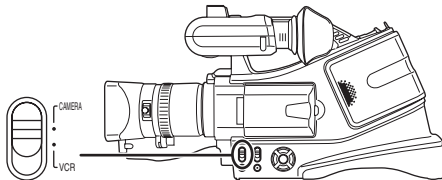

1 Press the recording start/stop button (or sub recording start/stop button) to start recording.

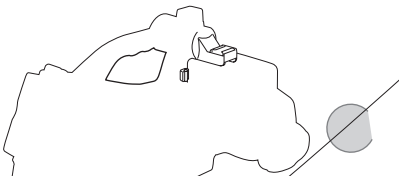

2 Press the recording start/stop button (or sub recording start/stop button) again to pause recording.

- For the recording time on a tape, refer to -11-.
- Carry out a recording check (-19-) to verify that the image is recorded properly.
- In order to find the unrecorded section, carry out the blank search (-19-).

■ On-screen display in the tape recording mode

- 1) Recording time elapse
- 2) Remaining tape indication



■ Concerning the remaining tape time indication on the screen

- The remaining tape time is indicated in minutes. (When it reaches less than 3 minutes, the indication starts flashing.)
- During a 15-second or shorter recording, the remaining tape time indication may not be displayed or the remaining tape time may not be displayed correctly.
- In some cases, the remaining tape time indication may display remaining tape time that is 2 to 3 minutes shorter than the actual remaining tape time.

Check the recording

The last image recorded is played back for 2 to 3 seconds. After checking, the camera-recorder will be set to a recording pause.

●Set to Tape Recording Mode.

- 1 Press the [ENTER] button during the recording pause until the icon  appears.
- 2 Press the [▼] button to select the recording check icon [].

Blank search function

Searches for the last part of the image recorded (unused part of the tape).

●Set to Tape Recording/Playback Mode.

- 1 Set [BASIC] or [ADVANCE] >> [BLANK SEARCH] >> [YES].

■ Stopping blank search midway through

Press the [▼] button to select the  icon.

- If the cassette tape has no blank part, then the camera-recorder will stop at the end of the tape.
- The camera-recorder stops at a point approx. 1 second before the end of the last image recorded. When you start recording at that point, the image can be recorded seamlessly from the last image.

Zoom in/out function

You can zoom in up to 10× optically.

● Set to Tape Recording Mode.

1 Wide-angle recording (zoom out):

Push the [W/T] lever (or sub zoom lever) towards [W].

Close-up recording (zoom in):

Push the [W/T] lever (or sub zoom lever) towards [T].

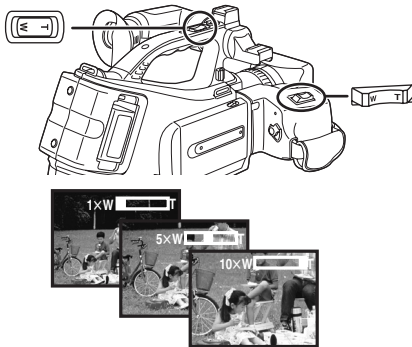

- When zooming in and taking a picture while holding the camera-recorder by hand, we recommend using the image stabilizer function.
- When you are zooming on a faraway subject, a sharper focus is achieved if the recording subject is 1.2 m (3.9 feet) or further from the camera-recorder.
- When the zoom speed is high, the subject may not be focused easily.
- When the zoom magnification is 1×, the camera-recorder can focus on a subject approx. 4 cm (1.6 inches) distant from the lens.

■ Digital zoom function

If the zoom magnification exceeds 10 times, then the digital zoom function will be activated. The digital zoom function allows you to select a magnification from 20× to 500×.

1 Set [ADVANCE] >> [D.ZOOM] >> [20×] or [500×].



[OFF]: Optical zoom only (Up to 10×)

[20×]: Up to 20×

[500×]: Up to 500×

- The larger the digital zoom magnification, the more the image quality is degraded.

■ To use the zoom microphone function

Interlocked with the zooming operation, the microphone will collect sounds clearly far away with the tele-shot or those in the vicinity with the wide-angle shot.

● Set to Tape Recording Mode.

1 Set [ADVANCE] >> [ZOOM MIC] >> [ON].



■ About the variable speed zoom function

- When pushing the [W/T] lever as far as it will go, you can zoom from 1× to 10× in 2.1 second at the maximum.
- The zoom speed varies according to the amount of movement of the [W/T] lever.
- The variable speed zoom function cannot be used with the remote control and sub zoom lever.

Adjusting the Microphone Sensitivity Level

You can adjust the microphone sensitivity for recording.

1 Set [ADVANCE] >> [MIC LEVEL] >> [AUTO], [SET+AGC] or [SET].

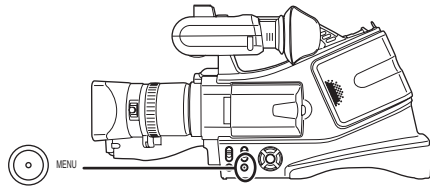

● AGC*: Auto Gain Control

[AUTO]: AGC is activated, and the recording level is adjusted automatically.

[SET+AGC]: The desired recording level can be set. AGC will also be activated to reduce the amount of distortion in the music.

[SET]: AGC is not activated and so natural recording can be performed. Adjust in such a way that the sound will not be distorted at the maximum volume level.

2 Press the [◀] or [▶] button to increase or decrease the bars of the gain value.

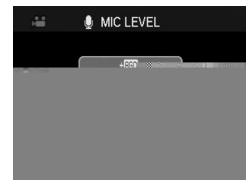

3 Press the [MENU] or [ENTER] button to complete the settings.

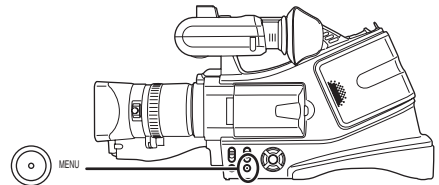

- Adjust the gain value so that the last 3 Bars of the [] will not light red. (Otherwise, the Sound is distorted.)
- The [MIC LEVEL] ([AUTO], [SET+AGC] or [SET]) setting on the [TAPE RECORDING MENU] and [TAPE PLAYBACK MENU] will be the same. (Microphone sensitivity level can be adjusted on each mode separately.)
- When [ZOOM MIC] is set to [ON], set the zoom to the [T] position before performing this adjustment.
- Select a lower setting for gain value or set [MIC LEVEL] to [AUTO].
- It is recommended that you check through the headphones before recording to ensure that the sound is not distorted.

Recording yourself

You can record yourself while viewing the LCD monitor. You can record persons in front of the camera while presenting them the image. The image is horizontally flipped as if you see a mirror image. (The image to be recorded is the same as that recording.)

1 Rotate the LCD monitor towards the lens side.

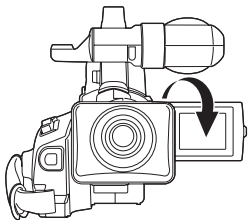

- When the LCD monitor is opened, the viewfinder will be automatically turned off. If the LCD monitor is rotated towards the lens side though, then the viewfinder will be activated.
- When the LCD monitor is rotated towards the lens side, the icon will not be displayed even if you press the [ENTER] button.

Backlight compensation function

This protects a backlit subject from being darkened.

• Set to Tape Recording Mode.

- 1 Press the [ENTER] button until the icon ❶ appears.
- 2 Press the [▶] button to select the backlight compensation icon [☀].



- The image on the screen will become brighter.

■ To return to normal recording

Select the [☀] icon again.

- If you operate the [OFF/ON] switch or the mode switch, the backlight compensation is cancelled.

Night view functions

This function allows you to record color subjects in dark locations to stand out against the background. Attach the camera-recorder to a tripod, and you can record images free from vibration.

- Only manual focusing can be used.
- Recorded scene is seen as if frames were missed.

Color night view function

You can record dark locations brightly in color.

0 Lux night view function

You can record completely dark locations with the light of the LCD monitor.

• Set to Tape Recording Mode.

- 1 Press the [ENTER] button until the icon ❶ appears.
- 2 Press the [▲] button to select the night view icon [★].



- Each upward press switches the modes.
OFF → Color night view function → 0 Lux night view function → OFF

3 (In the case of 0 lux night view function)

Rotate the LCD monitor towards the lens side.

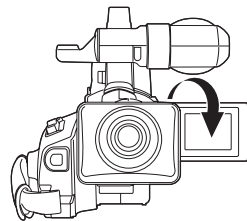

- When the LCD monitor is reversed, the Power LCD lamp turns on and the screen is lit in white.
- Record the subject while viewing it on the viewfinder.
- The light of the LCD monitor reaches approx. 1.2 m (3.9 feet) or less.

■ To cancel the color night view function

Select the night view icon until the night view indication disappears.

- If set in a bright place, the screen may become whitish for a while.
- The night view function makes the signal charging time of CCD up to approximately 30× longer than usual, so that dark scenes invisible to the naked eye can be recorded brightly. For this reason, bright dots that are usually invisible may be seen, but this is not a malfunction.
- The night view function is cancelled when you operate the power switch or the mode switch.

Soft skin mode

This allows the skin color to be recorded in a softer tone. This is more effective if you record the bust image of a person.

●Set to Tape Recording Mode.

- 1 Press the [ENTER] button until the icon  appears.
- 2 Press the [▼

Recording images for wide-screen TVs

This allows you to record images compatible with wide-screen TVs.

Cinema Function

Images are recorded with a black belt appearing along the top and bottom of the screen so that they look like theater movies.

●Set to Tape Recording Mode.

1 Set [ADVANCE] >> [CINEMA] >> [ON].



■ To cancel the Cinema function

Set [ADVANCE] >> [CINEMA] >> [OFF].

- Images played back vary depending on the TV connected. Please refer to the operating instructions for your TV.
- This function does not widen the recording range.
- When images are played back on a TV screen, the date/time indication may be erased in some cases.
- Depending on the TV, the picture quality may deteriorate.
- When a cinema picture is imported into a personal computer, the imported picture may not be displayed correctly, depending on the software in used.

Image stabilizer function

Reduces the image shaking due to hand movement when recording.

●Set to Tape Recording Mode.

1 Set [ADVANCE] >> [EIS] >> [ON].



■ To cancel the image stabilizer function

Set [ADVANCE] >> [EIS] >> [OFF].

- When a tripod is used, we recommend that you turn the image stabilizer function off.
- Under fluorescent lighting, image brightness may change or colors may not look natural.
- When the night view function is used, the image stabilizer function does not work. If so, the [EIS] indication flashes.
- In the following cases, the image stabilizer function may not work effectively.
 - When the digital zoom is used
 - When a conversion lens is used
 - When recording is done in an extremely dark place
 - When the camera-recorder is shaken greatly
 - When you record a moving subject while tracking it

Recording in various situations (Scene mode)

When you record images in different situations, this mode automatically sets optimum shutter speeds and apertures.

●Set to Tape Recording Mode.

1 Set the [AUTO/MANUAL/FOCUS] switch to [MANUAL].

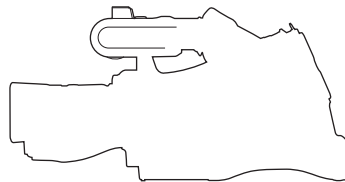

2 Set [BASIC] >> [SCENE MODE] >> select the desired mode.

- 1) [] Sports mode
 - To record sports scenes or scenes where there are quick motions
- 2) [] Portrait mode
 - To make persons stand out against the background
- 3) [] Low light mode
 - To record dark scenes so they are brighter
- 4) [] Spotlight mode
 - To record subjects spotlight in a party or theater
- 5) [] Surf & snow mode
 - To record images at dazzling places such as ski slopes and beaches

■ To cancel the scene mode function

Set [BASIC] >> [SCENE MODE] >> [OFF] or set the [AUTO/MANUAL/FOCUS] switch to [AUTO].

Sports mode

- For slow-motion playback or playback pause of recorded pictures, this mode presents free of camera shakes.
- During normal playback, the image movement may not look smooth.
- Avoid recording under fluorescent light, mercury light or sodium light because the color and brightness of the playback image may change.
- If you record a subject illuminated with strong light or a highly reflective subject, vertical lines of light may appear.
- If the brightness is insufficient, the sports mode does not function. The [] indication flashes.
- If this mode is used indoors, the screen may flicker.

Portrait mode

- If this mode is used indoors, the screen may flicker. If so, change the scene mode setting to [OFF].

Low light mode

- Extremely dark scenes may not be able to be recorded finely.

Spotlight mode

- If the recording subject is extremely bright, the recorded image may become whitish and the periphery of the recorded image extremely dark.

Surf & snow mode

- If the recording subject is extremely bright, the recorded image may become whitish.

Recording in natural colors (White balance)

The automatic white balance function may not reproduce natural colors depending on the scenes or lighting conditions. If so, you can adjust the white balance manually.

● Set to Tape Recording Mode.

1 Set the [AUTO/MANUAL/FOCUS] switch to [MANUAL].

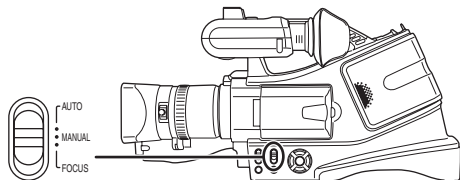

2 Press the [▼] button until the white balance indication appears. ([AWB] etc.)



3 Press the [◀] or [▶] button in order to select the white balance mode.

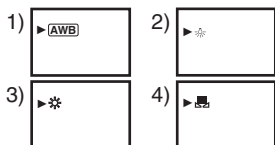

- 1) Auto white balance adjustment [AWB]
- 2) Indoor mode (for recording under incandescent lamps) [Incandescent]
- 3) Outdoor mode [Outdoor]
- 4) Manual adjustment mode [Manual]

■ To restore to the automatic adjustment

Press the [◀] or [▶] button until the [AWB] indication appears. Or, set the [AUTO/MANUAL/FOCUS] switch to [AUTO].

- When the camera-recorder is turned on with the lens cap fitted, the automatic white balance adjustment may not function properly. Please turn the camera-recorder on after removing the lens cap.
- When setting both the white balance and the iris/gain, set the white balance first.
- Whenever recording conditions change, re-set the white balance for correct adjustment.

■ To set the white balance manually

Select [Manual] in Step 3. Then, while viewing a white subject on the entire screen, press the [▲] button to select the [Manual] indication.

■ About flashing of the [Manual] indication

When the manual adjustment mode is selected

- Flashing indicates that the white balance previously adjusted is stored. This setting is stored until the white balance is adjusted again.

When white balance cannot be set in the manual adjustment mode

- White balance may not be adjusted properly in the manual adjustment mode in dark places. If so, use the auto white balance mode.

During setting in the manual adjustment mode

- When the setting is completed, it will keep lit.

■ About the white balance sensor

The white balance sensor detects the type of light source during recording.

- Do not cover the white balance sensor during recording, or it may not function properly.

■ About the black balance adjustment

This is one of the 3CCD system functions that automatically adjusts the black when the white balance is set in the manual adjustment mode. When the black balance is adjusted, the screen will temporarily be black.

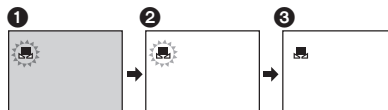

- 1) Black balance adjustment (Flashes.)
- 2) White balance adjustment (Flashes.)
- 3) Adjustment completed (Lights up.)

Manual focus adjustment

If auto focusing is difficult due to the conditions, then manual focusing is available.

● Set to Tape Recording Mode.

1 Set the [AUTO/MANUAL/FOCUS] switch to [MANUAL].

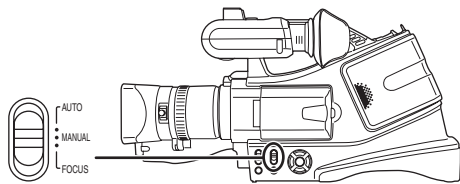

2 Set the [AUTO/MANUAL/FOCUS] switch to [FOCUS].

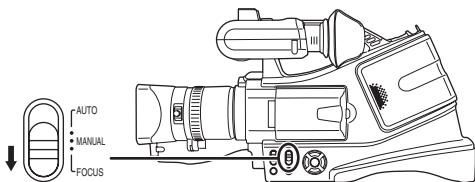

● The MNL and the manual focus indication [MF] will be displayed.

3 Rotate the focus ring to adjust the focus.

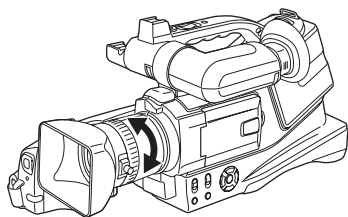

● When focused with a wide angle, the subject may not be in focus when zoomed in. First, zoom in on the subject, and then focus on it.

■ To restore to the automatic adjustment

Set the [AUTO/MANUAL/FOCUS] switch to [AUTO] or [FOCUS].

Manual shutter speed/aperture adjustment

Shutter Speed

Adjust it when recording fast-moving subjects.

Aperture

Adjust it when the screen is too bright or too dark.

● Set to Tape Recording Mode.

1 Set the [AUTO/MANUAL/FOCUS] switch to [MANUAL].

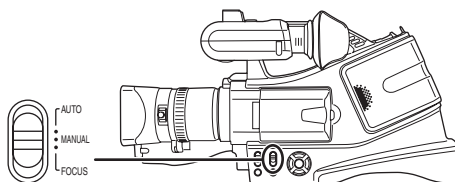

2 Press the [▼] button until the shutter speed indication or aperture value indication appears.

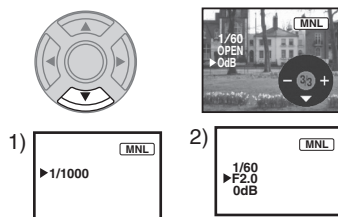

1) Shutter speed

2) (Aperture) Iris/gain value

3 Press the [◀] or [▶] button in order to adjust the shutter speed or aperture.

■ To restore to automatic adjustment

Set the [AUTO/MANUAL/FOCUS] switch to [AUTO].

Manual shutter speed adjustment

- Avoid recording under fluorescent light, mercury light or sodium light because the color and brightness of the playback image may change.
- If you increase the shutter speed manually, the sensitivity lowers and accordingly the gain value increases automatically, which may increase the noises on the screen.
- You may see vertical lines of light in the playback image of a brightly shining subject or highly reflective subject, but this is not a malfunction.
- During normal playback, image movement may not look smooth.
- When recording in the extremely bright place, the color of the screen may change or flicker. If this happens adjust the shutter speed manually to 1/60 or 1/100.

Manual iris/gain adjustment

- If the value does not become "OPEN", you cannot adjust the gain value.
- If the gain value is increased, the noise on the screen increases.
- Depending on the zoom magnification, there are iris values that are not displayed.

■ Shutter speed range

1/60 to 1/8000 seconds: Tape Recording Mode
The shutter speed closer to 1/8000 is faster.

■ Iris/gain value range

CLOSE (Closed), F16, ..., F2.0,
OPEN (Opened) 0dB, ..., 18dB
Value closer to [CLOSE] darken the image.
Value closer to [18dB] brighten the image.
Values with dB are gain values.

Playback mode

Playing back tape

- Set to Tape Playback Mode.

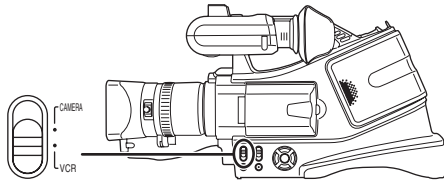

1 Operate with cursor buttons.



- ▶/||: Playback/Pause
- ◀◀: Rewind/Review playback
(Reverts to playback with the ▶/|| icon.)
- ▶▶: Fast forward/Cue playback
(Reverts to playback with the ▶/|| icon.)
- : Stop

- During cue/review playback, fast-moving images may show noise as a mosaic.
- Before and after cue/review playback, the screen may become blue for a moment or images may be disturbed.

■ To adjust volume

Adjust the speaker or headphone volume for playback.

- 1 Move the [W/T] lever (or sub zoom lever) to adjust the volume.

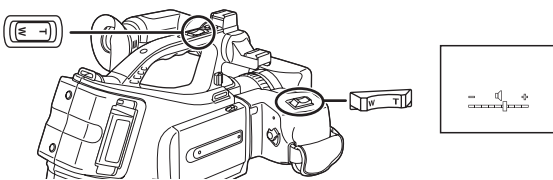

Towards [T]: increases the volume
Towards [W]: decreases the volume
(Nearer the bar to [+], larger the volume.)

- On the remote control, press the [T] button to increase the volume or the [W] button to decrease it.
- When the adjustment is completed, the volume indication will disappear.
- If you do not hear the sound, check the settings of [SETUP] >> [12bit AUDIO].

■ Repeat playback

When the tape end is reached, the tape will be rewound and played back again.

- 1 Set [ADVANCE] >> [REPEAT PLAY] >> [ON].

- The [REPEAT] indication appears. (In order to cancel the repeat playback mode, set [REPEAT PLAY] >> [OFF] or set [OFF/ON] switch to [OFF].)

■ Settings on the audio

- If you cannot listen to the desired audio when playing back a tape, check the settings in [SETUP] >> [12bit AUDIO].
- When you record or dub the audio in [12bit] and set [SETUP] >> [12bit AUDIO] >> [MIX], the audio will be played back in stereo sound regardless of the settings in [AUDIO OUT].

Slow-motion playback/frame-by-frame playback

- Set to Tape Playback Mode. (Slow-motion playback can only be performed by using the remote control.)

Slow-motion playback

If the image is recorded in the SP mode, then it will be played back at a speed approx. 1/5 the normal speed.

If the image is recorded in the LP mode, then it will be played back at a speed approx. 1/3 the normal speed.

- 1 During playback, press the [◀] button or the [▶] button on the remote control.

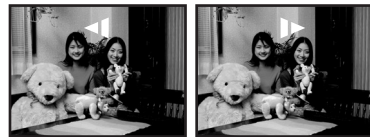
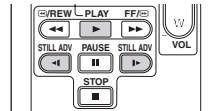

- If the slow-motion playback continues for approx. 10 minutes or more, then the playback will automatically stop. (10 minutes of slow-motion playback is equivalent to approx. 2 minutes in the SP mode or approx. 3 minutes in the LP mode.)

Frame-by-frame playback

- 1 During playback, press the [||] button on the remote control.
- 2 Press the [◀] button or the [▶] button on the remote control.

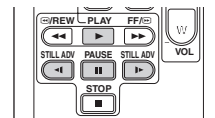

- Pushing the [W/T] lever (or sub zoom lever) towards [T] (normal direction) or towards [W] (reversed direction) of this camera-recorder during playback pause also turns into the frame-by-frame playback. If you keep pushing the lever, then the images will continuously be played back frame by frame.

■ To return to normal playback

Press the [▶] button on the remote control.

Slow-motion playback

- In the reversed slow-motion playback, the time code indication may be unstable.

Frame-by-frame playback

- Press and hold the [◀] or the [▶] button in the playback pause, and then the images will continuously be played back frame by frame.

Variable-speed search function

The speed of cue/review playback can be varied.
(This operation is only available when using the remote control.)

- Set to Tape Playback Mode and play back a tape.
- 1 Press the [VAR. SEARCH] button on the remote control.



- 2 Press the [▲] or [▼] button to vary the speed.

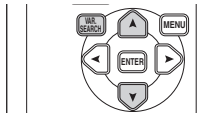

- The speeds for cue/review playback are 1/5× (SP mode slow-motion playback only), 1/3× (LP mode slow-motion playback only), 2×, 5×, 10×, 20×.

■ To return to normal playback

Press the [VAR. SEARCH] button or [▶] button on the remote control.

- Images may be shown in a mosaic-like pattern.
- The sound is muted during search.
- This function is cancelled when the operation icon is displayed.

Playback on TV

Images recorded by this camera-recorder can be played back on a TV.

- Insert a recorded tape into this camera-recorder.

- 1 Connect the camera-recorder and a TV.

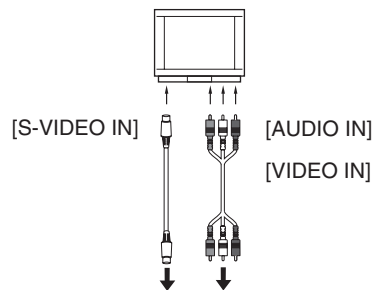

- Connect the camera-recorder and a TV by using the optional AV cable ①.
- If the TV has an S-Video terminal, then also connect an optional S-Video cable ②. It allows you to enjoy more beautiful images.

- 2 Turn on this camera-recorder and set the mode switch to the Tape Playback Mode.

- 3 Select the input channel on the TV.

- 4 Press the [▲] button to select the [▶/||] icon to start playback.

- The image and audio are output on the TV.

- 5 Press the [▼] button to select the [■] icon to stop playback.

- Whenever plugging in the S-Video cable, plug in the AV cable, too.
- Use the AC adapter to free you from worrying about the battery running down.

■ If the image or audio from this camera-recorder is not output on the TV

- Check that the plugs are inserted as far as they go.
- Check the connected terminal.
- Check the TV's input setting (input switch). (For more information, please read the operating instructions for the TV.)

■ To display the on-screen information on the TV

The information displayed on the LCD monitor or the viewfinder (operation icon, time code and mode indication, etc.), date and time can be displayed on the TV.

- 1 Press the [OSD] button on the remote control.

- Press the button again to erase the OSD information.

Edit mode

Copying onto a DVD recorder or a VCR (Dubbing)

Pictures recorded by the camera-recorder can be stored on a DVD-RAM or other such media. Refer to the instructions for the recorder.

- Place a recorded cassette in the camera-recorder, and an unrecorded DVD-RAM or cassette in the DVD recorder or VCR.

1 Connect the camera-recorder and the recorder.

Connecting with the AV cable

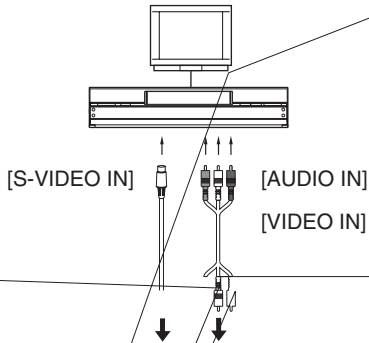

- Connect the camera-recorder and the recorder by using the AV cable ①.
- If the recorder has an S-Video terminal, then also connect an S-Video cable ②. It allows you to copy clearer image.

Connecting with the optional DV cable (Only for equipment with a DV terminal)

- 2 Turn on the camera-recorder and set to Tape Playback Mode.
- 3 Select the input channel on the TV set and recorder.
- 4 Press the [▲] button to select the [▶/||] icon to start playback.
 - The image and sound are reproduced.
- 5 Start recording. (Recorder)
- 6 Press the [▼] button to select the [■] icon to stop playback.
- 7 Stop recording. (Recorder)

- For more information, refer to the operating instructions for your TV set and recorder.
- When you do not need functional indications or date and time indications, press the [OSD] button on the remote control for no indication. (When you connect the camera-recorder and a recorder with the DV cable, these indications may not appear.)

■ When neither image nor sound from the camera-recorder is output to the TV set

- Check that the plugs are inserted as far as they go.
- Check the connected terminal.

Using the DV Cable for Recording (Digital Dubbing)

By connecting other digital video equipment with DV terminal and the camera-recorder by using the DV cable (optional) ①, high-image-quality dubbing can be done in digital format.

●Set to Tape Playback Mode. (Player/recorder)

1 Connect the camera-recorder and digital video equipment with the DV cable.

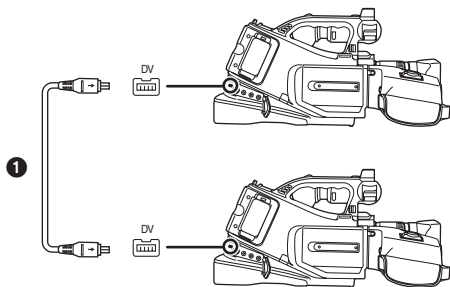

2 Set [ADVANCE] >> [REC STDBY] >> [YES]. (Recorder)

●You do not have to follow this step when the remote control is used in the digital dubbing.

3 Start playback. (Player)

4 Start recording. (Recorder)

Press the [▲] button to select [●/||] icon.



●Or, without operating step 2

While pressing the [●REC] button on the remote control, press the [▶] button.

5 Press the [▲] button to select the [●/||] icon again or press the [||] button on the remote control to stop recording. (Recorder)

6 Stop playback. (Player)

You can connect a digital video unit equipped with a DV connector and digitally transfer video and audio signals as well as time code.

- Before proceeding to connect or disconnect DV (IEEE1394) cable, be absolutely sure to turn off the power of the units.
- Before proceeding to connect the unit which uses a 6-pin type DV connector, carefully check the shape of the DV (IEEE1394) cable and the connectors on the DV (IEEE1394) cable. Connecting a connector upside down may damage the parts inside the unit and cause malfunctioning. Furthermore, connect the DV (IEEE1394) cable to the unit which uses a 6-pin type DV connector first.
- When recording signals from an external unit, first check that video signals are supplied.
- While signals from an external unit are being recorded, do not stop output on the external unit side or disconnect any of cables. This may lead to a failure to recognize the signals when you do recording again.
- Do not apply force when connecting DV (IEEE1394) cable to DV connector as this may damage the connector.

■ To cancel the standby for recording

When the camera-recorder is standby for recording, press the [▼] button and select the [■] icon.

- Do not plug or unplug the DV cable during dubbing, or the dubbing may not be completed properly.
- If a picture (bilingual video, etc.) containing main sound and sub sound has been dubbed, select the desired sound by [SETUP] >> [AUDIO OUT] on playback.
- Even if you use a device equipped with DV terminals such as IEEE1394, you may not be able to perform digital dubbing in some cases. For more information, see the instructions for equipment connected.
- Regardless of the menu settings on the recorder, digital dubbing is carried out in the same mode as the [AUDIO REC] mode of the playback tape.
- The images on the recorder monitor may be disturbed, but it does not affect the recorded images.
- If a picture containing a copyright protection signal (copy guard) is recorded by the camera-recorder, the picture is distorted by mosaic-like patterns at playback.
- When wide images are input, the display such as the menu screen or the operation icon is expanded horizontally.
- While pictures are input from the DV terminal, the operation icon blinks on instead of appearing from the side of the screen when you press the [ENTER] button.

Audio dubbing

You can add music or narration to the recorded cassette.

•Set to Tape Playback Mode.

- 1 Insert an external microphone securely into the [EXT MIC] terminal as far as it will go.

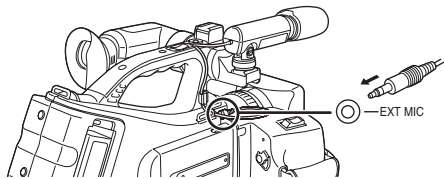

- 2 Find a scene that you want to add sound to, and press the [II] button on the remote control.

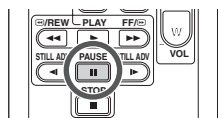

- 3 Press the [A.DUB] button on the remote control to make audio dubbing ready.

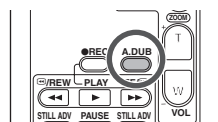

- 4 Press the [II] button on the remote control to start audio dubbing.



•Talk into the microphone.

- 5 Press the [II] button on the remote control to stop audio dubbing.

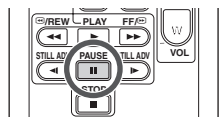

•If a tape has a non-recorded portion when the tape is dubbed, images and sounds may be disturbed when this portion of the tape is played back.

Recording with audio dubbing

Recording Mode.

To preserve the original sound taken during recording, set [SETUP] >> [AUDIO REC] >> [12bit] to take pictures when set [16bit], the sounds taken during recording will be replaced by the sounds taken after recording with audio dubbing.)

Set [REC SPEED] >> [SP] to take pictures.

Playback the sound recorded with audio

To switch between the sound recorded with audio dubbing and the original sound.

Set [12bit AUDIO] >> [ST2] or [MIX].

[ST2] plays back the original sound.

[MIX] plays back the sound added by audio dubbing.

[MIX] simultaneously plays back the original sound and the sound added with audio dubbing.

Menu

Menu list

Menu figures and illustrations are provided for easy-to-understand explanations, and so they are different from the actual menu indications.

■ [TAPE RECORDING MENU]



- 1) [BASIC]
 - [SCENE MODE] -23-
 - [REC SPEED] -19-
 - [BLANK SEARCH] -19-
 - [WIND CUT] -22-
 - [CLOCK SET] -15-

- 2) [ADVANCE]
 - [EIS] -23-
 - [CINEMA] -23-
 - [D.ZOOM] -20-
 - [ZOOM MIC] -20-
 - [MIC LEVEL] -20-
 - [DATE/TIME] -32-
 - [INITIAL SET] -32-

- 3) [SETUP]
 - [FADE COLOR] -22-
 - [AUDIO REC] -32-
 - [REC LAMP] -32-
 - [DISPLAY] -32-
 - [REMOTE] -17-
 - [BEEP SOUND] -32-
 - [LCD SET] -15-
 - [EVF SET] -15-
 - [POWER SAVE] -32-

- 4) [LANGUAGE] -14-

■ [TAPE PLAYBACK MENU]



- 1) [BASIC]
 - [DATE/TIME] -32-

- 2) [ADVANCE]
 - [BLANK SEARCH] -19-
 - [REC SPEED] -19-
 - [REC STDBY] -29-
 - [REC DATA] -32-
 - [REPEAT PLAY] -26-
 - [MIC LEVEL] -20-

- 3) [SETUP]
 - [12bit AUDIO] -30-
 - [AUDIO OUT] -32-
 - [DISPLAY] -32-
 - [REMOTE] -17-
 - [LCD SET] -15-
 - [EVF SET] -15-
 - [POWER SAVE] -32-

- 4) [LANGUAGE] -14-

Menus related to taking pictures

■ [DATE/TIME]

This switches between date and time indications.

- The camera-recorder automatically records the date and time of picture taking on the tape.
- You can also show or change the date/time indication by repeatedly pressing the [DATE/TIME] button on the remote control.

■ [AUDIO REC]

Switches the audio (PCM audio) recording systems.

[12bit]: Records audio in "12 bit 32 kHz 4 tracks".

(The original audio signals can be kept after the other audio signals are dubbed.)

[16bit]: Records audio in "16 bit 48 kHz 2 tracks". Audio can be recorded in higher quality.

(If audio signals are dubbed, then the original audio signals will be erased.)

■ [REC LAMP]

Set to [ON] and this turns the recording lamp on during recording, which indicates that recording is underway. Set to [OFF] and this does not turn on the lamp even when recording is underway.

■ [DISPLAY]

Set to [ON] and the display mode can be switched to all functions. Set to [OFF] and it can be switched to minimum display.

■ [BEEP SOUND]

Set to [ON] and confirmation/alarm beeps are issued as follows.

1 Beep

- When you start recording
- When you turn on the power

2 Beeps

- When you pause recording

2 Beeps for 4 times

- When a cassette with its erasure prevention tab set to [SAVE] is inserted, condensation occurs, and at other times. Check the sentence displayed on the screen.

■ [POWER SAVE]

[OFF]: When about 5 minutes passed without any operation, the standby mode automatically will be set. In the standby mode, [■■] blinks and it takes time more than usual to start recording after you press the recording start/stop button.

[5 MINUTES]: When about 5 minutes passes without any operation, the camera-recorder automatically turns off to protect the tape or to prevent the battery from running down. When you use the camera-recorder, turn it on again.

- In the following cases, the power may not turn off even when set [POWER SAVE] >> [5 MINUTES].
 - When connecting to the AC outlet (When using the AC adapter)
 - When connecting the DV cable to other equipment

Menus related to playback

■ [REC DATA]

Set to [ON] and the settings (shutter speed, iris/gain values, and white balance settings (-2+), etc.) used during the recordings are displayed during playback.

- When the [AUTO/MANUAL/FOCUS] switch is set to [AUTO], the indication [AUTO] will appear.
- When there is no data, [---] appears on the display.
- If the camera-recorder data of the camera-recorder are played back on other equipment, the settings information is sometimes not displayed normally.

■ [AUDIO OUT]

This switches the sound to be played back.

[STEREO]: Stereo sound (main sound and sub sound)

[L]: Left channel sound (main sound)

[R]: Right channel sound (sub sound)

Other menus

■ [INITIAL SET]

When there is a menu that cannot be selected depending on a combination of functions, set to [YES] for changing the menu settings back to the initial shipping condition.

(Language setting cannot be back to the initial shipping condition.)

Others

Indications

Various functions and the camera-recorder status are shown on the screen.

Basic indications

: Remaining battery power
0h00m00s00f: Time code
3:30:45PM: Date/Time indication

Recording indications

R0:45: Remaining tape time
● Remaining tape time is indicated in minutes. (When it reaches less than 3 minutes, the indication starts flashing.)
SP: Standard Play mode
(Recording speed mode) -19-

LP: Long Play mode
(Recording speed mode) -19-

●: Recording -19-

|| (Green): Recording pause -19-
Fade out (when the DV terminal is connected)

|| (Green flash): Standby mode

|| (Red): Fade out

: Recording check -19-

: Cinema mode -23-

: Digital zoom -20-

: Automatic mode -18-

: Manual mode -23-, -24-, -25-

MF: Manual focus -25-

5X: Zoom magnification indication -20-

: Backlight mode -21-

: Image stabilizer -23-

1/500: Shutter speed -25-

F2.4: F number -25-

6dB: Gain value -25-

: Soft skin mode -22-

: Tele macro -22-

: Fade (White) -22-

: Fade (Black) -22-

★: Color night view function -21-

0Lux ★: 0 Lux night view function -21-

ZOOM : Zoom microphone -20-

: Microphone sensitivity level -20-

: Wind noise reduction -22-

: Sports mode (Scene mode) -23-

: Portrait mode (Scene mode) -23-

: Low light mode (Scene mode) -23-

: Spotlight mode (Scene mode) -23-

: Surf & snow mode (Scene mode) -23-

: Auto white balance -24-

: Indoor mode (recording under incandescent lamp) -24-

: Outdoor mode -24-

: White balance adjustment mode -24-

: Blank search -19-

Playback indications

●: Recording underway

▶: Playback -26-

||: Pause -26-

▶▶: Fast-forward/Cue playback -26-

◀◀: Rewind/Review playback -26-

▶/◀: Slow motion playback -26-

||▶/◀||: Frame-by-frame playback -26-

2X▶▶: Variable-speed search -27-

↺▶▶: Repeat playback -26-

A.DUB ●: Audio dubbing -30-

A.DUB ||: Audio dubbing pause -30-

⊙: Blank search -19-

12bit, 16bit: Audio recording mode -32-

🔊: Volume adjustment -26-

Warning/alarm indications

If any one of the following indications lights up or flashes, please check the camera-recorder.

Confirmatory indications

: A cassette with the accidental erasure prevention slider placed in the [SAVE] position is inserted.
No cassette is inserted.

[--]/: The built-in battery is low. -15-

[!]: The warning/alarm indication appears when you record yourself. Turn the LCD monitor towards the viewfinder and check the warning/alarm indication.

REMOTE: An incorrect remote control mode has been selected. -17-

: The tape came to the end during recording.

: The video heads are dirty. -36-

Textual indications

/ : Condensation has occurred. Take out the cassette and wait for a while. It takes some time until the cassette holder opens, but this is not a malfunction. -36-

LOW BATTERY: The battery is low. Recharge it. -10-

NO TAPE: No tape is inserted. -12-

TAPE END: The tape came to the end during recording.

CHECK REC TAB: You are attempting to record pictures on a tape with the accidental erasure prevention slider placed in the [SAVE] position.

You are attempting audio dubbing or digital dubbing on a tape with the accidental erasure prevention slider placed in the [SAVE] position.

CHECK REMOTE MODE: An incorrect remote control mode has been selected. This is only displayed at the first operation of the remote control after powering-on. -17-

WRONG TAPE FORMAT: You are attempting to play back a tape section that has been recorded with a different TV system. This cassette is incompatible.

UNABLE TO A.DUB (LP RECORDED): Audio dubbing cannot be performed because the original recording was in LP mode.

UNABLE TO A.DUB: You are attempting to perform audio dubbing on a non-recorded tape.

COPY PROTECTED: Images cannot be recorded correctly because the medium is protected by a copy guard.

NEED HEAD CLEANING: The video heads are dirty. -36-

PUSH THE RESET SWITCH: An irregularity in the equipment has been detected. Press the reset button (-8-). This may solve the problem. You connect a device except for the DV format to the DV terminal. Pull out the DV cable, and press the reset button (-8-).

CHANGE TO MANUAL MODE: You are attempting to select the item on the [SCENE MODE] when the [AUTO/MANUAL/FOCUS] switch is set to [AUTO].

REVERSE THE LCD MONITOR: At the time of 0 Lux night view mode, when LCD monitor is not reversed, it displays. When the LCD monitor is rotated by 180° towards the lens, the brightness of the LCD monitor cannot be adjusted.

Functions cannot be used simultaneously

Some functions in the camera-recorder are disabled or cannot be selected due to its specifications. The table below shows examples of functions restricted by conditions.

Functions	Conditions which disable the functions
● Image stabilizer	● When the color night view function is used
● Backlight compensation	● When the iris/gain is set ● When the color night view function is used
● Soft skin ● Tele-macro ● Recording check ● Color Night View	● While recording to a tape
● Zoom microphone ● Wind noise reduction	● An external microphone is used
● Scene mode	● When setting the [AUTO/MANUAL/FOCUS] switch to [AUTO] ● When the color night view function is used
● Change of white balance	● When digital zoom (exceeds 10×) is used ● When the color night view function is used ● When a menu is displayed
● Adjusting the shutter speed, iris/gain	● When the color night view function is used ● When the scene mode is used
● Variable-speed search	● During repeat playback
● Audio dubbing	● The section of a tape recorded in LP mode ● The blank section of a tape ● Sounds sent through the DV terminal

Before requesting repair (Problems and solutions)

Power/Body

1: The camera-recorder power cannot be turned on.

- Is the battery fully charged? Use a fully charged battery.
- The battery protection circuit may have operated. Attach the battery to the AC adapter for 5 to 10 seconds. If the camera-recorder still cannot be used, the battery is faulty.

2: The camera-recorder power is turned off automatically.

- If you set [POWER SAVE] to [5 MINUTES] and do not operate the camera-recorder for about 5 continuous minutes, the power is automatically turned off for tape protection and power conservation. To resume recording, turn the [OFF/ON] switch to [OFF]. Then turn it to [ON] again. (-32-)

3: The camera-recorder power does not stay on long enough.

- Is the battery low? If the remaining battery power indication is flashing or the message "LOW BATTERY" is displayed, the battery has run down. Charge the battery or attach a fully charged battery. (-10-)
- Has condensation occurred? When you carry the camera-recorder from a cold place into a warm place, condensation may occur inside it. If so, the power is turned off automatically, disabling all operations except for taking cassettes out. Wait until the condensation indication disappears. (-36-)

4: Battery runs down quickly.

- Is the battery fully charged? Charge it with the AC adapter. (-10-)
- Are you using the battery in an extremely cold place? The battery is affected by ambient temperature. In cold places, the operating time of the battery becomes shorter.
- Has the battery worn out? The battery has a limited life. If the operating time is still too short even after the battery is fully charged, depending on the usage, the battery has worn out and can no longer be used.

5: The camera-recorder cannot be operated though powered up. The camera-recorder does not operate normally.

- Remove the cassette and then press the reset button. (-36-) If normal conditions are not restored yet, turn off the power. Then, about 1 minute later, turn on the power again.

6: The cassette cannot be removed.

- Does the power lamp comes on when opening the cassette cover? (-12-) Make sure that the battery and the AC adapter are properly connected. (-10-)
- Is the battery in use discharged? Charge the battery and remove the cassette.
- Close the cassette cover completely, and fully open it again. (-12-)

7: No operation other than cassette removal can be performed.

- Has condensation occurred? Wait until the condensation indication disappears. (-36-)

8: The remote control does not function.

- Has the coin-type battery of the remote control run out? Replace it with a new button-type battery. (-16-)
- Is the setting on the remote control correct? If the setting on the remote control is not in agreement with the [REMOTE] setting on the camera-recorder, the remote control does not operate. (-17-)

Recording**1: Recording does not start although power is supplied to the camera-recorder and the cassette is correctly inserted.**

- Is the accidental erasure prevention slider on the cassette open? If it is open (set to [SAVE]), recording cannot be performed. (-12-)
- Is the tape wound to the end? Insert a new cassette.
- Is the recording mode set? When in the playback mode, recording cannot be performed. (-19-)
- Has condensation occurred? No operation other than cassette removal can be performed when condensation occurs. Wait until the condensation indication disappears. (-36-)
- Is the cassette cover open? If the cover is open, the camera-recorder may not operate normally. Close the cassette cover. (-12-)

2: A cassette cannot be inserted.

- Has condensation occurred? Wait until the condensation indication disappears.

3: Auto focus function does not work.

- Is manual focus mode selected? If auto focus mode is selected, focus is automatically adjusted.
- There are some recording subjects and surroundings for which the auto focus does not operate correctly. (-39-) If so, use the manual focus mode to adjust the focus. (-25-)
- Is the color night view function set? When the color night view function is working, focusing shifts into the manual mode.

Indications**1: A sentence is displayed in red or yellow in the screen center.**

- Read the contents and respond to them. (-33-)

2: The time code becomes inaccurate.

- The time code indication counter may not be constant in the reversed slow-motion playback, but this is not a malfunction.

3: The remaining tape time indication disappears.

- The remaining tape time indication may disappear temporarily during frame-by-frame playback or other operation. If you continue ordinary recording or playback, the indication is restored.

4: The remaining tape time Indication does not match the actual remaining tape time.

- If scenes of less than 15 seconds are continuously recorded, the remaining tape time cannot be correctly displayed.
- In some cases, the remaining tape time indication may show remaining tape time that is 2 to 3 minutes shorter than the actual remaining tape time.

5: A function indication such as mode indication, remaining tape time indication, or time code indication is not shown.

- If you set [SETUP] >> [DISPLAY] >> [OFF], indications other than the tape running condition, warning, and date indications disappear.

Playback (Sound)**1: Sound is not played back from the built-in speaker of the camera-recorder or the headphones.**

- Is the volume too low? During playback, push the [W/T] lever to display the volume indication and adjust it. (-26-)

2: Different sounds are reproduced at the same time.

- Have you set [SETUP] >> [12bit AUDIO] >> [MIX]? If you set [AUDIO REC] >> [12bit] and dub audio to a recorded tape, you can hear the sound on recording and the sound dubbed at a later time. To hear the sounds separately, set to [ST1] or [ST2]. (-30-)
- Have you set [SETUP] >> [AUDIO OUT] >> [STEREO] and reproduced a picture containing the main sound and sub sound? Set to [L] to hear main sound, and set to [R] to hear the sub sound. (-32-)

3: Audio dubbing cannot be performed.

- Is the accidental erasure prevention slider on the cassette open? If it is open (set to [SAVE]), audio dubbing cannot be performed. (-12-)
- Are you attempting to edit a tape portion that was recorded in LP mode? LP mode does not allow audio dubbing. (-19-)

4: The original sound was erased when audio dubbing was performed.

- If you perform audio dubbing on a recording made in [16bit] mode, the original sound will be erased. If you wish to preserve the original sound, be sure to select [12bit] mode when recording.

5: Sounds cannot be played back.

- Although a cassette with no audio dubbing is being played, have you set [SETUP] >> [12bit AUDIO] >> [ST2]? To play back a cassette with no audio dubbing, set [12bit AUDIO] >> [ST1]. (-30-)
- Is the variable speed search function working? Press the [VAR. SEARCH] button on the remote control to cancel the variable speed search function. (-27-)

Playback (Pictures)**1: Mosaic-pattern noise appears on images during cue or review playback.**

- This phenomenon is characteristic of digital video systems. It is not a malfunction.

2: Horizontal stripes appear on images during cue and review playback.

- Horizontal stripes may appear depending on the scene, but this is not a malfunction.

3: Although the camera-recorder is correctly connected to a TV, playback images cannot be seen.

- Have you selected video input on the TV? Please read the operating instructions of your TV and select the channel that matches the input terminals used for the connection.

4: Playback picture is not clear.

- Are the heads of the camera-recorder dirty? If the heads are dirty, playback image cannot be clear. Clean the heads by using the head cleaner for digital video. (-36-)
- If the terminal for the AV cable is soiled, noises may appear on the screen. Wipe the soil off the terminal with a soft cloth, and then connect the cable to the AV terminal.
- Is a picture containing a copyright protection signal (copy guard) being recorded? When a protected picture is played back by the camera-recorder, mosaic-like patterns appear on the picture.

Others

1: The indication disappears, the screen is frozen, or no operation can be performed.

- Turn off the power to the camera-recorder. If the power cannot be turned off, press the [RESET] button, or detach the battery or AC adapter and then reattach it. After that, turn on the power again. If normal operation is still not restored, detach the power connected, and consult the dealer who you purchased the camera-recorder from.

2: "PUSH THE RESET SWITCH" is displayed.

- An irregularity in the camera-recorder has been automatically detected. Remove the cassette for data protection and then press the [RESET] button. The camera-recorder will be activated.

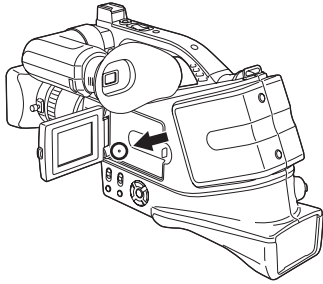

- If you do not press the [RESET] button, the power to the camera-recorder is turned off automatically about 1 minute later.
- Even after you press the [RESET] button, the indication may still appear repeatedly. If so, the camera-recorder needs repair. Detach the power connected, and consult the dealer who you purchased the camera-recorder from. Do not attempt to repair the appliance by yourself.

Cautions for Use

■ About condensation

If you turn the camera-recorder on when condensation occurs on the head or the tape, condensation Indication [] (yellow or red) is displayed on the viewfinder or the LCD monitor and the messages [] DEW DETECT or [] EJECT TAPE (only when the tape is inserted) appear. If so, follow the procedure below.

in yellow:

Dews are slightly adhering on the head or the tape.

in red:

Dews are adhering on the head or the tape.

1 Remove the tape if it is inserted.

- It takes about 20 seconds to open the cassette holder. This is not a malfunction.

2 Leave the camera-recorder with the cassette cover closed to cool or warm it to the ambient temperature.

When [] in yellow

- You cannot use the Tape Recording/Playback Mode. Leave the camera-recorder for about 30 minutes.

When [] in red

- The power lamp blinks for about 1 minute and then the camera-recorder automatically turns off. Leave it for about 2 to 3 hours.

3 Turn the camera-recorder on again, set it to the Tape Recording/Playback Mode and then check if the condensation indication disappears.

Especially in cold areas, moisture may be frozen. If so, it may take more time before the condensation indication disappears.

Watch for condensation even before the condensation Indication is displayed.

- The condensation indication may not appear depending on circumstances. When condensation occurs on the lens or the camera-recorder, it may also occur on the head and the tape. Do not open the cassette cover.

When the lens is fogged:

Set the [OFF/ON] switch to [OFF] and leave the camera-recorder in this condition for about 1 hour. When the lens temperature becomes close to the ambient temperature, the fogging disappears naturally.

■ About dirty heads

If video heads (the parts that closely contact with the tape) become dirty, normal recording and playback are not properly performed. Clean the heads with the digital video head cleaner.

- Insert the head cleaner into the camera-recorder, set it to the Tape Playback Mode, and play it back for about 10 seconds. (If you do not stop the playback, it automatically stops about 15 seconds later.)
- We recommend cleaning the heads periodically.

If the heads become dirty, "NEED HEAD CLEANING" appears during recording. During playback, moreover, the following symptoms appear.

- Mosaic-like noise appears partially or the sound is interrupted.
- Black or blue mosaic-like horizontal stripes appear.

Do not throw into a fire.

- Heating a battery that has caught into a fire may result in an explosion.
- If the operating time is short even after the battery has been recharged, the battery may be worn out. Please purchase a new battery.

■ About the AC adapter

- If the battery is warm, charging may take more time than normal.
- If the temperature of the battery is too high or extremely low, the [CHARGE] lamp will continue flashing, and the battery may not be charged. After the battery temperature has decreased or increased sufficiently, recharging starts automatically. So, wait for a while. If the lamp still continues flashing even after the recharging, the battery or AC adapter may be faulty. If so, please contact a dealer.
- If you use the AC adapter near a radio, radio reception may be disturbed. Keep the AC adapter 1 m (3 feet) or more away from radio.
- When using the AC adapter, it may generate whirring sounds. However, this is normal.
- After use, be sure to pull out the AC mains lead from the AC mains socket. (If they are left connected, a minute amount of current is consumed.)
- Always keep the electrodes of the AC adapter and battery clean.

■ About the cassette**Never place the cassette in a high temperature place.**

- The tape may be damaged, producing mosaic-like noise at the time of playback.

When storing the cassette after use, be sure to rewind the tape to the beginning and take it out.

- If the cassette is left for more than 6 months (depending on the storage condition) in the camera-recorder or stopped midway, the tape may sag and be damaged.
- Once every 6 months, wind the tape to the end and then rewind it to the beginning. If the cassette is left for 1 year or longer without winding or rewinding, the tape may be deformed by expansion or shrinkage attributable to temperature and humidity. The wound tape may stick to itself.
- Dust, direct sunlight (ultraviolet rays), and humidity may damage the tape. Such usage may cause damage to the camera-recorder and the heads.
- After use, be sure to rewind the tape to the beginning, put the cassette in the case to protect it from dust, and store it upright.

Keep the cassette away from strong magnetism.

- Apparatuses using magnets such as magnetic necklaces and toys have magnetic force that is stronger than expected, and they may erase the contents of a recording or may increase noise.

■ LCD monitor/viewfinder**LCD monitor**

- When the LCD monitor gets dirty, wipe it with a dry soft cloth.
- In a place with drastic temperature changes, condensation may form on the LCD monitor. Wipe it with soft dry cloth.
- If your camera-recorder is extremely cold, the LCD monitor is slightly darker than usual immediately after you turn the power on. However, as the internal temperature increases, it goes back to normal brightness.

Extremely high precision technology is employed to produce the LCD monitor screen featuring a total of approximately 113,000 pixels. The result is more than 99.99% effective pixels with a mere 0.01% of the pixels inactive or always lit. However, this is not a malfunction and does not affect the recorded picture.

Viewfinder

- To remove dust from inside the viewfinder, dismount the viewfinder first. When the dust is difficult to remove, get rid of it with a cotton swab dampened with water. Then wipe the viewfinder with a dry cotton swab.
- To clean the inside of the Viewfinder, remove the Eyecup ①, then keep pressing ② and pull the cover ③ out.

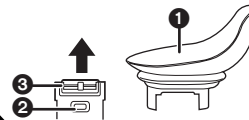

Extremely high precision technology is employed to produce the viewfinder screen featuring a total of approximately 113,000 pixels. The result is more than 99.99% effective pixels with a mere 0.01% of the pixels inactive or always lit. However, this is not a malfunction and does not affect the recorded picture.

The range of view shown in the viewfinder is slightly narrower than that shown in the video output socket.

■ Periodical check-ups

- To maintain the highest image quality, periodically replace worn parts such as heads and tape. The frequency of use. (This, however, depends on operation conditions including temperature, humidity and dust.)

Explanation of terms

Automatic white balance

White balance adjustment recognizes the color of light and adjusts so the white color will become a pure white. The camera-recorder determines the hue of light that comes through the lens and white balance sensor, thereby judging the recording condition, and selects the closest hue setting. This is called automatic white balance adjustment. However, since the camera-recorder only stores white color information under several light sources, automatic white balance adjustment does not function normally under the other light sources.

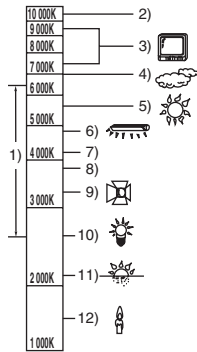

Outside of the effective range of automatic white balance adjustment, the image will become reddish or bluish. Even within the effective range of automatic white balance adjustment, the automatic white balance adjustment may not function properly if there is more than one light source. For light outside the functional auto white balance adjustment range, use the manual white balance adjustment mode.

- 1) The effective range of automatic white balance adjustment on this camera-recorder
- 2) Blue sky
- 3) TV screen
- 4) Cloudy sky (rain)
- 5) Sunlight
- 6) White fluorescent lamp
- 7) 2 hours after sunrise or before sunset
- 8) 1 hour after sunrise or before sunset
- 9) Halogen light bulb
- 10) Incandescent light bulb
- 11) Sunrise or sunset
- 12) Candlelight

White balance

The image recorded by the camera-recorder may become bluish or reddish under the influence of light sources. To avoid such phenomena, adjust the white balance.

White balance adjustment determines the white color under different light sources. By recognizing which is the white color under sunlight and which is the white color under a fluorescent lamp, the camera-recorder can adjust the balance among the other colors.

Since white color is the reference of all colors (light), the camera-recorder can record pictures in a natural hue if it can recognize the reference white color.

Auto focus

Auto focus automatically moves the focusing lens forward and backward inside the camera-recorder to bring the subject into focus.

Auto focus has the following characteristics

- Adjusts so that the vertical lines of a subject are seen more clearly.
- Attempts to bring an object with higher contrast into focus.
- Focuses on the screen center only.

Due to these characteristics, auto focus does not work correctly in the following situations. Record pictures in the manual focus mode.

Recording a subject with one end located closer to the camera-recorder and the other end farther away from it

- As auto focus adjusts at the center of an image, it may be impossible to focus on a subject that is located in both the foreground and background.

Recording a subject behind dirty or dusty glass

- The subject behind the glass will not be focused because the focus is on the dirty glass.

Recording a subject that is surrounded by objects with glossy surfaces or by highly reflective objects

- The recording subject may become blurry because the camera-recorder focuses on the objects with glossy surfaces or on highly reflective objects.

Recording a subject in dark surroundings

- The camera-recorder cannot focus correctly because the light information that comes through the lens decreases considerably.

Recording a fast-moving subject

- As the focus lens-inside moves mechanically, it cannot keep up with a fast-moving subject.

Recording a subject with little contrast

- A subject with little contrast, such as a white wall, may become blurry because the camera-recorder achieves focus based upon the vertical lines of an image.

Specifications

Specifications

Camera-Recorder

Recording format:

Mini DV (Consumer-use digital video SD format)

Tape used:

1/4-inch digital video tape

Recording/playback time:

SP: 60 min; LP: 90 min (with AY-DVM63)

Video**Recording system:**

Digital component

Television system:

EIA Standard: 525 lines, 60 fields NTSC color signal

Audio**Recording system:**

PCM digital recording

16 bit (48 kHz/2 ch), 12 bit (32 kHz/4 ch)

Image sensor:

1/6-inch 3CCD image sensor

(Effective pixels: moving picture/290 K×3, Total: 460 K×3)

Lens:

Auto Iris, F1.8 to F2.8, Focal length; 2.45 mm to 24.5 mm,

Macro (Full range AF)

Filter diameter:

43 mm

Zoom:

10:1 Power zoom

Monitor:

2.5-inch LCD

Viewfinder:

Color electronic viewfinder

Microphone:

Stereo (with a zoom function)

Speaker:

1 round speaker \varnothing 20 mm

Standard illumination:

1,400 lx

Minimum required illumination:

asonic[®]

CAST & TELEVISION SYSTEMS COMPANY
MASONIC CORPORATION OF NORTH AMERICA

us, NJ 07094 (201) 348-7000

07094 (201) 348-7196

36-3500



Free Manuals Download Website

<http://myh66.com>

<http://usermanuals.us>

<http://www.somanuals.com>

<http://www.4manuals.cc>

<http://www.manual-lib.com>

<http://www.404manual.com>

<http://www.luxmanual.com>

<http://aubethermostatmanual.com>

Golf course search by state

<http://golfingnear.com>

Email search by domain

<http://emailbydomain.com>

Auto manuals search

<http://auto.somanuals.com>

TV manuals search

<http://tv.somanuals.com>