

DIGITAL CAMERA

OLYMPUS[®]

SP-560UZ

Instruction Manual

Quick Start Guide

This manual will help you get started using your camera right away.

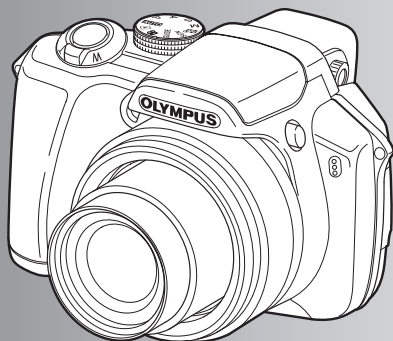

Button operations

Menu operations

Printing pictures

Using OLYMPUS Master

Getting to know your camera better

Appendix

- Thank you for purchasing an Olympus digital camera. Before you start to use your new camera, please read these instructions carefully to enjoy optimum performance and a longer service life. Keep this manual in a safe place for future reference.
- We recommend that you take test shots to get accustomed to your camera before taking important photographs.
- In the interest of continually improving products, Olympus reserves the right to update or modify information contained in this manual.
- The screen and camera illustrations shown in this manual were produced during the development stages and may differ from the actual product.

Contents

Quick Start Guide

P.3

Button operations

P.11

Test out the functions of the camera buttons by following the illustrations and trying them out on the camera.

Menu operations

P.21

Learn everything about the menus, from basic operations to the functions of each menu and their various settings.

Printing pictures

P.48

Learn how to print pictures you have taken.

Using OLYMPUS Master

P.55

Learn how to transfer pictures to a computer and save them.

Getting to know your camera better

P.62

Find out more about your camera and learn what to do when you have a question regarding operations.

Appendix

P.77

Read about convenient functions and safety precautions on how to use your camera more effectively.

Gather these items (box contents)



Digital Camera



Lens Cap/Lens Cap String

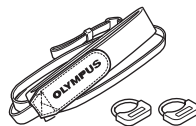

Strap/Strap rings



AA Batteries (four)

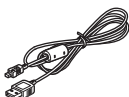

USB cable

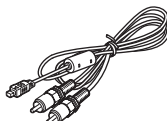

AV Cable



OLYMPUS Master 2 CD-ROM

Items not shown: Instruction Manual (this manual), warranty card.
Contents may vary depending on purchase location.

Attach the strap and the lens cap

Be sure to use the strap and strap rings provided.

- Attach the strap and strap rings together. The strap rings may fall off if they are attached without the strap.

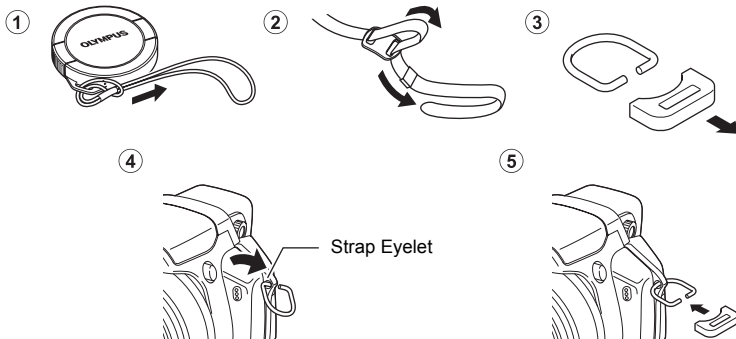

- Tilt the strap rings in such a way so that the strap rings can go through the strap eyelet.

- Insert it all the way in.

6

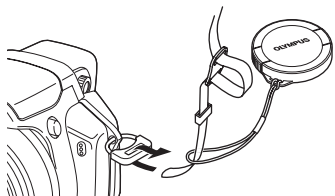

7

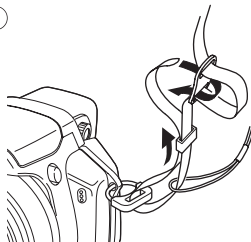

- Attach the strap to the other eyelet in the same manner.

- Pull the strap tight so that it does not come loose.

Preparing the camera

a. Load batteries into the camera

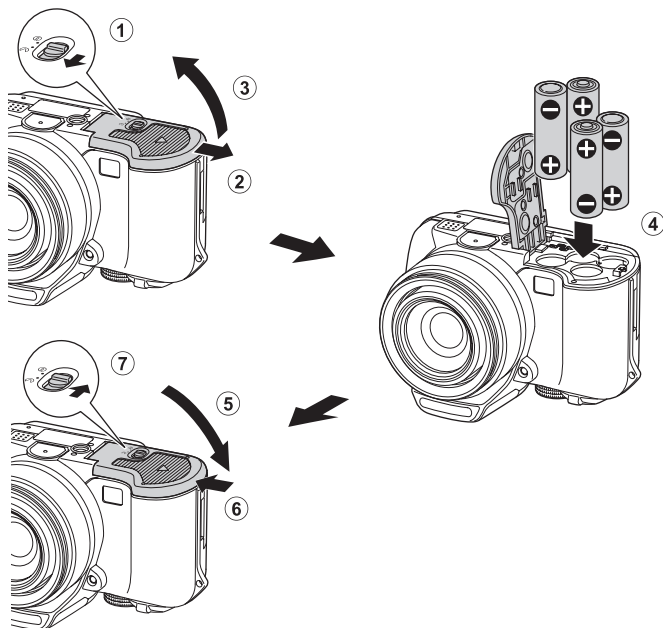

b. Insert the xD-Picture Card (optional) into the camera

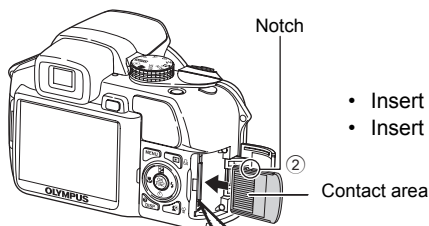
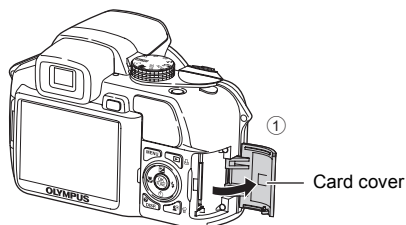

- Insert the card straight in.
- Insert the card until it clicks into place.

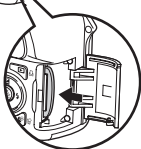

- To remove the card, push it all the way in, release it slowly and remove.

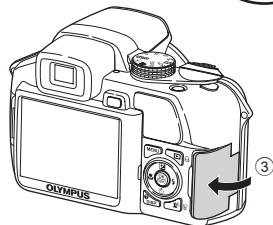

- This camera allows you to take pictures without using an optional xD-Picture Card™ (hereinafter called the card). When taking pictures without the card, pictures will be stored in the internal memory. For details on the card, please refer to "The card" (P.78).

Turn the camera on

This explains how to turn on the camera in shooting mode.

a. Set the mode dial to **AUTO**.

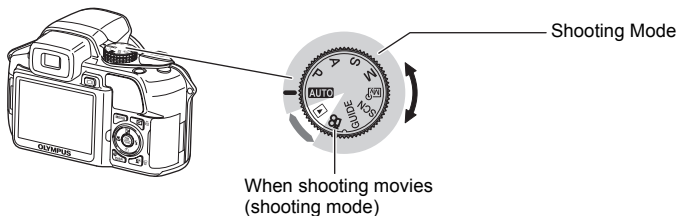

Still picture shooting modes

AUTO	The camera determines the optimum settings for the shooting conditions automatically.
P	The camera automatically sets the optimum aperture value and shutter speed.
A	This function allows you to change the aperture manually.
S	This function changes the shutter speed for shooting pictures.
M	This function allows you to change the aperture and shutter speed manually.
M[?]	This function allows you to set each shooting function manually and use as your original shooting mode.
SCN	This function allows you to shoot pictures by selecting a scene according to the shooting condition.
GUIDE	This function allows you to set the target items by following the shooting guide displayed on the screen.

b. Remove the lens cap and press the **POWER** button.

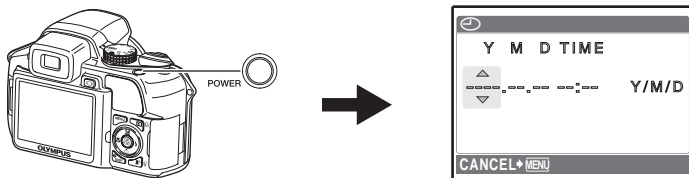

- When the date and time have not yet been set, this screen will appear.

- To turn off the camera, press the **POWER** button once again.

Set date and time

Tips

The directions of the arrow pad are indicated with \triangle ∇ \leftarrow \rightarrow in this manual.



About the date and time setting screen

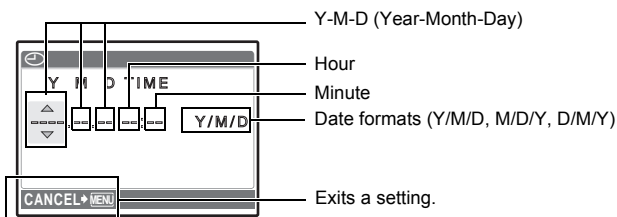

- a. Press the \triangle \square button and the ∇ \odot button to select [Y].

- The first two digits of the [Y] are fixed.

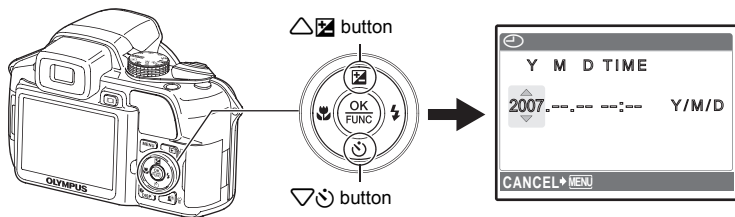

- b. Press the \rightarrow \square button.

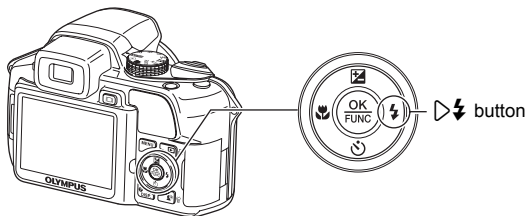

c. Press the  button and the  button to select [M].

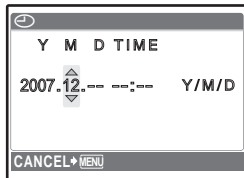

d. Press the  button.

e. Press the  button and the  button to select [D].

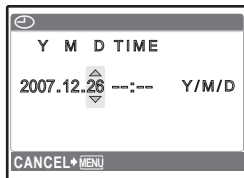

f. Press the  button.

g. Press the  button and the  button to select “hour”, “minute”.

- The time is displayed in the 24-hour format.

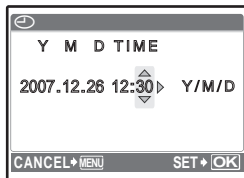

h. Press the  button.

i. Press the  button and the  button to select [Y/M/D].

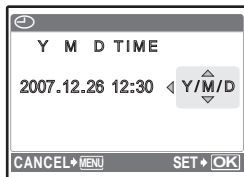

j. After all items have been set, press the  button.

- For precise time setting, press the  button as the time signal strikes 00 seconds.

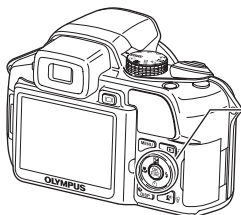

Take a picture

a. Hold the camera

Horizontal grip

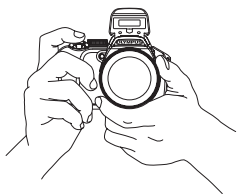

Vertical grip

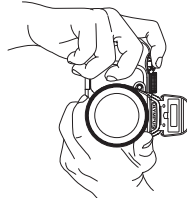

b. Focus

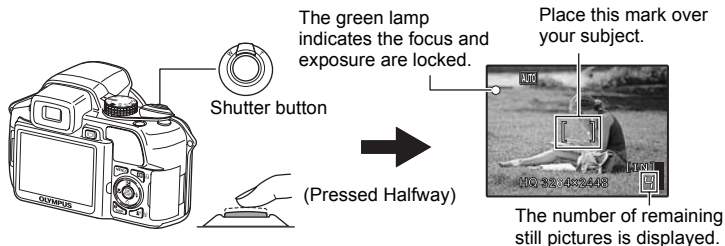

c. Shoot

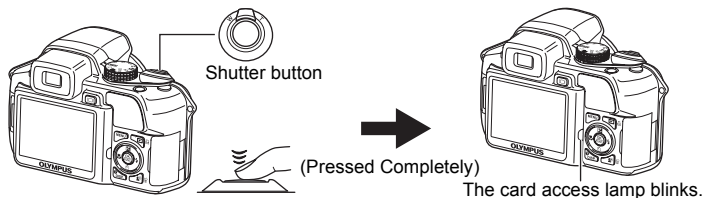

Adjusting the viewfinder's focus using the diopter

a. Press the  button.

b. While looking through the viewfinder, rotate the diopter adjustment dial little by little.

- When you can see  (AF target mark) clearly, adjustment is complete.

Diopter adjustment dial

 button





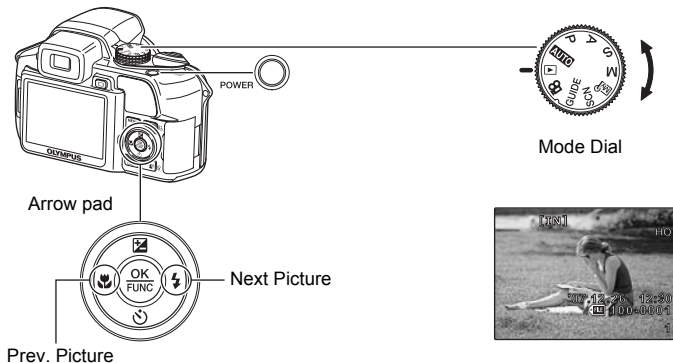

View pictures



- a. Set the mode dial to .

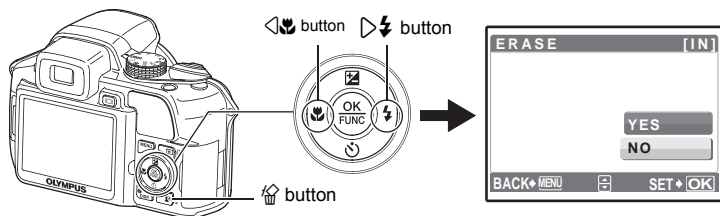

Erase pictures

- a. Press the   button and the   button to display the picture you want to erase.
b. Press the  button.



- c. Press the   button to select [YES], and press the  button to erase the picture.

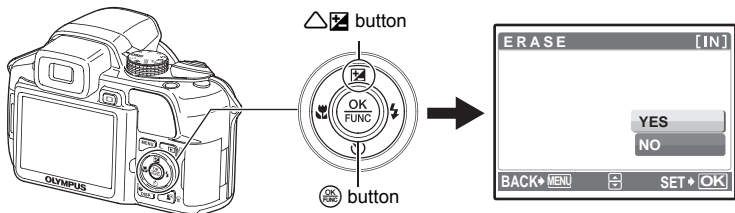

Button operations

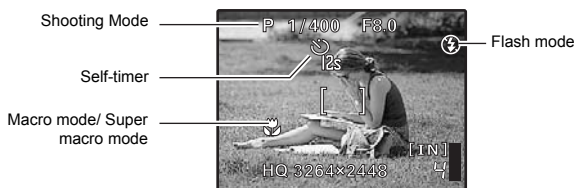
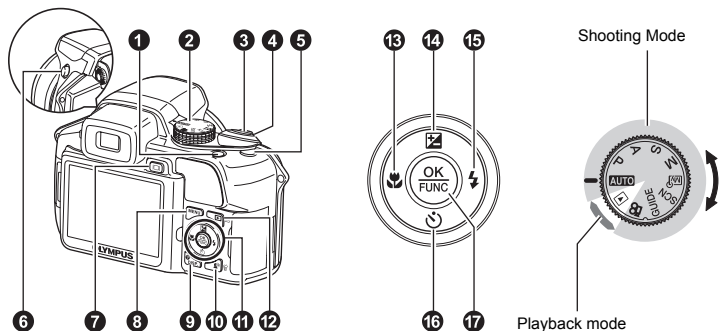

1 POWER button

Turning the camera on and off

Power on:

Shooting Mode

- Monitor turns on
- Lens extends

- Before turning the camera on in shooting mode, remove the lens cap.

Playback mode

- Monitor turns on

2 Mode dial

Switching between shooting and playback modes

Set the mode dial to the desired shooting or playback mode.

- Some functions cannot be set depending on the position of the mode dial.

"Functions available in shooting modes and scene modes" (P.73)

AUTO Shooting pictures with full automatic settings

The camera determines the optimum settings for the shooting conditions automatically. Settings in the [CAMERA MENU] such as WB and ISO Sensitivity cannot be changed.

P Set the optimum aperture value and shutter speed

The camera automatically sets the optimum aperture value and shutter speed for the brightness of the subject.

Settings in the [CAMERA MENU] such as WB and ISO Sensitivity can be changed.

A Changing the aperture value for shooting pictures

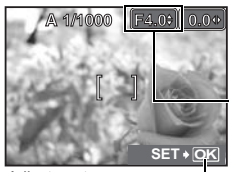

Adjustment range
 W : F2.8 to F8.0
 T : F4.5 to F8.0

Press \triangle / ∇ after pressing \triangle / \square . The camera automatically sets the shutter speed.

Aperture value

- \triangle : Increases the aperture value.
- ∇ : Decreases the aperture value.

When the correct exposure cannot be obtained, the aperture value is displayed in red.

- ⊗ : Sets the settings.

S Changing the shutter speed for shooting pictures

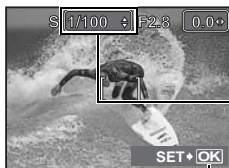

Shutter speed range:
 1/2 to 1/1000
 (When [NOISE REDUCT.]
 is set to [ON]: up to 4 sec.)

Press \triangle / ∇ after pressing \triangle / \square . The camera automatically sets the aperture value.

Shutter speed

- \triangle : Sets the shutter speed faster.
- ∇ : Sets the shutter speed slower.

When the correct exposure cannot be obtained, the shutter speed is displayed in red.

- ⊗ : Sets the settings.

M Changing the aperture value and shutter speed for shooting pictures

Press \triangle / ∇ / \triangleleft / \triangleright after pressing \triangle / \square .



Setting range:
 Aperture value F2.8 to F8.0
 (The aperture value varies
 depending on the zoom position.)
 Shutter speed: 15" to 1/2000
 (The shutter speed varies
 depending on the aperture value.)

Exposure differential

When this range has been exceeded $\pm 3.0\text{EV}$, the exposure differential is displayed in red.

Aperture value

- \triangleleft : Increases the aperture value.
- \triangleright : Decreases the aperture value.

Shutter speed

- \triangle : Sets the shutter speed faster.
- ∇ : Sets the shutter speed slower.

- ⊗ : Sets the settings.

To take long exposure (bulb) shots

Press ∇ to set shutter speed to BULB. The shutter remains open as long as the shutter button is pressed. (The maximum time that it can remain open is 8 minutes, however, this is possible only when [ISO] is set to [50], [100] or [200].)

Setting your own original mode for shooting pictures

This mode allows you to set functions and save up to 4 shooting modes manually, and use them as your original shooting mode.

 "MY MODE SETUP Setting and saving shooting-related functions" (P.47)

Use the function menu to switch the registered My Mode.

 "The functions you can set with the function menu" (P.20)

SCN Shoot pictures by selecting a scene according to the situation

You can shoot pictures by selecting a scene mode according to the situation.

Select a scene mode/change the scene mode to another one

- Press **MENU** and select [SCN] from the top menu. Use the \triangle/∇ to select a scene and press \odot .
- By switching to the other scene mode, most settings will be changed to the default settings of each scene mode.

 "**SCN** (Scene) Shooting pictures by selecting a scene according to the situation" (P.24)

GUIDE Follow the shooting guide for setting

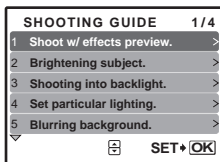

This function allows you to set the target items by following the shooting guide displayed on the screen.

- Press **MENU** to display the shooting guide again.
- To change the setting without using the shooting guide, set the shooting mode to another one.
- Functions set using the Shooting Guide will revert to the default settings when **MENU** is pressed or when the shooting mode is changed.

Shooting pictures while comparing previews of different effects

When [Exposure effects.] is selected

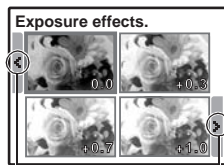

Use \triangle/∇ to change the display.

When an item is selected from [1 Shoot w/ effects preview.] using the shooting guide menu, the screen splits into 4 frames and pictures of subjects taken according to the individual settings will be displayed. You can then compare the shooting effects on the screen.

- Use the arrow pad to select the frame with the settings you want, and press \odot . The camera automatically switches to shooting mode and allows you to shoot with the selected effect.

Recording movies

When \odot (movies) is set to [ON], audio is recorded with the movie.

- When \odot (movies) is set to [ON], optical zoom cannot be used during the shooting.

 " \odot (movies) Recording sound with movies" (P.33)

- To zoom in when \odot (movies) is set to [ON], set [DIGITAL ZOOM] to [ON].

 "DIGITAL ZOOM Zooming in on your subject" (P.28)



This icon lights red during movie recording.

The remaining recording time is displayed.
When the remaining recording time reaches 0, recording stops.

- When [IMAGE STABILIZER] is set to [ON], continuous movie recording for a long period will cause the camera's internal temperature to rise and the camera may stop operation automatically. Remove the battery and allow the camera to cool down for some time before you begin shooting again. Or you can set [IMAGE STABILIZER] to [OFF].
In addition, the temperature of the camera's exterior also rises during usage. This is not a malfunction.

▶ Selecting playback mode

The last picture taken is displayed.

- Press the arrow pad to view other pictures.
 - Use the zoom lever to switch among close-up playback, index display and calendar display.
- ▶ "MOVIE PLAY Playing back movies" (P.35)

Displaying pictures that have been shot continuously in index view (Sequential Playback) / Auto playing back of pictures that have been shot continuously (Sequential Pictures Auto Playback)

Only the first frame will be displayed for pictures that have been shot continuously using the next option.

[] [Hi 1] [Hi 2] [AF] [BKT] [TIMELAPSE] [AUCTION] [SHOOT & SELECT1]
[SHOOT & SELECT2] [SMILE SHOT]

- Select the pictures that have the [] displayed and press [] to playback in index view (Sequential Playback). Press the [] again to return to the first frame.
- Select the pictures that have the [] displayed and press [], to playback automatically (Sequential Pictures Auto Playback).
- This function is only available for pictures taken with this model.
- When the first frame is displayed, perform the next operation to configure the settings to all the sequential pictures.

▶ /PRINT ORDER/ERASE

To configure settings to individual pictures, press [] to display the pictures in index view first before configuring.

3 Shutter button

Shooting pictures

Shooting still pictures

Set the mode dial to **AUTO**, **P**, **A**, **S**, **M**, [AF], **GUIDE** or **SCN**, and lightly press the shutter button (halfway). The green lamp lights when the focus and exposure are locked (focus lock). Now press the shutter button all the way (completely) to shoot a picture.

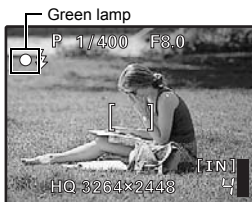

Locking the focus and then composing the shot (focus lock)

Compose your picture with the focus locked, and then fully press the shutter button to shoot a picture.

- When the green lamp blinks, the focus is not adjusted properly. Try locking the focus again.

Recording movies

Set the mode dial to , and press the shutter button halfway to lock the focus, and then press the shutter button completely to start recording. Press the shutter button again to stop recording.

4 Zoom Lever

Zooming while shooting/close-up playback

Shooting mode: Zooming in on your subject

Optical zoom: 18x



Zoom out:
Push the lever toward W.



Zoom in:
Pull the lever toward T.

Playback mode: Changing the picture display

Single-frame playback

- Use the arrow pad to browse pictures.

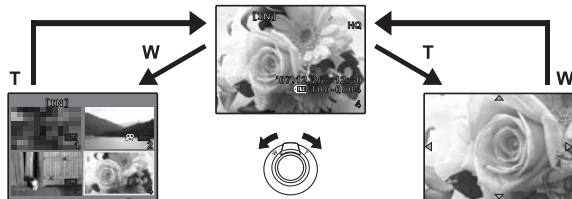

Index display

- Use the arrow pad to select a picture for playback, and press  to play back the single-frame of the picture selected.

Close-up playback

- Pull the lever toward T to incrementally enlarge the picture up to 10 times the original size. Push the lever toward W to reduce the size.
- Use the arrow pad during close-up playback to scroll around the picture.
- Press  to return to the single-frame playback.

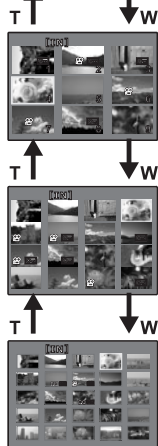

Calendar display

- Use the arrow pad to select the date, and press  or pull the lever toward T on the zoom lever to display the pictures on the date selected.

**Shooting mode: Shooting with digital image stabilization**

Press in shooting mode to select [] ON].

Press to set.

"IMAGE STABILIZER Shooting pictures using digital image stabilization" (P.29)

Shooting mode: Using this button as custom button

allows you to register frequently used functions when the Mode Dial is **P**, **A**, **S**, **M**, or **SCN**. (custom button)

You can then set the settings directly with the button instead of displaying the screen from the menu. (Example) When [FINE ZOOM] is registered in [CUSTOM BUTTON]

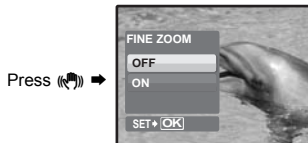

A direct setting screen is displayed.

"CUSTOM BUTTON Assigning functions to the custom buttons" (P.47)

"Functions that can be assigned to My Mode/custom button" (P.72)

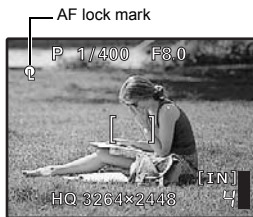

- **Locking the focus position (AF Lock)**

- Assign the AF lock function to so that the focus is locked by pressing , and (AF lock mark) is displayed on the monitor. AF Lock will be kept after shooting. To cancel the AF Lock, either press again, or change the exposure/shooting settings or the shooting mode. Each time you press the button, focus is locked and canceled alternately.
- If the zoom is operated after engaging the AF lock, the picture may be out of focus. Engage the AF lock after operating the zoom.

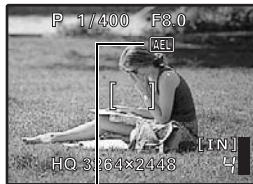

AEL is displayed while in AE lock.

- **Locking the exposure (AE lock)**

- Assign the AE lock function to so that the meter reading is saved by pressing and the exposure is locked. **AEL** (AE lock mark) is displayed on the monitor. AE Lock will be kept after shooting. To cancel the AE Lock, either press again, or change the exposure/shooting settings or the shooting mode. Each time you press the button, focus is locked and canceled alternately.

- **Locking the focus positions and exposure (AF LOCK + AE LOCK)**

- Register the AF lock + AE lock functions to so that the meter reading is saved by pressing and the focus and exposure is locked. (AF lock mark) and **AEL** (AE lock mark) are displayed on the monitor. Press again to cancel the AF lock + AE lock. Each time you press the button, focus and exposure are locked and canceled alternately.

Playback mode: Playing back continuously shot pictures in index display

Only the first frame will be displayed for pictures that have been shot continuously.

Press in the playback mode to display pictures in index view.

- "Displaying pictures that have been shot continuously in index view (Sequential Playback) / Auto playing back of pictures that have been shot continuously (Sequential Pictures Auto Playback)" (P.14)

6 button

Flash pop-up

Opens the flash.

Press this button to take a picture with flash.

- "D button Flash shooting" (P.19)

7 button

Monitor/Viewfinder

Toggles between the monitor and viewfinder.

8 MENU button (MENU)

Displays the top menu.

9 DISP./ button

Changing the information on display/Display the menu guide/Checking the time

Changing the information displays

Press **DISP./** to change the display in the following order.

- It cannot be switched when the mode dial is set to **GUIDE**.

Shooting Mode

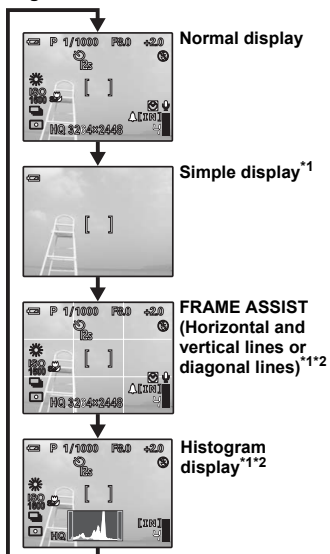

Playback mode

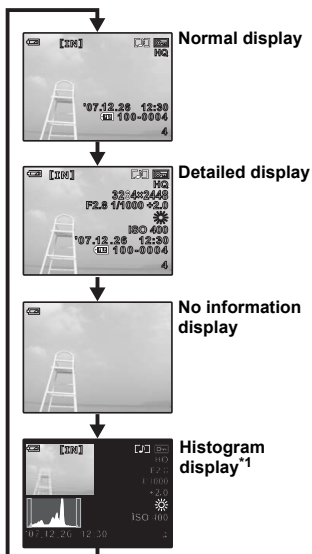

*1 Not displayed in case of .

*2 Not displayed if it is set to [OFF] in the menu.

"Histogram" (P.46)

"FRAME ASSIST" (P.46)

Displaying the menu guide



With menu items selected, hold down **DISP./** to display the menu guide. Release **DISP./** to close the menu guide.

Checking the time

While the camera is off, press **DISP./** to display the set alarm time (when [ALARM CLOCK] is set) and the current time for 3 seconds.

10 button

Brightening the subject against backlight / Erasing pictures

Shooting mode: Brightening the subject against backlight

Press in shooting mode to turn on or off Shadow Adjustment Technology. Press to set. A frame is displayed at the detected position (except for). This function makes the face of the subject appear brighter even against backlight.

SHADOW ADJ. OFF Shadow Adjustment Technology is deactivated.

SHADOW ADJ. ON Shadow Adjustment Technology is activated.

- The face may not be detected for some subjects.
- It may take some time for the frame to appear.
- When [SHADOW ADJ. ON] is selected, the following setting restrictions apply.
 - [METERING] is fixed at [ESP].
 - [AF MODE] is fixed at [FACE DETECT].
 - This function is applicable only for the first frame when [DRIVE] is not set to [□].
 - This function is applicable only for the first picture in [PANORAMA].

Playback mode: Erasing pictures

Display a picture to erase in playback mode, and press the .

- Once erased, pictures cannot be restored. Check each picture before erasing to avoid accidentally erasing pictures you want to keep.

"On Protecting pictures" (P.39)

11 button

Use the arrow pad to select scenes, playback picture, and the items on the menus.

12 button

Viewing pictures/Printing pictures

Shooting mode: Viewing pictures

The last picture taken is displayed on the monitor. Press in shooting mode. Press again or press the shutter button halfway to return to shooting mode.

Playback mode: Printing pictures

When the printer is connected to the camera, display a picture to be printed out in playback mode, and press .



"Easy print" (P.48)

13  button

Shooting pictures close to the subject (Macro)

Press  in shooting mode to select the macro mode.

Press  to set.



OFF	Macro mode is deactivated.
 (Macro mode)	Allows you to shoot from as close as 10 cm/3.94 in. (when the zoom is set for the zoom-out angle) to your subject.
 (Super macro mode)	Allows you to shoot from as close as 1 cm/0.39 in. to your subject.

• Some items cannot be set depending on the position of the mode dial.

 "Functions available in shooting modes and scene modes" (P.73)

14  button

Changing picture brightness(Exposure compensation)

Press  in shooting mode, set using  then press .

• Adjustable from -2.0 EV to +2.0 EV.



 : Brighten.

 : Darken.



 Activate the setting contents.

• Some items cannot be set depending on the position of the mode dial.

 "Functions available in shooting modes and scene modes" (P.73)







15  button

Flash shooting

Press  (Flash pop-up) in shooting mode to open the flash. Then press  to select the flash mode. The settings cannot be made if the flash is not popped up.

 "Flash pop-up" (P.17)



Press  to set.



AUTO (Auto-flash)	The flash fires automatically in low light or backlight conditions.
 (Red-eye reduction flash)	This emits pre-flashes to reduce the occurrence of red-eye in your pictures.
 (Fill-in flash)	The flash fires regardless of the available light.
 (Red-eye fill-in flash)	The flash always fires after pre-flashes for red-eye reduction are emitted.
 SLOW	The flash fires with slow shutter speed. Set the flash timing in [ SYNCRO].  "SYNCRO Selecting the flash timing" (P.30)
 (Flash off)	The flash does not fire.

• Some items cannot be set depending on the position of the mode dial.

 "Functions available in shooting modes and scene modes" (P.73)

16  **button****Self-timer shooting**

Press  in shooting mode to select on and off of the self-timer.
 Press  to set.

 OFF	Cancel the self-timer.
 12 SEC	After the setting, press the shutter button completely. The self-timer lamp lights for approximately 10 seconds, then starts blinking. After blinking for approximately 2 seconds, the picture is taken.
 2 SEC	After the setting, press the shutter button completely. The self-timer lamp flashes for 2 seconds, the picture is taken.

- To cancel the self-timer, press .
- Self-timer shooting is automatically canceled after one shot.
- When [AF PREDICT] or [PRE-CAPTURE] is set to [ON], self-timer settings cannot be made.



17  **button (OK/FUNC)****Setting using the function menu**

Displays the function menu which contains the functions and settings frequently used during shooting. This button is also used to confirm your selection.

The functions you can set with the function menu

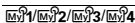

My 1/2/3/4 Switching the registered original shooting mode







- Displayed when the mode dial is set to .
- Settings are registered on  as a factory default.

Function menu



-  : Select a setting, and press .
-  : Select the function to be set.

Other functions you can set with the function menu

-  "WB Adjusting the color of a picture" (P.25)
-  "ISO Changing the ISO sensitivity" (P.26)
-  "DRIVE Continuous shooting" (P.27)
-  "METERING Changing the area for measuring the brightness of a subject" (P.28)

Menu operations

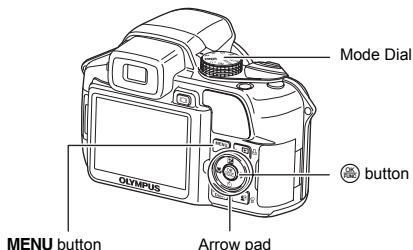

About the menus

Pressing **MENU** displays the top menu on the monitor or viewfinder.

- The items displayed on the top menu differ according to the mode.

Top menu (When Mode Dial is set to **P**)

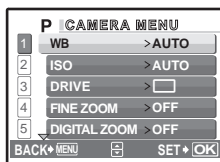
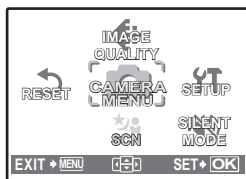

- When [CAMERA MENU], [PLAYBACK MENU], [EDIT], [ERASE] or [SETUP] is selected, the menu corresponding to the respective functions is displayed.
- When your camera is set according to the shooting guide with the mode dial set at **GUIDE**, press **MENU** to display the shooting guide screen.

Operation guide

During menu operations, the buttons and their respective functions are displayed at the bottom of the monitor. Follow these guides to navigate the menus.

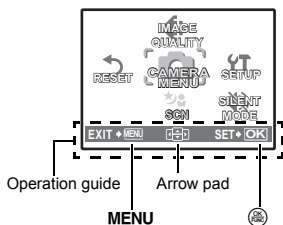

- BACK → MENU : Returns to the previous menu.
- EXIT → MENU : Exits the menu.
- Arrow pad : Press $\Delta \nabla \leftarrow \rightarrow$ to select a setting.
- SET → OK : Sets the selected item.

Using the menus





This explains how to use the menus with [DIGITAL ZOOM] as an example.

1 Set the mode dial to **P**.

2 Press **MENU** to display the top menu. Select [CAMERA MENU] and press .

- [DIGITAL ZOOM] is on a menu in [CAMERA MENU]. Press .

3 Press to select [DIGITAL ZOOM], and press .

- Unavailable settings cannot be selected.
- When pressing  on this screen, the cursor moves to the page display. Pressing   changes the page. To return to item selection, press  or .

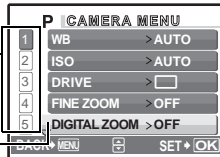
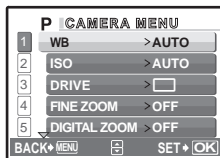
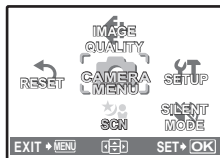

Page display: _____
The page display mark is displayed when there are additional menu items on the next page.

The selected item is displayed in a different color.

4 Press to select [OFF] or [ON], and press .

- The menu item is set and the previous menu is displayed. Press **MENU** repeatedly to exit the menu.
- To cancel changes and continue menu operation, press **MENU** before pressing .

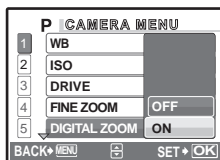





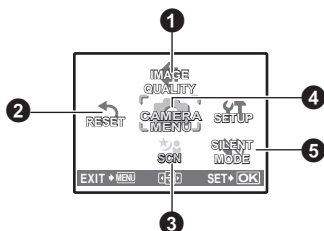

Shooting mode menu

AUTO P A S M  **SCN** 



4 CAMERA MENU

WB	 SYNCRO
ISO	 FLASH
DRIVE	 (still pictures)
FINE ZOOM	PANORAMA ^{*1}
DIGITAL ZOOM	WB?
METERING	SHARPNESS
AF MODE	CONTRAST
FOCUS MODE	SATURATION
FULL TIME AF	NOISE REDUCT.
AF PREDICT	TIMELAPSE
AF ILLUMINAT.	 (conversion lens)
IMAGE STABILIZER	 (movies)
	

*1 An OLYMPUS xD-Picture Card is required.

- Some menu items are not available depending on the position of the mode dial.
- ☞ “Functions available in shooting modes and scene modes” (P.73)
- ☞ “SETUP menus” (P.41)
- The factory default settings are displayed in gray ().

1 IMAGE QUALITY

Changing the image quality

Still picture image quality and their applications

Image quality	Image size	Compression	Application
RAW*1	3264x2448	—	<ul style="list-style-type: none"> • Raw uncompressed data. • Data is in ORF format.
SHQ	3264x2448 3 : 2 3264x2176	Low compression	<ul style="list-style-type: none"> • This is useful for printing large images on full-size paper. (For [3264x2448].) • This is useful for ordering prints from a photo store. (For [3 : 2 3264x2176].)
HQ	3264x2448 3 : 2 3264x2176	Standard compression	<ul style="list-style-type: none"> • This is useful for performing computer image processing, such as contrast adjustment and red-eye correction.
SQ1*2	2560x1920 2304x1728 2048x1536	Low compression (High quality) / Standard compression (Standard)	<ul style="list-style-type: none"> • This is useful for printing on full-size paper. • This is useful for computer editing such as rotating or adding text to a picture.
SQ2*2	1600x1200 1280x960 1024x768 640x480	Low compression (High quality) / Standard compression (Standard)	<ul style="list-style-type: none"> • This is useful for printing on A5 paper and below. • This is useful for viewing pictures on a computer. • This is useful for sending as e-mail attachments.
16 : 9	1920x1080	Standard compression	<ul style="list-style-type: none"> • This is useful for expressing the broadness of a subject such as landscapes and for viewing pictures on a wide-screen television. • [PANORAMA] cannot be set.

*1 Not displayed when set to **AUTO** or **SCN**.

*2 If you select [SQ1] or [SQ2], select [HIGH] or [NORMAL] after selecting the image size.

JPEG copy

Pictures taken in the [RAW] data format can be stored in JPEG format at the same time as they are recorded in raw data. To record pictures in JPEG format you can select [SHQ], [HQ], [SQ1] or [SQ2] for the record mode, but you cannot select the image size. Pictures are recorded in the size currently set for each record mode.

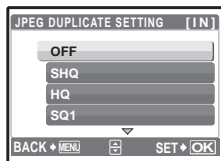

- In the [IMAGE QUALITY] screen, select [RAW], and press \triangleright .
- Select a JPEG duplicate setting from [OFF], [SHQ], [HQ], [SQ1] and [SQ2] and press \odot . (Select [OFF] to save raw data only.)

Movie image quality

Image quality	Image size	Number of frames
SHQ	640x480	30 frames/sec.
HQ	320x240	15 frames/sec.
SQ	160x120	15 frames/sec.

2 RESET

Change the shooting functions back to default settings

NO / YES

It restores shooting functions back to default settings.

Functions restored to the factory default settings

Function	Factory default setting	Ref. Page	Function	Factory default setting	Ref. Page
Flash	AUTO	P.19	AF ILLUMINAT.	ON	P.29
	OFF	P.19	IMAGE STABILIZER	ON	P.29
	OFF	P.20		± 0.0	P.30
	0.0	P.19		SYNC1	P.30
IMAGE QUALITY	HQ	P.23		IN	P.30
WB	AUTO	P.25		OFF	P.30
ISO	AUTO	P.26		± 0	P.31
DRIVE		P.27	SHARPNESS	± 0	P.32
FINE ZOOM	OFF	P.27	CONTRAST	± 0	P.32
DIGITAL ZOOM	OFF	P.28	SATURATION	± 0	P.32
METERING	ESP	P.28	NOISE REDUCT.	ON	P.32
AF MODE	iESP	P.28	TIMELAPSE	OFF	P.33
FOCUS MODE	AF	P.29		OFF	P.33
FULLTIME AF	OFF	P.29		OFF	P.33
AF PREDICT	OFF	P.29	Monitor/Viewfinder (I/O)	Monitor	P.17
			SCN	PORTRAIT	P.24

3 SCN (Scene)

Shooting pictures by selecting a scene according to the situation

PORTRAIT /LANDSCAPE/LANDSCAPE+PORTRAIT/SPORT/
 NIGHT SCENE^{*1}/NIGHT+PORTRAIT^{*1}/INDOOR/CANDLE/SELF PORTRAIT/
 AVAILABLE LIGHT/SUNSET/FIREWORKS^{*1}/CUISINE/BEHIND GLASS/
 DOCUMENTS/AUCTION^{*2}/SHOOT & SELECT1^{*2}/SHOOT & SELECT2^{*3}/
 SMILE SHOT/BEACH/SNOW/UNDER WATER WIDE1^{*4}/UNDER WATER WIDE2^{*4}/
 UNDER WATER MACRO^{*4}/QUICK SHUTTER

The scene mode selection screen displays sample images as well as a description of the shooting situation for which it is designed.

- By switching to the other scene mode, most settings will be changed to the default settings of each scene mode.
The zoom position may change automatically depending on the scene.
- *1 When the subject is dark, noise reduction is automatically activated. This approximately doubles the shooting time, during which the next picture cannot be taken.
- *2 The focus is locked at the first frame.
- *3 During sequential shooting, the camera focuses for each frame.
- *4 Use a waterproof protector.
- *5 The focus distance is fixed at approximately 5.0 m (16.4 ft).

Scene mode selection screen

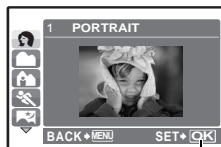

Set the scene mode.

[] SHOOT & SELECT1 [] SHOOT & SELECT2

- Press and hold the shutter button to shoot sequential pictures. After shooting pictures, select the ones you want to erase, put ✓ to them, and press to erase them.

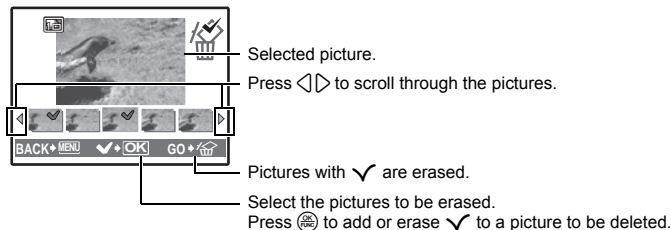

[] SMILE SHOT

- When the camera detects a smiling face in shooting standby mode, 3 frames are automatically taken in high speed sequential shooting mode. You can also shoot a picture by pressing the shutter button.
- A smiling face may not be detected for some subjects.
- When [SMILE SHOT] is selected, the self-timer lamp lights. Shooting is not available while the self-timer lamp is blinking.

[] QUICK SHUTTER

- [FULLTIME AF] is automatically set to [ON].
- "FULLTIME AF Shooting pictures while keeping the subject in focus" (P.29)
- When [FULLTIME AF] is set to [OFF], [CUSTOM BUTTON] is set to [AF LOCK].
- "Shooting mode: Using this button as custom button" (P.16)
- [] and [] in [DRIVE] can be set.

4 CAMERA MENU

WB Adjusting the color of a picture

AUTO		The white balance is adjusted automatically for natural color, regardless of the light source.
PRESET		Selects the white balance according to the light source.
	Sunny day	For shooting under a clear sky.
	Cloudy day	For shooting under a cloudy sky.
	Tungsten light	For shooting under tungsten lighting.
	Fluorescent lamp 1	For shooting under daylight fluorescent lighting. (This type of lamp is mainly used in homes.)
	Fluorescent lamp 2	For shooting under a neutral white fluorescent lamp. (This type of lamp is mainly used in desk lamps.)
	Fluorescent lamp 3	For shooting under a white fluorescent lamp. (This type of lamp is mainly used in offices.)
	One-touch WB	For setting a more precise white balance than preset white balance can provide. You can set and save the optimum white balance for the shooting conditions.

When [PRESET] is selected

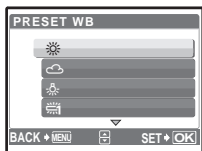

Press \triangle / ∇ to select a white balance setting, then press \odot .

When [ONE TOUCH] is selected

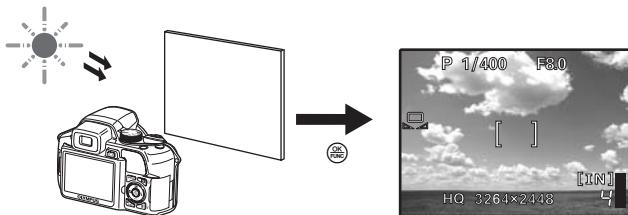

- With the [ONE TOUCH WB] screen displayed, point the camera at a sheet of white paper. Position the paper so that it fills the screen, making sure there are no shadows.
- Press \odot . The new white balance is set.

ISO Changing the ISO sensitivity

AUTO	Sensitivity is automatically adjusted according to the conditions of the subject.
HIGH ISO AUTO	This function has a higher sensitivity compared to [AUTO] and stabilizes the blur caused by a moving subject or camera movement when taking pictures.
50/100/200/400/ 800/1600/3200/ 6400	A low value lowers the sensitivity for daylight shooting of clear, sharp pictures. The higher the value, the better the camera's light sensitivity and ability to shoot with a fast shutter speed and in low light conditions. However, high sensitivity introduces noise into the resulting picture, which may give it a grainy appearance.

- If set to [6400], [IMAGE QUALITY] is limited to below [2048x1536].
- If [FINE ZOOM] or [DIGITAL ZOOM] is set to [ON], [6400] cannot be set.

DRIVE Continuous shooting

	Shoots 1 frame at a time when the shutter button is pressed.
	Focus and exposure are locked at the first frame. The sequential shooting speed varies depending on the setting of image quality.
	Pictures can be taken at a faster speed than normal sequential shooting.
	Sequential shooting at a speed of 15 frames/sec.
	Adjusts the focus 1 frame at a time. The shooting speed is slower than for normal sequential shooting.
BKT	Takes pictures sequentially while changing the exposure for each frame (Bracket shooting). Focus and white balance are locked at the first frame.

You can take a sequence of pictures at one time by holding down the shutter button. The camera will take pictures continuously until you release the shutter button.

- Only [] is available when record mode is set to [RAW].
- Flash cannot be used when [Hi 12] or [Hi 2] is set.
- When [Hi 12] is set, [IMAGE QUALITY] is limited to below [2048x1536] and the maximum number of pictures that can be taken for sequential shooting is approximately less than 23.
- When [Hi 2] is set, [IMAGE QUALITY] is limited to below [1280x960] and the maximum number of pictures that can be taken for sequential shooting is approximately less than 40. (This includes the 10 pictures stored shortly before shooting if [PRE-CAPTURE] is set to [ON].)
- When [Hi 12] or [Hi 2] is selected, [ISO] cannot be set to [HIGH ISO AUTO], [50], [100] or [200].

When [Hi 2] is selected

PRE-CAPTURE OFF / ON

- When [PRE-CAPTURE] is set to [ON], pressing the shutter button halfway stores 10 frames of a picture shortly before shooting.

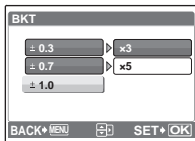
When [BKT] is selected

Exposure differential	± 0.3 / ± 0.7 / ± 1.0
Number of frames	x3 / x5

- Press the shutter button completely and keep it pressed to shoot the preset number of pictures. You can stop shooting at any time by releasing the shutter button.

FINE ZOOM Zooming in on your subject without reducing image quality

OFF / ON

This function allows you to zoom up to 27x by combining the optical zoom and image cropping. As data with few pixels are not converted to multiple pixels, there is no loss of image quality.

- [IMAGE QUALITY] is limited to below [2048x1536].

DIGITAL ZOOM Zooming in on your subject

OFF /ON

The digital zoom can be used to take close-up pictures with stronger magnification than the optical zoom.

Optical zoom



Maximum magnification:
 Still picture shooting modes
 Optical zoom × digital zoom: Approx. 100x (max.)
 Movie shooting mode
 Optical zoom × digital zoom: Approx. 54x (max.)



Digital zoom



Zoom bar
 White area: The optical zoom area
 Red area: The digital zoom area

METERING Changing the area for measuring the brightness of a subject

ESP	Meters the brightness at the center of the monitor and the surrounding area separately to capture an image with balanced brightness. When taking pictures against strong backlight, the center of the picture may appear dark.
	The AF target mark area is metered. Recommended for taking a picture against strong backlight.
	Meters the brightness over a wide area with emphasis on the center of the screen. This method is used when you do not want to allow surrounding light to affect the picture.

AF MODE Changing the focusing area

FACE DETECT	When a face is being detected in the screen, the camera will focus on the face. A frame is displayed at the detected position.
iESP	The camera determines which subject within the screen to focus on. Even when the subject is not in the center of the screen, focusing is possible.
SPOT	Focus selection is based on the subject within the AF target mark.
AREA	Move the AF target mark to select the area you want to focus on to take a picture.

- The [FACE DETECT] may not be able to detect the face for some subjects.
- If [FINE ZOOM] or [DIGITAL ZOOM] is set to [ON], [AREA] cannot be set.

When [AREA] is selected

- To move the AF target mark
 Press the arrow pad (the AF target mark is displayed in green).
 You can take pictures while in this status.
- To set the position of the AF target mark
 Hold down .
 To change the position of the mark, hold down again.

FOCUS MODE **Changing the focus method**

AF	Press the shutter button halfway. The camera automatically focuses.
MF	Adjust the focus manually.

**When set to [MF]**

- Press $\Delta \nabla$ to set the focus. During operation, the focus area is enlarged.
- Hold down \odot to fix the focus. The focus is locked at the distance you have set, and MF is displayed in red on the monitor. To adjust the focus, hold down \odot again.
- The distance displayed on the screen is a reference figure.

FULLTIME AF **Shooting pictures while keeping the subject in focus**

OFF	Press the shutter button halfway to focus.
ON	Fulltime AF keeps the subject in front of the lens in focus at all times, without having to press the shutter button halfway. The focusing time is reduced, so you will not miss snapshot opportunities. Also, the subject is automatically kept in focus during movie recording.

AF PREDICT **Shooting pictures with the focus on subjects moving back and forth**

OFF	AF predict is deactivated.
ON	When activated, position the AF target mark on the subject and press the shutter button halfway to engage the AF predict. Then, press the shutter button completely to take the picture.

- \odot blinks and AF predict continues to operate while the shutter button is pressed halfway.
- Depending on the subject, the picture may be out of focus even if [AF PREDICT] is set.
- During macro and super macro mode, [AF PREDICT] is not available.

AF ILLUMINAT. **Setting to light the illuminator in a dark place**

OFF	AF illuminator does not light.
ON	Press the shutter button halfway. The AF illuminator automatically lights.

IMAGE STABILIZER **Shooting pictures using digital image stabilization**

This function stabilizes the blur caused by camera movement when taking pictures.

OFF	Digital image stabilization is deactivated.
ON	Digital image stabilization is activated after pressing the shutter button halfway.

- When taking pictures with the camera stabilized (using a tripod), set to [OFF].
- Images may not be correctable if the camera is severely shaken.
- During night shooting or when the shutter speed is very slow, the Digital image stabilization mode may not work.



..... Adjusting the amount of light emitted by the flash

Depending on situations such as shooting small subjects or distant backgrounds, it may be advisable to adjust the amount of light emitted by the flash. In addition, this function is useful when increased contrast is desired.

+2.0EV to 0.0 to -2.0EV

Press   to adjust, and press .

SYNCRO Selecting the flash timing

 SYNC1	The flash fires right after the shutter fully opens (front curtain).
 SYNC2	With the rear curtain, the flash fires just before the shutter closes (rear curtain). You can use this setting to create interesting effects in your picture, such as expressing the movement of a car by showing the tail-lights streaming backwards. The slower the shutter speed, the better the effects turn out. If the shutter speed is faster than 1/200, the flash fires automatically with the front curtain.

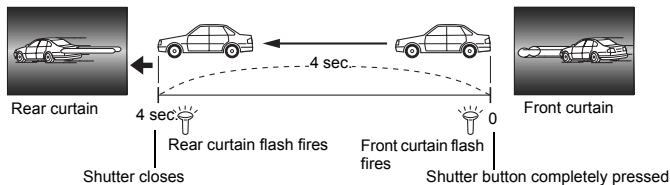

When the shutter speed is set to 4 sec.







FLASH Setting to use an external flash

IN	Allows you to take pictures using the built-in flash.
SLAVE	When using a commercially available slave flash that is synchronized with the camera flash, the amount of the light emitted by the flash can be adjusted in 10 levels.

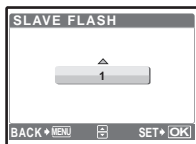
Selecting an emission level

- When flash is set to [SLAVE], flash mode automatically changes to  (Fill-in flash) for all flash modes except  (Flash off).



Press   to select an emission level from [1] to [10], then press . The bigger number indicates the bigger amount of light emitted by the flash.

- The flash can fire in sequential shooting mode, but the interval between shots will be longer if a high emission level is set.

(still pictures) Recording sound with still pictures

OFF / ON

It automatically starts recording for about 4 seconds after shooting pictures.

When recording, aim the camera microphone at the source of the sound you want to record.

PANORAMA Creating a panoramic picture

Panorama shooting lets you create a panoramic picture, using the OLYMPUS Master software from the provided CD-ROM. An Olympus xD-Picture Card is required for panorama shooting.

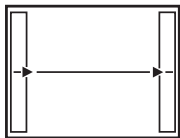

Connects pictures from left to right

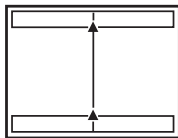

Connects pictures from bottom to top

- ▷: The next picture is connected at the right edge.
- ◁: The next picture is connected at the left edge.

- △: The next picture is connected at the top.
- ▽: The next picture is connected at the bottom.

Use the arrow pad to specify at which edge you want to connect the pictures, and then compose your shots so that the edges of the pictures overlap. The part of the previous picture that will be combined will not remain in the frame. Remember the frame displayed on the monitor as a rough indication, then compose the shot so that the edges of the previous picture in the frame overlap with the next shot.



- Press to exit panorama shooting.
- Panorama shooting is possible for up to 10 pictures. A warning mark is displayed after 10 pictures are taken.

..... Adjusting the white balance compensation



- The white balance can be adjusted in 7 increments in both the [BLUE] and [RED] directions.

Press after setting is complete.

△ : Each press makes the color more blue.

▽ : Each press makes the color more red.

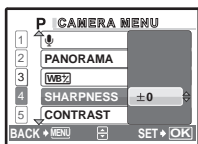
SHARPNESS Adjusting the sharpness of the image

△ (Toward +)

: The image contours are emphasized, making the image appear sharper and more vivid. Use this setting when you want to print pictures. If you adjust the sharpness too far toward +, noise may become conspicuous in the picture.

▽ (Toward -)

: The image contours are softened. Use this setting when you want to edit images on a computer.

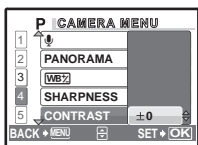
CONTRAST Adjusting the contrast of the image

△ (Toward +)

: The light and dark areas are defined more clearly, making the image look crisper.

▽ (Toward -)

: The light and dark areas become less defined, giving the image a softer impression. Use this setting when you want to edit images on a computer.

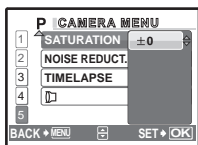
SATURATION Adjusting the saturation of the image

△ (Toward +)

: Colors become stronger.

▽ (Toward -)

: Colors become weaker.

NOISE REDUCT. Reducing the noise during long exposures

OFF	Noise is not reduced. Noise may be conspicuous at slow shutter speeds.
ON	Noise is reduced. Shooting time takes twice as long as usual. Shooting is not available during noise reduction. Noise reduction can only be used when the shutter speed is slower than 1/2 sec.

- This function may not work effectively with some shooting conditions or subjects.

TIMELAPSE Shooting pictures automatically as defined by set conditions

OFF	Timelapse shooting is deactivated.
ON	Timelapse shooting is activated.

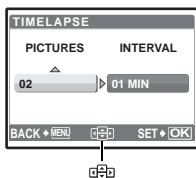

Number of shots: 2 to 99
Shooting interval: 1 to 99
minutes in 1 minute intervals

When setting the timelapse shooting

- Press \triangleleft to select [PICTURES] and [INTERVAL].
 - Press \triangleup / \triangledown to set the value.
 - Press \odot to set.
 - The first picture is taken when the shutter button is pressed, and the pictures thereafter are automatically taken.
 - During timelapse, the \odot mark lights on the monitor.
 - When recording to either the internal memory or the card, and after the first picture is taken, the camera enters sleep mode. The camera automatically reactivates from sleep mode 4 seconds prior to taking the next picture.
 - When the preset number of pictures is taken, the camera automatically turns off.
- If you will be taking pictures over a long period, make sure to use fully charged batteries or the AC adapter.
 - If any of the following operations occur during sleep mode, the camera cancels the timelapse mode and returns to normal shooting.
Opening the battery compartment cover, opening the card cover, connecting the camera to a computer, operating the shutter button, arrow pad or other button.
 - From 4 seconds prior to taking a picture until the time the picture has been taken, all operation buttons, the mode dial and zoom lever do not function.
 - If the internal memory/card becomes full or the battery power runs out during timelapse shooting, a warning is displayed, timelapse stops and the camera automatically turns off.

□ Shooting pictures with conversion lens

OFF /ON

Set this function when shooting with the camera using a conversion lens (option) specified by Olympus.

- Using the built-in flash with the conversion lens attached can cause vignetting. Use an external flash if required.
- When the conversion lens is attached, the camera may take some time to focus.

🎤 (movies) Recording sound with movies

OFF /ON

- If the camera is more than 1 m (3.3 ft.) away from the source of the sound, sound may not be recorded clearly.
- When \odot (movies) is set to [ON], [IMAGE STABILIZER] is not available.
- If [FULLTIME AF] is set to [ON] when \odot (movies) is set to [ON], the sound of operating lens may be recorded.

5 SILENT MODE

Setting to turn off operational sounds

OFF /ON

This function allows you to turn off operational sounds that occur during shooting and playback, warning beeps, shutter sounds, etc.



5 EDIT

- RAW DATA EDIT
- COLOR EDIT
- FRAME
- LABEL
- CALENDAR
- LAYOUT
- EXPRESSION EDIT
- FACE FOCUS
- INDEX
- EDIT
- MOVIE INDEX

When the still picture is selected

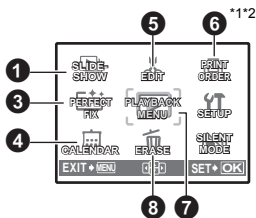

7 PLAYBACK MENU



- *1 A card is required.
- *2 This is not selected when the movie is selected.
- *3 This is not displayed when a movie is selected.
- *4 This is not displayed when the still picture is selected.

When the movie is selected

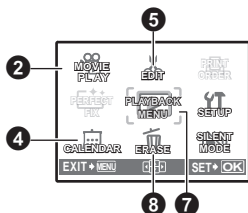

"SETUP menus" (P.41)

"SILENT MODE Setting to turn off operational sounds" (P.33)

- The factory default settings are displayed in gray ().

1 SLIDESHOW

Playing back pictures automatically

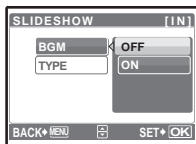

- Set music [BGM] to [ON] or [OFF].
- Select the transition effect between pictures from [TYPE].

BGM	ON	/OFF
TYPE	NORMAL	/SCROLL/FADER/ SLIDE/ZOOM DOWN/ZOOM UP/CHECKER BOARD/BLINDS/SWIVEL/RANDOM

- Only the first frame of each movie is displayed.
- After setting music [BGM] and [TYPE], press to start the slideshow.
- Press or **MENU** to cancel the slideshow.



Select [MOVIE PLAY] from the top menu, and press to play back the movie.

- Another option is to select a picture with the movie icon () in the playback mode, and press to play back the movie.

Operations during movie playback

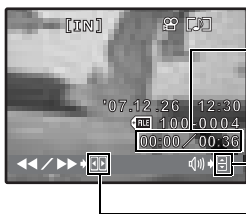

Playing time/Total recording time

- : Increases the volume.
- : Reduces the volume.
- : Each time you press the button, the playback speed changes in the following order: 2x; 20x and 1x.
- : Plays the movie in reverse. Each time you press the button, the playback speed changes in the following order: 1x; 2x; 20x; and back to 1x.

- Press to pause the playback.

Operations during pause



- : Displays the first frame.
- : Displays the last frame.
- : Displays the next frame.
- : Displays the previous frame.

- To resume the movie, press .
- To cancel the playback of the movie in the middle of it or during pause, press **MENU**.

3 PERFECT FIX

Continuous shooting

This function allows you to correct the taken picture and save it as a new picture.

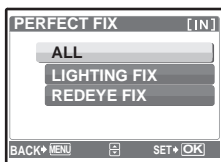

- Select the item to be corrected with Δ/∇ and press [OK] .
- Select the picture with $\triangleleft/\triangleright$ and press [OK] .

ALL	Lighting fix and red-eye fix are activated together.
LIGHTING FIX	Only the dark areas of an image are corrected. Underexposed areas caused by taking pictures against backlight or insufficient lighting are brightened.
REDEYE FIX	Only red-eye fix is activated.

- When red eye is not detected with [REDEYE FIX], press \triangleleft to cancel the correction.
- Movies, pictures shot by another camera, and previously fixed or edited pictures cannot be corrected.
- Pictures that have been corrected cannot be corrected when they are displayed.
- Some pictures may not be corrected completely.
- Editing an image may cause it to suffer a minor loss in quality.

4 CALENDAR

Playing back the pictures in a calendar format

This function lets you playback the pictures in a calendar format, organized by the date the images were recorded.

5 EDIT

This function lets you edit still pictures saved on a card and store them as new pictures.

RAW DATA EDIT Editing the pictures recorded in raw data format

Adjusts the pictures recorded in raw data format and stores them as new pictures in JPEG format. **Items that can be set with [RAW DATA EDIT].**

Item	Settings	Ref. Page
IMAGE QUALITY	SHQ/HQ/SQ1/SQ2/16 : 9	P.23
WB	AUTO/PRESET/ [WB] *	P.25
[WB]	RED7 - BLUE7	P.31
SHARPNESS	-5 - + 5	P.32
CONTRAST	-5 - + 5	P.32
SATURATION	-5 - + 5	P.32

* Available only when the picture is taken with [WB] set to [WB] .

..... Changing the size of pictures

640x480 / 320x240

This changes the image size of a picture and saves it as a new file.

..... Cropping a part of pictures

Designates and crops part of a still picture and saves it as a new file.



- Press \triangleleft or \triangleright to select the image to crop, and press MENU .
- Use the arrow pad and the zoom lever to set the position and size of the picture, and press MENU .

COLOR EDIT Changing the color of a picture

This function lets you change the color of a picture and save it as a new picture.



- Select the picture with \triangleleft or \triangleright and press MENU .
- Select your desired color with the arrow pad, and press MENU .

① BLACK & WHITE	This changes the picture to black and white.
② SEPIA	This changes the pictures to sepia.
③ SATURATION (HARD)	This increases the saturation of the picture.
④ SATURATION (SOFT)	This slightly increases the saturation of the picture.

FRAME Add a frame to your picture

This function lets you select a frame, integrate the frame with an image, and save it as a new picture.



- Select a frame with \triangleleft or \triangleright and press MENU .
- Select the picture to be synthesized with the frame with \triangleleft or \triangleright , and press MENU . (Press \triangle or ∇ to turn the picture 90 degrees clockwise or 90 degrees counterclockwise.)
- Use the arrow pad and the zoom lever to adjust the position and size of the picture, and press MENU .

LABEL Add a label to your picture

This function lets you select a label, integrate the label with an image, and save it as a new picture.



- Select the picture with \triangleleft or \triangleright and press MENU .
- Select the label with \triangleleft or \triangleright , and press MENU . (Press \triangle or ∇ to rotate the picture 90° clockwise or counterclockwise.)
- Use the arrow pad and the zoom lever to adjust the position and size of the label, and press MENU .
- Set the color of the label with the arrow pad, and press MENU .

CALENDAR Create a calendar print with your picture

This function lets you select a calendar format, integrate the calendar with a picture, and save it as a new file.

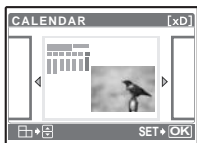

- Select the picture with $\triangleleft \triangleright$ and press MENU .
- Select the calendar with $\triangleleft \triangleright$, and press MENU . (Press $\triangle \nabla$ to rotate the picture 90° clockwise or counterclockwise.)
- Set the date of the calendar, and press MENU .

LAYOUT Creating an index layout of pictures

ALL IMAGES	All pictures in the internal memory or the card are added to the layout.
CALENDAR	A monthly calendar appears and the pictures you want to make layout are selected by the date.
SEL. IMAGE	Pictures that you want to make layout are specified one by one.

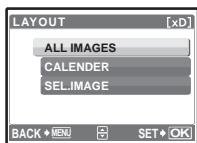

- Press $\triangleleft \triangleright$ to select a layout, and press MENU .
- Select the type of layout picture, and press MENU .
- Select the pictures and press MENU . (When [SEL. IMAGE] is selected in [LAYOUT] screen, press $\triangle \nabla$ to rotate the picture 90° clockwise or counterclockwise.)

EXPRESSION EDIT Transforming a face in the picture

This function lets you transform a face that is largest and facing front in the picture, and save it as a new picture.

- Select your desired effect with $\triangleleft \triangleright$ and press MENU .
- Use $\triangleleft \triangleright$ to select the desired effect, and press MENU .
- The face may not be detected correctly for some subjects.

FACE FOCUS Showing up a face in the picture

This function allows you to change the largest face that is facing the front and save it as a new picture.

- Select the picture with $\triangleleft \triangleright$ and press MENU .
- The face may not be detected correctly for some subjects.

INDEX Making an index picture from a movie

This function extracts 9 frames from a movie and saves them as a new picture (INDEX) containing thumbnails of each frame.



- Use $\triangleleft \triangleright$ to select a movie and press MENU .
- Use the arrow pad to select the first frame of the part you want to keep, and press MENU .
In the same manner, select the last frame of the part you want to keep and press MENU .

EDIT Extracting a part of the movie

Allows you to specify a part of the movie and overwrite it, or save it as a new movie.



- Select [NEW FILE] or [OVERWRITE], and press
- Use the arrow pad to select the first frame of the part you want to keep, and press . In the same manner, select the last frame of the part you want to keep and press .

MOVIE INDEX Capturing a still image from the movie

Allows you to capture a still image from the movie, which is taken and record in JPEG format.



- Use to select a movie and press .
- Use the arrow pad to select the frame to capture, and press .

6 PRINT ORDER

Making print reservations (DPOF)

This function allows you to save printing data (the number of prints and the date and time information) with the pictures stored on the card.

"Print settings (DPOF)" (P.52)

7 PLAYBACK MENU

..... Protecting pictures

OFF /ON



Protected pictures cannot be erased with [ERASE]/[SEL. IMAGE]/[ALL ERASE], but they are all erased by formatting.

- Select the picture with , and protect it by selecting [ON] with . You can protect several frames in succession. When a picture is protected, is displayed on the monitor.

..... Rotating pictures

+90°/ 0° /-90°

Pictures taken with the camera held vertically are displayed horizontally during playback. This function allows you to turn such pictures so that they are displayed vertically. New picture orientations are saved even when the power is turned off.

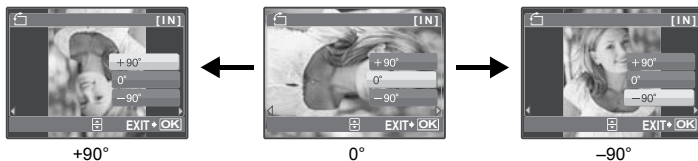

Select the picture with \triangleleft / \triangleright , and rotate it by selecting [+90°], [0°] or [-90°] with \triangleup / \triangledown . You can rotate several frames in succession.

INDEX PLAY Selecting the playback position of the movie



- Use the arrow pad to select a frame. Push or pull the zoom lever to change the number of displayed index frames.
- Press MENU . Movie playback begins from the selected frame.

MIC Adding sound to still pictures

YES / NO



- Sound is recorded for about 4 seconds.
- Use \triangleleft / \triangleright to select a picture, and use \triangleup / \triangledown to select [YES] to record.
 - The [BUSY] bar will be temporarily displayed.

8 ERASE Erase selected pictures/Erase all pictures

Protected pictures cannot be erased. Cancel protection before erasing protected pictures. Once erased, pictures cannot be restored. Check each picture before erasing to avoid accidentally erasing pictures you want to keep.

- When erasing the picture in the internal memory, do not insert the card into the camera.
- When erasing the picture from the card, insert a card into the camera in advance.

SEL. IMAGE Selecting images to erase



- Use the arrow pad to select a picture, and press MENU to add \checkmark .
- Press MENU again to cancel the selection.
- When the selection is completed, press HOME .
- Select [YES], and press MENU .

ALL ERASE Erase all the pictures in the internal memory and the card

- Select [YES], and press MENU .

SETUP menus

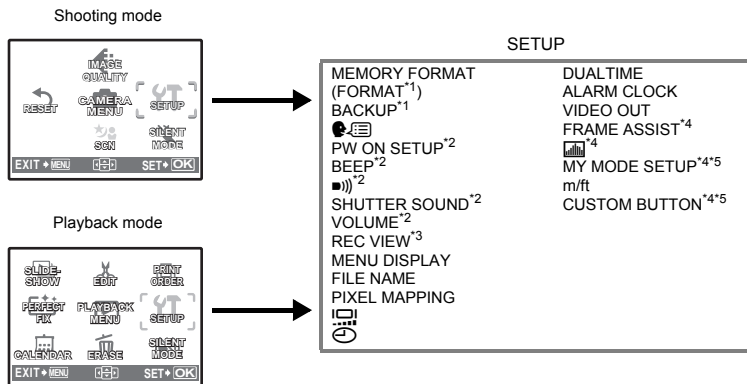

*1 A card is required.

*2 The sound is turned off regardless the setting when [SILENT MODE] is set to [ON].

*3 "SILENT MODE Setting to turn off operational sounds" (P.33)

*4 Not available when SCN is set to [UNDER WATER WIDE2].

*5 Not available when the mode dial is set to .

MEMORY FORMAT (FORMAT) Formatting the internal memory or card

All existing data, including protected pictures, are erased when the internal memory or card is formatted. Make sure that you save or transfer important data to a computer before formatting.

- Make sure there is no card inserted in the camera when formatting the internal memory.
- Be sure that the card is inserted in the camera when formatting the card.
- Before using non-Olympus cards or cards which have been formatted on a computer, you must format them with this camera.

BACKUP Copying pictures in the internal memory to the card

Insert the optional card into the camera. Copying data does not erase the picture in the internal memory.

- It takes some time to back up data. Check if the battery is not empty before starting the copy, or use the AC adapter.

..... Selecting a display language

You can select a language for on-screen display. Available languages vary depending on the area where you purchased this camera.

You can add other languages to your camera with the provided OLYMPUS Master software.

PW ON SETUP Setting the startup screen and sound

SCREEN	OFF (No picture is displayed.)	/	1	/	2
SOUND	OFF (No sound)	/	1	/	2

You can select the types of the sound and the picture displayed when the camera is turned on.

- Select [2] and press \triangleright to set the still picture saved in the internal memory or card as the startup screen.
- The volume turns to the value set in [VOLUME].

"VOLUME Adjusting the volume during playback" (P.42)

BEEP Adjusting the beep sound and volume when button is pressed

OFF (No sound)	
1	LOW / HIGH
2	LOW / HIGH

 Adjust the volume of camera warning sound

OFF (No sound) /	LOW / HIGH
------------------	------------

SHUTTER SOUND Selecting the sound and volume of the shutter button

OFF (No sound)	
1	LOW / HIGH
2	LOW / HIGH

VOLUME Adjusting the volume during playback

OFF (No sound)	/	1	/	2	/	3	/	4	/	5
----------------	---	---	---	---	---	---	---	---	---	---

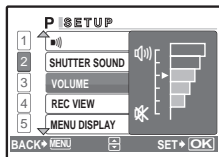

- Press \triangle / ∇ to adjust the volume.
- You can select [OFF] or adjust in 5 steps from 1-5.

REC VIEW Viewing pictures immediately

OFF	The picture being recorded is not displayed. This is useful when you want to prepare for your next shot while the previous picture is being recorded.
ON	The picture being recorded is displayed. This is useful when you want to quickly review the last picture taken. You can resume shooting while the picture is still being displayed.



Select [ON] to set whether to display the image on the monitor or viewfinder during recording.

LCD ONLY : Pictures that are being recorded will always be displayed on the menu on the monitor.

CURRENT : Pictures that are being recorded will be displayed on the viewfinder when the viewfinder is used and on the monitor when the monitor is used.

MENU DISPLAY Displaying menu display on the monitor

Perform next operation to set whether to display on the monitor or viewfinder.

- When **MENU** is pressed
- When  is pressed in the playback mode
- When  is pressed in the shooting mode
- When the camera is connected to the printer

LCD ONLY	This always displays the menu on the monitor.
CURRENT	This displays the menu on the viewfinder when the viewfinder is used and on the monitor when the monitor is used.

FILE NAME Resetting the file names of pictures

RESET	This method is useful when grouping files on separate cards. The file number and folder number are reset every time a new card is inserted in the camera. The folder number returns to [No. 100] and the file number returns to [No. 0001].
AUTO	This method is useful when you want to manage all your files with sequential numbers. Even if a new card is inserted, the folder number and file number are retained from the previous card. This helps you to manage multiple cards.

File names and their folder names for recorded pictures are automatically generated by the camera. File names and folder names respectively include file numbers (0001 to 9999) and folder names (100 to 999), and are named as follows.

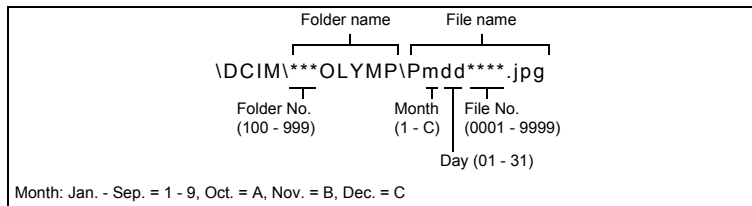

PIXEL MAPPING Adjusting the image processing function

The pixel mapping feature allows the camera to check and adjust the CCD and image processing functions. It is not necessary to operate this function frequently. Approximately once a year is recommended. Wait at least one minute after taking or viewing pictures to allow the pixel mapping function to perform properly. If you turn the camera off during pixel mapping, start again. Select [PIXEL MAPPING]. When [START] is displayed, press .



Adjusting the monitor brightness





- △ : Brightens the monitor.
 - ▽ : Darkens the monitor.
- Press  after setting is complete.



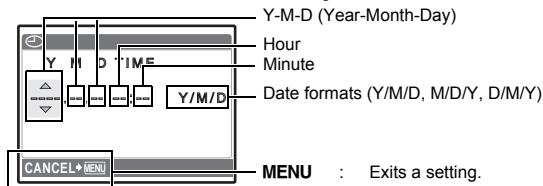

Setting the date and time

The date and time is saved with each image, and is used in the file name.



- The first two digits of the [Y] are fixed.
- The time is displayed in the 24-hour format.
- To set the time precisely, with the cursor at either "minute" or [Y/M/D], press  as the time signal strikes 00 seconds.

DUALTIME Setting the date and time in another time zone

OFF	Switches to the date and time set in  . Pictures are recorded with the date and time set in  .
ON	Switches to the date and time set in [DUALTIME]. When setting the dual time, select [ON], and then set the time. Pictures are recorded with the date and time set in [DUALTIME].

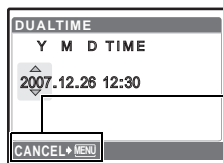

- The date format is the same as that set with .
- The first two digits of the [Y] are fixed.
- The time is displayed in the 24-hour format.

ALARM CLOCK Setting alarms

OFF	No alarm is set or alarm is canceled.
ONE TIME	Alarm is activated once. After the alarm goes off, the setting is canceled.
DAILY	Alarm is activated daily at the set time.

- When [☺] has not been set, [ALARM CLOCK] is not available.
- When [DUALTIME] is set to [ON], the alarm sounds according to the dual time date and time setting.

Setting an alarm

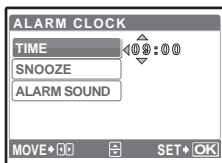

- Select [ONE TIME] or [DAILY], and set the alarm time.
- You can set snooze or alarm sounds and volume.

TIME	Sets the alarm time.	
SNOOZE	OFF	No snooze is set.
	ON	Alarm is activated every 5 minutes, up to 7 times.
ALARM SOUND	1	LOW/MID/HIGH
	2	LOW/MID/HIGH
	3	LOW/MID/HIGH

Operating, shutting off and checking the alarm

- Operating the alarm:
Turn off the camera. The alarm only operates when the camera is off.
- Shutting off the alarm:
While the alarm is sounding, press any button to shut off the alarm and turn off the camera. Note that pressing **POWER** will turn the camera on.
After 1 minute of no operation, the alarm stops automatically and the camera turns off when [SNOOZE] is set to [OFF].
- Checking the alarm settings:
While the camera is off, press **DISP./?** to display the set alarm time and the current time for 3 seconds.

VIDEO OUT **Playing back pictures on a TV**

NTSC / PAL

The factory default settings differ according to the region where the camera is sold.

To play back camera images on a TV, set the video output according to your TV's video signal type.

- TV video signal types by country/region. Check the video signal type before connecting the camera to the TV.

NTSC : North America, Taiwan, Korea, Japan

PAL : European countries, China

Playing back pictures on a TV

Turn off the camera and the TV before connecting.

Connect to the TV's video input (yellow) and audio input (white) terminals.

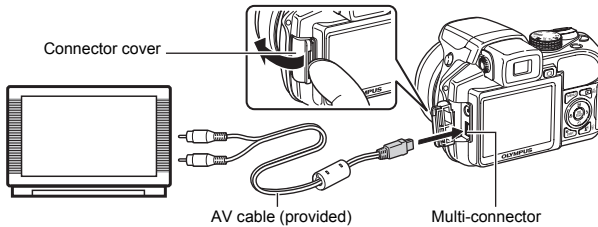

Settings on the TV

Turn the TV on, and set it to video input mode.

- For details of switching to video input, refer to your TV's instruction manual.
- Images and the information displayed on the screen may become cropped depending on the TV's settings.

Settings on the camera

Press **POWER** in playback mode to turn the camera on.

- The last picture taken is displayed on the TV. Use the arrow pad to select the picture you want to display.

FRAME ASSIST **Displaying the frame assist/Determining the type of frame assist**

OFF / [Grid Icon] / [Envelope Icon]

Press **DISP./[Info Icon]** in shooting mode to determine the type of frame assist to be displayed.

Selecting [OFF] or when pressing **DISP./[Info Icon]** will not display the frame assist.



..... **Displaying the histogram**

OFF / ON / DIRECT

Press **DISP./[Info Icon]** in shooting mode to determine whether to display the histogram.

- When set to [DIRECT], the black (blue) and white (red) areas are displayed directly on the picture.

MY MODE SETUP Setting and saving shooting-related functions

Types of my mode settings

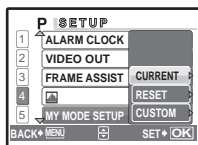

Select a MY MODE to save.

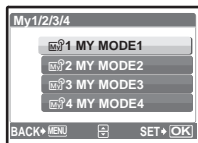

* Default settings are saved only in [1] MY MODE 1).

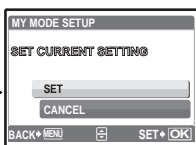
CURRENT

Saves the current camera settings.

- Select [SET], and press

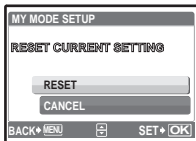
RESET

Restores the factory default settings.

- Select [RESET], and press
- My mode cannot be selected if no setting is saved.

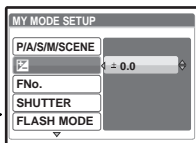
CUSTOM

Saves settings one by one.

- Select the item to save in my mode, and press or
- Change setting of the item, and press

"Functions that can be assigned to My Mode/custom button" (P.72)

m/ft Setting the measurement unit during manual focus

m	Displays in meters and centimeters.
ft	Displays in feet and inches.

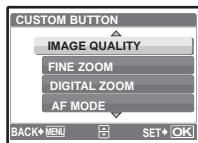
CUSTOM BUTTON Assigning functions to the custom buttons

Select the function to be registered with , , and press

"Functions that can be assigned to My Mode/custom button" (P.72)

Printing pictures

Direct printing (PictBridge)

Using the direct printing function

By connecting the camera to a PictBridge-compatible printer, you can print pictures directly - no computer necessary. Select the pictures you want to print and the number of prints using the camera's print menus.

To find out if your printer is compatible with PictBridge, refer to the printer's instruction manual.

What is PictBridge?

A standard for connecting digital cameras and printers of different makers and printing out pictures directly.

- Available printing modes, paper sizes etc., vary depending on the printer you use. Refer to the instruction manual for your printer.
- For details of printing paper types, ink cassettes, etc., refer to the printer's instruction manual.

Easy print

[EASY PRINT] can be used to print out the picture displayed on the monitor. The selected picture is printed using the standard settings of your printer. The date and file name are not printed.

STANDARD

All printers that support PictBridge have standard print settings. If [STANDARD] is selected on the settings screens (P.50 - P.51), pictures are printed according to these settings. Refer to the printer's instruction manual for its standard settings or contact the printer manufacturer.

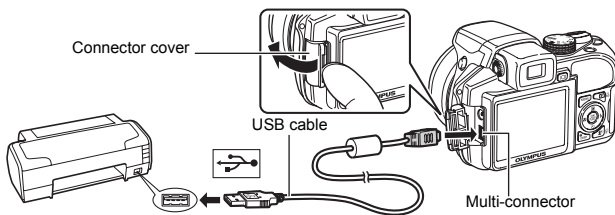

- 1 Display the picture you want to print out on the monitor in the playback mode.**
- 2 Turn the printer on and plug the USB cable (provided) into the camera's multi-connector and the printer's USB port.**



- The [EASY PRINT START] screen is displayed.
- For details of how to turn the printer on and the position of the USB port, refer to the printer's instruction manual.

3 Press .

- Printing starts.

- When printing is finished, the picture selection screen is displayed. To print another picture, press   to select a picture, and press .
- When you are finished, disconnect the USB cable from the camera with the picture selection screen displayed.



4 Disconnect the USB cable from the camera.

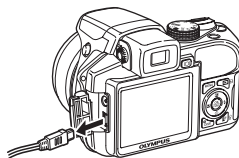

5 Disconnect the USB cable from the printer.

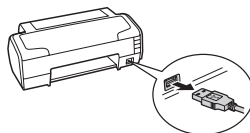

You can use [EASY PRINT] even when the camera is turned off or in shooting mode. With the camera turned off or in shooting mode, connect the USB cable. The selection screen for the USB connection is displayed. Select [EASY PRINT].

 "EASY PRINT" Step 3(P.49), "CUSTOM PRINT" Step 2(P.50)

Other print modes and print settings (CUSTOM PRINT)

1 Display the screen being indicated on the right according to the procedure 1 and 2 in P.48, and press .

2 Select [CUSTOM PRINT] and press .

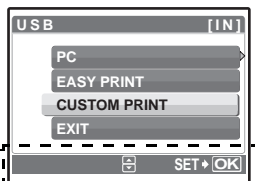

3 Follow the operation guide to adjust print settings.

Selecting a print mode

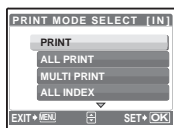

PRINT	Prints the selected picture.
ALL PRINT	Prints all the pictures stored in the internal memory or the card.
MULTI PRINT	Prints one picture in multiple layout format.
ALL INDEX	Prints an index of all the pictures stored in the internal memory or the card.
PRINT ORDER	Prints the pictures according to the print reservation data on the card. If no print reservations have been made, this option is not available.  "Print settings (DPOF)" (P.52)

Setting the print paper

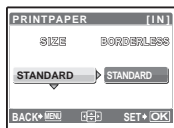

SIZE	Choose from the available paper sizes on your printer.
BORDERLESS	Select with or without borders. In [MULTI PRINT] mode, you cannot print with a border.
OFF <input type="checkbox"/>	The picture is printed inside a blank frame.
ON <input type="checkbox"/>	The picture is printed filling the entire page.
PICS/SHEET	Available in [MULTI PRINT] mode only. The number of prints that can be printed vary depending on the printer.

Note

- If the [PRINT PAPER] screen is not displayed, [SIZE], [BORDERLESS] and [PICS/SHEET] are set to the standard.

Selecting the picture to print



PRINT	Prints one copy of the selected picture. When [SINGLE PRINT] or [MORE] has been selected, a single copy or more copies are printed.
SINGLE PRINT	Makes a print reservation for the displayed picture.
MORE	Sets the number of prints and data to be printed for the displayed picture.

Press \triangleleft / \triangleright to select the picture you want to print. You can also use the zoom lever and select a picture from the index display.

Setting the number of prints and data to be printed

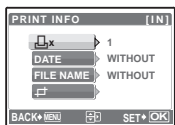

\times	Sets the number of prints. You can select up to 10 prints.
DATE(☉)	If you select [WITH], pictures are printed with the date.
FILE NAME(☐)	If you select [WITH], pictures are printed with the file name.
\triangleleft / \triangleright	Use the arrow pad or the zoom lever to adjust trimming size and position, and press ☉ . The trimmed picture is printed.

4 Select [PRINT] and press ☉ .

- Printing starts.
- When printing is finished, the [PRINT MODE SELECT] screen is displayed.

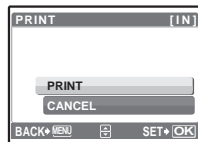

To cancel printing

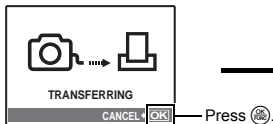

Press ☉ .

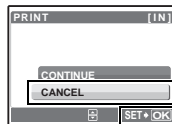

Select [CANCEL], and press ☉ .

Screen during data transfer

5 In the [PRINT MODE SELECT] screen, press MENU.

- A message is displayed.

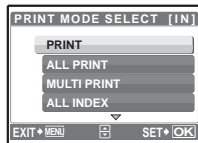

6 Disconnect the USB cable from the camera.

7 Disconnect the USB cable from the printer.

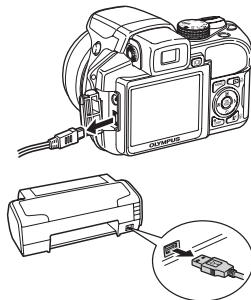

Print settings (DPOF)

How to make print reservations

Print reservation allows you to save printing data (the number of prints and the date and time information) with the pictures stored on the card. With print reservation, you can print out pictures easily either at home using a personal DPOF-compatible printer or at a photo store that supports DPOF. DPOF is a standard format used to record automatic print information from digital cameras.

Only the images stored on the card can be reserved to print. Insert a card with recorded pictures into the camera before making print reservations.

Pictures with print reservations can be printed using the following procedures.

Printing using a DPOF-compatible photo store.

You can print the pictures using the print reservation data.

Printing using a DPOF-compatible printer.

Printing is possible directly from a card containing print reservation data, without using a computer. For more details, refer to the printer's instruction manual. A PC card adapter may also be necessary.

Note

- DPOF reservations set by another device cannot be changed by this camera. Make changes using the original device. If a card contains DPOF reservations set by another device, entering reservations using this camera may overwrite the previous reservations.
- You can make DPOF print reservations for up to 999 images per card.
- Not all functions may be available on all printers, or at all photo stores.

To use print services without using DPOF

- Pictures stored in the internal memory cannot be printed at a photo store. The pictures need to be copied to a card before taking them.
📄 "BACKUP Copying pictures in the internal memory to the card" (P.41)

Single-frame reservation

Follow the operation guide to make a print reservation for a selected picture.

1 Press **MENU** in the playback mode and display the top menu.

2 Select **[PRINT ORDER]** ▶ **[]**, and press **[]**.

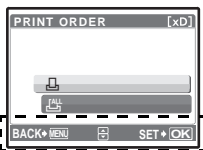

3 Press **[]** to select the frames for print reservations, and then press **[]** to set the number of prints.

- You cannot make print reservations for pictures with **[]**.
- Repeat Step 3 to make print reservations for other pictures.

To trim the picture

- Use the zoom lever to display the trimming line.
- Use the arrow pad or the zoom lever to adjust trimming size and position, and press **[]**.



4 When you finish making print reservations, press **[]**.

5 Select the date and time print setting, and press **[]**.

- NO The pictures are printed without the date and time.
DATE The selected pictures are printed with the shooting date.
TIME The selected pictures are printed with the shooting time.

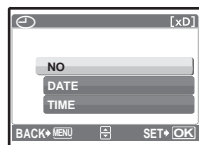

6 Select **[SET]** and press **[]**.

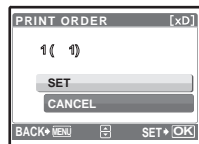

All-frame reservation

Reserves all the pictures stored on the card. The number of prints is set at one print per picture.

1 Press MENU in the playback mode and display the top menu.

2 Select [PRINT ORDER] ▸ [ALL], and press .

3 Select the date and time setting, and press .

NO The pictures are printed without the date and time.

DATE All pictures are printed with the shooting date.

TIME All pictures are printed with the shooting time.

4 Select [SET], and press .

Resetting print reservation data

You can reset all the print reservation data or just for selected pictures.

1 Select top menu ▸ [PRINT ORDER], and press .

To reset the print reservation data for all the pictures

2 Select [□] or [ALL], and press .

3 Select [RESET] and press .

To reset the print reservation data for a selected picture

2 Select [□], and press .

3 Select [KEEP], and press .

4 Press ◀▶ to select the picture with the print reservations you want to cancel, and press ▼ to decrease the number of prints to 0.

• Repeat Step 4 to cancel print reservations for other pictures.

5 When you are finished canceling print reservations, press .

6 Select the date and time setting, and press .

• The setting is applied to the remaining pictures with print reservations.

7 Select [SET], and press .

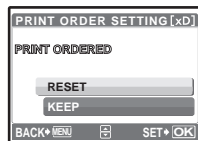

Using OLYMPUS Master

Overview

Using the USB cable provided with your camera, you can connect the camera and computer and download (transfer) the images to your computer using the OLYMPUS Master software, also provided with the camera.

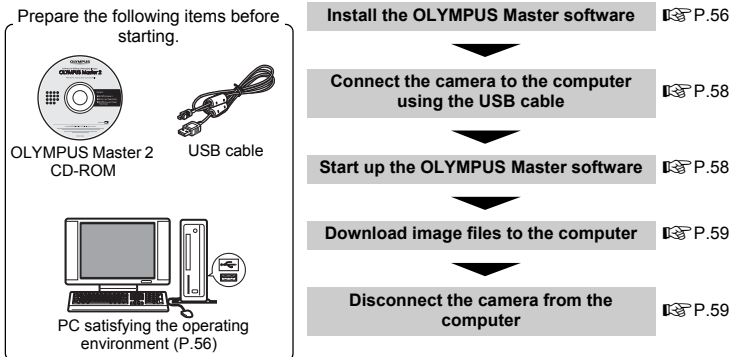

Using OLYMPUS Master

What is OLYMPUS Master?

OLYMPUS Master is a software application for managing your digital images on your computer. Installing it on your computer lets you do the following:

- **Download images from the camera or other media**
- **View images and movies**
 - You can run a slideshow and play back sound.
- **Manage images**
 - Manage images in an album or folder. Downloaded images are automatically sorted by date, allowing you to search for images quickly.
- **Edit images**
 - You can rotate images, trim them and change the size.
- **Edit images with the filter and correction functions**

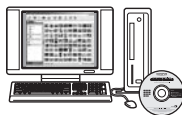

- **Print images**
 - You can easily print images.
- **Make panoramic images**
 - You can make panoramic images using pictures taken in panorama mode.
- **Update the version of your camera's firmware.**

For details of other functions and operations, refer to the "Help" guide in the OLYMPUS Master reference manual.

Install the OLYMPUS Master software

Before installing the OLYMPUS Master software, please confirm that your computer is compatible with the following system requirements.

For newer operating systems, please refer to the Olympus web site as shown on the back cover of this manual.

Operating environment

Windows

OS	Windows 2000 Professional/XP Home Edition/ XP Professional/Vista
CPU	Pentium III 500 MHz or later
RAM	256 MB or more
Hard disk capacity	500 MB or more
Monitor	1,024 × 768 pixels or more 65,536 colors or more (16.77 million colors or more recommended)
Other	USB port or IEEE 1394 port Internet Explorer 6 or later QuickTime 7 or later recommended DirectX 9 or later recommended

Note

- **Windows 98/98SE/Me are not supported.**
- Use a computer with a pre-installed operating system. Operations are not guaranteed on home-built computers or computers with an updated operating system.
- Operations are not guaranteed when using an added USB port or IEEE 1394 port.
- To install the software, you must log on as a user with administrators' privileges.

Macintosh

OS	Mac OS X v10.3 or later
CPU	Power PC G3 500 MHz or later Intel Core Solo/Duo 1.5 GHz or later
RAM	256 MB or more
Hard disk capacity	500 MB or more
Monitor	1,024 × 768 pixels or more 32,000 colors or more (16.77 million colors or more recommended)
Other	USB port or IEEE 1394 port (FireWire) Safari 1.0 or later (1.3 or later recommended) QuickTime 6 or later

Note

- **Mac versions earlier than OS X 10.3 are not supported.**
- Operations are not guaranteed when using an added USB or IEEE 1394 (FireWire) port.
- To install the software, you must log on as a user with administrators' privileges.
- Be sure to remove the media (drag & drop onto the trash icon) before performing the following operations. Failure to do so could result in unstable computer operation and the need to reboot.
 - Disconnect the cable connecting the camera to the computer
 - Turn off the camera
 - Open the camera's battery compartment cover/card cover

Windows

1 Insert the CD-ROM into the CD-ROM drive.

- The OLYMPUS Master setup screen is displayed.
- If the screen is not displayed, double-click the "My Computer" icon and click the CD-ROM icon.

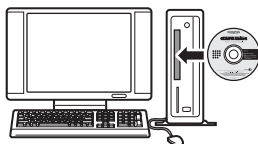

2 Select the display language and click the "OLYMPUS Master 2" button.

- When the component installation screen is displayed, click "OK".



3 Click "Next" and follow the on-screen instructions.

- When the OLYMPUS Master licensing agreement is displayed, read the agreement and click "Yes" to proceed with the installation.

4 When the user information screen is displayed, enter your "Name", select your "Region" and click "Next".



5 When the setup type selection screen is displayed, click "Install".

- To select the components to install, select "Custom".
- The installation begins. The screen confirming that setup is completed is displayed. Click "Close".
- Next, the screen confirming whether to install OLYMPUS muvee theaterPack Trial Version is displayed. To install this software, click "Install".

Macintosh

1 Insert the CD-ROM into the CD-ROM drive.

- The CD-ROM window is displayed.
- If the CD-ROM window is not displayed, double-click the CD-ROM icon on the desktop.

2 Double-click the "Setup" icon on the desktop.

- The OLYMPUS Master installation screen is displayed.
- Follow the on-screen instructions.
- When the OLYMPUS Master licensing agreement is displayed, read the agreement and click "Continue" and then "Continue" to proceed with the installation.
- The screen confirming that installation is completed is displayed.
- You must restart your computer before using OLYMPUS Master.



Connecting the camera to a computer

1 Make sure the camera is turned off.

- The monitor is off.
- The lens is retracted.

2 Connect the multi-connector on the camera to the USB port on the computer using the provided USB cable.

- Refer to your computer's instruction manual to locate the position of the USB port.
- The camera turns on automatically.
- The monitor turns on and the selection screen for the USB connection is displayed.

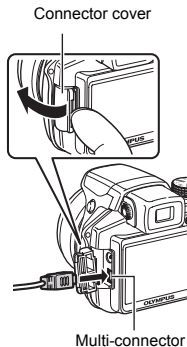

3 Select [PC] and press .

4 The camera is recognized by the computer.

• Windows

When you connect the camera to your computer for the first time, the computer attempts to recognize the camera. Click "OK" to exit the message that is displayed. The camera is recognized as a "Removable Disk".

• Macintosh

The iPhoto program is the default application for managing digital images. When you connect your digital camera for the first time, the iPhoto application starts automatically, so close this application and start OLYMPUS Master.

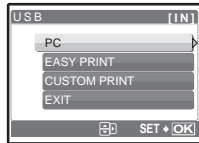

Note

- The camera functions are disabled while the camera is connected to a computer.
- Connecting the camera to a computer via a USB hub may cause unstable operation. In this case, do not use a hub, but connect the camera directly to the computer.
- Images cannot be transferred to your computer with OLYMPUS Master if [PC] is selected in Step 3,  is pressed and [MTP] is selected.

Start up the OLYMPUS Master software

Windows

1 Double-click the "OLYMPUS Master 2" icon on the desktop.

Macintosh

1 Double-click the "OLYMPUS Master 2" icon in the "OLYMPUS Master 2" folder.

- The browse window is displayed.
- When OLYMPUS Master is started up for the first time after installation, the OLYMPUS Master initial setting screen and user registration screen are displayed before the browse window. Follow the on-screen instructions.

To exit OLYMPUS Master

1 Click “Exit”  on any window.

- OLYMPUS Master is exited.

Displaying camera images on a computer

Downloading and saving images

1 Click “Transfer Images”  on the browse window, and then click “From Camera” .

- The window for selecting the pictures you want to transfer from the camera is displayed. All the images in the camera are displayed.

2 Select “New Album” and enter an album name.

3 Select the image files and click “Transfer Images”.

- A window indicating that the download is complete is displayed.

4 Click “Browse images now”.

- The downloaded images are displayed in the browse window.



To disconnect the camera

1 Make sure that the card access lamp has stopped blinking.

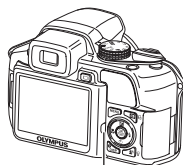

Card access lamp

2 Make the following preparations for disconnecting the USB cable.

Windows

- ① Click the “Unplug or Eject Hardware” icon  in the system tray.
- ② Click the message that is displayed.
- ③ When a message is displayed saying that the hardware can be ejected safely, click “OK”.

Macintosh

- ① The trash icon changes to the eject icon when the “Untitled” or “NO_NAME” icon on the desktop is dragged. Drag and drop it on the eject icon.

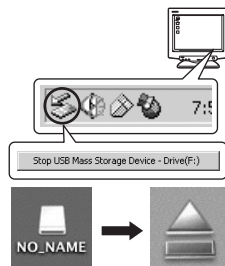

3 Disconnect the USB cable from the camera.

! Note

- Windows: When you click "Unplug or Eject Hardware", a warning message may be displayed. Make sure that image data is not being downloaded from the camera and that all applications are closed. Click the "Unplug or Eject Hardware" icon again and disconnect the cable.

Viewing still pictures and movies

1 Click the "Album" tab on the browse window and select the album that you want to view.

- The selected album image is displayed in the thumbnail area.

2 Double-click the still picture thumbnail that you want to view.

- OLYMPUS Master switches to the image edit window and the picture is enlarged.
- Click "Back"  to return to the browse window.



To view a movie

1 Double-click the movie thumbnail that you want to see in the browse window.

- OLYMPUS Master switches to the edit window and the first frame of the movie is displayed.

2 To play back the movie, click "Play" at the bottom of the screen.



To download and save images to a computer without using OLYMPUS Master

This camera is compatible with USB mass storage. You can connect the camera to your computer using the USB cable provided with the camera to download and save images without using OLYMPUS Master. The following environment is required to use the USB cable to connect the camera to your computer.

Windows : Windows 2000 Professional/XP Home Edition/
XP Professional/Vista

Macintosh : Mac OS X v10.3 or later

Note

- If your computer is running Windows Vista, you can select [PC] in Step 3 on page 58, press \triangleright , and select [MTP] to use Windows Photo Gallery.
- Data transfer is not guaranteed in the following environments, even if your computer is equipped with a USB port.
 - Computers with a USB port added by means of an extension card, etc.
 - Computers without a factory-installed OS and home-built computers

To increase the number of languages

Please take care that your battery is fully charged!

- 1 Make sure that your computer is connected to the Internet.**
- 2 Plug the USB cable into the USB port on the computer.**
- 3 Plug the other end of the USB cable into the camera's USB connector.**
 - The camera turns on automatically.
 - The monitor turns on and the selection screen for the USB connection is displayed.
- 4 Select [PC], and press \odot .**
- 5 In the browse window, select "Camera", then "Update Camera/Add Display Language".**
 - The confirmation window for updating is displayed.
- 6 Click "OK".**
 - The updating the camera window is displayed.
- 7 Click "Add Language" in the updating camera display.**
 - The "Add Display Language of Camera" window is displayed.
- 8 Click \triangleright and select a language.**
- 9 Click "Add".**
 - The new language is downloaded to your camera.
Please do not remove any cable or the battery while the camera is processing.
- 10 After the download procedure the camera display will show "OK". You can remove the cables and turn power off. After restarting the camera you will be able to choose the new language from [SETUP].**



Getting to know your camera better

Shooting tips and information

Tips before you start taking pictures

The camera does not turn on even when the batteries are loaded

The direction of the batteries is incorrect.

- Insert the batteries in the correct direction.

The battery power is exhausted

- Insert new batteries. When using rechargeable batteries, charge the batteries.

The battery is temporarily unable to function because of the cold

- Battery performance declines in low temperatures, and the charge may not be sufficient to turn on the camera. Remove the battery and warm it by putting it in your pocket for a while.

The camera is connected to a computer

- The camera will not operate while it is connected to a computer.

The card cannot be used

- If the contact area of the card is contaminated, data in the card cannot be read and the [CARD SETUP] screen may appear. In this case, select [xD CARD CLEAN], press , remove the card, and then wipe the contact area with a soft dry cloth.

No picture is taken when the shutter button is pressed

The camera is in sleep mode

- To save battery power, the camera automatically goes into sleep mode and the monitor turns off if there is no operation for 3 minutes when the camera is turned on (when the lens is extended and the monitor is on). No picture is taken even if the shutter button is fully pressed in this mode. Operate the zoom lever or other buttons to restore the camera from sleep mode before taking a picture. If the camera is further left for 12 minutes, it automatically turns off (the lens retracts and the monitor turns off). Press the **POWER** to turn the camera on.

The mode dial is set to

- This is the playback mode for displaying pictures on the monitor. Set the mode dial to a shooting mode.

The mode dial is set to **GUIDE**

- No pictures can be taken when the shooting guide is being displayed. Take a picture after making the settings following the shooting guide, or turn the mode dial and set it to the position other than **GUIDE** in the shooting mode.

The flash is charging

- Wait until  (flash charge) stops blinking before taking the picture.

The camera's internal temperature increases

- With prolonged camera use, the internal temperature may increase, resulting in automatic shutdown. If this occurs, remove the battery from the camera and wait until the camera has sufficiently cooled. The camera's external temperature may also increase during use, however this is normal and does not indicate malfunction.

The memory gauge is full

- No pictures can be taken when the memory gauge is full. Wait until there is space in the memory gauge.

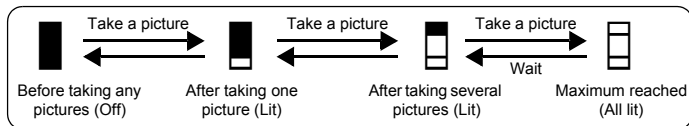

The viewfinder does not turn on

The monitor is turned on

- Press  to switch to the viewfinder.

The monitor does not turn on

The viewfinder is turned on

- Press  to switch to the monitor.

The viewfinder or monitor is hard to see

There is condensation* inside the camera

- Turn the camera off. Before turning it on again, wait until the camera adjusts to the surrounding temperature and dries out.
 - * When it is cold outside, the water vapor in the air is rapidly cooled and turns to droplets of water. Condensation occurs when the camera is suddenly taken from a cold place into a warm room.

Vertical lines appear on the monitor screen during shooting



- Aiming the camera at a bright subject in sunlight may cause vertical lines to appear on the screen. This is not a malfunction.

The viewfinder is not properly adjusted

- Rotate the diopter adjustment dial slightly and adjust.
 "Adjusting the viewfinder's focus using the diopter" (P.9)

The date and time have not been set

The camera has been used in the same conditions from the time of purchase

- No date and time have been set for the camera at the time of purchase. Set the date and time before using the camera.
 "Turn the camera on" (P.6)
 "Setting the date and time" (P.44)

The battery has been pulled out of the camera.

- The date and time settings will be returned to the factory default settings if the camera is left without batteries for approximately 3 days. In addition, if the batteries are inserted in the camera for a short period, the date and time settings will be returned to the factory default settings more quickly. Before taking important pictures, check that the date and time settings are correct.

Shooting tips

Focusing on the subject

There are several ways to focus, depending on the subject.

When the subject is not in the center of the frame

- Place the subject in the center of the frame, lock the focus on the subject, and then recompose your picture.
- Set [AF MODE] to [AREA].
 "AF MODE Changing the focusing area" (P.28)

The subject is moving quickly

- Focus the camera on a point roughly the same distance away as the subject you want to shoot and lock the focus (by pressing the shutter button halfway). Then recompose your picture and press the shutter button completely as the subject enters the frame.
- Set the mode dial to **S** to set the shutter speed, and then take the picture. Setting a fast shutter speed lets you capture fast-moving subjects as though they were standing still.
 "**S** Changing the shutter speed for shooting pictures" (P.12)

The subject is dark.

- Set [AF ILLUMINAT.] to [ON].
 "AF ILLUMINAT. Setting to light the illuminator in a dark place" (P.29)

Subjects that are difficult to focus on

- Under certain types of conditions, it is difficult to focus using auto focus. The green lamp on the monitor lights, allowing you to check if the focus is locked.

The green lamp blinks.
The subject cannot be brought into focus.



Subject with low contrast



Subject with an extremely bright area in the center of the frame

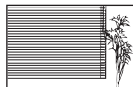

Subject without vertical lines

The green lamp lights, but the subject cannot be brought into focus.



Subjects at different distances

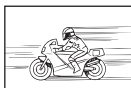

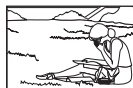

Fast-moving subject



The subject is not in the center of the frame

In these cases, focus (focus lock) on an object with high contrast at the same distance as the intended subject, recompose your shot and then take the picture. If the subject has no vertical lines, hold the camera vertically and focus the camera using the focus lock function by pressing the shutter button halfway, and then return the camera to the horizontal position while keeping the button pressed halfway and take the picture.

Prevent blur by using image stabilization

Be sure to hold the camera firmly with both hands and press the shutter button slowly so as to avoid moving the camera. To correct the digital image, take pictures with  pressed and set  ON]. Pictures are more likely to be blurry when:

- images are shot at a high-magnification zoom setting, i.e. using both optical zoom and digital zoom functions,
- the object is dark and the shutter speed is slow, or
- the flash cannot be used or when a low shutter speed set **SCN** mode is selected.

Taking stabilized pictures without the flash

To take pictures in low light places without flash, set the following after setting the flash mode to  (Flash off).

Increase the [ISO] setting

 "ISO Changing the ISO sensitivity" (P.26)

The picture is too grainy

There are several factors that can cause the picture to appear grainy.

Using the digital zoom to take close-up pictures

- With the digital zoom, part of the image is cropped and enlarged. The greater the magnification, the grainier the picture appears.

 "DIGITAL ZOOM Zooming in on your subject" (P.28)

Increasing the ISO sensitivity







- When you increase the [ISO] setting, "noise", which appears as spots of unwanted color or unevenness in the color, can be introduced and give the picture a grainy appearance. This camera is equipped with a function to allow shooting at high sensitivity while suppressing noise; however, increasing the ISO sensitivity creates grainier pictures than when using a lower sensitivity.

 "ISO Changing the ISO sensitivity" (P.26)





Taking pictures with the correct color

- The reason why there are differences between the colors in a picture and the actual colors taken and the actual color is the light source illuminating the subject. [WB] is the function that allows the camera to determine the correct colors. Normally, the [AUTO] setting provides the optimal white balance, but depending on the subject, it may be better to experiment with changing the [WB] setting.
 - When the subject is in the shade on a sunny day
 - When the subject is illuminated by both natural light and indoor lighting, such as when near a window
 - When there is no white in the center of the frame
- ☞ "WB Adjusting the color of a picture" (P.25)
- ☞ "[WB] Adjusting the white balance compensation" (P.31)

Taking pictures of a white beach or snow scene

- Take pictures with  or  in **SCN** mode. Suitable for taking pictures on a sunny day at the beach or in the snow.
- ☞ "**SCN** Shoot pictures by selecting a scene according to the situation" (P.13)
- Often, bright subjects (such as snow) turn out darker than their natural colors. Adjust   toward [+] to make these subjects closer to their real shades. Conversely, when you are shooting dark subjects, it can be effective to adjust toward the [-]. Sometimes, using the flash may not produce the brightness (exposure) that was intended.
- ☞ "  button Changing picture brightness(Exposure compensation)" (P.19)

Taking pictures of a subject against backlight

- When [SHADOW ADJ. ON] is selected, the face of the subject will appear brighter even against backlight. This function is also effective when shooting indoor pictures from outdoor.
- ☞ "Shooting mode: Brightening the subject against backlight" (P.18)
- With [METERING] set to , the picture can be taken based on the brightness of the subject in the AF target mark area without being affected by the light in the background.
- ☞ "METERING Changing the area for measuring the brightness of a subject" (P.28)
- Set the flash to  (Fill-in flash) to activate fill-in-flash. You can shoot a subject against backlight without the face of the subject appearing dark.  (Fill-in flash) is effective for shooting against backlight and under fluorescent and other artificial lighting.
- ☞ " button Flash shooting" (P.19)
- With [AF MODE] set to [FACE DETECT], the face of the subject will be given due exposure even against backlight and it will appear brighter.
- ☞ "AF MODE Changing the focusing area" (P.28)

When the subject is too bright or too dark

- When taking pictures in **S** mode or **A** mode, the shutter speed or aperture setting may be displayed in red. A red display means that the correct exposure cannot be obtained. If you take the picture as is, the picture will appear too bright or too dark. In this case, use the arrow pad to change the settings.
- ☞ "**A** Changing the aperture value for shooting pictures" (P.12)
- ☞ "**S** Changing the shutter speed for shooting pictures" (P.12)

Additional shooting tips and information

Increasing the number of pictures that can be taken

There are two ways to record the pictures you take with this camera.

Recording pictures to the internal memory

- Pictures are recorded to the internal memory, and when the number of storable still pictures reaches 0, you must connect the camera to a computer to download the pictures, and then erase the pictures from the internal memory.

Using a card (optional)

- Pictures are recorded to the card when inserted in the camera. When the card is full, download the pictures to a computer, and then either erase the pictures from the card or use a new card.
 - Pictures are not recorded to the internal memory when a card is inserted in the camera. Pictures in the internal memory can be copied to the card using the [BACKUP] function.
-  "BACKUP Copying pictures in the internal memory to the card" (P.41)
"The card" (P.78)

Number of storable still pictures and recording length of movies

Still pictures

Record mode	Image size		Number of storable still pictures				
			Internal memory		Using a 1GB card		
			With sound	Without sound	With sound	Without sound	
RAW	3264x2448		4	4	85	86	
SHQ	3264x2448		12	12	253	255	
	3:2	3264x2176	13	13	284	286	
HQ	3264x2448		23	23	492	499	
	3:2	3264x2176	26	26	551	561	
SQ1	2560x1920	HIGH	19	19	404	410	
		NORMAL	36	37	770	789	
	2304x1728	HIGH	23	23	492	499	
		NORMAL	43	45	927	954	
	2048x1536	HIGH	29	29	615	627	
		NORMAL	54	56	1142	1184	
SQ2	1600x1200	HIGH	45	46	954	984	
		NORMAL	82	86	1728	1827	
	1280x960	HIGH	65	68	1390	1453	
		NORMAL	112	121	2369	2558	
	1024x768	HIGH	94	101	1998	2132	
		NORMAL	151	168	3198	3553	
	640x480	HIGH	233	275	4920	5814	
		NORMAL	379	505	7995	10660	
	16 : 9	1920x1080	NORMAL	60	63	1279	1332

Movie

IMAGE QUALITY	Image size	Sequential recording length			
		Internal memory		Using a 1GB card	
		With sound	Without sound	With sound	Without sound
SHQ	640x480 (30 frames/sec.)	26 sec.	26 sec.	40 sec.	40 sec.
HQ	320x240 (15 frames/sec.)	2 min. 22 sec.	2 min. 26 sec.	29 min.	29 min.
SQ	160x120 (15 frames/sec.)	9 min. 28 sec.	10 min. 44 sec.	29 min.	29 min.



Using a new card

- If you use a non-Olympus card or a card used for another application, such as for a computer, use [FORMAT] function to format the card.

 "MEMORY FORMAT (FORMAT) Formatting the internal memory or card" (P.41)

Lamp indicators

This camera uses several lamps to indicate the camera status.

Lamp	Status
Self-timer lamp	<p>When set to  12 SEC] The lamp lights for approximately 10 seconds, blinks for approximately 2 seconds, and then the picture is taken.</p> <p>When set to  2 SEC] The lamp blinks for approximately 2 seconds, and then the picture is taken.</p> <p>When set to [SMILE SHOT] Lit: Camera is ready Blinking: The flash is charging (shooting not available)</p>
Card access lamp	<p>Blinking: An image or movie is being recorded or downloaded (when connected to a computer).</p> <ul style="list-style-type: none">Do not do any of the following while the card access lamp is blinking. Doing so may prevent the image data from being saved and render the internal memory or card unusable.<ul style="list-style-type: none">Open the battery compartment cover/card cover.Removing the battery and card.Connect or disconnect the AC adapter.Disconnect the USB cable
Green lamp of the monitor	<p>Lit: The focus and exposure are locked. Blinking: The focus is not locked.</p> <ul style="list-style-type: none">Release your finger from the shutter button, re-position the AF target mark on the subject and press the shutter button halfway again.

Extending the useful life of the battery

- Performing any of the following operations when not actually taking pictures can deplete the battery power.
 - The shutter button is pressed halfway repeatedly in shooting mode, activating the auto focus and digital image stabilization.
 - Using the zoom repeatedly.
 - [FULLTIME AF] is set to [ON].
 - The monitor is left on for an extended period of time.
 - The camera is connected to a computer or printer.

Functions that cannot be selected from menus/buttons

- Some items may not be selectable from the menus when using the arrow pad. (The menu is grayed out and cannot be selected)
 - Items that cannot be set with the current shooting mode
 - Items that cannot be set because of an item that has already been set:
 - When [FOCUS MODE] is set to [MF], [AF MODE] cannot be selected.
 - Items that cannot be set because the pictures taken by other camera will be edited.
- Some items cannot be set when the button is pressed.
 and [FLASH].
- Some functions cannot be used when there is no card in the camera.
PANORAMA/PRINT ORDER/FORMAT/BACKUP

Selecting the appropriate image quality

Image quality is a combination of desired image size and compression level. Use the following examples to help determine the optimal record mode when shooting.

To edit and process images on a computer

- [RAW]

To make high quality prints on full-size paper such as A3 (16.5 × 11.7 in.)/To edit and process images on a computer

- [SHQ] [HQ]

To print on full-size paper

- [SQ1]

To print on A5 (8.3 × 5.8 in.) paper and below/ To send as an e-mail attachment or post on a web site

- [SQ2]



To express the broadness of a subject such as landscapes/To view pictures on a wide-screen television.

- [16 : 9]

 "IMAGE QUALITY Changing the image quality" (P.23)

Restoring default settings

- This camera retains a part of the settings even after the power is turned off. To return the settings to default settings, execute [RESET].

When the mode dial is set to **P**, **A**, **S**, **M** or : the settings are retained even after the power is turned off (except for the settings of , PANORAMA and TIMELAPSE shootings).

When the mode dial is set to **AUTO** or **SCN**: the settings return to default (except for IMAGE QUALITY and IMAGE STABILIZER).

 "RESET Change the shooting functions back to default settings" (P.24)

Confirming the exposure when the monitor is difficult to see outdoors

The monitor may be difficult to see (and the exposure difficult to confirm) when shooting under bright light.

Press **DISP./Q** repeatedly to display the histogram

- Set the exposure so that the graph is concentrated on the outer edges and the graph is balanced on both sides.

How to read the histogram

- ① If the peak fills too much of the frame, the image will appear mostly black.
- ② If the peak fills too much of the frame, the image will appear mostly white.
- ③ The part indicated in green in the histogram shows the luminance distribution within the AF target mark.

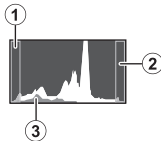

 "**DISP./Q** button Changing the information on display/Display the menu guide/Checking the time" (P.17)

Using the viewfinder

 "[] button Monitor/Viewfinder" (P.17)

Playback help and troubleshooting tips

The red-eye cannot be fixed.

- Depending on the picture, certain red-eyes may not be correctable. Also, areas other than the eyes may be wrongly corrected.

Playback tips

Playing back the picture in the internal memory

- When a card has been inserted in the camera, the picture in the internal memory cannot be played back. Turn off the camera and remove the card to playback pictures stored in the camera's internal memory.

Understanding the settings and other information of pictures taken

- Play back a picture, and press **DISP./** . Press **DISP./** repeatedly to change the amount of information displayed.
-  **DISP./** button Changing the information on display/Display the menu guide/Checking the time" (P.17)

Quickly displaying a desired picture

- Push the lever toward W to view the pictures as thumbnails (index display) or in a calendar format (calendar display).
-  "Zoom Lever Zooming while shooting/close-up playback" (P.15)

Erasing sound recorded to still pictures

- Once sound is added to a picture, it is not possible to erase the sound. In this case, make a re-recording with silence. Sound recording is not possible if there is insufficient space in the internal memory or on the card.
-  "Adding sound to still pictures" (P.40)

Viewing pictures on a computer

Viewing the entire picture on a computer screen

The size of the picture displayed on a computer screen changes depending on the computer settings. When the monitor setting is 1024x768 and you are using Internet Explorer to view a picture with an image size of 2048x1536 at 100 %, the entire picture cannot be viewed without scrolling. There are several ways you can view the entire picture on the computer screen.











View the picture using image browsing software







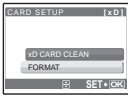

- Install the OLYMPUS Master 2 software from the provided CD-ROM.

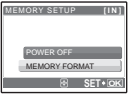
Change the monitor setting

- The icons on the computer desktop may be rearranged. For details of changing the settings on your computer, refer to the computer's instruction manual.

When you get an error message on the camera

Monitor indication	Possible cause	Corrective action
 CARD ERROR	There is a problem with the card.	This card cannot be used. Insert a new card.
 WRITE PROTECT	Writing to the card is prohibited.	The recorded image has been protected (read-only) on a computer. Download the image to a computer and cancel the read-only setting.
 MEMORY FULL	The internal memory has no available memory and cannot store any new data.	Insert a card or erase unwanted data. Before erasing, backup the data of important pictures onto the card, or download such pictures to a computer.
 CARD FULL	The card has no available memory and cannot store any new data.	Replace the card or erase unwanted data. Before erasing, download important pictures to a computer.
 NO PICTURE	There are no pictures in the internal memory or on the card.	The internal memory or the card contains no pictures. Record pictures.
 PICTURE ERROR	There is a problem with the selected picture and it cannot be played back on this camera.	Use image processing software to view the picture on a computer. If that cannot be done, the image file is damaged.
 THE IMAGE CANNOT BE EDITED	If pictures taken by other cameras are selected, they cannot be edited.	Use image processing software to edit the pictures.
 CARD-COVER OPEN	The card cover is open.	Close the card cover.
 BATTERY EMPTY	The battery is empty.	Insert new batteries. When using rechargeable batteries, charge the batteries.
Recording has stopped to allow camera to cool. Please wait a moment.	When [IMAGE STABILIZER] is set to [ON], the camera's internal temperature rises due to continuous movie recording for a long period, thereby causing shooting to stop.	Allow the camera to cool down for some time before you begin shooting again. Or you can shoot with [IMAGE STABILIZER] set to [OFF].
Camera is cooling. Please wait a moment.		
	Data in the card cannot be read. Or, the card is not formatted.	<ul style="list-style-type: none"> Select [xD CARD CLEAN], and press . Remove the card and wipe the contact area with a soft dry cloth. Select [FORMAT] ▶ [YES] and press . All data on the card is erased.

Monitor indication	Possible cause	Corrective action
	There is an error in the internal memory.	Select [MEMORY FORMAT] ▶ [YES] and press  . All data in the internal memory is erased.
 NO CONNECTION	The camera is not connected to the computer or printer correctly.	Disconnect the camera and connect it again correctly.
 NO PAPER	There is no paper in the printer.	Load some paper in the printer.
 NO INK	The printer has run out of ink.	Replace the ink cartridge in the printer.
 JAMMED	The paper is jammed.	Remove the jammed paper.
SETTINGS CHANGED	The printer's paper tray has been removed or the printer has been operated while changing settings on the camera.	Do not operate the printer while changing settings on the camera.
 PRINT ERROR	There is a problem with the printer and/or camera.	Turn off the camera and printer. Check the printer and remedy any problems before turning the power on again.
 CANNOT PRINT	Pictures recorded on other cameras may not be printed on this camera.	Use a computer to print.

Functions that can be assigned to My Mode/custom button

Function	MY MODE SETUP	CUSTOM BUTTON	Ref. Page
P/A/S/M/SCENE	✓	—	P.6
	✓	—	P.19
FNo.	✓	—	P.12
SHUTTER	✓	—	P.12
FLASH MODE	✓	—	P.19
	✓	—	P.19
	✓	—	P.20
	✓	—	P.18
MONITOR (I/O) ^{*1}	✓	—	P.17
ZOOM ^{*2}	✓	—	—
IMAGE STABILIZER	✓	✓ (default)	P.16
AE LOCK	—	✓	P.16
AF LOCK	—	✓	P.16
AF LOCK + AE LOCK	—	✓	P.16
IMAGE QUALITY	✓	✓	P.23
WB	✓	—	P.25
ISO	✓	—	P.26
DRIVE	✓	—	P.27
FINE ZOOM	✓	✓	P.27
DIGITAL ZOOM	✓	✓	P.28
METERING	✓	—	P.28
AF MODE	✓	✓	P.28
FOCUS MODE	✓	✓	P.29
FULLTIME AF	✓	✓	P.29
AF PREDICT	✓	✓	P.29
AF ILLUMINAT.	✓	—	P.29
	✓	—	P.30
	✓	✓	P.30
	✓	✓	P.30
 (still pictures)	✓	✓	P.30
PANORAMA	✓	—	P.31
	✓	—	P.31
SHARPNESS	✓	—	P.32
CONTRAST	✓	—	P.32
SATURATION	✓	—	P.32
NOISE REDUCT.	✓	✓	P.32
TIMELAPSE	✓	—	P.33
 (conversion lens)	✓	—	P.33
INFO	✓	—	P.17
FRAME ASSIST	✓	—	P.46
	✓	—	P.46

*1 Set whether to use the monitor or viewfinder.



*2 For [ZOOM], select from 27 mm, 50 mm, 150 mm, 300 mm or 486 mm. (These numbers are based on the focal length of a 35 mm camera.)

Functions available in shooting modes and scene modes

Some functions cannot be set in certain shooting modes. For more details, refer to the table below. In **[M7]** mode, available functions vary depending on the modes set in the [MY MODE SETUP] menu. In **SCN** mode, in order to produce specialized effects, some scenes limit control of certain functions. Those functions are indicated with an . For details, refer to "Functions with restrictions in shooting scenes" (P.74).

● Modes and shooting functions









Function	Shooting mode	AUTO	P	A	S	M	SCN		Ref. Page
		Flash mode	AUTO	✓	✓	✓	—	—	
		✓	✓	✓	—	—		—	P.19
		✓	✓	✓	✓	✓		—	P.19
		✓	✓	✓	✓	✓		—	P.19
		✓	✓	✓	—	—		—	P.19
		✓	✓	✓	✓	✓		—	P.19
		✓	✓	✓	✓	—	✓	✓	P.19
Aperture value		—	—	✓	—	✓	—	—	P.11
Shutter speed		—	—	—	✓	✓	—	—	P.12
		✓	✓	✓	✓	✓		✓	P.19
		✓	✓	✓	✓	✓		✓	P.19
		✓	✓	✓	✓	✓		✓	P.20
INFO		✓	✓	✓	✓	✓	✓	—	P.17
Optical zoom		✓	✓	✓	✓	✓		✓ ^{*1}	P.28
IMAGE STABILIZER		✓	✓	✓	✓	✓	✓	✓	P.16
AE LOCK		—	✓	✓	✓	—		—	P.16
AF LOCK		—	✓	✓	✓	✓		—	P.16
AF LOCK + AE LOCK		—	✓	✓	✓	—		—	P.16
		✓	✓	✓	✓	✓		✓	P.18
IMAGE QUALITY		✓ ^{*2}	✓	✓	✓	✓		✓	P.23
WB		—	✓	✓	✓	✓	✓	✓	P.25
ISO		—	✓	✓	✓	✓ ^{*3}		—	P.26
DRIVE		—	✓	✓	✓	✓ ^{*4}		—	P.27
FINE ZOOM		—	✓	✓	✓	✓		—	P.27
DIGITAL ZOOM		—	✓	✓	✓	✓		✓	P.28

*1 When  (movies) is set to [ON], optical zoom cannot be used during the shooting. To zoom in when  (movies) is set to [ON], set [DIGITAL ZOOM] to [ON].

*2 [RAW] is not available.

*3 [AUTO] and [HIGH ISO AUTO] are not available.













*4 [BKT] is not available.















Function	Shooting mode								Ref. Page
	AUTO	P	A	S	M	SCN			
METERING	—	✓	✓	✓	✓	✓	✓	P.28	
AF MODE	—*5	✓	✓	✓	✓		—	P.28	
FOCUS MODE	—	✓	✓	✓	✓		—	P.29	
FULLTIME AF	—	✓	✓	✓	✓		✓	P.29	
AF PREDICT	—	✓	✓	✓	✓		—	P.29	
AF ILLUMINAT.	—	✓	✓	✓	✓		—	P.29	
	—	✓	✓	✓	✓		—	P.30	
 SYNCRO	—	✓	✓	✓	✓		—	P.30	
 FLASH	—	✓	✓	✓	✓		—	P.30	
 (still pictures)	—	✓	✓	✓	✓		—	P.30	
PANORAMA	—	✓	—	—	—		—	P.31	
 WB	—	✓	✓	✓	✓	✓	✓	P.31	
SHARPNESS	—	✓	✓	✓	✓	✓	✓	P.32	
CONTRAST	—	✓	✓	✓	✓	✓	✓	P.32	
SATURATION	—	✓	✓	✓	✓	✓	✓	P.32	
NOISE REDUCT.	—	✓	✓	✓	✓*6		—	P.32	
TIMELAPSE	—	✓	✓	✓	✓		—	P.33	
 (conversion lens)	—	✓	✓	✓	✓		✓	P.33	
 (movies)	—	—	—	—	—		✓	P.33	

*5 This is fixed at [IESP].

*6 This is fixed at [ON] during bulb shooting.

● Functions with restrictions in shooting scenes



Function	Scene									Ref. Page
										
	✓	✓	✓	✓	✓	✓	✓	✓	✓	P.20
Flash mode	✓	✓	✓	—	✓	—	—	—	—	P.19
	✓	—	—	✓	—	—	—	✓	✓	P.19
 s	✓	—	—	✓	—	—	—	✓	✓	P.19
Optical zoom	✓	✓	✓	✓	—	✓	✓	✓	—	—
AE LOCK	✓	✓	✓	✓	✓	✓	✓	✓	✓	P.16
AF LOCK	✓	✓	✓	✓	✓	✓	—	✓	✓	P.16
AF LOCK + AE LOCK	✓	✓	✓	✓	✓	✓	—	✓	✓	P.16
 *	✓	✓	—	—	✓	✓	—	✓	✓	P.18
IMAGE QUALITY	✓ ¹	✓ ¹	✓ ¹	✓ ²	✓ ¹	✓ ¹	✓ ¹	✓ ¹	✓ ¹	P.23
ISO	—	—	—	—	—	—	—	—	—	P.26
DRIVE	✓ ³	✓ ³	—	—	✓ ³	—	—	✓ ³	✓ ³	P.27

Function \ Scene	Scene									Ref. Page
										
FINE ZOOM	✓		✓	✓	—	—	✓	✓	✓	P.27
DIGITAL ZOOM	✓		✓	✓	—	—	✓	✓	✓	P.28
AF MODE	✓		✓	✓	✓	— ^{*4}	✓	—	✓	P.28
FOCUS MODE	✓		✓	✓	✓	✓	✓	—	✓	P.29
FULLTIME AF	✓		✓	✓	✓	✓	✓	—	✓	P.29
AF PREDICT	✓		✓	✓	✓	✓	✓	—	✓	P.29
AF ILLUMINAT.	✓		✓	✓	✓	✓	✓	—	—	P.29
	✓		✓	✓	—	✓	—	—	—	P.30
 SYNCRO	✓		✓	✓	—	✓	—	—	—	P.30
 FLASH	✓		✓	✓	—	✓	—	—	—	P.30
 (still pictures)	✓		✓	✓	✓	✓	✓	✓	✓	P.30
PANORAMA	✓		✓	✓	✓	✓	✓	✓	✓	P.31
NOISE REDUCT.	—		—	— ^{*5}	—	—	—	— ^{*5}	—	P.32
TIMELAPSE	✓		✓	—	✓	✓	✓	✓	✓	P.33
 (conversion lens)	✓		✓	✓	✓	✓	✓	✓	✓	P.33

Function \ Scene	Scene									Ref. Page
					 1	 2				
	✓	✓	✓	✓	✓	✓	✓	—	✓	P.20
Flash mode	—	—	—	✓ ^{*6}	✓	✓ ^{*7}	✓ ^{*8}	✓ ^{*8}	✓ ^{*7}	P.19
	✓	— ^{*9}	✓	✓	✓	—	— ^{*9}	✓	✓	P.19
 s	✓	—	✓	✓	✓	—	—	—	—	P.19
Optical zoom	✓	✓	✓	✓	✓	—	✓	✓	✓	—
AE LOCK	✓	✓	✓	✓	✓	✓	✓	✓	—	P.16
AF LOCK	✓	✓	✓	✓	✓	—	✓	—	— ^{*10}	P.16
AF LOCK + AE LOCK	✓	✓	✓	✓	✓	—	✓	—	— ^{*10}	P.16
 [*]	✓	✓	✓	✓	✓	✓	✓	✓	✓	P.18

*1 [RAW] is not available.



*2 [IMAGE QUALITY] is limited to below [2048x1536].



*3 [] and [] are not available.

*4 This is fixed at [IESP].

*5 This is fixed at [ON].

*6 [] (Red-eye reduction flash) and [] (Red-eye fill-in flash) are not available.

*7 Setting is disabled when using [] or [].

*8 Only [] (Fill-in flash) or [] (Flash off) is available.

*9 This is fixed at [] (Macro mode).

*10 Setting is enabled [FULLTIME AF] is [OFF].

Scene Function										Ref. Page
IMAGE QUALITY	✓*1	—*10	✓*2	✓*1	✓*1	✓*1	✓*1	✓*11	✓*11*12	P.23
ISO	—	—	—	—	✓	✓	✓	—	—	P.26
DRIVE	✓*7	—*13	—*14	—*15	✓*16	✓*16	✓*16	✓*17	✓	P.27
FINE ZOOM	✓	✓	—	✓	✓	—	✓	—	✓*7	P.27
DIGITAL ZOOM	✓	✓	—	✓	✓	—	✓	—	✓*7	P.28
AF MODE	✓	✓	✓	✓*18	✓	—	✓*18	✓*19	✓	P.28
FOCUS MODE	✓	—	✓	—	✓	—	—	—	—	P.29
FULLTIME AF	✓	✓	✓	✓	✓	—	✓	—*5	✓	P.29
AF PREDICT	✓	—	✓	✓	✓	—	—	—	—	P.29
AF ILLUMINAT.	✓	✓	✓	✓	—	—	—	✓	✓	P.29
	—	—	—	✓	✓	✓	✓	✓	✓	P.30
SYNCRO	—	—	—	✓	✓	✓	✓	✓	✓	P.30
FLASH	—	—	—	✓	✓	✓	✓	✓	✓	P.30
(still pictures)	✓	—	—	—	—	—	—	—	✓	P.30
PANORAMA	✓	—	—	—	✓	✓	✓	—	✓	P.31
NOISE REDUCT.	—	—	—	—	—	—	—	—	✓	P.32
TIMELAPSE	✓	—	—	—	✓	✓	✓	—	✓	P.33
(conversion lens)	✓	—	✓	✓	✓	✓	—	✓	✓	P.33

*1 [RAW] is not available.

*2 [IMAGE QUALITY] is limited to below [2048x1536].

*5 This is fixed at [ON].

*6 [] (Red-eye reduction flash) and [] (Red-eye fill-in flash) are not available.

*7 Setting is disabled when using [] or [].

*10 [IMAGE QUALITY] is fixed at [640x480] in [SQ2].

*11 [IMAGE QUALITY] is limited to below [1280x960].

*12 [IMAGE QUALITY] is limited to below [2048x1536] when [] is set, and below [1280x960] when [] is set.

*13 This is fixed at [BKT].

*14 This is fixed at [].

*15 This is fixed at [].

*16 [] and [] are not available.

*17 This is fixed at [].

*18 [FACE DETECT] is not available.

*19 This is fixed at [FACE DETECT].

Camera care

Cleaning the camera

Exterior:

- Wipe gently with a soft cloth. If the camera is very dirty, soak the cloth in mild soapy water and wring well. Wipe the camera with the damp cloth and then dry it with a dry cloth. If you have used the camera at the beach, use a cloth soaked in clean water and wrung well.

Monitor and viewfinder:

- Wipe gently with a soft cloth.

Lens

- Blow dust off the lens with a commercial blower, then wipe gently with a lens cleaner.



Note

- Do not use strong solvents such as benzene or alcohol, or chemically treated cloth.
- Mold may form on the lens surface if the lens is left dirty.

Storage

- When storing the camera for extended periods, remove the battery, AC adapter and card, and keep in a cool, dry place that is well ventilated.
- Periodically insert the battery and test the camera functions.



Note

- Avoid leaving the camera in places where chemical products are handled since this may result in corrosion.

Battery Handling Precautions

- In addition to the batteries provided with the camera, the following types of battery can be used. Choose the power source best suited to the situation.
 - AA alkaline batteries**
The number of pictures that you can take may vary considerably depending on the battery manufacturer and shooting conditions.
 - AA NiMH batteries (rechargeable batteries)**
Olympus NiMH batteries are rechargeable and economical. For details, refer to the instruction manual for your charger.
- **Lithium battery pack (CR-V3) and manganese (zinc-carbon) batteries cannot be used.**
- Power consumption by the camera varies depending on which functions are used.
- Power is consumed continuously during the conditions described below causing batteries to become exhausted quickly.
 - The zoom is used repeatedly.
 - The shutter button is pressed halfway repeatedly in shooting mode, activating the auto focus and digital image stabilization.
 - Set [FULLTIME AF] to [ON].
 - The monitor is left on for an extended period of time.
 - The camera is connected to a computer or printer.
- Battery life varies depending on the type of battery, manufacturer, shooting conditions, etc. Similarly, the camera may turn off without displaying the battery level warning or may display the battery level warning more quickly.

Useful use of the accessories

The card

Pictures can be recorded on the optional card.

The internal memory and card are the camera's media for recording pictures, similar to film in a film camera.

Pictures recorded to the internal memory or card can be easily erased on the camera or processed using a computer.

Unlike portable storage media, the internal memory cannot be removed or exchanged.

The number of recordable pictures can be increased by using a card with a larger capacity.

- ① Index area
You can use this space to note down the contents of the card.
- ② Contact area
The part where the data transferred from the camera enters the card. Do not touch this part with your hands.

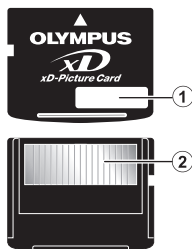

Compatible cards

xD-Picture Card (16 MB - 2 GB) (TypeH/M, Standard)

Using the internal memory or card

You can confirm on the monitor whether the internal memory or card is being used during shooting and playback operations.



Memory indicator

[IN] : When internal memory is used.

[xD] : When the card is used.

! Note

- Do not open the battery compartment cover and card cover while the card access lamp is blinking as data reading and writing is in progress. Doing so may damage the data in the internal memory or the card and render the internal memory or card unusable.

AC adapter

An AC adapter is useful for time-consuming tasks such as image downloads to a computer or when running a slideshow for a long period of time.

Do not use any other AC adapter with this camera.

! Note

- Do not remove or load the battery or connect or disconnect the AC adapter or the multi-adapter while the camera is turned on. Doing so could affect the camera's internal settings or functions.
- Be sure to read the instruction manual for the AC adapter.

Using your AC adapter abroad

- The AC adapter can be used in most home electrical sources within the range of 100 V to 240 V AC (50/60Hz) around the world. However, depending on the country or area you are in, the AC wall outlet may be shaped differently and the AC adapter may require a plug adapter to match the wall outlet. For details, ask at your local electrical shop or travel agent.
- Do not use travel voltage converters as they could damage your AC adapter.

SAFETY PRECAUTIONS

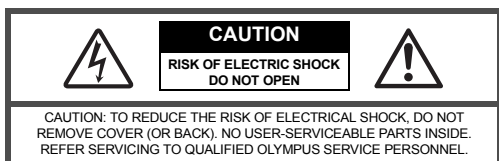

An exclamation mark enclosed in a triangle alerts you to important operating and maintenance instructions in the documentation provided with the product.



DANGER

If the product is used without observing the information given under this symbol, serious injury or death may result.



WARNING

If the product is used without observing the information given under this symbol, injury or death may result.



CAUTION

If the product is used without observing the information given under this symbol, minor personal injury, damage to the equipment, or loss of valuable data may result.

WARNING!

TO AVOID THE RISK OF FIRE OR ELECTRICAL SHOCK, NEVER DISASSEMBLE, EXPOSE THIS PRODUCT TO WATER OR OPERATE IN A HIGH HUMIDITY ENVIRONMENT.

General Precautions

Read All Instructions — Before you use the product, read all operating instructions. Save all manuals and documentation for future reference.

Cleaning — Always unplug this product from the wall outlet before cleaning. Use only a damp cloth for cleaning. Never use any type of liquid or aerosol cleaner, or any type of organic solvent to clean this product.

Attachments — For your safety, and to avoid damaging the product, use only accessories recommended by Olympus.

Water and Moisture — For precautions on products with weatherproof designs, read the weatherproofing sections.

Location — To avoid damage to the product, mount the product securely on a stable tripod, stand, or bracket.

Power Source — Connect this product only to the power source described on the product label.

Lightning — If a lightning storm occurs while using an AC adapter, remove it from the wall outlet immediately.

Foreign Objects — To avoid personal injury, never insert a metal object into the product.

Heat — Never use or store this product near any heat source such as a radiator, heat register, stove, or any type of equipment or appliance that generates heat, including stereo amplifiers.

Handling the Camera



WARNING

- Do not use the camera near flammable or explosive gases.
- Do not use the flash and LED on people (infants, small children, etc.) at close range.
 - You must be at least 1 m (3 ft.) away from the faces of your subjects. Firing the flash too close to the subject's eyes could cause a momentary loss of vision.

- **Keep young children and infants away from the camera.**
 - Always use and store the camera out of the reach of young children and infants to prevent the following dangerous situations which could cause serious injury:
 - Becoming entangled in the camera strap, causing strangulation.
 - Accidentally swallowing the battery, cards or other small parts.
 - Accidentally firing the flash into their own eyes or those of another child.
 - Accidentally being injured by the moving parts of the camera.
- **Do not look at the sun or strong lights with the camera.**
- **Do not use or store the camera in dusty or humid places.**
- **Do not cover the flash with a hand while firing.**

CAUTION

- **Stop using the camera immediately if you notice any unusual odors, noise, or smoke around it.**
 - Never remove the batteries with bare hands, which may cause a fire or burn your hands.
- **Never hold or operate the camera with wet hands.**
- **Do not leave the camera in places where it may be subject to extremely high temperatures.**
 - Doing so may cause parts to deteriorate and, in some circumstances, cause the camera to catch fire. Do not use the charger or AC adapter if it is covered (such as a blanket). This could cause overheating, resulting in fire.
- **Handle the camera with care to avoid getting a low-temperature burn.**
 - When the camera contains metal parts, overheating can result in a low-temperature burn. Pay attention to the following:
 - When used for a long period, the camera will get hot. If you hold on to the camera in this state, a low-temperature burn may be caused.
 - In places subject to extremely cold temperatures, the temperature of the camera's body may be lower than the environmental temperature. If possible, wear gloves when handling the camera in cold temperatures.
- **Be careful with the strap.**
 - Be careful with the strap when you carry the camera. It could easily catch on stray objects - and cause serious damage.

Battery Handling Precautions

Follow these important guidelines to prevent batteries from leaking, overheating, burning, exploding, or causing electrical shocks or burns.

DANGER

- Use only the Olympus brand NiMH batteries and proper fitting charger.
- Never heat or incinerate batteries.
- Take precautions when carrying or storing batteries to prevent them from coming into contact with any metal objects such as jewelry, pins, fasteners, etc.
- Never store batteries where they will be exposed to direct sunlight, or subjected to high temperatures in a hot vehicle, near a heat source, etc.
- To prevent causing battery leaks or damaging their terminals, carefully follow all instructions regarding the use of batteries. Never attempt to disassemble a battery or modify it in any way, solder, etc.
- If battery fluid gets into your eyes, flush your eyes immediately with clear, cold running water and seek medical attention immediately.
- Always store batteries out of the reach of small children. If a child accidentally swallows a battery, seek medical attention immediately.

WARNING

- Keep batteries dry at all times.
- To prevent batteries from leaking, overheating, or causing a fire or explosion, use only batteries recommended for use with this product.
- Never mix batteries (old and new batteries, charged and uncharged batteries, batteries of different manufacture or capacity, etc.).
- Never attempt to charge alkaline, lithium or CR-V3 lithium battery packs.
- Insert the battery carefully as described in the operating instructions.
- Do not use batteries if their body is not covered by the insulating sheet or if the sheet is torn, as this may cause fluid leaks, fire, or injury.

CAUTION

- Do not remove batteries immediately after using the camera. Batteries may become hot during prolonged use.
- Always unload the battery from the camera before storing the camera for a long period.

• The following AA (R6) batteries cannot be used.

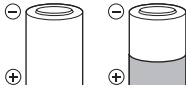

Batteries whose bodies are only partially or not at all covered by an insulating sheet.



Batteries whose - terminals are raised, but not covered by an insulating sheet.

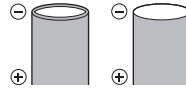

Batteries whose terminals are flat and not completely covered by an insulating sheet. (Such batteries cannot be used even if the - terminals are partially covered.)

- If NiMH batteries are not charged within the specified time, stop charging them and do not use them.
- Do not use a battery if it is cracked or broken.
- If a battery leaks, becomes discolored or deformed, or becomes abnormal in any other way during operation, stop using the camera.
- If a battery leaks fluid onto your clothing or skin, remove the clothing and flush the affected area with clean, running cold water immediately. If the fluid burns your skin, seek medical attention immediately.
- Never subject batteries to strong shocks or continuous vibration.

Caution for Usage Environment

- To protect the high-precision technology contained in this product, never leave the camera in the places listed below, no matter if in use or storage:
 - Places where temperatures and/or humidity are high or go through extreme changes. Direct sunlight, beaches, locked cars, or near other heat sources (stove, radiator, etc.) or humidifiers.
 - In sandy or dusty environments.
 - Near flammable items or explosives.
 - In wet places, such as bathrooms or in the rain. When using products with weatherproof designs, read their manuals as well.
 - In places prone to strong vibrations.
- Never drop the camera or subject it to severe shocks or vibrations.
- When mounted on a tripod, adjust the position of the camera with the tripod head. Do not twist the camera.
- Do not touch electric contacts on cameras.
- Do not leave the camera pointed directly at the sun. This may cause lens or shutter curtain damage, color failure, ghosting on the CCD, or may possibly cause fires.
- Do not push or pull severely on the lens.
- Before storing the camera for a long period, remove the batteries. Select a cool, dry location for storage to prevent condensation or mold from forming inside the camera. After storage, test the camera by turning it on and pressing the shutter button to make sure that it is operating normally.
- Always observe the operating environment restrictions described in the camera's manual.

Battery Handling Precautions

- Olympus NiMH batteries (included in some areas) are intended for use only with Olympus digital cameras. Never use these batteries with any other device.
- Always charge NiMH batteries (included in some areas) before using them for the first time, or if they have not been used for a long period.
- Always charge sets of batteries (included in some areas) (2 or 4) together.

- Do not use alkaline batteries unless it is absolutely necessary. In some cases, alkaline batteries may have a shorter service life than NiMH. Alkaline battery performance is limited, especially at low temperatures. The use of NiMH batteries is recommended.
- AA manganese (Zinc-Carbon) batteries cannot be used with this camera.
- When operating the camera with battery power at low temperatures, try to keep the camera and spare batteries as warm as possible. Batteries which run down at low temperatures may be restored after they are warmed at room temperature.
- Recommended temperature ranges for NiMH batteries:
 Operation0°C to 40°C (32°F to 104°F)
 Charge0°C to 40°C (32°F to 104°F)
 Storage.....-20°C to 30°C (-4°F to 86°F)
- Using, charging, or storing the batteries outside these ranges could shorten battery life or affect battery performance. Always unload the batteries from the camera before storing the camera for a long period.
- Before using NiMH or NiCd batteries, always read the provided instructions.
- The number of pictures you can take may vary depending on the shooting conditions or batteries.
- Before going on a long trip, and especially before traveling abroad, purchase an ample supply of extra batteries. The recommended batteries may be difficult to obtain while traveling.
- Please recycle batteries to help save our planet's resources. When you throw away dead batteries, be sure to cover their terminals and always observe local laws and regulations.

LCD Monitor

- Do not push the monitor forcibly; otherwise the image may become vague, resulting in a playback mode failure or damage to the monitor.
- A strip of light may appear on the top/bottom of the monitor, but this is not a malfunction.
- When a subject is viewed diagonally in the camera, the edges may appear zigzagged on the monitor. This is not a malfunction; it will be less noticeable in playback mode.
- In places subject to low temperatures, the LCD monitor may take a long time to turn on or its color may change temporarily. When using the camera in extremely cold places, it is a good idea to occasionally place it in a warm place. An LCD monitor exhibiting poor performance due to low temperatures will recover in normal temperatures.
- The LCD used for the monitor is made with high-precision technology. However, black spots or bright spots of light may appear constantly on the LCD Monitor. Due to its characteristics or the angle at which you are viewing the monitor, the spot may not be uniform in color and brightness. This is not a malfunction.

Legal and Other Notices

- Olympus makes no representations or warranties regarding any damages, or benefit expected by using this unit lawfully, or any request from a third person, which are caused by the inappropriate use of this product.
- Olympus makes no representations or warranties regarding any damages or any benefit expected by using this unit lawfully which are caused by erasing picture data.

Disclaimer of Warranty

- Olympus makes no representations or warranties, either expressed or implied, by or concerning any content of these written materials or software, and in no event shall be liable for any implied warranty of merchantability or fitness for any particular purpose or for any consequential, incidental or indirect damages (including but not limited to damages for loss of business profits, business interruption and loss of business information) arising from the use or inability to use these written materials or software or equipment. Some countries do not allow the exclusion or limitation of liability for consequential or incidental damages, so the above limitations may not apply to you.
- Olympus reserves all rights to this manual.

Warning

Unauthorized photographing or use of copyrighted material may violate applicable copyright laws. Olympus assumes no responsibility for unauthorized photographing, use or other acts that infringe upon the rights of copyright owners.

Copyright Notice

All rights reserved. No part of these written materials or this software may be reproduced or used in any form or by any means, electronic or mechanical, including photocopying and recording or the use of any type of information storage and retrieval system, without the prior written permission of Olympus. No liability is assumed with respect to the use of the information contained in these written materials or software, or for damages resulting from the use of the information contained therein. Olympus reserves the right to alter the features and contents of this publication or software without obligation or advance notice.

FCC Notice

- Radio and Television Interference

Changes or modifications not expressly approved by the manufacturer may void the user's authority to operate this equipment. This equipment has been tested and found to comply with the limits for a Class B digital device, pursuant to Part 15 of the FCC Rules. These limits are designed to provide reasonable protection against harmful interference in a residential installation. This equipment generates, uses, and can radiate radio frequency energy and, if not installed and used in accordance with the instructions, may cause harmful interference to radio communications. However, there is no guarantee that interference will not occur in a particular installation. If this equipment does cause harmful interference to radio or television reception, which can be determined by turning the equipment off and on, the user is encouraged to try to correct the interference by one or more of the following measures:

- Adjust or relocate the receiving antenna.
- Increase the distance between the camera and receiver.
- Connect the equipment to an outlet on a circuit different from that to which the receiver is connected.
- Consult your dealer or an experienced radio/TV technician for help. Only the OLYMPUS supplied USB cable should be used to connect the camera to USB enabled personal computers (PC).

Any unauthorized changes or modifications to this equipment would void the user's authority to operate.

For customers in North and South America

For customers in USA

Declaration of Conformity

Model Number : SP-560UZ

Trade Name : OLYMPUS

Responsible Party : **OLYMPUS IMAGING AMERICA INC.**

Address : 3500 Corporate Parkway, P.O. Box 610, Center Valley,
PA 18034-0610, U.S.A.

Telephone Number: 484-896-5000

Tested To Comply With FCC Standards

FOR HOME OR OFFICE USE

This device complies with Part 15 of the FCC rules. Operation is subject to the following two conditions:

(1) This device may not cause harmful interference.

(2) This device must accept any interference received, including interference that may cause undesired operation.

For customers in Canada

This Class B digital apparatus meets all requirements of the Canadian Interference-Causing Equipment Regulations.

Trademarks

- IBM is a registered trademark of International Business Machines Corporation.
- Microsoft and Windows are registered trademarks of Microsoft Corporation.
- Macintosh is a trademark of Apple Inc.
- xD-Picture Card™ is a trademark.
- All other company and product names are registered trademarks and/or trademarks of their respective owners.
- The standards for camera file systems referred to in this manual are the "Design Rule for Camera File System/DCF" standards stipulated by the Japan Electronics and Information Technology Industries Association (JEITA).

SPECIFICATIONS

● Camera

Product type	: Digital camera (for shooting and displaying)
Recording system	
Still pictures	: Digital recording, JPEG (in accordance with Design rule for Camera File system (DCF)), RAW data
Applicable standards	: Exif 2.2, Digital Print Order Format (DPOF), PRINT Image Matching III, PictBridge
Sound with still pictures	: Wave format
Movie	: AVI Motion JPEG
Memory	: Internal memory xD-Picture Card (16 MB - 2 GB) (TypeH/M, Standard)
No. of effective pixels	: 8,000,000 pixels
Image pickup device	: 1/2.35" CCD (primary color filter), 8,500,000 pixels (gross)
Lens	: Olympus lens 4.7 to 84.2 mm, f2.8 to 4.5 (equivalent to 27 to 486 mm on a 35 mm camera)
Photometric system	: Digital ESP metering, spot metering, center weighted metering
Shutter speed	: 15 to 1/2000 sec. (During bulb: Max. 8 minutes)
Aperture	: F2.8 to F8.0
Shooting range	: 0.1 m (3.94 in.) to ∞ (W) 1.2 m (47.24 in.) to ∞ (T) (normal/macro mode) 0.01 m (0.39 in.) to ∞ (super macro mode)
Monitor	: 2.5" TFT color LCD display, 230,000 pixels
Flash charge time	: Approx. 7 sec. (for full flash discharge at room temperature using a new fully charged battery)
Connector	: DC-IN jack USB connector, A/V OUT jack (multi-connector)
Automatic calendar system	: 2000 up to 2099
Operating environment	
Temperature	: 0 °C to 40 °C (32 °F to 104 °F) (operation)/ -20 °C to 60 °C (-4 °F to 140 °F) (storage)
Humidity	: 30 % to 90 % (operation)/10 % to 90 % (storage)
Power supply	: AA alkaline / NiMH battery (four) or Olympus AC adapter
Dimensions	: 116.0 mm (W) × 78.5 mm (H) × 78.0 mm (D) (4.57 × 3.09 × 3.07 in.) (excluding protrusions)
Weight	: 365 g (12.9 oz) without batteries and card

Design and specifications subject to change without notice.

CAMERA DIAGRAM

Camera

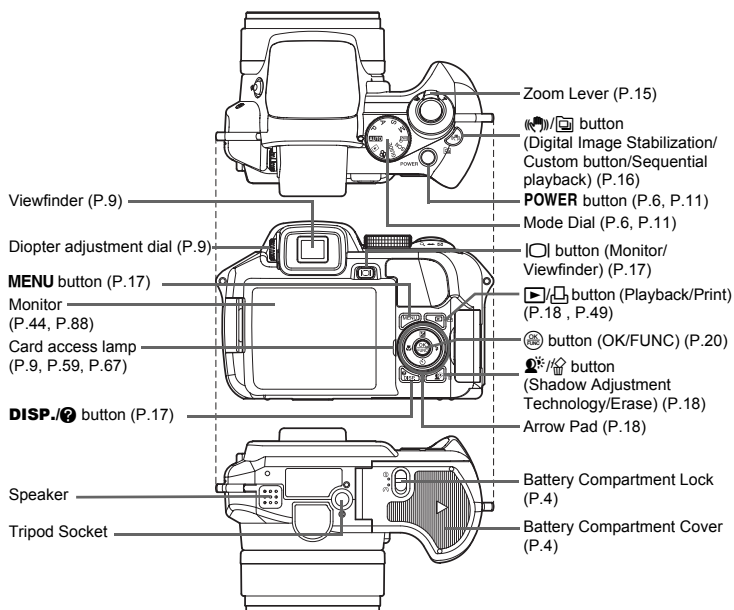
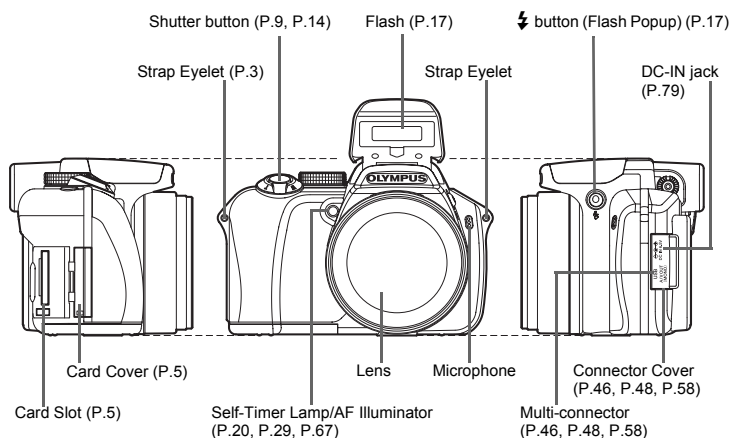



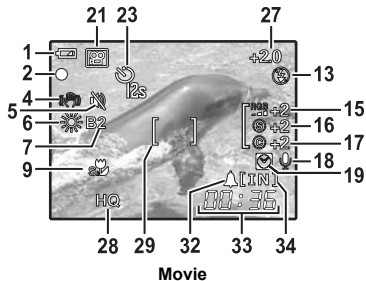
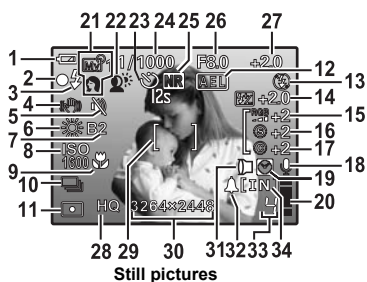

Monitor Symbols & Icons

● Shooting Mode



	Item	Indications	Ref. Page
1	Battery check	= full power, = low power	P.70
2	Green lamp	O= Auto Focus Lock	P.9, P.14, P.67
3	Flash standby Camera movement warning/Flash charge	(Lit) (Blinks)	P.62
4	Digital image stabilization		P.16
5	Silent mode		P.33
6	White balance		P.25
7	White balance compensation	B1 - B7, R1 - R7	P.31
8	ISO	ISO 100, ISO 800, ISO 3200 etc.	P.26
9	Macro mode Super macro mode Manual focus AF predict	 MF 	P.19 P.29 P.29
10	Drive	BKT	P.27
11	Spot metering		P.28
12	AE lock		P.16
13	Flash mode	etc.	P.19
14	Flash intensity control	-2.0 - +2.0	P.30
15	Saturation	-5 - +5	P.32
16	Contrast	-5 - +5	P.32
17	Sharpness	-5 - +5	P.32
18	Sound record		P.40
19	Dual time		P.44
20	Memory gauge	(Maximum reached)	P.62
21	Shooting Mode	AUTO, P, A, S, M, M1 to M4, P etc.	P.6, P.11, P.24

	Item	Indications	Ref. Page
22	Shadow Adjustment Technology		P.18
23	Self-timer		P.20
24	Shutter speed	15", 1/2, 1/60, 1/2000, BULB etc.	P.12
25	Noise reduction	NR	P.32
26	Aperture value	F2.8 to F8.0	P.12
27	Exposure compensation	-2.0 - +2.0	P.19
28	Record mode	RAW, SHQ, HQ, SQ1, SQ2, 16 : 9	P.23
29	AF target mark	[]	P.9, P.28
30	Image size	3264x2448, 2560x1920, 640x480 etc.	P.23
31	Conversion lens		P.33
32	Alarm		P.45
33	Number of storable still pictures Recording length	4 00:36	P.66
34	Current memory	[IN] : Pictures are recorded to the internal memory [xD] : Pictures are recorded to the card	P.79

● Playback mode

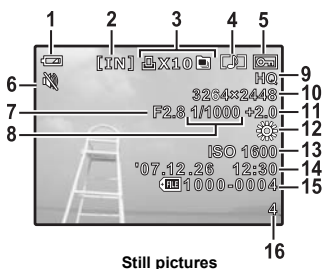

Still pictures

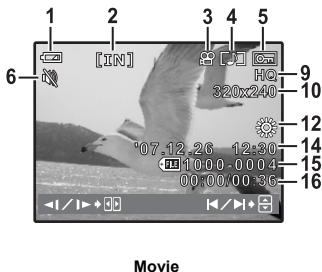

Movie

Item	Indications	Ref. Page
1 Battery check	= full power, = low power	P.70
2 Current memory	[IN] : Playing back the picture in the internal memory [xD] : Playing back the picture in the card	P.79
3 Print reservation/Number of prints Movie Sequential Playback / Sequential Pictures Auto Playback	 	P.53 P.35 P.14
4 Sound record		P.40
5 Protect		P.39
6 Silent mode		P.33
7 Aperture value	F2.8 to F8.0	P.12
8 Shutter speed	15", 1/2, 1/60, 1/2000, etc.	P.12
9 Record mode	RAW, SHQ, HQ, SQ1, SQ2, 16 : 9	P.23
10 Image size	3264x2448, 2560x1920, 640x480 etc.	P.23
11 Exposure compensation	-2.0 - +2.0	P.19
12 White balance	WB AUTO,	P.25
13 ISO	ISO 100, ISO 800, ISO 3200 etc.	P.26
14 Date and time	'07.12. 26 12:30	P.7, P.44
15 File number	100-0004	P.52
16 Frame number Playing time/Total recording time	4 00:00/00:36	P.43, P.35

Index

SCN (Scene) 6, 13, 24
 button 16
 button 18
 button
(exposure compensation) 19
 button (flash mode) 19
 button (flash pop-up) 17
 button (macro) 19
 button (Monitor/Viewfinder) 9, 17
 button (OK/FUNC) 20, 21
 button (self-timer) 20
16:9 23, 66, 68
3:2 23, 66

A

AC adapter 79
Adding sound to still pictures 40
AE lock **[AEL]** 16
AF 29
AF ILLUMINAT. 29
AF MODE 28
AF PREDICT 29
AF sequential shooting 27
AF target mark 9, 89
ALARM CLOCK 45
ALL ERASE 40
ALL INDEX 50
ALL PRINT 50
All-frame reservation 54
Aperture priority mode **A** 6, 12
AREA 28
Arrow pad 18
AUCTION 24
AUTO (full automatic) **AUTO** 6, 11
AUTO (ISO) 26
AUTO (shooting mode) **AUTO** 11

AUTO (white balance) **WB AUTO** 25
Auto bracketing **BKT** 27
Auto focus 64
Auto-flash 19
AV cable 3, 46
AVAILABLE LIGHT 24

B



BACKUP 41
Batteries 78
BEACH 24
BEEP 42
BEHIND GLASS 24
BKT 27
Bracket shooting 27

C

CALENDAR 36
CALENDAR (edit) 38
CALENDAR (playback) 15, 36
CAMERA MENU 22, 25
CANDLE 24
Card 78
Card access lamp 9, 59, 67
Center-weighted metering 28
Close-up playback 15
Cloudy day 25
COLOR EDIT 37
Compression 23
Connector cover 46, 48, 58
CONTRAST 32
Conversion lens 33
Cropping (DPOF) 53
Cropping (PictBridge) 51
Cropping 37
CUISINE 24

CURRENT (MY MODE SETUP) . . .	47
CUSTOM (MY MODE SETUP) . . .	47
CUSTOM BUTTON	47, 72
CUSTOM PRINT	50



D







Date and time 	7, 44
DC-IN jack	79
DIGITAL ZOOM	28
Diopter adjustment dial	9
DIRECT (Histogram)	46
Direct printing	48
DISP./? button	17
DOCUMENTS 	24
DPOF	52
DRIVE	27
DUALTIME 	44



E

EASY PRINT	48
EDIT	39
ERASE	40
Error messages	70
ESP	28
EV	19
Exposure	19
Exposure compensation 	19
EXPRESSION EDIT	38

F

FACE DETECT	28
FACE FOCUS	38
FILE NAME	43, 51
Fill-in flash 	19
FINE ZOOM	27
FIREWORKS 	24
Flash	19
Flash intensity control 	30



Flash mode 	19
Flash off 	19
FLASH 	30
Fluorescent lamp 1/2/3   	25

Focus	9, 14, 64
Focus lock	14
FOCUS MODE	29
FORMAT	41
FRAME	37
FRAME ASSIST  	46
Front curtain  SYNC1	30
FULLTIME AF	29



G

Green lamp	9, 14, 67
GUIDE	6, 13

H

































HIGH ISO AUTO	26
High speed sequential shooting1 	27
High speed sequential shooting2 	27
Histogram 	17, 46, 68
HQ	23, 66, 68

I

iESP	28
IMAGE QUALITY	23
Image size	23
IMAGE STABILIZER 	16, 29
IN	79
IN ( FLASH)	30
INDEX	38
Index display	15
INDEX PLAY	40
INDOOR 	24

Information displays DISP.	17
Internal memory	79
ISO	26
J	
JPEG	23
L	
LABEL	37
LANDSCAPE	24
LANDSCAPE+PORTRAIT	24
LAYOUT	38
M	
m/ft	47
Macro mode	19
Manual focus MF	29
Manual mode M	6, 12
MEMORY FORMAT	41
Memory gauge	62
Memory indicator	79
MENU button	17, 21
MENU DISPLAY	43
Menu guide	18
METERING	28
Microphone	30
Mode dial	6, 11
Monitor	17, 44, 88
Monitor brightness adjustment	44
MOVIE INDEX	39
MOVIE PLAY	35
Movie recording	13
MULTI PRINT	50
Multi-connector	46, 58
MY MODE	13
MY MODE SETUP My1/2/3/4	47
N	
NIGHT SCENE	24

NIGHT+PORTRAIT	24
Noise reduction NR	32
NTSC	46
Number of prints	51
Number of storage still picture	66
O	
OLYMPUS Master	55
One-touch WB	25
Optical zoom	15
P	
PAL	46
PANORAMA	31
PC	58
PERFECT FIX	36
PictBridge	48
Picture rotation	39
PIXEL MAPPING	43
PLAYBACK MENU	34, 39
Playback mode	11, 14, 17
Playback on a TV	46
Playing time	35
PORTRAIT	24
POWER button	6, 11
PRE-CAPTURE	27
PRESET (WB)	25
Press completely	9
Press halfway	9
PRINT ORDER	50
Print settings	52
Program mode P	6, 11
Protect	39
PW ON SETUP	42
Q	
QUICK SHUTTER	24, 25

R	
RAW	23, 66, 68
RAW DATA EDIT	36
Rear curtain  SYNC2	30
REC VIEW.	42
Recording length of movies.	66
Recording sound with movies 	33
Recording sound with still picture 	30
Red-eye fill-in flash 	19
Red-eye reduction flash 	19
RESET	24
RESET (MY MODE SETUP).	47
Resizing 	37
S	
SATURATION 	32
SEL. IMAGE	40
Selecting a language 	41
SELF PORTRAIT 	24
Self-timer lamp	20, 67
Self-timer 	20
Sequential shooting 	27
Shadow Adjustment Technology 	18
SHARPNESS 	32
SHOOT & SELECT 1/2  , 	24
Shooting guide GUIDE	6, 13
Shooting mode	6, 11, 18
SHQ.	23, 66, 68
Shutter button	9, 14
Shutter priority mode S	6, 12
SHUTTER SOUND	42
Shutter speed	12
SILENT MODE 	33
Single-frame reservation 	53
Single-frame shooting 	27
SLAVE.	30
SLIDESHOW.	34
SMILE SHOT 	24, 25
SNOW 	24
SPORT 	24
SPOT (AF MODE).	28
Spot metering 	28
SQ1	23, 66, 68
SQ2	23, 66, 68
STANDARD	48
Sunny day 	25
SUNSET 	24
Super macro mode 	19
SYNCHRO 	30
T	
TIMELAPSE 	33
Top menu.	21
Total recording time.	35
Tungsten light 	25
U	
UNDER WATER MACRO 	24
UNDER WATER WIDE1/2  1  2	24
USB cable	3, 48, 49, 55, 58
V	
VIDEO OUT	46
Viewfinder	17
VOLUME	42
W	
WB	25
White balance compensation 	31
X	
xD	79
xD-Picture Card	78
Z	
Zoom	15

Zoom lever 15

OLYMPUS®

<http://www.olympusamerica.com/>

OLYMPUS IMAGING AMERICA INC.

3500 Corporate Parkway, P.O. Box 610, Center Valley, PA 18034-0610, U.S.A. Tel. 484-896-5000

Technical Support (USA)

24/7 online automated help: <http://www.olympusamerica.com/support>

Phone customer support: Tel. 1-888-553-4448 (Toll-free)

Our phone customer support is available from 8 am to 10 pm (Monday to Friday) ET

<http://olympusamerica.com/contactus>

Olympus software updates can be obtained at: <http://www.olympusamerica.com/digital>

To find the nearest Service Centers, please visit: <http://www.olympusamerica.com/digital>, and click on the Worldwide Warranty icon at the bottom of the page.

Service Centers

U.S.A.:

- California** **Olympus Imaging America Inc.**
10805 Holder Street Suite 170
Cypress, CA 90630-5145
Tel: (888) 553-4448
- New York** **Olympus Imaging America Inc.**
400 Rabro Drive
Hauppauge, NY 11788-4258
Tel: (888) 553-4448
- Canada:** **Olympus Canada Inc.**
Consumer Products Group
151 Telson Road
Markham, Ontario Canada L3R 1E7
Tel. (888)553-4448
- Mexico:** **Olympus Imaging de Mexico S.A. de C.V.**
WTC Mexico,
Montecito No.38 - Lobby - Office 3
Col. Napoles, Mexico D.F. 03810
Tel. (01800)800-2128
E-mail: oimx@olympus.com
- Argentina:** **Jesus Labrador**
Paraguay 755 PB, C1057AAJ - Buenos Aires
Tel: (011) 4313-3174 Fax: (011) 4312-5239
E-Mail: olympus@jesuslabrador.com.ar
- Jesus Labrador**
Bartolome Mitre 860
C1036AAP - Buenos Aires
Tel: (011) 4331-1227 Fax: (011) 4331-1247
E-mail: service@basr.com.ar

Brazil:

- Rio de Janeiro** **Assistec**
Rua Uruguaiana, 94-Sobreloja
Centro-Rio de Janeiro CEP 20050-091
Tel: (021) 2242-3236 Fax: (021) 2242-3236
E-Mail: rio@assistecs.com.br
- Sao Paulo** **Assistec**
Rua Avanhandava 126, 3 Andar
Consolação, São Paulo
Tel: (011) 3123-3100 Fax: (011) 3214-0706
E-mail: ASSISTECSS@UOL.COM.BR
- Assistec**
Filial Shopping Eldorado
Av. Reboças 3970, 1 Subsolo, Loja 1035
Pinheiros, São Paulo
Tel: (011) 3815-3054 Fax: (011) 3814-4398
E-mail: ASSISTECSS@UOL.COM.BR
- Chile:** **REIFSCHEIDER S.A.**
Camino El Conquistador del Monte 5024
Huechuraba, Santiago
Tel: 56-2-6781200 Fax: 56-2-6781202
E-mail: olympus@reifschneider.cl,
serviciotecnico@reifschneider.cl

- Colombia:** **CV Tronica LTDA**
Calle 68 No 12-57, Bogota
Tel: (0571)235-7260/348-1573
Fax: (0571) 348-1574
E-mail: servicio@cvtronica.com
- CV Tronica LTDA**
Cra 9 No 23-49 Local 215 C.C Intercentro, Bogota
Tel: (0571)284-4365
- CV Tronica LTDA**
Av. Cra 15 No 105A-22 Piso 2 Local 5, Bogota
Tel: (0571)637-3540

- Panama:** **FOTOSER**
Edif. El Paical, Oficina No3, P.A.
Urb. Herbruger, Transistmica
(Detras del S/M Riba Smith),
Tel/Fax: (507) 261-0436
E-mail: rearanda@rocketmail.com

- Uruguay:** **Fotocamara S.R.L.**
Rondeau 1470 Montevideo
Tel: (02) 900-2004 Fax: (02) 900-8430
E-mail: FOTOCAM@ADINET.COM.UY

- Venezuela:** **Micron C.A.**
4ta. transversal Urb. Horizonte,
Edificio América, Mezanine, Caracas 1070-A
Tel: (0212) 238-3526 Fax: (0212) 239-8598
E-mail: serviciotecnico@micron.com.ve
VS264801

© 2007 OLYMPUS IMAGING CORP.

Printed in Japan

1AG6P1P3694--

Download from www.Somanuals.com. All Manuals Search And Download.

Free Manuals Download Website

<http://myh66.com>

<http://usermanuals.us>

<http://www.somanuals.com>

<http://www.4manuals.cc>

<http://www.manual-lib.com>

<http://www.404manual.com>

<http://www.luxmanual.com>

<http://aubethermostatmanual.com>

Golf course search by state

<http://golfingnear.com>

Email search by domain

<http://emailbydomain.com>

Auto manuals search

<http://auto.somanuals.com>

TV manuals search

<http://tv.somanuals.com>