

OLYMPUS[®]

DIGITAL CAMERA

FE-4030

Instruction Manual

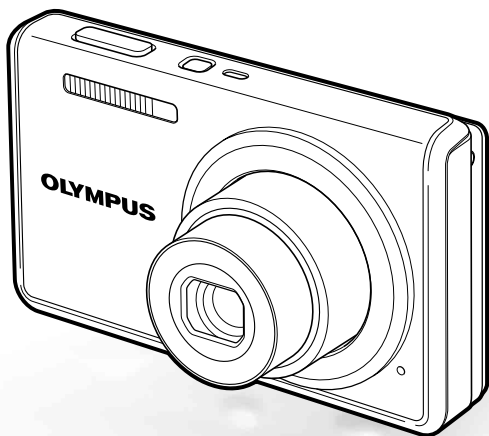

- Thank you for purchasing an Olympus digital camera. Before you start to use your new camera, please read these instructions carefully to enjoy optimum performance and a longer service life. Keep this manual in a safe place for future reference.
- We recommend that you take test shots to get accustomed to your camera before taking important photographs.
- In the interest of continually improving our products, Olympus reserves the right to update or modify information contained in this manual.
- The screen and camera illustrations shown in this manual were produced during the development stages and may differ from the actual product.

Step 1

Checking the contents of the box



Digital camera



Strap



LI-42B Lithium Ion Battery



or



F-2AC USB-AC adapter



USB cable



AV cable



ib CD-ROM

Other accessories not shown: Instruction Manual (this manual), warranty card.
Contents may vary depending on purchase location.

Step 2

Preparing the Camera

"Preparing the Camera" (p. 10)

Step 3

Shooting and Playing Back Images

"Shooting, Viewing, and Erasing" (p. 14)

Step 4

How to Use the Camera

"Camera Settings" (p. 3)

Step 5

Printing

"Direct printing (PictBridge)" (p. 37)

"Print Reservations (DPOF)" (p. 40)

Contents

- Names of Parts 6
- Menus for Playback, Editing, and Printing Functions 30
- Preparing the Camera 10
- Menus for Other Camera Settings 32
- Shooting, Viewing, and Erasing... 14
- Printing 37
- Using Shooting Modes 20
- Usage Tips 42
- Using Shooting Functions 23
- Appendix 46
- Menus for Shooting Functions... 27

Camera Settings

Using the Direct Buttons

Frequently used functions can be accessed using the direct buttons.

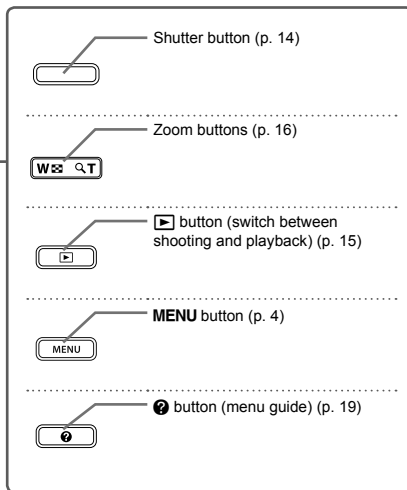

Arrow pad

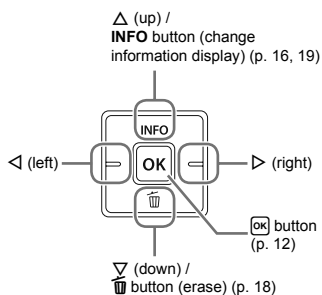

The symbols Δ ∇ \triangleleft \triangleright displayed for image selections and settings indicate that the arrow pad is to be used.



Using the Menu

Use the menu to change camera settings such as the shooting mode.

Press the **MENU** button to display the function menu. The function menu can be used to set frequently used shooting and playback functions such as shooting mode.

Shooting

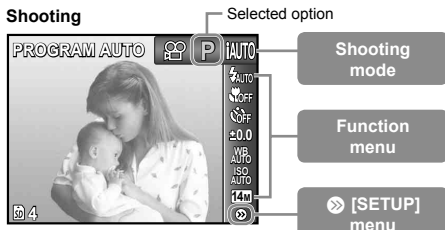

To select the shooting mode

Use \triangleleft to select a shooting mode and press the OK button.

To select the function menu

Use \triangle to select a menu and use \triangleleft to select a menu option. Press the OK button to set the function menu.

Playback



Use \triangle to select a menu and press the OK button.

In the [SETUP] menu, various camera functions can be set, including shooting and playback functions not displayed in the function menu, and other settings such as date, time and screen display.

1 Select [SETUP] and then press the OK button.

- The [SETUP] menu is displayed.

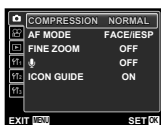

2 Press \triangleleft to highlight the page tabs. Use \triangle to select the desired page tab and press \triangleright .

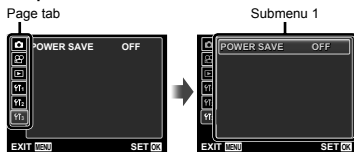

3 Use \triangle to select the desired submenu 1 and then press the OK button.

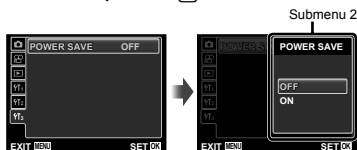

4 Use \triangle to select the desired submenu 2 and then press the OK button.

- Once a setting is selected, the display returns to the previous screen.

! There may be additional operations. "Menu Settings" (p. 27 to 36)



5 Press the MENU button to complete the setting.

! Some functions cannot be used in some shooting modes. In such cases, the following message is displayed after setting.



Menu Index

Menus for Shooting Functions

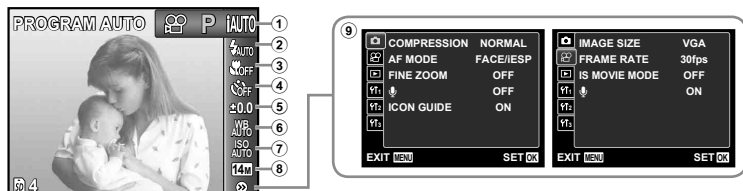

- | | | |
|--|--|--|
| <ul style="list-style-type: none"> ① Shooting mode P (PROGRAM AUTO)..... p. 14 iAUTO (iAUTO)..... p. 20 OFF (DIS MODE)..... p. 20 SCN (SCENE MODE)..... p. 20 MAGIC (MAGIC FILTER)..... p. 21 PANORAMA..... p. 22 MOVIE..... p. 15 ② Flash..... p. 23 ③ Macro p. 23 | <ul style="list-style-type: none"> ④ Self-timer p. 24 ⑤ Exposure compensation..... p. 24 ⑥ White balance..... p. 25 ⑦ ISO p. 25 ⑧ Image size (Still images) ...p. 26 ⑨ (SETUP) ▶ (Shooting)/ (Movie) IMAGE SIZE (Movies) p. 27 COMPRESSION (Still images) p. 27 | <ul style="list-style-type: none"> FRAME RATE (Movies)..... p. 27 AF MODE..... p. 28 FINE ZOOM p. 28 IS MOVIE MODE..... p. 28 (Still images)..... p. 29 (Movies)..... p. 29 ICON GUIDE p. 29 |
|--|--|--|

Menus for Playback, Editing, and Printing Functions

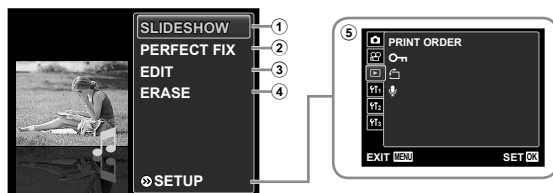

- | | |
|--|--|
| <ul style="list-style-type: none"> ① SLIDESHOW..... p. 30 ② PERFECT FIX p. 30 ③ EDIT p. 30 ④ ERASE p. 30 | <ul style="list-style-type: none"> ⑤ (SETUP) ▶ (Playback) PRINT ORDER..... p. 31 Protect..... p. 31 (Rotate)..... p. 31 (Add sound to still images) p. 31 |
|--|--|

Menus for Other Camera Settings

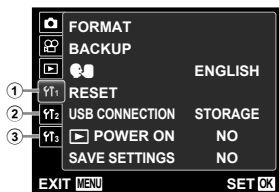

- | | |
|--|---|
| <ul style="list-style-type: none"> ① Y1 (Settings 1) MEMORY FORMAT/ FORMAT..... p. 32 BACKUP..... p. 32 (Language)..... p. 32 RESET..... p. 32 USB CONNECTION p. 33 POWER ON p. 33 SAVE SETTINGS p. 33 | <ul style="list-style-type: none"> ② Y2 (Settings 2) PW ON SETUP p. 33 SOUND SETTINGS p. 34 PIXEL MAPPING p. 34 (Monitor) p. 34 (Date/time)..... p. 34 WORLD TIME..... p. 35 VIDEO OUT..... p. 35 ③ Y3 (Settings 3) POWER SAVE..... p. 36 |
|--|---|

Names of Parts

Camera unit

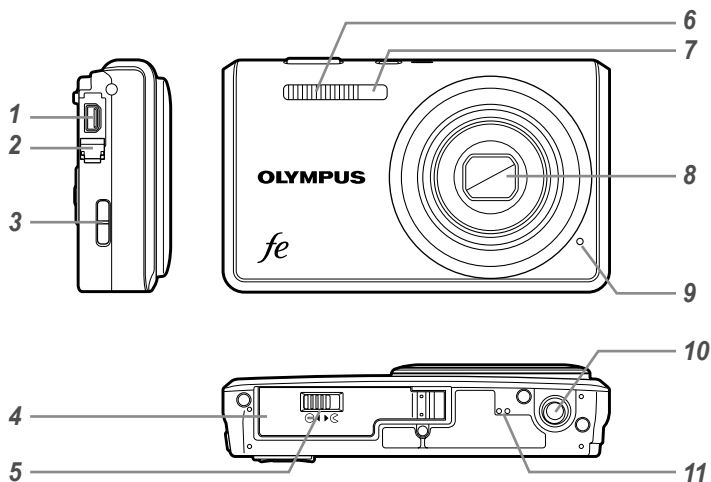

- | | |
|---|------------------------------|
| 1 Multi-connector p. 11, 12, 35, 37 | 7 Self-timer lamp..... p. 24 |
| 2 Connector cover..... p. 11, 12, 35, 37 | 8 Lens p. 46, 59 |
| 3 Strap eyelet | 9 Microphone p. 29, 31 |
| 4 Battery/card compartment cover... p. 10 | 10 Tripod socket |
| 5 Battery/card compartment lock p. 10 | 11 Speaker |
| 6 Flash p. 23 | |

Attaching the camera strap

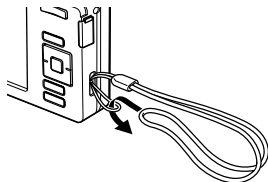

 Pull the strap tight so that it does not come loose.

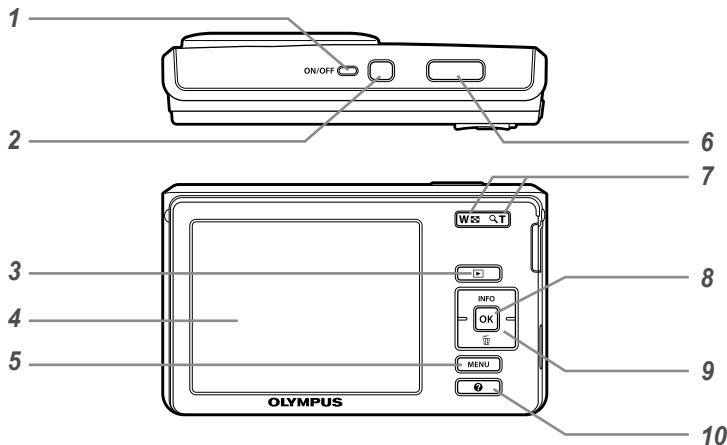

- | | | | | | | | |
|---|---|-------|-----------|----|--|-------|-----------|
| 1 | Indicator lamp | | p. 11, 12 | 7 | Zoom buttons | | p. 16 |
| 2 | ON/OFF button | | p. 12, 14 | 8 | OK button (OK) | | p. 3, 12 |
| 3 | ▶ button (switch between shooting and playback) | | p. 15 | 9 | Arrow pad | | p. 3 |
| 4 | Monitor | | p. 14, 42 | | INFO button (change information display) | | p. 16, 19 |
| 5 | MENU button | | p. 4 | | ⌫ button (erase) | | p. 18 |
| 6 | Shutter button | | p. 14 | 10 | 🔍 button (menu guide) | | p. 19 |

Shooting mode display

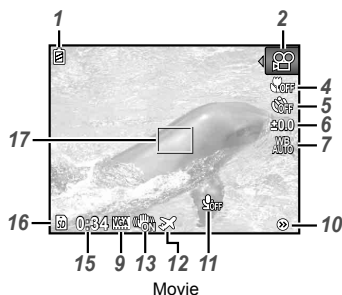
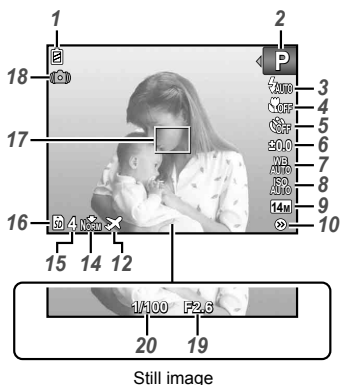

- | | | | |
|---|-----------|--|-------|
| 1 Battery check | p. 12 | 12 World time | p. 35 |
| 2 Shooting mode | p. 14, 20 | 13 Digital image stabilization | p. 28 |
| 3 Flash | p. 23 | 14 Compression (still images)..... | p. 27 |
| 4 Flash standby/flash charge | p. 42 | 15 Number of storable pictures (still images) | p. 14 |
| 5 Macro | p. 23 | Continuous recording length (movies) | p. 15 |
| 6 Self-timer | p. 24 | 16 Current memory | p. 48 |
| 7 Exposure compensation | p. 24 | 17 AF target mark | p. 14 |
| 8 White balance | p. 25 | 18 Camera shake warning | - |
| 9 ISO | p. 25 | 19 Aperture value..... | p. 14 |
| 10 Image size..... | p. 26, 27 | 20 Shutter speed..... | p. 14 |
| 11 [SETUP] menu | p. 4, 5 | | |
| 11 Recording with sound (movies) | p. 29 | | |

Playback mode display

• Normal display

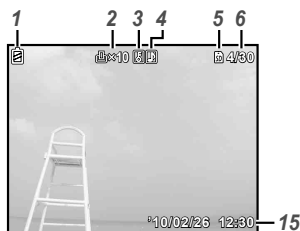

Still image



Movie

• Detailed display

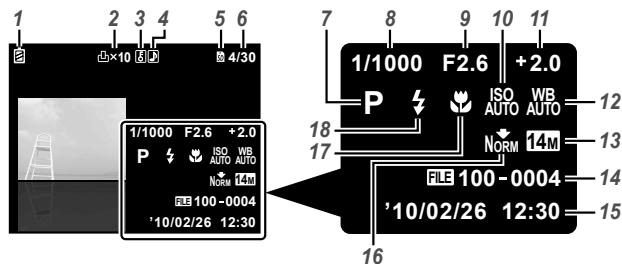

- | | | | | | |
|---|---|-------------------|----|----------------------------|-----------------|
| 1 | Battery check | p. 12 | 9 | Aperture value | p. 14 |
| 2 | Print reservation/
number of prints | p. 40/p. 39 | 10 | ISO | p. 25 |
| 3 | Protect | p. 31 | 11 | Exposure compensation | p. 24 |
| 4 | Adding sound | p. 29, 31 | 12 | White balance | p. 25 |
| 5 | Current memory | p. 48 | 13 | Image size | p. 26, 27 |
| 6 | Frame number/total number of images
(still images) | p. 16 | 14 | File number | - |
| | Elapsed time/total recording time
(movies) | p. 17 | 15 | Date and time | p. 12 |
| 7 | Shooting mode | p. 14, 20 | 16 | Compression (still images) | p. 27 |
| 8 | Shutter speed | p. 14 | | Frame rate (movies) | p. 27 |
| | | | 17 | Macro | p. 23 |
| | | | 18 | Flash | p. 23 |

Preparing the Camera

Inserting the battery and the SD/SDHC memory card (sold separately)

- Always use SD/SDHC memory cards with this camera. Do not insert any other types of memory card.

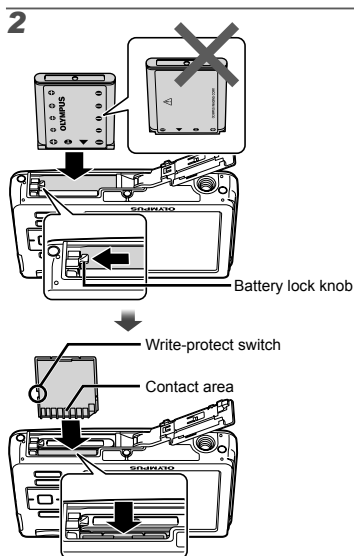
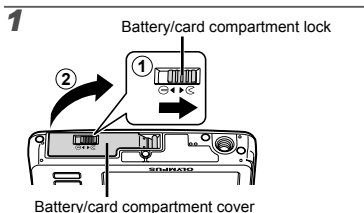

- Insert the battery by putting in the ▼ marked side first, with the ⊕ marks toward the battery lock knob. Damage to the battery exterior (scratches, etc.) may produce heat or an explosion.

- Insert the battery while sliding the battery lock knob in the direction of the arrow.
- Slide the battery lock knob in the direction of the arrow to unlock, and then remove the battery.
- Turn off the camera before opening the battery/card compartment cover.
- When using the camera, be sure to close the battery/card compartment cover.
- Insert the card straight until it clicks into place.
- Do not touch the contact area directly.

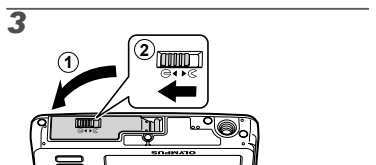

- This camera allows the user to take pictures using the internal memory even when no SD/SDHC memory card (sold separately) is inserted. "Using an SD/SDHC memory card" (p. 47)
- "Number of storable pictures (still images)/ Continuous recording length (movies) in the internal memory and SD/SDHC memory cards" (p. 49)

To remove the SD/SDHC memory card

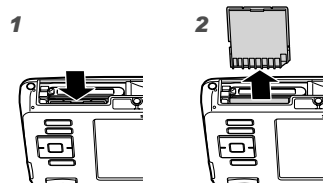

- Press the card in until it clicks and comes out slightly, then grab the card and pull it out.

Charging the battery and installing the supplied computer software (ib)

After checking the system requirements, follow the instructions below to connect the camera to a computer, charge the battery, and install the supplied computer software (ib).

System requirements

Windows XP (Service Pack 2 or later)/
Windows Vista/Windows 7

- ! If your system does not meet the system requirements or if you do not use a computer, charge the battery using the supplied USB-AC adapter. "Charging the battery with the supplied USB-AC adapter" (p. 12)

Connecting the camera

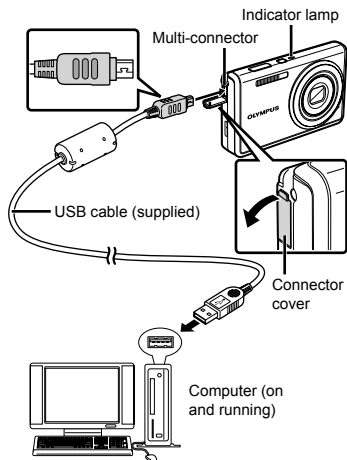

Charging the camera battery

The camera battery can be charged while the camera is connected to a computer.

- The indicator lamp lights during charging and turns off when charging is complete.
- ! Charging takes up to 3 hours.
- ! If the indicator lamp does not light, the camera is not correctly connected or the battery, camera, or USB cable may be damaged.

Installing the computer software (ib)

- ! For information on using the computer software (ib), see the software's online help.

1 Insert the supplied CD in a CD-ROM drive.

- A setup screen will appear on the computer monitor.
- ! If the setup window is not displayed, select "My Computer" (Windows XP) or "Computer" (Windows Vista/Windows 7) from the start menu. Double-click the icon for the CD-ROM drive to open the setup CD window and then double-click "CameraInitialSetup.exe".

2 Connect the camera to the computer.

- ! If nothing is displayed in the camera monitor when the camera is connected, the battery may be exhausted. Leave the camera connected to the computer until the battery has charged, then disconnect and reconnect the camera.

3 Follow the on-screen instructions on your computer.

Charging the battery with the supplied USB-AC adapter

- ❗ The included F-2AC USB-AC adapter (with an AC cable or plug-in type; hereafter referred to as AC adapter) differs depending on the region where you purchased the camera. If you received a plug-in type AC adapter, plug it directly into an AC outlet.
- ❗ The included AC adapter has been designed to be used only for charging. Make sure that operations such as shooting, viewing images and so on are not being used while the AC adapter is connected to the camera.

Example: AC adapter with an AC cable

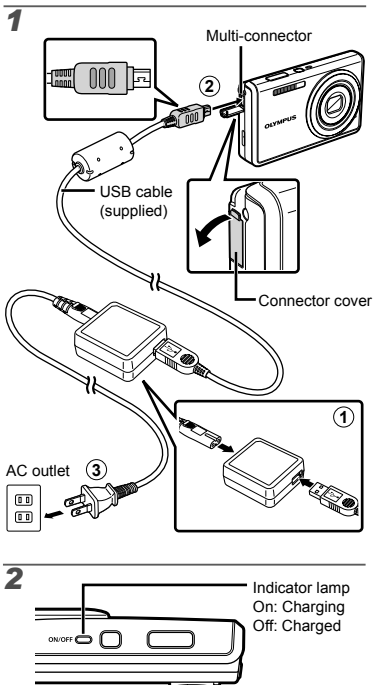

- ❗ The battery is not fully charged at the time of purchase. Before use, be sure to charge the battery until the indicator lamp turns off (up to 3 hours).

- ❗ If the indicator lamp does not light, the camera is not correctly connected or the battery, camera, or AC adapter may be damaged.
- ❗ For details on the battery and the AC adapter, see "Battery and AC adapter (included)" (p. 46).
- ❗ The battery can be charged while the camera is connected to the computer. Charging time varies depending on the performance of a computer. (There may be cases in which it takes approx. 10 hours.)

When to charge the batteries

Charge the battery when the error message shown below appears.

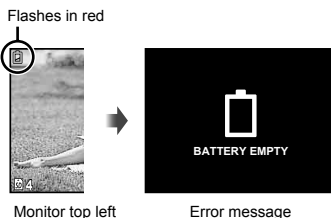

Operation guide

Operation guides displayed at the bottom of the screen indicate that the **MENU** button, **OK** button, or zoom buttons should be used.

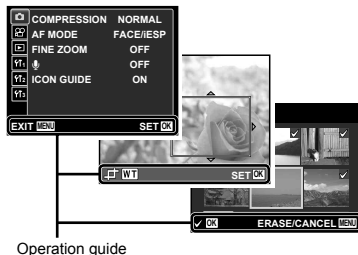

Setting the date, time and time zone

The date and time set here are saved to image file names, date prints, and other data.

1 Press the ON/OFF button to turn on the camera.

- The date and time setting screen is displayed when the date and time are not set.

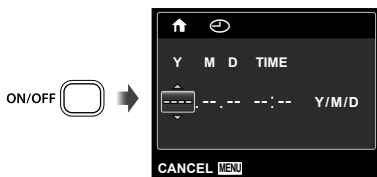

Date and time setting screen

2 Use Δ / ∇ to select the year for [Y].



3 Press \triangleright to save the setting for [Y].

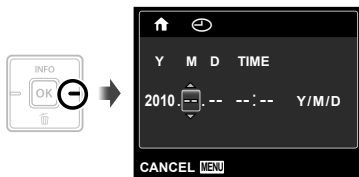

4 As in Steps 2 and 3, use Δ / ∇ / \triangleleft / \triangleright and the **OK** button to set [M] (month), [D] (day), [TIME] (hours and minutes), and [Y/M/D] (date order).

- ! For a more accurate setting, press the **OK** button when the time signal hits 00 seconds while setting the minutes.
- ! To change the date and time, adjust the setting from the menu. [\odot] (Date/time) (p. 34)

5 Use \triangleleft / \triangleright to select your home time zone and press the **OK** button.

- Use Δ / ∇ to turn daylight saving time ([SUMMER]) on or off.



- ! The menu can be used to change the selected time zone. [WORLD TIME] (p. 35)

Changing the display language

The language for the menu and error messages displayed on the monitor is adjustable.

1 Display the [SETUP] menu.

- ! "Using the Menu" (p. 4)

2 Use Δ / ∇ to select the Υ 1 (Settings 1) tab and then press \triangleright .

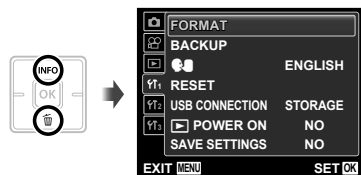

3 Use Δ / ∇ to select [\odot] and press the **OK** button.

4 Use Δ / ∇ / \triangleleft / \triangleright to select your language and press the **OK** button.

5 Press the **MENU** button.

Shooting, Viewing, and Erasing

Shooting with the optimum aperture value and shutter speed [PROGRAM AUTO]

In this mode, automatic shooting settings are activated while also allowing changes to a wide range of other shooting menu functions, such as exposure compensation, white balance, etc. as needed.

1 Press the ON/OFF button to turn on the camera.

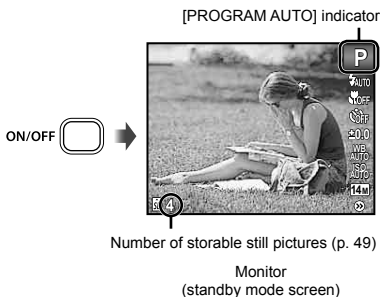

- ! If the [PROGRAM AUTO] indicator is not displayed, press the **MENU** button to display the function menu and then set the shooting mode to **P**. "Using the Menu" (p. 4)

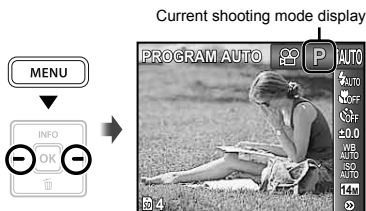

- ! Press the **ON/OFF** button again to turn off the camera.

2 Hold the camera and compose the shot.

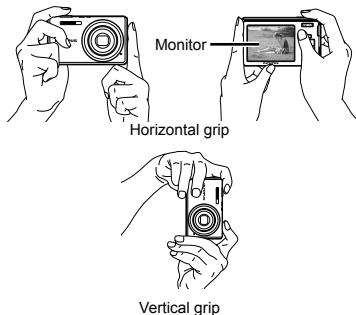

- ! When holding the camera, take care not to cover the flash with your fingers, etc.

3 Press the shutter button halfway down to focus on the subject.

- When the camera focuses on the subject, the exposure is locked (shutter speed and aperture value are displayed), and the AF target mark changes to green.
- The camera was unable to focus if the AF target mark flashes red. Try focusing again.

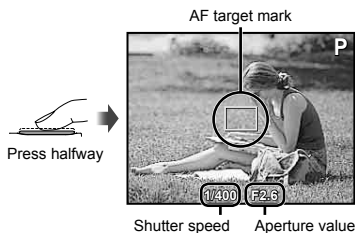

- ! "Focusing" (p. 44)

- 4** To take the picture, gently press the shutter button all the way down while being careful not to shake the camera.



To view images during shooting

Pressing the button enables playback of images. To return to shooting, either press the button or press the shutter button halfway down.

Shooting movies [MOVIE]

- 1** Press the MENU button to display the function menu screen.



- 2** Use to set the shooting mode to and then press the button.

[MOVIE] indicator



- 3** Press the shutter button halfway down to focus on the subject, and gently press the button all the way down to start recording.

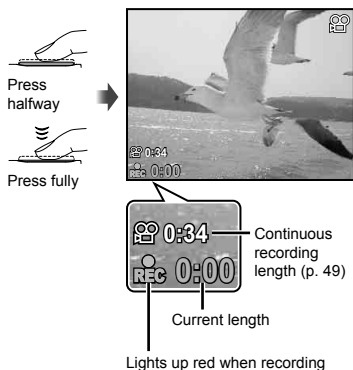

- 4** Gently press the shutter button all the way down to stop recording.

- Sound will also be recorded.
- During sound recording, only the digital zoom can be used. To record a movie with optical zoom, set (movies) (p. 29) to [OFF].

Using the zoom

Pressing the zoom buttons adjusts the shooting range.

Pressing the wide (W) button Pressing the telephoto (T) button



- ! Optical zoom: 4x
Digital zoom: 4x
- ! Select [DIS MODE] for the shooting mode (p. 20) when shooting with the telephoto zoom.

To take larger images without reducing image quality [FINE ZOOM] (p. 28)

- ! The zoom bar appearance identifies the status of the fine zoom/digital zoom.

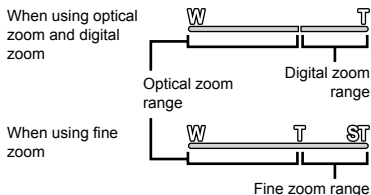

Changing the shooting information display

The display of the screen information can be changed to best match the situation, for example, the need for a clear view of the screen or for making a precise composition by using the grid display.

1 Press Δ (INFO).

- The displayed shooting information changes in the order shown below each time the button is pressed. "Shooting mode display" (p. 8)

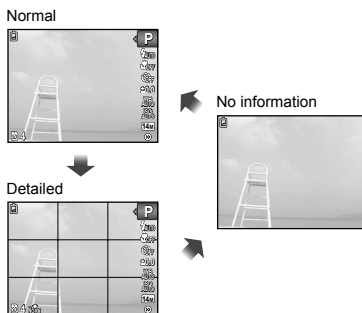

Viewing images

1 Press the \blacktriangleright button.

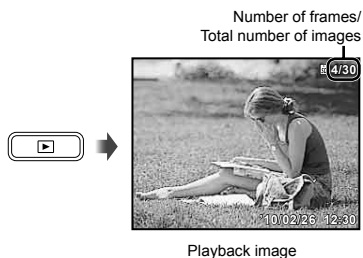

2 Use \triangleleft and \triangle to select an image.



- ! Hold \triangle to fast forward and hold \triangleleft to reverse.
- ! The display size of the images can be changed. "Index view and close-up view" (p. 18)

To play sound recordings

To play sound recorded with an image, select the image and press the **OK** button. A  icon appears on images with which sound has been recorded.

- !  (still images) (p. 29, 31)



During audio playback

To play back movies

Select a movie, and press the **OK** button.



Movie

Operations during movie playback



Elapsed time/
Total recording
time

During playback

Pausing and resuming playback	Press the OK button to pause playback. To resume playback during pause, fast forward, or rewind, press OK .
Fast forward	Press \triangle to fast forward. Press \triangle again to increase the fast forward speed.
Rewind	Press \triangleleft to rewind. The rewinding speed increases each time \triangleleft is pressed.
Adjusting the volume	Use \triangle ∇ to adjust the volume.

Operations during pausing playback



During pause

Cueing	Use \triangle to display the first frame and press ∇ to display the last frame.
Advancing and rewinding one frame at a time	Press \triangle or \triangleleft to advance or rewind one frame at a time. Hold \triangle or \triangleleft pressed for continuous advance or rewind.
Resuming playback	Press the OK button to resume playback.

To stop movie playback

Press the **MENU** button.

Erasing images during playback (Single image erase)

- 1 Display the image you want to erase and press ∇ (T).



- 2 Press $\Delta \nabla$ to select [ERASE], and press the OK button.

 [ALL ERASE] (p. 30) and [SEL. IMAGE] (p. 30) can be used to erase multiple images at the same time.

Index view and close-up view

Index view enables quick selection of a desired image. Close-up view (up to 10x magnification) allows checking of image details.

- 1 Press the zoom buttons.



To select an image in index view

Use $\Delta \nabla \langle \triangleright$ to select an image, and press the OK button to display the selected image in single-image view.

To scroll an image in close-up view

Use $\Delta \nabla \langle \triangleright$ to move the viewing area.

Changing the image information display

Shooting information settings displayed on the screen can be changed.

1 Press Δ (INFO).

- The displayed image information changes in the order shown below each time the button is pressed.

Normal



No information



Detailed



Using the menu guide

If the ? button is pressed while settings are being made in the function or [SETUP] menu, a description of the selected option is displayed.

- ! "Using the Menu" (p. 4)

Using Shooting Modes

- ! The shooting mode can be selected from the function menu in the following order: **P**, **iAUTO**, **(AUTO)**, **SCN**, **MAGIC**, **(M)**, and **(P)**.
- ! "Using the Menu" (p. 4)

Shooting with automatic settings [iAUTO]

According to the scene, the camera automatically selects the optimal shooting mode from [PORTRAIT]/[LANDSCAPE]/[NIGHT+PORTRAIT]/[SPORT]/[MACRO]. This is a fully automatic mode that allows the user to take pictures using the best mode for the shooting scene simply by pressing the shutter button.

1 Set the shooting mode to iAUTO.

The icon changes depending on the scene that the camera automatically selects.



- ! In some cases, the camera may not select the desired shooting mode.
- ! When the camera cannot identify which is the optimal mode, [PROGRAM AUTO] will be selected.

Reducing blur on shooting [DIS MODE]

This mode enables the user to reduce blur that is caused by camera shake and subject movement.

1 Set the shooting mode to (DIS).

[DIS MODE] indicator



Using the best mode for the shooting scene [SCENE MODE]

1 Set the shooting mode to SCN.



2 Press ∇ to go to the submenu.



- 3 Use \triangleleft \triangleright to select the best shooting mode for the scene, and press the OK button.

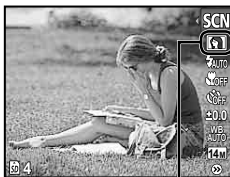

Icon indicating [SCENE MODE] that is set

- ! In [SCENE MODE], the optimum shooting settings are pre-programmed for specific shooting scenes. For this reason, some settings cannot be changed in some modes.

Option	Application
PORTRAIT/ LANDSCAPE/ NIGHT SCENE ¹⁾ / NIGHT+PORTRAIT/ SPORT/ INDOOR/ CANDLE/ SELF PORTRAIT/ SUNSET ¹⁾ / FIREWORKS ¹⁾ / CUISINE/ DOCUMENTS/ BEACH & SNOW/ PET	The camera takes a picture using the optimum settings for the scene conditions.

- ¹⁾ When the subject is dark, noise reduction is automatically activated. This approximately doubles the shooting time during which no other pictures can be taken.

To take pictures of a moving subject like a pet (PET)

- Use \triangleleft \triangleright to select [PET], and press the OK button to set.
- Hold the camera to align the AF target mark on the subject and press the OK button.
 - When the camera recognizes the subject, the AF target mark automatically tracks the subject movement to focus on it continuously. "To focus on a moving subject continuously (AF Tracking)" (p. 28).

Shooting with special effects [MAGIC FILTER]

Add an artistic effect to your photo by selecting the desired magic filter.

- 1 Set the shooting mode to MAGIC.



- 2 Press ∇ to go to the submenu.



- 3 Use \triangleleft \triangleright to select the desired effect and then press the OK button to set.



Icon indicating [MAGIC FILTER] that is set

Shooting mode	Option
MAGIC FILTER	① POP ART ② PIN HOLE ③ FISH EYE ④ DRAWING

- ! In [MAGIC FILTER], the optimum shooting settings are pre-programmed for each scene effect. For this reason, some settings cannot be changed in some modes.

Creating panoramic images [PANORAMA]

Take pictures that can be joined to form a panorama using the ib computer software.

- ! The focus, exposure (p. 24), zoom position (p. 16), and white balance (p. 25) are locked at the first frame.
- ! The flash (p. 23) is fixed to  (FLASH OFF) mode.

1 Set the shooting mode to .



2 Use to select the pan direction.

3 Press the shutter button to take the first frame, and then compose the second shot.

Before first shot

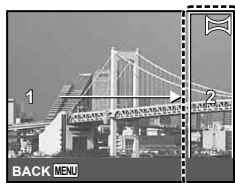

After first shot



- After the first shot, the area shown in the white frame reappears on the side of the display opposite the pan direction. Frame subsequent photographs so that they overlap with the image on the monitor.

4 Repeat Step 3 until the number of desired frames is taken, and then press the MENU button when finished.

- ! Panorama shooting is possible for up to 10 frames.
- ! For information on making panoramas, refer to the online help for the ib computer software.

Using Shooting Functions

! "Using the Menu" (p. 4)

Using the flash

The flash functions can be selected to best match the shooting conditions.

- 1 Select the flash option in the shooting function menu.



- 2 Use \leftarrow and \rightarrow to select the setting option, and press the $\boxed{\text{OK}}$ button to set.

Option	Description
FLASH AUTO	The flash fires automatically in low-light or backlight conditions.
REDEYE	Pre-flashes are emitted to reduce the occurrence of red eye in your photos.
FILL IN	The flash fires regardless of the available light.
FLASH OFF	The flash does not fire.

Shooting closeups (Macro shooting)

This function enables the camera to focus and shoot subjects at close distances.

- 1 Select the macro option in the shooting function menu.



- 2 Use \leftarrow and \rightarrow to select the setting option, and press the $\boxed{\text{OK}}$ button to set.

Option	Description
OFF	Macro mode is deactivated.
MACRO	This enables shooting as close as 15 cm/5.9 in. ¹⁾ (60 cm/23.6 in. ²⁾ to the subject.
SUPER MACRO ³⁾	This enables shooting as close as 4 cm/1.6 in. to the subject.

¹⁾ When the zoom is at the widest (W) position.

²⁾ When the zoom is at the most telephoto (T) position.

³⁾ The zoom is automatically fixed.

! The flash (p. 23) and zoom (p. 16) cannot be set during super macro shooting.

Using the self-timer

After the shutter button is pressed all the way down, the picture is taken after a short delay.

- 1 Select the self-timer option in the shooting function menu.



- 2 Use <|> to select the setting option, and press the **OK** button to set.

Option	Description
OFF	The self-timer is deactivated.
12 SEC	The self-timer lamp turns on for approx. 10 seconds, then blinks for approx. 2 seconds, and then the picture is taken.
2 SEC	The self-timer lamp blinks for approx. 2 seconds, and then the picture is taken.

Self-timer shooting is automatically canceled after one shot.

To cancel the self-timer after it starts

Press the **MENU** button.

Adjusting the brightness (Exposure compensation)

The standard brightness (appropriate exposure) set by the camera based on the shooting mode (except for [iAUTO]) can be adjusted brighter or darker to obtain a desired shot.

- 1 Select the exposure compensation option in the shooting function menu.



- 2 Use <|> to select the desired brightness, and press the **OK** button.

Adjusting to a natural color scheme (White balance)

For more natural coloring, choose a white balance option suited to the scene.

1 Select the white balance option in the shooting function menu.

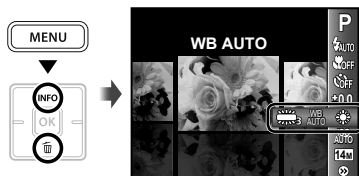

2 Use <Left><Right> to select the setting option, and press the [OK] button to set.

Option	Description
WB AUTO	The camera automatically adjusts the white balance according to the shooting scene.
	For shooting outdoors under a clear sky
	For shooting outdoors under a cloudy sky
	For shooting under tungsten lighting
	For shooting under daylight fluorescent lighting (household lighting, etc.)
	For shooting under neutral fluorescent lighting (desk lamps, etc.)
	For shooting under white fluorescent lighting (offices, etc.)

Selecting the ISO sensitivity

- ! Abbreviation for the International Organization for Standardization. ISO standards specify the sensitivity for digital cameras and film, thus codes such as "ISO 100" are used to represent sensitivity.
- ! In the ISO setting, although smaller values result in less sensitivity, sharp images can be taken under fully lit conditions. Larger values result in higher sensitivity, and images can be taken at fast shutter speeds even under low light conditions. However, high sensitivity introduces noise into the resulting picture, which may give it a grainy appearance.

1 Select the ISO setting option in the shooting function menu.



2 Use <Left><Right> to select the setting option, and press the [OK] button to set.

Option	Description
ISO AUTO	The camera automatically adjusts the sensitivity according to the shooting scene.
Value	The ISO sensitivity is fixed to the selected value.

Selecting the size of still images

- 1 Select the image size option in the shooting function menu.



- 2 Use \leftarrow and \rightarrow to select the setting option, and press the $\boxed{\text{OK}}$ button to set.

Option	Description
14M (4288×3216)	Suitable for printing A3 (11×17 in.) pictures.
8M (3264×2448)	Suitable for printing pictures up to A3 (11×17 in.).
5M (2560×1920)	Suitable for printing A4 (8.5×11 in.) pictures.
3M (2048×1536)	Suitable for printing pictures up to A4 (8.5×11 in.).
2M (1600×1200)	Suitable for printing A5 (5×7 in.) pictures.
1M (1280×960)	Suitable for printing pictures at postcard size.
VGA (640×480)	Suitable for viewing pictures on a TV or using pictures in emails and on websites.
16:9S (1920×1080)	Suitable for playing pictures on a wide screen TV.



- ! Image size for movies can be selected from the [SETUP] menu. [IMAGE SIZE/FRATE] (p. 27)
- ! "Number of storable pictures (still images)/ Continuous recording length (movies) in the internal memory and SD/SDHC memory cards" (p. 49)

Menus for Shooting Functions

 The default settings of the function are highlighted in .

Selecting a compression mode for still images [COMPRESSION]

 (Shooting menu) ► COMPRESSION

Available shooting modes: P iAUTO  SCN MAGIC 



Submenu 2	Application
FINE	Shooting at high quality.
NORMAL	Shooting at normal quality.

 "Number of storable pictures (still images)/Continuous recording length (movies) in the internal memory and SD/SDHC memory cards" (p. 49)

Selecting the image quality for movies [IMAGE SIZE/FRATE RATE]

 (Movie menu) ► IMAGE SIZE/FRATE RATE

Available shooting modes: 

Submenu 1	Submenu 2	Application
IMAGE SIZE	VGA (640×480)/ QVGA (320×240)	Select the image quality based on the image size and frame rate. Higher frame rates provide smoother movie images.
FRAME RATE	 30fps ^{*1} /  15fps ^{*1}	

^{*1} frames per second

 "Number of storable pictures (still images)/Continuous recording length (movies) in the internal memory and SD/SDHC memory cards" (p. 49)

Selecting the focusing area [AF MODE]

(Shooting menu) ► AF MODE

Available shooting modes: P i AUTO SCN
MAGIC

Submenu 2	Application
FACE/IESP	The camera focuses automatically. (If a face is detected, it is shown by a white frame ¹ ; when the shutter button is pressed halfway and the camera is able to focus, the frame color is changed to green ² if the camera is able to focus. If no face is detected, the camera chooses a subject in the frame and focuses automatically.)
SPOT	The camera focuses on the subject located within the AF target mark.
AF TRACKING	The camera tracks the subject movement automatically to focus on it continuously.

¹ For some subjects, the frame may not appear or may take some time to appear.

² If the frame blinks in red, the camera is unable to focus. Try again to press the shutter button halfway.

To focus on a moving subject continuously (AF Tracking)

- 1 Hold the camera to align the AF target mark on the subject and press the button.
 - 2 When the camera recognizes the subject, the AF target mark automatically tracks the subject movement to focus on it continuously.
 - 3 To cancel the tracking, press the button.
- ! Depending on the subjects or the shooting conditions, the camera may be unable to lock the focus or fail to track the subject movement.
 - ! When the camera fails to track the subject movement, the AF target mark changes to red.

Shooting at higher magnifications than optical zoom without reducing the image quality [FINE ZOOM]

(Shooting menu) ► FINE ZOOM

Available shooting modes: P i AUTO SCN
MAGIC

Submenu 2	Application
OFF	Optical zoom and digital zoom are used to zoom in for shooting.
ON	Optical zoom and image cropping are combined to zoom in for shooting (up to 26.8x).

- ! This function will not reduce the image quality since it does not convert the data with fewer pixels into the data with larger pixels.
- ! When set to [ON], [IMAGE SIZE] is limited to or lower.
- ! When set to [ON], digital zoom is canceled automatically.
- ! [FINE ZOOM] is not available when SUPER MACRO (p. 23) is selected.

Reducing blur due to camera shake during movie shooting [IS MOVIE MODE]

(Movie menu) ► IS MOVIE MODE

Available shooting modes:

Submenu 2	Application
OFF	Shoots without using the image stabilizing function.
ON	Shoots using the image stabilizing function.

- ! Image stabilization may not prevent motion blur caused by movement of the subject or by extreme movement of the camera.
- ! When set to [ON], shooting is slightly zoomed in.

Recording sound when shooting still images [🔊]

📷 (Shooting menu) ▶ 🔊

Available shooting modes: **P** iAUTO 📷 **SCN**

Submenu 2	Application
OFF	No sound is recorded.
ON	The camera automatically starts recording sound for approx. 4 seconds after a picture is taken. This is useful for recording notes or comments about the picture.

- ⚠ When recording, aim the microphone (p. 6) at the source of the sound you want to record.

Recording sound when shooting movies [🔊]

🎬 (Movie menu) ▶ 🔊

Available shooting modes: 🎬

Submenu 2	Application
OFF	No sound is recorded.
ON	Sound is recorded.

- ⚠ When set to [ON], only the digital zoom can be used during movie recording. To record the movie with the optical zoom, set [🔊] (movies) to [OFF].

Displaying icon guides [ICON GUIDE]

📷 (Shooting menu) ▶ ICON GUIDE

Available shooting modes: **P** iAUTO 📷 **SCN**
MAGIC 🎭 📷

Submenu 2	Application
OFF	No icon guide is displayed.
ON	The explanation of the selected icon will be displayed when a shooting mode or shooting function menu icon is selected (position the cursor on the icon for a while to display the explanation).

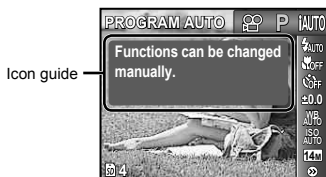

Menus for Playback, Editing, and Printing Functions

Playing back pictures automatically [SLIDESHOW]

SLIDESHOW

To start a slideshow

After pressing the **[OK]** button, the slideshow starts. To stop the slideshow, press the **[OK]** button or the **MENU** button.

Single-frame advance/rewind: During a slideshow, press **[▶]** to advance one frame or press **[◀]** to rewind one frame.

Retouching images [PERFECT FIX]

PERFECT FIX

- ⓘ Depending on the picture, the editing may not be effective.
- ⓘ The retouching process may lower the image resolution.

Submenu 1	Application
ALL	[SHADOW ADJ] and [REDEYE FIX] are applied together.
SHADOW ADJ	Only sections darkened by backlighting and dim lighting are brightened.
REDEYE FIX	Eyes that are reddened by the flash are corrected.

- 1 Use **△ ▽** to select a correction method, and press the **[OK]** button.
- 2 Use **[◀▶]** to select an image for retouching, and press the **[OK]** button.
 - The retouched image is saved as a separate image.

Changing the image size [ZOOM]

EDIT ▶ [ZOOM]

Submenu 2	Application
WIDE 640 × 480	This saves a high-resolution image as a separate image with a smaller size for use in e-mail attachments and other applications.
NORMAL 320 × 240	

- 1 Use **[◀▶]** to select an image.
- 2 Use **△ ▽** to select the size, and press the **[OK]** button.

Cropping images [CROP]

EDIT ▶ [CROP]

- 1 Use **[◀▶]** to select an image, and press the **[OK]** button.
- 2 Use the zoom buttons to select the size of the cropping frame, and use **△ ▽ ◀ ▶** to move the frame.

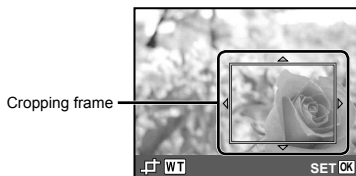

- 3 Press the **[OK]** button.
 - The edited image will be saved as a separate image.

Erasing images [ERASE]

ERASE

Submenu 1	Application
ALL ERASE	All images in the internal memory or card will be erased.
SEL. IMAGE	Images are individually selected and erased.
ERASE	Deletes the image displayed.
CANCEL	Cancels erasing.

- ❗ When erasing pictures in a internal memory, do not insert the card into the camera.
- ❗ When erasing pictures from the card, insert a card into the camera in advance.

To erase all images [ALL ERASE]

- ① Use Δ ∇ to select [ALL ERASE], and press the **OK** button.
- ② Use Δ ∇ to select [YES], and press the **OK** button.

To individually select and erase images [SEL. IMAGE]

- ① Use Δ ∇ to select [SEL. IMAGE], and press the **OK** button.
- ② Use \triangleleft \triangleright to select the image to be erased, and press the **OK** button to add a \checkmark mark to the image.
 - Press the W zoom button to display an index view. Images can be quickly selected using Δ ∇ \triangleleft \triangleright . Press the T button to return to the single frame display.

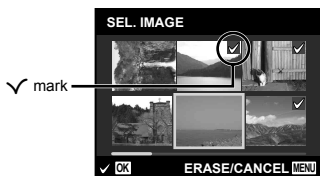

- ③ Repeat Step ② to select the images to be erased, and then press the **MENU** button to erase the selected images.
- ④ Use Δ ∇ to select [YES], and press the **OK** button.
 - The images with a \checkmark mark are erased.

Saving print settings to the image data [PRINT ORDER]

▶ (Playback menu) **▶** PRINT ORDER

- ❗ "Print Reservations (DPOF)" (p. 40)
- ❗ Print reservation can be set only for still images that are recorded to the card.

Protecting images [O-M]

▶ (Playback menu) **▶** O-M

- ❗ Protected images cannot be erased by [ERASE] (p. 18, 30), [SEL. IMAGE], or [ALL ERASE] (p. 30), but all images are erased by [MEMORY FORMAT]/[FORMAT] (p. 32).
- ① Use \triangleleft \triangleright to select an image.
 - ② Press the **OK** button.
 - Press the **OK** button again to cancel the settings.
 - ③ If necessary, repeat Steps ① and ② to protect other images, and press the **MENU** button.

Rotating images [R]

▶ (Playback menu) **▶** R

- ① Use \triangleleft \triangleright to select an image.
 - ② Press the **OK** button to rotate the image.
 - ③ If necessary, repeat Steps ① and ② to make settings for other images, and press the **MENU** button.
- ❗ The new picture orientations will be saved even after the power is turned off.

Adding sound to still images [M]

▶ (Playback menu) **▶** M

- ① Use \triangleleft \triangleright to select an image.
- ② Aim the microphone toward the sound source.

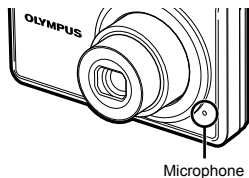



- ③ Press the **OK** button.
 - Recording starts.

Menus for Other Camera Settings

Erasing data completely [MEMORY FORMAT]/[FORMAT]

 (Settings 1) ► MEMORY FORMAT/
FORMAT

-  Before formatting, check that no important data is left in the internal memory or card.
-  Cards must be formatted with this camera before first use or after being used with other cameras or computers.

Submenu 2	Application
YES	Completely erases the image data in the internal memory ¹ or card (including protected images).
NO	Cancels formatting.

¹ Be sure to remove the card before formatting the internal memory.

Copying images in the internal memory to the card [BACKUP]

 (Settings 1) ► BACKUP

Submenu 2	Application
YES	Backs up image data in the internal memory to the card.
NO	Cancels the backup.

-  It takes some time to back up data. Check that the battery has sufficient power before starting the backup.

Changing the display language [●●]



 (Settings 1) ► ●●

Submenu 2	Application
Languages	The language for the menus and error messages displayed on the monitor is selected.

-  "Changing the display language" (p. 13)

Restoring the shooting functions to the default settings [RESET]

 (Settings 1) ► RESET

Submenu 2	Application
YES	Restores the following menu functions to the default settings. <ul style="list-style-type: none">• Flash (p. 23)• Macro (p. 23)• Self-timer (p. 24)• Exposure compensation (p. 24)• White balance (p. 25)• ISO (p. 25)• Image size (p. 26)• Menu functions in  (Shooting menu)/ (Movie menu) (p. 27 to 29)
NO	The current settings will not be changed.

Selecting a method for connecting the camera to other devices [USB CONNECTION]

Y1 (Settings 1) ► USB CONNECTION

Submenu 2	Application
AUTO	When the camera is connected to another device, the settings selection screen is displayed.
STORAGE	Select when transferring images to a computer or when using ib computer software with the camera connected to a computer.
MTP	Select when transferring images to a computer running Windows Vista or Windows 7 without using ib computer software.
PRINT	Select when connecting to a PictBridge-compatible printer.

Copying pictures to a computer without using ib computer software

This camera is compatible with the USB Mass Storage Class. You can transfer and save the image data on your computer while the camera and the computer are connected.

System requirements

Windows 2000 Professional/
Windows XP/Windows Vista/Windows 7/
Mac OS X v10.3 or later

! Even if a computer has USB ports, proper operation is not guaranteed in the following cases.

- computers with USB ports installed using an expansion card, etc.
- computers without a factory-installed OS and home-built computers

Turning on the camera with the button [POWER ON]

Y1 (Settings 1) ►  POWER ON

Submenu 2	Application
YES	Pressing the  button turns on and starts the camera in the playback mode.
NO	The camera is not turned on. To turn on the camera, press the ON/OFF button.

Saving the mode when the camera is turned off [SAVE SETTINGS]

Y1 (Settings 1) ► SAVE SETTINGS

Submenu 2	Application
YES	The shooting mode is saved when the camera is turned off and is reactivated the next time the camera is turned on.
NO	The shooting mode is set to P mode when the camera is turned on.

Choosing the opening screen display [PW ON SETUP]

Y2 (Settings 2) ► PW ON SETUP

Submenu 2	Application
OFF	No opening screen is displayed.
ON	The opening screen is displayed when the camera is turned on.

Selecting the camera sound and its volume [SOUND SETTINGS]

(Settings 2) ► SOUND SETTINGS

Submenu 2	Submenu 3	Submenu 4	Application
SILENT MODE ^{1,2}	OFF/ON	—	Select [ON] to disable camera sounds (operating sound, shutter sound, and warning sound) and mute sound during playback.
BEEP	SOUND TYPE	1/2/3	Selects the operating sound and volume of the camera buttons (except the shutter button).
	VOLUME	OFF (No Sound) or 2 levels of volume	
SHUTTER SOUND	SOUND TYPE	1/2/3	Selects the type and volume of the shutter sound.
	VOLUME	OFF (No Sound) or 2 levels of volume	
	OFF (No Sound) or 2 levels of volume	—	Adjusts the warning sound volume.
VOLUME	OFF (No Sound) or 5 levels of volume	—	Adjusts the image playback volume.

¹ Even when [SILENT MODE] is [ON], can be used to adjust volume during playback.

² Even when [SILENT MODE] is [ON], sound is played when images are displayed on a television.

Adjusting the CCD and the image processing function [PIXEL MAPPING]

(Settings 2) ► PIXEL MAPPING

This function has already been adjusted at factory shipping, and no adjustment is needed right after purchase. Approximately once a year is recommended.

For best results, wait at least one minute after taking or viewing pictures before performing pixel mapping. If the camera is turned off during pixel mapping, be sure to perform it again.

To adjust the CCD and the image processing function

Press the button when [START] (Submenu 2) is displayed.

- The camera checks and adjusts the CCD and the image processing function at the same time.

Adjusting the brightness of the monitor []

(Settings 2) ►

Submenu 2	Application
BRIGHT/ NORMAL	Selects the monitor brightness depending on the surrounding brightness.

Setting the date and time []

(Settings 2) ►

- "Setting the date, time and time zone" (p. 12)

To select the date display order

- Press after setting Minute, and use to select the date display order.

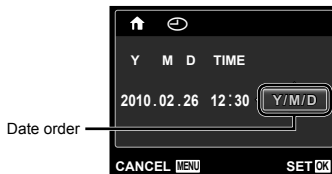

Switching between home and travel destination time zones [WORLD TIME]

Yt2 (Settings 2) ► WORLD TIME

! You will not be able to select a time zone using [WORLD TIME] if the camera clock has not first been set using [☺].

Submenu 2	Submenu 3	Application
HOME/ALTERNATE	🏠	The time in the home time zone (the time zone selected for 🏠 in submenu 2).
	✈️	The time in the travel destination time zone (the time selected for ✈️ in submenu 2).
🏠 ^{*1}	—	Select the home time zone (🏠).
✈️ ^{*1, 2}	—	Select the travel destination time zone (✈️).

*1 In areas where daylight saving time is in effect, use Δ ▽ to turn daylight saving time ((SUMMER)) on.

*2 When you select a time zone, the camera automatically calculates the time difference between the selected zone and the home time zone (🏠) to display the time in the travel destination time zone (✈️).

Selecting a video signal system to match your TV [VIDEO OUT]

Yt2 (Settings 2) ► VIDEO OUT

! The TV video signal system varies depending on the countries and regions. Before viewing camera images on your TV, select the video output according to your TV's video signal type.

Submenu 2	Application
NTSC	Connecting the camera to a TV in North America, Taiwan, Korea, Japan, and so on.
PAL	Connecting the camera to a TV in European countries, China, and so on.

! The factory default settings differ according to the region where the camera is sold.

To play back camera images on a TV

- Use the camera to select the same video signal system as the one of connected TV ([NTSC]/[PAL]).
- Connect the TV and camera.

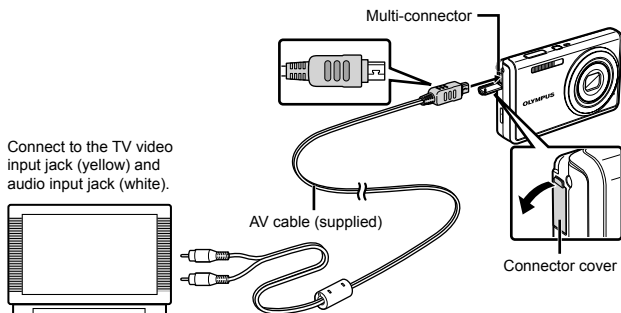

- Turn on the TV, and change "INPUT" to "VIDEO (an input jack connected to the camera)."

! For details on changing the input source of the TV, refer to the TV's instruction manual.

④ Press the  button, and use  to select the image for playback.

 Depending on the TV's settings, the displayed images and information may become cropped.

Saving battery power between shots [POWER SAVE]

 (Settings 3) ► POWER SAVE

Submenu 2	Application
OFF	Cancels [POWER SAVE].
ON	When the camera is not being used for approx. 10 seconds, the monitor automatically turns off to save battery power.

To resume standby mode

Press any button.

Printing

Direct printing (PictBridge¹)

By connecting the camera to a PictBridge-compatible printer, you can print images directly without using a computer.

To find out if your printer supports PictBridge, refer to the printer's instruction manual.

¹ PictBridge is a standard for connecting digital cameras and printers of different makers and printing out pictures directly.

- ! The printing modes, paper sizes, and other parameters that can be set with the camera vary depending on the printer that is used. For details, refer to the printer's instruction manual.
- ! For details on the available paper types, loading paper, and installing ink cassettes, refer to the printer's instruction manual.

Printing images at the printer's standard settings [EASY PRINT]

- ! In the [SETUP] menu, set [USB CONNECTION] to [AUTO] or [PRINT]. "Using the Menu" (p. 4)

1 Display the image to be printed on the monitor.

- ! "Viewing images" (p. 16)
- ! Printing can also be started when the camera is turned off. After performing Step 2, use $\Delta \nabla$ to select [EASY PRINT], press the \square button. Use $\triangleleft \triangleright$ to select an image, and press the \square button.

2 Turn on the printer, and then connect the printer and camera.

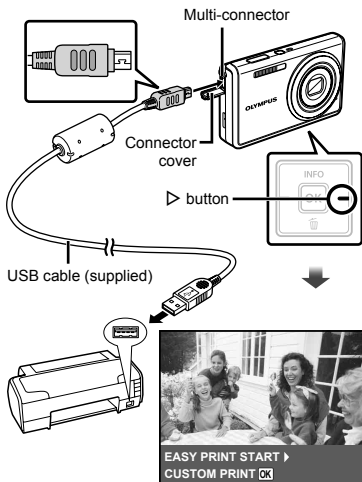

3 Press \triangleright to start printing.

4 To print another image, use $\triangleleft \triangleright$ to select an image, and press the \square button.

To exit printing

After a selected image is displayed on the screen, disconnect the USB cable from the camera and printer.



Changing the printer's settings for printing [CUSTOM PRINT]

1 Follow Steps 1 and 2 in [EASY PRINT] (p. 37).

2 Press the **[OK]** button to start printing.

3 Use Δ ∇ to select the print mode, and press the **[OK]** button.

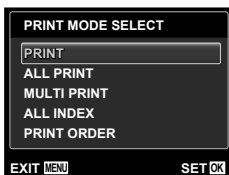

Submenu 2	Application
PRINT	This prints the image selected in Step 6.
ALL PRINT	This prints all images stored in the internal memory or card.
MULTI PRINT	This prints one image in a multiple layout format.
ALL INDEX	This prints an index of all images stored in the internal memory or card.
PRINT ORDER ^{*1}	This prints images based on the print reservation data on the card.

^{*1} [PRINT ORDER] is available only when print reservations have been made. "Print Reservations (DPOF)" (p. 40)

4 Use Δ ∇ to select [SIZE] (Submenu 3), and press **[>]**.

! If the [PRINTPAPER] screen is not displayed, the [SIZE], [BORDERLESS], and [PICS/SHEET] are set to the printer's standard.

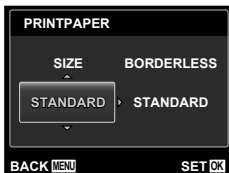

5 Use Δ ∇ to select the [BORDERLESS] or [PICS/SHEET] settings, and press the **[OK]** button.

Submenu 4	Application
OFF/ON ^{*1}	The image is printed with a border around it ([OFF]). The image is printed to fill the entire paper ([ON]).
(The number of images per sheet varies depending on the printer.)	The number of images per sheet ([PICS/SHEET]) is selectable only when [MULTI PRINT] is selected in Step 3.

^{*1} The available settings for [BORDERLESS] vary depending on the printer.

! If [STANDARD] is selected in Steps 4 and 5, the image is printed at the printer's standard settings.



6 Use \triangleleft \triangleright to select an image.

7 Press Δ to make a print reservation for the current image. Press ∇ to make the detailed printer settings for the current image.

To make the detailed printer settings

! Use Δ ∇ \triangleleft \triangleright to select the setting, and press the **[OK]** button.

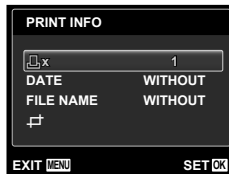

Submenu 5	Submenu 6	Application
	0 to 10	This selects the number of prints.
DATE	WITH/ WITHOUT	Selecting [WITH] prints the images with the date. Selecting [WITHOUT] prints the images without the date.
FILE NAME	WITH/ WITHOUT	Selecting [WITH] prints the file name on the image. Selecting [WITHOUT] does not print any file name on the image.
	(Proceeds to the setting screen.)	This selects a portion of the image for printing.

To crop an image [

- Use the zoom buttons to select the size of the cropping frame, use Δ ∇ \langle \rangle to move the frame, and then press the button.



- Use Δ ∇ to select [OK], and press the button.



- If necessary, repeat Steps 6 and 7 to select the image to be printed, make the detailed settings, and set [SINGLE PRINT].

9 Press the button.

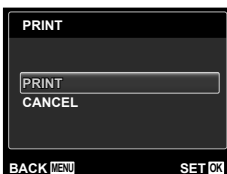

10 Use Δ ∇ to select [PRINT], and press the button.

- Printing starts.
- When [OPTION SET] is selected in [ALL PRINT] mode, [PRINT INFO] screen is displayed.
- When printing is finished, the [PRINT MODE SELECT] screen is displayed.

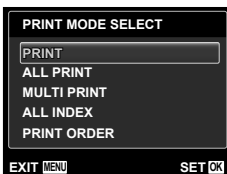

To cancel printing

- When [DO NOT REMOVE USB CABLE] is displayed, press the **MENU** button, use Δ ∇ to select [CANCEL], and then press the button.

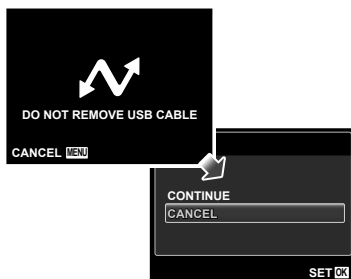

11 Press the MENU button.

12 When the message [REMOVE USB CABLE] is displayed, disconnect the USB cable from the camera and printer.

Print Reservations (DPOF¹)

In print reservations, the number of prints and date imprint option are saved in the image on the card. This enables easy printing at a printer or print shop supporting DPOF by using only the print reservations on the card without a computer or a camera.

- ¹ DPOF is a standard for storing automatic printout information from digital cameras.
- Print reservations can be set only for the images stored on the card. Insert a card with recorded images before making print reservations.
 - DPOF reservations set by another DPOF device cannot be changed by this camera. Make changes using the original device. Making new DPOF reservations with this camera will erase the reservations made by the other device.
 - DPOF print reservations can be made for up to 999 images per card.

Single-frame print reservations []

1 Display the [SETUP] menu.

- "Using the Menu" (p. 4)

2 From the playback menu [], select [PRINT ORDER] and then press the [OK] button.

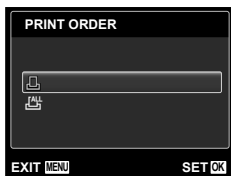

3 Use Δ ∇ to select [], and press the [OK] button.



4 Use \triangleleft \triangleright to select the image for print reservation. Use Δ ∇ to select the quantity. Press the [OK] button.

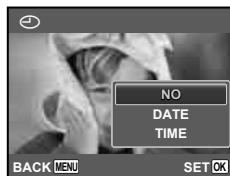

5 Use Δ ∇ to select the [] (date print) screen option, and press the [OK] button.

Submenu 2	Application
NO	This prints the image only.
DATE	This prints the image with the shooting date.
TIME	This prints the image with the shooting time.



6 Use Δ ∇ to select [SET], and press the [OK] button.

Reserving one print each of all images on the card [ALL]

- 1** Follow Steps 1 and 2 in [] (p. 40).
- 2** Use $\Delta \nabla$ to select [ALL], and press the [OK] button.
- 3** Follow Steps 5 and 6 in [].

Resetting all print reservation data

- 1** Follow Steps 1 and 2 in [] (p. 40).
- 2** Use $\Delta \nabla$ to select either [] or [ALL], and press the [OK] button.

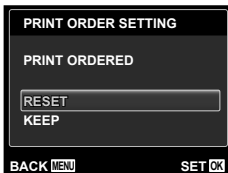

- 3** Use $\Delta \nabla$ to select [RESET], and press the [OK] button.

Resetting the print reservation data for selected images

- 1** Follow Steps 1 and 2 in [] (p. 40).
- 2** Use $\Delta \nabla$ to select [], and press the [OK] button.
- 3** Use $\Delta \nabla$ to select [KEEP] and press the [OK] button.
- 4** Use $\triangleleft \triangleright$ to select the image with the print reservation you want to cancel. Use $\Delta \nabla$ to set the print quantity to "0".
- 5** If necessary, repeat Step 4, and then press the [OK] button when finished.
- 6** Use $\Delta \nabla$ to select the [] (date print) screen option, and press the [OK] button.
 - The settings are applied to the remaining images with the print reservation data.
- 7** Use $\Delta \nabla$ to select [SET], and press the [OK] button.



Usage Tips

If the camera does not work as intended, or if an error message is displayed on the screen, and you are unsure of what to do, refer to the information below to fix the problem(s).

Troubleshooting

Battery

“The camera does not work even when batteries are installed”.

- Insert recharged batteries in the correct direction.
“Inserting the battery and the SD/SDHC memory card (sold separately)” (p. 10), “Charging the camera battery” (p. 11), “Charging the battery with the supplied USB-AC adapter” (p. 12)
- Battery performance may have been reduced temporarily due to low temperature. Take the batteries out of the camera, and warm them by putting them in your pocket for a while.



Card/Internal memory

“An error message is displayed”.

“Error message” (p. 43)

Shutter button

“No picture is taken when the shutter button is pressed”.

- Cancel sleep mode.
To save battery power, the camera automatically goes into sleep mode and the monitor turns off if there is no operation for 3 minutes when the camera is turned on. No picture is taken even if the shutter button is fully pressed in this mode. Operate the zoom buttons or other buttons to restore the camera from sleep mode before taking a picture. If the camera is left for another 12 minutes, it automatically turns off. Press the ON/OFF button to turn the camera on.
- Press the  button to switch to the shooting mode.
- Wait until  (flash charge) stops blinking before taking pictures.

- With prolonged camera use, the internal temperature may increase, resulting in automatic shutdown. If this occurs, remove the battery from the camera and wait until the camera has sufficiently cooled. The camera's external temperature may also increase during use, however this is normal and does not indicate malfunction.

Monitor

“Difficult to see”.

- Condensation¹ may have occurred. Turn off the power, and wait for the camera body to become acclimated to the surrounding temperature and dry out before taking pictures.
¹ Dew drops can form in the camera when it is suddenly taken from a cold location into a warm, humid room.

“Vertical lines appear on the screen”.

- This condition may occur when the camera is pointed at an extremely bright subject under a clear sky and so on. The lines do not appear, however, in the final image.

“The light is caught in the picture”.

- Shooting with flash in dark situations results in an image with many flash reflections on dust in the air.

Date and time function

“Date and time settings return to the default setting”.

- If the batteries are removed and left out of the camera for about a day², the date and time settings return to the default setting, and must be reset.
² The time until the date and time settings return to the default setting varies depending on how long the batteries have been loaded.
- “Setting the date, time and time zone” (p. 12)











Miscellaneous



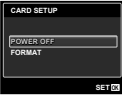
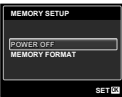

“The camera makes a noise when taking pictures”.

- The camera may activate the lens and make a noise even if no operation is performed. This is because the camera automatically performs actions of auto focus as far as it is ready to shoot.

Error message

-  When one of the messages below is displayed on the monitor, check the corrective action.

Error message	Corrective action
 CARD ERROR	Card problem Insert a new card.
 WRITE PROTECT	Card problem The card write-protect switch is set to the "LOCK" side. Release the switch.
 MEMORY FULL	Internal memory problem <ul style="list-style-type: none"> • Insert a card. • Erase unwanted images.^{*1}
 CARD FULL	Card problem <ul style="list-style-type: none"> • Replace the card. • Erase unwanted images.^{*1}
	Card problem Use $\Delta \nabla$ to select [FORMAT], and press the [OK] button. Next, use $\Delta \nabla$ to select [YES], and press the [OK] button. ^{*2}
	Internal memory problem Use $\Delta \nabla$ to select [MEMORY FORMAT], and press the [OK] button. Next, use $\Delta \nabla$ to select [YES], and press the [OK] button. ^{*2}
 NO PICTURE	Internal memory/Card problem Take pictures before viewing them.
 PICTURE ERROR	Problem with selected image Use photo retouch software, etc. to view the image on a computer. If the image still cannot be viewed, the image file is corrupted.
 THE IMAGE CANNOT BE EDITED	Problem with selected image Use photo retouch software, etc. to edit the image on a computer.
 BATTERY EMPTY	Battery problem Charge the battery.
 NO CONNECTION	Connection problem Connect the camera and computer or printer correctly.
 NO PAPER	Printer problem Load paper into the printer.

 NO INK	Printer problem Refill the ink in the printer.
 JAMMED	Printer problem Remove the jammed paper.
SETTINGS CHANGED ^{*3}	Printer problem Return to the status where the printer can be used.
 PRINT ERROR	Printer problem Turn off the camera and printer, check the printer for any problems, and then turn the power on again.
 CANNOT PRINT ^{*4}	Problem with selected image Use a computer to print.

^{*1} Before erasing important images, download them to a computer.

^{*2} All data will be erased.

^{*3} This is displayed, for instance, when the printer's paper tray has been removed. Do not operate the printer while making the print settings on the camera.

^{*4} This camera may be unable to print images taken by other cameras.

Shooting tips

When you are unsure of how to take a picture that you envision, refer to the information below.

Focusing



“Focusing on the subject”

- **Taking a picture of a subject not in the center of the screen**

After focusing on an object at the same distance as the subject, compose the shot, and take the picture.

Pressing the shutter button halfway (p. 14)

- **Set [AF MODE] (p. 28) to [FACE/IESP]**
- **Taking a picture in [AF TRACKING] mode (p. 28)**

The camera tracks the subject movement automatically to focus on it continuously.

- **Taking a picture of subjects where autofocus is difficult**

In the following cases, after focusing on an object (by pressing the shutter button halfway down) with high contrast at the same distance as the subject, compose the shot, and take the picture.

Subjects with low contrast

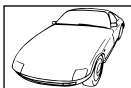

When extremely bright objects appear in the center of the screen



Object with no vertical lines¹⁾

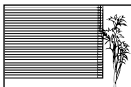

¹⁾ It is also effective to compose the shot by holding the camera vertically to focus, and then returning to the horizontal position to take the picture.

When objects are at different distances



Fast-moving object

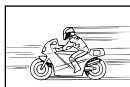

The subject is not in the center of the frame



Camera shake



“Taking pictures without camera shake”

- **Taking pictures using [M] mode (p. 20)**
- **Select [SPORT] in [SCN] mode (p. 20)**

The [SPORT] mode uses a fast shutter speed and can reduce the blur incurred by a moving subject.

- **Taking pictures at a high ISO sensitivity**

If a high ISO sensitivity is selected, pictures can be taken at a high shutter speed even at locations where a flash cannot be used.

“Selecting the ISO sensitivity” (p. 25)

Exposure (brightness)



“Taking pictures with the right brightness”

- **Taking pictures using [FILL IN] (p. 23) flash**
A subject against backlight is brightened.
- **Taking pictures using exposure compensation (p. 24)**

Adjust the brightness while viewing the screen for taking the picture. Normally, taking pictures of white subjects (such as snow) results in images that are darker than the actual subject. Use the exposure compensation to adjust in the positive (+) direction to express whites as they appear. When taking pictures of black subjects, on the other hand, it is effective to adjust in the negative (-) direction.

Color hue



“Taking pictures with colors at the same shade as they appear”

- Taking pictures by selecting white balance (p. 25)

Best results in most environments can normally be obtained with the [WB AUTO] setting, but for some subjects, you should try experimenting with different settings. (This is especially true for sunshade under a clear sky, mixed natural and artificial light settings, and so on.)

Image quality



“Taking sharper pictures”

- Taking pictures with the optical zoom

Avoid using digital zoom (p. 16) to take pictures.

- Taking pictures at a low ISO sensitivity

If the picture is taken with a high ISO sensitivity, noise (small colored spots and color unevenness that were not in the original image) can occur, and the image can appear grainy. The resulting image is grainier than with low ISO sensitivity as well.

“Selecting the ISO sensitivity” (p. 25)

Batteries



“Making batteries last longer”

- Avoid any of the following operations when not actually taking pictures because they deplete the battery power
 - Repeatedly pressing the shutter button halfway
 - Repeatedly using the zoom
- Set [POWER SAVE] (p. 36) to [ON]

Playback/Editing tips

Playback



“Playing images in the internal memory and card”

- Remove the card when playing pictures in the internal memory

“Inserting the battery and the SD/SDHC memory card (sold separately)” (p. 10)

Editing



“Erasing the sound recorded to a still image”

- Record over the sound with silence when playing back the image

“Adding sound to still images [🔊]” (p. 31)

Appendix

Camera care

Exterior

- Wipe gently with a soft cloth. If the camera is very dirty, soak the cloth in mild soapy water and wring well. Wipe the camera with the damp cloth and then dry it with a dry cloth. If you have used the camera at the beach, use a cloth soaked in clean water and wrung well.

Monitor

- Wipe gently with a soft cloth.

Lens

- Blow dust off the lens with a commercial blower, then wipe gently with a lens cleaner.

Battery/AC adapter

- Wipe gently with a soft, dry cloth.
 - ⚠ Do not use strong solvents such as benzene or alcohol, or chemically treated cloth.
 - ⚠ Mold may form on the lens surface if the lens is left dirty.

Storage

- When storing the camera for extended periods, remove the battery, AC adapter and card, and keep in a cool, dry place that is well ventilated.
- Periodically insert the battery and test the camera functions.
 - ⚠ Avoid leaving the camera in places where chemical products are handled since this may result in corrosion.

Battery and AC adapter (included)

- This camera uses one Olympus lithium ion battery (LI-42B/LI-40B). No other type of batteries can be used.
 - ⚠ **Caution:**
There is a risk of explosion if the battery is replaced with the incorrect battery type. Dispose of the used battery following the instructions. (p. 52)
- Power consumption by the camera varies depending on which functions are used.
- During the conditions described below, power is consumed continuously and the battery becomes exhausted quickly.
 - The zoom is used repeatedly.
 - The shutter button is pressed halfway repeatedly in shooting mode, activating the auto focus.
 - A picture is displayed on the monitor for an extended period of time.
 - The camera is connected to a computer or printer.
- Using an exhausted battery may cause the camera to turn off without displaying the battery level warning.
- The rechargeable battery is not fully charged at the time of purchase. Before use, charge the battery fully with the supplied F-2AC USB-AC adapter (hereafter referred to as AC adapter) or an optional AC adapter (D-7AC) or charger (LI-41C/LI-40C).
- When the included AC adapter is used, charging usually takes approximately 3 hours (varies on usage).
- The included AC adapter has been designed to be used only for charging. Make sure that operations such as shooting, viewing images and so on are not being used while the AC adapter is connected to the camera.
- The included AC adapter is designed to be used only with this camera. Other cameras cannot be charged with this AC adapter. Do not use with other devices.
- For plug-in type AC adapter:
The included AC adapter is intended to be correctly orientated in a vertical or floor mount position.

Using a separately sold AC adapter

A D-7AC AC adapter (sold separately) is useful for time-consuming tasks such as downloading images to a computer or when running a slideshow for a long period of time. A CB-MA1/ CB-MA3 multi-adapter (sold separately) is required when using a D-7AC AC adapter with this camera. To charge the battery, turn the camera off and connect the D-7AC AC adapter. Use only AC adapters approved for use with this camera.

Using a separately sold charger

A charger (LI-41C/LI-40C: sold separately) can be used to charge the battery. In this case, remove the battery from the camera.

Using your charger and AC adapter abroad

- The charger and AC adapter can be used in most home electrical sources within the range of 100 V to 240 V AC (50/60Hz) around the world. However, depending on the country or area you are in, the AC wall outlet may be shaped differently and the charger and AC adapter may require a plug adapter to match the wall outlet. For details, ask at your local electrical shop or travel agent.
- Do not use travel voltage converters as they could damage your charger and AC adapter.

Using an SD/SDHC memory card

A card (and internal memory) also corresponds to the film that records images in a film camera. Otherwise, the recorded images (data) can be erased, and retouching is also available with the use of a computer. Cards can be removed from the camera and exchanged, but this is not possible with the internal memory. Use of larger capacity cards enables you to take more pictures.

SD/SDHC card write-protect switch

The SD/SDHC card body has a write-protect switch. If you set the switch to the "LOCK" side, you will not be able to write to the card, delete data or format. Release the switch to enable writing.



Cards compatible with this camera

SD/SDHC memory cards (for more information, visit the Olympus website)



Using a new card

Cards must be formatted with this camera before first use or after being used with other cameras or computers.

[MEMORY FORMAT]/[FORMAT] (p. 32)

Checking the image saving location

The memory indicator shows whether the internal memory or card is being used during shooting and playback.

Current memory indicator

: Internal memory is being used

: Card is being used

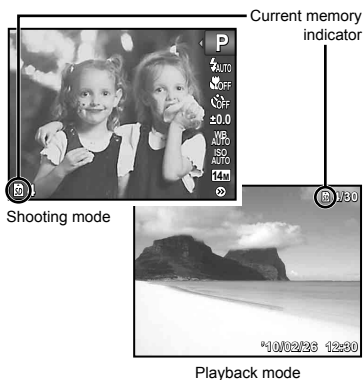

Readout/recording process of the card

During shooting, the current memory indicator lights in red while the camera is writing data. Never open the battery/card compartment cover or unplug the USB cable. This can not only damage the image data but also render the internal memory or card unusable.



- ⚠ Even if [MEMORY FORMAT]/[FORMAT], [ERASE], [SEL. IMAGE], or [ALL ERASE] is performed, the data in the card is not completely erased. When disposing of the card, damage the card to prevent the disclosure of personal data.

Number of storable pictures (still images)/Continuous recording length (movies) in the internal memory and SD/SDHC memory cards

! The figures for the number of storable still pictures and continuous recording length are approximate. The actual capacity varies with shooting conditions and the card used.

Still images

IMAGE SIZE	COMPRESSION	Number of storable still pictures			
		Internal memory		SD/SDHC memory card (1 GB)	
		With sound	Without sound	With sound	Without sound
14M 4288×3216	FINE	6	6	141	141
	NORM	13	13	276	279
9M 3264×2448	FINE	11	11	240	242
	NORM	22	22	465	473
5M 2560×1920	FINE	18	18	383	388
	NORM	37	38	776	797
3M 2048×1536	FINE	29	30	611	624
	NORM	57	59	1,187	1,236
2M 1600×1200	FINE	47	48	977	1,009
	NORM	88	94	1,835	1,954
1M 1280×960	FINE	71	75	1,477	1,553
	NORM	133	146	2,753	3,028
VGA 640×480	FINE	225	266	4,659	5,506
	NORM	366	488	7,571	10,095
16:9 1920×1080	FINE	43	45	904	931
	NORM	83	88	1,730	1,835

Movies



IMAGE SIZE	FRAME RATE	Continuous recording length			
		Internal memory		SD/SDHC memory card (1 GB)	
		With sound	Without sound	With sound	Without sound
1080i 640×480	30p	25 sec.	26 sec.	8 min. 55 sec.	8 min. 58 sec.
	15p	51 sec.	52 sec.	17 min. 44 sec.	17 min. 56 sec.
720p 320×240	30p	1 min. 9 sec.	1 min. 11 sec.	24 min. 5 sec.	24 min. 27 sec.
	15p	2 min. 17 sec.	2 min. 22 sec.	47 min. 27 sec.	48 min. 54 sec.

! The maximum file size of a single movie is 2 GB, regardless of the capacity of the card.

Increasing the number of pictures that can be taken

Either erase unwanted images, or connect the camera to a computer or other device to save the images, and then erase the images in the internal memory or card. [ERASE] (p. 18, 30), [SEL. IMAGE] (p. 30), [ALL ERASE] (p. 30), [MEMORY FORMAT]/[FORMAT] (p. 32)

SAFETY PRECAUTIONS

	CAUTION RISK OF ELECTRIC SHOCK DO NOT OPEN	
CAUTION: TO REDUCE THE RISK OF ELECTRICAL SHOCK, DO NOT REMOVE COVER (OR BACK). NO USER-SERVICEABLE PARTS INSIDE. REFER SERVICING TO QUALIFIED OLYMPUS SERVICE PERSONNEL.		



An exclamation mark enclosed in a triangle alerts you to important operating and maintenance instructions in the documentation provided with the product.



DANGER

If the product is used without observing the information given under this symbol, serious injury or death may result.



WARNING

If the product is used without observing the information given under this symbol, injury or death may result.



CAUTION

If the product is used without observing the information given under this symbol, minor personal injury, damage to the equipment, or loss of valuable data may result.

WARNING!

TO AVOID THE RISK OF FIRE OR ELECTRICAL SHOCK, NEVER DISASSEMBLE, EXPOSE THIS PRODUCT TO WATER OR OPERATE IN A HIGH HUMIDITY ENVIRONMENT.

General Precautions

Read All Instructions — Before you use the product, read all operating instructions. Save all manuals and documentation for future reference.

Cleaning — Always unplug this product from the wall outlet before cleaning. Use only a damp cloth for cleaning. Never use any type of liquid or aerosol cleaner, or any type of organic solvent to clean this product.

Attachments — For your safety, and to avoid damaging the product, use only accessories recommended by Olympus.

Water and Moisture — For precautions on products with weatherproof designs, read the weatherproofing sections.

Location — To avoid damage to the product, mount the product securely on a stable tripod, stand, or bracket.

Power Source — Connect this product only to the power source described on the product label.

Lightning — If a lightning storm occurs while using an AC adapter, remove it from the wall outlet immediately.

Foreign Objects — To avoid personal injury, never insert a metal object into the product.

Heat — Never use or store this product near any heat source such as a radiator, heat register, stove, or any type of equipment or appliance that generates heat, including stereo amplifiers.

Handling the Camera



WARNING

- Do not use the camera near flammable or explosive gases.
- Do not use the flash and LED on people (infants, small children, etc.) at close range.
 - You must be at least 1 m (3 ft.) away from the faces of your subjects. Firing the flash too close to the subject's eyes could cause a momentary loss of vision.
- Keep young children and infants away from the camera.
 - Always use and store the camera out of the reach of young children and infants to prevent the following dangerous situations which could cause serious injury:
 - Becoming entangled in the camera strap, causing strangulation.
 - Accidentally swallowing the battery, cards or other small parts.
 - Accidentally firing the flash into their own eyes or those of another child.
 - Accidentally being injured by the moving parts of the camera.
- Do not look at the sun or strong lights with the camera.
- Do not use or store the camera in dusty or humid places.
- Do not cover the flash with a hand while firing.
- Use SD/SDHC memory cards only. Never use other types of cards.

If you accidentally insert another type of card into the camera, contact an authorized distributor or service center. Do not try to remove the card by force.



CAUTION

- Stop using the camera immediately if you notice any unusual odors, noise, or smoke around it.
 - Never remove the batteries with bare hands, which may cause a fire or burn your hands.
- Never hold or operate the camera with wet hands.
- Do not leave the camera in places where it may be subject to extremely high temperatures.
 - Doing so may cause parts to deteriorate and, in some circumstances, cause the camera to catch fire. Do not use the charger or AC adapter if it is covered (such as a blanket). This could cause overheating, resulting in fire.

- **Handle the camera with care to avoid getting a low-temperature burn.**
 - When the camera contains metal parts, overheating can result in a low-temperature burn. Pay attention to the following:
 - When used for a long period, the camera will get hot. If you hold on to the camera in this state, a low-temperature burn may be caused.
 - In places subject to extremely cold temperatures, the temperature of the camera's body may be lower than the environmental temperature. If possible, wear gloves when handling the camera in cold temperatures.
- **Be careful with the strap.**
 - Be careful with the strap when you carry the camera. It could easily catch on stray objects and cause serious damage.

Battery Handling Precautions

Follow these important guidelines to prevent batteries from leaking, overheating, burning, exploding, or causing electrical shocks or burns.

DANGER

- The camera uses a lithium ion battery specified by Olympus. Charge the battery with the specified AC adapter or charger. Do not use any other AC adapters or chargers.
- Never heat or incinerate batteries.
- Take precautions when carrying or storing batteries to prevent them from coming into contact with any metal objects such as jewelry, pins, fasteners, etc.
- Never store batteries where they will be exposed to direct sunlight, or subjected to high temperatures in a hot vehicle, near a heat source, etc.
- To prevent causing battery leaks or damaging their terminals, carefully follow all instructions regarding the use of batteries. Never attempt to disassemble a battery or modify it in any way, solder, etc.
- If battery fluid gets into your eyes, flush your eyes immediately with clear, cold running water and seek medical attention immediately.
- Always store batteries out of the reach of small children. If a child accidentally swallows a battery, seek medical attention immediately.

WARNING

- Keep batteries dry at all times.
- To prevent batteries from leaking, overheating, or causing a fire or explosion, use only batteries recommended for use with this product.
- Insert the battery carefully as described in the operating instructions.
- If rechargeable batteries have not been recharged within the specified time, stop charging them and do not use them.

- Do not use a battery if it is cracked or broken.
- If a battery leaks, becomes discolored or deformed, or becomes abnormal in any other way during operation, stop using the camera.
- If a battery leaks fluid onto your clothing or skin, remove the clothing and flush the affected area with clean, running cold water immediately. If the fluid burns your skin, seek medical attention immediately.
- Never subject batteries to strong shocks or continuous vibration.

CAUTION

- Before loading, always inspect the battery carefully for leaks, discoloration, warping, or any other abnormality.
- The battery may become hot during prolonged use. To avoid minor burns, do not remove it immediately after using the camera.
- Always unload the battery from the camera before storing the camera for a long period.

Caution for Usage Environment

- To protect the high-precision technology contained in this product, never leave the camera in the places listed below, no matter if in use or storage:
 - Places where temperatures and/or humidity are high or go through extreme changes. Direct sunlight, beaches, locked cars, or near other heat sources (stove, radiator, etc.) or humidifiers.
 - In sandy or dusty environments.
 - Near flammable items or explosives.
 - In wet places, such as bathrooms or in the rain. When using products with weatherproof designs, read their manuals as well.
 - In places prone to strong vibrations.
- Never drop the camera or subject it to severe shocks or vibrations.
- When mounted on a tripod, adjust the position of the camera with the tripod head. Do not twist the camera.
- Do not touch electric contacts on cameras.
- Do not leave the camera pointed directly at the sun. This may cause lens or shutter curtain damage, color failure, ghosting on the CCD, or may possibly cause fires.
- Do not push or pull severely on the lens.
- Before storing the camera for a long period, remove the batteries. Select a cool, dry location for storage to prevent condensation or mold from forming inside the camera. After storage, test the camera by turning it on and pressing the shutter button to make sure that it is operating normally.
- Always observe the operating environment restrictions described in the camera's manual.

Battery Handling Precautions

- This camera uses a lithium ion battery specified by Olympus. Do not use any other type of battery.
- If the battery's terminals get wet or greasy, camera contact failure may result. Wipe the battery well with a dry cloth before use.
- Always charge a battery when using it for the first time, or if it has not been used for a long period.
- When operating the camera with battery power at low temperatures, try to keep the camera and spare battery as warm as possible. A battery that has run down at low temperatures may be restored after it is warmed at room temperature.
- The number of pictures you can take may vary depending on the shooting conditions or battery.
- Before going on a long trip, and especially before traveling abroad, purchase extra batteries. A recommended battery may be difficult to obtain while traveling.
- Please recycle batteries to help save our planet's resources. When you throw away dead batteries, be sure to cover their terminals and always observe local laws and regulations.

LCD Monitor

- Do not push the monitor forcibly; otherwise the image may become vague, resulting in a playback mode failure or damage to the monitor.
- A strip of light may appear on the top/bottom of the monitor, but this is not a malfunction.
- When a subject is viewed diagonally in the camera, the edges may appear zigzagged on the monitor. This is not a malfunction; it will be less noticeable in playback mode.
- In places subject to low temperatures, the LCD monitor may take a long time to turn on or its color may change temporarily. When using the camera in extremely cold places, it is a good idea to occasionally place it in a warm place. An LCD monitor exhibiting poor performance due to low temperatures will recover in normal temperatures.
- The LCD used for the monitor is made with high-precision technology. However, black spots or bright spots of light may appear constantly on the LCD Monitor. Due to its characteristics or the angle at which you are viewing the monitor, the spot may not be uniform in color and brightness. This is not a malfunction.

Legal and Other Notices

- Olympus makes no representations or warranties regarding any damages, or benefit expected by using this unit lawfully, or any request from a third person, which are caused by the inappropriate use of this product.
- Olympus makes no representations or warranties regarding any damages or any benefit expected by using this unit lawfully which are caused by erasing picture data.

Disclaimer of Warranty

- Olympus makes no representations or warranties, either expressed or implied, by or concerning any content of these written materials or software, and in no event shall be liable for any implied warranty of merchantability or fitness for any particular purpose or for any consequential, incidental or indirect damages (including but not limited to damages for loss of business profits, business interruption and loss of business information) arising from the use or inability to use these written materials or software or equipment. Some countries do not allow the exclusion or limitation of liability for consequential or incidental damages or of the implied warranty, so the above limitations may not apply to you.
- Olympus reserves all rights to this manual.

Warning

Unauthorized photographing or use of copyrighted material may violate applicable copyright laws. Olympus assumes no responsibility for unauthorized photographing, use or other acts that infringe upon the rights of copyright owners.

Copyright Notice

All rights reserved. No part of these written materials or this software may be reproduced or used in any form or by any means, electronic or mechanical, including photocopying and recording or the use of any type of information storage and retrieval system, without the prior written permission of Olympus. No liability is assumed with respect to the use of the information contained in these written materials or software, or for damages resulting from the use of the information contained therein. Olympus reserves the right to alter the features and contents of this publication or software without obligation or advance notice.

FCC Notice

- Radio and Television Interference
- Changes or modifications not expressly approved by the manufacturer may void the user's authority to operate this equipment. This equipment has been tested and found to comply with the limits for a Class B digital device, pursuant to Part 15 of the FCC Rules. These limits are designed to provide reasonable protection against harmful interference in a residential installation.
- This equipment generates, uses, and can radiate radio frequency energy and, if not installed and used in accordance with the instructions, may cause harmful interference to radio communications.
- However, there is no guarantee that interference will not occur in a particular installation. If this equipment does cause harmful interference to radio or television reception, which can be determined by turning the equipment off and on, the user is encouraged to try to correct the interference by one or more of the following measures:
 - Adjust or relocate the receiving antenna.
 - Increase the distance between the camera and receiver.
 - Connect the equipment to an outlet on a circuit different from that to which the receiver is connected.
 - Consult your dealer or an experienced radio/TV technician for help. Only the OLYMPUS-supplied USB cable should be used to connect the camera to USB enabled personal computers (PC).

Any unauthorized changes or modifications to this equipment would void the user's authority to operate it.

Use Only Dedicated Rechargeable Battery, Battery Charger and AC adapter

We strongly recommend that you use only the genuine Olympus dedicated rechargeable battery, battery charger and AC adapter with this camera. Using a non-Olympus rechargeable battery, battery charger and/or AC adapter may result in fire or personal injury due to leakage, heating, ignition or damage to the battery. Olympus does not assume any liability for accidents or damage that may result from the use of a battery, battery charger and/or AC adapter that are not genuine Olympus accessories.

Representative plug of power supply cord of countries/regions around the world



A Type
(American Type)



B Type
(British Type)



BF Type
(British Type)



B3 Type
(British Type)



C Type
(CEE Type)



SE Type
(CEE Type)



O Type
(Oceania Type)

The representative supply voltage and plug type are described in this chart.
Depending on the area, different types of plugs and supply voltages are used.

Attention: Power cord meeting demands from each country shall be used.

- For only the United States

Use a UL Listed, 1.5 - 4.5 m (5 - 15 ft), Type SPT-2 or NISPT-2, AWG no. 18 power supply cord, rated for 125 V 7 A, with a non-polarized NEMA 1-15P plug rated for 125 V 15 A*.

Europe

Countries/Regions	Voltage	Frequency (Hz)	Plug type
Austria	230	50	C
Belgium	230	50	C
Czech	220	50	C
Denmark	230	50	C
Finland	230	50	C
France	230	50	C
Germany	230	50	C
Greece	220	50	C
Hungary	220	50	C
Iceland	230	50	C
Ireland	230	50	C/BF
Italy	220	50	C
Luxemburg	230	50	C
Netherlands	230	50	C
Norway	230	50	C
Poland	220	50	C
Portugal	230	50	C
Romania	220	50	C
Russia	220	50	C
Slovak	220	50	C
Spain	127/230	50	C
Sweden	230	50	C
Switzerland	230	50	C
UK	240	50	BF

Asia

Countries/Regions	Voltage	Frequency (Hz)	Plug type
China	220	50	A
Hong Kong	200/220	50	BF
India	230/240	50	C
Indonesia	127/230	50	C
Japan	100	50/60	A
Korea (rep)	220	60	C
Malaysia	240	50	BF
Philippines	220/230	60	A/C
Singapore	230	50	BF
Taiwan	110	60	A
Thailand	220	50	C/BF
Vietnam	220	50	A/C

Oceania

Countries/Regions	Voltage	Frequency (Hz)	Plug type
Australia	240	50	O
New Zealand	230/240	50	O

North America

Countries/Regions	Voltage	Frequency (Hz)	Plug type
Canada	120	60	A
USA	120	60	A

Central America

Countries/Regions	Voltage	Frequency (Hz)	Plug type
Bahamas	120/240	60	A
Costa Rica	110	60	A
Cuba	110/220	60	A/C
Dominican (rep)	110	60	A
El Salvador	110	60	A
Guatemala	120	60	A
Honduras	110	60	A
Jamaica	110	50	A
Mexico	120/127	60	A
Nicaragua	120/240	60	A
Panama	110/220	60	A

South America

Countries/Regions	Voltage	Frequency (Hz)	Plug type
Argentina	220	50	C/BF/O
Brazil	127/220	60	A/C
Chile	220	50	C
Colombia	120	60	A
Peru	220	60	A/C
Venezuela	120	60	A

Middle East

Countries/Regions	Voltage	Frequency (Hz)	Plug type
Iran	220	50	C/BF
Iraq	220	50	C/BF
Israel	230	50	C
Saudi Arabia	127/220	50	A/C/BF
Turkey	220	50	C
UAE	240	50	C/BF

Africa

Countries/Regions	Voltage	Frequency (Hz)	Plug type
Algeria	127/220	50	C
Congo (dem)	220	50	C
Egypt	220	50	C
Ethiopia	220	50	C
Kenya	240	50	C/BF
Nigeria	230	50	C/BF
South Africa	220/230	50	C/BF
Tanzania	230	50	C/BF
Tunisia	220	50	C

For customers in North and South America

For customers in USA

Declaration of Conformity

Model Number : FE-4030

Trade Name : OLYMPUS

Responsible Party :
OLYMPUS IMAGING AMERICA INC.

Address : 3500 Corporate
Parkway, P.O. Box
610, Center Valley, PA
18034-0610, U.S.A.

Telephone Number : 484-896-5000

Tested To Comply With FCC Standards
FOR HOME OR OFFICE USE

This device complies with Part 15 of the FCC rules.
Operation is subject to the following two conditions:

- (1) This device may not cause harmful interference.
- (2) This device must accept any interference received, including interference that may cause undesired operation.

For customers in Canada

This Class B digital apparatus meets all requirements of the Canadian Interference-Causing Equipment Regulations.

OLYMPUS WORLDWIDE LIMITED WARRANTY - IMAGING PRODUCTS

Olympus warrants that the enclosed Olympus® imaging product(s) and related Olympus® accessories (individually a "Product" and collectively the "Products") will be free from defects in materials and workmanship under normal use and service for a period of one (1) year from the date of purchase.

If any Product proves to be defective within the one-year warranty period, the customer must return the defective Product to any of Olympus Service Centers, following the procedure set forth below (See "WHAT TO DO WHEN SERVICE IS NEEDED").

Olympus, at its sole discretion, will repair, replace, or adjust the defective Product, provided that Olympus investigation and factory inspection disclose that (a) such defect developed under normal and proper use and (b) the Product is covered under this limited warranty.

Repair, replacement, or adjustment of defective Products shall be Olympus's sole obligation and the customer's sole remedy hereunder.

The customer is liable and shall pay for shipment of the Products to the Olympus Service Center. Olympus shall not be obligated to perform

preventive maintenance, installation, deinstallation, or maintenance.

Olympus reserves the right to (i) use reconditioned, refurbished, and/or serviceable used parts (that meet Olympus's quality assurance standards) for warranty or any external repairs and (ii) make any internal or external design and/or feature changes on or to its products without any liability to incorporate such changes on or to the Products.

WHAT IS NOT COVERED BY THIS LIMITED WARRANTY

Excluded from this limited warranty and not warranted by Olympus in any fashion, either express, implied, or by statute, are:

- (a) products and accessories not manufactured by Olympus and/or not bearing the "OLYMPUS" brand label (the warranty coverage for products and accessories of other manufacturers, which may be distributed by Olympus, is the responsibility of the manufacturers of such products and accessories in accordance with the terms and duration of such manufacturers' warranties);
- (b) any Product which has been disassembled, repaired, tampered with, altered, changed, or modified by persons other than Olympus's own authorized service personnel unless repair by others is made with the written consent of Olympus;
- (c) defects or damage to the Products resulting from wear, tear, misuse, abuse, negligence, sand, liquids, impact, improper storage, nonperformance of scheduled operator and maintenance items, battery leakage, use of non-"OLYMPUS" brand accessories, consumables, or supplies, or use of the Products in combination with non-compatible devices;
- (d) software programs;
- (e) supplies and consumables (including but not limited to lamps, ink, paper, film, prints, negatives, cables and batteries); and/or
- (f) Products which do not contain a validly placed and recorded Olympus serial number, unless they are a model on which Olympus does not place and record serial numbers.

EXCEPT FOR THE LIMITED WARRANTY SET FORTH ABOVE, OLYMPUS MAKES NO AND DISCLAIMS ALL OTHER REPRESENTATIONS, GUARANTIES, CONDITIONS, AND WARRANTIES CONCERNING THE PRODUCTS, WHETHER DIRECT OR INDIRECT, EXPRESS OR IMPLIED, OR ARISING UNDER ANY STATUTE, ORDINANCE, COMMERCIAL USAGE OR OTHERWISE, INCLUDING BUT NOT LIMITED TO ANY WARRANTY OR REPRESENTATION AS TO THE SUITABILITY, DURABILITY, DESIGN, OPERATION, OR

CONDITION OF THE PRODUCTS (OR ANY PART THEREOF) OR THE MERCHANTABILITY OF THE PRODUCTS OR THEIR FITNESS FOR A PARTICULAR PURPOSE, OR RELATING TO THE INFRINGEMENT OF ANY PATENT, COPYRIGHT, OR OTHER PROPRIETARY RIGHT USED OR INCLUDED THEREIN.

IF ANY IMPLIED WARRANTIES APPLY AS A MATTER OF LAW, THEY ARE LIMITED IN DURATION TO THE LENGTH OF THIS LIMITED WARRANTY.

SOME STATES MAY NOT RECOGNIZE A DISCLAIMER OR LIMITATION OF WARRANTIES AND/OR LIMITATION OF LIABILITY SO THE ABOVE DISCLAIMERS AND EXCLUSIONS MAY NOT APPLY.

THE CUSTOMER MAY ALSO HAVE DIFFERENT AND/OR ADDITIONAL RIGHTS AND REMEDIES THAT VARY FROM STATE TO STATE.

THE CUSTOMER ACKNOWLEDGES AND AGREES THAT OLYMPUS SHALL NOT BE RESPONSIBLE FOR ANY DAMAGES THAT THE CUSTOMER MAY INCUR FROM DELAYED SHIPMENT, PRODUCT FAILURE, PRODUCT DESIGN, SELECTION, OR PRODUCTION, IMAGE OR DATA LOSS OR IMPAIRMENT OR FROM ANY OTHER CAUSE, WHETHER LIABILITY IS ASSERTED IN CONTRACT, TORT (INCLUDING NEGLIGENCE AND STRICT PRODUCT LIABILITY) OR OTHERWISE. IN NO EVENT SHALL OLYMPUS BE LIABLE FOR ANY INDIRECT, INCIDENTAL, CONSEQUENTIAL OR SPECIAL DAMAGES OF ANY KIND (INCLUDING WITHOUT LIMITATION LOSS OF PROFITS OR LOSS OF USE), WHETHER OR NOT OLYMPUS SHALL BE OR SHOULD BE AWARE OF THE POSSIBILITY OF SUCH POTENTIAL LOSS OR DAMAGE.

Representations and warranties made by any person, including but not limited to dealers, representatives, salespersons, or agents of Olympus, which are inconsistent or in conflict with or in addition to the terms of this limited warranty, shall not be binding upon Olympus unless reduced to writing and approved by an expressly authorized officer of Olympus. This limited warranty is the complete and exclusive statement of warranty which Olympus agrees to provide with respect to the Products and it shall supersede all prior and contemporaneous oral or written agreements, understandings, proposals, and communications pertaining to the subject matter hereof. This limited warranty is exclusively for the benefit of the original customer and cannot be transferred or assigned.

WHAT TO DO WHEN SERVICE IS NEEDED

The customer must transfer any image or other data saved on a Product to another image or data storage medium and/or remove any film from the Product prior to sending the Product to Olympus for service.

IN NO EVENT SHALL OLYMPUS BE RESPONSIBLE FOR SAVING, KEEPING OR MAINTAINING ANY IMAGE OR DATA SAVED ON A PRODUCT RECEIVED BY IT FOR SERVICE, OR ON ANY FILM CONTAINED WITHIN A PRODUCT RECEIVED BY IT FOR SERVICE, NOR SHALL OLYMPUS BE RESPONSIBLE FOR ANY DAMAGES IN THE EVENT ANY IMAGE OR DATA IS LOST OR IMPAIRED WHILE SERVICE IS BEING PERFORMED (INCLUDING, WITHOUT LIMITATION, DIRECT, INDIRECT, INCIDENTAL, CONSEQUENTIAL OR SPECIAL DAMAGES, LOSS OF PROFITS OR LOSS OF USE), WHETHER OR NOT OLYMPUS SHALL BE OR SHOULD BE AWARE OF THE POSSIBILITY OF SUCH POTENTIAL LOSS OR IMPAIRMENT.

Package the Product carefully using ample padding material to prevent damage in transit and either deliver it to the Authorized Olympus Dealer that sold you the Product or ship it postage prepaid and insured to any of our Olympus Service Centers.

When returning Products for service, your package should include the following:

- 1 Sales receipt showing date and place of purchase.
- 2 Copy of this limited warranty **bearing the Product serial number corresponding to the serial number on the Product** (unless it is a model on which Olympus does not place and record serial numbers).
- 3 A detailed description of the problem.
- 4 Sample prints, negatives, digital prints (or files on disk) if available and related to the problem.

When service is completed, the Product will be returned to you postage prepaid.

WHERE TO SEND PRODUCT FOR SERVICE

See "WORLDWIDE WARRANTY" for the nearest service center.

INTERNATIONAL WARRANTY SERVICE

International warranty service is available under this warranty.

For customers in Europe



"CE" mark indicates that this product complies with the European requirements for safety, health, environment and customer protection. "CE" mark cameras are intended for sales in Europe.



This symbol [crossed-out wheeled bin WEEE Annex IV] indicates separate collection of waste electrical and electronic equipment in the EU countries.

Please do not throw the equipment into the domestic refuse.

Please use the return and collection systems available in your country for the disposal of this product.



This symbol [crossed-out wheeled bin Directive 2006/66/EC Annex II] indicates separate collection of waste batteries in the EU countries. Please do not throw the batteries into the domestic refuse. Please use the return and collection systems available in your country for the disposal of the waste batteries.

Provisions of warranty

- 1 If this product proves to be defective, although it has been used properly (in accordance with the written Handling Care and Operating instructions supplied with it), during the applicable national warranty period and has been purchased from an authorized Olympus distributor within the business area of Olympus Europa Holding GmbH as stipulated on the website: <http://www.olympus.com> this product will be repaired, or at Olympus's option replaced, free of charge. To claim under this warranty the customer must take the product before the end of the applicable national warranty period to the dealer where the product was purchased or any other Olympus service station within the business area of Olympus Europa Holding GmbH as stipulated on the website: <http://www.olympus.com>. During the one year period of the World Wide Guarantee the customer may turn the product in at any Olympus service station. Please notice that not in all countries such Olympus service station exists.
- 2 The customer shall transport the product to the dealer or Olympus authorized service station at his own risk and shall be responsible for any costs incurred in transporting the product.

Provisions of Guarantee

- 1 "OLYMPUS IMAGING CORP., Shinjuku Monolith, 2-3-1 Nishi-Shinjuku, Shinjuku-ku, Tokyo 163-0914, Japan grants a one year World Wide Guarantee. This worldwide Guarantee must be presented at an Olympus authorized repair service station before any repair can be made under conditions of this Guarantee. This Guarantee is valid only if the Guarantee Certificate and proof of purchase are presented at the Olympus repair service station. Please note that this Guarantee is in addition to and does not

affect the customer's legal warranty rights under the applicable national legislation governing the sale of consumer goods mentioned above.

- 2 This Guarantee does not cover the following and the customer will be required to pay repair charge, even for defects occurring within the Guarantee period referred to above.
 - a. Any defect that occurs due to mishandling (such as an operation performed that is not mentioned in the Handling Care or other sections of the instructions, etc.)
 - b. Any defect that occurs due to repair, modification, cleaning, etc. performed by anyone other than Olympus or an Olympus authorized service station.
 - c. Any defect or damage that occurs due to transport, a fall, shock, etc. after purchase of the product.
 - d. Any defect or damage that occurs due to fire, earthquake, flood damage, thunderbolt, other natural disasters, environmental pollution and irregular voltage sources.
 - e. Any defect that occurs due to careless or improper storage (such as keeping the product under conditions of high temperature and humidity, near insect repellents such as naphthalene or harmful drugs, etc.), improper maintenance, etc.
 - f. Any defect that occurs due to exhausted batteries, etc.
 - g. Any defect that occurs due to sand, mud, etc. entering the inside of the product casing.
 - h. When the Guarantee Certificate is not returned with the product.
 - i. When any alterations whatsoever are made to the Guarantee Certificate regarding the year, month and date of purchase, the customer's name, the dealer's name, and the serial number.
 - j. When proof of purchase is not presented with this Guarantee Certificate.
- 3 This Guarantee applies to the product only; the Guarantee does not apply to any other accessory equipment, such as the case, strap, lens cap and batteries.
- 4 Olympus's sole liability under this Guarantee shall be limited to repairing or replacing the product. Any liability under the Guarantee for indirect or consequential loss or damage of any kind incurred or suffered by the customer due to a defect of the product, and in particular any loss or damage caused to any lenses, films, other equipment or accessories used with the product or for any loss resulting from a delay in repair or loss of data, is excluded. Compelling regulations by law remain unaffected by this.

Notes regarding Guarantee maintenance

- 1 This Guarantee will only be valid if the Guarantee Certificate is duly completed by Olympus or an authorized dealer or other documents contain sufficient proof. Therefore, please make sure that your name, the name of the dealer, the serial number and the year, month and date of purchase are all completed or the original invoice or the sales receipt (indicating the dealer's name, the date of purchase and product type) is attached to this Guarantee Certificate. Olympus reserves the right to refuse free-of-charge service if neither Guarantee Certificate is completed nor the above document is attached or if the information contained in it is incomplete or illegible.
 - 2 Since this Guarantee Certificate will not be re-issued, keep it in a safe place.
- * Please refer to the list on the web site: <http://www.olympus.com> for the authorized international Olympus service network.

Trademarks

- IBM is a registered trademark of International Business Machines Corporation.
- Microsoft and Windows are registered trademarks of Microsoft Corporation.
- Macintosh is a trademark of Apple Inc.
- SDHC logo is a trademark.
- All other company and product names are registered trademarks and/or trademarks of their respective owners.
- The standards for camera file systems referred to in this manual are the "Design rule for Camera File system/DCF" standards stipulated by the Japan Electronics and Information Technology Industries Association (JEITA).

SPECIFICATIONS

Camera

Product type	: Digital camera (for shooting and displaying)
Recording system	
Still pictures	: Digital recording, JPEG (in accordance with Design rule for Camera File system (DCF))
Applicable standards	: Exif 2.2, Digital Print Order Format (DPOF), PRINT Image Matching III, PictBridge
Sound with still pictures	: Wave format
Movie	: AVI Motion JPEG
Memory	: Internal memory SD memory card SDHC memory card
No. of effective pixels	: 14,000,000 pixels
Image pickup device	: 1/2.33" CCD (primary color filter), 14,500,000 pixels (gross)
Lens	: Olympus lens 4.7 to 18.6 mm, f2.6 to 5.9 (equivalent to 26 to 105 mm on a 35 mm camera)
Photometric system	: Digital ESP metering system
Shutter speed	: 4 to 1/2000 sec.
Shooting range	: 0.6 m (2.0 ft.) to ∞ (W), 1.0 m (3.3 ft.) to ∞ (T) (normal) 0.15 m (0.5 ft.) to ∞ (W), 0.6 m (2.0 ft.) to ∞ (T) (macro mode) 0.04 m (0.13 ft.) to ∞ (super macro mode)
Monitor	: 2.7" TFT color LCD display, 230,000 dots
Connector	: Multi-connector (DC-IN jack, USB connector, A/V OUT jack)
Automatic calendar system	: 2000 up to 2099
Operating environment	
Temperature	: 0 °C to 40 °C (32 °F to 104 °F) (operation/ -20 °C to 60 °C (-4 °F to 140 °F) (storage)
Humidity	: 30 % to 90 % (operation)/10 % to 90 % (storage)
Power supply	: One Olympus lithium ion battery (LI-42B/LI-40B) or an AC adapter (sold separately)
Dimensions	: 92.5 mm (W) × 55.5 mm (H) × 21.6 mm (D) (3.6 × 2.2 × 0.9 in.) (excluding protrusions)
Weight	: 99.4 g (3.5 oz) (excluding battery and card)

Lithium ion battery (LI-42B)

Product type	: Lithium ion rechargeable battery
Standard voltage	: DC 3.7 V
Standard capacity	: 740 mAh
Battery life	: Approx. 300 full charges (varies on usage)
Operating environment	
Temperature	: 0°C to 40°C (32°F to 104°F) (charging)/ -10°C to 60°C (14°F to 140°F) (operation)/ -20°C to 35°C (-4°F to 95°F) (storage)
Dimensions	: 31.5 mm (W) × 39.5 mm (H) × 6.0 mm (D) (1.2 × 1.5 × 0.2 in.)
Weight	: Approx. 15 g (0.5 oz)

USB-AC adapter (F-2AC)

Model No.	: F-2AC-1A/F-2AC-2A/F-2AC-1B/F-2AC-2B
Power requirements	: AC 100 to 240 V (50/60 Hz)
Output	: DC 5 V, 500 mA
Charging time	: Approx. 3 hours
Operating environment	
Temperature	: 0 °C to 40 °C (32 °F to 104 °F) (operation)/ -20 °C to 60 °C (-4 °F to 140 °F) (storage)
Dimensions	: 50.0 mm (W) × 54.0 mm (H) × 22.0 mm (D) (2.0 × 2.1 × 0.9 in.)
Weight	: Approx. 46 g (1.6 oz) (F-2AC-1A)/Approx. 42 g (1.5 oz) (F-2AC-2A)/ Approx. 44 g (1.6 oz) (F-2AC-1B)/Approx. 40 g (1.4 oz) (F-2AC-2B)

Design and specifications subject to change without notice.



<http://www.olympus.com/>

OLYMPUS IMAGING CORP.

Shinjuku Monolith, 3-1 Nishi-Shinjuku 2-chome, Shinjuku-ku, Tokyo, Japan

OLYMPUS IMAGING AMERICA INC.

3500 Corporate Parkway, P.O. Box 610, Center Valley, PA 18034-0610, U.S.A. Tel. 484-896-5000

Technical Support (USA)

24/7 online automated help: <http://www.olympusamerica.com/support>

Phone customer support: Tel. 1-888-553-4448 (Toll-free)

Our phone customer support is available from 8 am to 10 pm

(Monday to Friday) ET

<http://olympusamerica.com/contactus>

Olympus software updates can be obtained at: <http://www.olympusamerica.com/digital>

OLYMPUS EUROPA HOLDING GMBH

Premises: Wendenstrasse 14-18, 20097 Hamburg, Germany

Tel: +49 40-23 77 3-0 / Fax: +49 40-23 07 61

Goods delivery: Bredowstrasse 20, 22113 Hamburg, Germany

Letters: Postfach 10 49 08, 20034 Hamburg, Germany

European Technical Customer Support:

Please visit our homepage <http://www.olympus-europa.com>

or call our TOLL FREE NUMBER* : **00800 - 67 10 83 00**

for Austria, Belgium, Denmark, Finland, France, Germany, Italy, Luxemburg, Netherlands, Norway, Portugal, Spain, Sweden, Switzerland, United Kingdom

* Please note some (mobile) phone services providers do not permit access or request an additional prefix to +800 numbers.

For all European Countries not listed and in case that you can't get connected

to the above mentioned number, please make use of the following

CHARGED NUMBERS: **+49 180 5 - 67 10 83** or **+49 40 - 237 73 4899**

Our Technical Customer Support is available from 9 am to 6 pm MET (Monday to Friday)

Free Manuals Download Website

<http://myh66.com>

<http://usermanuals.us>

<http://www.somanuals.com>

<http://www.4manuals.cc>

<http://www.manual-lib.com>

<http://www.404manual.com>

<http://www.luxmanual.com>

<http://aubethermostatmanual.com>

Golf course search by state

<http://golfingnear.com>

Email search by domain

<http://emailbydomain.com>

Auto manuals search

<http://auto.somanuals.com>

TV manuals search

<http://tv.somanuals.com>