

IVIE Enterprises

www.ivie-ent.com Ph:(918)254-5161 or (888)262-5161 Fax:(918)250-4807

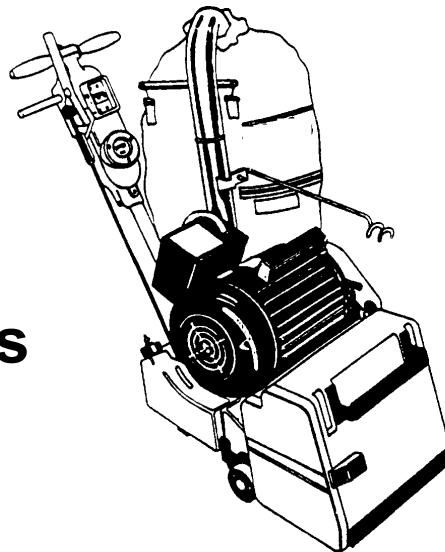

**Operator's
Manual**



**Classic 12
Belt Sander**

READ THIS BOOK

This book has important information for the use and safe operation of this machine. Failure to read this book prior to operating or attempting any service or maintenance procedure to your ALTO machine could result in injury to you or to other personnel; damage to the machine or to other property could occur as well. You must have training in the operation of this machine before using it. If you cannot read English, have this manual explained fully before attempting to operate this machine.

Si Ud. o sus operadores no pueden leer el Inglés, se hagan explicar este manual completamente antes de tratar el manejo o servicio de esta máquina.

All directions given in this book are as seen from the operator's position at the rear of the machine.

For new books write to: ALTO U.S. INC., 2100 Highway 265, Springdale, Arkansas 72764.

Contents of this Book

Section I - Operator's Manual

Operator Safety Instructions	3
Machine Safety Statements	5
Introduction and Machine Specifications	6
Electrical Connection Instructions	7
How to Transport the Machine	8
One Person	8
Two People	9
Machine Set-Up	10
How to Operate the Machine	11
Sanding Cuts and Sandpaper	14
Sander Adjustment Procedures	15
Routine Maintenance	17
Troubleshooting	18

Section II - Parts Manual

Assembly Drawing #1	22
Assembly Parts List #1	23
Assembly Drawing #2	24
Assembly Parts List #2	25
Assembly Drawing #3	26
Assembly Parts List #3	27
Wiring Diagram	28

IVIE Enterprises

www.ivie-ent.com Ph:(918)254-5161 or (888)262-5161 Fax:(918)250-4807

OPERATOR SAFETY INSTRUCTIONS



WARNING



AVERTISSEMENT



ADVERTENCIA

- DANGER** means: Severe bodily injury or death can occur to you or other personnel if the **DANGER** statements found on this machine or in this Owner's Manual are ignored or are not adhered to. Read and observe all **DANGER** statements found in this Owner's Manual and on your machine.
- WARNING** means: Injury can occur to you or to other personnel if the **WARNING** statements found on your machine or in this Owner's Manual are ignored or are not adhered to. Read and observe all **WARNING** statements found in this Owner's Manual and on your machine.
- CAUTION** means: Damage can occur to the machine or to other property if the **CAUTION** statements found on your machine or in this Owner's Manual are ignored or are not adhered to. Read and observe all **CAUTION** statements found in this Owner's Manual and on your machine.



DANGER: Failure to read the Owner's Manual prior to operating or attempting any service or maintenance procedure to your American Sanders Technology machine could result in injury to you or to other personnel; damage to the machine or to other property could occur as well. You must have training in the operation of this machine before using it. **If you cannot read English, have this manual explained fully before attempting to operate this machine.**



DANGER: Sanding/finishing wood floors can create an environment that can be explosive. The following safety procedures must be adhered to:

















- Cigarettes, cigars, pipes, lighters, pilot lights and any other source of ignition can create an explosion when active during a sanding session. All sources of ignition should be extinguished or removed entirely from the work area.
- Work areas that are poorly ventilated can create an explosive environment when certain combustible materials are in the atmosphere, i.e., solvents, thinners, alcohol, fuels, certain finishes, wood dust and other combustible materials. Floor sanding machines can cause flammable material and vapors to burn. Read the manufacturer's label on all chemicals used to determine combustibility. Keep the work area well ventilated.
- Spontaneous combustion or an explosion can occur when working with sanding dust. The sanding dust can ignite and cause injury or damage. Sanding dust should be disposed of properly. Always empty the sanding dust into a metal container that is located outside of any building.
- Remove the contents of the dust bag when the bag is 1/3 full. Remove the contents of the dust bag each time you finish using the machine. Never leave a dust bag unattended with sanding dust in it.
- Do not empty the contents of the dust bag into a fire.
- Hitting a nail while sanding can cause sparks and create an explosion or fire. Always countersink all nails before sanding floors.



DANGER: Operating a machine that is not completely or fully assembled could result in injury or property damage. Do not operate this machine until it is completely assembled. Keep all fasteners tight. Keep adjustments according to machine specifications.



DANGER: Electrocution could occur if the machine is used on a power circuit that repeatedly trips or is undersized. Have a licensed electrician check the fuse, circuit breaker or power supply.

-  **DANGER:** Electrocutation could occur if maintenance and repairs are performed on a unit that is not properly disconnected from the power source. Disconnect the power supply before attempting any maintenance or service.
-  **DANGER:** Electrocutation could occur if machine is used on ungrounded electrical circuit. Never remove or disable the grounding supply conductor on the electrical cord. Consult an electrician if the grounding conductor is missing or if you suspect your circuit is not grounded properly.
-  **DANGER:** Use of this machine with a damaged power cord could result in an electrical shock. Do not use the machine if the power cord is damaged. Do not use the electrical cord to move the machine.
-  **DANGER:** Electrocutation or injury could occur if the power cord is run over or damaged by the sander. Keep the cord free from under the machine to avoid contact with the sandpaper. Always lift the power cord over the machine.
-  **DANGER:** Moving parts of this machine can cause serious injury and/or damage. Keep hands, feet and loose clothing away from all moving parts of the sander.
-  **DANGER:** Operating a sander without all guards, doors or covers in place can cause an injury or damage. Always check to make sure that all of the guards, doors and covers are secure and in place.
-  **DANGER:** Injury to the operator or bystanders could occur if the machine's power is on while performing maintenance, changing or adjusting the belt, or changing the dust bag.
-  **DANGER:** Attempting to adjust the belt tracking while the machine is on can cause injury and/or damage. Do not perform belt tracking adjustments while the machine is running.
-  **WARNING:** Failure to read and observe all safety statements found on your machine or in this Owner's Manual can result in serious injury or damage. Read and observe all safety statements. Make sure that all labels, decals, warnings, cautions, and instructions are fastened to the machine. Get new labels from your authorized American Sanders Technology distributor.
-  **WARNING:** Sanding dust can be airborne and can be breathed in while operating a sander. Always wear a dust mask while operating sanding equipment.
-  **WARNING:** Injury to the eyes and/or body can occur if protective clothing and/or equipment is not worn while sanding. Always wear safety goggles, protective clothing, and a dust mask while performing any sanding operation.
-  **WARNING:** Bodily injury could occur if power is applied to the machine with the power switch already in the "ON" position. Always check to assure that the power switch is in the "OFF" position before applying power to the power cable.
-  **CAUTION:** Maintenance and repairs performed by unauthorized personnel could result in damage or injury. Maintenance and repairs performed by unauthorized personnel will void your warranty. Servicing of this unit must always be referred to an authorized American Sanders Technology distributor.
-  **CAUTION:** Use of this machine to move other objects or to climb on could result in injury or damage. Do not use this machine as a step or furniture. Do not ride on this machine.
-  **CAUTION:** Damage could occur to the machine if not properly kept in a dry building for storage. Store the machine in a dry building.
-  **CAUTION:** The machine is heavy. When transporting the machine, remove the motor. Get help to lift the machine and motor.
-  **CAUTION:** Serious damage to the floor can occur if the machine is left running in one spot while the sanding drum is in contact with the floor. To avoid damage to the floor, feather cut in at a normal sanding rate. Do not dwell while lowering or raising the contact wheel. Always sand at a constant rate.

Machine Safety Statements

The following safety decals are mounted on the machine as shown. If these or any other machine decal, label or plate should become damaged or illegible, install a new decal in its place. Contact your local authorized distributor for new decals.

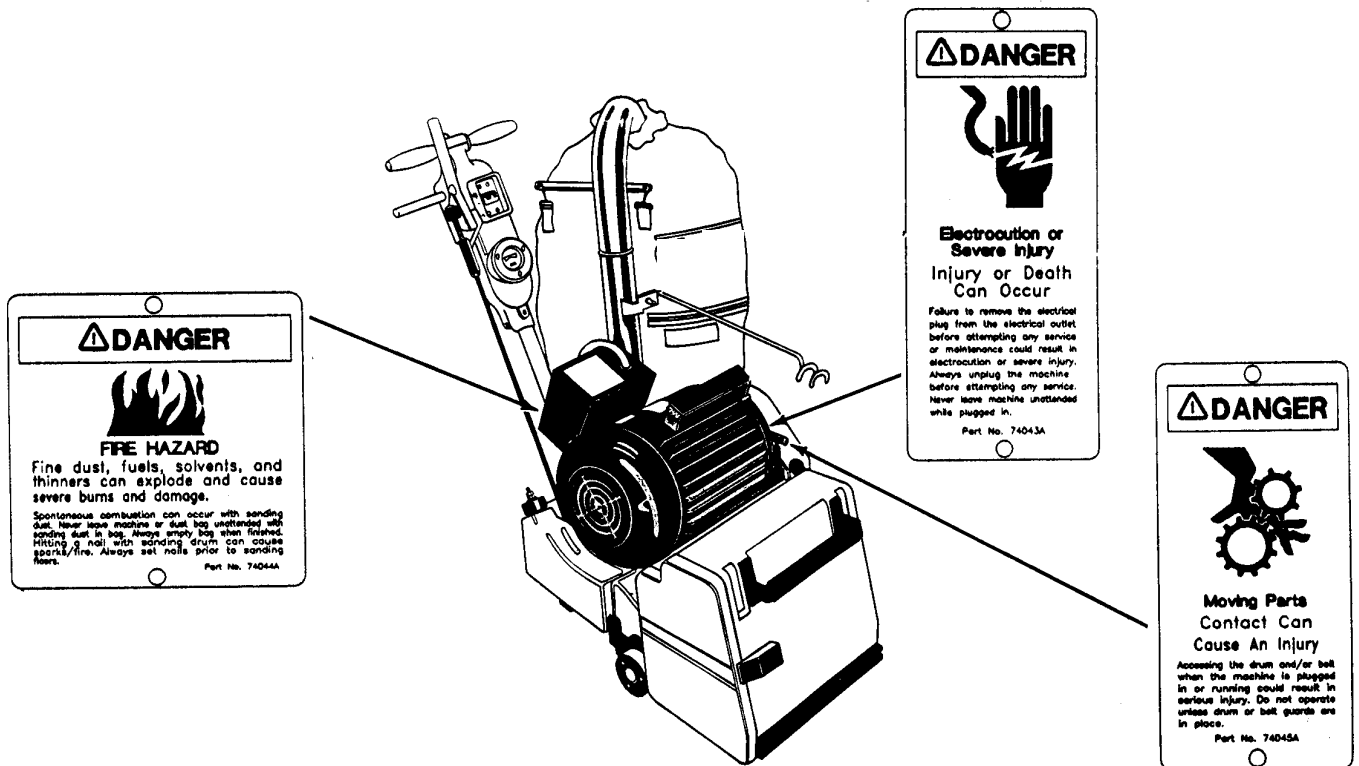

The following information signals potentially dangerous conditions to the operator and/or equipment. Read this manual carefully and familiarize yourself with the machine. Know when these conditions can exist. Locate all safety devices on the machine. Then, take the necessary steps to train the personnel that will be operating the machine. Report machine damage or faulty operation immediately.

1. Keep hands and clothing clear of rotating parts.
2. Keep hands on controls with the motor running.
3. Do not leave the machine with the motor running.
4. Do not operate the machine with the access door or the belt guard open.
5. Always operate the machine with the dust bag in place.
6. Do not remove the dust bag with the motor running.
7. Always disconnect the motor pigtail power cord from the handle before servicing the machine.
8. Use caution when transporting. The motor weighs 120 lbs. The machine weighs 157 lbs.
9. Always operate in a well ventilated area.
10. Always dispose of sanding dust properly.

Introduction and Machine Specifications

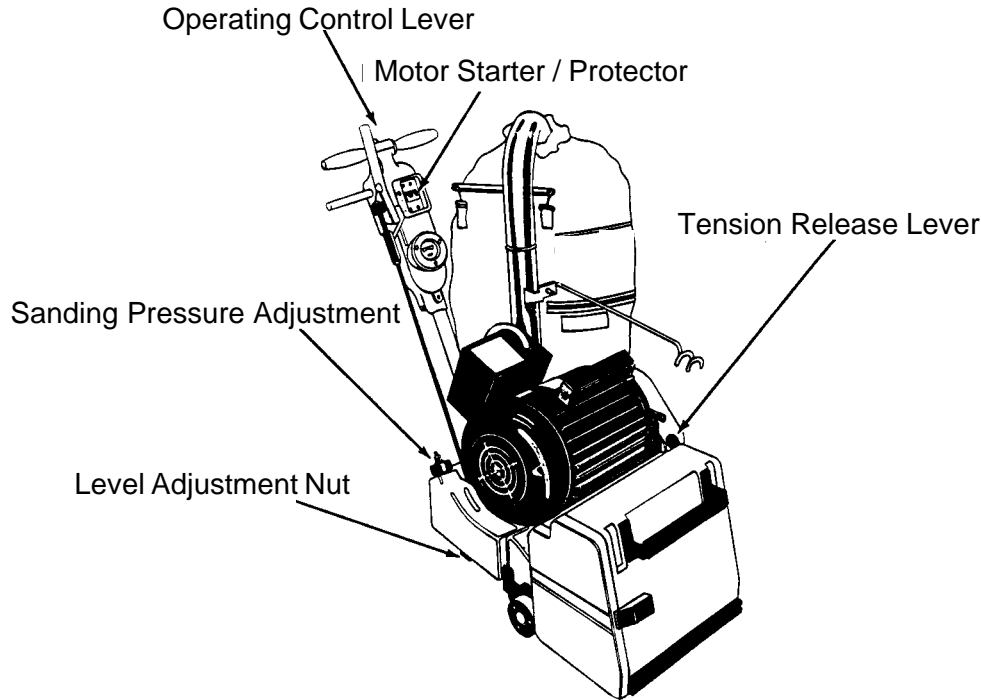

PART NUMBER	07055C	07056C
ABRASIVE BELT SIZE	11-7/8" W x 31-1/2" L	30cm X 80cm
CONTACT WHEEL SPEED (RPM)	2850	2375
ABRASIVE SPEED	5262 sfm (surface feet per minute)	22m/second
DUST FAN SPEED (RPM)	6800	5667
DUST FAN FLOW	234 cfm (cubic feet per minute)	110 liters/second
MOTOR (07055A)	4hp 230V 60Hz	2.2kW 230V 50Hz
LEVELING CONTROL	Externally adjustable	
OPERATING CONTROL	Adjustable lever/grip	
MOTOR STARTER/PROTECTOR	Magnetic circuit breaker	
SANDING PRESSURE ADJUSTMENT	Infinitely adjustable	
WHEELS	Replaceable 3½" O.D.	89mm
BEARINGS	Radial ball, permanently lubricated	
DIMENSIONS	37"H x 18½"W x 35"L	94cm x 47cm x 89cm
WEIGHT	277 lbs. (300 lbs. with cord)	126 kg (136kg with cord)

CAUTION: Your equipment may be inappropriate on some installations. Some softer woods used in flooring cannot support the pressure created by hard wheels. A felt or rubber wheel should be used when these woods are encountered. See parts list for optional wheels.

Always consult with the flooring manufacturer on the proper installation, preparation, and finishing of their product. Determine suitability of your equipment in preparing the product.

IVIE Enterprises

www.ivie-ent.com Ph:(918)254-5161 or (888)262-5161 Fax:(918)250-4807

Electrical Connection Instructions

CAUTION: This machine will operate only on AC frequency and voltage shown on the motor nameplate. Make sure you have the correct frequency and voltage before connecting the power cord to an outlet. The machine has a plug as shown below.

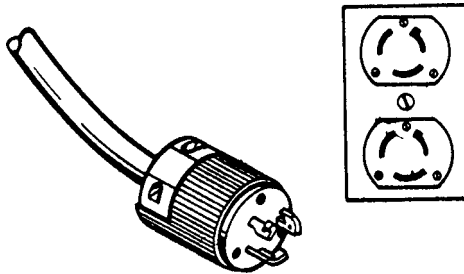

Figure 1

Note: European machines are not equipped with an electrical plug. This machine must be connected to an electrically ground circuit in order to protect the operator from electric shock. This machine has an approved power cord with three conductors as well as a plug with three terminals. Connect the plug into a three holed receptacle. For maximum protection against electric shock, use a circuit that is protected by a ground fault circuit interrupter.

DANGER: Electrocutation could occur if the machine is exposed to water or rain. Keep the machine in a dry building.

DANGER: Electrocutation could occur if machine is improperly connected to the electrical system. To prevent possible electric shock, always use a 3-wire electrical system connected to an electrical ground. For maximum protection against electrical shock, use a circuit that is protected by a ground fault circuit interrupter. Consult your electrical contractor.

DANGER: Electrocutation could occur if the ground pin is tampered with in any way. Do not cut, remove, or break the ground pin. Do not try to fit a three-terminal plug into a receptacle or connector body other than a three holed receptacle or connector body matching the machine plug. If the outlet does not fit the plug, consult your electrical contractor.

DANGER: Electrocutation could occur if the machine is used with a damaged plug or power cord. If the cords or plugs are worn or damaged in any way, have them replaced by an authorized service person or electrician.

Extension Cords

Use only an approved three-pronged extension cord with two main conductors and one earthing conductor. This machine's power cord has a wire size of 10 gauge. This machine is equipped with a 100' power cord. When greater range is needed follow the table below to determine wire gauge of additional footage. Refer to the following chart for extension cord information.

Feet/Wire Gauge (Stranded Copper)		
Source Voltage	0 - 100'	100 - 250'
208	6	Use Voltage Booster
230	10	8

If motor appears to labor or takes a considerably longer time to come up to speed, reduce sanding pressure.

How to Transport the Machine

WARNING: The machine is heavy. Remove the motor from the machine before transporting. Get help loading the machine and motor.

Transporting the Machine - One Person

To transport the machine, follow this procedure:

1. Make sure the power cable is disconnected from the electrical outlet.
2. Disconnect the handle pigtail cord connection. (twist and pull) See figure 2.
3. Loosen the belt tension T-screw completely.
4. Grasp the belt guard immediately above the left hand truck wheel and pull to gain access to the drive belts. Remove the drive belts. See figure 3.
5. Unscrew the motor mounting knob clear of the counterbore on chassis. See figure 4.
6. Straddle the machine. With your legs, lift the motor off of the chassis. Take the motor to worksite.
7. Lift the chassis by grasping the front and rear handle. Bring the belt guard against your chest. Take the chassis to worksite.

To assemble the machine after transporting, follow this procedure:

1. Open the belt guard door.
2. Place the motor assembly on the chassis.
3. Screw in the motor mounting knob completely. See figure 4.
4. Install the drive belts.
5. Tighten the belt tension T-screw only until the contact drive wheel belt does not squeal upon start up. Do not over tighten.

CAUTION: Premature bearing failure can occur if the belt tension is set too tight. The fan drive belt should deflect $\frac{1}{2}$ " at the center of the span with 5 lbs. of pressure.

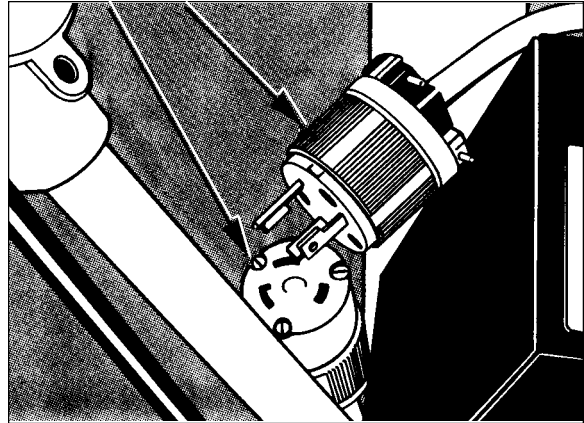

Figure 2

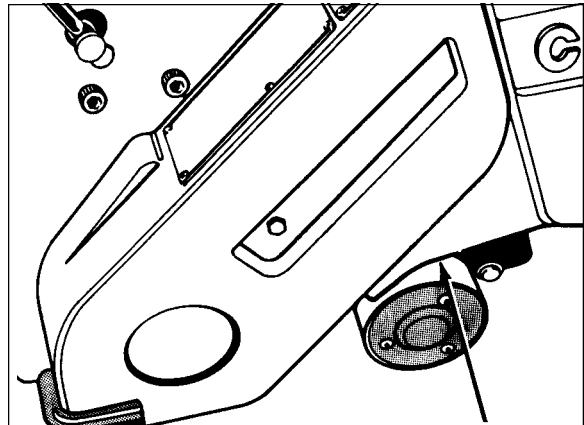

Figure 3

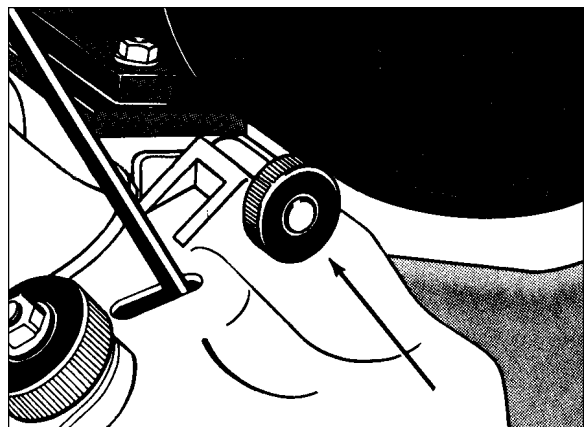

Figure 4

NOTE: It is not always necessary to adjust the fan belt independently during this procedure or during replacement.

NOTE: New drive belts may shed particles of rubber until seated to the pulley grooves. This seating process can take up to 24 hours to accomplish.

6. Close the belt guard door.
7. Plug the motor pigtail in. Twist clockwise to lock.

Transporting the Machine - Two People

When transporting the machine with two people follow this procedure:

1. One operator places hands under the front of the machine main casting.
2. Person #2 lifts the machine by the handle.

Machine Set-Up

To set-up your machine follow this procedure:

1. Familiarize yourself with the machine and read all danger, warning and caution statements. Make sure all operators of this machine have read this Owner's Manual. If they cannot read English, have the manual explained fully before allowing anyone to operate the sander.
2. Locate the power supply. The receptacle should be compatible with the plug. The receptacle must be grounded and must be fused (30 amp) to avoid an electrical hazard.
3. Clip the dust bag to the elbow. See figure 5. Cross the strings on the dust bag and draw tight over the flare on the elbow. Wrap the string around the elbow and secure.
4. Wind the power cord through the cable arm. See figure 6. Keep the power cord out of path of equipment.
5. Pull the draw latch forward to release the access door to gain entry to the sanding chamber.
6. Rotate the release lever forward. See figure 7.
7. Install a new abrasive belt by sliding the abrasive over the tension roller and contact wheel. See figure 8. See table on page 12 for abrasive belt selection.
8. Rotate the release lever clockwise to tighten the abrasive belt.
9. Plug the pig-tailed power cord into the handle. Twist the cord connection clockwise to lock.
10. Turn on the motor circuit breaker (switch) momentarily.
11. Observe the belt tracking. Follow the procedures outlined in the "Sander Adjustment Procedures" on page 14 to correct the belt tracking. There is also a label on the inside of the access door that outlines the belt tracking adjustment.
12. Close the access door. Place the end of the draw latch over the keeper on the access door and push the draw latch flat against the mainframe to secure.

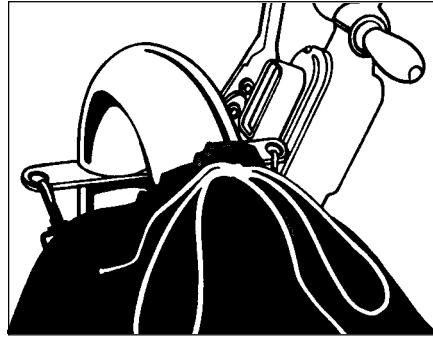

Figure 5

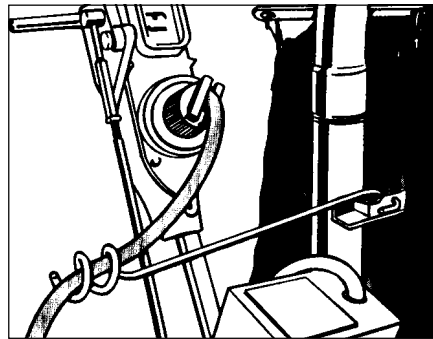

Figure 6

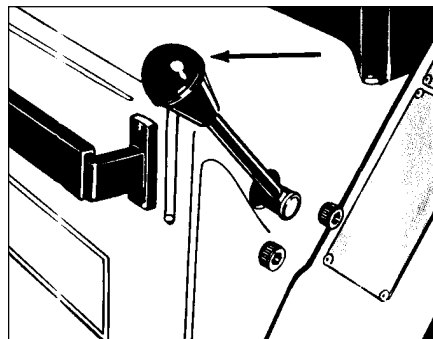

Figure 7

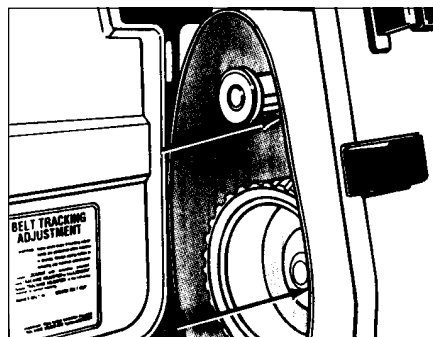



Figure 8

IVIE Enterprises

www.ivie-ent.com

Ph:(918)254-5161 or (888)262-5161 Fax:(918)250-4807

How to Operate the Machine

 **DANGER:** Sanding/finishing wood floors can create an environment that can be explosive. Cigarettes, cigars, pipes, lighters, pilot lights and any other source of ignition can create an explosion when active during a sanding session. All sources of ignition should be extinguished or removed entirely from the work area.

 **DANGER:** Work areas that are poorly ventilated can create an explosive environment when certain combustible materials are in the atmosphere, i.e., solvents, thinners, alcohol, fuels, certain finishes, wood dust and other combustible materials. Floor sanding machines can cause flammable material and vapors to ignite. Read the manufacturer's label on all chemicals used to determine combustibility. Keep the work area well ventilated.

 **DANGER:** Sanding dust can spontaneously ignite and cause an injury or damage. Sanding dust should be disposed of properly. Always empty the sanding dust into a metal container. Remove the contents of the dust bag when the bag is 1/3 full.

 **DANGER:** Sanding dust can spontaneously ignite and cause an injury or damage. Remove the contents of the dust bag each time you finish using the machine. Always dispose of the dust in a metal container located outside of the building. Never leave a dust bag unattended with sanding dust in it. Do not empty the contents of the dust bag into a fire.

 **DANGER:** Hitting a nail while sanding can cause sparks and create an explosion or fire. Always countersink all nails before sanding floors.

IVIE Enterprises

www.ivie-ent.com Ph:(918)254-5161 or (888)262-5161 Fax:(918)250-4807

To operate the machine follow this procedure:

1. Install the operator's belt as follows:
 - a. Position the operator's belt around waist.
 - b. Cross the straps at the waist. See figure 9.
 - c. Slide the belt loop end over the handle on the control lever side. Adjust the length as needed.
 - d. Wrap the remaining strap around the opposite side of the handle and hold it in place with your hand.

⚠ WARNING: **Serious operator injury could occur if the operator has tied the loose end of the operator's belt strap to the machine. Always position the strap so that you can let go and get away quickly in case of bag fire or explosion.**

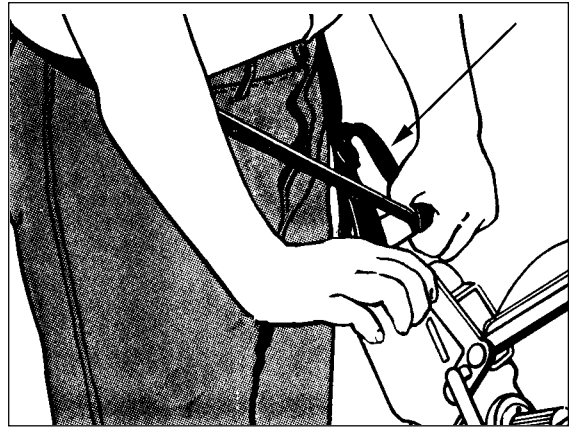

Figure 9

2. Put the On/Off switch into the "ON" position.

⚠ DANGER: **Serious damage can occur to the floor surface if the machine is not in motion while the contact wheel is running on the floor surface. To prevent damage to the surface, make sure the machine is always moving when the contact wheel is in contact with the floor.**

3. Work right to left. For each forward pass, move the machine 6" over the pass you have just finished. Retrace your reverse path without overlapping. See figures 10A through 10E.
4. Feather-cut by easing the contact wheel down onto the surface with the control lever while the sander is in motion.
5. When contact wheel is fully engaged with the surface, gradually adjust your pace for adequate finish removal. Keep sander in motion while the contact wheel is on the floor surface or dwell marks will occur.
6. Move the machine in the direction of the grain in the wood whenever it is possible. Sand the surface at a constant pace.
7. Gradually feather-cut the termination point (the end of your pass) by easing the contact wheel up with the control lever. Stagger the termination points for a better blend when edging.
8. Empty dust bag whenever it is 1/3 full. Never leave a dust bag unattended with sanding dust in it. Sanding dust can spontaneously ignite and cause a fire or explosion. Empty dust into a metal container located **outside of the building**.

IVIE Enterprises

www.ivie-ent.com Ph:(918)254-5161 or (888)262-5161 Fax:(918)250-4807

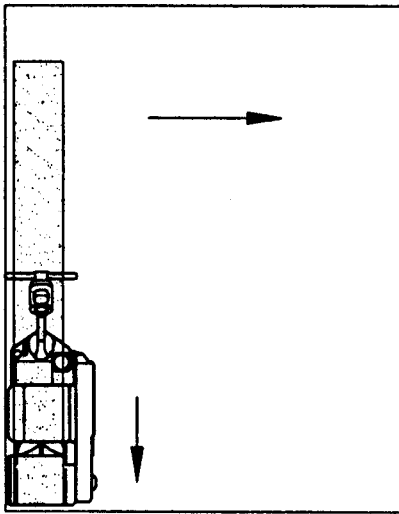

A. First pass forward, right to left.

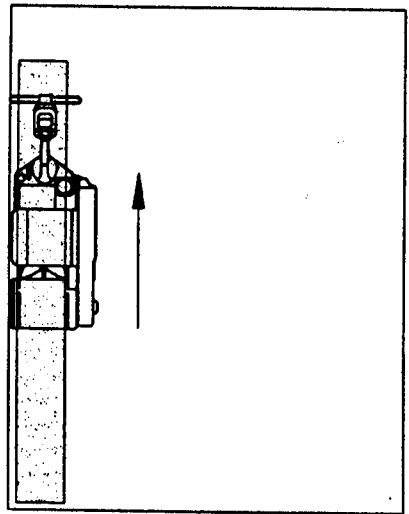

B. First pass reverse, retrace same path.

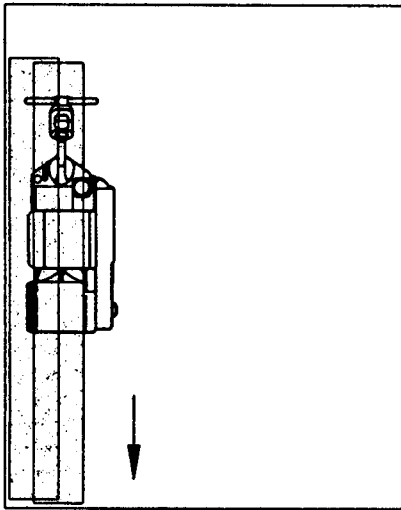

C. Second pass forward, overlap $\frac{1}{2}$ the drum width.

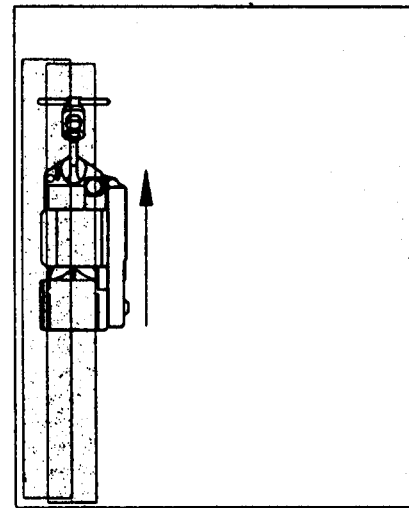

D. Second pass reverse, retrace second path forward, etc.....for the entire room.

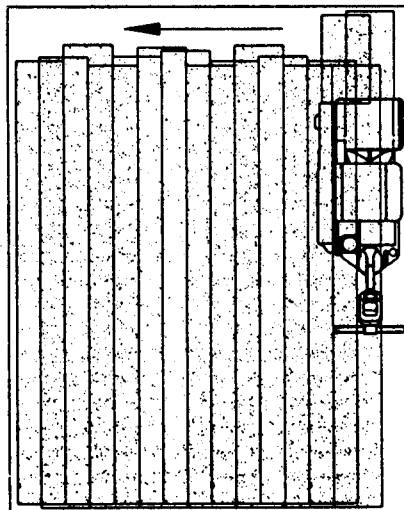

E. Work the remaining unsanded floor in the same fashion, right to left.

Figure 10, A - E

Sanding Cuts and Sandpaper

Initial Cut

The purpose of the initial cut is to remove old finish and gross imperfections on the floor surface. The sanding equipment should be adjusted to heavy sanding pressure setting and a coarse abrasive belt should be used. If the surface is severely damaged by deep scratches, pre-existing dwell marks, uneven planks, etc., it may be necessary to sand across or diagonally to the grain to restore evenness to the surface. If these conditions are not present, the initial cut should be done in the direction of the grain.

If glazing, loading, or burning takes place immediately into an initial cut, select a coarser abrasive. If this should occur during an initial cut, the abrasive has dulled and must be replaced.

Finishing Cuts

The purpose of a finishing cut is to remove the scratches produced during the initial cut. Use a fine (60 - 80 grit) abrasive and a reduced sanding pressure setting.

If the surface remains rough after a finishing cut, it may be necessary to use an even finer grit of abrasive (80 - 100 grit). Care should be taken in selecting the grit size of the abrasive. A very fine grit will close the pores of the wood. If the pores of the wood are closed it will not accept stain.

If glazing or burning should occur immediately into a finishing cut, reduce the sanding pressure and/or select a coarser abrasive. If it should occur during a finishing cut, the abrasive has dulled and must be replaced.

Abrasive Belts

Note: All part numbers listed are for a carton of 10 belts

Grit	Use	Aluminum Oxide	Silicon Carbide	Ceramic Alum. Oxide
16	For removing gross imperfections and restore evenness to old flooring. To remove build-up of paints and varnishes.	-	945856	-
36	For initial cut on new flooring (maple, oak). For removing minor imperfections and finishes from old flooring.	-	945854	945916
40	For initial cut on new flooring (oak, walnut). For removing minor imperfections and finishes from old flooring.	-	945853	945917
50	For initial cut on new flooring (cedar, pine, fir) For clean-up from initial cut of 16 grit.	-	945852	945918
60	For clean-up from initial cut of 36 - 40 grit.	945851	-	945919
80	For finishing cut on certain hardwoods. For clean-up of initial cuts of 50 grit.	945850	-	945920
100	For finishing cut on certain hardwoods where a smooth surface is desired.	945849	-	945921
120	For finishing cut on certain conifers.	945848	-	945922
150	For finishing cut on certain conifers where a smooth surface is desired.	945847	-	945923
180	For surface roughing between coats of finish.	945846	-	-

Sander Adjustment Procedures

⚠ DANGER: Electrocution could occur if maintenance and repairs are performed on a unit that is not disconnected from the power source. Disconnect the power supply before attempting any maintenance or service.

⚠ DANGER: Moving parts of this machine can cause serious injury and/or damage. Keep hands, feet and loose clothing away from all moving parts of the sander.

The following information provides details on how to adjust different features/controls of the sander.

Dust Shoe

To adjust the dust shoe follow this procedure:

1. Disconnect machine from power supply.
2. Loosen the three screws fastening the dust shoe to the chassis.
3. Adjust the dust shoe forward to reduce clearance.
4. Adjust the dust shoe rearward to increase clearance.
5. Align the dust shoe to the chassis and tighten all three screws. See figure 11.

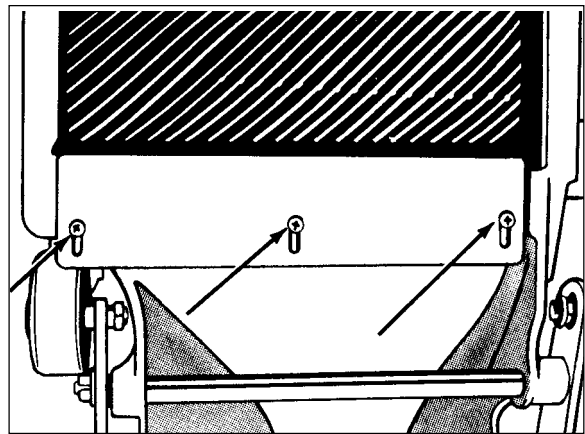

Figure 11

Sanding Pressure

To adjust the sanding pressure follow this procedure:

1. Screw the sanding pressure knob clockwise to increase the sanding pressure when making the initial cut.
2. Screw the sanding pressure knob counter-clockwise to decrease the sanding pressure when making finishing cuts.

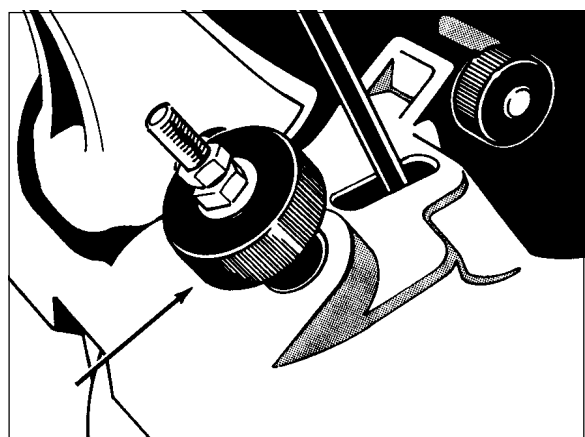

Figure 12

Minimum pressure is reached when the sanding pressure knob extends 7/8" off of the casting. See figure 12.

Leveling

To adjust the machine leveling follow this procedure:

1. Locate the leveling screw. See figure 13. The leveling screw is located towards the rear of the chassis beneath the sanding pressure knob.
2. Tighten the leveling screw (compress the leveling spring) to sand heavier on the left (drive belt side).
3. Loosen the leveling screw (relax the leveling spring) to sand heavier on the right (side opposite the drive belts).

Belt Tracking

⚠ WARNING: Injury to the operator could occur if any machine adjustments are made while the motor is running. Do not attempt to make any adjustments while the machine is plugged in or running.

To adjust the belt tracking follow this procedure:

1. Locate the belt tracking adjuster screw. See figure 14a.
2. Hold the belt tracking adjuster screw and loosen the locknut. See figure 14b.
3. Rotate the tracking adjuster screw counterclockwise to move the belt in.
4. Rotate the tracking adjuster screw clockwise to move the belt out.
5. Tighten the locknut and test the adjustment. Repeat steps 2 through 5 until belt tracks properly.

Operating Control

To **increase** the travel or extend the reach on the grip control follow this procedure:

1. Loosen the locknut on the control rod. See figure 15a.
2. Screw the control rod adjuster (fig. 15b) onto the control rod until the desired reach is found.
3. Hold the control rod adjuster and tighten the locknut. See figure 15a.

To **decrease** the travel or reduce the reach on the grip control follow this procedure:

1. Loosen the locknut on the control rod. See figure 15a.
2. Screw the control rod adjuster (fig. 15b) off the control rod until desired reach is found.
3. Hold the control rod adjuster and tighten the locknut. See figure 15a.

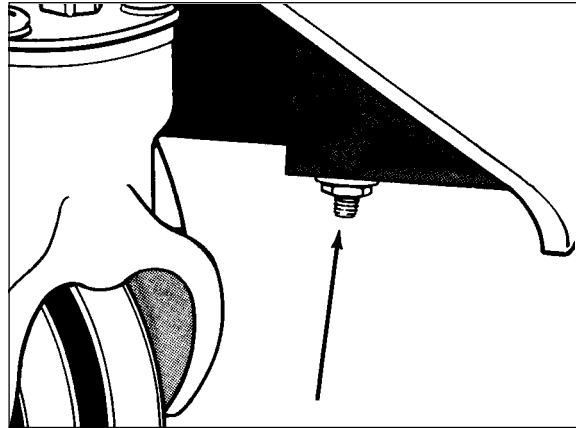

Figure 13

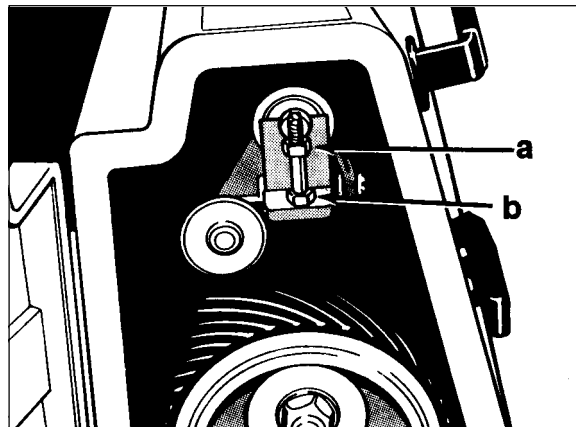

Figure 14

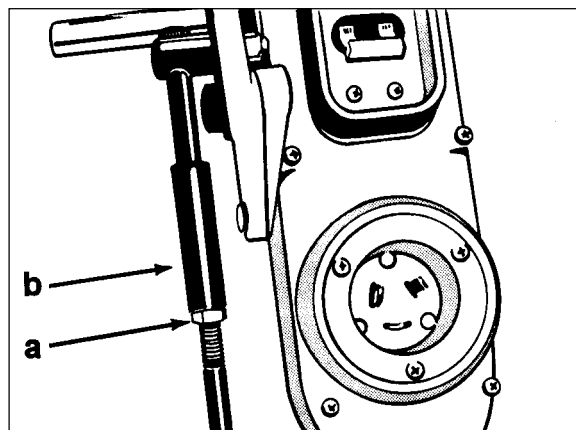

Figure 15

Routine Maintenance

The following items need to be periodically inspected and maintained to keep your sander in good working condition.

Sanding Chamber

Periodically blow out the sanding chamber to prevent accumulations of debris which could interfere with the performance of the tension roller.

Wheels

Periodically remove the debris from the truck and caster wheels. Debris can cause waves on a sanded surface.

Dust Bag

Remove the dust bag from the machine and shake it thoroughly to remove the sanding dust. Turn the dust bag inside out and machine wash in cold water to prevent pore blockage and loss of dust recovery.

Drive Belt

Periodically check the drive belt tension. See the adjustment procedure on page 6.

Bearings

Periodically check the bearings for wear or damage according to the following schedule:

<i>Guide rollers</i>	after 1 st 650 hrs.
<i>Idler pulley</i>	after 1 st 1500 hrs.
<i>Fan shaft</i>	after 1 st 2500 hrs.
<i>Tension roller</i>	after 1 st 2500 hrs.
<i>Arbor shaft</i>	after 1 st 5000 hrs.
<i>Motor shaft</i>	after 1 st 5000 hrs.

Rollers

Periodically check the guide rollers and the tension roller for wear. Also check for build-up of debris on tension roller.

Problem	Cause	Action
Drive belts slip. (Squeaking or squealing sound)	Insufficient tension. Worn Belts.	Tension drive belt as described in adjustment procedures. (Page 6) Replace belts.
Squealing, growling or grinding noise coming from machine.	Damaged and/or worn bearing.	Remove drive belts, rotate arbor motor, fan, shafts and idler pulley to locate dragging or rough bearing. Contact an authorized dealer.
Dust pick-up is poor.	Dust bag is over 1/3 full. Dust bag is dirty. Dust shoe is improperly adjusted. Dust chute is obstructed. Extremely fine dust and clogged pores.	Empty contents of bag. Shake debris from bag and wash. Readjust dust shoe. Remove fan cover and clear throat. Shake debris from bag and wash.
Motor will not start.	Defective circuit breaker. Defective start capacitor. Defective electronic start switch. Low voltage from poor connection. Defective motor. No power at outlet.	Contact an authorized dealer. Contact an authorized dealer. Contact an authorized dealer. Contact an authorized dealer. Contact an authorized dealer. Check power supply and connections.
Motor runs sluggishly.	Low voltage from excessive footage, undersized extension cord, or poor connection. Defective bearing. Defective run capacitor. Defective Motor.	Locate power source nearer to work site. Decrease sanding pressure. See squealing , etc. above to locate defective bearing. Contact an authorized dealer. Contact an authorized dealer.
Motor circuit breaker trips/repeatedly trips.	Excessive load. Defective electronic start switch. Defective motor circuit breaker. Low voltage from poor connection. Defective motor. Defective capacitor. Operating on wrong voltage or frequency.	Contact an authorized dealer. Contact an authorized dealer. Contact an authorized dealer. Contact an authorized dealer. Contact an authorized dealer. Contact an authorized dealer. Verify power supply is as marked on motor nameplate. Readjust leveling. (Fig. 13, Page 14)
Uneven cut.	Leveling out of adjustment. Abrasive belt tracking.	Adjust belt to track towards the edge of drum with deepest cut. (Fig 14, Page 14)

IVIE Enterprises

www.ivie-ent.com Ph:(918)254-5161 or (888)262-5161 Fax:(918)250-4807

Download from Www.Somanuals.com. All Manuals Search And Download.

Problem	Cause	Action
Burning or glazing.	Dull abrasive. Excessive sanding pressure. Too fine of an abrasive belt.	Replace abrasive. Decrease sanding pressure setting. Fig12. Page 13. Use coarser abrasive.
Slow cutting.	Dull abrasive. Too fine of an abrasive belt. Insufficient sanding pressure.	Replace abrasive. Use a coarser abrasive belt. Increase sanding pressure setting. Fig. 12, Page 13.
Waves on sanded surface.	Debris on wheels. Flat spot on tire(s).	Remove and clean wheels. Replace tires.
Chatter marks on sanded surface. (close evenly spaced ripples)	Flat spot on contact wheel. Contact wheel out of round.	Contact an authorized dealer or replace the contact wheel.
Difficult to actuate tension release lever.	Debris interferes with mechanism. Worn sleeve bearing. Galled linkages.	Blow out sanding chamber. Remove & disassemble mechanism. Clean out. Replace. Lubricate with WD-40.
Abrasive belt hunts. (seeks)	Worn neoprene washers. Worn sleeve bearing. High edges on contact wheel.	Replace (Item 70, page 21.) Check for excessive play, replace. Contact an authorized dealer or replace the contact wheel.
Abrasive belt will not track.	Extreme difference in side-to side length of belt. High edge on contact wheel.	Replace abrasive belt. Check several different abrasive belts. Contact an authorized dealer or replace the contact wheel.
Abrasive belt tears along its length.	Debris built-up on (top) tension roller.	Clean tension roller.

IVIE Enterprises

www.ivie-ent.com Ph:(918)254-5161 or (888)262-5161 Fax:(918)250-4807

Download from www.Somanuals.com. All Manuals Search And Download.

Free Manuals Download Website

<http://myh66.com>

<http://usermanuals.us>

<http://www.somanuals.com>

<http://www.4manuals.cc>

<http://www.manual-lib.com>

<http://www.404manual.com>

<http://www.luxmanual.com>

<http://aubethermostatmanual.com>

Golf course search by state

<http://golfingnear.com>

Email search by domain

<http://emailbydomain.com>

Auto manuals search

<http://auto.somanuals.com>

TV manuals search

<http://tv.somanuals.com>