

# ***Nikon***

35mm Film Scanner

## **COOLSCAN II**

Standard Model and Internal-Mount Model

### **User's Manual**

## **Contents**

1. Overview
  - 1.1 Features
  - 1.2 Operating Environment for Standard Model
2. Before Operation
  - 2.1 Inspection
  - 2.2 Components
  - 2.3 Notes on Use
  - 2.4  Cleaning the Unit
3. Parts Identification
  - 3.1 Main Unit
  - 3.2 Status Display LED
  - 3.3 Strip Film Holder FH-2
4. Setting Up the Standard Model
  - 4.1 Before Connection
  - 4.2 Connecting the Power Cord
  - 4.3 Connecting the SCSI Cable
  - 4.4 Setting the SCSI ID

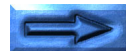

- 5. Setting Up the Internal-mount Model
    - 5.1 Before Installing
    - 5.2 Installing the Internal-mount Model
    - 5.3 Setting the SCSI ID
    - 5.4 Terminating the SCSI Chain
    - 5.5 SCSI Cables Used with Internal Scanners
    - 5.6 Connecting to the Computer SCSI
    - 5.7 Setting Up a SCSI Chain with the Scanner
  - 6. Operation
    - 6.1 Turning on the Power
    - 6.2 Film Insertion
  - 7. Troubleshooting
- Appendix: Specifications
- Index



## Cautions

- The reproduction of all or part of this manual without our permission is prohibited.
- The information contained in this manual is subject to change without notice.
- We have made every effort to produce a perfect manual, but should you find any mistakes, we would be grateful if you would kindly let us know.
- We shall take no responsibility for consequences resulting from the operation of this product, despite the terms mentioned above.

## Trademark Information

Macintosh is a registered trademark of Apple Computer, Inc.

Microsoft is a registered trademark and Windows is a trademark of Microsoft Corporation.

IBM PC/AT is a trademark of International Business Machines Corporation.

Other brand or product names are the trademarks or registered trademarks of their respective holders.



## Indication

The  indications in this manual signify important safety precautions. In order to use this product safely, please read every section where these indications are placed before beginning operation, this product. These indications are also placed in the table of contents so users can find them easily.



## Indication

The  indications in this manual signify the need for caution when using the products. These indications are placed in sections that should be read by users before beginning operation, in order to avoid damage to the product.

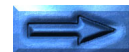

## **Federal Communications Commission (FCC) Radio Frequency Interference Statement**

This equipment has been tested and found to comply with the limits for a Class B digital device, pursuant to Part 15 of the FCC Rules. These limits are designed to provide reasonable protection against harmful interference in a residential installation. This equipment generates, uses, and can radiate radio frequency energy and, if not installed and used in accordance with the instructions, may cause harmful interference to radio communications. However, there is no guarantee that interference will not occur in a particular installation. If this equipment does cause harmful interference to radio or television reception, which can be determined by turning the equipment off and on, the user is encouraged to try to correct the interference by one or more of the following measures:

- Reorient or relocate the receiving antenna.
- Increase the separation between the equipment and receiver.
- Connect the equipment into an outlet on a circuit different from that to which the receiver is connected.
- Consult the dealer or an experienced radio/TV technician for help.

## **CAUTIONS**

### **Modifications**

The FCC requires the user to be notified that any changes or modifications made to this device that are not expressly approved by Nikon Corporation may void the user's authority to operate the equipment.

### **SCSI Cable**

Please use the SCSI cable listed on page 5 in the user's Manual supplied with the scanner. Using other interface cables may exceed the limits of the class B Part 15 of FCC rules.

## **Notice for customers in Canada**

### **CAUTION**

This class B digital apparatus meets all requirements of the Canadian interference Causing Equipment Regulations.

### **ATTENTION**

Cet appareil numérique de la classe B respecte toutes les exigences du Règlement sur le matériel brouilleur du Canada.

## **Notice for customers in European countries**

### **ACHTUNG**

Dieses Gerät entspricht den Bestimmungen der EG-Direktive 87/308/EEC zur Störungsunterdrückung. Lärmemission kleiner 70 dBA



## Cautions for Safety

In order to use the COOLSCAN II safely and correctly, and to prevent problems, pay careful attention to the following points:

- Use an AC power supply of 50/60Hz and a voltage of from 100V–240V. Be sure to use a power cord rated for the appropriate voltage.

### At voltages of more than AC 125V:

use a power cord that complies with the safety standards of the country in which it is used, which has a plug rated for AC 250V, 15A (NEMA 6P-15) and insulation of SVT type or better, and which is more than AWG18 in thickness.

### At voltages of AC 125V or less:

use a power cord that complies with the safety standards of the country in which it is used, which has a plug rated for AC 125V, 10A and insulation of SVT type or better, and which is more than AWG18 in thickness.

- Be sure that the electrical outlet of the power supply is grounded. Conduct the grounding in common to the other machines it is being connected with. Unless common grounding is conducted, ground loop will occur, which will cause electric shock and noise static.

\* The shape of the plug depends on the country of use.

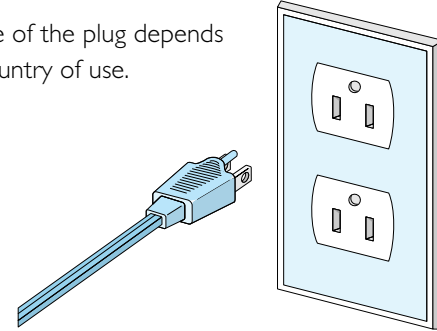

- Do not conduct the grounding to a gas pipe or a water pipe.



- When plugging in or unplugging the power cord, be sure to touch only the plug.

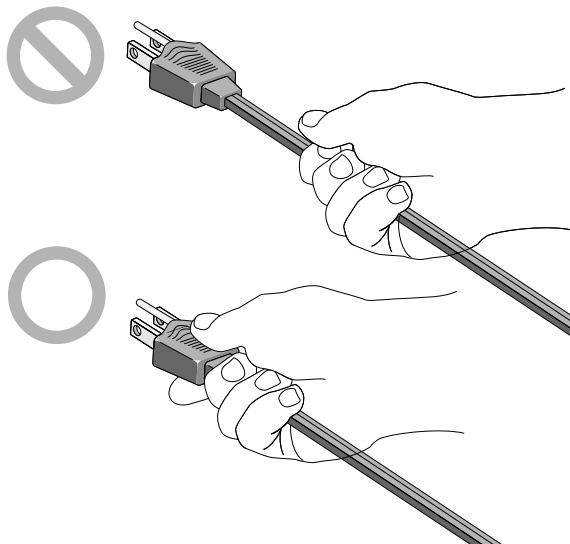

- Do not extend the power cord of the product, as this may cause malfunction. This can cause breakage and failure.

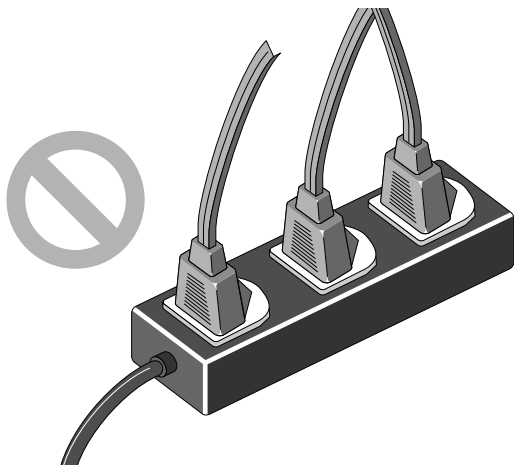

- Do not connect or remove peripheral equipment while the power switch is on. This can cause breakage and failure.
- Do not unplug the power cord while the power switch is on. This can cause breakage and failure.
- Do not move the Unit while the power switch is on. This can cause breakage and failure.
- Once the power switch has been turned off, wait at least five seconds before turning the power switch on.
- On no account disassemble the Unit. The high voltage parts inside the unit can cause electric shock.

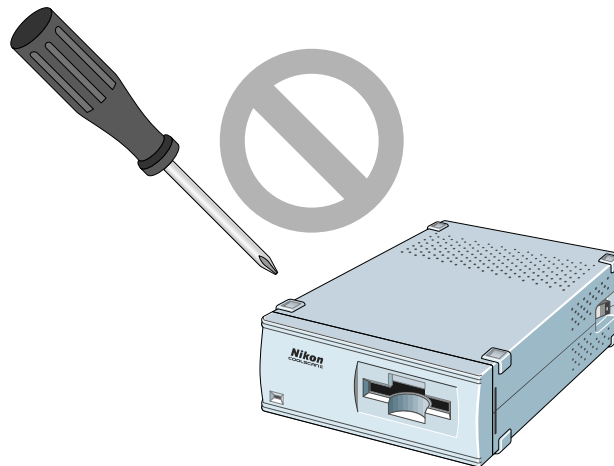

- Do not insert any foreign objects inside the unit. If flammable objects, metal, or water come in contact with the interior of the unit, failure, fire, and/or an electrical shock may result.

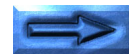

- Avoid harsh substances such as alcohol, benzine, thinner, or pesticides, as failure, fire, and/or an electrical shock may result.
- Do not subject the unit to any strong shocks. This can cause breakage and failure.

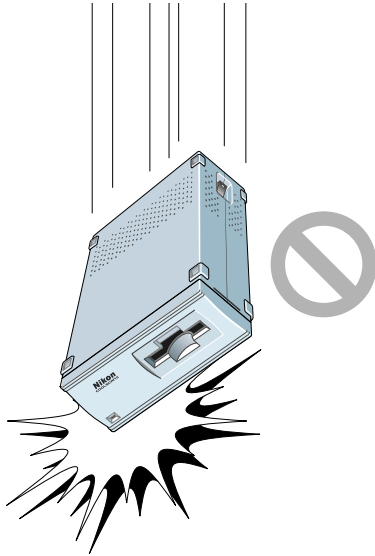

- Do not place heavy objects on the unit.

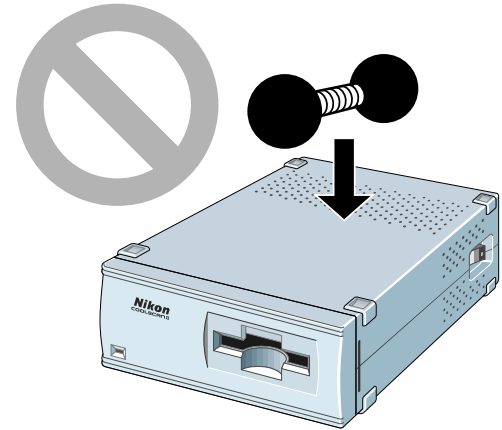

- Do not pull or bend the SCSI cable. This can cause the cable to malfunction.

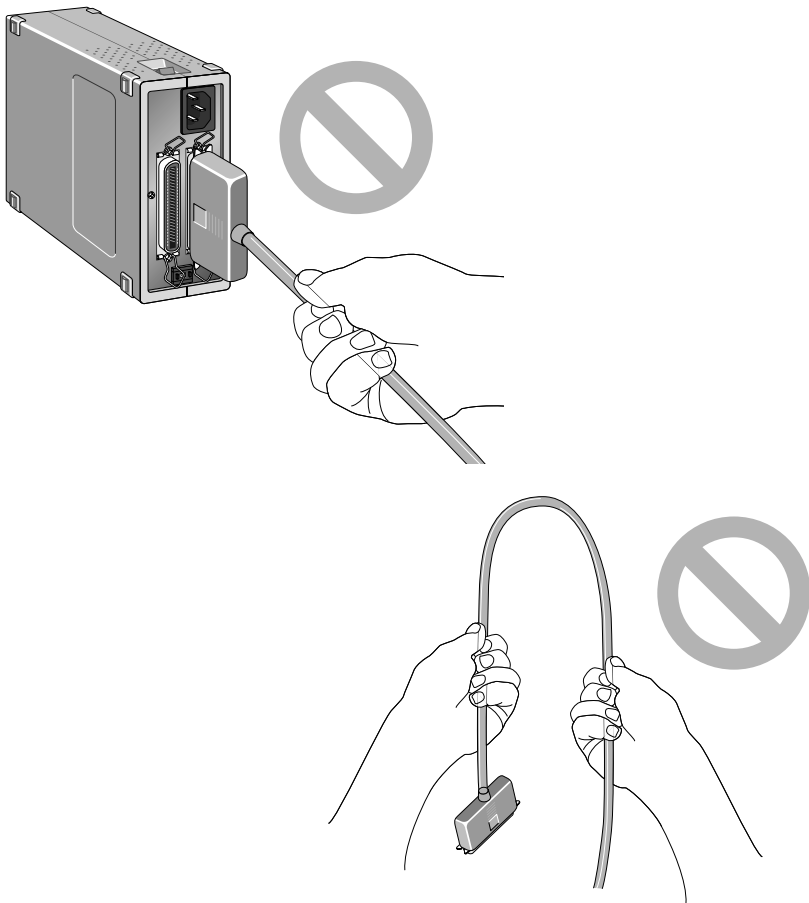

## **If You Notice Anything Abnormal**

If unusual noise, odor or smoke occurs, switch the Unit off immediately and disconnect the power cord and the SCSI cable. Contact your retailer or Nikon sales representative in your country.





## Storage and Operating Locations

Proper storage will ensure the long life of the Unit. In order to avoid internal dust while being stored, it is recommended that an appropriate cover be used on the Unit.

### Do not store or use where:

- The temperature is above 95°F (35°C) or below 50°F (10°C), the temperature changes drastically, or condensation occurs.

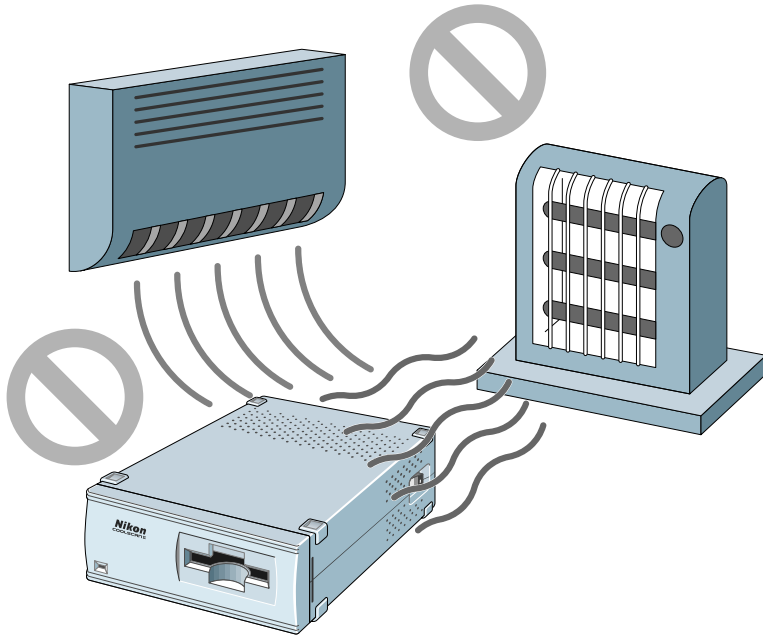

- The humidity exceeds 80%.
- The Unit is exposed to direct sunlight.

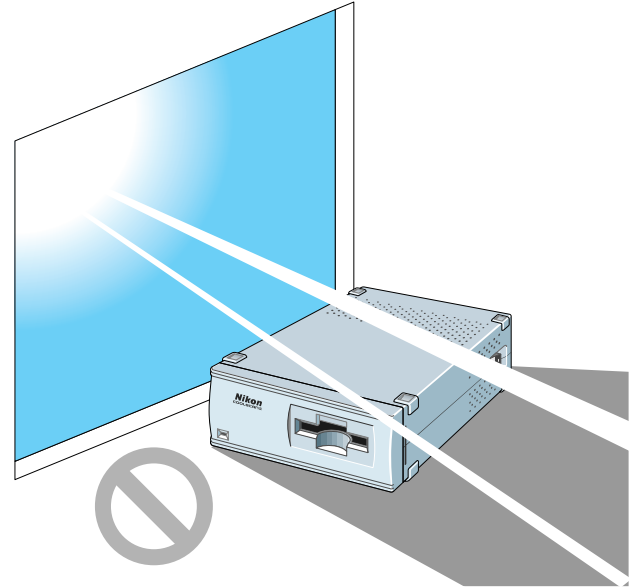

- The atmosphere is excessively dusty.

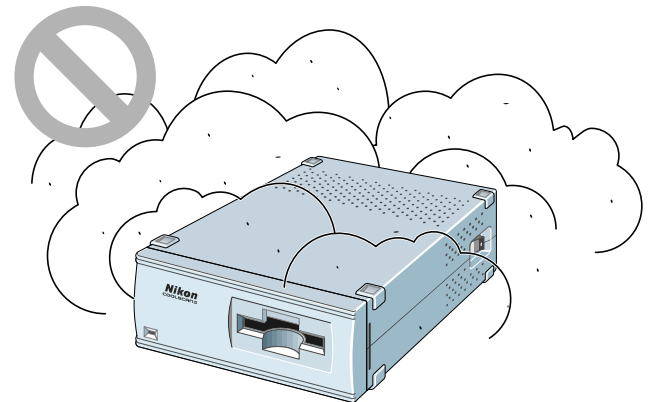

- The Unit may be subjected to excessive vibration.
- The Unit is placed on tilted surface.

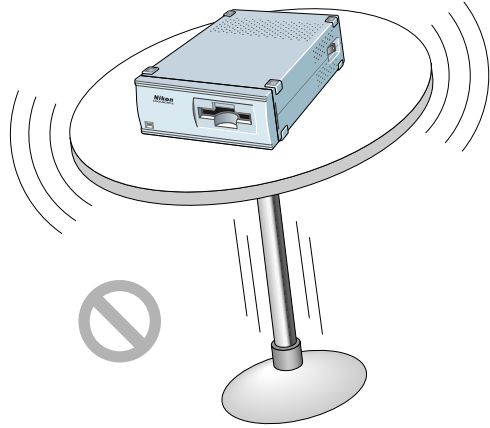

- The Unit is exposed to electrical noise and interference from other equipment nearby.

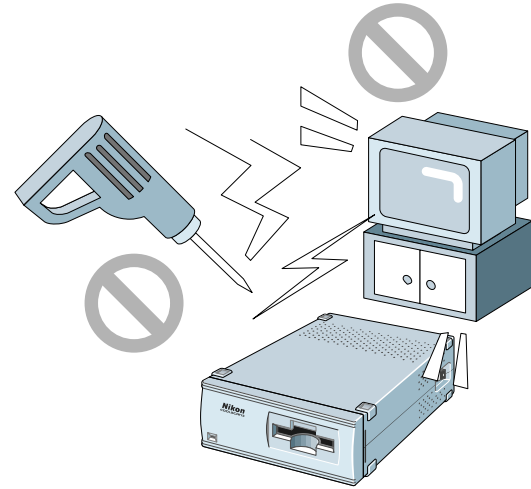

Leave sufficient space around the unit to ensure that the ventilation slots are not blocked. Blocking these slots may cause an internal heat build-up.

Place the unit on a level and stable surface for operation. If operated in any other way, problems will occur.

## Cautions for Operation

- Don't carry the Unit or film while scanning. This can cause breakage and failure.
- When moving the scanning stage, don't touch or unmount the film holder. This can cause breakage and failure.
- Don't use a slide mount more than 3mm thick. If the slide mount surface is not smooth, you may feel some resistance when mounting or unmounting the slide.
- Don't force the slide mount or strip film holder into or out of the scanner if it does not move smoothly. This can cause breakage and failure.

## Transportation Precautions

When transporting the Unit, pack the unit with the original package box and packing material provided by Nikon.

## When Taking the Unit Out of The Country

The use of this product may violate local laws and restrictions in some countries. If this is the case, we cannot bear any responsibility for any violations resulting from the use of this product.

## Notice concerning prohibition of copying or reproduction

Note that simply being in possession of material which has been copied or reproduced by means of a scanner may be punishable by law.

- **Items prohibited by law from being copied or reproduced**

Do not copy or reproduce paper money, coins, securities, government bonds, or local government bonds, even if such copies or reproductions are stamped "Sample".

The copying or reproduction of paper money, coins, or securities which are circulated in a foreign country is prohibited.

The copying or reproduction of unused postage stamps or post cards issued by the government without obtaining approval from the government is prohibited.

The copying or reproduction of stamps issued by the government and certified documents stipulated by law is prohibited.

- **Cautions on certain copies and reproductions**

The government has issued cautions on copies or reproductions of securities issued by private companies (shares, bills, checks, gift certificates, etc.), commuter passes, or coupon tickets, except when a minimum of necessary copies are to be provided for business use by a company. Also, do not copy or reproduce passports issued by the government, licenses issued by public agencies and private groups, ID cards, and tickets, such as passes and meal coupons.

- **Comply with copyright notices**

The copying or reproduction of works such as books, music, paintings, woodcut prints, maps, drawings, movies, and photographs which are copyrighted creative works is prohibited except when it is done for personal use at home or for similar restricted and non-commercial use.



# I. Overview

Thank you for purchasing the Nikon 35mm Film Scanner COOLSCAN II. This manual describes the procedures for unpacking, setting up, and connecting the scanner, with emphasis on hardware use and precautions.

Please read the sections appropriate for the scanner you are using, to ensure proper operation.

For an explanation of how to scan and reproduce images with COOLSCAN II, please refer to the [software manual](#).

We hope that you will find this manual helpful.

## I.1 Features

The COOLSCAN II is capable of scanning 35mm film (color/monochrome, negative/positive) at high speed and high resolution.

- 3-color, high-brightness LED illuminant, eliminates the need for illuminant maintenance
- High-speed single-pass scanning capability
- High quality images produced using an 8-bit A/D converter
- Maximum pixel count of  $2,592 \times 3,888$  and high resolution of 2,700dpi (on film surface)
- Auto-focus function, eliminating the need for manual focusing
- Compact, lightweight design, with low power consumption

## I.2 Operating Environment for Standard Model

Leave extra space around and above the unit to ensure smooth operation. Please refer to the drawings below for the amount of space to be provided.

If possible, place a suitable cover over the unit to avoid dust accumulating when it is not being used.

### For vertical installation

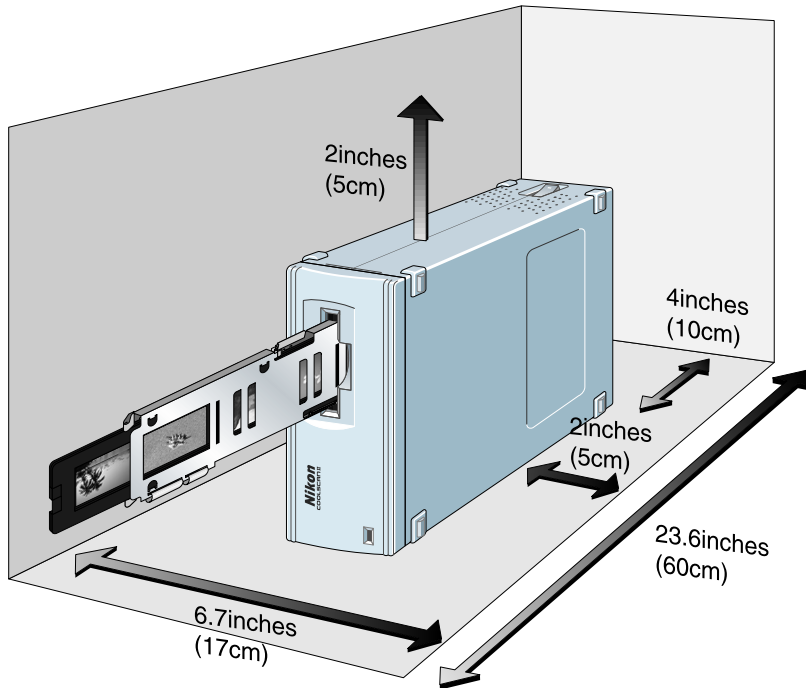

### For horizontal installation

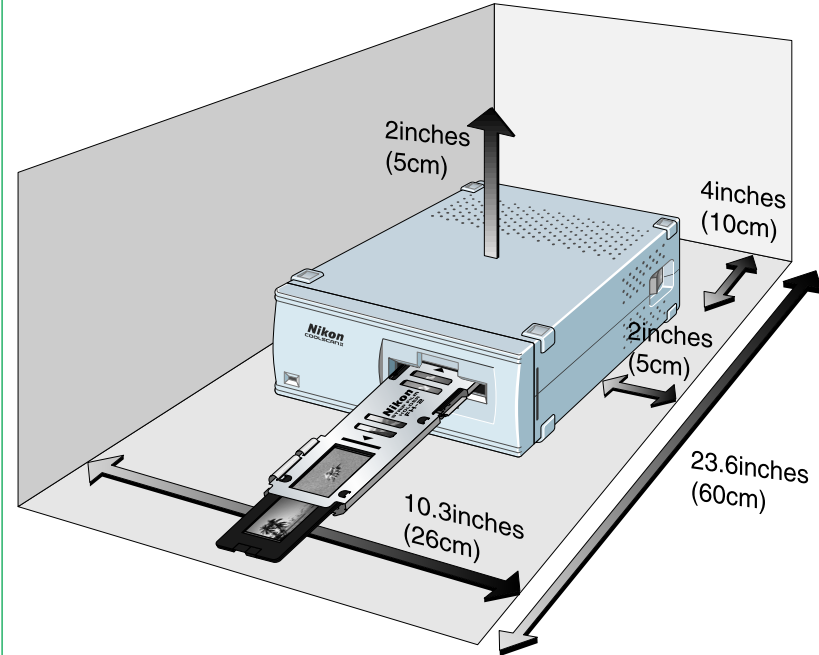

## 2. Before Operation

### 2.1 Inspection

Inspect the package to see whether any damage has occurred during shipment. If there is any damage to the package, please contact your retailer directly and do not unpack the unit.

### 2.2 Components

When you open the package, check whether all the items are present. If there are any missing items, please contact your retailer immediately.

#### Standard Model

The following items are included with your COOLSCAN II standard model package.

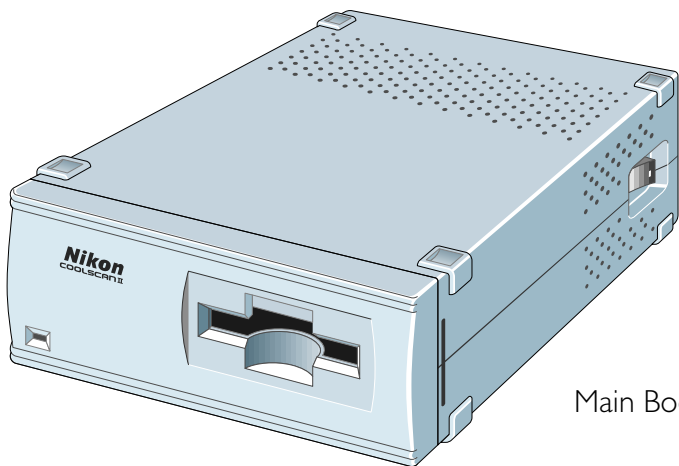

Main Body (1)



Power cord (1)

\* The shape of the plug depends on the country of use.

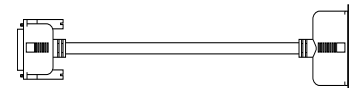

SCSI cable (1)  
(50pin full pitch Dsub 25pin)



FH-2 Strip Film Holder (1)

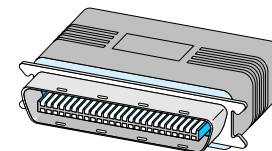

Terminator (1)



User's manual(s)  
Software disk(s)



## Internal-mount Model

The following items are included with your COOLSCAN II Internal-mount model package.

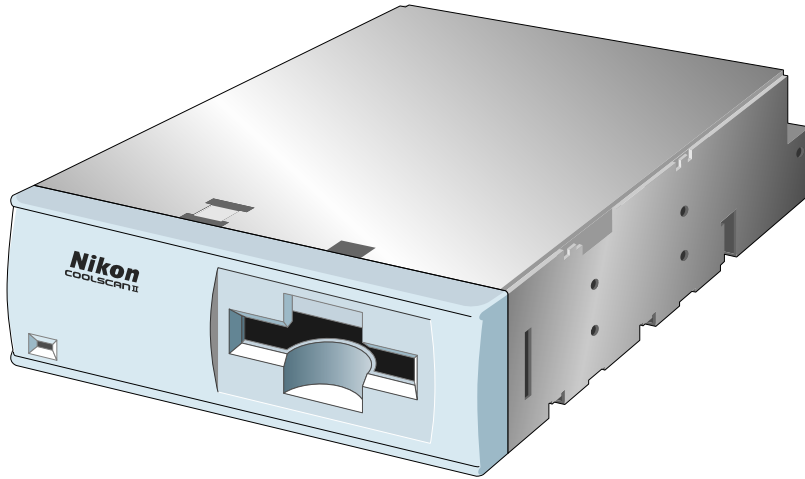

Main Body (1)

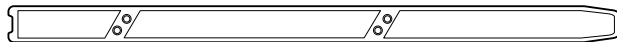

Guide rail (1)

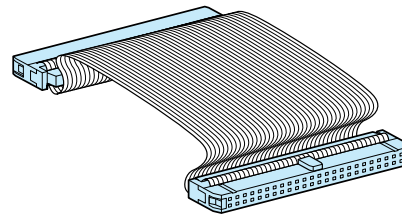

SCSI 50-pin flat cable (1)

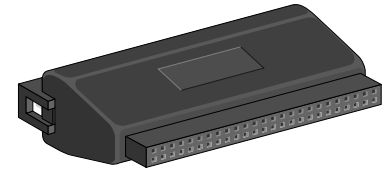

Terminator (1)

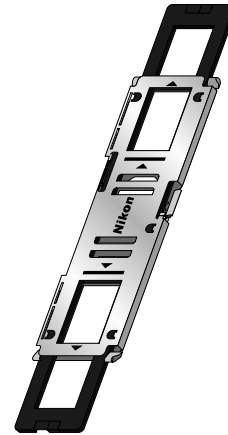

FH-2 Strip Film Holder (1)



User's manual(s)  
Software disk(s)

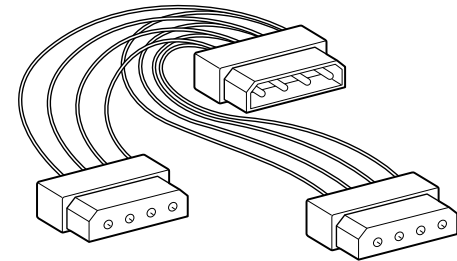

Internal Power Cable (1)



## 2.3 ✓ Notes on Use

- Don't use a slide mount neither less than 1.1mm nor more than 3.0mm thick. If the slide mount is not flat on its surface, you may feel some roughness when mounting or unmounting the slide.
- Don't force the slide-mount or strip film holder into or out of the unit if it does not move smoothly.
- When scanning film, don't touch or unmount the slide-mount or film strip holder.

## 2.4 ⚠ Cleaning the Unit

When carrying out routine maintenance and cleaning, ensure that no volatile liquids such as alcohol, benzene, or thinner come into contact with the COOLSCAN II as this may cause a failure, fire, or electric shock.

Please observe the following points:

- Before cleaning, always turn the power off, and pull out the power plug.
- Since the front cover is made from plastic material, remove dust with a blower or a dry cloth.

Use a soft, dry cloth to remove dust from the metal panel at the rear.

- If the unit has become badly soiled, clean with a cloth moistened with a mild liquid detergent, then dry with a soft cloth.

Avoid harsh substances such as alcohol, benzene, thinner, or pesticides, as they may damage the surface, or remove the exterior finish.

# 3. Parts Identification

## 3.1 Main Unit

### Standard Model

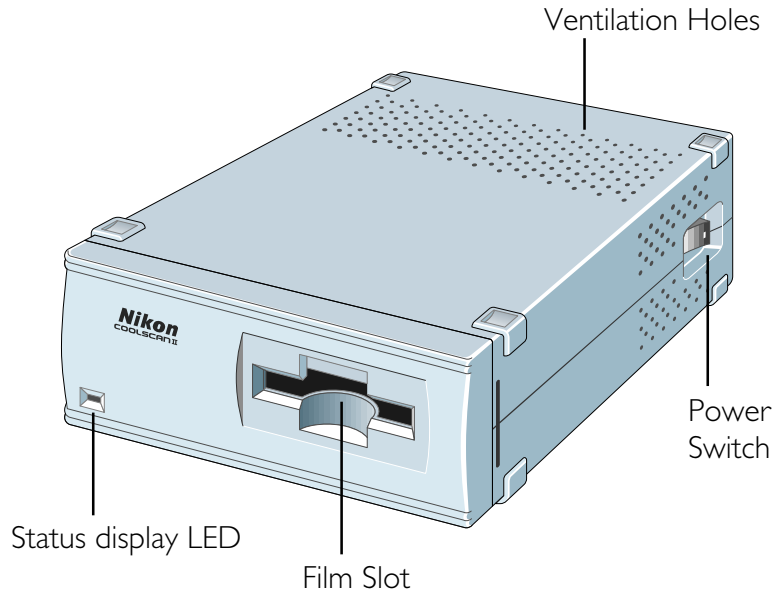

**Film Slot:** The film holder is inserted here.

**Status display LED:** Shows the scanner status.

**Power Switch:** Directly turns the AC power ON/OFF.

**Ventilation Holes:** Since air is drawn in through these holes, make sure that they are not blocked by other equipment.

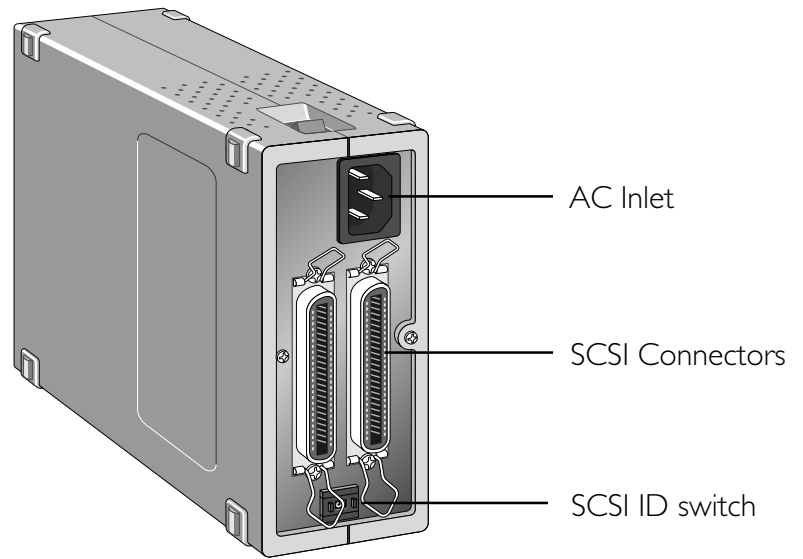

**SCSI Connectors:** For SCSI cable connection. No difference between IN and OUT.

**SCSI ID switch:** Sets the SCSI ID number. Numbers 0 to 7 are shown and valid.

**AC Inlet:** Connect to the AC power source with the power cord provided.

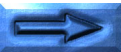

## Internal-mount Model

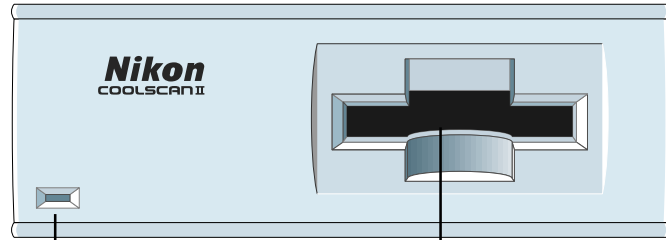

Status display  
LED

Film Slot

**Film Slot:** The film holder is inserted here.

**Status display LED:**  
Shows the scanner status.

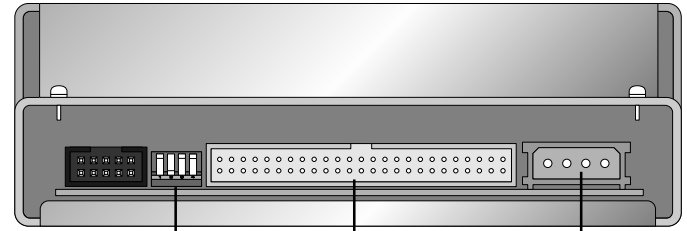

Configuration  
DIP switch

SCSI  
Connector

Power  
Connector

**SCSI Connector:**

For SCSI connection.

**Configuration DIP switch:**

Sets the SCSI ID number.

**Power Connector:**

Connect to the power source.

## 3.2 Status Display LED

The display LED is located on the front panel and shows the scanner status.

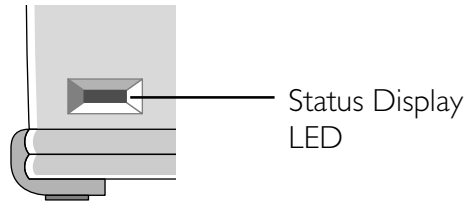

### Steady illumination:

Lights when power is supplied (READY status).

### Blinking (about once every 1.5 seconds):

Blinks slowly during operation (BUSY status). Also blinks when the power is switched on and during initialization.

### Fast blinking (about 5 times a second):

Blinks fast when an error occurs either in the scanner or in communication (ERROR status).

**Note:** *The blinking cycle may sometimes be irregular, but this does not necessarily signify a product malfunction.*

## 3.3 Strip Film Holder FH-2

This strip film holder can be used with a strip of film containing up to six images.

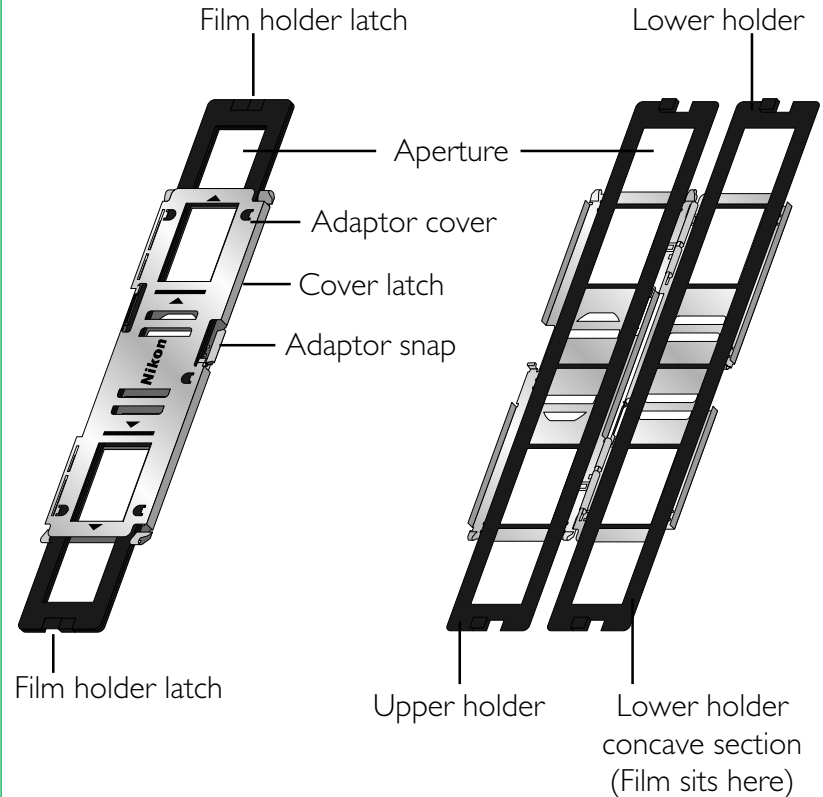

## 4. Setting Up the Standard Model

### 4.1 ✓ Before Connection

Before connecting the cables, confirm that all devices, including the computer system and the COOLSCAN II, are turned off.

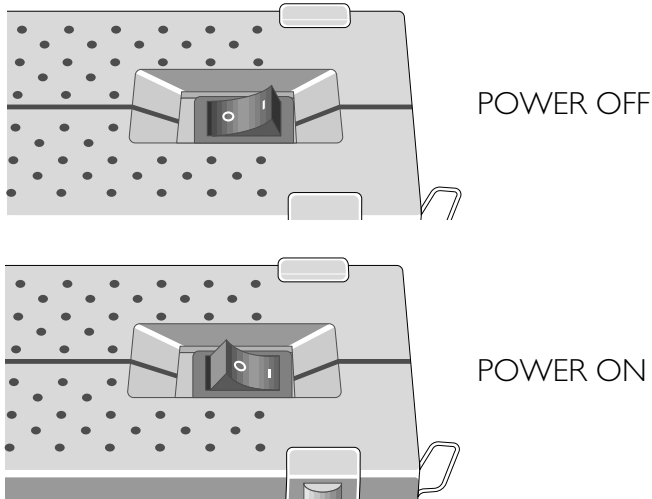

For an IBM PC/AT or compatible in which a SCSI board has not been installed, install a SCSI board as explained in the manual supplied with the board.

**Note:** Make sure that the PC is powered off before installing the SCSI board.

When installing a SCSI board for the first time, be careful not to set conflicting I/O addresses, interrupt numbers, or graphic board DMA channels.

## 4.2 Connecting the Power Cord

Before connecting the power cord, confirm that the unit's power switch is in the off position.

Insert the female end of the supplied power cord into the AC inlet located on the rear panel, then insert the plug into the AC power outlet.

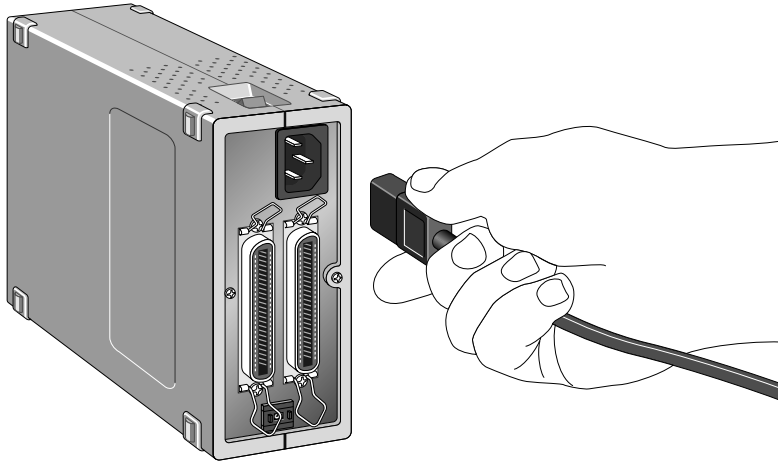

\* The shape of the plug depends on the country of use.

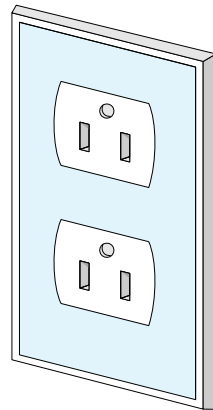
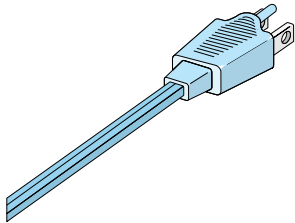

### Remarks

- The power source must be grounded.
- If possible, try to use an independent electric outlet. If the unit is connected to an outlet to which an electric household appliance, such as a vacuum cleaner or air-conditioner, is connected, the product may experience power source noise interference.
- Do not extend the power cord of the product, as this may cause malfunction.

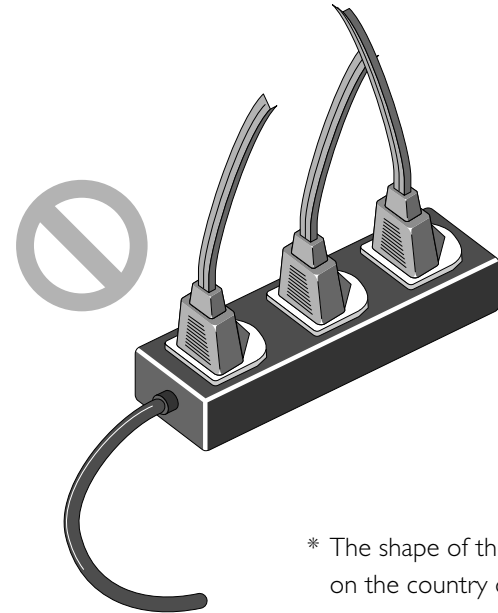

\* The shape of the plug depends on the country of use.

## 4.3 Connecting the SCSI Cable

Before connecting the SCSI cable, confirm that all SCSI devices, including the computer system, have been turned off.

Connect the unit to the computer using the SCSI cable. After attaching the connector, be sure to lock it in place. You can connect the SCSI cable to either of the SCSI connectors on the rear panel of the unit.

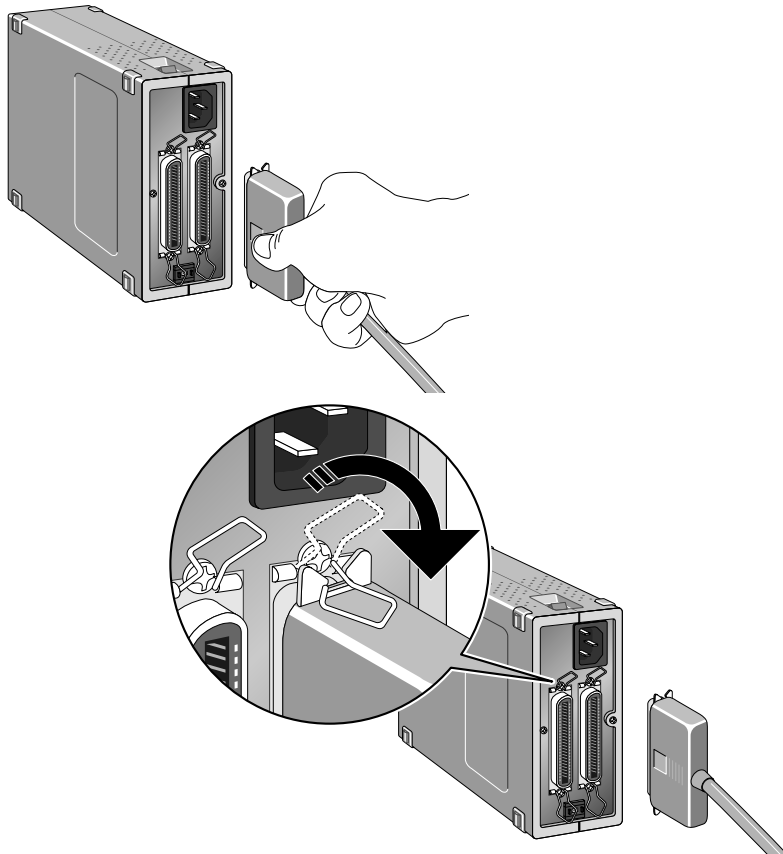

If the unit is the only connected SCSI device, or if the unit is connected at the end of the SCSI chain, attach a terminator (terminal resistance) to the other SCSI connector. At this point, remove the terminator of the other SCSI device that has been placed between them. The terminator is not needed when the unit is connected between other SCSI devices.

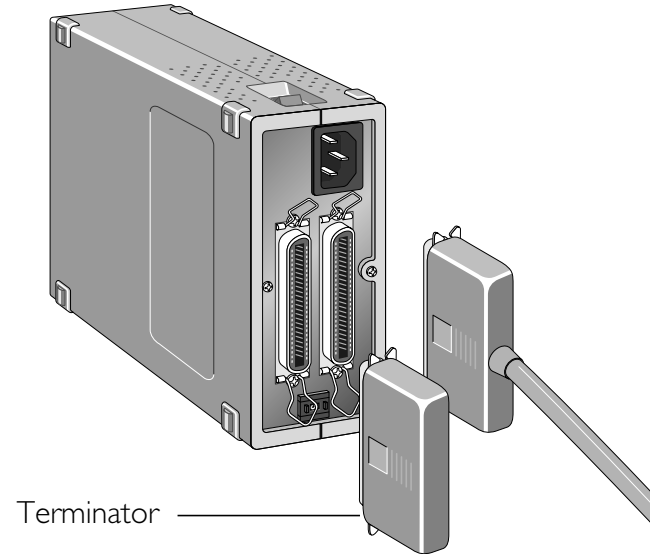

Connect SCSI devices in a chain, and attach terminators to both ends of the chain. Since the terminator is built into the host computer in most cases, the host computer should be at the end of the SCSI chain. The operation manuals of some notebook computers require a terminator to be attached outside the computer; please refer to the operation manual for the computer to which the unit is connected.

**Note:** The SCSI cable used for SCSI connection should be of high-impedance type.







## Remarks

- The maximum number of SCSI devices that can be connected to one computer is eight including the CPU. When using with a host computer with a built-in SCSI hard disk or built-in CD-ROM, note that SCSI ID numbers have been pre-assigned for the host CPU and the SCSI devices.
- The SCSI cable must not be extended beyond a total length of 19 feet (6 meters), or else failure may result.
- If you use the type of terminator that is inserted between the SCSI cable and SCSI interface connector, install a terminator independent of the other SCSI connector of the COOLSCAN II.

- Terminators must be attached to the devices located at both ends of the SCSI chain.

If the host computer is a Macintosh, the Macintosh itself will provide termination at one end of the chain.

If the host computer is an IBM PC/AT or compatible, equipped with a SCSI board, the SCSI board itself will present termination at one end of the chain.

Note that when a SCSI chain connection is made inside a computer, the end of the SCSI device inside the computer will become the end terminal.

- Before installing a SCSI board, be sure to read the user's manual provided with the board. The numbers for the I/O address, interrupt level (INT) and DMA channel might conflict with other interface boards and peripheral devices. If so, change them as explained in the manual.

## 4.4 Setting the SCSI ID

The SCSI ID for the COOLSCAN II is set at "5" when the unit is shipped. If other SCSI devices are connected to your computer, make sure that the SCSI ID for the COOLSCAN II is different from those assigned to other SCSI devices.

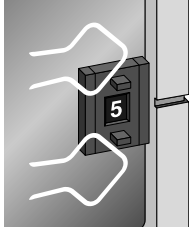

Note that in the case of a host computer which has a built-in SCSI hard disk or built-in CD-ROM, the ID numbers of the host CPU and each SCSI device have already been assigned.

If the IDs are the same, you must change the ID number of the other SCSI device or the ID of the COOLSCAN II to avoid any conflict.

### ✓ Remarks

- To change the ID, confirm that the COOLSCAN II power is off. The ID cannot be changed when the power is on.
- As 7 has been assigned for the CPU and 0 has been assigned to the built-in hard disk for a Macintosh, and 0 and 7 have also been assigned to other personal computer systems, any number from 1 to 6 is recommended for the ID number.
- If conflicting ID numbers are assigned, the system might not function, or important data on the hard disk might be destroyed. It is therefore essential to check the ID numbers carefully before connecting the COOLSCAN II.

## 5. Setting Up the Internal-mount Model

The internal-mount scanner is easy to install, following the procedure described below.

### 5.1 Before Installing

The internal-mount scanner is shown below. Note that the front of the internal-mount model is identical to that of the standard model.

#### Front panel

The front of the scanner includes the film slot and the status display LED.

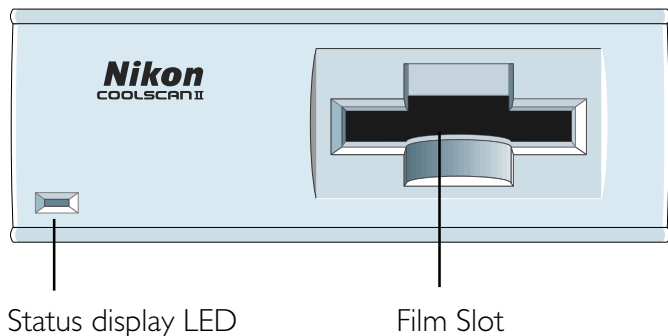

#### Rear panel

The rear panel of the internal-mount scanner is shown below. The rear panel contains the DC power connector, SCSI connector, and configuration DIP switch block.

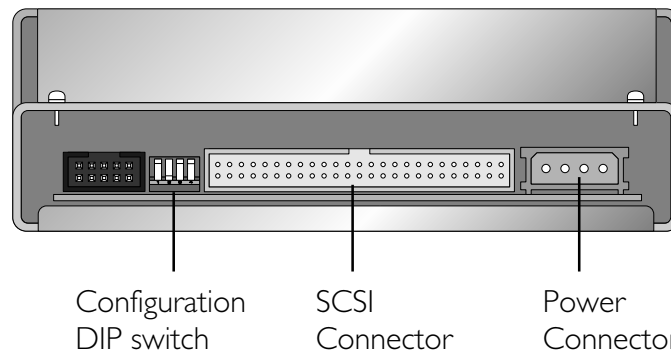

The default DIP switch configuration is shown in Table 5.1. The meaning of the SCSI ID DIP switch is explained later. The internal-mount scanner is set at the factory to SCSI ID #5.

DIP Switch	Default	Usage
1	Closed	SCSI ID bit 0 = 1
2	Open	SCSI ID bit 1 = 0
3	Closed	SCSI ID bit 2 = 1
4	—	(Not used)

Table 5.1 Factory set default DIP switch configuration

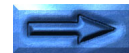

Both sides of the internal-mount scanner are identical as shown below. Note the set of two tapped holes on each side. One set of holes on each side of the scanner will be used for the rails as shown in this figure.

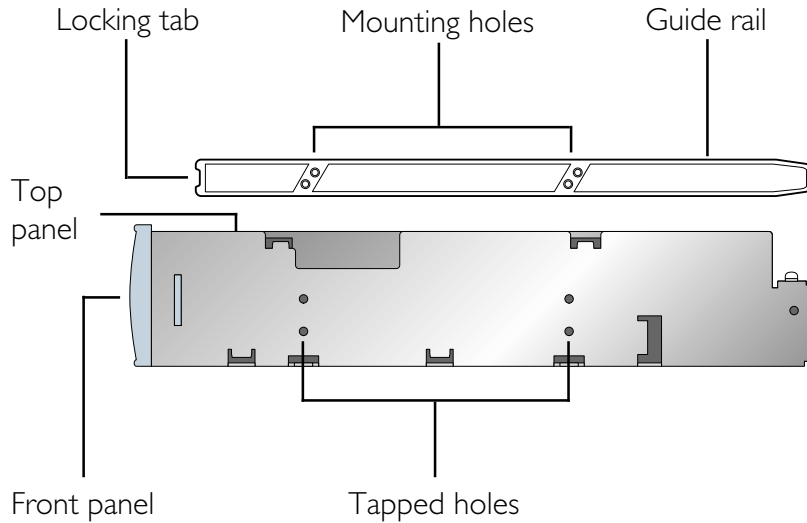

## 5.2 Installing the Internal-mount Model

To install the internal-mount scanner, first screw the guide rails provided with the scanner to the two sides of the scanner, then insert the scanner into the drive bay using the computer drive bay slots. Connections to the back of the scanner include the computer power and the SCSI flat cable.

Due to the tight space constraints inside the computer, it is not possible to connect the cables to the scanner after it has been installed. The SCSI cable and terminating networks are easier to connect to the scanner before it is mounted in the drive bay. The computer power connector is easily connected to the scanner when the scanner is partially inserted into the drive bay.

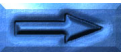

## Installing the guide rails

Different computers have their own special requirements for mounting devices in an internal drive bay. In most cases, a pair of guide rails are screwed to the sides of the scanner to enable it to be slid into the drive bay. These guide rails are also used to lock the scanner in place.

## The computer drive bays

In order for a scanner to be mounted inside the computer, the computer must have the following:

1. An externally accessible 5 1/4" half-height bay
2. A standard power supply connector
3. A card slot available on the motherboard

The scanner will slide into a 5 1/4" half-height drive bay as shown below. To enable film to be inserted into the scanner, the computer must have a cutout for this drive bay, so that the drive bay is externally accessible. The scanner will be powered from the computer using the standard computer drive power supply connector. The computer mother board needs to have an available single short connector slot for the SCSI interface board.

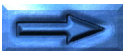
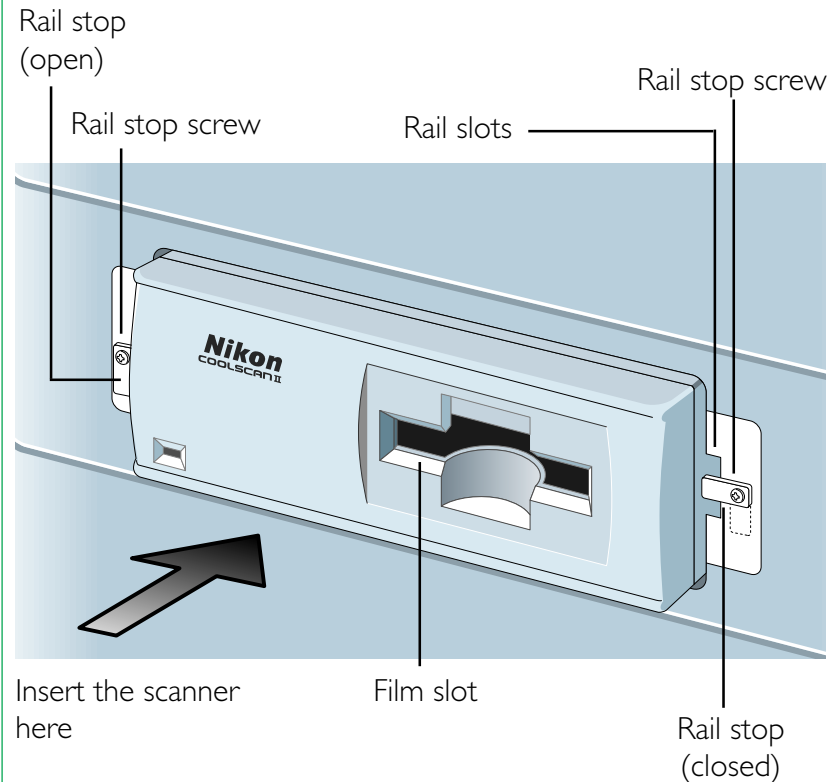

The computer drive bay has one or two metal stops screwed into the tapped holes on the sides of each half-height drive slot. These should be loosened to allow them to either be removed or to hang freely so they do not block the drive bay receptacles for the guide rails. These will be repositioned after the scanner is installed to lock the scanner in place.

### **The scanner side mounting holes**

Two sets of vertical holes are provided on the sides of the scanner. These are the top and bottom rail mounting holes. One set must be chosen according to where the computer allows the scanner to be positioned in the drive bay. Most computers require that the bottom set of mounting holes be used. Position the rails at the bottom of the scanner and, while holding the scanner, see if the scanner will slide into the bay rail slots.

### **The guide rail mounting holes**

The guide rails have a tapered end and a non-tapered end. The tapered end is mounted at the rear of the scanner to facilitate the scanner's insertion into the drive bay slot. The non-tapered end is mounted at the front of the scanner. This flat end allows the scanner to be locked into position once the scanner is installed. Certain holes on the rails are elongated vertically, allowing precise adjustment of the position of the rails with respect to the scanner. The rails have a set of horizontal holes that can be used to position the rails forward or backward with respect to the scanner.

### **Attaching the guide rails to the scanner**

Depending on the type of computer, it may take several tries to find the best combination of holes on the scanner and rails for optimal mounting. The face of the scanner has to fit flush with other peripherals in the drive bays as well as the face of the computer. In addition, the scanner must slide into the drive bay without touching any other devices, or the drive bay itself. It should sit so that the cutout in the computer front panel aligns with the front of the scanner.

Several attempts may be required to align the scanner in the computer drive bay. It is often easiest to identify the best holes while holding the scanner and rails in front of the drive bay. Choose the position that looks best, then screw the rails into the side of the scanner loosely and attempt to push the scanner into the bay. If it fits, remove the scanner, tighten the screws and continue with the installation. If not, move the rails with respect to the scanner and try again until it fits.

### **Sliding the scanner into the drive bay**

Before the scanner is inserted into the drive bay, insure that the DIP switch block is set correctly. In rare cases, it may be necessary to change the configuration of the DIP switch block.

- ✓ On no account force the scanner into the drive bay. It should have a snug fit, yet it should not be necessary to apply excessive force when pushing in the scanner. If it does not slide in easily, reposition the guide rails or visually check the drive bay to see what might be blocking the path of the scanner.



## Installing the internal-mount scanner in the drive bay

### Step 1—Connect the SCSI cable to the scanner

Connect one end of the flat 50-pin SCSI cable to the 50-pin SCSI connector on the rear of the internal-mount scanner as shown below. Insure that Pin 1 of the cable is aligned with Pin 1 of the scanner.

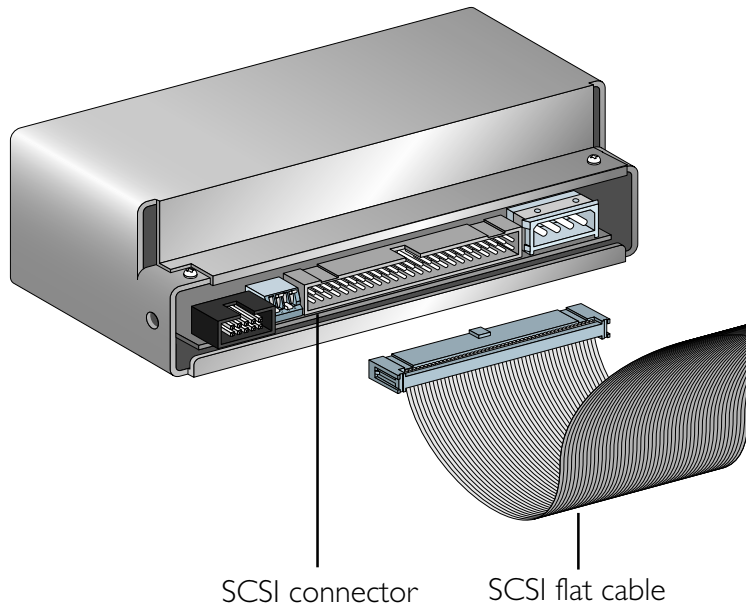

The connectors on both the scanner and the cable are protected with a protruding tab to force the connector to mount properly. Note that Pin 1 on the scanner connector and the cable connector is marked with a triangle, and the wire associated with Pin 1 has a red stripe on it. Do not force the cable connector into the scanner. It should snap into place with moderate force. Make sure that the connector on the cable is positioned parallel to the connector on the scanner before applying force. This will reduce the risk of bending any pins.

✔ **Warning!** *Make sure that Pin 1 marked on the scanner connector mates with Pin 1 of the flat cable connector.*

### Step 2—Terminating the SCSI chain

The internal-mount scanner needs SCSI termination. Refer to “5.4 Terminating the SCSI chain” in this chapter for more information.

### Step 3—Loosen the lock down screws

On one or both sides of the drive bay opening are locking screws. These may be positioned so that they block the access to the openings in the drive bay where the rails will slide in. Loosen these screws so that the metal tab does not block access to the openings. It may be necessary to remove these tabs. Keep them handy because they will be repositioned in Step 8 below.



#### Step 4—Feed the computer power connector

Feed the computer power 4-pin connector, through the drive bay from the inside as far as it will extend out through the drive bay. Connect the cords with each 12V DC or 5V DC connector.

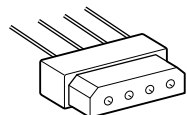

Computer power connector  
(Typical connector on four wire cable)

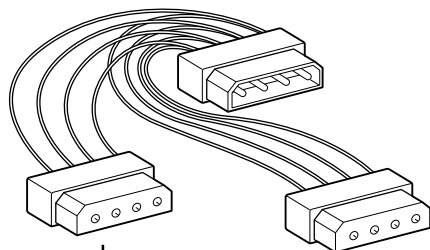

Y-Adapter power connector  
(Optional Y-type power connector)

✓ **Note:** When you establish a ground, connect a grounding cable (not provided) to the GND screw.

GND screw

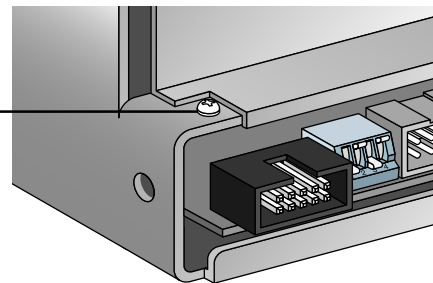

#### Step 5—Slide the scanner part way into the drive bay

Thread the unconnected end of the 50-pin SCSI cable through the drive bay and pull it through into the inside of the computer while sliding the scanner rear-first into the drive bay. The scanner should slide in easily if the rails are properly positioned. Push the scanner in so that the rear of the scanner aligns with the computer power connector.

#### ✓ **Warning!**

The top or bottom of the scanner should not touch anything when sliding into the computer. Damage can occur to the scanner or to other devices if the scanner scrapes during installation.

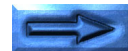



## Step 6—Connect the power connector

Connect the 4-pin power connector of the computer to the 4-pin power connector of the scanner. Note that both connectors are keyed so that one side of the connector is beveled. Be careful to insure that the beveled edges are properly aligned. Under certain circumstances, it is possible to force the connector in at an improper angle, thereby creating a reversed connection. Extreme damage can occur to the scanner should this happen. Make sure that the connection is correct.

**Note:** *An optional Y-adaptor may be necessary if there are no available power connectors in the computer.*

✔ **Warning!** *Do not attempt to connect power to the scanner with the computer power on.*

## Step 7—Slide the scanner into the computer

Once the power connection is made, carefully slide the scanner the rest of the way into the computer. Pull gently on the SCSI cable with one hand to provide slight tension on the cable while the scanner is being pushed in. Do not tug on the cable or allow the cable to fold while pushing in the scanner.

## Step 8—Screw down the rail stops

Once the scanner has been pushed into the computer, reposition or reinsert the lock tabs mentioned in Step 3 above. The tabs should slide in front of the scanner guide rails, thereby locking the scanner in place.

## 5.3 Setting the SCSI ID

Up to eight devices can share a SCSI host. These are each identified by SCSI ID numbers. Thus, a SCSI ID can have a value between 0 and 7. There are no implicit regulations regarding the use of these numbers. Typically, the computer itself would be SCSI ID number 7, while the SCSI peripherals would be 0 through 6.

A minimum of two devices must be connected to any SCSI bus. In this case, one is designated as the initiator while the other is the target. It is possible to have many configurations of initiators and targets on a bus. More than one initiator can be present on a SCSI bus. The typical configuration is one initiator and one or more targets. The internal-mount scanner is always a target. In the case we show below, the only initiator is the computer.

The SCSI ID is typically set by a switch on the rear of the SCSI peripherals. The default SCSI ID number set at the factory is ID #5.



## Determining which ID to use

If the scanner is the only SCSI device that will be connected to the SCSI bus, there is no need to change the SCSI ID from the preset value.

If the scanner must share the SCSI bus with one or more other peripherals, it is necessary to insure that no two peripherals have the same ID. Create a list of SCSI peripherals on the desired bus, noting the device type and the SCSI ID of that device. To determine the SCSI ID of the other peripherals, check the rear of each peripheral for some indication of the SCSI ID of that device. If there is no indication of the ID number, consult the peripheral's user's manual or call the peripheral manufacturer to determine the SCSI ID setting.

## ✓ Remarks

- To change the ID, confirm that the computer power is off. The ID cannot be changed when the power is on.
- As 0 and 7 have been generally assigned to the computer system, any number from 1 to 6 is recommended for the ID number.
- If conflicting ID numbers are assigned, the system might not function, or important data on the hard disk might be destroyed. It is therefore essential to check the ID numbers carefully before connecting the COOLSCAN II.

If another SCSI peripheral shares the same SCSI ID as the COOLSCAN II, change the SCSI ID of the COOLSCAN II to an unused SCSI ID as indicated in the following sections.

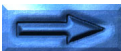

## Setting the SCSI ID on the Internal Scanner

The SCSI ID is set by a set of DIP switches on the back of the internal-mount scanner as shown below. In most cases, these DIP switches will not be changed.

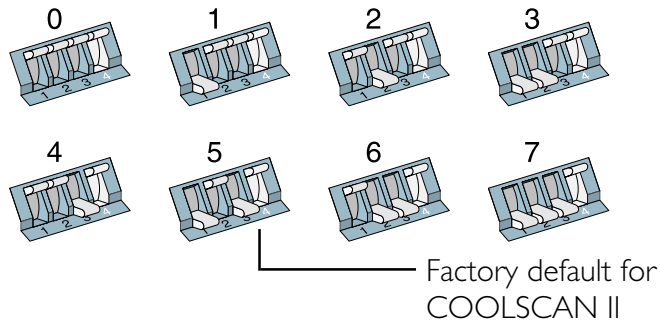

If it is necessary to change the default SCSI ID, change the position of the DIP switches to the proper SCSI ID. Refer to Table 5.2 for the proper DIP switch values. When changing the position of the switches, use a pointed instrument to toggle the switch. Use of a pen or pencil is not recommended, since these will leave a mark on the switch and make it difficult to differentiate between the "on" and "off" positions.

SCSI ID	DIP #1	DIP #2	DIP #3
0	Open	Open	Open
1	Closed	Open	Open
2	Open	Closed	Open
3	Closed	Closed	Open
4	Open	Open	Closed
5	Closed	Open	Closed
6	Open	Closed	Closed
7	Closed	Closed	Closed

Table 5.2 SCSI ID DIP switch values

## 5.4 Terminating the SCSI Chain

The SCSI chain is an electrical bus connecting two or more devices. It is critical that this bus be correctly terminated for the SCSI peripherals to work properly.

Termination is an electronics term that applies to the impedance found at both ends of the bus. The electrical signals on the SCSI bus are changing rapidly between their digital “on” and “off” states. To minimize noise, a terminator is placed on each end of the bus. The effects of this termination may be subtle, but are critical to the correct operation of the scanner on bus.

Typically, the computer is located at one end of the SCSI bus. Assuming this is the case, the SCSI controller in the computer has to be terminated.

**✓ Warning!** *Incorrect SCSI termination can cause unpredictable errors.*

If one other SCSI peripheral shares this SCSI bus, it also has to be terminated. If additional SCSI devices are connected to the bus between the two end SCSI devices, these devices can NOT be terminated. Only two terminated devices can reside on the SCSI bus, one at each end.

Improperly terminated SCSI peripherals can fail immediately or may work correctly for a period of time before generating their first errors.

## Terminating the Internal-mount Scanner

If the LS-20 is at the end of the chain, attach the provided SCSI terminator as described below.

The SCSI terminator is usually inserted between the SCSI connector on the LS-20 and the provided SCSI flat cable, as shown below.

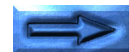
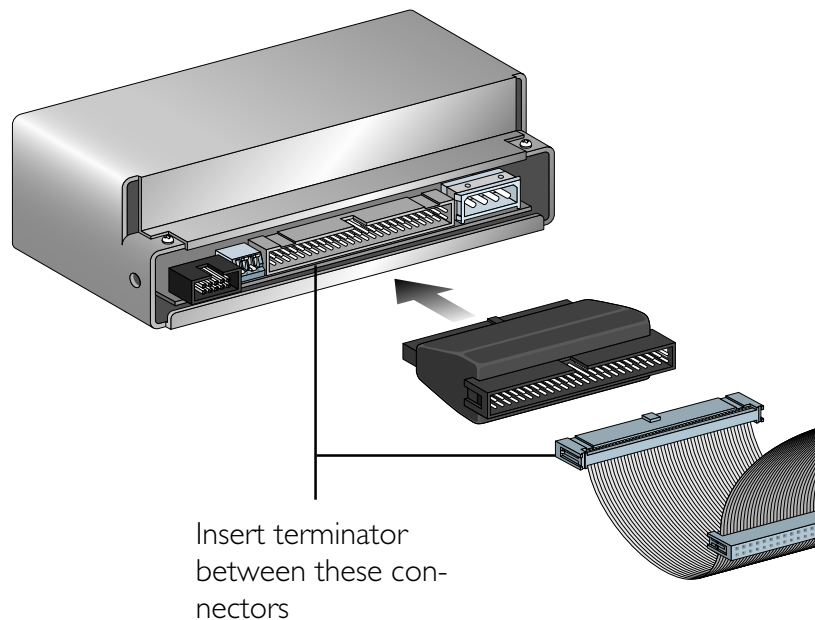

## ✓ Remarks

- When connecting the terminator to the scanner, insert it straight, and correctly aligned with the locator key, taking care not to bend the pins.
- When removing the terminator from the scanner, pull it straight out, taking care not to bend the pins.

If there is not enough space to connect the terminator directly to the LS-20, the SCSI connector on the LS-20 should be attached to the connector stamped in the center of a daisy-chaining flat cable (not provided), and the provided SCSI terminator should be attached to the unconnected stamped connector at one end of this cable.

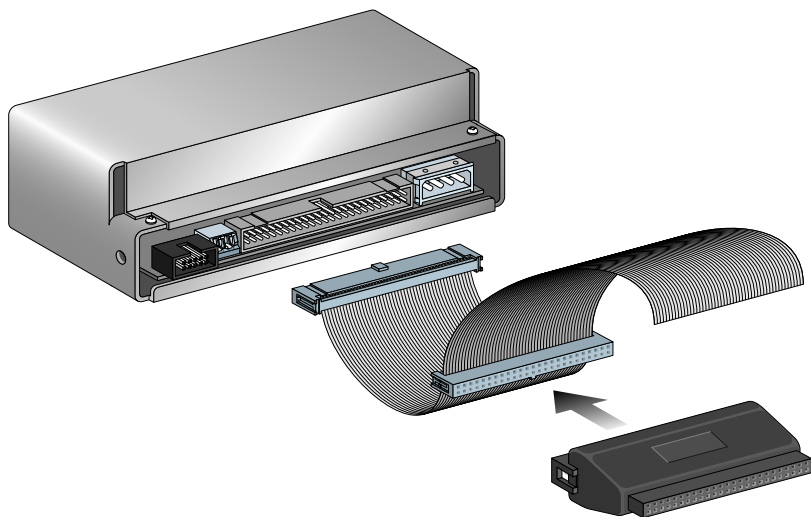

## 5.5 SCSI Cables Used with Internal Scanners

The internal SCSI cable is a 50-pin flat cable with two identical molded connectors on each end. One end of this cable will connect to the SCSI controller while the other end will connect to the connector on the rear of the internal-mount scanner. A typical SCSI internal cable is shown below.

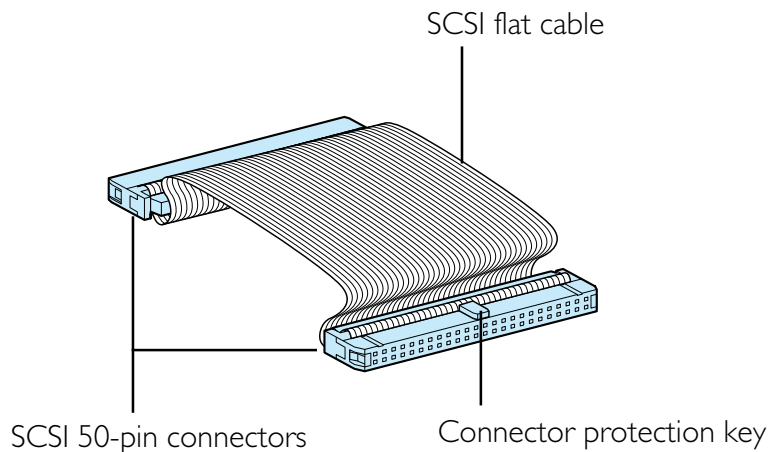

## 5.6 Connecting to the Computer SCSI

The SCSI port on the computer is a connector located either inside the computer or on the rear panel of the computer. There are three basic types of SCSI connectors dealt with in this manual: the 50-pin internal connector, standard 25-pin DB25 type connector, and 50-pin external Centronics connector.

**Warning!** *The SCSI connector should never be connected or disconnected while the computer is running.*

### Connecting inside the computer

The SCSI connector inside the computer will be a 50-pin flat connector as shown below. Note the position of pin 1 and the key. A wide variety of 50-pin flat connectors are used. Some may have keys while others do not; some may have Pin 1 clearly marked while others will not; and some may have mechanical levers to assist in inserting and removing the connector.

To remove connector: Pry the flat cable connector out gently with a small, flat-bladed screwdriver

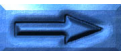
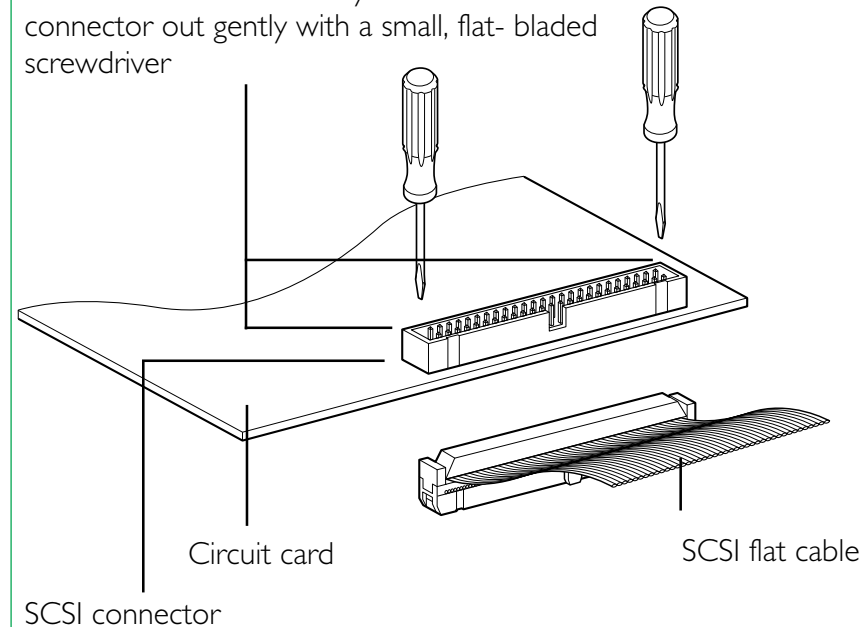

Care must be exercised when inserting and removing these 50-pin connectors. The connecting pins are rather fragile. Follow the rules below when handling these connectors.

1. **Never force the connector in and out.**
2. **Make sure that the connectors are properly aligned before inserting.**
3. **Do not remove a connector from the socket by pulling on the cable. Instead use a small screwdriver to pry each of the sides out, a little at a time.**

This connector is similar to the connector on the back of the internal-mount scanner.

## 5.7 Setting Up a SCSI Chain with the Scanner

The internal-mount scanner is equipped with one SCSI 50-pin connector. When the scanner is connected as the only other device on the chain, or as the last device on the chain, the connector of the 50-pin cable will end at the scanner. This case is shown below.

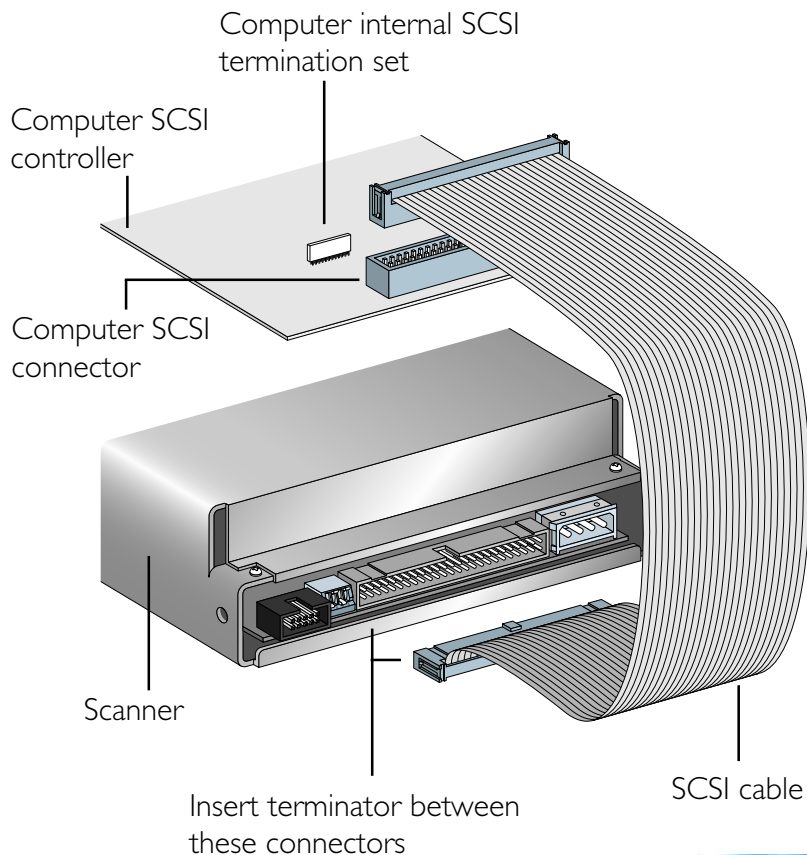

Typically, the scanner will be the only peripheral on the internal SCSI bus. If this is the case, the 50-pin cable provided will work.

In some cases, the scanner will not be the only peripheral on the internal SCSI bus. When this occurs, the SCSI cable provided will not work. A special cable with a connector stamped in the center of the cable as well as a connector stamped on both ends of the cable will be required. This special cable is shown below.

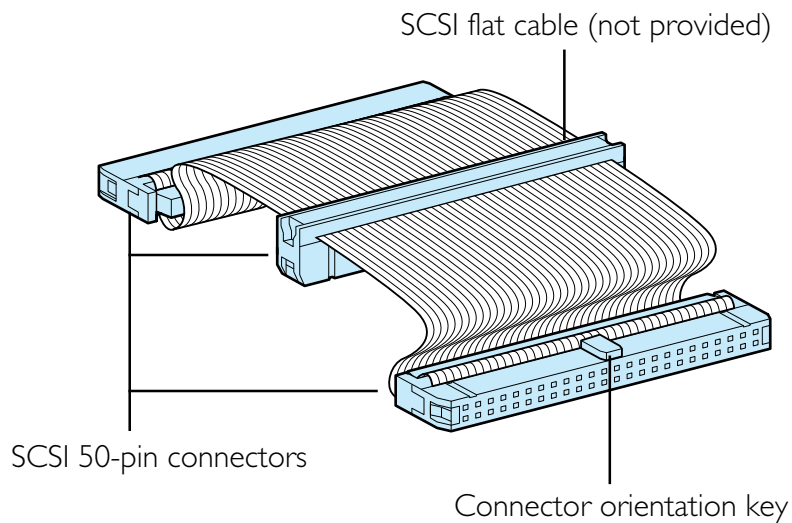



## 6. Operation

### 6.1 Turning on the Power

Turn the COOLSCAN II on first, the other SCSI devices next, and the host computer last. If your scanner is the internal-mount model, you need not turn the COOLSCAN II on.

After turning the power on, the LED will begin to blink to indicate scanner initialization.

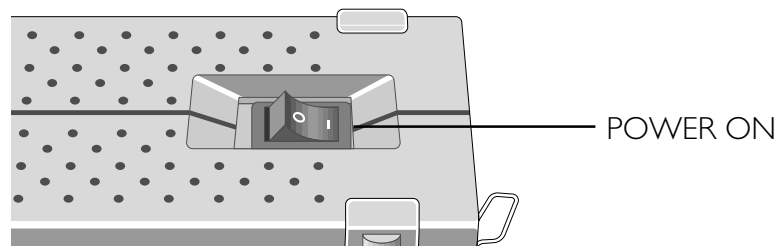

The scanner is self-calibrating. A calibration procedure occurs automatically during power-up. This procedure typically takes about twenty seconds.

Due to the patented light source, there is no warm up time necessary for the scanner. Once the scanner has performed its power-on calibration, it is ready to go.

### ✓ Remarks

- To turn the COOLSCAN II power off, turn the host computer off first, the other SCSI devices next, and the COOLSCAN II last (reverse order from switching on).
- Once the power is turned off, please wait five seconds or more before turning the power on again.
- Do not turn the power off while the scanner is scanning.
- Make sure there is no strip film holder in the scanner during power-up, or the scanner will not calibrate correctly.

## 6.2 Film Insertion

The COOLSCAN II can scan different types of 35mm positive/negative monochrome/color images. In addition, it can scan a film strip of up to 6 frames or single film 'chips'.

### Insertion of Mounted slides

The COOLSCAN II can scan mounted slides as they are.

- Confirm that the thickness of the mounted slides to be scanned is between 1.1mm and 3.0mm.
- Ensure that the emulsion surface is facing up.

When the scanner is installed vertically, insert the mounted slide so that the emulsion surface is facing toward the right (shiny surface facing left).

When the scanner is installed horizontally, insert the mounted slide so that the emulsion surface is facing downward (shiny surface facing upward).

- \* All film has an emulsion surface and a base surface. The emulsion surface is slightly dull and concave. The base surface is slightly convex and is shinier than the emulsion surface.

Insert the mounted slide lengthways until it touches the back of the scanning stage.

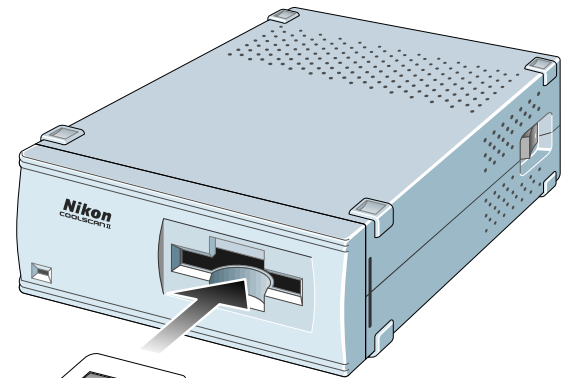
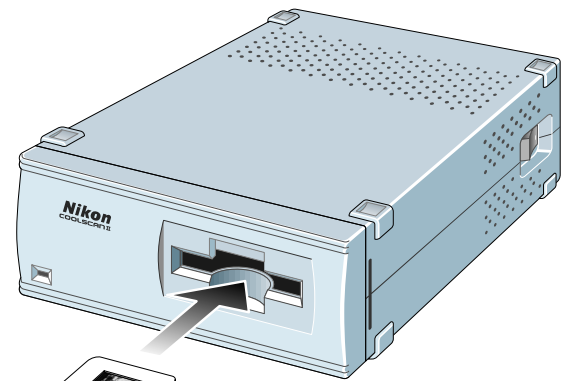

**Note:** Do not insert the mounted slide so that the width and length of the mount are reversed. If you do so, the COOLSCAN II will not be able to scan both sides of the mounted slide.

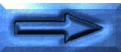

The standard orientation of a mounted portrait or landscape slide is shown below. If the top and bottom are reversed, the image can be flipped using software.

### Orientation of a portrait slide

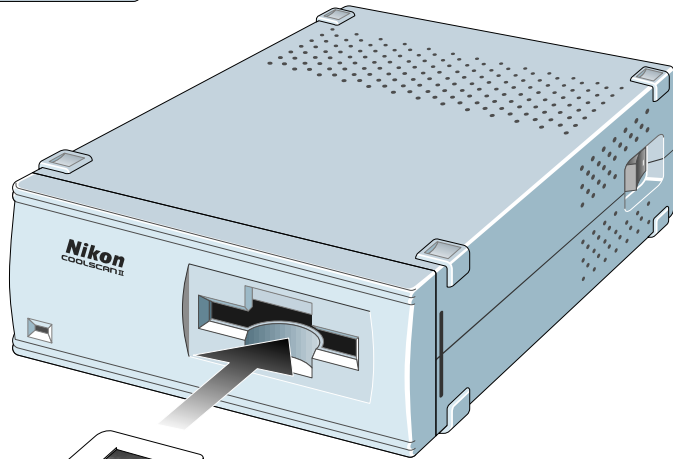

### Orientation of a landscape slide

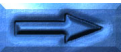
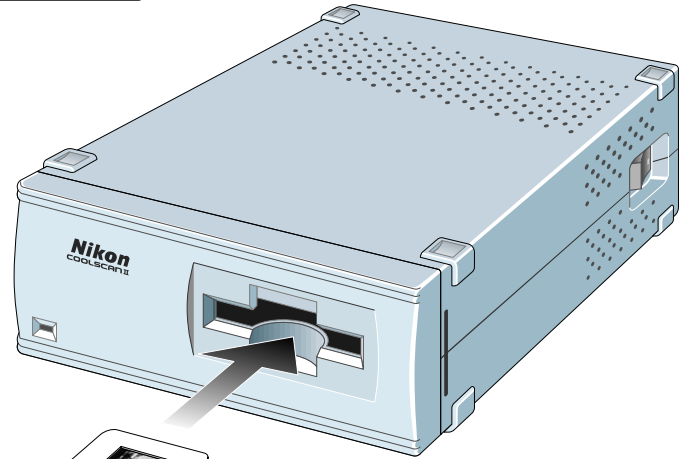

## Insertion of Film Strip

Insert the film strip into the attached film holder FH-2, and then insert the holder into the film slot of the front panel of the unit.

### Step 1

Remove the cover latch and open the upper holder. Be sure the word Nikon, printed on the adaptor cover of the upper holder is facing upward.

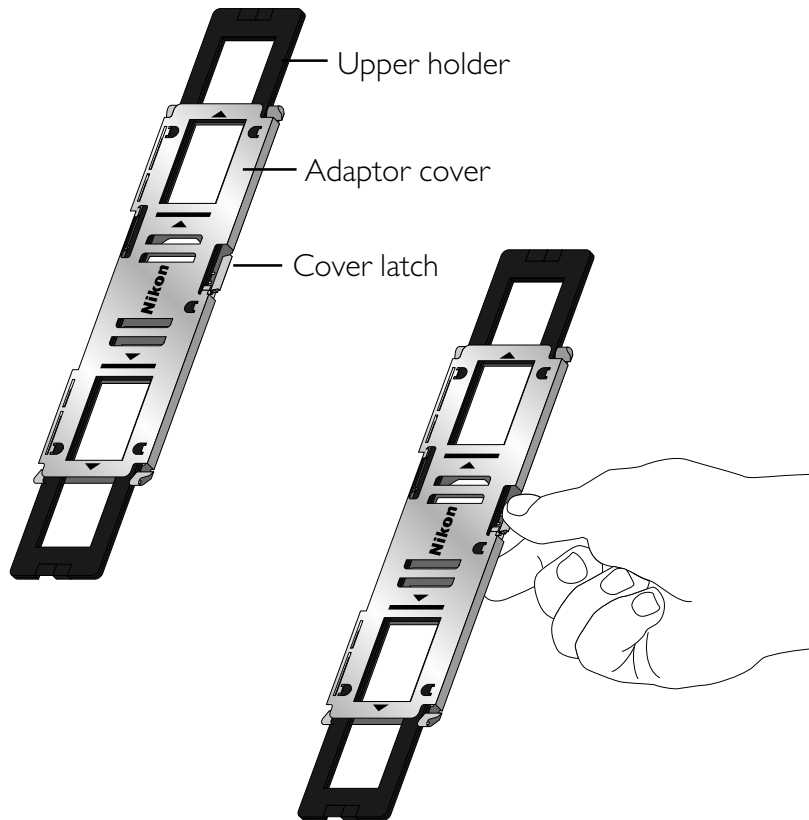

### Step 2

Place the film strip on the concave section which is fixed in the adaptor of the lower holder. Be sure to place the film strip on the lower holder so that the emulsion surface will be facing down (the shiny surface will be facing up). The orientation is correct if the image edge numbers can be read.

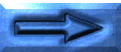
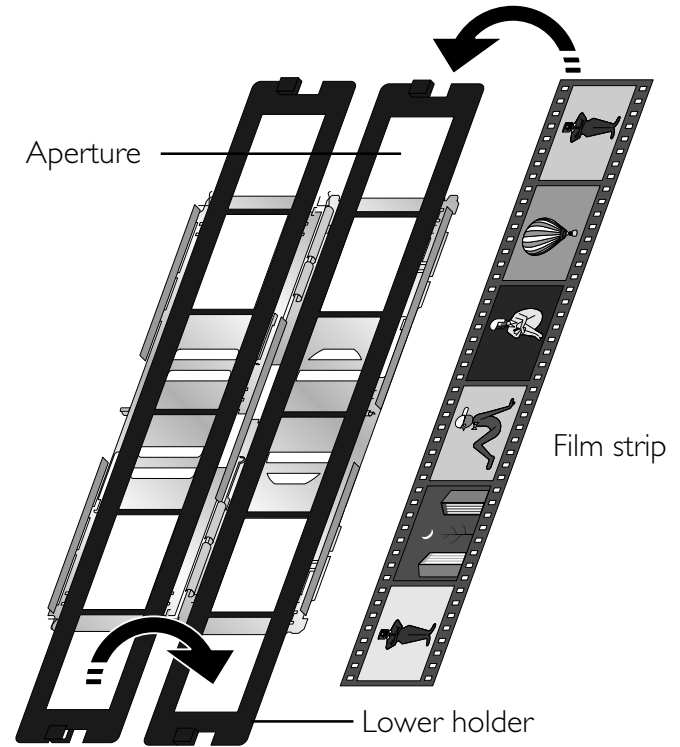

### Step 3

Align each image of the strip film with an aperture in the lower holder.



### Step 4

Close the upper holder, aligning both ends of the upper holder and the lower holder.

Fasten the latches at both ends of the holder after securing the adaptor cover and fastening the cover latch.

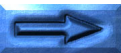
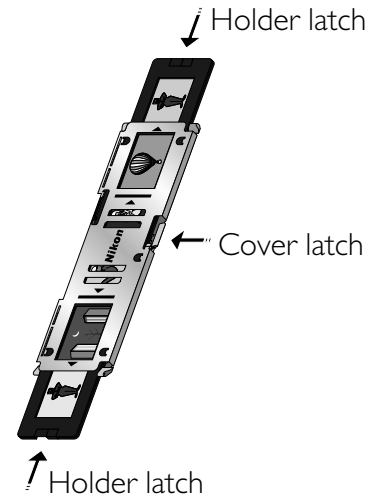

## Step 5

Align the image to be read with either of the two apertures in the silver-colored adaptor frame.

Insert the film holder in the film slot of the front panel in the scanner, with placing the aperture through which the image is to be read toward the slot.

The film holder can be inserted into the COOLSCAN II from either end. Decide the insertion direction of the film holder according to which image is to be read.

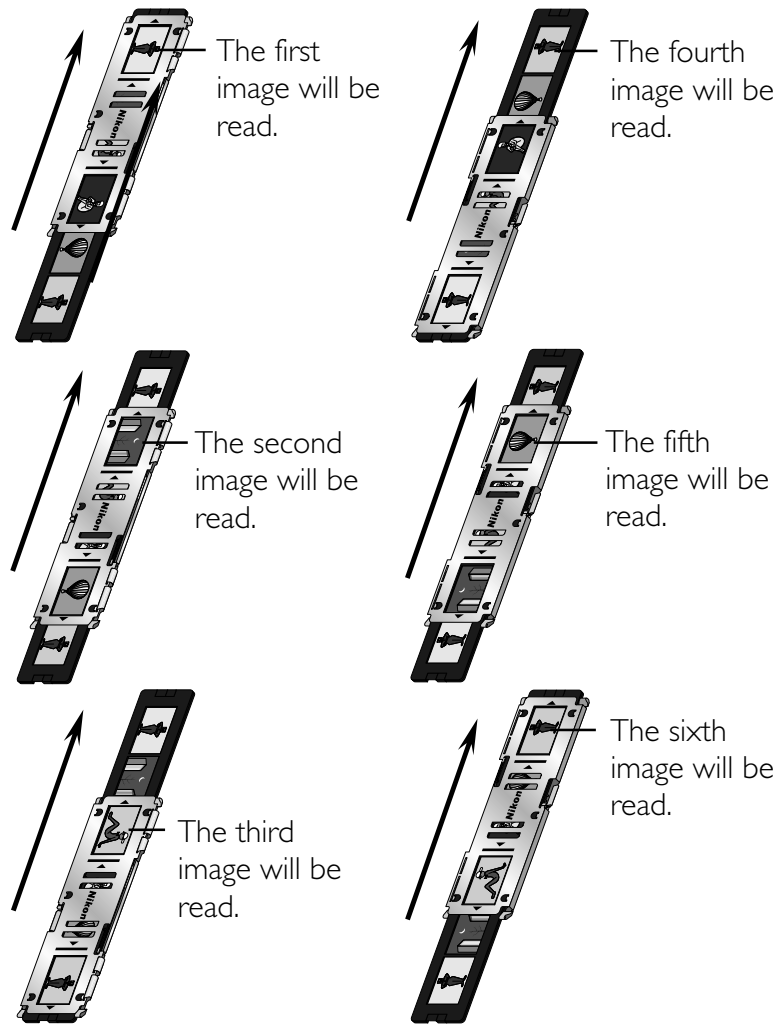

## Step 6

Insert the film holder until it touches the back of the stage and is aligned with the edge of film slot, as shown.

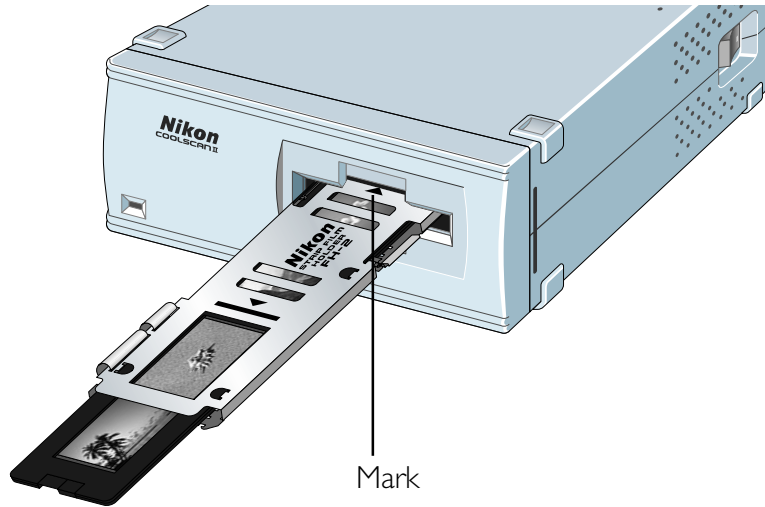

## ✓ Remarks

- Do not force the film holder into the scanner.
- Though the film holder is made of plastic, it will be damaged if film is forced into it.
- Remove dust on the film or film holder with a blower or photographic brush.
- Insert the film holder slowly.

## 7. Troubleshooting

If something unusual should occur, please check the following items before you conclude that there is a unit failure. For more details, refer to the Troubleshooting section of the software manual.

### **Scanner cannot be turned on.**

- Is the Power cord connected?  
Connect the Power cord.
- Is the power switch turned on?  
Turn the power switch on.

### **Scanning cannot be performed.**

- Is the SCSI cable connected?  
Connect the SCSI cable.
- Are you using the supplied SCSI cable?  
Use the supplied SCSI cable.
- Is the end of the connected SCSI cable terminated?  
Connect the terminator.
- Is the SCSI ID number different from the SCSI ID of other devices?  
Change the ID number if it is duplicated.
- Are you using a recommended SCSI board ? (For Windows version)  
Use a recommended SCSI board.

- Are the numbers you have set for I/O, INT and DMA for the SCSI board different from those for other boards? (For Windows version)  
Do not set the conflicting numbers.
- Does your system satisfy our recommended system requirements?  
Provide the recommended system described in the software manual.
- Have you installed software?  
For information on installing and operating software, refer to the software manual provided with the unit.
- Have you properly set the configuration, such as CONFIG.SYS ?  
If you have installed applications for Windows, for instance, note that the configuration may change automatically. (For Windows version)

### **Poor image quality.**

- Have you set the film properly?  
Set the film properly.
- Can you see dust on the film?  
Remove dust on the film with a blower or photographic brush.
- Was the unit subjected to vibration during the scanning operation?  
Place the unit where it will not be subjected to vibration or physical shocks.
- Are you using software properly?  
For details, please refer to the manual for your software.



# Appendix: Specifications

## Reading system/Optics

**Film type:** 35mm film (color or monochrome, negative or positive)

**Reading resolution:**  
2,592 × 3,888 pixels

**Reading area:** 24.3 × 36.5mm

**Effective area:** 23.4 × 35.4mm (with strip film holder)

**Light source:** RGB 3-color LED

**Film holder:** No holder needed for mounted slides. Strip film holder FH-2 for strip film.

**Image optics:** High-resolution optics (Autofocus)

**Focusing:** Auto

**Gradation:** 256 gradations each for R, G and B

## Scanning/Signal processing

### Image scanning (single pass):

Main scanning: 2,592-element CCD line sensor

Sub-scanning: Moving film stage driven by step motor

**Scanning time:** Prescan, Preview: Approx. 20 sec.  
Actual scan: depends on the kind of interface, resolution setting and film density (Approx. 80 sec. for 3-color within a 2,592 × 3,888-pixel range with standard film)

**Resolution:** 2,700 dpi

**A/D conversion:** 8 bit

## Data Transmission

**Interface:** SCSI-2 compliant

**Maximum transfer rate:**  
Approx. 2.66MB/sec with SCSI

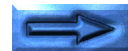

## Others

### Power requirements:

Standard model: AC 100 - 240V, 50/60Hz,  
0.3 - 0.2A

Internal-mount model: DC 5V, 1.5A, DC  
12V, 1.2A

### Panel indicators:

READY, BUSY and ERROR states indicated  
by LED

**Temperature:** 50°F – 95°F (10°C – 35°C)

**Humidity:** 20% – 85% (with no condensation)

**Dimensions:** Standard model: 6.0 (W) × 10.5 (D) × 2.5  
(H) inches (151 × 267.5 × 63.3mm)  
Internal-mount model: 6.0 (W) × 8.2 (D) ×  
1.7 (H) inches (148 × 210 × 42mm)

**Weight:** Standard model: Approx. 4.2lbs (1.9kg)  
Internal-mount model: Approx. 2.0lbs (0.9kg)



# Index

## A

AC inlet 18  
Adaptor cover 44  
Adaptor snap 20

## B

Before use 15

## C

Cleaning the unit 17  
Components 15  
Configuration DIP switch 19  
Connecting the power cord 22  
Connecting the SCSI cable 23  
Connecting to external SCSI 38  
Connecting to internal SCSI 38

## D

Display LED 20  
Drive bay 29  
installing scanner in 30

## F

Film, inserting 42  
Film slot 18, 19

## G

Guide rail mounting holes 30  
Guide rails  
attaching to scanner 30  
installing 29

## I

Internal-mount model 19  
installing 28  
SCSI cables for use with 37

## M

Main unit 18  
Mounting holes 30

## N

Notes on use 17

## O

Operating environment 14

## P

Parts 18  
Power connector 19  
Power switch 18

## S

SCSI  
connecting scanner to an SCSI chain 24, 39  
determining which SCSI to use 34  
setting the internal scanner's SCSI ID 35  
setting the SCSI DIP switches 35  
setting the SCSI ID 26, 33  
terminating the internally mounted model 36  
termination 36  
SCSI connector 18, 19  
SCSI ID switch 18  
Set up 21, 27  
Slides  
mounted, inserting 42  
orientation of landscape slides 43  
orientation of portrait slides 43  
Specifications 49  
Standard model 18  
Status display LED 18, 19  
Strip Film Holder FH-2 20  
upper holder 44  
Strip film, inserting 44

## T

Troubleshooting 48  
Turning on 41

## V

Ventilation holes 18



## EC DECLARATION OF CONFORMITY

We  
Name: Nikon UK Limited  
Address: Nikon House, 380 Richmond Road, Kingston, Surrey KT2 5PR, UK

declare that the product

Product Name: Nikon 35mm Film Scanner LS-20E/LS-20I  
Manufacturer's Name: Nikon Corporation  
Manufacturer's Address: Fuji Bldg., 2-3, Marunouchi 3-chome, Chiyoda-ku, Tokyo 100, Japan

is in conformity with the following Standards

EN55022 Class B  
EN50082-1  
IEC801-2: 1991 4kV  
IEC801-3: 1984 3V/m  
IEC801-4: 1988 1kV AC, 0.5kV I/O

following the provisions of the EMC Directive (89/336/EEC)

## DECLARATION DE CONFORMITE DE LA CEE

Nous  
Nom: Nikon UK Limited  
Adresse: Nikon House, 380 Richmond Road, Kingston, Surrey KT2 5PR, UK

déclarons que ce produit

Nom du produit: Nikon 35mm Film Scanner LS-20E/LS-20I  
Nom du fabricant: Nikon Corporation  
Adresse du fabricant: Fuji Bldg., 2-3, Marunouchi 3-chome, Chiyoda-ku, Tokyo 100, Japan

est conforme aux normes suivantes

EN55022 Classe B  
EN50082-1  
IEC801-2: 1991 4kV  
IEC801-3: 1984 3V/m  
IEC801-4: 1988 1kV AC, 0.5kV I/O

selon les dispositions de la directive de la CEE (89/336/EEC)

## ERKLÄRUNG ÜBER EG-NORMENGERECHTHEIT

Wir  
Name: Nikon UK Limited  
Anschrift: Nikon House, 380 Richmond Road, Kingston, Surrey KT2 5PR, UK

erklären hiermit, daß das folgende Produkt

Produktbezeichnung: Nikon 35mm Filmscanner LS-20E/LS-20I  
Name des Herstellers: Nikon Corporation  
Anschrift des Herstellers: Fuji Bldg., 2-3, Marunouchi 3-chome, Chiyoda-ku, Tokyo 100, Japan

den nachstehend aufgeführten Normen genügt:

EN55022 Klasse B  
EN50082-1  
IEC801-2: 1991 4kV  
IEC801-3: 1984 3V/m  
IEC801-4: 1988 1kV AC, 0.5kV I/O

und zwar gemäß den Bestimmungen der EMC-Richtlinie (89/336/EEC)

Kingston, UK                      September 30, 1995

Place	Date	Signature/Managing Director
Lieu	Date	Signature/Directeur général
Ort	Datum	Unterschrift/Geschäftsführer

## Free Manuals Download Website

<http://myh66.com>

<http://usermanuals.us>

<http://www.somanuals.com>

<http://www.4manuals.cc>

<http://www.manual-lib.com>

<http://www.404manual.com>

<http://www.luxmanual.com>

<http://aubethermostatmanual.com>

Golf course search by state

<http://golfingnear.com>

Email search by domain

<http://emailbydomain.com>

Auto manuals search

<http://auto.somanuals.com>

TV manuals search

<http://tv.somanuals.com>