

Nikon

DIGITAL CAMERA

1 v2

Reference Manual



1

En

Download from [Www.Somanuals.com](http://www.somanuals.com). All Manuals Search And Download.

Thank you for your purchase of a Nikon digital camera. To get the most from your camera, please be sure to read all instructions thoroughly and keep them where they will be read by all who use the product.

Camera Settings

The explanations in this manual assume that default settings are used.

Symbols and Conventions

To make it easier to find the information you need, the following symbols and conventions are used:



This icon marks cautions; information that should be read before use to prevent damage to the camera.



This icon marks notes; information that should be read before using the camera.



This icon marks references to other pages in this manual.

The ▲, ▼, ◀, and ▶ symbols represent up, down, left, and right on the multi selector.

Digitutor

“Digitutor”, a series of “watch and learn” manuals in movie form, is available from the following website:

http://www.nikondigitutor.com/index_eng.html



For Your Safety

Before using the camera for the first time, read the safety instructions in “For Your Safety” (□ x–xii).

1 v2

Getting the Most from Your Camera	 ii
Table of Contents	 iv
 Introduction	 1
 Auto Mode	 23
 P, S, A, and M Modes	 33
 Best Moment Capture Mode	 41
 Advanced Movie Mode	 49
 Motion Snapshot Mode	 59
 More on Photography	 63
 More on Playback	 81
 Connections	 91
 The Playback Menu	 109
 The Shooting Menu	 119
 The Setup Menu	 159
 Technical Notes	 169

Getting the Most from Your Camera

Take photos with the shutter-release button.

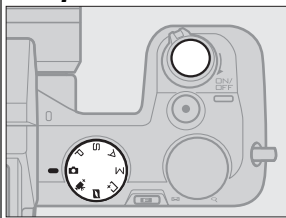

Photos can be taken in any mode by pressing the shutter-release button. In **Motion Snapshot mode** (☞ 59), the camera will also record a brief movie vignette.

Shoot movies with the movie-record button.

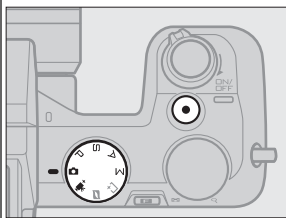

Movies can be recorded by pressing the movie-record button in auto, advanced movie, P, S, A, and M modes. Choose **auto mode** (☞ 23) for basic recording, **advanced movie mode** (☞ 49) for more advanced techniques.

Create short movies with music.

① **Install** the supplied software (☞ 91), ② **copy** photos and movies to your computer (☞ 95), and ③ use Short Movie Creator to **create** short movies (☞ 98).

View short movies in high definition.

① **Transfer** short movies to the camera (☞ 99) and use an HDMI cable to ② **connect the camera to an HDTV** (☞ 100).

Accessories

Expand your photographic horizons with a wide variety of interchangeable lenses, flash units, and other accessories (📖 169).



Lenses



Flash units



GPS units



Remote controls



Software for Nikon digital cameras (available on CD)



Mount adapters



Wireless mobile adapters

Table of Contents

Getting the Most from Your Camera	ii
Accessories	iii
For Your Safety.....	x
Notices.....	xiii
Introduction	1
Package Contents.....	1
Parts of the Camera.....	2
The Camera Body	2
The Monitor	4
The DISP (Display) Button	5
The Mode Dial	7
The Multi Selector	8
The ■ (Feature) Button	9
The MENU Button	10
First Steps.....	12
Auto Mode	23
Taking Photos in Auto Mode.....	23
Viewing Photographs	30
Deleting Pictures	31
Recording Movies in Auto Mode	32
P, S, A, and M Modes	33
Taking Photos in P, S, A, and M Modes	34
P Programmed Auto	34
S Shutter-Priority Auto	35
A Aperture-Priority Auto	36
M Manual.....	37
Recording Movies in P, S, A, and M Modes.....	40

Best Moment Capture Mode	41
Slow View.....	41
Smart Photo Selector.....	44
Viewing Photos Taken with the Smart Photo Selector	47
Choosing the Best Shot	47
Deleting Pictures.....	48
Advanced Movie Mode	49
HD Movies.....	49
Slow Motion	53
Viewing Movies	56
Deleting Movies	57
Motion Snapshot Mode	59
Shooting in Motion Snapshot Mode	59
Viewing Motion Snapshots	62
Deleting Motion Snapshots	62
More on Photography	63
Single-Frame, Continuous, Self-Timer, and Remote Control Modes.....	63
Continuous Mode.....	63
Self-Timer and Remote Control Modes	65
Exposure Compensation	68
The Built-in Flash.....	69
Choosing a Flash Mode	70
Optional Flash Units	72
Attaching Flash Units	72
Taking Pictures	73
The GP-N100 GPS Unit	76
Attaching the GP-N100.....	76
Setup Menu Options	77
The WU-1b Wireless Mobile Adapter	79

More on Playback	81
Photo Information.....	81
Thumbnail Playback	84
Calendar Playback.....	85
Playback Zoom.....	86
Deleting Pictures	87
Deleting the Current Picture	87
The Playback Menu	87
Rating Pictures	88
Slide Shows.....	89
Connections	91
Installing the Supplied Software	91
System Requirements.....	93
Viewing and Editing Pictures on a Computer	95
Transferring Pictures	95
Viewing Pictures	96
Creating Short Movies	98
Viewing Pictures on TV.....	100
High-Definition Devices.....	100
Printing Photographs	102
Connecting the Printer.....	102
Printing Pictures One at a Time.....	103
Printing Multiple Pictures.....	104
Creating a DPOF Print Order: Print Set	108
The Playback Menu	109
Selecting Multiple Images.....	111
Image Review	112
Rotate Tall	112
Protect	112
Rating.....	112
D-Lighting	113

Resize.....	114
Crop	115
Edit Movie.....	116
Change Theme.....	117
The Shooting Menu	119
<hr/>	
Reset Shooting Options	122
Exposure Mode.....	122
Image Quality.....	123
Image Size.....	123
Continuous	125
Silent Photography.....	125
Number of Shots Saved	125
Frame Rate.....	125
Movie Settings	126
Movie Before/After	127
File Format.....	128
Metering	128
Autoexposure Lock.....	129
White Balance	130
Fine-Tuning White Balance.....	131
Preset Manual	132
ISO Sensitivity	135
Picture Control.....	136
Modifying Picture Controls	136
Custom Picture Control.....	140
Edit/Save	140
Load from/Save to Card	141
Auto Distortion Control	142
Color Space.....	143
Active D-Lighting	144
HDR (High Dynamic Range)	145

Long Exposure NR	146
High ISO Noise Reduction.....	146
Movie Sound Options	147
Vibration Reduction.....	148
Focus Mode.....	149
Manual Focus.....	151
AF-Area Mode	153
Focus Lock	154
Face-Priority	156
Built-in AF Assist	156
Flash Control	157
Flash Compensation	158
The Setup Menu	159
Reset Setup Options	160
Format Memory Card.....	161
Slot Empty Release Lock	161
Display Brightness.....	161
Grid Display	162
Auto Power Off.....	162
Self-Timer	162
Remote Control.....	163
Remote on Duration	163
Assign AE/AF-L Button	163
Shutter Button AE Lock	163
Flicker Reduction.....	164
Reset File Numbering	164
Time Zone and Date.....	165
Language	165
Auto Image Rotation.....	166
Pixel Mapping	167
Firmware Version	167

Optional Accessories	169
Approved Memory Cards.....	172
Approved Eye-Fi Cards	173
Attaching a Power Connector and AC Adapter.....	174
Storage and Cleaning	176
Storage	176
Cleaning	176
Caring for the Camera and Battery: Cautions.....	177
Available Settings	181
Defaults	185
Memory Card Capacity	186
Troubleshooting.....	188
Battery/Display	188
Shooting (All Modes).....	189
Shooting (P, S, A, and M Modes).....	190
Movies.....	190
Playback	191
Miscellaneous	191
Error Messages.....	192
Specifications.....	195
Nikon 1 V2 Digital Camera.....	195
Battery Life	210
Index.....	211

For Your Safety

To prevent damage to your Nikon product or injury to yourself or to others, read the following safety precautions in their entirety before using this equipment. Keep these safety instructions where all those who use the product will read them.

The consequences that could result from failure to observe the precautions listed in this section are indicated by the following symbol:



This icon marks warnings. To prevent possible injury, read all warnings before using this Nikon product.

■ WARNINGS

- ⚠ **Keep the sun out of the frame.** Keep the sun well out of the frame when shooting backlit subjects. Sunlight focused into the camera when the sun is in or close to the frame could cause a fire.
- ⚠ **Do not look at the sun through the viewfinder.** Viewing the sun or other strong light source through the viewfinder could cause permanent visual impairment.
- ⚠ **Using the viewfinder diopter adjustment control:** When operating the viewfinder diopter adjustment control with your eye to the viewfinder, care should be taken not to put your finger in your eye accidentally.
- ⚠ **Turn off immediately in the event of malfunction.** Should you notice smoke or an unusual smell coming from the equipment or AC adapter (available separately), unplug the AC adapter and remove the battery immediately, taking care to avoid burns. Continued operation could result in injury. After removing the battery, take the equipment to a Nikon-authorized service center for inspection.
- ⚠ **Do not use in the presence of flammable gas.** Do not use electronic equipment in the presence of flammable gas, as this could result in explosion or fire.
- ⚠ **Do not disassemble.** Touching the product's internal parts could result in injury. In the event of malfunction, the product should be repaired only by a qualified technician. Should the product break open as the result of a fall or other accident, remove the battery and/or AC adapter and then take the product to a Nikon-authorized service center for inspection.
- ⚠ **Keep out of reach of children.** Failure to observe this precaution could result in injury. In addition, note that small parts constitute a choking hazard. Should a child swallow any part of this equipment, consult a physician immediately.
- ⚠ **Do not place the strap around the neck of an infant or child.** Placing the camera strap around the neck of an infant or child could result in strangulation.

⚠ Do not remain in contact with the camera, battery, or charger for extended periods while the devices are on or in use. Parts of the device become hot. Leaving the device in direct contact with the skin for extended periods may result in low-temperature burns.

⚠ Do not aim the flash at the operator of a motor vehicle. Failure to observe this precaution could result in accidents.

⚠ Observe caution when using a flash.

- Using the camera with the flash in close contact with the skin or other objects could cause burns.
- Using a flash close to the subject's eyes could cause temporary visual impairment. Particular care should be observed when photographing infants, when the flash should be no less than one meter (39 in.) from the subject.

⚠ Avoid contact with liquid crystal. Should the displays break, care should be taken to avoid injury due to broken glass and to prevent the liquid crystal from the displays touching the skin or entering the eyes or mouth.

⚠ Observe proper precautions when handling batteries. Batteries may leak or explode if improperly handled. Observe the following precautions when handling batteries for use in this product:

- Use only batteries approved for use in this equipment.
- Do not short or disassemble the battery.
- Be sure the product is off before replacing the battery. If you are using an AC adapter, be sure it is unplugged.

- Do not attempt to insert the battery upside down or backwards.
- Do not expose the battery to flame or to excessive heat.
- Do not immerse in or expose to water.
- Replace the terminal cover when transporting the battery. Do not transport or store the battery with metal objects such as necklaces or hairpins.
- Batteries are prone to leakage when fully discharged. To avoid damage to the product, be sure to remove the battery when no charge remains.
- When the battery is not in use, attach the terminal cover and store in a cool, dry place.
- The battery may be hot immediately after use or when the product has been used on battery power for an extended period. Before removing the battery turn the camera off and allow the battery to cool.
- Discontinue use immediately should you notice any changes in the battery, such as discoloration or deformation.

⚠ Observe proper precautions when handling the charger:

- Keep dry. Failure to observe this precaution could result in fire or electric shock.
- Do not short the charger terminals. Failure to observe this precaution could result in overheating and damage to the charger.
- Dust on or near the metal parts of the plug should be removed with a dry cloth. Continued use could result in fire.
- Do not go near the charger during thunderstorms. Failure to observe this precaution could result in electric shock.
- Do not handle the plug or charger with wet hands. Failure to observe this precaution could result in electric shock.
- Do not use with travel converters or adapters designed to convert from one voltage to another or with DC-to-AC inverters. Failure to observe this precaution could damage the product or cause overheating or fire.

⚠ Use appropriate cables. When connecting cables to the input and output jacks, use only the cables provided or sold by Nikon for the purpose to maintain compliance with product regulations.

⚠ CD-ROMs: CD-ROMs containing software or manuals should not be played back on audio CD equipment. Playing CD-ROMs on an audio CD player could cause hearing loss or damage the equipment.

Notices

- No part of the manuals included with this product may be reproduced, transmitted, transcribed, stored in a retrieval system, or translated into any language in any form, by any means, without Nikon's prior written permission.
- Nikon reserves the right to change the specifications of the hardware and software described in these manuals at any time and without prior notice.
- Nikon will not be held liable for any damages resulting from the use of this product.
- While every effort has been made to ensure that the information in these manuals is accurate and complete, we would appreciate it were you to bring any errors or omissions to the attention of the Nikon representative in your area (address provided separately).

Notice for Customers in Canada

CAUTION

This Class B digital apparatus complies with Canadian ICES-003.

ATTENTION

Cet appareil numérique de la classe B est conforme à la norme NMB-003 du Canada.

Notice for Customers in Europe

CAUTION: RISK OF EXPLOSION IF BATTERY IS REPLACED BY AN INCORRECT TYPE. DISPOSE OF USED BATTERIES ACCORDING TO THE INSTRUCTIONS.

This symbol indicates that this product is to be collected separately.



The following apply only to users in European countries:

- This product is designated for separate collection at an appropriate collection point. Do not dispose of as household waste.
- For more information, contact the retailer or the local authorities in charge of waste management.

This symbol on the battery indicates that the battery is to be collected separately.



The following apply only to users in European countries:

- All batteries, whether marked with this symbol or not, are designated for separate collection at an appropriate collection point. Do not dispose of as household waste.
- For more information, contact the retailer or the local authorities in charge of waste management.

Notice for Customers in the U.S.A.

The Battery Charger

IMPORTANT SAFETY INSTRUCTIONS—SAVE THESE INSTRUCTIONS

DANGER—TO REDUCE THE RISK OF FIRE OR ELECTRIC SHOCK, CAREFULLY FOLLOW THESE INSTRUCTIONS

For connection to a supply not in the U.S.A., use an attachment plug adapter of the proper configuration for the power outlet if needed. This power unit is intended to be correctly oriented in a vertical or floor mount position.

Federal Communications Commission (FCC) Radio Frequency Interference Statement

This equipment has been tested and found to comply with the limits for a Class B digital device, pursuant to Part 15 of the FCC rules. These limits are designed to provide reasonable protection against harmful interference in a residential installation. This equipment generates, uses, and can radiate radio frequency energy and, if not installed and used in accordance with the instructions, may cause harmful interference to radio communications. However, there is no guarantee that interference will not occur in a particular installation. If this equipment does cause harmful interference to radio or television reception, which can be determined by turning the equipment off and on, the user is encouraged to try to correct the interference by one or more of the following measures:

- Reorient or relocate the receiving antenna.
- Increase the separation between the equipment and receiver.
- Connect the equipment into an outlet on a circuit different from that to which the receiver is connected.
- Consult the dealer or an experienced radio/television technician for help.



Nikon
1 V2

CAUTIONS

Modifications

The FCC requires the user be notified that any changes or modifications made to this device that are not expressly approved by Nikon Corporation may void the user's authority to operate the equipment.

Interface Cables

Use the interface cables sold or provided by Nikon for your equipment. Using other interface cables may exceed the limits of Class B Part 15 of the FCC rules.

Notice for Customers in the State of California

WARNING: Handling the cord on this product may expose you to lead, a chemical known to the State of California to cause birth defects or other reproductive harm. *Wash hands after handling.*

Nikon Inc., 1300 Walt Whitman Road,
Melville, New York 11747-3064, U.S.A.
Tel.: 631-547-4200

Notice Concerning Prohibition of Copying or Reproduction

Note that simply being in possession of material that has been digitally copied or reproduced by means of a scanner, digital camera, or other device may be punishable by law.

• Items prohibited by law from being copied or reproduced

Do not copy or reproduce paper money, coins, securities, government bonds, or local government bonds, even if such copies or reproductions are stamped "Sample."

The copying or reproduction of paper money, coins, or securities which are circulated in a foreign country is prohibited.

Unless the prior permission of the government has been obtained, the copying or reproduction of unused postage stamps or post cards issued by the government is prohibited.

The copying or reproduction of stamps issued by the government and of certified documents stipulated by law is prohibited.

• Cautions on certain copies and reproductions

The government has issued cautions on copies or reproductions of securities issued by private companies (shares, bills, checks, gift certificates, etc.), commuter passes, or coupon tickets, except when a minimum of necessary copies are to be provided for business use by a company. Also, do not copy or reproduce passports issued by the government, licenses issued by public agencies and private groups, ID cards, and tickets, such as passes and meal coupons.

• Comply with copyright notices

The copying or reproduction of copyrighted creative works such as books, music, paintings, woodcuts, prints, maps, drawings, movies, and photographs is governed by national and international copyright laws. Do not use this product for the purpose of making illegal copies or to infringe copyright laws.

Disposing of Data Storage Devices

Please note that deleting images or formatting memory cards or other data storage devices does not completely erase the original image data. Deleted files can sometimes be recovered from discarded storage devices using commercially available software, potentially resulting in the malicious use of personal image data. Ensuring the privacy of such data is the user's responsibility.

Before discarding a data storage device or transferring ownership to another person, erase all data using commercial deletion software, or format the device and then completely refill it with images containing no private information (for example, pictures of empty sky). Care should be taken to avoid injury when physically destroying data storage devices.

AVC Patent Portfolio License

THIS PRODUCT IS LICENSED UNDER THE AVC PATENT PORTFOLIO LICENSE FOR THE PERSONAL AND NON-COMMERCIAL USE OF A CONSUMER TO (i) ENCODE VIDEO IN COMPLIANCE WITH THE AVC STANDARD ("AVC VIDEO") AND/OR (ii) DECODE AVC VIDEO THAT WAS ENCODED BY A CONSUMER ENGAGED IN A PERSONAL AND NON-COMMERCIAL ACTIVITY AND/OR WAS OBTAINED FROM A VIDEO PROVIDER LICENSED TO PROVIDE AVC VIDEO. NO LICENSE IS GRANTED OR SHALL BE IMPLIED FOR ANY OTHER USE. ADDITIONAL INFORMATION MAY BE OBTAINED FROM MPEG LA, L.L.C. SEE <http://www.mpegla.com>

Temperature Warnings

The camera may become warm to the touch during use; this is normal and does not indicate a malfunction. At high ambient temperatures, after extended periods of continuous use, or after several photographs have been taken in quick succession, a temperature warning may be displayed, following which the camera will turn off automatically to minimize damage to its internal circuits. Wait for the camera to cool before resuming use.

Use Only Nikon Brand Electronic Accessories

Nikon cameras are designed to the highest standards and include complex electronic circuitry. Only Nikon brand electronic accessories (including chargers, batteries, AC adapters, and flash accessories) certified by Nikon specifically for use with this Nikon digital camera are engineered and proven to operate within the operational and safety requirements of this electronic circuitry.

The use of non-Nikon electronic accessories could damage the camera and may void your Nikon warranty. The use of third-party rechargeable Li-ion batteries not bearing the Nikon holographic seal shown at right could interfere with normal operation of the camera or result in the batteries overheating, igniting, rupturing, or leaking.



For more information about Nikon brand accessories, contact a local authorized Nikon dealer.

Use Only Nikon Brand Accessories

Only Nikon brand accessories certified by Nikon specifically for use with your Nikon digital camera are engineered and proven to operate within its operational and safety requirements. THE USE OF NON-NIKON ACCESSORIES COULD DAMAGE YOUR CAMERA AND MAY VOID YOUR NIKON WARRANTY.

Servicing the Camera and Accessories

The camera is a precision device and requires regular servicing. Nikon recommends that the camera be inspected by the original retailer or a Nikon-authorized service representative once every one to two years, and that it be serviced once every three to five years (note that fees apply to these services). Frequent inspection and servicing are particularly recommended if the camera is used professionally. Any accessories regularly used with the camera, such as lenses or optional flash units, should be included when the camera is inspected or serviced.

Before Taking Important Pictures

Before taking pictures on important occasions (such as at weddings or before taking the camera on a trip), take a test shot to ensure that the camera is functioning normally. Nikon will not be held liable for damages or lost profits that may result from product malfunction.

Life-Long Learning

As part of Nikon's "Life-Long Learning" commitment to ongoing product support and education, continually-updated information is available on-line at the following sites:

- **For users in the U.S.A.:** <http://www.nikonusa.com/>
- **For users in Europe and Africa:** <http://www.europe-nikon.com/support/>
- **For users in Asia, Oceania, and the Middle East:** <http://www.nikon-asia.com/>

Visit these sites to keep up-to-date with the latest product information, tips, answers to frequently-asked questions (FAQs), and general advice on digital imaging and photography. Additional information may be available from the Nikon representative in your area. For contact information, visit <http://imaging.nikon.com/>

Introduction

Package Contents

Confirm that the package contains the following items:

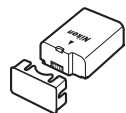
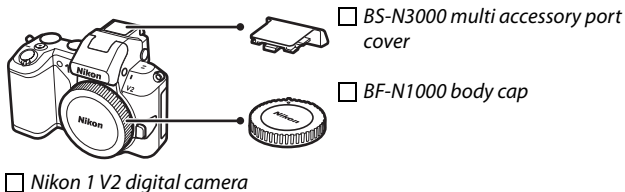

EN-EL21
rechargeable
Li-ion battery
(with terminal cover)



MH-28 battery
charger (AC wall
adapter supplied in
countries or regions where
required; shape depends
on country of sale)

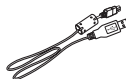

UC-E19
USB cable



Lens (supplied only if
lens kit is purchased with
camera; comes with front
and rear lens caps)

AN-N1000 strap
 ViewNX 2/Short
Movie Creator CD

Warranty
 User's Manual

Reference manual
CD (contains this manual)

Memory cards are sold separately.

Parts of the Camera

Take a few moments to familiarize yourself with camera controls and displays. You may find it helpful to bookmark this section and refer to it as you read through the rest of the manual.

The Camera Body

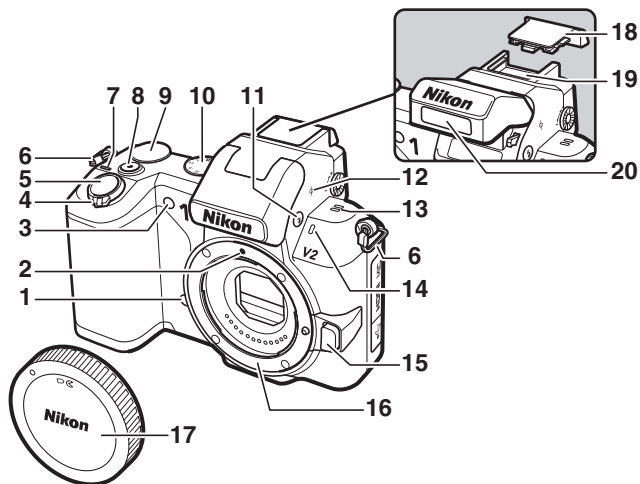

1 Infrared receiver	66, 189	10 Mode dial	7
2 Mounting mark	17	11 \blacksquare (flash) button	69
3 AF-assist illuminator	151, 156	12 Focal plane mark (\ominus)	152
Self-timer lamp	65	13 Speaker	
Red-eye reduction lamp	69	14 Microphone	147
4 Power switch	18	15 Lens release button	203
5 Shutter-release button	26, 42, 45, 51, 60	16 Lens mount	17, 152
6 Eyelet for camera strap	12	17 Body cap	171
7 Power lamp	18	18 Multi accessory port cover	72, 76
8 Movie-record button	32, 40, 50	19 Multi accessory port	72, 76
9 Command dial	9, 30, 152	20 Built-in flash	69

The Camera Body (Continued)

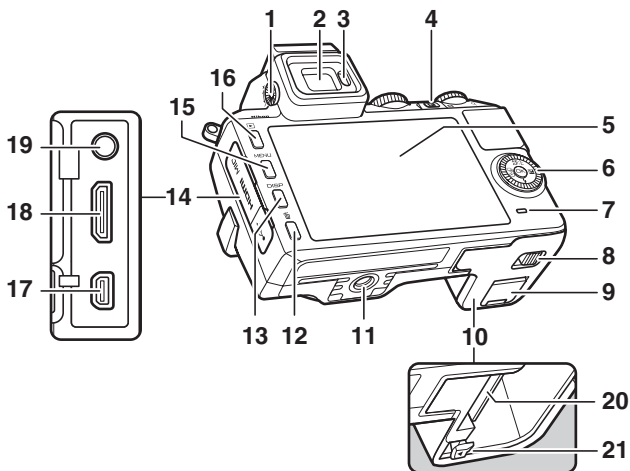

- | | | | |
|--|---------------|--|-------------|
| 1 Diopter adjustment control | 6 | 10 Battery-chamber/
memory card slot cover ... | 14, 16, 175 |
| 2 Electronic viewfinder | 6 | 11 Tripod socket * | |
| 3 Eye sensor | 6 | 12 (delete) button | 31, 87 |
| 4 (feature) button | 9 | 13 DISP (display) button | 5 |
| 5 Monitor | 4, 5 | 14 Connector cover | |
| 6 Multi selector | 8 | 15 MENU (menu) button | 10 |
| (OK) button | 8 | 16 (playback) button | 30, 47, 62 |
| (AE-L/AF-L) | 129, 155, 163 | 17 USB connector | 79, 95 |
| (exposure compensation) | 68 | 18 HDMI mini-pin connector | 100 |
| (flash mode) | 70 | 19 Connector for
external microphone | 171 |
| (continuous shooting/
self-timer) | 63, 65 | 20 Memory card slot | 14 |
| 7 Memory card access lamp | 16, 25 | 21 Battery latch | 14, 16, 174 |
| 8 Battery-chamber/memory card slot
cover latch | 14, 16, 174 | | |
| 9 Power connector cover
for optional power connector | 175 | | |

*TA-N100 tripod adapter not supported.

The Monitor

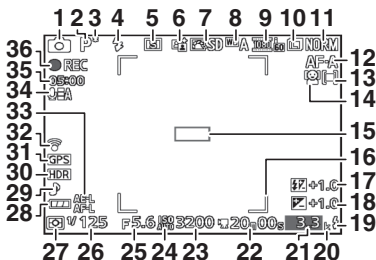

1 Shooting mode 7	21 Number of exposures remaining 21
2 Exposure mode 122	Number of shots remaining
Live image control 28	before memory buffer fills 64
3 Flexible program indicator 34	White balance
4 Flash mode 69	recording indicator 133
5 Self-timer/remote control mode 63	Card warning indicator 161, 192
Continuous mode * 125	22 Time available 50, 54
6 Active D-Lighting * 144	23 ISO sensitivity 135
7 Picture Control * 136	24 ISO sensitivity indicator 135
8 White balance * 130	Auto ISO sensitivity indicator 135
9 Movie settings (HD movies) * 126	25 Aperture 36, 37
Frame rate	26 Shutter speed 35, 37
(slow motion movies) * 125	27 Metering 128
10 Image size * 123	28 Battery indicator * 21
11 Image quality * 123	29 Silent photography * 125
12 Focus mode * 149	30 HDR 145
13 AF-area mode * 153	31 GPS connection indicator * 78
14 Face-priority * 27, 156	32 Eye-Fi connection indicator * 173
15 Focus area 24, 153	33 Autoexposure (AE)/autofocus (AF)
16 AF area brackets * 149	lock indicator 129, 155
17 Flash compensation 158	34 Microphone sensitivity * 147
18 Exposure compensation 68	35 Time elapsed 50, 54
19 Flash-ready indicator 69, 73	36 Recording indicator 50, 54
20 "K" (appears when memory remains	
for over 1000 exposures) 21	

* Available only in detailed display (□ 5).

The DISP (Display) Button

Press DISP to cycle through shooting (4) and playback (81) indicators as shown below.

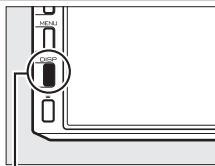

DISP button

Shooting

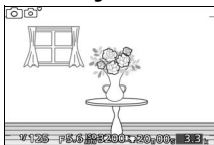

Simplified display

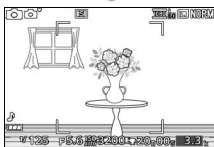

Detailed display

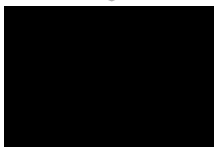

Monitor off
(viewfinder is not affected; 6)

Playback

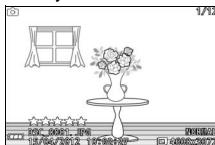

Simple photo info

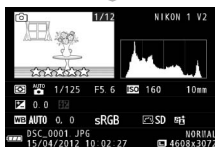

Detailed photo info

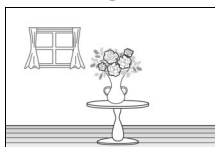
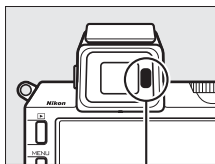

Image only

The Electronic Viewfinder

Use the viewfinder when bright ambient lighting conditions make it difficult to see the display in the monitor. The viewfinder display turns on when you put your eye to the viewfinder and is identical to that shown on page 4; the monitor turns off automatically. Note that the monitor may turn off and the viewfinder turn on if you place your finger or other objects near the eye sensor; avoid covering the sensor when using the monitor.



Eye sensor

To focus the display, use the diopter adjustment control. When operating the control with your eye to the viewfinder, be careful not to put your finger or fingernails in your eye.

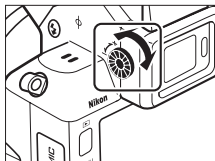

The Framing Grid

A framing grid can be displayed by selecting **On** for **Grid display** in the setup menu (p 162).

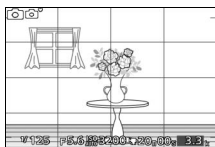

See also

For information on adjusting monitor and viewfinder brightness, see page 161.

The Mode Dial

The camera offers a choice of the following shooting modes:

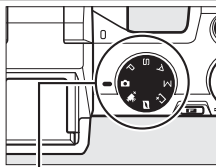

Mode dial

Auto mode (☐ 23): Let the camera pick the settings for photographs and movies.

Advanced movie mode (☐ 49): Choose the exposure mode for HD movies or shoot slow-motion movies.

Motion Snapshot mode (☐ 59): Each time the shutter is released, the camera records a still image and about 1.6 s of movie footage. When the resulting "Motion Snapshot" is viewed on the camera, the movie will play back in slow motion over approximately 4 s, followed by the still image.

Best moment capture mode (☐ 41): Choose the moment to release the shutter as the scene plays back in slow motion (slow view), or let the camera choose the best shot based on composition and motion (Smart Photo Selector).

P, S, A, and M modes (☐ 33): Control shutter speed and aperture for advanced photographic effects.

- **P**: Programmed auto (☐ 34)
- **S**: Shutter-priority auto (☐ 35)
- **A**: Aperture-priority auto (☐ 36)
- **M**: Manual (☐ 37)

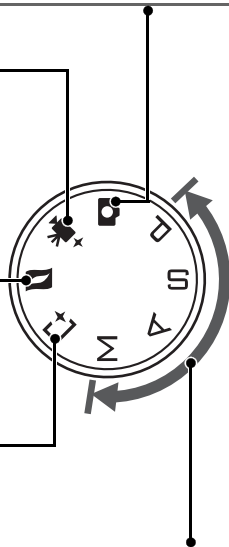

The Multi Selector

The multi selector and  button are used to adjust settings and navigate the camera menus.

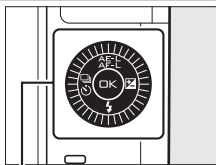

Multi selector

Settings: 

Lock exposure ([□ 129](#)) and/or focus ([□ 154](#)).

Menu navigation: 

Move cursor up.

Settings: 

View continuous shooting/self-timer menu ([□ 63](#)).

Menu navigation: 

Return to previous menu.

Select highlighted item.

Settings: 

View exposure compensation menu ([□ 68](#)).

Menu navigation: 

Select highlighted item or display sub-menu.

Settings: 

View flash mode menu ([□ 69](#)).

Menu navigation: 

Move cursor down.

The Multi Selector

Items can be highlighted by rotating the multi selector as shown at right.







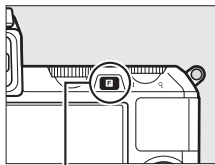



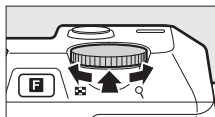

The **F** (Feature) Button

The **F** button gives access to the features listed below. Press **F** to display options for the current mode, then rotate the command dial to highlight the desired option and press the dial to select (options can also be selected using the multi selector and **OK** button).



F button



- **Live image control** (**Q** auto mode;  28): Adjust exposure (**Brightness control**), contrast (**Active D-Lighting**), or depth of field (**Background softening**), or freeze or blur motion (**Motion control**). The effects can be previewed in the monitor.
- **Quick menu access** (P, S, A, and M modes;  33): Access **Metering**, **White balance**, **ISO sensitivity**, **Picture Control**, **Focus mode**, and **AF-area mode** options.
- **Best moment capture** ( best moment capture mode;  43): Choose from **Slow view** and **Smart Photo Selector** options.
- **Advanced movie** ( advanced movie mode;  52): Choose from high-definition (**HD movie**) and slow-motion (**Slow motion**) recording.
- **Theme** ( Motion Snapshot mode;  61): Choose from **Beauty**, **Waves**, **Relaxation**, and **Tenderness**.
- **Rating** (playback mode;  88): Rate pictures.

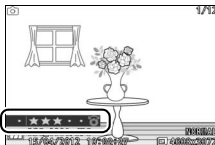

The MENU Button

Most shooting, playback, and setup options can be accessed from the camera menus. To view the menus, press the MENU button.

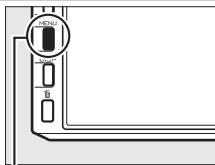

MENU button

Tabs

Choose from the following menus:

▶ Playback menu (📖 109)

🔧 Setup menu (📖 159)

📷 P S A M 📷+ Shooting menu (📖 119)

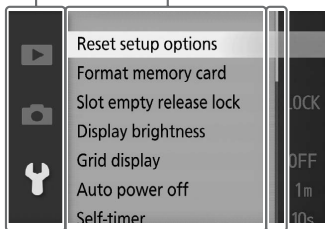

Menu options
Options in current menu.

Slider shows position in current menu.

■ Using the Menus

Use the multi selector (📖 8) to navigate the menus.

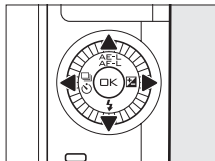

Multi selector

1 Select a menu.

Press ▲ or ▼ to highlight tabs and press ► to position the cursor in the highlighted menu.

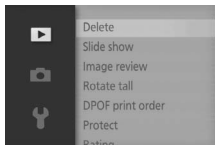

2 Select an item.

Press ▲ or ▼ to highlight menu items and press ► to view options for the highlighted item.

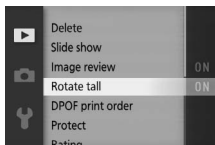

3 Select an option.

Press ▲ or ▼ to highlight the desired option and press  to select.

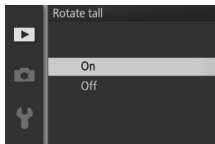

Using the Menus

The items listed may vary with camera settings. Items displayed in gray are not currently available (📖 181). To exit the menus and return to shooting mode, press the shutter-release button halfway (📖 26).



First Steps

1 Attach the camera strap.

Attach the strap securely to the two camera eyelets.

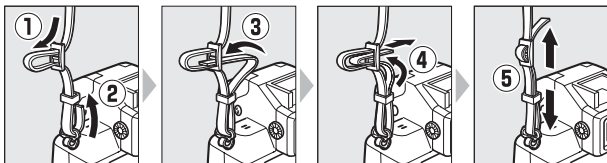

2 Charge the battery.

Insert the battery into the charger ① and plug the charger in ②. An exhausted battery fully charges in about two hours. Unplug the charger and remove the battery when charging is complete.

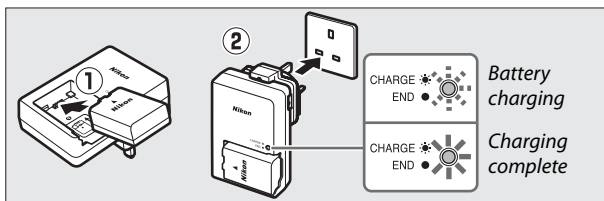

The Plug Adapter

Depending on the country or region of purchase, a plug adapter may be supplied with the charger. The shape of the adapter varies with the country or region of purchase. If a plug adapter is supplied, raise the wall plug and connect the plug adapter as shown at right, making sure the plug is fully inserted. Attempting to forcibly remove the plug adapter could damage the product.

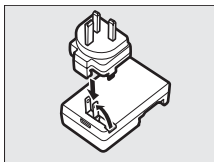

The Battery and Charger

Read and follow the warnings and cautions on pages x–xii and 177–180 of this manual. Do not use the battery at ambient temperatures below 0°C (32°F) or above 40°C (104°F); failure to observe this precaution could damage the battery or impair its performance. Capacity may be reduced and charging times may increase at battery temperatures from 0°C (32°F) to 15°C (59°F) and from 45°C (113°F) to 60°C (140°F); the battery will not charge if its temperature is below 0°C (32°F) or above 60°C (140°F).

Charge the battery at ambient temperatures between 5°C (41°F) and 35°C (95°F). If the **CHARGE** lamp flashes quickly during charging, cease use immediately and take battery and charger to your retailer or a Nikon-authorized service representative.

Do not move the charger or touch the battery during charging. Failure to observe this precaution could in very rare instances result in the charger showing that charging is complete when the battery is only partially charged. Remove and reinsert the battery to begin charging again.

Use the charger with compatible batteries only. Unplug when not in use.



3 Insert the battery and a memory card.

Check to be sure the battery and card are in the correct orientation. Using the battery to keep the orange battery latch pressed to one side, slide the battery in until it latches, and then slide in the memory card until it clicks into place.

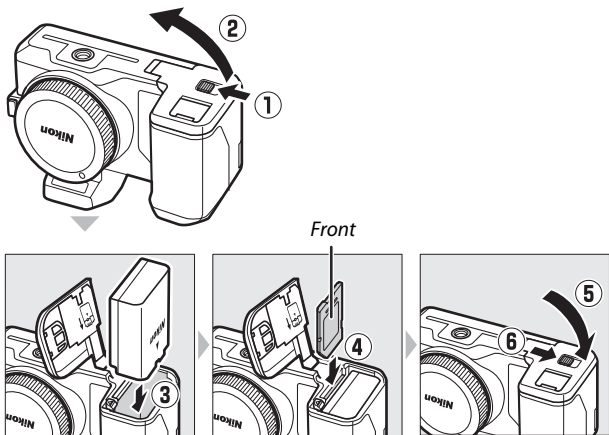

✓ Inserting and Removing Batteries and Memory Cards

Always turn the camera off before inserting or removing batteries or memory cards. Note that the battery may be hot after use; observe due caution when removing the battery.

✍ Formatting Memory Cards

If this is the first time the memory card will be used in the camera or if the card has been formatted in another device, select **Format memory card** in the setup menu and follow the on-screen instructions to format the card (☞ 161). *Note that this permanently deletes any data the card may contain.* Be sure to copy any photographs and other data you wish to keep to a computer before proceeding.



✍ The Write Protect Switch

Memory cards are equipped with a write protect switch to prevent accidental loss of data. When this switch is in the “lock” position, the memory card can not be formatted and photos can not be deleted or recorded. To unlock the memory card, slide the switch to the “write” position.

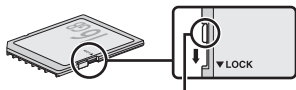

Write-protect switch

Removing Batteries and Memory Cards

After turning the camera off, confirm that the memory card access lamp (☐ 3) is off and open the battery-chamber/memory card slot cover. To remove the battery, first release it by pressing the orange battery latch in the direction shown by the arrow and then remove the battery by hand.

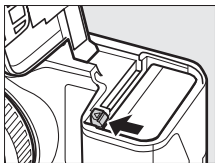

To remove a memory card, first press the card in to eject it (①); the card can then be removed by hand (②).

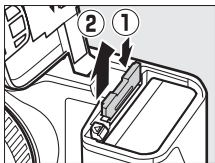

Memory Cards

- The camera stores pictures on SD, SDHC, and SDXC memory cards (available separately; ☐ 172).
- Memory cards may be hot after use. Observe due caution when removing memory cards from the camera.
- Do not remove memory cards from the camera, turn the camera off, or remove or disconnect the power source during formatting or while data are being recorded, deleted, or copied to a computer. Failure to observe these precautions could result in loss of data or in damage to the camera or card.
- Do not touch the card terminals with your fingers or metal objects.
- Do not bend, drop, or subject to strong physical shocks.
- Do not apply force to the card casing. Failure to observe this precaution could damage the card.
- Do not expose to water, heat, high levels of humidity, or direct sunlight.
- Do not format memory cards in a computer.

4 Attach a lens.

Be careful to prevent dust from entering the camera when the lens or body cap is removed. The lens generally used in this manual for illustrative purposes is a 1 NIKKOR VR 10–30 mm f/3.5–5.6. See page 148 for information on vibration reduction (VR) and page 203 for information on removing lenses.

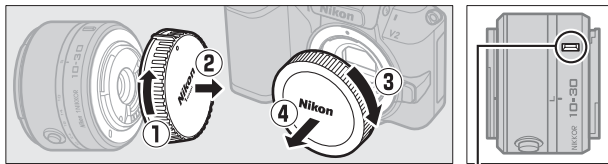

Mounting mark (lens)

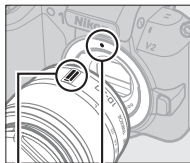

Mounting mark
(camera)

Mounting mark (lens)

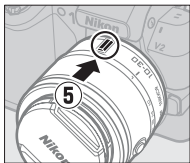

Keeping marks aligned, position lens on camera, then rotate until it clicks into place.

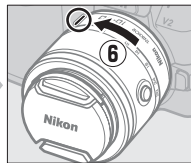

Lenses with Retractable Lens Barrel Buttons

Lenses with retractable lens barrel buttons can not be used when retracted. To unlock and extend the lens, keep the retractable lens barrel button pressed (1) while rotating the zoom ring (2). The lens can be retracted and the zoom ring locked by pressing the retractable lens barrel button and rotating the ring in the opposite direction. Be careful not to press the retractable lens barrel button while attaching or removing the lens.

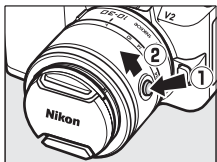

5 Turn the camera on.

Rotate the power switch to turn the camera on. The power lamp will briefly light green and the monitor will turn on. Be sure to remove the lens cap before shooting.

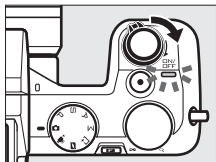

Turning the Camera Off

To turn the camera off, rotate the power switch again. The monitor will turn off.

Auto Power Off

If no operations are performed for about a minute, the displays will turn off and the power lamp start to flash (if desired, the delay before the displays turn off automatically can be changed using the **Auto power off** option in the setup menu; □ 162). The camera can be reactivated by operating the buttons, mode dial, or other camera controls. If no operations are performed for about three minutes after the displays have turned off, the camera will turn off automatically.



Attaching and Removing Lenses

Turn the camera off before attaching or removing lenses. Note that when the camera is turned off, the sensor protection barrier in the lens will close, protecting the camera image sensor.



Lenses with Retractable Lens Barrel Buttons

If you are using a lens with a retractable lens barrel button (□ 17), the camera will turn on automatically when the retractable lens barrel lock is released; in addition, if the view through the lens is displayed or the monitor is off, the camera will turn off when the lens barrel is locked (in the case of 1 NIKKOR VR 10–30mm f/3.5–5.6 and 1 NIKKOR VR 30–110mm f/3.8–5.6 lenses, firmware version 1.10 or later is required if locking the lens barrel is to turn the camera off when the monitor is off; for information on updating lens firmware, visit the Nikon website for your area).

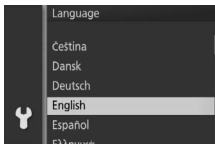

6 Choose a language and set the clock.

A language-selection dialog will be displayed the first time the camera is turned on. Use the multi selector and  button ( 11) to choose a language and set the camera clock. Photos can not be taken until you have set the time and date.



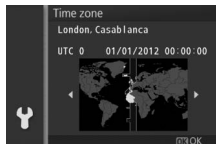

Press  or  to highlight language and press .



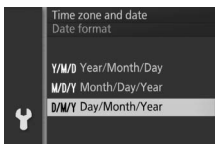

Press  or  to highlight time zone and press .



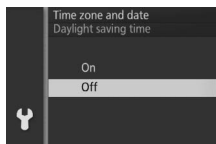



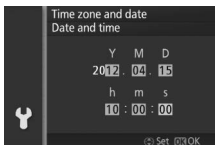

Press  or  to highlight date format and press .



Press  or  to highlight daylight saving time option and press .



Press  or  to select items and press  or  to change. Press  when finished.

Note: The camera uses a 24-hour clock. Language and clock can be changed at any time using **Language** ( 165) and **Time zone and date** ( 165) options in setup menu.

 **The Camera Clock**

The camera clock is less accurate than most watches and household clocks. Check the clock regularly against more accurate time pieces and reset as necessary.

The camera clock is powered by an independent, rechargeable power source, which is charged as necessary when the main battery is installed or the camera is powered by an optional EP-5D power connector and EH-5b AC adapter (□ 174). Three days of charging will power the clock for about a month. If a message warning that the clock is not set is displayed when the camera is turned on, the clock battery is exhausted and the clock has been reset. Set the clock to the correct time and date.



7 Check the battery level and memory card capacity.



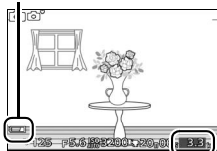

Check the battery level and number of exposures remaining in the monitor.

Battery level





Exposures remaining

Battery Level

Display	Description
NO ICON	Battery fully charged or partially discharged; level shown by  or  icon in detailed display ( 5).
	Low battery. Ready fully-charged battery or prepare to charge battery.
Cannot take pictures. Insert fully-charged battery.	Battery exhausted; shutter-release disabled. Insert charged battery.

Number of Exposures Remaining

The monitor shows the number of pictures that can be stored on the memory card at current settings (values over 1000 are rounded down to the nearest hundred; e.g., values between 1200 and 1299 are shown as 1.2 k). If a warning is displayed stating that there is not enough memory for additional images, insert another memory card ( 14) or delete some photos ( 87).



Auto Mode

Shoot photographs and movies. The camera automatically adjusts settings to suit the subject.

Taking Photos in Auto Mode

1 Select auto mode.

Rotate the mode dial to .

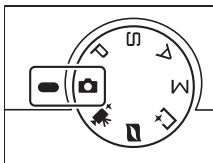

2 Ready the camera.

Hold the camera securely with both hands, being careful not to obstruct the lens, AF-assist illuminator, or microphone. Rotate the camera as shown at lower right when taking pictures in "tall" (portrait) orientation.

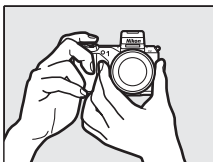

Shutter speeds slow when lighting is poor; use of the built-in flash ( 69) or a tripod is recommended.

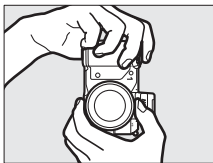

Available Settings

For information on the options available in auto mode, see page 181.

3 Frame the photograph.

Position your subject in the center of the frame.

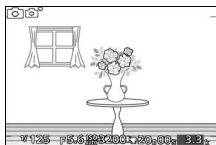

4 Focus.

Press the shutter-release button half-way to focus. If the subject is poorly lit, the AF-assist illuminator (📖 151) may light to assist the focus operation.



If the camera is able to focus, the selected focus area will be highlighted in green and a beep will sound (a beep may not sound if the subject is moving).

If the camera is unable to focus, the focus area will be displayed in red. See page 150.

Focus area

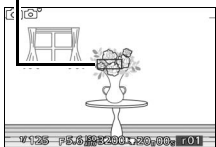

5 Shoot.

Smoothly press the shutter-release button the rest of the way down to release the shutter and record the photograph. The memory card access lamp will light and the photograph will be displayed in the monitor for a few seconds (the photo will automatically clear from the display when the shutter-release button is pressed halfway). *Do not eject the memory card or remove or disconnect the power source until the lamp has gone out and recording is complete.*

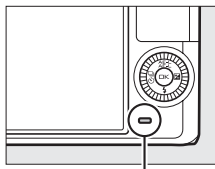

Memory card access lamp

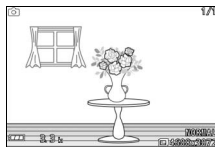

Taking Several Photographs in Succession

If **Off** is selected for **Image review** in the playback menu (📖 112), you can take additional photographs without refocusing by keeping the shutter-release button pressed halfway between shots.



The Shutter-Release Button

The camera has a two-stage shutter-release button. The camera focuses when the shutter-release button is pressed halfway. To take the photograph, press the shutter-release button the rest of the way down.



Focus: Press halfway





Shoot: Press the rest of the way down

Automatic Scene Selection

In auto mode, the camera automatically analyzes the subject and selects the appropriate scene. The selected scene is shown in the monitor.

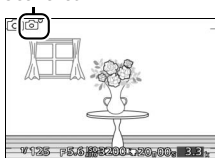
Scene icon



 **Portrait:** Human portrait subjects.

 **Landscape:** Landscapes and cityscapes.

 **Night portrait:** Portrait subjects framed against dark backgrounds.

 **Close up:** Subjects close to the camera.

 **Night landscape:** Poorly-lit landscapes and cityscapes.

 **Auto:** Subjects that do not fall into the categories listed above.

Using a Zoom Lens

Use the zoom ring to zoom in on the subject so that it fills a larger area of the frame, or zoom out to increase the area visible in the final photograph (select longer focal lengths on the lens focal length scale to zoom in, shorter focal lengths to zoom out).

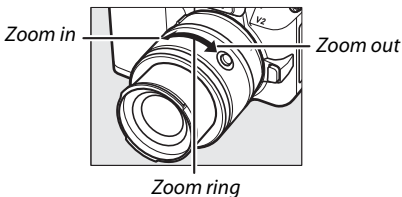

If you are using an optional lens with a power drive zoom switch, select **T** to zoom in and **W** to zoom out. The speed with which the camera zooms in and out varies with how far you slide the switch. The zoom position is shown by the zoom guide in the display.

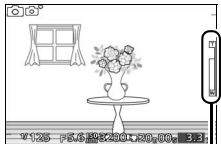

Zoom guide

Face Priority

The camera detects and focuses on portrait subjects (face priority). A double yellow border will be displayed if a portrait subject is detected facing the camera (if multiple faces, up to a maximum of five, are detected, the camera will select the closest subject). Press the shutter-release button halfway to focus on the subject in the double yellow border. The border will clear from the display if the camera can no longer detect the subject (because, for example, the subject has looked away).



■ Live Image Control

Live image controls let you preview how changes to each control will affect the final photograph. To choose a live image control for auto mode, press **F** and use the command dial. Rotate the dial to highlight an item and press the dial to view the effect.

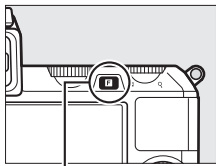

F button

Rotate the command dial to adjust the selected item. To hide live image controls, press **F** again.

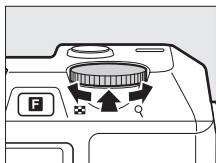

Command dial

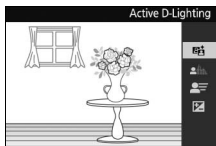

Increase effect

Active D-Lighting: Preserve details in high-lights and shadows for natural contrast.



Active D-Lighting: High



Active D-Lighting: Low

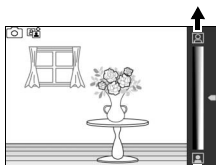

Reduce effect

Background softening: Soften background details to make your subject stand out, or bring both background and foreground into focus.



Background sharp



Background softened

Sharpen background

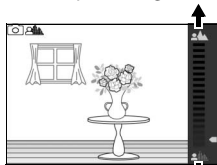

Soften background

Motion control: Suggest motion by blurring moving objects, or “freeze” motion to capture moving objects clearly.



Freeze motion

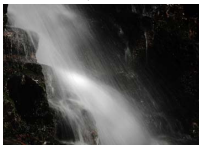

Blur motion

Freeze motion

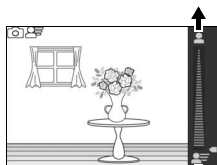

Blur motion

Brightness control: Make pictures brighter or darker.



Brighter

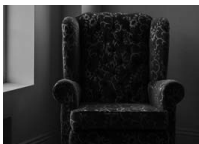

Darker

Brighter

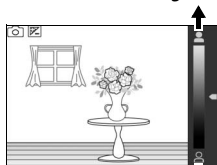

Darker

Live Image Control

When live image control is in effect, the built-in flash and optional flash units can not be used and only one picture will be taken each time the shutter-release button is pressed all the way down, even if  is selected in the continuous/self-timer menu.

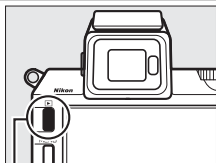

Viewing Photographs

Press  to display your most recent photograph full frame in the monitor (full-frame playback).



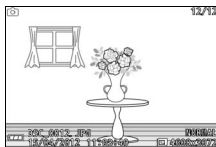

 *button*



Press  or  or rotate the multi selector to view additional pictures.



To zoom in on the center of the current image, rotate the command dial to the right ( 86). Rotate left to zoom out. To view multiple images, rotate the command dial left when the picture is displayed full frame ( 84).

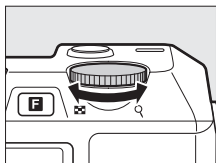

Command dial

To end playback and return to shooting mode, press the shutter-release button halfway.

See Also

For information on toggling photo info on or off, see page 81. See page 89 for information on slide shows.

Deleting Pictures

To delete the current picture, press . Note that once deleted, pictures can not be recovered.

1 Display the photograph.

Display the photograph you wish to delete as described on the preceding page.

2 Press .

A confirmation dialog will be displayed.

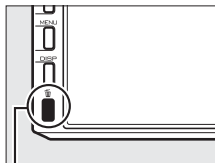

button

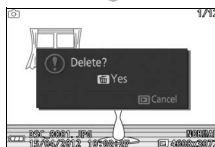

3 Delete the photograph.

Press again to delete the picture and return to playback, or press to exit without deleting the picture.

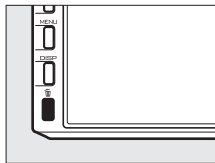

Deleting Multiple Pictures

The **Delete** option in the playback menu (87) can be used to delete selected pictures, all pictures, or pictures taken on selected dates.

Recording Movies in Auto Mode

In auto mode, the movie-record button can be used to shoot movies with sound at an aspect ratio of 16 : 9 (the movie crop is shown in the display). Press the movie-record button to start and stop recording.

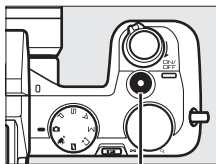

Movie-record button

Taking Photographs During Recording

Photographs can be taken at any time during recording by pressing the shutter-release button all the way down. Movie recording is not interrupted.

See Also

See page 56 for information on viewing movies.

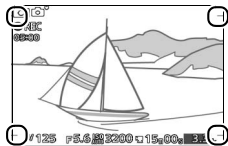

P, S, A, and M Modes

P, S, A, and M modes offer varying degrees of control over shutter speed and aperture. Choose a mode and adjust settings according to your creative intent.

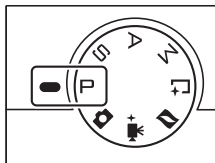

■ Adjusting Settings

In P, S, A, and M modes, the settings below can be accessed directly from the shooting display. Press the **F** button and rotate the command dial to highlight a setting and press the dial to select.

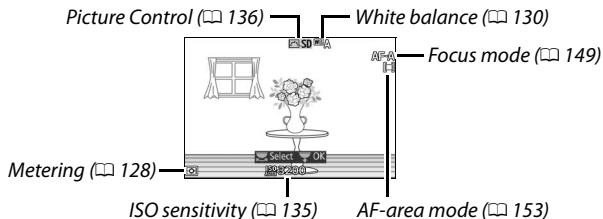

Once selected, the setting can be changed by rotating the command dial. Press the dial again to save changes and exit to shooting mode.

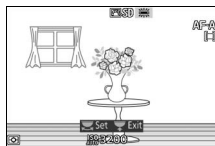

✎ Available Settings

For information on the options available in P, S, A, and M modes, see page 181.

Taking Photos in P, S, A, and M Modes

P Programmed Auto

In this mode, the camera automatically adjusts shutter speed and aperture for optimal exposure in most situations. This mode is recommended for snapshots and other situations in which you want to leave the camera in charge of shutter speed and aperture.

■ Choosing a Combination of Shutter Speed and Aperture

Although the shutter speed and aperture chosen by the camera will produce optimal results, you can also choose from other combinations that will produce the same exposure (“flexible program”). Rotate the command dial right for large apertures (low f-numbers) that blur background details or fast shutter speeds that “freeze” motion. Rotate the dial left for small apertures (high f-numbers) that increase depth of field or slow shutter speeds that blur motion. * is displayed while flexible program is in effect.

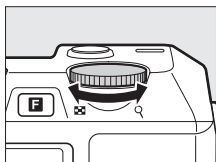

Command dial

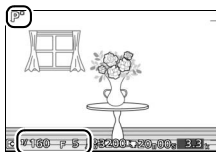

■ Restoring Default Shutter Speed and Aperture Settings

To restore default shutter speed and aperture settings, rotate the command dial until * is no longer displayed, choose another mode, rotate the mode dial, or turn the camera off. The default shutter speed and aperture is automatically restored when the camera enters standby mode.

☒ Shutter-Priority Auto

In shutter-priority auto, you choose the shutter speed while the camera automatically selects the aperture that will produce the optimal exposure. Use slow shutter speeds to suggest motion by blurring moving subjects, fast shutter speeds to “freeze” motion.



Fast shutter speed ($1/1600$ s)

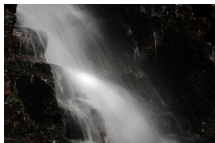

Slow shutter speed (1 s)

☒☒ Choosing a Shutter Speed

Rotate the command dial right for faster shutter speeds, left for slower shutter speeds. Choose from values between 30 s and $1/4000$ s. The electronic shutter, which can be enabled either by selecting **On** for **Silent photography** (☒ 125) or by choosing a frame rate of 15, 30, or 60 fps (☒ 125) in continuous shooting mode (☒ 63), supports shutter speeds as fast as $1/16,000$ s; the slowest shutter speed available with the electronic shutter is 30 s (silent photography) or $1/60$ s (15, 30, and 60 fps continuous).

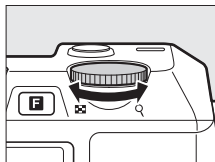

Command dial

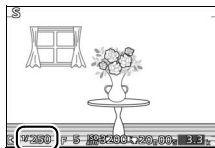

☒☒ Continuous Shooting

The selected shutter speed may change when continuous shooting (☒ 63) is in effect.

A Aperture-Priority Auto

In aperture-priority auto, you choose the aperture while the camera automatically selects the shutter speed that will produce the optimal exposure. Large apertures (low f-numbers) reduce depth of field, blurring objects behind and in front of the main subject. Small apertures (high f-numbers) increase depth of field, bringing out details in the background and foreground. Short field depths are generally used in portraits to blur background details, long field depths in landscape photographs to bring the foreground and background into focus.

PS
AM



Large aperture (f/5.6)



Small aperture (f/16)

■ ■ Choosing an Aperture

Rotate the command dial right for smaller apertures (higher f-numbers), left for larger apertures (lower f-numbers). The minimum and maximum values depend on the lens currently in use.

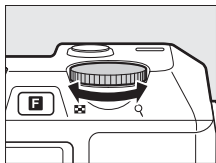

Command dial

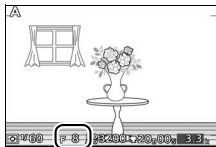

M Manual

In manual exposure mode, you control both shutter speed and aperture.

■ Choosing Shutter Speed and Aperture

Adjust shutter speed and aperture with reference to the exposure indicator (see below). Shutter speed is set by rotating the command dial right for faster speeds and left for slower speeds: choose from values between 30 s and $\frac{1}{4000}$ s (30 s and $\frac{1}{16,000}$ s when the electronic shutter is enabled by selecting **On** for **Silent photography**, or $\frac{1}{60}$ s and $\frac{1}{16,000}$ s when the electronic shutter is enabled by selecting a frame rate of 15, 30, or 60 fps in continuous shooting mode;  63, 125), or select "Bulb" or "Time" to hold the shutter open indefinitely for a long time-exposure. Aperture is selected by rotating the multi selector clockwise for smaller apertures (higher f-numbers) and counter-clockwise for larger apertures (lower f-numbers): choose from values between the minimum and maximum for the lens.

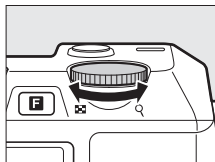

Command dial

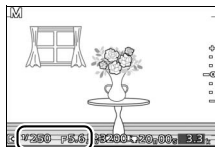

PS
AM

Continuous Shooting

The selected shutter speed may change when continuous shooting ( 63) is in effect.

The Exposure Indicator

When shutter speeds other than “Bulb” or “Time” are selected, the exposure indicator shows whether the photograph would be under- or over-exposed at current settings.

Optimal exposure	Underexposed by $\frac{1}{3}$ EV	Overexposed by over 2 EV
+	+	+
.	.	▲
.	.	■
-○	-○	■
.	.	■
.	.	■
-	-	■

PS
AM

■ Long Time-Exposures (Manual Exposure Mode Only)

Select the following shutter speeds for long time-exposures of moving lights, the stars, night scenery, or fireworks.

- **Bulb:** The shutter remains open while the shutter-release button is held down. To prevent blur, use a tripod.
- **Time:** Requires an optional ML-L3 remote control (📖 170). Start the exposure by pressing the ML-L3 shutter-release button. The shutter remains open until the button is pressed a second time.





1 Ready the camera.

Mount the camera on a tripod or place it on a stable, level surface. To prevent loss of power before the exposure is complete, use a fully charged EN-EL21 battery or an optional EH-5b AC adapter and EP-5D power connector. Note that noise (bright spots, randomly-spaced bright pixels, or fog) may be present in long exposures; before shooting, choose **On** for **Long exposure NR** in the shooting menu (📖 146).

2 Choose a shutter speed.

Select mode M and choose a shutter speed as follows:

- **Bulb:** Rotate the command dial left until “Bulb” is selected for shutter speed.
- **Time:** Rotate the command dial left until “Bulb” is selected for shutter speed, and then select  (remote control mode) for **Continuous/self-timer** ( 63).

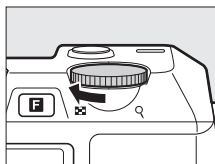

Command dial

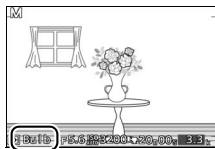

PS
AM

3 Open the shutter.

Bulb: After focusing, press the shutter-release button all the way down. Keep the shutter-release button pressed until the exposure is complete.

Time: Press the ML-L3 shutter-release button all the way down. The shutter will open immediately or after a two-second delay.

4 Close the shutter.

Bulb: Take your finger off the shutter-release button.

Time: Press the ML-L3 shutter-release button all the way down.

Shooting ends automatically after two minutes. Note that some time may be required to record long exposures.

Recording Movies in P, S, A, and M Modes

In P, S, A, and M modes, the movie-record button can be used to shoot movies with sound at an aspect ratio of 16:9 (the corners of the movie crop are shown in the display). Press the movie-record button to start and stop recording. Note that regardless of the mode selected, movies are recorded using programmed auto exposure; to adjust exposure when shooting movies, select advanced movie mode (49).

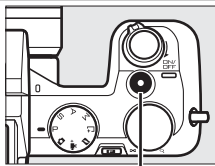

Movie-record button

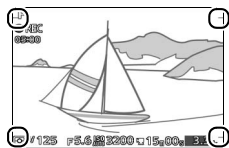

Taking Photographs During Recording

Photographs can be taken at any time during recording by pressing the shutter-release button all the way down. Movie recording is not interrupted.

See Also

See page 56 for information on viewing movies.

Best Moment Capture Mode

This mode is ideal for fast-changing, hard-to-capture subjects. Choose when to release the shutter as the scene plays back in slow motion (slow view), or let the camera choose the best shot based on composition and motion (Smart Photo Selector).

Slow View

In this mode, the camera captures a short sequence of still images and plays them back in slow motion so that you can choose the precise moment for a photograph. While the shutter-release button is pressed halfway, the camera records up to 40 frames over about 1.3 s and plays them back in a continuous slow-motion loop. When the frame you want to keep is displayed, press the shutter-release button the rest of the way down to record the current frame and discard the remaining images.

1 Select mode.

Rotate the mode dial to .

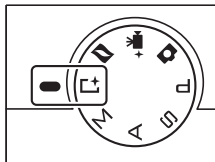

Available Settings

For information on the options available in best moment capture mode, see page 181.

2 Frame the photograph.

Compose the photograph with your subject in the center of the frame.

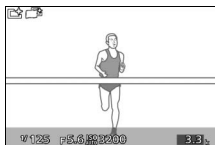

3 Press the shutter-release button halfway.

The camera will focus (24) and then, over a span of about 1.3 s, record 40 frames to a temporary memory buffer.



4 View the buffer contents.

Keep the shutter-release button pressed halfway to play the frames in the buffer back in a continuous loop about 6 s long. The position of the current frame is shown by a progress indicator.

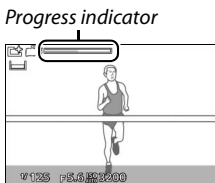

The Capture Illuminator

The optional SB-N5 flash unit is equipped with a capture illuminator which lights during buffering (74).

5 Record the desired frame.

Press the shutter-release button all the way down to record the current frame and discard the remaining images. To exit without recording a photograph, release the button without pressing it all the way down.

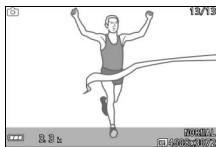

■ ■ Choosing a Capture Mode

Pressing the **F** button in best moment capture mode displays the following options. Rotate the command dial to highlight the desired capture mode and press the dial to select.

- **Slow view:** Take pictures in slow view mode (📖 41).
- **Smart Photo Selector:** Take pictures using the Smart Photo Selector (📖 44).

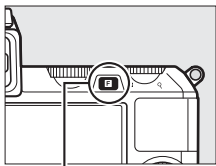

F button

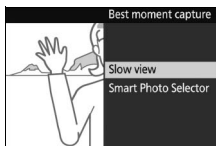

Smart Photo Selector

Choose Smart Photo Selector mode to let the camera help you take photos that capture a fleeting expression on the face of a portrait subject or other hard-to-time shots such as group photos in party scenes. Each time the shutter is released, the camera automatically selects the best shot and a number of best shot candidates based on composition and motion.



1 Select $\square+$ mode.

Rotate the mode dial to $\square+$.

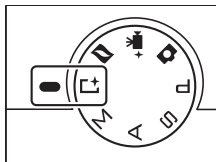

2 Select Smart Photo Selector mode.

Press \mathbf{F} , then rotate the command dial to highlight **Smart Photo Selector** and press the dial to select.

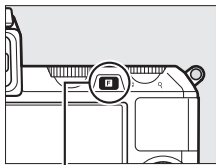

\mathbf{F} button

3 Frame the photograph.

Compose the photograph with your subject in the center of the frame.



4 Begin buffering photographs.

Press the shutter-release button half-way to focus (📖 24). An icon will be displayed as the camera begins recording images to the memory buffer. The camera continuously adjusts focus to account for changes in the distance to the subject while the shutter-release button is pressed halfway.



Buffering

Buffering begins when the shutter-release button is pressed halfway and ends after about 90 seconds or when the shutter-release button is pressed all the way down.

*Shutter-release
button pressed
halfway to focus*

*Shutter-release button
pressed all the way
down*

Shooting ends



The optional SB-N5 flash unit is equipped with a capture illuminator which lights during buffering (📖 74). Buffering ends automatically and the capture illuminator turns off after shooting or if the shutter-release button is kept pressed halfway for about six seconds.

5 Shoot.

Smoothly press the shutter-release button the rest of the way down. The camera will compare shots recorded to the buffer both before and after the shutter-release button was pressed all the way down, and select five to copy to the memory card. Note that some time may be required. The best picture is displayed in the monitor when recording is complete.



Smart Photo Selector Files

Do not delete the "NCSPSLST.LST" file from the "NCFL" folder on the memory card or change the file names of images taken with the Smart Photo Selector. The camera will no longer recognize the affected files as Smart Photo Selector images and will instead handle them as independent photographs.

See Also

Use the **Number of shots saved** option in the shooting menu to choose the number of shots selected by the Smart Photo Selector (📖 125).

Viewing Photos Taken with the Smart Photo Selector



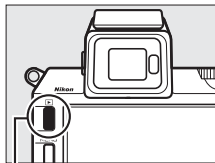

Press  and use the multi selector to display photographs taken with the Smart Photo Selector (📖 30; pictures taken with the Smart Photo Selector are indicated by a  icon). Of the photographs recorded by the Smart Photo Selector, only the best shot will be displayed (when you press the multi selector right to view the next picture, the camera will skip over the best shot candidates, with the result that the next picture displayed will not have a file number that immediately follows that of the current picture). To end playback and return to shooting mode, press the shutter-release button halfway.



 button



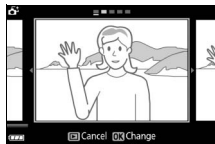

Choosing the Best Shot

When a photograph taken with the Smart Photo Selector is displayed, you can choose the best shot by pressing . Press  or  to view the other pictures in the sequence and press  to select the current picture as the best shot. To return to normal playback, press .



Deleting Pictures

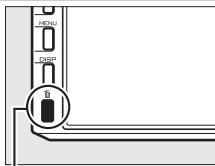

Pressing  when a picture taken with the Smart Photo Selector is selected displays a confirmation dialog; press  again to delete the best shot and the best shot candidates, or press  to exit without deleting the pictures. *Note that once deleted, pictures can not be recovered.*

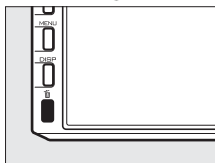
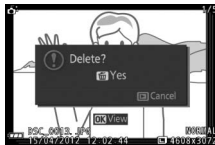

 button



Deleting Individual Photographs

Pressing the  button in the best shot selection dialog displays the following options; highlight an option using the multi selector and press  to select.

- **This image:** Delete the current photo (note that the picture currently selected as the best shot can not be deleted).
- **All except best shot:** Delete the best shot candidates, but not picture currently selected as the best shot.

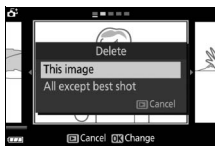

A confirmation dialog will be displayed; to delete the selected image or images, highlight **Yes** and press .

Best Moment Capture Mode

The camera automatically chooses a scene mode appropriate to the subject. Movies can not be recorded, and pressing the movie-record button has no effect. The flash can not be used.

Advanced Movie Mode

Choose this mode to film slow-motion movies or to shoot high-definition (HD) movies in mode P, S, A, or M.

HD Movies

Record movies with sound at an aspect ratio of 16 : 9.

1 Select advanced movie mode.

Rotate the mode dial to . An HD movie crop with an aspect ratio of 16 : 9 will appear in the display.

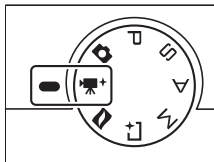

2 Frame the opening shot.

Frame the opening shot with your subject in the center of the display.

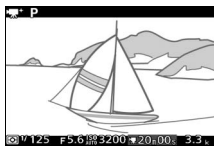

Available Settings

For information on the options available in advanced movie mode, see page 183.

The Icon

A  icon indicates that movies can not be recorded.

See Also

For information on choosing an exposure mode, see page 122. Frame size and frame rate options are described on page 126.

3 Start recording.

Press the movie-record button to begin recording. A recording indicator, the time elapsed, and the time available are displayed while recording is in progress.

Audio Recording

Be careful not to cover the microphone and note that the built-in microphone may record sounds made by the camera or lens. By default, the camera focuses continuously; to avoid recording focus noise, select a focus mode of **AF-S** (□ 149). The **Movie sound options** item in the shooting menu offers sensitivity and wind noise options for both built-in and external microphones (□ 147).

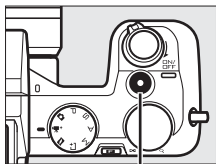

Movie-record button

*Recording indicator/
Time elapsed*



Time available

4 End recording.

Press the movie-record button again to end recording. Recording will end automatically when the maximum length is reached (□ 126), the memory card is full, another mode is selected, the lens is removed, or the camera becomes hot (□ xvi).

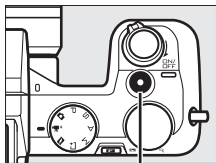

Movie-record button

Maximum Length

At default settings, HD movies can be up to 4 GB in size and 20 minutes in length (for more information, see page 126); note that depending on memory card write speed, shooting may end before this length is reached (□ 172).

Focus and Exposure Lock

Focus and exposure will lock while the AF-L (multi selector up) button is pressed (□ 129, 154).

■ Taking Photographs During HD Movie Recording

Press the shutter-release button all the way down to take a photograph without interrupting HD movie recording. Photographs taken during movie recording have an aspect ratio of 3 : 2.

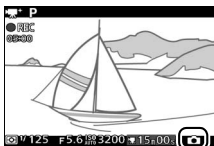

■ Taking Photographs During Movie Recording

Up to 20 photographs can be taken with each movie shot. Please note that photographs can not be taken with slow-motion movies.



■ Choosing the Movie Type

To choose between high definition and slow motion recording, press **F**, then rotate the command dial to highlight one of the following options and press the dial to select:

- **HD movie:** Record movies in HD (📖 49).
- **Slow motion:** Record slow-motion movies (📖 53).

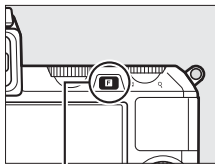

F button

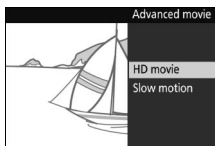

☑ Recording Movies

Flicker, banding, or distortion may be visible in the displays and in the final movie under fluorescent, mercury vapor, or sodium lamps or if the camera is panned horizontally or an object moves at high speed through frame (flicker and banding can be reduced in HD movies by choosing a **Flicker reduction** option that matches the frequency of the local AC power supply, but note that the slowest shutter speed available is $\frac{1}{100}$ s at **50 Hz**, $\frac{1}{60}$ s at **60 Hz**; 📖 164). Bright light sources may leave after-images when the camera is panned. Jagged edges, color fringing, moiré, and bright spots may also appear. When recording movies, avoid pointing the camera at the sun or other strong light sources. Failure to observe this precaution could result in damage to the camera's internal circuitry.

Slow Motion

Record silent movies with an aspect ratio of 8 : 3. Movies are recorded at 400 fps and play back at 30 fps.

1 Select advanced movie mode.

Rotate the mode dial to .

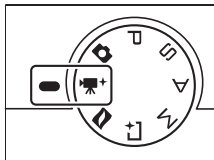

2 Select slow-motion mode.

Press the **F** button, then rotate the command dial to highlight **Slow motion** and press the dial to select. A slow-motion movie crop with an aspect ratio of 8 : 3 will appear in the display.

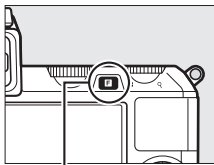

F button

3 Frame the opening shot.

Frame the opening shot with your subject in the center of the display.

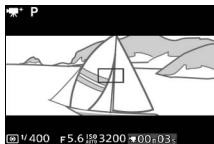

4 Focus.



Focus area

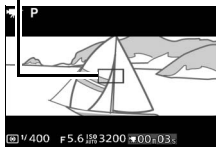

5 Start recording.

Press the movie-record button to begin recording. A recording indicator, the time elapsed, and the time available are displayed while recording is in progress. The camera focuses on the subject at the center of the display; face detection (27) is not available and focus and exposure can not be adjusted.

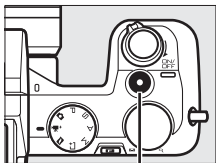

Movie-record button

*Recording indicator/
Time elapsed*

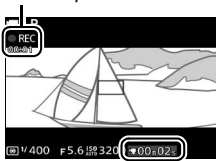

Time available

6 End recording.

Press the movie-record button again to end recording. Recording will end automatically when the maximum length is reached, the memory card is full, another mode is selected, the lens is removed, or the camera becomes hot (☞ xvi).

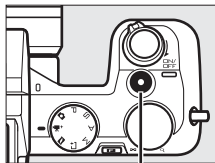

Movie-record button

Maximum Length



Up to 3 seconds or 4 GB of footage can be recorded; note that depending on memory card write speed, shooting may end before this length is reached (☞ 172).

See Also

Frame rate options are described on page 126.



Viewing Movies

Movies are indicated by a  icon in full-frame playback ( 30). Press  to start playback.

 icon/Length

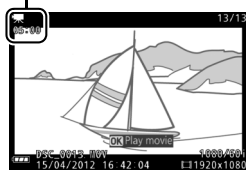

Movie playback indicator/
Current position/total length

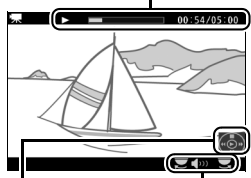











Guide



Volume



The following operations can be performed:

To	Use	Description
Pause		Pause playback.
Play		Resume playback when the movie is paused or during rewind/advance.
Advance/ rewind	 / 	Press  to rewind,  to advance. Speed increases with each press, from 2x to 4x to 8x to 16x. If playback is paused, the movie rewinds or advances one frame at a time; keep the button pressed for continuous rewind or advance. You can also rotate the multi selector to rewind or advance when playback is paused.
Adjust volume		Rotate the command dial to adjust volume.
Return to full-frame playback	 / 	Press  or  to exit to full-frame playback.

Deleting Movies

To delete the current movie, press . A confirmation dialog will be displayed; press  again to delete the movie and return to playback, or press  to exit without deleting the movie. *Note that once deleted, movies can not be recovered.*

See Also

See page 116 for information on trimming unwanted footage from movies.

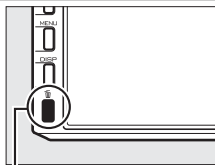

 button

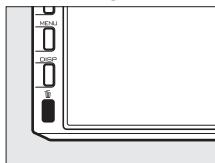



Motion Snapshot Mode

Record brief movie vignettes with your photographs. Each time the shutter is released, the camera records a still image and about 1.6 s of movie footage. When the resulting "Motion Snapshot" is viewed on the camera, the movie will play back in slow motion over approximately 4 s, followed by the still image; playback is accompanied by a background track about 10 s long.

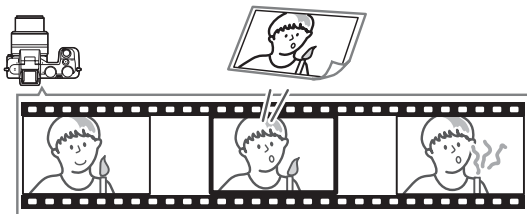

Shooting in Motion Snapshot Mode

1 Select Motion Snapshot mode.

Rotate the mode dial to

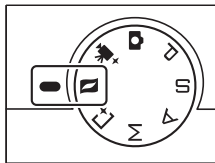

2 Frame the picture.

Compose the photograph with your subject in the center of the frame.



Available Settings

For information on the options available in Motion Snapshot mode, see page 183.

3 Begin buffering.

Press the shutter-release button half-way to focus (📖 24). An icon will be displayed as the camera begins recording footage to the memory buffer.



4 Shoot.

Smoothly press the shutter-release button the rest of the way down. The camera will record a photograph, together with about 1.6 s of movie footage beginning before and ending after the time the shutter-release button was pressed all the way down. Note that some time may be required. When recording is complete, the photograph will be displayed for a few seconds.



Buffering

Buffering begins when the shutter-release button is pressed halfway and ends after about 90 seconds or when the shutter-release button is pressed all the way down.

*Shutter-release
button pressed
halfway to focus*

*Shutter-release button
pressed all the way
down*

Shooting ends



■ Choosing a Theme

To choose the background music for the movie, press **F** and use the command dial to select from **Beauty**, **Waves**, **Relaxation**, and **Tenderness**. Rotate the command dial to highlight an option and press the dial to select.

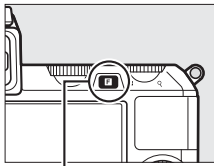

F button

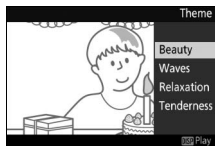

To play the background music for the highlighted theme, press the **DISP** button and use the command dial to adjust volume.

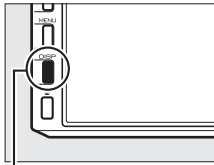

DISP button

🔍 Motion Snapshot Mode





Live audio is not recorded. Movies can not be recorded using the movie-record button and the flash can not be used.

The optional SB-N5 flash unit is equipped with a capture illuminator which lights during buffering (📖 74). Buffering ends automatically and the capture illuminator turns off after shooting or if the shutter-release button is kept pressed halfway for about six seconds.

🔍 See Also

See page 127 for information on choosing what portions of the buffer are included in the movie footage. For information on saving Motion Snapshots in a format that can be viewed in most movie playback software, see page 128.

Viewing Motion Snapshots

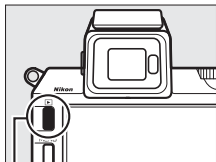

Press  and use the multi selector to display a Motion Snapshot ( 30; Motion Snapshots are indicated by a  icon). Pressing  when a Motion Snapshot is displayed plays back the movie portion in slow motion over a period of about 4 s, followed by the photo; the background track plays for about 10 s (to choose a new background track, use the **Change theme** option in the playback menu;  117). To end playback and return to shooting mode, press the shutter-release button halfway.



 button



Deleting Motion Snapshots

To delete the current Motion Snapshot, press . A confirmation dialog will be displayed; press  again to delete the photo and movie and return to playback, or press  to exit without deleting the file. *Note that once deleted, Motion Snapshots can not be recovered.*

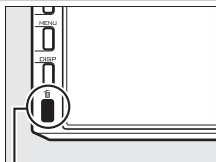

 button

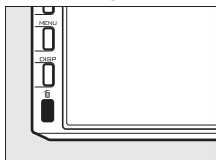







More on Photography

Single-Frame, Continuous, Self-Timer, and Remote Control Modes

Pressing ◀ (📷) on the multi selector displays a choice of shutter-release modes for still photography:

	Single frame: The camera takes pictures one at a time.
	Continuous: The camera takes photographs while the shutter-release button is pressed. The rate can be selected using the Continuous option in the shooting menu (📖 125).
	Self-timer: Delayed shutter release (📖 65).
	Remote control: The shutter is using a remote control (📖 65).

Continuous Mode

To take pictures in continuous mode:

1 Display release mode options.

Press ◀ (📷) to display release mode options.



2 Select .

Highlight  and press (OK).

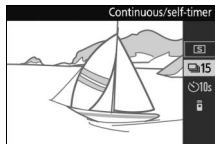

3 Compose the shot and start shooting.

The camera takes pictures while the shutter-release button is held all the way down.



✔ Continuous Mode

The **Continuous** option in the shooting menu offers a choice of 5, 15, 30, and 60 fps (☐ 125). Frame rates of 15, 30, and 60 fps use an electronic shutter; except when **On** is selected for **Silent photography** (☐ 125), a mechanical shutter is used at a frame rate of 5 fps. The built-in flash can be used when **5 fps** is selected, but only one picture will be taken each time the shutter-release button is pressed; at settings of 15, 30, and 60 fps, the built-in flash will not fire. At 15 fps, the maximum number of shots that can be taken in a single burst is about 45, while at 30 and 60 fps the maximum is about 40. For more information, see page 186.

While photographs are being recorded to the memory card, the memory card access lamp will light. Depending on shooting conditions and memory card write speed, recording may take up to about a minute. If the battery is exhausted before all photographs are recorded, the shutter release will be disabled and the remaining images transferred to the memory card.

Continuous shooting is not available in best moment capture, advanced movie, or Motion Snapshot mode, when live image control is used in auto mode (☐ 28), or when **On** is selected for **HDR** in the shooting menu (☐ 145).

✔ Buffer Size

The camera is equipped with a memory buffer for temporary storage, allowing shooting to continue while photographs are being saved to the memory card. Up to 100 photographs can be taken in succession; note, however, that the frame rate will drop or shooting will pause when the buffer is full.

The approximate number of images that can be stored in the memory buffer at current settings is displayed while the shutter-release button is pressed halfway (this number is an approximation only and varies with shooting conditions). The illustration shows the display when space remains in the buffer for about 35 pictures.

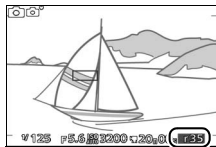

Self-Timer and Remote Control Modes

The self-timer and optional ML-L3 remote control (📖 170) can be used to reduce camera shake or for self-portraits.

🔍 Before Using the ML-L3 Remote Control

Before using the remote control for the first time, remove the clear plastic battery-insulator sheet.

1 Display release mode options.

Press ◀ (📷) to display release mode options.



2 Select the desired option.

Use the multi selector to highlight the desired option and press (OK).

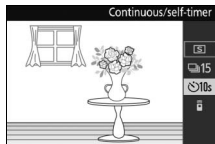

3 Mount the camera on a tripod.

Mount the camera on a tripod or place the camera on a stable, level surface.



4 Frame the photograph and shoot.

Self-timer mode: Press the shutter-release button halfway to focus, and then press the button the rest of the way down. The self-timer lamp will start to flash and a beep will begin to sound. Two seconds before the photo is taken, the lamp will stop flashing and the beeping will become more rapid.

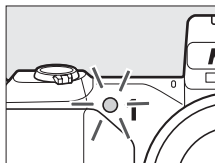

Remote control mode: From a distance of 5 m (16 ft) or less, aim the ML-L3 at the infrared receiver on the front of the camera (2) and press the ML-L3 shutter-release button. If **2 s delay** is selected for **Remote control** in the setup menu (163), the self-timer lamp will light for about two seconds before the shutter is released. If **Quick response** is selected, the self-timer lamp will flash after the shutter has been released.

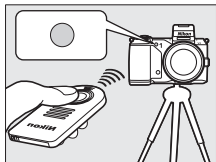

Note that the timer may not start or a photograph may not be taken if the camera is unable to focus or in other situations in which the shutter can not be released. Turning the camera off cancels self-timer and remote control modes. Remote control mode is cancelled automatically if no operations are performed for about ten minutes after the mode is selected in Step 2.



Movie Mode

In self-timer mode, start and stop the timer by pressing the movie-record button instead of the shutter-release button. In remote control mode, the ML-L3 shutter-release button functions as the movie-record button for advanced movie mode (□ 49).

Using a Flash

When using the built-in flash, press the  button to raise the flash before shooting. Shooting will be interrupted if the flash is raised while the self-timer or delayed-remote timer is counting down.

In remote control mode, the flash starts charging while the camera is waiting for the signal from the remote. The camera will only respond to the shutter-release button on the remote control when the flash is charged. If red-eye reduction (□ 69) is used when **Quick response** is selected for **Remote control** in the setup menu (□ 163), the shutter will be released about 1 second after the red-eye reduction lamp lights. If **2 s delay** is selected, there will be about a 2 second delay after the shutter-release button on the remote control is pressed; the red-eye reduction lamp will then light for about 1 second before the shutter is released.

See Also

For information on choosing how long the camera will wait for a signal from the remote, see page 163. See page 162 for information on choosing the shutter-release delay in self-timer mode.



Exposure Compensation

Exposure compensation is used to alter exposure from the value suggested by the camera, making pictures brighter or darker.



-1 EV



No compensation



+1 EV

1 Display exposure compensation options.

Press **▶** (**☒**) to display exposure compensation options.



2 Choose a value.

Use the multi selector to choose from values between -3 EV (underexposure) and $+3$ EV (overexposure) in increments of $\frac{1}{3}$ EV. In general, positive values make the image brighter while negative values make it darker.

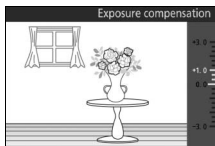

Normal exposure can be restored by setting exposure compensation to ± 0 . Except in auto mode, exposure compensation is not reset when the camera is turned off.



Exposure Compensation

Exposure compensation is most effective when used with center-weighted or spot metering ([☐ 128](#)).

Using a Flash





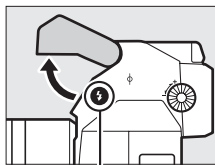

When used with a flash, exposure compensation affects both background exposure and flash level.

The Built-in Flash

To use the flash, raise it by pressing the  button. Charging begins when the flash is raised; once charging is complete, a flash-ready indicator () will be displayed when the shutter-release button is pressed halfway. The following flash modes are available; choose a flash mode as described on the following page.



 button

	Fill flash: The flash fires with every shot. Use when the subject is poorly lit or with back-lit subjects to “fill in” (illuminate) shadows.
	Red-eye reduction: The red-eye reduction lamp lights before the flash fires, reducing “red-eye” caused by light reflecting from your subject’s retinas.
	Red-eye reduction + slow sync: Combines red-eye reduction with slow shutter speeds to capture background details at night or under low light. Use for portraits taken against a backdrop of night scenery.
	Fill flash + slow sync: Combines fill flash with slow shutter speeds to capture details of poorly-lit backgrounds.
	Rear curtain + slow sync: Combines rear-curtain sync (see below) with slow shutter speeds to capture poorly-lit background details.
	Rear-curtain sync: While in other modes the flash fires as the shutter opens, in rear-curtain sync the flash fires just before the shutter closes, creating streams of light that appear to follow moving light sources.

Lowering the Built-in Flash

To save power when the flash is not in use, press it gently downward until the latch clicks into place. *Do not use force.* Failure to observe this precaution could result in product malfunction.

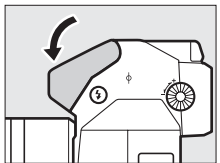

Choosing a Flash Mode

1 Display the flash mode options.

Press ▼ (⚡) to display a list of flash modes. The modes available vary with the shooting mode (📖 7).



Auto mode		P, A	
⚡	Fill flash	⚡	Fill flash
⚡👁	Red-eye reduction	⚡👁	Red-eye reduction
		⚡👁SLOW	Red-eye reduction + slow sync
		⚡SLOW	Fill flash + slow sync
		⚡SLOW REAR	Rear curtain + slow sync

S, M	
⚡	Fill flash
⚡👁	Red-eye reduction
⚡REAR	Rear-curtain sync

2 Select a flash mode.

Use the multi selector to highlight a flash mode (📖 69) and press OK to select.

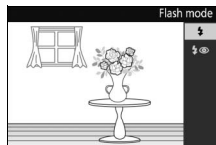

Using the Built-in Flash

The built-in flash can be used in auto and P, S, A, and M modes only; note, however, that the flash can not be used with live image control (□ 28) and will not fire when **On** is selected for **HDR** in the shooting menu (□ 145), or in □ mode (□ 63) when a frame rate of 15, 30, or 60 fps is selected for **Continuous** in the shooting menu (□ 125). If the flash is fired multiple times in quick succession, the flash and shutter may be temporarily disabled to protect the flash. Shooting can be resumed after a brief pause.

Objects close to the camera may be overexposed in photographs taken with the flash at high ISO sensitivities.

To avoid vignetting, remove lens hoods and shoot at ranges of at least 0.6 m (2 ft). Some lenses may cause vignetting at greater distances or obstruct the red-eye reduction lamp, interfering with red-eye reduction. The following illustrations show the effect of vignetting caused by shadows cast by the lens when the built-in flash is used.

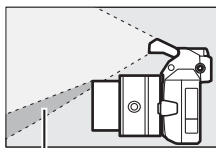

Shadow

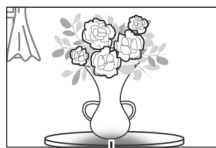

Shadow

Aperture, Sensitivity, and Flash Range

Flash range varies with sensitivity (ISO equivalency) and aperture. With the standard zoom lens at maximum aperture and ISO sensitivity set to ISO 160 to 6400, the range is approximately 0.6 m–7.0 m (2 ft–23 ft) when the lens is zoomed all the way out, 0.6 m–4.2 m (2 ft–13.8 ft) at maximum zoom.

See Also

See page 157 for information on flash control, or page 158 for information on adjusting flash level.



Optional Flash Units

In still image mode, optional flash units for Nikon 1 cameras can be used for lighting effects such as bounce-flash photography or, when an optional SB-N5 flash unit is attached, to provide capture illumination in best moment capture and Motion Snapshot modes. The built-in flash does not fire when an optional flash unit is attached.

In the instructions that follow, the optional SB-N5 flash unit is used for illustrative purposes.

Attaching Flash Units

Mount optional flash units on the camera multi accessory port.

1 Remove the multi accessory port cover.

Remove the cover as shown at right. Keep the cover in a safe place and replace it when the port is not in use.

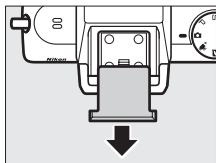

2 Attach the flash unit.

Turn the camera off and mount the flash unit on the multi accessory port as described in the manual provided with the flash unit.

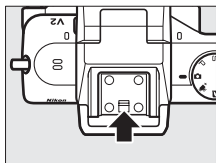

Supported Flash Units

The camera supports only flash units designated for use with Nikon 1 cameras.

Taking Pictures

Follow the steps below to take pictures with the flash.

1 Turn the camera and flash unit on.

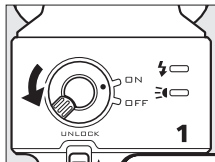

2 Choose a flash mode.

Choose a flash mode as described on page 70.

3 Position the flash head.

Rotate the flash head so that it points directly ahead.

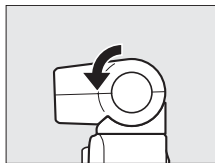

4 Take pictures.

Before shooting, confirm that the flash status indicator on the rear of the flash unit is lit and that the flash-ready indicator (⚡) appears in the camera display. To take pictures without the flash, turn the flash unit off.

Flash status indicator

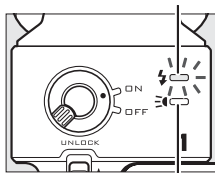

*Capture-illuminator
status indicator*

See Also

See page 157 for information on flash control, or page 158 for information on adjusting flash level.



■ Bounce Lighting

Light from the flash can be “bounced” (reflected) from a ceiling or wall, diffusing the light from the flash to make shadows less harsh and reduce glare from hair, skin, clothing and foreground objects.

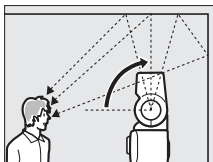

Flash head rotated upward 90°
(bounce lighting)

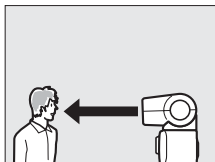

Flash pointed directly ahead
(normal lighting)

■ Bounce Lighting

If possible, bounce flash lighting from a reflective white or near-white surface; light reflected from other surfaces may change the colors in the photograph. If no suitable surface can be found nearby, a piece of white paper (A4 or letter sized) can be used instead, but be sure to check the results in the camera display.

■ The Capture Illuminator

The optional SB-N5 flash unit offers a capture illuminator that lights to illuminate subjects in best moment capture and Motion Snapshot modes (41, 59). In Smart Photo Selector and Motion Snapshot modes, the illuminator will light for about 6 seconds during buffering, illuminating subjects about 1 m (3.3 ft) from the camera. In slow view, the illuminator will light for about 1.3 seconds, starting when the shutter-release button is pressed halfway. Before shooting, confirm that the capture-illuminator status indicator is lit. The indicator lights during buffering.



Optional Flash Units

Detailed instructions may be found in the manual provided with the flash unit. Optional flash units can be used in auto and P, S, A, and M modes only; note, however, that the flash can not be used with live image control (□ 28) and will not fire when **On** is selected for **HDR** in the shooting menu (□ 145), or in □ mode (□ 63) when a frame rate of 15, 30, or 60 fps is selected for **Continuous** in the shooting menu (□ 125).

The Flash/Capture-Illuminator Status Indicators

If the flash status or capture-illuminator status indicator on the rear of the SB-N5 flashes, one of the following errors may have occurred:

Display	Description
The flash status indicator flashes for about 3 seconds after a photograph is taken.	The flash has fired at full power and the photograph may be underexposed. Try reducing the distance to the subject or increasing ISO sensitivity (□ 135).
The flash or capture status indicator flashes once a second.	Continuous use has caused the temperature of the flash unit to rise and the unit has been disabled to protect the flash. Turn the unit off and wait for it to cool.
The flash and capture status indicators flash once every 2 seconds.	A data transfer error has occurred. Check that the flash unit is correctly attached.
The flash status indicator flashes 8 times a second.	An error has occurred in the unit's internal circuitry. Turn the camera off, remove the flash unit, and take the camera and flash unit to a Nikon-authorized service center for consultation.



The GP-N100 GPS Unit

GP-N100 GPS units (available separately) can be used to record information on your current position when pictures are taken. This information can be viewed on a computer using ViewNX 2 (supplied) or Capture NX 2 (available separately;  171). ViewNX 2 can be installed from the supplied ViewNX 2/ Short Movie Creator CD.

Attaching the GP-N100

The GP-N100 attaches to the camera multi accessory port.

1 Remove the multi accessory port cover.

Remove the cover as shown at right. Keep the cover in a safe place and replace it when the port is not in use.

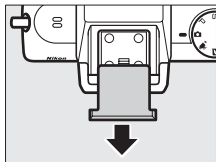

2 Attach the GP-N100.

Turn the camera off and mount the GP-N100 on the multi accessory port as described in the manual provided with the GPS unit.

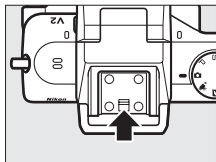

Setup Menu Options

The **GPS** item in the setup menu contains the following options. To display GPS options, press **MENU** and select **GPS** in the setup menu.

- **Auto power off:** Choose whether the displays turn off automatically when the GP-N100 is attached.

Enable	Camera displays turn off automatically if no operations are performed for the time selected for Auto power off in the setup menu (☞ 162). This reduces the drain on the battery.
Disable	The displays do not turn off automatically while the GP-N100 is attached.



- **Position:** This item is only available if the GP-N100 is currently receiving GPS data, when it displays the current latitude, longitude, altitude, Coordinated Universal Time (UTC), and expiry date for Assisted GPS data (☞ 78) as reported by the GP-N100.
- **Use GPS to set clock:** Select **Yes** to synchronize the camera clock with the time reported by the GPS device.





Coordinated Universal Time (UTC)

UTC data is provided by the GPS device and is independent of the camera clock.



Connection Status

Connection status is shown by the  icon in the camera display ( 4) and the LED on the GP-N100:

 GPS icon	LED	Description
 (flashes)	Flashes (red)	The GPS unit is searching for a signal. Pictures taken while the  icon is flashing do not include GPS data.
 (static)	Flashes (green)	The unit is receiving signals from three GPS satellites. GPS data will be recorded with photographs.
 (static)	On (green)	The unit is receiving signals from four or more GPS satellites. More precise GPS data will be recorded with photographs.

GPS data are only recorded while the GP-N100 is receiving signals from at least three satellites. If no signal is received for over two seconds, the  icon will clear from the camera display and no GPS data will be recorded.

Assisted GPS

When connected to a computer using its supplied USB cable, the GP-N100 can use resources provided by Nikon servers to reduce the time needed to acquire GPS data (GPS data can still be acquired without these resources, although the time needed to do may increase). This method of determining position using supplementary information stored in a file supplied by a network is known as "Assisted GPS" (A-GPS or aGPS). To connect to Nikon servers and receive Assisted GPS files, the GP-N100 uses GP-N100 Utility software, available for download from the following website:

<http://nikonimglib.com/gpn100u/>

For information on using GP-N100 Utility, see the above website or online help. The Assisted GPS file provided by the servers is valid for two weeks, after which time it can no longer be used to assist global positioning. Use GP-N100 Utility regularly to keep the GP-N100 up to date.

The WU-1b Wireless Mobile Adapter

Attach an optional WU-1b wireless mobile adapter to the camera USB connector to copy images to, or control the camera from, smartphone or tablet devices running the Wireless Mobile Adapter Utility app.

1 Connect the WU-1b.

After removing the rubber cap from the WU-1b USB connector, turn the camera off and attach the adapter to the camera USB connector.

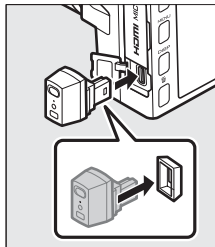

2 Activate the adapter.

Select **Wireless mobile adapter** in the setup menu (📖 159). A confirmation dialog will be displayed; select **Yes** to activate the WU-1b, allowing wireless connection to smart devices, or **No** to deactivate the WU-1b and prevent wireless connection.

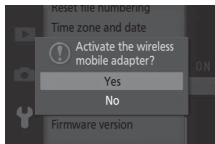

Using the WU-1b for the First Time

After connecting the WU-1b, you will need to adjust smart device wireless settings. See the WU-1b manual for more information.

3 Launch the Wireless Mobile Adapter Utility.

Launch the Wireless Mobile Adapter Utility on the smart device.

4 Take pictures remotely.

Once a wireless connection is established, the smart device will display the view through the camera lens; the camera will display a message stating that a wireless connection is active.

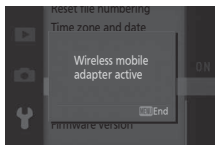

Wireless Networks

Camera settings can not be adjusted while the camera is connected to a wireless network. To end the connection, press the MENU button.

The Wireless Mobile Adapter Utility

The Wireless Mobile Adapter Utility is available from Google Play and the App Store. System requirements and Information on installation, wireless connections and use may be found in the Wireless Mobile Adapter Utility manual available in pdf format from the following URL: <http://nikonimglib.com/ManDL/WMAU/>



More on Playback

Photo Information

Photo information is superimposed on images displayed in full-frame playback (☞ 30). Press the **DISP** button to cycle through simple photo information, detailed photo information (☞ 82), and no photo information.

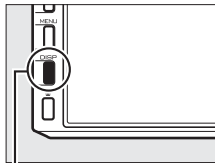

DISP button

Simple Photo Information

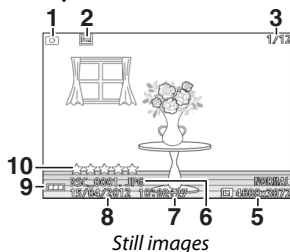

Still images

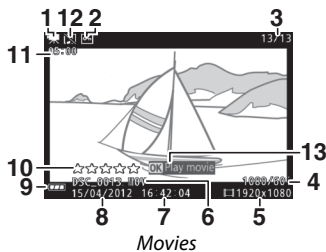

Movies

1 Shooting mode	7	6 File name	124
2 Protect status	112	7 Time of recording	19, 165
3 Frame number/total number of images		8 Date of recording	19, 165
4 Image quality	123	9 Battery indicator	21
Frame rate	125	10 Rating	88
5 Image size	123	11 Movie length	56
Frame size	126	12 Audio recording indicator	147
		13 On-screen guide (for movies)	56

Thumbnail Playback

Press **DISP** to view or hide photo info when thumbnails are displayed (☞ 84).

■ Detailed Photo Information

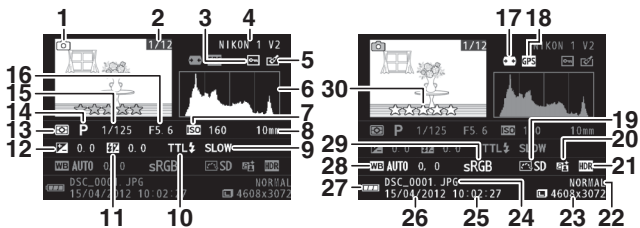

Still images

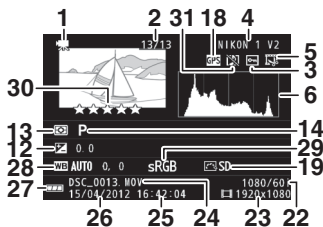

Movies

1 Shooting mode	7	17 Auto distortion control.....	142
2 Frame number/total number of images		18 GPS data indicator	76
3 Protect status.....	112	19 Picture Control	136
4 Camera name		20 Active D-Lighting indicator	144
5 Retouch indicator	113, 114, 115	21 HDR	145
Movie edit indicator	116	22 Image quality.....	123
6 Histogram showing distribution of tones in image	83	Frame rate	125, 126
7 ISO sensitivity	135	23 Image size.....	123
8 Focal length	201	Frame size.....	125, 126
9 Flash mode.....	69	24 File name	124
10 Flash control.....	157	25 Time of recording	19, 165
11 Flash compensation.....	158	26 Date of recording.....	19, 165
12 Exposure compensation	68	27 Battery indicator	21
13 Metering	128	28 White balance.....	130
14 Exposure mode	122	White balance fine-tuning	131
15 Shutter speed	35, 37	29 Color space.....	143
16 Aperture.....	36, 37	30 Rating	88
		31 Audio recording indicator	147

Histograms (📖 82)

Camera histograms are intended only as a guide and may differ from those in imaging applications. Sample histograms are shown below:

- **If brightness varies evenly across the image**, the distribution of tones will be relatively even.



- **If the image is dark**, tone distribution will be shifted to the left.



- **If the image is bright**, tone distribution will be shifted to the right.



Exposure compensation shifts the distribution of tones to the right when raised, to the left when lowered. Histograms can give you a rough idea of overall exposure when bright ambient lighting makes it difficult to see the display in the monitor.



Thumbnail Playback

To view pictures in “contact sheets” of 4, 9, or 72 images, rotate the command dial left when a picture is displayed full frame.

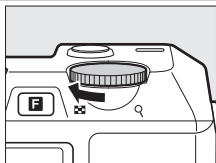

Command dial



The following operations can be performed:

To	Use	Description
Display more images		Rotate left to increase the number of images displayed, right to decrease. Rotate left when 72 images are displayed to view images taken on selected dates (85). Rotate right when 4 images are displayed to view the highlighted image full frame.
Display fewer images		
Highlight images	 	Use the multi selector to highlight images. You can delete (87) or rate (88) the highlighted image or zoom in for a closer look (86).
View highlighted image		Press to view the highlighted image full frame.
Delete highlighted image		See page 87.
Rate highlighted image		See page 88.

Calendar Playback

To view pictures taken on a selected date, rotate the command dial left when 72 pictures are displayed (📖 84).

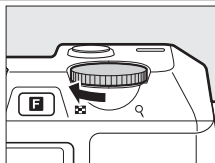

Command dial



The following operations can be performed:

To	Use	Description
Highlight date		Use multi selector to highlight date.
View pictures taken on highlighted date		Press to view the first picture taken on the highlighted date.
Delete pictures taken on highlighted date		Press to delete all pictures taken on the highlighted date.
Exit to thumbnail display		Rotate right to return to 72-frame display.





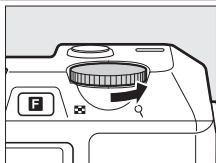

Playback Zoom

To zoom in on a photograph, display it full frame and rotate the command dial right. Playback zoom is not available with movies or Motion Snapshots.



Command dial

The following operations can be performed:

To	Use	Description
Zoom in or out		Rotate the command dial right to zoom in, left to zoom out. Whenever you zoom in or out, a navigation window will appear with the area currently visible in the display indicated by a yellow border.
View other areas of image		Press ▲, ►, ▼, or ◀ to scroll the image.
View faces		Faces (up to five) detected during face priority are indicated by white borders in the navigation window. Rotate the multi selector to view other faces.
Exit zoom		Return to full-frame playback.



Deleting Pictures

Pictures can be deleted from the memory card as described below. Note that once deleted, pictures can not be recovered; protected images, however, will not be deleted.

Deleting the Current Picture

To delete the picture currently displayed in full-frame playback or selected in the thumbnail list, press . A confirmation dialog will be displayed; press again to delete the picture and return to playback, or press to exit without deleting the picture.

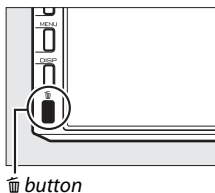

The Playback Menu

To delete multiple images, press the MENU button, select **Delete** in the playback menu, and choose from the options below. A confirmation dialog will be displayed; select **Yes** to delete the images (note that some time may be required if a large number of images is selected).

Delete selected images	Highlight images and press or to select or deselect (111). Press to exit when the selection is complete.
Select images by date	Highlight dates and press to select or deselect. To view the pictures taken on the highlighted date, rotate the command dial right; rotate the dial left to return to the date list. Press to delete all pictures taken on the selected dates.
Delete all images	Delete all pictures on the memory card.



Rating Pictures

Rate pictures or mark them as candidates for later deletion. Rating is not available with protected images.

1 Select a picture.

Display a picture in full-frame playback or highlight it in the thumbnail list.

2 Press **F**.

Press **F** and rotate the multi selector to choose from ratings of zero to five stars, or select **✕** to mark the picture as a candidate for later deletion.

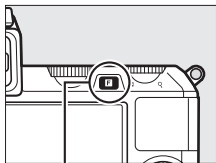

F button

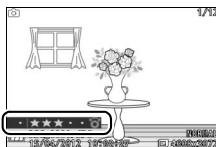

Slide Shows

To view a slide show of the pictures on the memory card, press the **MENU** button, select **Slide show** in the playback menu, and follow the steps below.

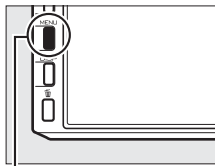

MENU button

1 Select the type of image used in the show.

Highlight the desired option and press .

All images	Display all the images on the memory card.
Still images	Display still images only.
Movies	Display movies only.
Motion Snapshot	Display only the movie portion of Motion Snapshots. The associated photographs are not displayed.
Select images by date	Display only images recorded on a selected date. A calendar will be displayed; use the multi-selector to highlight a date.



2 Adjust display times and choose a background track.

Adjust the following options:





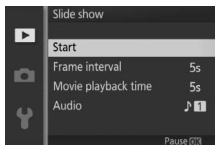

Frame interval	Choose how long each still image is displayed.
Movie playback time	Choose how much of each movie is played back before the next slide is displayed. Choose Same as frame interval to display the next slide after the time selected for Frame interval , No limit to play back the entire movie before displaying the next slide.
Audio	Mute audio playback or choose a slide show background track. Select Movie sound tracks to play only audio recorded with movies; in this case, no sound is played for still images or Motion Snapshots.

3 Select Start.

Highlight **Start** and press  to start the slide show.



The following operations can be performed while a slide show is in progress:

To	Use	Description
Skip back/skip ahead		Press  to return to the previous frame,  to skip to the next frame.
Pause/resume		Pause the show. Press again to resume.
Adjust volume		Rotate the command dial to adjust volume.
Exit to playback mode		End the show and return to playback mode.

The options shown at right are displayed when the show ends. Select **Resume** to restart or **Exit** to exit to the playback menu.

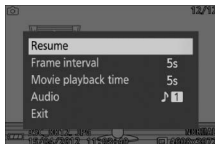

Connections

Installing the Supplied Software

Install the supplied software to copy pictures to your computer for viewing and editing pictures and creating short movies. Before installing the software, confirm that your system meets the requirements on page 93.

1 Start the computer and insert the installer ViewNX 2/ Short Movie Creator CD.

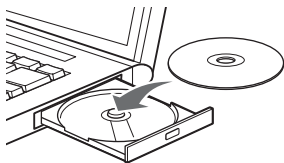

Windows

Mac OS



Nikon Software

Double-click icon
on desktop



Welcome

Double-click
Welcome icon

2 Select a language.

If the desired language is not available, click **Region Selection** to choose a different region and then choose the desired language (region selection is not available in the European release).

① Select region (if required)



② Select language

③ Click **Next**

3 Start the installer.

Click **Install** and follow the on-screen instructions.



4 Exit the installer.

Click **Yes** (Windows) or **OK** (Mac OS) when installation is complete.



Click Yes



Click OK

The following software is installed:

- ViewNX 2
- Short Movie Creator
- Apple QuickTime (Windows only)

5 Remove the installer CD from the CD-ROM drive.

Supplied Software

Be sure to update to the latest versions of the supplied software. Nikon Message Center 2 will periodically check for updates while the computer is connected to the Internet.

System Requirements

The system requirements for ViewNX 2 are:

Windows	
CPU	<ul style="list-style-type: none">• Photos/JPEG movies: Intel Celeron, Pentium 4, or Core series, 1.6 GHz or better• H.264 movies (playback): 3.0 GHz Pentium D or better• H.264 movies (editing): 2.6 GHz Core 2 Duo or better
OS	Pre-installed versions of Windows 7 Home Basic/Home Premium/Professional/Enterprise/Ultimate (64- and 32-bit editions; Service Pack 1), Windows Vista Home Basic/Home Premium/Business/Enterprise/Ultimate (64- and 32-bit editions; Service Pack 2), or Windows XP Home Edition/Professional (32-bit editions only; Service Pack 3)
RAM	<ul style="list-style-type: none">• Windows 7/Windows Vista: 1 GB or more (2 GB or more recommended)• Windows XP: 512 MB or more (2 GB or more recommended)
Hard-disk space	A minimum of 500 MB available on the startup disk (1 GB or more recommended)
Monitor	<ul style="list-style-type: none">• Resolution: 1024 × 768 pixels (XGA) or more (1280 × 1024 pixels/SXGA or more recommended)• Color: 24-bit color (True Color) or more

Mac OS	
CPU	<ul style="list-style-type: none">• Photos/JPEG movies: Intel Core or Xeon series• H.264 movies (playback): 2 GHz Core Duo or better• H.264 movies (editing): 2.6 GHz Core 2 Duo or better
OS	Mac OS X version 10.6.8, 10.7.5 or 10.8.2
RAM	512 MB or more (2 GB or more recommended)
Hard-disk space	A minimum of 500 MB available on the startup disk (1 GB or more recommended)
Monitor	<ul style="list-style-type: none">• Resolution: 1024 × 768 pixels (XGA) or more (1280 × 1024 pixels/SXGA or more recommended)• Color: 24-bit color (millions of colors) or more

Motion Snapshots

ViewNX 2 is required to view Motion Snapshots saved using the **File format > NMS files** option in the shooting menu (☰ 128).



The system requirements for Short Movie Creator are:

Windows	
CPU	2 GHz intel Core 2 Duo or better
OS	Pre-installed versions of Windows 7 Home Basic/Home Premium/Professional/Enterprise/Ultimate (Service Pack 1), Windows Vista Home Basic/Home Premium/Business/Enterprise/Ultimate (Service Pack 2), or Windows XP Home Edition/Professional (Service Pack 3). All installed programs run as 32-bit applications in 64-bit editions of Windows 7 and Windows Vista.
RAM	1.5 GB or more with at least 128 MB of video RAM (2 GB or more with at least 256 MB of video RAM recommended for creating HD movies)
Hard-disk space	A minimum of 500 MB available on the startup disk (1 GB or more recommended)
Monitor	<ul style="list-style-type: none">• Resolution: 1024 × 768 pixels (XGA) or more• Color: 32-bit color (True Color) or more
Other	DirectX 9 or later and OpenGL 1.4 or later

Mac OS	
CPU	2 GHz intel Core 2 Duo or better
OS	Mac OS X version 10.6.8, 10.7.5 or 10.8.2
RAM	1 GB or more
Hard-disk space	A minimum of 500 MB available on the startup disk (1 GB or more recommended)
Monitor	<ul style="list-style-type: none">• Resolution: 1024 × 768 pixels (XGA) or more• Color: 24-bit color (millions of colors) or more

If your system does not meet the above requirements, only ViewNX 2 will be installed (☞ 93).

Supported Operating Systems

See the websites listed on page xvii for the latest information on supported operating systems.

Viewing and Editing Pictures on a Computer

Transferring Pictures

1 Choose how pictures will be copied to the computer.

Choose one of the following methods:

- **Direct USB connection:** Turn the camera off and ensure that the memory card is inserted in the camera. Connect the camera to the computer using the supplied USB cable (do not use force or insert the connectors at an angle) and then turn the camera on.

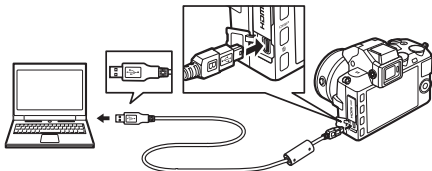

- **SD card slot:** If your computer is equipped with an SD card slot, the card can be inserted directly in the slot.
- **SD card reader:** Connect a card reader (available separately from third-party suppliers) to the computer and insert the memory card.

2 Start the Nikon Transfer 2 component of ViewNX 2.

If a message is displayed prompting you to choose a program, select Nikon Transfer 2.

Windows 7

If the following dialog is displayed, select Nikon Transfer 2 as described below.

- 1 Under **Import pictures and videos**, click **Change program**. A program selection dialog will be displayed; select **Import File using Nikon Transfer 2** and click **OK**.



- 2 Double-click **Import file**.

3 Click Start Transfer.

At default settings, all the pictures on the memory card will be copied to the computer.



Click **Start Transfer**

4 Terminate the connection.

If the camera is connected to the computer, turn the camera off and disconnect the USB cable. If you are using a card reader or card slot, choose the appropriate option in the computer operating system to eject the removable disk corresponding to the memory card and then remove the card from the card reader or card slot.

Viewing Pictures

Pictures are displayed in ViewNX 2 when transfer is complete.

Starting ViewNX 2 Manually

- **Windows:** Double-click the ViewNX 2 shortcut on the desktop.
- **Mac OS:** Click the ViewNX 2 icon in the Dock.

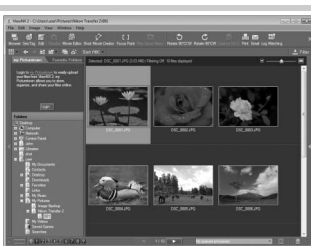

■ ■ Retouching Photographs

To crop pictures and perform such tasks as adjusting sharpness and tone levels, click the **Edit** button in the toolbar.



■ ■ Creating Short Movies

Use the Short Movie Creator to create short movies combining photos, music, Motion Snapshots, and movie footage (📖 98).



■ ■ Printing Pictures

Click the **Print** button in the toolbar. A dialog will be displayed, allowing you to print pictures on a printer connected to the computer.

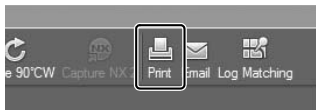

■ ■ Viewing Places

If the selected image contains GPS data recorded using an optional GP-N100 GPS unit (📖 76), click the **Geo Tag** button in the toolbar to view a map showing where the picture was taken (Internet connection required).



🔍 For More Information

Consult online help for more information on using ViewNX 2.

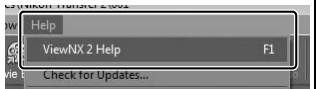

Creating Short Movies

Use the supplied Short Movie Creator software to create movies combining photographs with Motion Snapshots, movies, and music.

1 Transfer pictures.

Transfer pictures as described on page 95.

2 Select components.

Select pictures in ViewNX 2.

3 Start Short Movie Creator.

Click the **Short Movie Creator** button in ViewNX 2.

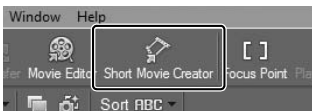

The images selected in Step 2 will be displayed in the Short Movie Creator “Components” panel; if desired, additional pictures can be dragged into the “Components” panel from ViewNX 2 and re-ordered using drag and drop. In the case of photos taken with the Smart Photo Selector, only the best shot will be displayed.

“Components” panel



The photo and movie components of Motion Snapshots appear as separate files.

4 Select a style and background track.

Select a style in the “Styles” panel and a background track in the “Music” panel. To preview the movie, click .

5 Save the movie.

Click **Create Movie**. The dialog shown at right will be displayed; select one of the following options and click **Create**.

- **Save file:** Save the movie to a folder on the computer.
- **Save to Camera (memory card):** Save the movie to a memory card so that it can later be played back on the camera. To use this option, you will first need to insert a memory card that has been formatted in the camera (161) into a card reader or card slot.

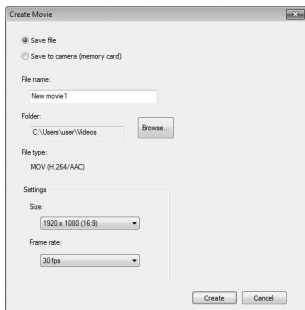

Starting Short Movie Creator

If ViewNX 2 is not running, you can start Short Movie Creator by double-clicking the **Short Movie Creator** icon on the desktop (Windows) or clicking the **Short Movie Creator** icon in the Dock (Mac OS).



Viewing Short Movies on Other Devices

Movies saved to a memory card using the **Save to Camera (memory card)** option in Short Movie Creator can be viewed on the camera, or displayed on a television monitor when the camera is connected to a TV (100). Movies created in other applications or using the **Save file** option in Short Movie Creator can not be viewed on the camera.

For More Information

Consult online help for more information on using Short Movie Creator.

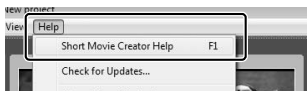

Viewing Pictures on TV

Connect the camera to a television for playback.

Connecting an HDMI Cable

Always turn the camera off before connecting or disconnecting HDMI cables. When connecting cables, do not use force or attempt to insert the connectors at an angle.

High-Definition Devices

A type C mini-pin High-Definition Multimedia Interface (HDMI) cable (available separately from third-party suppliers) can be used to connect the camera to high-definition video devices.

1 Connect the HDMI cable.

Turn the camera off and connect the HDMI cable.

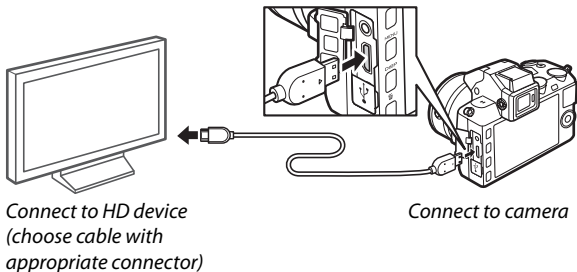

2 Tune the device to the HDMI channel.

3 Turn the camera on.

Turn the camera on; the camera monitor will remain off and the camera shooting mode display will appear on the HD device. Pictures can be played back using camera controls as described elsewhere in this manual; note that the edges of images may not be visible in the display.

Close the Connector Cover



Close the connector cover when the connectors are not in use. Foreign matter in the connectors can interfere with data transfer.

Television Playback

Volume can be adjusted using the controls on the television; adjusting volume on the camera has no effect. Use of an EH-5b AC adapter and EP-5D power connector (available separately) is recommended for extended playback.

■ ■ HDMI Device Control

To control the camera remotely from a device that supports HDMI-CEC (**H**igh-**D**efinition **M**ultimedia **I**nterface-**C**onsumer **E**lectronics **C**ontrol), select **On** for **HDMI device control** in the camera setup menu. The HDMI-CEC device will display a remote control guide and the remote control can be used in place of the following camera controls:

Camera	Remote control
▲, ▼, ◀, ▶	Up, down, left, and right buttons
	Center button
	Blue button
MENU	Red button
Slide show menu	Green button

The remote control guide can be hidden or displayed at any time by pressing the yellow button on the remote control. See the television manual for details.



Printing Photographs

Selected JPEG images can be printed on a PictBridge printer connected directly to the camera.

Connecting the Printer

Connect the camera using the supplied USB cable.

1 Turn the camera off.

2 Connect the USB cable.

Turn the printer on and connect the USB cable as shown. Do not use force or attempt to insert the connectors at an angle.

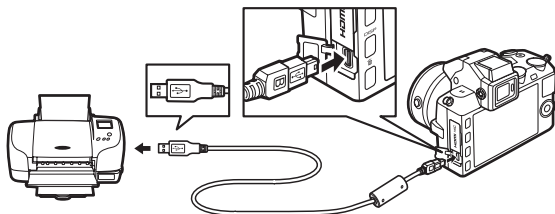

USB Hubs

Connect the camera directly to the printer; do not connect the cable via a USB hub.

3 Turn the camera on.

A welcome screen will be displayed in the monitor, followed by a PictBridge playback display.

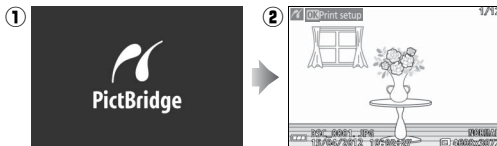

Printing Via Direct USB Connection

Be sure the EN-EL21 battery is fully charged or use an optional EH-5b AC adapter and EP-5D power connector.

Printing Pictures One at a Time

1 Select a picture.

Press ◀ or ▶ to view additional pictures. Rotate the command dial right to zoom in on the current frame (📖 86; rotate the dial left to exit zoom). To view nine pictures at a time, rotate the dial left when a picture is displayed full frame. Use the multi selector to highlight pictures, or rotate the command dial right to display the highlighted picture full frame.

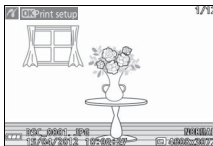

2 Adjust print options.

Press **OK** to display PictBridge print options (📖 107). Press ▲ or ▼ to highlight options and press ▶ to select.

3 Start printing.

Highlight **Start printing** and press **OK** to start printing. To cancel before all copies have been printed, press **OK** again.



Selecting Photographs for Printing

Movies and NEF (RAW) photographs (📖 123) can not be selected for printing. If Motion Snapshots are selected, only the photographs will be printed; the movie portion will not be printed. If photographs taken with the Smart Photo Selector are selected, only the best shot will be printed.



Printing Multiple Pictures

1 Display the PictBridge menu.

Press the MENU button in the PictBridge playback display (see Step 3 on page 102).

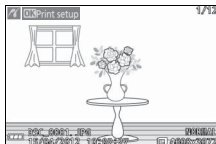

2 Choose an option.

Highlight one of the following options and press ►.

- **Select images for printing:** Select pictures for printing.
- **Select by date:** Print one copy of each picture taken on selected dates.
- **Print DPOF print order:** Print an existing print order created with the **DPOF print order** option in the playback menu (□ 108). The current print order will be displayed in Step 3.
- **Index print:** To create an index print of all JPEG pictures on the memory card, proceed to Step 4. Note that if the memory card contains more than 256 pictures, a warning will be displayed and only the first 256 images will be printed.



3 Select pictures or choose dates.

If you chose **Select images for printing** or **Print DPOF print order** in Step 2, press ◀ or ▶ or rotate the multi selector to highlight pictures. To select the current picture for printing, press ▲. The picture will be marked with a 🖨️ icon and the number of prints will be set to 1; press ▲ or ▼ to specify the number of prints (up to 99; to deselect the picture, press ▼ when the number of prints is 1). Continue until all the desired pictures have been selected.

If you chose **Select by date** in Step 2, press ▲ or ▼ to highlight dates and press ▶ to select or deselect.





Inspecting Pictures

To view pictures taken on the date highlighted in the **Select by date** date list, rotate the command dial left. Use the multi selector to highlight pictures, or rotate the dial left to return to the date list.



The picture currently highlighted in the **Select images for printing** or **Print DPOF print order** displays or in the **Select by date** thumbnail display can be inspected by pressing the command dial; the picture will be displayed full screen while the dial is pressed.



4 Adjust print options.

Press  to display PictBridge print options. Press  or  to highlight page size, border, or time stamp items and press  to display the options described on page 107; note that a warning will be displayed if the selected page size is too small for an index print.

5 Start printing.

Highlight **Start printing** and press  to start printing. To cancel before all copies have been printed, press  again.











Errors

See page 192 for information on what to do if an error occurs during printing.



PictBridge Print Options

Page size	Highlight a page size (only sizes supported by the current printer are listed) and press  to select and exit to the previous menu (to print at the default page size for the current printer, select Use printer settings).
Number of copies	This option is listed only when pictures are printed one at a time. Press  or  to choose number of copies (maximum 99), then press  to select and return to the previous menu.
Print border	This option is listed only if supported by the printer. Highlight Use printer settings (use current printer settings), Yes (print white borders), or No (no borders) and press  to select and exit to the previous menu.
Print time stamp	Highlight Use printer settings (use current printer settings), Yes (print times and dates of recording on photos), or No (no time stamp) and press  to select and exit to the previous menu.
Crop	This option is listed only when pictures are printed one at a time on a printer that supports cropping. To exit without cropping, highlight No and press  . To crop the current picture, highlight Yes and press  . A crop selection dialog will be displayed; rotate the command dial right to increase the size of the crop, left to decrease. Position the crop using the multi selector and press  . Note that print quality may drop if small crops are printed at large sizes.



Creating a DPOF Print Order: Print Set

The **DPOF print order** option is used to create digital “print orders” for PictBridge-compatible printers and devices that support DPOF. Press the MENU button, select **DPOF print order** in the playback menu, and choose from the following options:

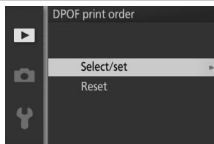

Select/ set	Press ◀ or ▶ or rotate the multi selector to highlight pictures (111). To select the current picture for printing, press ▲. The picture will be marked with a 📄 icon and the number of prints will be set to 1; press ▲ or ▼ to specify the number of prints (up to 99; to deselect the picture, press ▼ when the number of prints is 1). When the selection is complete, press Ⓞ to display printing options. Highlight Print shooting info (print the shutter speed and aperture on all pictures in the print order) or Print date (print the date of recording on all pictures in the print order) and press ▶ to select or deselect, and then press Ⓞ to complete the print order.	A screenshot of a camera's menu system. The title is 'DPOF print order'. Below it is 'Select/set'. There are two options: 'Print shooting info' (with a checkbox) and 'Print date' (with a checkbox). At the bottom right, there are 'Set', 'OK', and 'OK' options.
Reset	Remove all pictures from the print order.	

☑ DPOF Print Order

DPOF date and shooting info options are not supported when printing via direct USB connection; to print the date of recording on photographs in the current print order, use the PictBridge **Print time stamp** option (107).

The **DPOF print order** option can not be used if there is not enough space on the memory card to store the print order. For restrictions on the types of images that can be selected for printing, see page 103.

Print orders may not print correctly if images are deleted using a computer or other device after the print order is created.

The Playback Menu

To display the playback menu, press MENU and select the playback menu tab (▶).

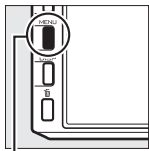

MENU button

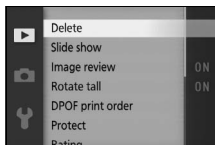
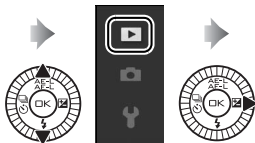

The playback menu contains the following options:

Option	Description	Default	
Delete	Delete multiple images.	—	87
Slide show	View movies and photos in a slide show.	Image type: All images Frame interval: 5 s Movie playback time: Same as frame interval Audio: Background track 1	89
Image review	Choose whether pictures are displayed after shooting.	On	112
Rotate tall	Rotate “tall” (portrait-orientation) pictures for display during playback.	On	112
DPOF print order	Create digital “print orders”.	—	108
Protect	Protect pictures from accidental deletion.	—	112
Rating	Rate pictures.	—	112
D-Lighting	Brighten shadows in dark or back-lit photos, creating a retouched copy that is saved separately from the unmodified original.	—	113
Resize	Create small copies of selected pictures.	Choose size: 1.1 M	114

Option	Description	Default	
Crop	Create cropped copies of selected pictures.	—	115
Edit movie	Create copies of movies from which unwanted footage has been trimmed.	—	116
Change theme	Change the themes for existing Motion Snapshots.	—	117

Playback

The camera may be unable to display or retouch images that were created or have been edited with other devices.

Image Quality

Copies created from JPEG photos are the same quality as the original, while copies created from NEF (RAW) photos are saved as fine-quality JPEG images.



Selecting Multiple Images

Choosing the options listed below displays an image selection dialog. Press ◀ or ▶ or rotate the multi selector to highlight pictures (only pictures to which the operation applies are available for selection).

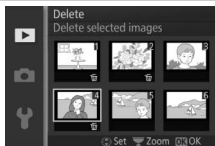

- **Delete > Delete selected images** (📖 87)
- **DPOF print order > Select/set** (📖 108)
- **Protect > Select/set** (📖 112)
- **D-Lighting** (📖 113)
- **Crop** (📖 115)
- **Change theme** (📖 117)
- **Rating** (📖 112)
- **Resize > Select images** (📖 114)
- **Edit movie** (📖 116)

🔍 Inspecting Pictures

The picture currently highlighted in the thumbnail display can be inspected by pressing the command dial; the picture will be displayed full screen while the dial is pressed.



Image Review

If **On** is selected, pictures will be displayed immediately after shooting. To view pictures when **Off** is selected, press the  button.

Rotate Tall

Choose whether to rotate “tall” (portrait-orientation) pictures for display during playback. Note that because the camera itself is already in the appropriate orientation during shooting, images are not rotated automatically during image review.

On	“Tall” (portrait-orientation) pictures are automatically rotated for display in the camera monitor. Pictures taken with Off selected for Auto image rotation (📖 166) will be displayed in “wide” (landscape) orientation.
Off	“Tall” (portrait-orientation) pictures are displayed in “wide” (landscape) orientation.

Protect

Protect selected images from accidental deletion. Note that this option does NOT protect files from deletion when the memory card is formatted (📖 161).

Select/set	Press ◀ or ▶ or rotate the multi selector to highlight pictures (📖 111) and press ▲ or ▼ to select or deselect. Press  to exit when the operation is complete.
Reset	Remove protection from all pictures.



Rating

Press ◀ or ▶ or rotate the multi selector to highlight pictures (📖 111) and press ▲ or ▼ to choose a rating (📖 88). Press  to exit when the operation is complete.

D-Lighting

Applied to selected images, D-Lighting creates copies that have been processed to brighten shadows. Use to retouch dark or backlit photographs.

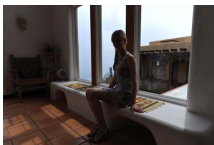

Before



After

Press ◀ or ▶ or rotate the multi selector to highlight an image (📖 111) and press Ⓚ to display the options shown at right. Press ▲ or ▼ to choose the amount of correction performed (the effect can be previewed in the display; press and hold the command dial to zoom in) and press Ⓚ to create a retouched copy.

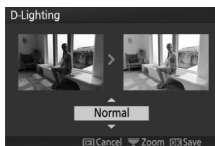

D-Lighting

Noise (randomly-spaced bright pixels, fog, or lines) may appear in copies created with **D-Lighting**. Uneven shading may be visible with some subjects.

Image Size

Copies created from JPEG photos are the same size as the original, while copies created from NEF (RAW) photos are saved as JPEG images with a size of 4608 × 3072.



Resize

Create small copies of selected photographs. Select **Choose size** and choose a size from **1280×856; 1.1 M** (1280 × 856 pixels), **960×640; 0.6 M** (960 × 640 pixels), and **640×424; 0.3 M** (640 × 424 pixels), and then choose **Select images**.

Press ◀ or ▶ or rotate the multi selector to highlight pictures (📖 111) and press ▲ or ▼ to select or deselect. When the selection is complete, press ⌘ to display a confirmation dialog and select **Yes** to save the resized copies.

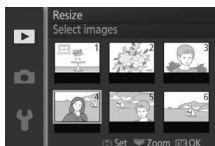

Resized Copies

Playback zoom may not be available with resized copies.



Crop

Create a cropped copy of selected photographs. Press ◀ or ▶ or rotate the multi selector to highlight a picture (📖 111) and press Ⓞ to display the image with the default crop shown in yellow. Use the controls below to choose a crop and save the copy.



To	Use	Description
Choose size		Rotate the command dial to choose the crop size.
Choose aspect ratio		Rotate the multi selector to choose between aspect ratios of 3 : 2, 4 : 3, 1 : 1, and 16 : 9.
Position crop		Press ▲, ▶, ▼, or ◀ to position the crop.
Create copy		Save the current crop as a separate file.

Cropped Copies

Playback zoom may not be available with cropped copies. The size of the copy varies with crop size and aspect ratio and appears at upper left in the crop display.

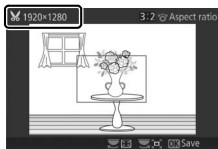

Edit Movie

Trim footage from movies to create edited copies.

1 Select **Choose start point** or **Choose end point**.

Choose from the following options:

- **Choose start point:** Trim the opening footage.
- **Choose end point:** Trim the closing footage.

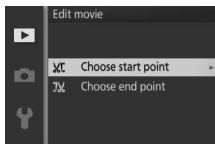

2 Select a movie.

Press ◀ or ▶ or rotate the multi selector to highlight a movie (111) and press OK to select.

3 Pause the movie on opening or closing frame.

Play the movie back, pressing OK to begin and resume playback and ▼ to pause (56; the first frame is indicated by a ⏮ icon in the display, the last frame by ⏭). Pause playback when you reach the frame that will become the new opening or closing frame.

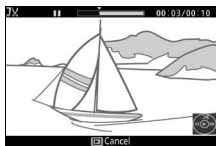

4 Delete the unwanted frames.

Press ▲ to delete all frames before (**Choose start point**) or after (**Choose end point**) the current frame.

5 Save the copy.

Highlight **Yes** and press OK to save the edited copy. If necessary, the copy can be trimmed as described above to remove additional footage.

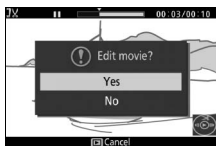

Trimming Movies

Movies must be at least two seconds long. If a copy can not be created at the current playback position, the current position will be displayed in red in Step 4 and no copy will be created. The copy will not be saved if there is insufficient space available on the memory card.

To prevent the camera from turning off unexpectedly, use a fully-charged battery when editing movies.

Change Theme

Assign existing Motion Snapshots new themes (NMS-format files only; Motion Snapshots created with **MOV file** selected for **File format** in the shooting menu can not be assigned new themes). Choose from **Beauty, Waves, Relaxation, Tenderness**, and **None**. To hear a theme, highlight it and press the DISP button; volume is controlled with the command dial.

See Also

See page 128 for information on Motion Snapshot file formats.





The Shooting Menu

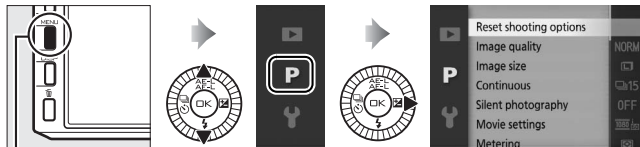

To display the shooting menu, press MENU and select the shooting menu tab (P, P, S, A, M, C, Z, or *+).



MENU button

The shooting menu contains the following options:

Option	Description	Default	
Reset shooting options	Reset shooting options to default values.	—	122
Exposure mode	Choose how the camera sets shutter speed and aperture.	Scene auto selector (Motion Snapshot mode)/ P Programmed auto (other modes)	122
Image quality	Choose a file format and compression ratio.	JPEG normal	123
Image size	Choose a size for new photos.	4608 × 3072; 14.2 M	123
Continuous	Choose the frame rate for continuous shooting (63).	15 fps	125
Silent photography	Choose whether to mute shutter and control sounds.	Off	125
Number of shots saved	Choose the number of shots selected by the Smart Photo Selector (44).	5	125
Frame rate	Choose a frame rate for slow-motion movies (53).	400 fps	125
Movie settings	Choose HD movie frame size and frame rate (49).	1080/60i	126

Option	Description	Default	
Movie before/after	Choose when the movie portion of Motion Snapshots is recorded ( 59).	1.0 s : 0.6 s	127
File format	Choose a file format for new Motion Snapshots ( 59).	NMS file	128
Metering	Choose how the camera meters exposure.	Matrix	128
White balance	Adjust settings for different types of lighting.	Auto	130
ISO sensitivity	Control the camera's sensitivity to light.	Auto (160–3200)	135
Picture Control	Choose how the camera processes pictures.	Standard	136
Custom Picture Control	Create custom Picture Controls.	—	140
Autodistortion control	Choose whether the camera corrects barrel and pincushion distortion.	Off	142
Color space	Choose a color space for new pictures.	sRGB	143
Active D-Lighting	Avoid loss of detail in highlights and shadows.	On	144
HDR	Enhance detail in highlights and shadows when photographing high-contrast scenes.	Off	145
Long exposure NR	Reduce noise in long time-exposures.	Off	146
High ISO noise reduction	Reduce noise at high ISO sensitivities.	On	146
Movie sound options	Choose sound recording options.	Microphone: Auto sensitivity (A) Wind noise reduction: On	147



Option	Description	Default	
Vibration reduction	Adjust settings for 1 NIKKOR lenses with vibration reduction.	Active/On ¹	148
Focus mode	Choose how the camera focuses.	See page 149	149
AF-area mode	Choose how the focus area is selected.	Auto-area ²	153
Face-priority	Turn face priority on or off.	On ³	156
Built-in AF assist	Control the built-in AF-assist illuminator.	On	156
Flash control	Choose a flash mode for the built-in flash and optional flash units.	TTL (Manual : Full)	157
Flash compensation	Control flash output.	0.0	158

1 Varies with lens ( 148).

2 The camera focuses on the subject in the center of the frame when **Slow motion** is selected in advanced movie mode.

3 Face detection is not available when **Slow motion** is selected in advanced movie mode.



Reset Shooting Options

Select **Yes** to reset the options in the shooting menu and other shooting settings to default values (☞ 119, 185).

Exposure Mode

The options in the exposure mode menu offer varying degrees of control over shutter speed and aperture.

 Scene auto selector	An automatic, “point-and-shoot” mode in which the camera not only chooses shutter speed and aperture but adjusts other settings to suit the subject (automatic scene selection; ☞ 26).
P Programmed auto	The camera sets shutter speed and aperture for optimal exposure (☞ 34). Recommended for snapshots and in other situations in which there is little time to adjust camera settings.
S Shutter-priority auto	You choose the shutter speed; the camera selects an aperture for best results (☞ 35). Use to freeze or blur motion.
A Aperture-priority auto	You choose the aperture; the camera selects a shutter speed for best results (☞ 36). Use to blur the background or bring both foreground and background into focus.
M Manual	You control both shutter speed and aperture (☞ 37). Set shutter speed to “Bulb” or “Time” for long time-exposures.

ISO Sensitivity (P, S, A, and M Modes)

When an “auto” option is selected for **ISO sensitivity** (☞ 135), the camera will automatically adjust sensitivity within the selected range if optimal exposure can not be achieved at the selected shutter speed or aperture.





Image Quality

Choose a file format and compression ratio for photographs.

Option	File type	Description
NEF (RAW)	NEF	Compressed 12-bit raw data from the image sensor are saved directly to the memory card. White balance, contrast, and other settings can be adjusted on a computer after shooting.
JPEG fine	JPEG	Record JPEG images at a compression ratio of roughly 1 : 4 (fine quality).
JPEG normal		Record JPEG images at a compression ratio of roughly 1 : 8 (normal quality).
JPEG basic		Record JPEG images at a compression ratio of roughly 1 : 16 (basic quality).
NEF (RAW) + JPEG fine	NEF/ JPEG	Two images are recorded: one NEF (RAW) image and one fine-quality JPEG image.

Image Size

Choose the size of photographs taken in still image and Smart Photo Selector modes.

Option	Size (pixels)	Approximate print size at 300 dpi (cm/in.)*
 4608×3072; 14.2 M	4608 × 3072	39 × 26/15.4 × 10.2
 3456×2304; 8.0 M	3456 × 2304	29.3 × 19.5/11.5 × 7.7
 2304×1536; 3.5 M	2304 × 1536	19.5 × 13/7.7 × 5.1

*Print size in inches equals image size in pixels divided by printer resolution in dots per inch (dpi; 1 inch=approximately 2.54 cm).



NEF (RAW)/NEF (RAW) + JPEG

The option selected for image size does not affect the size of NEF (RAW) images. NEF (RAW) images can be viewed on the camera or using software such as Capture NX 2 (available separately; □ 171) or ViewNX 2 (supplied).

When photographs taken at NEF (RAW) + JPEG are viewed on the camera, only the JPEG image will be displayed. When photographs taken at these settings are deleted, both NEF and JPEG images will be deleted.

File Names

Photos and movies are stored as image files with names of the form "xxx_nnnn.yyy," where:

- xxx is either NMS (Motion Snapshots recorded with **NMS file** selected for **File format**; □ 128) or DSC (photos, MOV-format Motion Snapshots, and movies, including copies created with **Edit movie**; □ 116),
- nnnn a four-digit number between 0001 and 9999 assigned automatically in ascending order by the camera, and
- yyy one of the following three letter extensions: "NEF" for NEF (RAW) images, "JPG" for JPEG images, or "MOV" for movies.

The NEF and JPEG files recorded at settings of NEF (RAW)+JPEG have the same file names but different extensions. Trimmed copies created with **Edit movie** (□ 116) have file names beginning with "DSC"; copies created with the other retouch options in the playback menu have file names beginning with "CSC" (e.g., "CSC_0001.JPG"). Images recorded with **Adobe RGB** selected for **Color space** (□ 143) have names that begin with an underscore (e.g., "_DSC0001.JPG").

Image Quality and Size

Together, image quality and size determine how much space each photograph occupies on the memory card. Larger, higher quality images can be printed at larger sizes but also require more memory, meaning that fewer such images can be stored on the memory card (□ 186).



Continuous

Choose the frame rate for continuous shooting (📖 63) from 5, 15, 30, and 60 fps. An electronic shutter is used at rates of 15 fps and above; except when **On** is selected for **Silent photography**, a mechanical shutter is used when **5 fps** is selected.

Silent Photography

Select **On** to reduce camera noise in quiet surroundings. The camera uses an electronic shutter and silences the sounds produced when the camera controls are operated. Selecting **Off** restores normal operation.

Number of Shots Saved

Choose the number of shots selected by the Smart Photo Selector. If **5** is selected, the camera will save the best shot and 4 best shot candidates. If **1** is selected, the camera will save only the best shot.

Frame Rate

Choose a frame rate for slow motion movies (📖 53). The faster the frame rate, the smaller the frame size.

Option	Frame size (pixels)	Bit rate (approx.)	Maximum length (shooting)	Maximum length (playback)*
400 fps	640 × 240	2 Mbps	3 seconds	40 seconds
1200 fps	320 × 120	1 Mbps	3 seconds	2 minutes

* All figures are approximate. Slow motion movies will play back over a period of about 13.2 (400 fps) or 40 (1200 fps) times the recording time.





See Also

For information on the total length of movies that can be stored on the memory card, see page 187.



Movie Settings

Choose a frame size and frame rate for HD movies (📖 49).

Option	Frame size (pixels)	Recording rate	Bit rate (approx.)	Maximum length
 1080/60i	1920 × 1080	59.94 fields/s *	24 Mbps	20 minutes
 1080/30p		29.97 fps	24 Mbps	
 720/60p	1280 × 720	59.94 fps	16 Mbps	29 minutes
 720/30p		29.97 fps	12 Mbps	

* Sensor output is about 60 fps.

Photo Frame Size

Photographs recorded by pressing the shutter-release button all the way down during movie recording have an aspect ratio of 3 : 2. The frame size varies with the option selected for **Movie settings**:

- **1080/60i and 1080/30p**: 4608 × 3072
- **720/60p and 720/30p**: 1280 × 865

See Also

For information on the total length of movies that can be stored on the memory card, see page 187.



Movie Before/After

Choose whether the movie portions of Motion Snapshots end when the shutter-release button is pressed all the way or about 0.6 s after (□ 59).

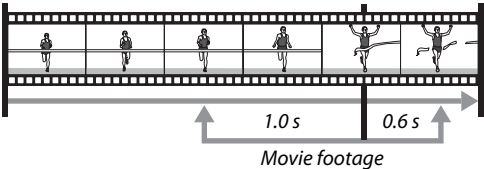
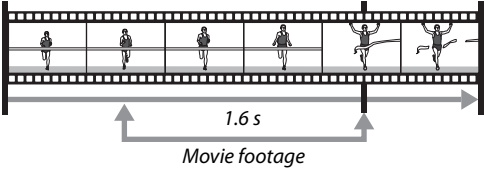
1.0 s : 0.6 s	<p>Movie footage starts about a second before the shutter-release button is pressed all the way down and ends about 0.6 s after.</p> <p><i>Shutter-release button pressed halfway</i> <i>Shutter-release button pressed all the way down</i></p>  <p>The diagram shows a film strip with six frames of a person running. A vertical line marks the shutter-release button pressed all the way down. A horizontal arrow below the film strip indicates that the movie footage starts 1.0 s before this vertical line and ends 0.6 s after it.</p>
1.6 s : 0 s	<p>The camera records about 1.6 s of movie footage, ending when the shutter-release button is pressed all the way down.</p> <p><i>Shutter-release button pressed halfway</i> <i>Shutter-release button pressed all the way down</i></p>  <p>The diagram shows a film strip with six frames of a person running. A vertical line marks the shutter-release button pressed all the way down. A horizontal arrow below the film strip indicates that the movie footage starts 1.6 s before this vertical line and ends at the vertical line.</p>





File Format

Choose the file format for Motion Snapshots (📖 59).

NMS file	Motion Snapshots are recorded as a 4 s MOV file and a JPEG image. Motion Snapshots can only be viewed on the camera or using ViewNX 2.
MOV file	Motion Snapshots are recorded as a 10 s MOV file that can be viewed in a variety of computer applications. The Motion Snapshot is not displayed automatically when shooting ends (📖 60); for information on viewing Motion Snapshot movies, see page 56.

Metering

Choose how the camera sets exposure.

 Matrix	The camera meters a wide area of the frame and adjusts for contrast (tone distribution), color, composition, and subject distance, producing natural results in most situations.
 Center-weighted	The camera meters the entire frame but assigns the greatest weight to the center area. This is the classic meter for portraits and is recommended if you are using filters with an exposure factor (filter factor) over 1×.
 Spot	The camera meters the current focus area; use to meter off-center subjects (if Auto-area is selected for AF-area mode as described on page 153, the camera will meter the center focus area, while during face priority the camera will meter the focus area closest to the center of the selected face; 📖 27). Spot metering ensures that the subject will be correctly exposed, even when framed against a background that is much brighter or darker.

Metering and Shooting Mode

In auto and best moment capture modes, and when  **Scene auto selector** (📖 122) is chosen in Motion Snapshot mode, metering is adjusted automatically according to the scene.

Autoexposure Lock

Exposure lock is used to recompose photographs after metering exposure. It is most effective when used with center-weighted or spot metering (📖 128) to frame off-center subjects that are much brighter or darker than their surroundings or to optimize exposure for an object other than your main subject.

1 Meter exposure.

Position the subject in the center of the frame and press the shutter-release button halfway to meter exposure. Check that the focus area is displayed in green.

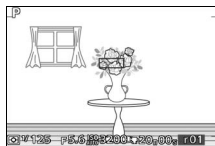

2 Lock exposure.

With the shutter-release button pressed halfway and the subject positioned in the focus area, press \blacktriangle (AE-L) to lock exposure. While exposure lock is in effect, an AE-L/AF-L indicator will be displayed. Exposure will remain locked until \blacktriangle (AE-L) is pressed again, even if you later remove your finger from the shutter-release button.

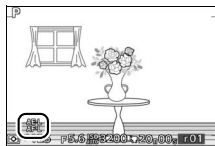

See Also

For information on changing the role of the \blacktriangle (AE-L) button, see page 163.







3 Recompose the photograph.

Recompose the photograph and shoot. To end exposure lock, press \blacktriangle (AE-L) again.



White Balance

White balance ensures that colors are unaffected by the color of the light source. Auto white balance is recommended for most light sources, but other values can be selected if necessary according to the type of source.

AUTO Auto	Automatic white balance adjustment. Recommended in most situations.
 Incandescent	Use under incandescent lighting.
 Fluorescent	Use with cool-white fluorescent lighting.
 Direct sunlight	Use with subjects lit by direct sunlight.
 Flash	Use with built-in or optional flash units.
 Cloudy	Use in daylight under overcast skies.
 Shade	Use in daylight with subjects in the shade.
PRE Preset manual	Measure white balance (□ 132).

White Balance and Shooting Mode

In auto and best moment capture modes, and when  **Scene auto selector** (□ 122) is chosen in Motion Snapshot mode, white balance is adjusted automatically according to the scene.



Fine-Tuning White Balance

Options other than **Preset manual** can be fine-tuned as follows:

1 Display fine-tuning options.

Highlight an option other than **Preset manual** and press **▶** to display the fine-tuning options shown at right.

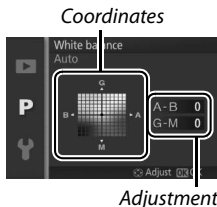

2 Fine-tune white balance.

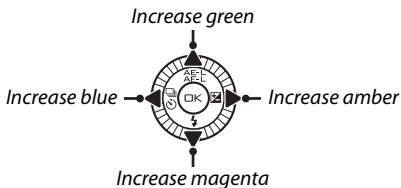

Use the multi selector to fine-tune white balance.



White Balance Fine Tuning

The colors on the fine-tuning axes are relative, not absolute. For example, moving the cursor to **B** (blue) when a “warm” setting such as  (incandescent) is selected will make photographs slightly “colder” but will not actually make them blue.

3 Save changes and exit.

Press **OK**. An asterisk will appear next to the white balance icon ( 4) in the detailed display ( 5) to show that white balance has been altered from default values.



Preset Manual

Preset manual is used to record and recall custom white balance settings for shooting under mixed lighting or to compensate for light sources with a strong color cast.

1 Light a reference object.

Place a neutral gray or white object under the lighting that will be used in the final photograph. A standard gray panel can be used for increased precision.

2 Select Preset manual.

Highlight **Preset manual** in the white balance menu and press **▶**. The dialog shown at right will be displayed; highlight **Yes** and press **OK** to overwrite the existing value for preset manual white balance.

The message shown at right will be displayed.

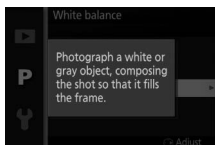
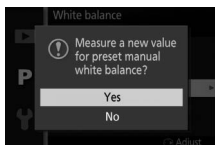

3 Measure white balance.

When the camera is ready to measure white balance, a flashing PRE will be displayed. Before the indicator stops flashing, frame the reference object so that it fills the display and press the shutter-release button all the way down. No photograph will be recorded; white balance can be measured accurately even when the camera is not in focus.



4 Check the results.

If the camera was able to measure a value for white balance, the message shown at right will be displayed. To return to shooting mode immediately, press the shutter-release button half-way.

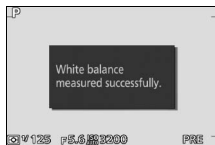

If lighting is too dark or too bright, the camera may be unable to measure white balance. The message at right will be displayed. Return to Step 3 and measure white balance again.

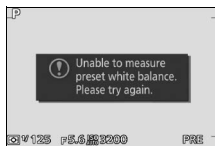

Auto Power Off

White balance measurement will end without a new value being acquired if no operations are performed for the time selected for **Auto power off** in the setup menu (☐ 162; the default is 1 minute).

Preset White Balance

The camera can store only one value for preset white balance at a time; the existing value will be replaced when a new value is measured. Note that exposure is automatically increased by 1 EV when measuring white balance; in mode M, adjust exposure so that the exposure indicator shows ± 0 (☐ 37).

Color Temperature

The perceived color of a light source varies with the viewer and other conditions. Color temperature is an objective measure of the color of a light source, defined with reference to the temperature to which an object would have to be heated to radiate light in the same wavelengths. While light sources with a color temperature in the neighborhood of 5000–5500 K appear white, light sources with a lower color temperature, such as incandescent light bulbs, appear slightly yellow or red. Light sources with a higher color temperature appear tinged with blue. The camera white balance options are adapted to the following color temperatures (all figures are approximate):

- | | |
|---|---------------------------------------|
| • Sodium-vapor lamps: 2700 K | • ☀ (direct sunlight): 5200 K |
| • ⚡ (incandescent)/ | • ⚡ (flash): 5400 K |
| Warm-white fluorescent: 3000 K | • ☁ (cloudy): 6000 K |
| • White fluorescent: 3700 K | • Daylight fluorescent: 6500 K |
| • ☀ Cool-white fluorescent: 4200 K | • Mercury-vapor lamps: 7200 K |
| • Day white fluorescent: 5000 K | • 🏠 (shade): 8000 K |



ISO Sensitivity

The higher the ISO sensitivity, the less light needed to make an exposure, allowing faster shutter speeds or smaller apertures, but the more likely the image is to be affected by “noise” in the form of randomly-spaced bright pixels, fog, or lines.

A6400 Auto (160–6400) A3200 Auto (160–3200) A800 Auto (160–800)	The camera adjusts ISO sensitivity in response to lighting conditions. ISO sensitivity is adjusted in the range given in brackets; choose larger ranges for increased sensitivity when lighting is poor, smaller ranges to reduce noise.
160, 200, 400, 800, 1600, 3200, 6400	ISO sensitivity is fixed at the selected value.





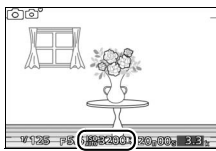

“Auto” ISO Sensitivity Options

When auto ISO sensitivity control is in effect, the display shows an **ISO-AUTO** icon and the current ISO sensitivity.



Picture Control

Choose how the camera processes photographs.

 SD Standard	Standard processing for balanced results. Recommended in most situations.
 NL Neutral	Minimal processing for natural results. Choose for photographs that will later be extensively processed or retouched.
 VI Vivid	Pictures are enhanced for a vivid, photoprint effect. Choose for photographs that emphasize primary colors.
 MC Monochrome	Take monochrome photographs.
 PT Portrait	Process portraits for natural texture and a rounded feel.
 LS Landscape	Take vibrant photographs of landscapes and cityscapes.

Modifying Picture Controls

Existing preset and custom Picture Controls (📖 140) can be modified to suit the scene or your creative intent.

1 Display options.

Highlight an item in the Picture Control menu and press ► to display Picture Control settings (📖 138; the settings available with custom Picture Controls are the same as the preset controls on which they are based). To use an unmodified Picture Control, highlight it and press Ⓞ.

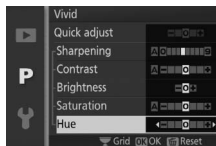

2 Adjust settings.

Press ▲ or ▼ to highlight the desired setting and press ◀ or ▶ to choose a value. Repeat this step until all settings have been adjusted, or select



Quick adjust to choose a preset combination of settings. Default settings can be restored by pressing the  button.





3 Save changes and exit.

Press .

Preset Picture Controls Versus Custom Picture Controls



The Picture Controls supplied with the camera are referred to as *preset Picture Controls*. *Custom Picture Controls* are created through modifications to existing Picture Controls using the **Custom Picture Control** option in the shooting menu ( 140). If desired, custom Picture Controls can be saved to a memory card and copied to other Nikon 1 V2 cameras or loaded into compatible software ( 141).

Modified Picture Controls

Picture Controls that have been modified from default settings are indicated by asterisks ("*") next to the Picture Control name and icon in the Picture Control menu ( 136) and next to the Picture Control icon ( 4) in the detailed display ( 5).



Picture Control and Shooting Mode

In auto and best moment capture modes, and when  **Scene auto selector** ( 122) is chosen in Motion Snapshot mode, the camera automatically chooses a Picture Control according to the scene.



Picture Control Settings

Quick adjust		Choose from options between -2 and +2 to reduce or exaggerate the effect of the selected Picture Control (note that this resets all manual adjustments). For example, choosing positive values for Vivid makes pictures more vivid. Not available with Neutral , Monochrome , or custom Picture Controls.
Manual adjustments (all Picture Controls)	Sharpening	Control the sharpness of outlines. Select A to adjust sharpening automatically according to the type of scene, or choose from values between 0 (no sharpening) and 9 (the higher the value, the greater the sharpening).
	Contrast	Select A to adjust contrast automatically according to the type of scene, or choose from values between -3 and +3 (lower values prevent highlights in portrait subjects from being "washed out" in direct sunlight, while higher values preserve detail in misty landscapes and other low-contrast subjects).
	Brightness	Choose -1 for reduced brightness, +1 for enhanced brightness. Does not affect exposure.
Manual adjustments (non-monochrome only)	Saturation	Control the vividness of colors. Select A to adjust saturation automatically according to the type of scene, or choose from values between -3 and +3 (lower values reduce saturation and higher values increase it).
	Hue	Choose negative values (to a minimum of -3) to make reds more purple, blues more green, and greens more yellow, positive values (up to +3) to make reds more orange, greens more blue, and blues more purple.
Manual adjustments (monochrome only)	Filter effects	Simulate the effect of color filters on monochrome photographs. Choose from Off , yellow, orange, red, and green (☞ 139).
	Toning	Choose the tint used in monochrome photographs from B&W (black-and-white), Sepia , Cyanotype (blue-tinted monochrome), Red , Yellow , Green , Blue Green , Blue , Purple Blue , and Red Purple (☞ 139).



✔ "A" (Auto)

Results for auto sharpening, contrast, and saturation vary with exposure and the position of the subject in the frame.

🔍 The Picture Control Grid

Pressing the command dial in Step 2 displays a Picture Control grid showing the contrast and saturation for the selected Picture Control in relation to the other Picture Controls (only contrast is displayed when **Monochrome** is selected). Release the dial to return to the Picture Control menu.

The icons for Picture Controls that use auto contrast and saturation are displayed in green in the Picture Control grid, and lines appear parallel to the axes of the grid.

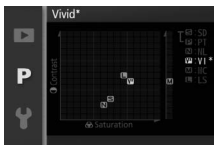

🔍 Previous Settings

The line under the value display in the Picture Control setting menu indicates the previous value for the setting. Use this as a reference when adjusting settings.



🔍 Filter Effects (Monochrome Only)

The options in this menu simulate the effect of color filters on monochrome photographs. The following filter effects are available:

Y (yellow)	Enhance contrast. Can be used to reduce the brightness of the sky in landscape photographs.
O (orange)	Orange produces more contrast than yellow, red more contrast than orange.
R (red)	
G (green)	Softens skin tones. Can be used for portraits.

Note that the effects achieved with **Filter effects** are more pronounced than those produced by physical glass filters.

🔍 Toning (Monochrome Only)

Pressing ▼ when **Toning** is highlighted displays saturation options. Press ◀ or ▶ to adjust saturation. Saturation control is not available when **B&W** (black-and-white) is selected.

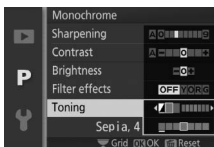

Custom Picture Control

The Picture Controls supplied with the camera can be modified and saved as custom Picture Controls.

Edit/Save

To create a custom Picture Control, select **Edit/save** and follow the steps below.

1 Select a Picture Control.

Highlight an existing Picture Control and press **▶**, or press **OK** to proceed to Step 3 to save a copy of the highlighted Picture Control without further modification.



2 Edit the selected Picture Control.

See page 138 for more information. To abandon any changes and start over from default settings, press the **⌫** button. Press **OK** when settings are complete.

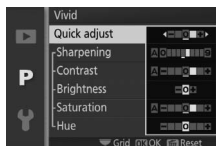

3 Save the Picture Control.

Highlight a destination (C-1 through C-9) and press **OK** to save the custom Picture Control and return to the shooting menu.

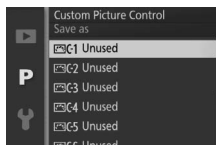

The new Picture Control will be listed in the **Picture Control** menu.

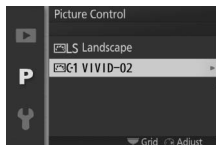

Load from/Save to Card

Custom Picture Controls created using the Picture Control Utility available with ViewNX 2 or optional software such as Capture NX 2 can be copied to a memory card and loaded into the camera, or custom Picture Controls created with the camera can be copied to the memory card to be used in other Nikon 1 V2 cameras and compatible software and then deleted when no longer needed.

To copy custom Picture Controls to or from the memory card, or to delete custom Picture Controls from the memory card, select **Load from/save to card** in the **Custom Picture Control** menu. The following options will be displayed:

Copy to camera	Copy custom Picture Controls from the memory card to custom Picture Controls C-1 through C-9.
Delete from card	Delete selected custom Picture Controls from the memory card. The confirmation dialog shown at right will be displayed before a Picture Control is deleted; to delete the selected Picture Control, highlight Yes and press OK .
Copy to card	Copy a custom Picture Control (C-1 through C-9) to a selected destination (1 through 99) on the memory card.



Copy to Card

Up to 99 custom Picture Controls can be stored on the memory card at any one time. The memory card can only be used to store user-created custom Picture Controls. The preset Picture Controls supplied with the camera can not be copied to the memory card or deleted.

Custom Picture Control > Delete

The **Delete** option in the **Custom Picture Control** menu can be used to delete selected custom Picture Controls from the camera when they are no longer needed.



Auto Distortion Control

Select **On** to reduce barrel distortion in photos taken with wide-angle lenses and to reduce pin-cushion distortion in photos taken with long lenses (note that the edges of photographs may be cropped out, and that there may be an increase in the time needed to process images before they are saved). This option is available only with 1 NIKKOR lenses and not with other NIKKOR lenses attached using the FT1 mount adapter. Results are not guaranteed with third-party lenses.



Color Space

The color space determines the gamut of colors available for color reproduction. Choose **sRGB** for photos that will be used "as is," with no further modification, **Adobe RGB** for photos that will be extensively processed or retouched after leaving the camera. Note that regardless of the option selected, sRGB is used for movies and Motion Snapshots and for photos taken during movie recording.

Color Space

Color spaces define the correspondence between colors and the numeric values by which they are represented in a digital image file. The sRGB color space is widely used, while Adobe RGB is typically used in publishing and commercial printing. sRGB is recommended when taking photographs that will be printed without modification or viewed in applications that do not support color management, or when taking photographs that will be printed with ExifPrint, the direct printing option on some household printers, or kiosk printing or other commercial print services. Adobe RGB photographs can also be printed using these options, but colors will not be as vivid.

JPEG photographs taken in the Adobe RGB color space are DCF compliant; applications and printers that support DCF will select the correct color space automatically. If the application or device does not support DCF, select the appropriate color space manually. For more information, see the documentation provided with the application or device.

Nikon Software

ViewNX 2 (supplied) and Capture NX 2 (available separately) automatically select the correct color space when opening photographs created with this camera.



Active D-Lighting

Active D-Lighting preserves details in highlights and shadows for natural contrast. Use with high contrast scenes such as a brightly lit outdoor view framed in a door or window or a subjects in the shade on a sunny day. It is most effective when used with **Matrix** metering (☐ 128).



Active D-Lighting: **Off**



Active D-Lighting: ☑ **On**

☑ Active D-Lighting

Noise (randomly-spaced bright pixels, fog, or lines) may appear in photographs taken with Active D-Lighting. Uneven shading may be visible with some subjects.

✎ “Active D-Lighting” Versus “D-Lighting”

The **Active D-Lighting** option in the shooting menu adjusts exposure before shooting to optimize the dynamic range, while the **D-Lighting** option in the playback menu (☐ 113) brightens shadows in images after shooting.



HDR (High Dynamic Range)

Select **On** to preserve details in high-contrast scenes. Each time a picture is taken, the camera quickly takes 2 shots at different exposures and combines them to capture a wide range of tones, from shadows to highlights. While the shots are combined, a message is displayed and the shutter release is disabled. The final photograph is displayed when processing is complete.

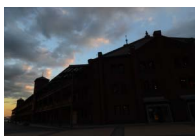

First exposure (darker)

+



Second exposure (brighter)



Combined HDR image

While HDR is in effect, **HDR** appears in the display and continuous shooting (📖 63) is disabled.

HDR

The edges of the image will be cropped out and neither the built-in flash nor optional flash units will fire. The desired results may not be achieved if the camera or subject moves during shooting. Depending on the scene, shading may be uneven and shadows may appear around bright objects or halos around dark objects.



Long Exposure NR

Photographs taken at slow shutter speeds are automatically processed to reduce “noise” (bright spots, randomly-spaced bright pixels, or fog), slightly increasing recording times. Selecting **On** increases the amount of noise reduction performed at shutter speeds slower than 1 s and increases the time required to record images by roughly 1.5 to 2 times. During processing, a warning will be displayed and pictures can not be taken (if the camera is turned off before processing is complete, the picture will be saved but noise reduction will not be performed). In continuous release mode, frame rates will slow and while photographs are being processed, the capacity of the memory buffer will drop.

High ISO Noise Reduction

Select **On** to reduce “noise” (randomly-spaced bright pixels, lines, or fog). If **Off** is selected, noise reduction will only be performed at high ISO sensitivities; the amount of noise reduction is less than that performed when **On** is selected.



Movie Sound Options

Adjust movie sound recording settings for the built-in microphone and optional ME-1 external microphones.

Microphone

Select **Microphone off** to disable sound recording. Selecting any other option enables recording and sets the microphone to the selected sensitivity.

The Icon

Movies recorded with the microphone off are indicated by a  icon in full-frame and movie playback.

Wind Noise Reduction

Select **On** to enable the low-cut filter, reducing noise produced by wind blowing over the microphone (note that other sounds may also be affected).

Wind Noise Reduction

To disable wind noise reduction when using an optional ME-1 stereo microphone, slide the microphone low-cut filter switch to FLAT and select **Off** for **Wind noise reduction**.



Vibration Reduction

This option is available with 1 NIKKOR lenses that support vibration reduction (VR). The options available vary with the type of lens: **Normal/Active/Off** for lenses that support active vibration reduction and **On/Off** for other VR lenses. Choose **Active, Normal**, or **On** to reduce the effects of vibration; choose **Active** when shooting from a moving vehicle or while walking or for other forms of strong camera shake, **Normal** for the relatively mild camera shake that occurs while standing still.



Vibration Reduction

When the camera is panned, vibration reduction applies only to motion that is not part of the pan (if the camera is panned horizontally, for example, vibration reduction will be applied only to vertical shake), making it much easier to pan the camera smoothly in a wide arc. The composition may appear to change after the shutter is released, but this does not indicate a malfunction.

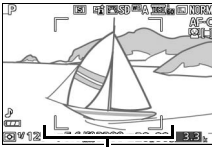

Focus Mode

Choose how the camera focuses.

AF-A	Auto-select AF: The camera automatically selects AF-S if the subject is stationary, AF-C if it is moving.
AF-S	Single AF: For stationary subjects. Focus locks when the shutter-release button is pressed halfway.*
AF-C	<p>Continuous AF: For subjects in motion. The camera focuses continuously on the subject in the AF area brackets while the shutter-release button is pressed halfway (note that the AF area brackets are only shown in the detailed display;  5). Photos can be taken whether or not the camera is in focus.</p>  <p style="text-align: center;"><i>AF area brackets</i></p>
AF-F	Full-time AF: For subjects in motion. The camera focuses continuously; photos can be taken whether or not the camera is in focus.
MF	Manual focus: Focus manually ( 151). Photos can be taken whether or not the camera is in focus.

*Shutter can only be released if camera is able to focus.

Focus Mode

The options available vary with the shooting mode.

Shooting mode		Focus mode
P, S, A, M		AF-A (default), AF-S, AF-C, MF
Advanced movie mode	HD movie	AF-F (default), AF-S, MF
	Slow motion	AF-S (default), MF



Getting Good Results with Autofocus

Autofocus does not perform well under the conditions listed below. The shutter release may be disabled if the camera is unable to focus under these conditions, or the focus area may be displayed in green and the camera may sound a beep, allowing the shutter to be released even when the subject is not in focus. In these cases, focus manually (☐ 151) or use focus lock (☐ 154) to focus on another subject at the same distance, and then recompose the photograph.

There is little or no contrast between the subject and the background.

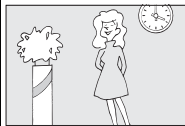

Example: The subject is the same color as the background.

The subject contains areas of sharply contrasting brightness.

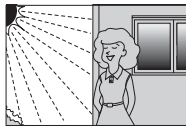

Examples: The subject is half in the shade; a night scene with point illumination.

The subject contains objects at different distances from the camera.



Example: The subject is inside a cage.

Background objects appear larger than the subject.



Example: A building is in the frame behind the subject.

The subject is dominated by regular geometric patterns.

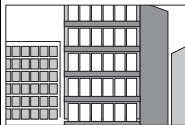

Example: Blinds or a row of windows in a skyscraper.

The subject contains many fine details or is made up of objects that are small or lack variation in brightness.

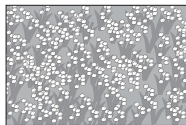

Example: A field of flowers.



The AF-Assist Illuminator

If the subject is poorly lit, the AF-assist illuminator will light automatically to assist the autofocus operation when the shutter-release button is pressed halfway. The AF-assist illuminator does not light in advanced movie mode or during movie recording; in other situations it lights only if:

- **AF-S** is selected for focus mode or single AF selected in **AF-A** focus mode,
 - **Auto-area** is selected for **AF-area mode** (☞ 153) or the center focus area (☞ 153) is selected for **Single-point**, and
 - **On** is selected for **Built-in AF assist** in the shooting menu (☞ 156).
- Larger lenses may prevent the illuminator lighting all or part of the subject. Remove lens hoods when using the illuminator.

AF-assist illuminator

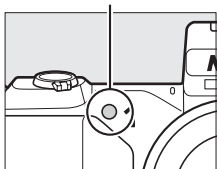

Manual Focus

Manual focus can be used when autofocus does not produce the desired results.

1 Select manual focus.

Select **Manual focus** for **Focus mode** (☞ 149).

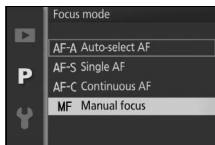





2 Display the manual focus guides.

Press  to magnify the view at the center of the frame and display manual focus guides (this feature is not available during movie recording or in slow-motion movie mode).



3 Focus.

Rotate the multi selector until the subject is in focus. Rotate the multi selector clockwise to increase the focus distance, counterclockwise to decrease; the faster you rotate the multi selector, the quicker the focus distance changes. The focus indicator shows the approximate focus distance. Press  when the subject is in focus.

To magnify the view in the display by up to about 10x for precise focus, rotate the command dial right. Press , , , or  to view areas of the frame not currently visible in the display; the visible portion is shown by the navigation window. To zoom out, rotate the command dial left.

Multi selector dial: Focus

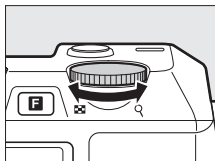

Command dial:

Zoom in or out

Focus indicator

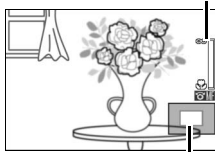

Navigation window

Movies

The multi selector can also be used to choose the focus distance if manual focus is selected during movie recording. Rotate the multi selector clockwise to increase the focus distance, counterclockwise to decrease; the faster you rotate the multi selector, the quicker the focus distance changes.

Focal Plane Position



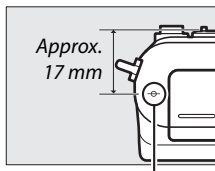





To determine the distance between your subject and the camera, measure from the focal plane mark on the camera body. The distance between the lens mounting flange and the focal plane is approximately 17 mm (0.7 in.).

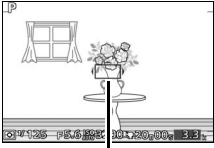

Focal plane mark

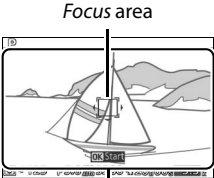
AF-Area Mode

Choose how the focus area for autofocus is selected.

 Auto-area	The camera automatically detects the subject and selects the focus area.	 <p><i>Focus area</i></p>
 Single-point	Press  to view the focus area selection display, then use the multi selector to position the focus area over your subject and press  ; the camera focuses on the subject in the selected focus area only. Use with stationary subjects.	 <p><i>Subject tracking area</i></p>
 Subject tracking	Press  to view the focus area selection display, then use the multi selector to position the focus area over your subject and press  . The focus area will track the subject as it moves through the area shown at right. The camera will focus on the selected subject when the shutter-release button is pressed halfway. To end focus tracking when shooting is complete, press  .	

Subject Tracking

The camera may be unable to track subjects if they move quickly, leave the frame or are obscured by other objects, change visibly in size, color, or brightness, or are too small, too large, too bright, too dark, or similar in color or brightness to the background.



Focus Lock

Focus lock can be used to change the composition after focusing on the subject in the center of the frame, allowing you to focus on a subject that will not be in the center of the final composition. If the camera is unable to focus using autofocus (📖 150), you can also focus on another subject at the same distance and then use focus lock to recompose the photograph. Focus lock is most effective when an option other than **Auto-area** is selected for **AF-area mode** (📖 153).

1 Focus.

Position the subject in the center of the frame and press the shutter-release button halfway to initiate focus. Check that the focus area is displayed in green. If **AF-S** is selected for focus mode (📖 149), focus will lock while the shutter-release button is pressed halfway.

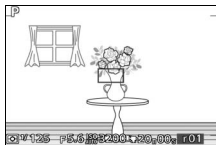

2 Lock focus.

With the shutter-release button pressed halfway, press ▲ (AE-L/AF-L) to lock both focus and exposure (an AE-L/AF-L indicator will be displayed; 129). Focus will remain locked until ▲ (AE-L/AF-L) is pressed again, even if you later remove your finger from the shutter-release button.

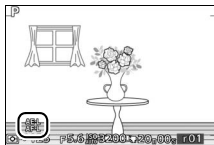

See Also

For information on changing the role of the ▲ (AE-L/AF-L) button, see page 163.

3 Recompose the photograph and shoot.

Focus will remain locked between shots.

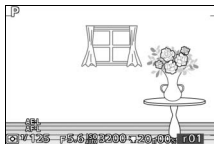

Do not change the distance between the camera and the subject while focus lock is in effect. If the subject moves, press ▲ (AE-L/AF-L) to end focus lock and then focus again at the new distance.



Face-Priority

Choose **On** to enable face priority (📖 27).

Built-in AF Assist

When **On** is selected, the built-in AF-assist illuminator will light to illuminate poorly-lit subjects if:

- **AF-S** is selected for focus mode (📖 149) or single AF is selected in **AF-A**, and
- **Auto-area** is selected for **AF-area mode** (📖 153) or the center focus area is selected for **Single-point**.

AF-assist illuminator

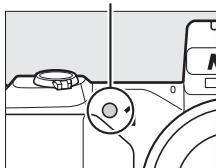

The AF-assist illuminator will not light to assist the focus operation in advanced movie mode, during movie recording, or when **Off** is selected. If the AF-assist illuminator does not light, auto-focus may not produce the desired results when lighting is poor.

See Also

See page 151 for information on using the AF-assist illuminator. Information on the modes in which AF-assist is available may be found on page 181.



Flash Control

Choose a flash control mode for the built-in and optional flash units.

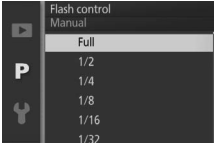
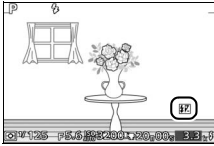
TTL ↕ TTL	Flash output is adjusted automatically in response to shooting conditions (TTL flash control).
M ↕ Manual	<p>Choose a flash level between Full and 1/32 (1/32 of full power). At full power, the built-in flash has a guide number of about 5/16 (m/ft, ISO 100, 20 °C/68 °F; at ISO 160, the guide number is about 6.3/20.7).</p> <p>A  icon flashes in the display during flash photography when this option is selected.</p> <div data-bbox="658 282 935 467"></div> <div data-bbox="658 489 935 678"></div>



Flash Compensation

Flash compensation alters flash output from the level suggested by the camera, changing the brightness of the main subject relative to the background. Choose from values between -3 EV (darker) and $+1$ EV (brighter) in increments of $\frac{1}{3}$ EV; in general, positive values make the subject brighter while negative values make it darker.

A  icon is displayed when flash compensation is in effect. Normal flash output can be restored by setting flash compensation to ± 0 . Flash compensation is not reset when the camera is turned off.

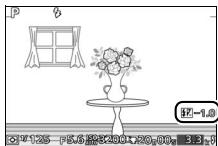

The Setup Menu

To display the setup menu, press MENU and select the setup menu tab (Y).

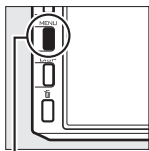

MENU button

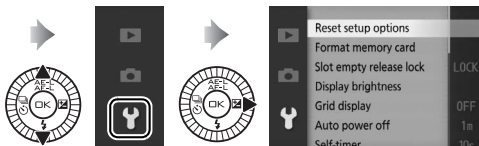

The setup menu contains the following options:

Option	Description	Default	
Reset setup options	Reset setup menu options to default values.	—	160
Format memory card	Format the memory card.	—	161
Slot empty release lock	Allow the shutter to be released when no memory card is inserted in the camera.	Release locked	161
Display brightness	Adjust display brightness.	0	161
Grid display	Display a framing grid.	Off	162
Auto power off	Choose the auto power off delay.	1 min	162
Self-timer	Choose the self-timer delay.	10 s	162
Remote control	Choose the remote control mode shutter-release delay.	Quick response	163
Remote on duration	Choose how long the camera waits for a signal from an ML-L3 remote control.	10 min	163
Assign AE/AF-L button	Choose the role played by the \blacktriangle (AE-L) button.	AE/AF lock	163
Shutter button AE lock	Choose whether exposure locks when the shutter-release button is pressed halfway.	Off	163

Option	Description	Default	
HDMI device control	Choose whether remote controls for HDMI-CEC devices to which the camera is connected can be used to operate the camera.	On	101
Flicker reduction	Reduce flicker or banding.	—	164
Reset file numbering	Reset file numbering.	—	164
Time zone and date	Set the camera clock.	Daylight saving time: Off	165
Language	Choose a language for the camera displays.	—	165
Auto image rotation	Record camera orientation with pictures.	On	166
Wireless mobile adapter	Enable or disable the wireless mobile adapter.	—	79
GPS	Adjust settings for optional GPS units.	Auto power off: Disable Use GPS to set clock: Yes	77
Pixel mapping	Check and optimize the camera image sensor and image processors.	—	167
Firmware version	Display the current firmware version.	—	167

Reset Setup Options

Select **Yes** to reset all setup menu options other than **Flicker reduction**, **Time zone and date**, and **Language** to default values.



Format Memory Card

Select **Yes** to format the memory card. *Note that this permanently deletes all data on the card, including protected images; before proceeding, be sure to copy important pictures and other data to a computer (📖 95).* To exit without formatting the memory card, highlight **No** and press **OK**.

The message shown at right is displayed while the card is formatted; *do not remove the memory card or remove or disconnect the power source until formatting is complete.*

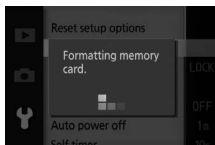

Slot Empty Release Lock

If **Enable release** is selected, the shutter can be released when no memory card is inserted. No pictures will be recorded, although they will be displayed in demo mode. Select **Release locked** to enable the shutter only when a card is inserted.

Display Brightness

Highlight **Monitor brightness** or **Viewfinder brightness** and press **▶** to display brightness options for the selected display. Brightness can then be adjusted by pressing **▲** or **▼**; choose higher values for increased brightness, lower values for reduced brightness.

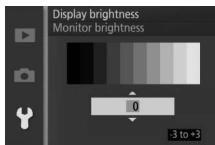

Grid Display

Select **On** to display a framing grid (📖 6).

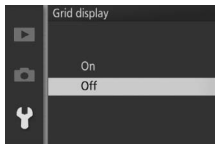

Auto Power Off

Choose how long the displays remain on when no operations are performed (📖 18). Choose shorter delays to reduce the drain on the battery. Once the displays have turned off, they can be reactivated by operating the camera buttons or mode dial.

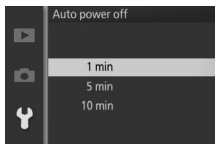

The GP-N100

To enable auto power off when an optional GP-N100 GPS unit is attached, select **Enable** for the **GPS > Auto power off** option in the setup menu (📖 76).

Self-Timer

Choose the length of the self-timer shutter-release delay (📖 65). Choose **2 s** to reduce blur caused by the camera moving when the shutter-release button is pressed, **10 s** for self-portraits.



Remote Control

Choose how the camera responds to the shutter-release button on the optional ML-L3 remote control (☞ 65). If **Quick response** is selected, the shutter will be released immediately; if **2 s delay** is selected, the shutter will be released after a 2 s delay.

Remote on Duration

Choose how long the camera will remain active while waiting for a signal from the remote control (☞ 63). Choose a shorter delay to reduce the drain on the battery. Note that remote control mode must be reselected once the timer has expired.

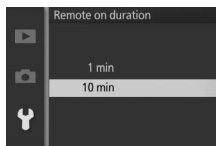

Assign AE/AF-L Button

Choose whether the **▲** (AE-L/AF-L) button locks both focus and exposure (**AE/AF lock**), exposure only (**AE lock only**), or focus only (**AF lock only**). Focus lock is described on page 154, exposure lock on page 129.



Shutter Button AE Lock

If **On** is selected, exposure will lock while the shutter-release button is pressed halfway.

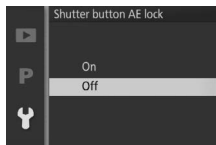

Flicker Reduction

Reduce flicker and banding in the displays and in movies while shooting under fluorescent or mercury-vapor lighting. Choose a frequency which matches that of the local AC power supply.

Flicker Reduction

If you are unsure as to the frequency of the local power supply, test both options and choose the one that produces the best results. Flicker reduction may not produce the desired results if the subject is very bright, in which case you should select mode A or M and choose a smaller aperture (larger f-number).

Reset File Numbering

When a photograph is taken or a movie is recorded, the camera names the file by adding one to the number of the previous file (📖 124). If the current folder is numbered 999 and contains either 999 photographs or a photograph numbered 9999, the shutter-release button will be disabled and no further photographs can be taken. To reset file numbering to 0001, select **Yes** for **Reset file numbering** and then either format the current memory card or insert a new memory card.

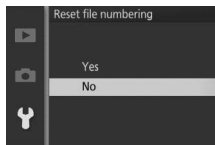

Time Zone and Date

Change time zones, set the camera clock, choose the date display order, or turn daylight saving time on or off (📖 19).

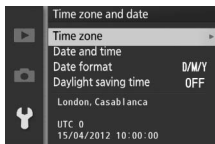

Time zone	Choose a time zone. The camera clock is automatically set to the time in the new time zone.
Date and time	Set the camera clock.
Date format	Choose the order in which the day, month, and year are displayed.
Daylight saving time	Turn daylight saving time on or off. The camera clock will automatically be advanced or set back one hour. The default setting is Off .

Language

Choose a language for camera messages and displays.



Auto Image Rotation

Photographs taken while **On** is selected contain information on camera orientation, allowing them to be rotated automatically during playback or when viewed in ViewNX 2 or Capture NX 2 (available separately;  171). The following orientations are recorded:

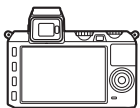

*Landscape (wide)
orientation*

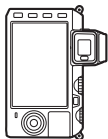

*Camera rotated 90°
clockwise*

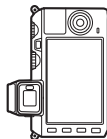

*Camera rotated 90°
counterclockwise*

Camera orientation is not recorded when **Off** is selected. Choose this option when panning or taking photographs with the lens pointing up or down.

Auto Image Rotation

Image orientation is not recorded in movie or Motion Snapshot modes.

Rotate Tall

To automatically rotate “tall” (portrait-orientation) photographs for display during playback, select **On** for the **Rotate tall** option in the playback menu ( 112).



Pixel Mapping

Check and optimize the camera image sensor and image processors if you notice unexpected bright spots in your pictures (note that the camera comes with the sensor and processors already optimized). Before performing pixel mapping as described below, check that the battery is fully charged.

1 Attach a lens and lens cap.

Turn the camera off and attach a 1 NIKKOR lens. Do not remove the lens cap.

2 Select Pixel mapping.

Turn the camera on, press **MENU**, and select **Pixel mapping** in the setup menu.

3 Select Yes.

Pixel mapping begins immediately. Note that other operations can not be performed while pixel mapping is in progress. *Do not turn the camera off or remove or disconnect the power source until pixel mapping is complete.*

4 Turn the camera off.

Turn the camera off when pixel mapping is complete.

Firmware Version

View the current firmware version.





Technical Notes

Read this chapter for information on compatible accessories, cleaning and storing the camera, and what to do if an error message is displayed or you encounter problems using the camera.

Optional Accessories

At the time of writing, the following accessories were available for your camera.

Lenses	1 mount lenses
Mount adapters	Mount Adapter FT1: The FT1 allows NIKKOR F mount lenses to be used with Nikon 1 interchangeable lens format digital cameras. The angle of view of an F mount lens mounted on the FT1 is equivalent to that of a 35 mm format lens with a focal length about 2.7 × longer. See page 205 for information on using the FT1. For information on attaching the FT1 and precautions for use, see the <i>FT1 Mount Adapter User's Manual</i> . For information on the lenses that can be used, see <i>Compatible NIKKOR F Mount Lenses</i> . The <i>FT1 Mount Adapter User's Manual</i> and <i>Compatible NIKKOR F Mount Lenses</i> are included with the FT1.
Power sources	<ul style="list-style-type: none">• Rechargeable Li-ion Battery EN-EL21 (□ 12–14): Additional EN-EL21 batteries are available from local retailers and Nikon-authorized service representatives.• Battery Charger MH-28 (□ 12): Recharge EN-EL21 batteries.• Power Connector EP-5D, AC Adapter EH-5b: These accessories can be used to power the camera for extended periods (EH-5a and EH-5 AC adapters can also be used). An EP-5D power connector is required to connect the camera to the EH-5b, EH-5a, or EH-5; see page 174 for details.



- Flash units**
- **SB-N5** (☐ 72): The SB-N5 has a Guide Number of 8.5/27.9 (m/ft, ISO 100, 20 °C/68 °F; Guide Number at ISO 160 is 10.8/35.4). When mounted on the Nikon 1 V2, it supports i-TTL and manual flash control (☐ 157).
 - **SB-N7** (☐ 72): The SB-N7 has a Guide Number of 18/59 (m/ft, ISO 100, 20 °C/68 °F; Guide Number at ISO 160 is 22.8/74.8). When mounted on the Nikon 1 V2, it supports i-TTL and manual flash control (☐ 157).

☑ Guide Number

To calculate the range of the flash at full power, divide the Guide Number by the aperture. For example, at ISO 100 the SB-N5 has a Guide Number of 8.5 m or 27.9 ft (35 mm zoom head position); its range at an aperture of f/5.6 is $8.5 \div 5.6$ or about 1.5 meters (or in feet, $27.9 \div 5.6 =$ approximately 5 ft). For each twofold increase in ISO sensitivity, multiply the Guide Number by the square root of two (approximately 1.4).

- Remote controls**
- Wireless Remote Control ML-L3** (☐ 65): The ML-L3 uses a 3 V CR2025 battery.

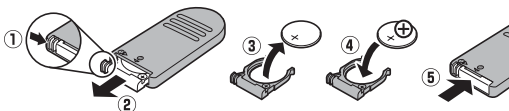

Pressing the battery-chamber latch to the right (①), insert a fingernail into the gap and open the battery chamber (②). Ensure that the battery is in the correct orientation (④).



Software	<p>Capture NX 2: A complete photo editing package offering such features as white balance adjustment and color control points.</p> <p>Note: Use the latest versions of Nikon software; see the websites listed on page xvii for the latest information on supported operating systems. At default settings, Nikon Message Center 2 will periodically check for updates to Capture NX 2 and other Nikon software and firmware while you are logged in to an account on the computer and the computer is connected to the Internet. A message is automatically displayed when an update is found.</p>
Body caps	<p>Body Cap BF-N1000: The body cap keeps the image sensor free of dust when a lens is not in place.</p>
Microphones	<p>Stereo Microphone ME-1 (☞ 147): Connect the ME-1 to the camera microphone jack to record stereo sound while reducing the noise caused by lens vibration being recorded during autofocus.</p>
GPS units	<p>GP-N100 (☞ 76): Record the time (UTC) and the camera's current latitude, longitude, and altitude with every picture taken.</p>
Wireless mobile adapters	<p>WU-1b (☞ 79): Create a wireless connection that can be used by smart devices running the Wireless Mobile Adapter Utility to download pictures or control the camera remotely.</p>



Approved Memory Cards

The following cards have been tested and approved for use in the camera. Cards with class 6 or faster write speeds are recommended for movie recording. Recording may end unexpectedly when cards with slower write speeds are used.

	SD cards	SDHC cards ²	SDXC cards ³
SanDisk	2 GB ¹	4 GB, 8 GB, 16 GB, 32 GB	64 GB
Toshiba			48 GB, 64 GB
Panasonic			—
Lexar Media	—	4 GB, 8 GB, 16 GB	—
Platinum II		4 GB, 8 GB, 16 GB, 32 GB	
Professional		4 GB, 8 GB, 16 GB	
Full-HD Video		4 GB, 8 GB, 16 GB	

- 1 Check that any card readers or other devices with which the card will be used support 2 GB cards.
- 2 Check that any card readers or other devices with which the card will be used are SDHC-compliant. The camera supports UHS-1.
- 3 Check that any card readers or other devices with which the card will be used are SDXC-compliant.  The camera supports UHS-1.





Other cards have not been tested. For more details on the above cards, please contact the manufacturer.



Approved Eye-Fi Cards

When inserted in the camera, Eye-Fi cards can be used to upload photographs to a preselected destination. As of September 2012, the camera supports 8 GB Pro X2 SDHC cards. Eye-Fi cards are for use only in the country of purchase in accordance with local regulations. Eye-Fi cards may not be available in some countries or regions; consult the manufacturer for more information. Be sure the Eye-Fi card firmware has been updated to the latest version.

Card status is indicated by an icon in the display:

-  (static): Eye-Fi upload enabled; waiting to begin upload.
-  (animated): Eye-Fi upload enabled; uploading data.
- : Eye-Fi upload enabled but no pictures available for upload.
- : Error.

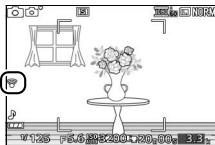

Eye-Fi Cards

Note that pictures will not be uploaded if signal strength is insufficient, and that Eye-Fi upload is disabled during movie recording. In locations in which wireless devices are prohibited, turn the camera off and remove the card. See the manual provided with the Eye-Fi card, and direct any inquiries to the manufacturer.



Attaching a Power Connector and AC Adapter

Turn the camera off before attaching an optional power connector and AC adapter.

1 Ready the camera.

Open the battery-chamber cover.

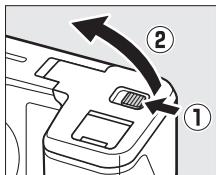

2 Insert the EP-5D power connector.

Be sure to insert the connector in the orientation shown, using the connector to keep the orange battery latch pressed to one side. The latch locks the connector in place when the connector is fully inserted.

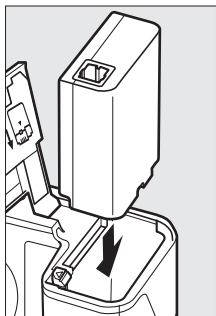

3 Close the battery-chamber cover.

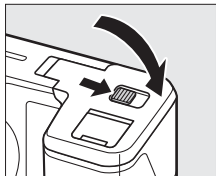

4 Connect the AC cable.

Connect the AC adapter AC cable to the AC socket on AC adapter.

5 Connect the DC cable.

Open the camera power connector cover and plug the AC adapter DC cable securely into the DC socket on the EP-5D. A  icon is displayed in the monitor when the camera is powered by the AC adapter and power connector.

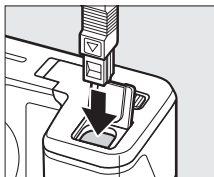

Storage and Cleaning

Storage

If the camera will not be used for an extended period, remove the battery and store it in a cool, dry area with the terminal cover in place. To prevent mold or mildew, store the camera in a dry, well-ventilated area. Do not store your camera with naphtha or camphor moth balls or in locations that:

- are poorly ventilated or subject to humidities of over 60%
- are next to equipment that produces strong electromagnetic fields, such as televisions or radios
- are exposed to temperatures above 50 °C (122 °F) or below -10 °C (14 °F)

Cleaning

Camera body	Use a blower to remove dust and lint, then wipe gently with a soft, dry cloth. After using the camera at the beach or sea-side, wipe off sand or salt with a cloth lightly dampened in distilled water and dry thoroughly. Important: <i>Dust or other foreign matter inside the camera may cause damage not covered under warranty.</i>
Lens, viewfinder	These elements are easily damaged. Remove dust and lint with a blower. If using an aerosol blower, keep the can vertical to prevent the discharge of liquid. To remove fingerprints and other stains, apply a small amount of lens cleaner to a soft cloth and clean with care.
Monitor	Remove dust and lint with a blower. When removing fingerprints and other stains, wipe the surface lightly with a soft cloth or chamois leather. Do not apply pressure, as this could result in damage or malfunction.

Do not use alcohol, thinner, or other volatile chemicals.



Caring for the Camera and Battery: Cautions

Do not drop: The product may malfunction if subjected to strong shocks or vibration. Physical shocks may also cause the shutter to malfunction.

Keep dry: This product is not waterproof, and may malfunction if immersed in water or exposed to high levels of humidity. Rusting of the internal mechanism can cause irreparable damage.

Avoid sudden changes in temperature: Sudden changes in temperature, such as those that occur when entering or leaving a heated building on a cold day, can cause condensation inside the device. To prevent condensation, place the device in a carrying case or plastic bag before exposing it to sudden changes in temperature.

Keep away from strong magnetic fields: Do not use or store this device in the vicinity of equipment that generates strong electromagnetic radiation or magnetic fields. Strong static charges or the magnetic fields produced by equipment such as radio transmitters could interfere with the displays, damage data stored on the memory card, or affect the product's internal circuitry.

Keep the lens mount covered: Be sure to attach the body cap if the camera is without a lens.

Do not touch the image sensor: The image sensor is easily damaged. Under no circumstances should you exert pressure on the sensor, poke it with cleaning tools, or subject it to powerful air currents from a blower. These actions could scratch or otherwise damage the sensor.

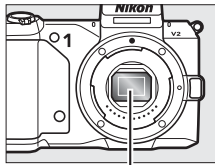

Image sensor

Turn the product off before removing or disconnecting the power source: Do not unplug the product or remove the battery while the product is on or while images are being recorded or deleted. Forcibly cutting power in these circumstances could result in loss of data or in damage to product memory or internal circuitry. To prevent an accidental interruption of power, avoid carrying the product from one location to another while the AC adapter is connected.



Cleaning: When cleaning the camera body, use a blower to gently remove dust and lint, then wipe gently with a soft, dry cloth. After using the camera at the beach or seaside, wipe off any sand or salt using a cloth lightly dampened in pure water and then dry the camera thoroughly.

The lens is easily damaged. Dust and lint should be gently removed with a blower. When using an aerosol blower, keep the can vertical to prevent discharge of liquid. To remove fingerprints and other stains from the lens, apply a small amount of lens cleaner to a soft cloth and wipe the lens carefully.

Storage: To prevent mold or mildew, store the camera in a dry, well-ventilated area. If you are using an AC adapter, unplug the adapter to prevent fire. If the product will not be used for an extended period, remove the battery to prevent leakage and store the camera in a plastic bag containing a desiccant. Do not, however, store the camera case in a plastic bag, as this may cause the material to deteriorate. Note that desiccant gradually loses its capacity to absorb moisture and should be replaced at regular intervals.

To prevent mold or mildew, take the camera out of storage at least once a month. Turn the camera on and release the shutter a few times before putting it away.

Store the battery in a cool, dry place. Replace the terminal cover before putting the battery away.

Notes on the monitor and viewfinder: These displays are constructed with extremely high precision; at least 99.99% of pixels are effective, with no more than 0.01% being missing or defective. Hence while these displays may contain pixels that are always lit (white, red, blue, or green) or always off (black), this is not a malfunction and has no effect on images recorded with the device.

Images in the monitor may be difficult to see in a bright light.

Do not apply pressure to the displays, as this could cause damage or malfunction. Dust or lint on the displays can be removed with a blower. Stains can be removed by wiping lightly with a soft cloth or chamois leather. Should the monitor or viewfinder break, care should be taken to avoid injury from broken glass and to prevent liquid crystal from the display touching the skin or entering the eyes and mouth.



Do not leave the lens pointed at the sun: Do not leave the lens pointed at the sun or other strong light source for an extended period. Intense light may cause the image sensor to deteriorate or produce a white blur effect in photographs.

Moiré: Moiré is an interference pattern created by the interaction of an image containing a regular, repeating grid, such as the pattern of weave in cloth or windows in a building, with the camera image sensor grid. In some cases, it may appear in the form of lines. If you notice moiré in your photographs, try changing the distance to the subject, zooming in and out, or changing the angle between the subject and the camera.

Lines: Noise in the form of lines may in rare cases appear in pictures of extremely bright or backlit subjects.

Batteries: Batteries may leak or explode if improperly handled. Observe the following precautions when handling batteries:

- Use only batteries approved for use in this equipment.
- Do not expose the battery to flame or excessive heat.
- Keep the battery terminals clean.
- Turn the product off before replacing the battery.
- Remove the battery from the camera or charger when not in use and replace the terminal cover. These devices draw minute amounts of charge even when off and could draw the battery down to the point that it will no longer function. If the battery will not be used for some time, insert it in the camera and run it flat before removing it and storing it in a location with an ambient temperature of 15 °C to 25 °C (59 °F to 77 °F; avoid hot or extremely cold locations). Repeat this process at least once every six months.
- Turning the camera on and off repeatedly when the battery is fully discharged will shorten battery life. Batteries that have been fully discharged must be charged before use.
- The internal temperature of the battery may rise while the battery is in use. Attempting to charge the battery while the internal temperature is elevated will impair battery performance, and the battery may not charge or charge only partially. Wait for the battery to cool before charging.
- Continuing to charge the battery after it is fully charged can impair battery performance.



- A marked drop in the time a fully charged battery retains its charge when used at room temperature indicates that it requires replacement. Purchase a new EN-EL21 battery.
- Charge the battery before use. When taking photographs on important occasions, ready a spare EN-EL21 battery and keep it fully charged. Depending on your location, it may be difficult to purchase replacement batteries on short notice. Note that on cold days, the capacity of batteries tends to decrease. Be sure the battery is fully charged before taking photographs outside in cold weather. Keep a spare battery in a warm place and exchange the two as necessary. Once warmed, a cold battery may recover some of its charge.
- Used batteries are a valuable resource; recycle in accord with local regulations.

Image Sensor Cleaning

Each time it is turned on or off, the camera performs image sensor cleaning to remove dust from the image sensor (note that operating camera controls before cleaning is complete interrupts this process, and that image sensor cleaning may be temporarily disabled if the camera is turned on and off several times in succession). Dust not removed by this method may appear in images recorded with the camera, in which case you should have the sensor cleaned by Nikon-authorized service personnel.

Servicing the Camera and Accessories

The camera is a precision device and requires regular servicing. Nikon recommends that the camera be inspected by the original retailer or Nikon-authorized service representative once every one to two years, and that it be serviced once every three to five years (note that fees apply to these services). Frequent inspection and servicing are particularly recommended if the camera is used professionally. Any accessories regularly used with the camera, such as lenses or optional flash units, should be included when the camera is inspected or serviced.



Available Settings



The following table lists the settings that can be adjusted in each mode.

📷 Auto, P, S, A, M, and 📷 Best Moment Capture Modes

	📷	P	S	A	M	📷
Exposure mode	—	—	—	—	—	—
Image quality	✓ ¹	✓ ¹	✓ ¹	✓ ¹	✓ ¹	✓
Image size ²	✓ ¹	✓ ¹	✓ ¹	✓ ¹	✓ ¹	✓
Continuous	✓	✓	✓	✓	✓	—
Silent photography	✓	✓	✓	✓	✓	✓
Number of shots saved	—	—	—	—	—	✓ ³
Frame rate	—	—	—	—	—	—
Movie settings	✓	✓	✓	✓	✓	—
Movie before/after	—	—	—	—	—	—
File format	—	—	—	—	—	—
Metering	—	✓ ¹	✓ ¹	✓ ¹	✓ ¹	—
White balance	—	✓	✓	✓	✓	—
ISO sensitivity	—	✓ ¹	✓ ¹	✓ ¹	✓ ¹	—
Picture Control	—	✓	✓	✓	✓	—
Custom Picture Control	—	✓	✓	✓	✓	—
Auto distortion control	✓ ¹	✓ ¹	✓ ¹	✓ ¹	✓ ¹	✓
Color space	✓ ¹	✓ ¹	✓ ¹	✓ ¹	✓ ¹	✓
Active D-Lighting	—	✓ ¹	✓ ¹	✓ ¹	✓ ¹	—
HDR	✓ ⁴	—	—	—	—	—
Long exposure NR	✓	✓	✓	✓	✓	—
High ISO noise reduction	✓	✓	✓	✓	✓	✓
Movie sound options	✓	✓	✓	✓	✓	—
Vibration reduction ⁵	✓	✓	✓	✓	✓	✓
Focus mode	—	✓ ¹	✓ ¹	✓ ¹	✓ ¹	—
AF-area mode	—	✓ ¹	✓ ¹	✓ ¹	✓ ¹	—
Face-priority	—	✓	✓	✓	✓	—
Built-in AF assist	✓	✓	✓	✓	✓	✓
Flash control ⁶	—	✓ ⁷	✓ ⁷	✓ ⁷	✓ ⁷	—
Flash compensation ⁶	—	✓ ⁷	✓ ⁷	✓ ⁷	✓ ⁷	—

Shooting menu



		P	S	A	M	
Focus area selection	—	✓	✓	✓	✓	—
Flexible program	—	✓ ¹	—	—	—	—
Other settings Autoexposure lock	—	✓	✓	✓	—	—
Focus lock	—	✓	✓	✓	✓	—
Self-timer	✓	✓	✓	✓	✓	—
Exposure compensation	✓	✓	✓	✓	—	—
Flash mode ⁶	✓	✓	✓	✓	✓	—
Advanced movie	—	—	—	—	—	—
Theme	—	—	—	—	—	—

1 Has no effect on movies recorded with movie-record button.

2 NEF (RAW) images fixed at 4608 × 3072.

3 Smart Photo Selector mode only.

4 Not available at image qualities of **NEF (RAW)** or **NEF (RAW) + JPEG fine**.

5 VR lenses only.

6 Available only when built-in flash is raised or optional flash unit is used.



7 Not available when  is selected for **Continuous/self-timer** and **15 fps**, **30 fps**, or **60 fps** is selected for **Continuous**.



■ ■ ■+ Advanced Movie and ■ Motion Snapshot Modes

		■+				■				
		P	S	A	M	SCENE*	P	S	A	M
Shooting menu	Exposure mode	✓	✓	✓	✓	✓	✓	✓	✓	✓
	Image quality	—	—	—	—	—	—	—	—	—
	Image size	—	—	—	—	—	—	—	—	—
	Continuous	—	—	—	—	—	—	—	—	—
	Silent photography	✓	✓	✓	✓	✓	✓	✓	✓	✓
	Number of shots saved	—	—	—	—	—	—	—	—	—
	Frame rate	✓ ¹	✓ ¹	✓ ¹	✓ ¹	—	—	—	—	—
	Movie settings	✓ ²	✓ ²	✓ ²	✓ ²	—	—	—	—	—
	Movie before/after	—	—	—	—	✓	✓	✓	✓	✓
	File format	—	—	—	—	✓	✓	✓	✓	✓
	Metering	✓ ²	✓ ²	✓ ²	✓ ²	—	✓	✓	✓	✓
	White balance	✓	✓	✓	✓	—	✓	✓	✓	✓
	ISO sensitivity	✓	✓	✓	✓	—	✓	✓	✓	✓
	Picture Control	✓	✓	✓	✓	—	✓	✓	✓	✓
	Custom Picture Control	✓	✓	✓	✓	—	✓	✓	✓	✓
	Auto distortion control	—	—	—	—	—	—	—	—	—
	Color space	—	—	—	—	—	—	—	—	—
	Active D-Lighting	—	—	—	—	—	—	—	—	—
	HDR	—	—	—	—	—	—	—	—	—
	Long exposure NR	—	—	—	—	—	—	—	—	—
	High ISO noise reduction	✓	✓	✓	✓	✓	✓	✓	✓	✓
	Movie sound options	✓ ²	✓ ²	✓ ²	✓ ²	✓	—	—	—	—
	Vibration reduction ³	✓	✓	✓	✓	✓	✓	✓	✓	✓
	Focus mode	✓	✓	✓	✓	—	—	—	—	—
	AF-area mode	✓ ²	✓ ²	✓ ²	✓ ²	—	✓	✓	✓	✓
	Face-priority	✓ ²	✓ ²	✓ ²	✓ ²	—	✓	✓	✓	✓
	Built-in AF assist	—	—	—	—	✓	✓	✓	✓	✓
	Flash control	—	—	—	—	—	—	—	—	—
	Flash compensation	—	—	—	—	—	—	—	—	—



										
		P	S	A	M		P	S	A	M
Other settings	Focus area selection	✓ ²	✓ ²	✓ ²	✓ ²	—	✓	✓	✓	✓
	Flexible program	—	—	—	—	—	—	—	—	—
	Autoexposure lock	✓	✓	✓	—	—	✓	✓	✓	—
	Focus lock	✓	✓	✓	✓	—	✓	✓	✓	✓
	Self-timer	✓	✓	✓	✓	—	—	—	—	—
	Exposure compensation	✓	✓	✓	—	—	✓	✓	✓	—
	Flash mode	—	—	—	—	—	—	—	—	—
	Advanced movie	✓	✓	✓	✓	—	—	—	—	—
	Theme	—	—	—	—	✓	✓	✓	✓	✓

1 Slow motion selected in advanced movie mode.

2 HD movie selected in advanced movie mode.

3 VR lenses only.



Defaults

Defaults for the options in the playback, shooting, and setup menus may be found on pages 109, 119, and 159, respectively. Defaults for other settings are listed below.

Option	Default
Focus area (☐ 153)	Center*
Flexible program (☐ 34)	Off
Autoexposure lock (☐ 129)	Off
Focus lock (☐ 154)	Off
Continuous/self-timer (☐ 63)	 (single frame)
Exposure compensation (☐ 68)	0.0
Flash mode (☐ 69)	Fill flash
Best moment capture (☐ 43)	Slow view
Advanced movie (☐ 49)	HD movie
Theme (☐ 61)	Beauty
Picture Control settings (☐ 136)	Unmodified

*Not displayed when **Auto-area** is selected for **AF-area mode**.



Memory Card Capacity

The following table shows the number of pictures or amount of movie footage that can be stored on a 16 GB Toshiba SD-E016GUX UHS-I SDHC card at different image quality, size, or movie settings. All figures are approximate; file size varies with the scene recorded.

■ ■ ■ Auto, P, S, A, M, Slow View, and Smart Photo Selector¹

Image quality (□ 123)	Image size (□ 123)	File size	No. of images	Buffer capacity ²
NEF (RAW) + JPEG fine ³	4608 × 3072	26.6 MB	591	48
	3456 × 2304	23.1 MB	682	48
	2304 × 1536	20.5 MB	766	49
NEF (RAW)	—	17.4 MB	902	50
JPEG fine	4608 × 3072	9.2 MB	1700	54
	3456 × 2304	5.6 MB	2700	60
	2304 × 1536	3.1 MB	5000	71
JPEG normal	4608 × 3072	4.6 MB	3300	63
	3456 × 2304	2.9 MB	5400	76
	2304 × 1536	1.6 MB	9800	98
JPEG basic	4608 × 3072	2.4 MB	6600	80
	3456 × 2304	1.5 MB	10700	100
	2304 × 1536	0.8 MB	18600	100

1 Off selected for **Silent photography** and **Number of shots saved** set to 1.

2 Maximum number of pictures that can be stored in memory buffer at ISO 160. Drops if long exposure noise reduction is on (□ 146).

3 Image size applies to JPEG images only. Size of NEF (RAW) images can not be changed. File size is the total for NEF (RAW) and JPEG images.



Smart Photo Selector¹

Image quality (📖 123)	Image size (📖 123)	File size	No. of shots
NEF (RAW) + JPEG fine ²	4608 × 3072	133.1 MB	118
	3456 × 2304	115.4 MB	136
	2304 × 1536	102.7 MB	153
NEF (RAW)	—	87.1 MB	180
JPEG fine	4608 × 3072	45.9 MB	342
	3456 × 2304	28.2 MB	557
	2304 × 1536	15.6 MB	1000
JPEG normal	4608 × 3072	23.2 MB	679
	3456 × 2304	14.3 MB	1000
	2304 × 1536	8.0 MB	1900
JPEG basic	4608 × 3072	11.8 MB	1300
	3456 × 2304	7.4 MB	2100
	2304 × 1536	4.2 MB	3700

1 Number of shots saved set to 5. File size is total for 5 images.

2 Image size applies to JPEG images only. Size of NEF (RAW) images can not be changed. File size is the total for NEF (RAW) and JPEG images.

HD Movies

Movie settings (📖 126)	Maximum total length (approx.) [*]
1080/60i	1 hour 28 minutes
1080/30p	1 hour 28 minutes
720/60p	2 hours 12 minutes
720/30p	2 hours 56 minutes

*For information on the maximum length that can be recorded in a single clip, see page 126.

Slow Motion Movies

Frame rate (📖 125)	Maximum total recorded length (approx.) [*]
400 fps	1 hour 4 minutes
1200 fps	2 hours 8 minutes

*Up to 3 s of slow motion footage can be recorded in a single clip. Playback length is about 13.2 (**400 fps**) or 40 (**1200 fps**) times the recorded length.

Motion Snapshots

Image quality	Image size	Format (📖 128)	File size	No. of shots
—	—	NMS	21.6 MB [*]	729
—	—	MOV	30.8 MB	510

*File size is the total for a single photograph and movie.



Troubleshooting

If the camera fails to function as expected, check this list of common problems before consulting your retailer or Nikon representative.

Battery/Display

The camera is on but does not respond: Wait for recording or any other processing to end. If the problem persists, turn the camera off. If the camera still does not respond, remove and replace the battery or disconnect and reconnect the AC adapter, but note that this will delete any data not yet saved. Data already saved to the memory card are unaffected.

The displays are off:

- The camera is off (☐ 18) or the battery is exhausted (☐ 12, 21).
 - The monitor has been turned off (☐ 5). Press the DISP button to turn the monitor on.
 - An object has come close to the eye sensor, turning the viewfinder on and the monitor off (☐ 6).
 - The displays have turned off automatically to save power (☐ 162). The displays can be reactivated by operating buttons or the mode dial.
 - The camera is connected to a computer (☐ 95) or television (☐ 100).
-

The displays turn off without warning:

- The battery is low (☐ 12, 21).
 - The displays have turned off automatically to save power (☐ 162). The displays can be reactivated by operating buttons or the mode dial.
 - The camera's internal temperature is high (☐ xvi, 194). Wait for the camera to cool before turning it on again.
-

The viewfinder is out of focus: Focus the viewfinder using the diopter adjustment control (☐ 6).

Indicators are not displayed: Press the DISP button (☐ 5).



Shooting (All Modes)

The camera takes time to turn on: Delete files or format the memory card.

The shutter-release is disabled:

- The battery is exhausted (☐ 12, 21).
 - The memory card is locked (☐ 15) or full (☐ 21).
 - The flash is charging (☐ 69).
 - The camera is not in focus (☐ 24).
 - You are currently filming a slow motion movie (☐ 51).
-

Only one picture is taken each time the shutter-release button is pressed in continuous release mode: 5 fps is selected for **Continuous** and the built-in flash is raised.

The camera does not focus automatically:

- The subject is not suited to autofocus (☐ 150).
 - The camera is in manual focus mode (☐ 149, 151).
-

Focus does not lock when the shutter-release button is pressed halfway: Use the ▲ (AF-L) button to lock focus when **AF-C** is selected for focus mode or when photographing moving subjects in **AF-A** mode (☐ 149, 154).

Focus area selection is unavailable: Focus area selection is not available in auto-area AF (☐ 153) or face priority (☐ 27). In other AF-area modes, the focus area can be selected by pressing .

Subject-tracking AF not available: Select a non-monochrome Picture Control (☐ 136, 153).

AF-area mode selection is unavailable: The camera is in auto or best moment capture mode (☐ 41), manual focus mode is selected (☐ 149), or the  **Scene auto selector** is used (☐ 122).

Scene auto selector is used (☐ 122).

Image size selection is unavailable: **NEF (RAW)** is selected for image quality (☐ 123).

The camera is slow to record photos: Turn long exposure noise reduction off (☐ 146).

Noise (bright spots, randomly-spaced bright pixels, fog, or lines) appears in photos:

- Lower ISO sensitivity or enable high ISO noise reduction (☐ 146).
 - Use long exposure noise reduction at shutter speeds slower than 1 s (☐ 146).
-

No photo taken when ML-L3 remote control shutter-release button is pressed:

- Replace battery in remote control (☐ 170).
 - Choose a remote control mode (☐ 63).
 - The remote control standby timer has expired (☐ 163).
 - The remote is not pointed at the camera or the infrared receiver is not visible (☐ 2, 66).
 - The remote is too far from the camera (☐ 66).
 - Bright light is interfering with remote.
-



Smudges appear in photographs: Clean the front and rear lens elements.

Flicker or banding appears in movies or in the displays: Choose a **Flicker reduction** setting that matches the local AC power supply (☞ 164).

No flash: The camera is in best moment capture or Motion Snapshot mode or is recording a movie, or  is selected for **Continuous/self-timer** (☞ 63) and the **Continuous** is 15 fps or above (☞ 125).

Menu items are unavailable: Some options are only available in particular shooting or exposure modes (☞ 181) or when the built-in flash is raised (☞ 69) or a flash, GPS unit, or wireless mobile adapter is attached (☞ 72, 76, 79).

Shooting (P, S, A, and M Modes)

The shutter release is disabled: You selected mode **S** after choosing a shutter speed of “Bulb” in mode **M** (☞ 35).

Some shutter speeds are not available: You are using a flash.

Colors are unnatural:

- Adjust white balance to match the light source (☞ 130).
- Adjust Picture Control settings (☞ 136).

Cannot measure white balance: The subject is too dark or too bright (☞ 133).

Picture Controls produce varying results: **A** (auto) is selected for sharpening, contrast, or saturation. For consistent results over a series of photos, choose another setting (☞ 138).

Metering can not be changed: Exposure lock is in effect (☞ 129).

Noise (reddish areas and other artifacts) appears in long time-exposures: Enable long-exposure noise reduction (☞ 146).

Movies

Cannot record movies: The movie-record button can not be used to record movies in best moment capture or Motion Snapshot mode (☞ 48, 61).

No sound is recorded for movies:

- **Microphone off** is selected for **Movie sound options > Microphone** (☞ 147).
- Live audio is not recorded with slow-motion movies (☞ 53) or Motion Snapshots (☞ 59).



Playback

NEF (RAW) images are not displayed: The camera displays only the JPEG copies of NEF (RAW) + JPEG fine images (☞ 123).

“Tall” (portrait) orientation photos are displayed in “wide” (landscape) orientation:

- Select **On** for **Rotate tall** (☞ 112).
- The photos were taken with **Auto image rotation** off (☞ 166).
- Camera was pointed up or down when the photo was taken (☞ 166).
- Photo is displayed in image review (☞ 112).

Cannot hear movie sound:

- Rotate the command dial right to raise the volume (☞ 56). If the camera is connected to a television (☞ 100), use the controls for the TV to adjust the volume.
- Live audio is not recorded with slow-motion movies (☞ 53) or Motion Snapshots (☞ 61).

Cannot delete images:

- Remove protection from the files before deletion (☞ 112).
- The memory card is locked (☞ 15).

Cannot select photos for printing: The memory card is full (☞ 21) or locked (☞ 15) or the photos are in NEF (RAW) format. To print NEF (RAW) photos, transfer the pictures to a computer and use the supplied software or Capture NX 2 (☞ 95).

Pictures are not displayed on TV: The camera is not correctly connected (☞ 100).

Pictures cannot be transferred to a computer: If your system does not meet the requirements on page 93, you may still be able to transfer pictures to the computer using a card reader.

Photos are not displayed in Capture NX 2: Update to the latest version (☞ 171).

Miscellaneous

The date of recording is not correct: Set the camera clock (☞ 19, 165).

Menu items are unavailable: Some options are only available at particular settings (☞ 181) or when a memory card is inserted (☞ 14).



Error Messages

This section lists the error messages that appear in the display.

Message	Solution	
(Shutter-speed or aperture display flashes)	If the subject is too bright, lower ISO sensitivity or choose a faster shutter speed or smaller aperture (higher f-number).	35, 36, 37, 135
	If the subject is too dark, raise ISO sensitivity, use a flash, or choose a slower shutter speed or larger aperture (lower f-number).	35, 36, 37, 69, 72, 135
Keeping the zoom ring button pressed, rotate the zoom ring to extend the lens.	A lens with a retractable lens barrel button is attached with the lens barrel retracted. Press the retractable lens barrel button and rotate the zoom ring to extend the lens.	17, 202
Check lens. Pictures can only be taken when a lens is attached.	Attach a lens.	17
Cannot take pictures. Insert fully-charged battery.	Turn the camera off and recharge the battery or insert a fully charged spare battery.	12, 14
Start-up error. Turn the camera off and then on again.	Turn the camera off, remove and replace the battery, and then turn the camera on.	14, 18
The clock has been reset.	Set the camera clock.	19, 165
No memory card.	Turn the camera off and confirm that the card is correctly inserted.	14
This memory card is not formatted. Format the memory card?	Select Yes to format the card, or turn the camera off and insert another memory card.	14, 161
Memory card is locked (write protected).	Turn the camera off and slide the card write-protect switch to the "write" position.	15



Message	Solution	
Eye-Fi cards cannot be used with the write protect switch in the "lock" position.	Turn the camera off and slide the card write-protect switch to the "write" position.	173
Memory card is full.	<ul style="list-style-type: none"> You may be able to record additional images if you reduce image quality or size. 	123
	<ul style="list-style-type: none"> Delete unwanted images. Insert another memory card. 	87 14, 172
	<ul style="list-style-type: none"> Use an approved card. Format the card. If the problem persists, the card may be damaged. Contact a Nikon-authorized service representative. Insert a new memory card. 	172 161 14, 172
This memory card cannot be used. Card may be damaged; insert a different card.		
Cannot create additional folders on memory card.	If the current folder is numbered 999 and contains either 999 photographs or a photograph numbered 9999, the shutter-release button will be disabled and no further photographs can be taken. Choose Yes for Reset file numbering and then either format the current memory card or insert a new memory card.	164
The movie-record button cannot be used in this mode.	The movie-record button can not be used in best moment capture or Motion Snapshot modes.	48, 61
Photographs cannot be recorded in this mode.	The shutter-release button can not be used to take photographs while a slow-motion movie is being recorded.	51
The capture illuminator has been used consecutively for the maximum time and has turned off.	The capture illuminator on the optional SB-N5 flash unit turns off automatically after extended use. Remove your finger from the shutter-release button for a short period.	74
Photographs cannot be taken in shutter-priority auto mode at a shutter speed of "Bulb".	Choose a different shutter speed, or select mode M.	35, 37



Message	Solution	
Failed to update speedlight firmware. Try again after turning the camera off and on.	Turn the camera off and then on again and reattempt the update. If the problem persists or reoccurs frequently, contact a Nikon-authorized service representative.	—
Failed to update lens firmware. Try again after turning the camera off and on.	Turn the camera off and then on again and reattempt the update. If the problem persists or reoccurs frequently, contact a Nikon-authorized service representative.	—
An error has occurred. Press the shutter-release button again.	Press the shutter-release button. Contact a Nikon-authorized service representative if the problem persists or reoccurs frequently.	—
An error has occurred in the internal circuitry. Try again after turning the camera off and on.	Turn the camera off and then on again. If the problem persists or reoccurs frequently, contact a Nikon-authorized service representative.	—
The camera's internal temperature is high. The camera will now turn off.	Wait for the camera to cool.	xvi
Memory card contains no images.	To view pictures, insert a memory card containing images.	14
Cannot display this file.	The file has been created or modified on a computer or different make of camera, or is corrupt.	—
Check printer.	Check the printer.	—*
Check paper.	Select Resume after loading paper of the correct size.	—*
Paper jam.	Clear the jam and select Resume .	—*
Out of paper.	Insert paper and select Resume .	—*
Check ink supply.	Select Resume after checking the ink.	—*
Out of ink.	Replace the ink and select Resume .	—*

* See the printer manual for more information.











Specifications



Nikon 1 V2 Digital Camera

Type	
Type	Digital camera with support for interchangeable lenses
Lens mount	Nikon 1 mount
Effective angle of view	Approx. 2.7× lens focal length (35 mm format equivalent)
Effective pixels	14.2 million
Image sensor	
Image sensor	13.2 mm × 8.8 mm CMOS sensor (Nikon CX format)
Dust-reduction system	Image sensor cleaning
Storage	
Image size (pixels)	Still images (M, P, S, A, M, L modes; aspect ratio 3 : 2)
	<ul style="list-style-type: none"> • 4608 × 3072 • 2304 × 1536
	<ul style="list-style-type: none"> • 3456 × 2304
	Still images (L mode; aspect ratio 3 : 2)
	<ul style="list-style-type: none"> • 4608 × 3072 (1080/60i, 1080/30p) • 1280 × 856 (720/60p, 720/30p)
	Still images (Motion Snapshots; aspect ratio 16 : 9)
	4608 × 2592
File format	<ul style="list-style-type: none"> • NEF (RAW): 12-bit, compressed • JPEG: JPEG-Baseline compliant with fine (approx. 1 : 4), normal (approx. 1 : 8), or basic (approx. 1 : 16) compression • NEF (RAW) + JPEG: Single photograph recorded in both NEF (RAW) and JPEG formats
Picture Control system	Standard, Neutral, Vivid, Monochrome, Portrait, Landscape; selected Picture Control can be modified; storage for custom Picture Controls
Media	SD (Secure Digital), SDHC, and SDXC memory cards
File system	DCF (Design Rule for Camera File System) 2.0, DPOF (Digital Print Order Format), Exif (Exchangeable Image File Format for Digital Still Cameras) 2.3, PictBridge



Electronic viewfinder	
Electronic viewfinder	0.47-in., approx. 1440k-dot color TFT LCD viewfinder with diopter control and brightness adjustment
Frame coverage	Approx. 100% horizontal and 100% vertical
Eyepoint	18 mm (-1.0 m^{-1} ; from center surface of viewfinder eyepiece lens)
Diopter adjustment	-3 – $+2 \text{ m}^{-1}$
Eye sensor	Camera switches to viewfinder display when it detects that viewfinder is in use
Shooting modes	
	 auto,  programmed auto,  shutter-priority auto,  aperture-priority auto,  manual,  best moment capture (slow view and Smart Photo Selector),  advanced movie (HD and slow motion),  Motion Snapshot
Shutter	
Type	Electronically-controlled vertical-travel focal-plane mechanical shutter; electronic shutter
Speed	<ul style="list-style-type: none"> • Mechanical shutter: $\frac{1}{4000}$–30 s in steps of $\frac{1}{3}$ EV; Bulb; Time (requires optional ML-L3 remote control) • Electronic shutter: $\frac{1}{6,000}$–30 s in steps of $\frac{1}{3}$ EV; Bulb; Time (requires optional ML-L3 remote control) Note: Bulb and Time end automatically after approximately 2 minutes
Flash sync speed	<ul style="list-style-type: none"> • Mechanical shutter: Synchronizes with shutter at $X=\frac{1}{250}$ s or slower • Electronic shutter: Synchronizes with shutter at $X=\frac{1}{60}$ s or slower
Release	
Mode	<ul style="list-style-type: none"> • Single frame, continuous • Self-timer, remote
Frame advance rate	Approximately 5, 15, 30, or 60 fps
Self-timer	2 s, 10 s
Remote control modes	Delayed remote (2 s); quick-response remote



Exposure	
Metering	TTL metering using image sensor
Metering method	<ul style="list-style-type: none"> • Matrix • Center-weighted: Meters 4.5 mm circle in center of frame • Spot: Meters 2 mm circle centered on selected focus area
Mode	P programmed auto with flexible program; S shutter-priority auto; A aperture-priority auto; M manual;  scene auto selector
Exposure compensation	-3 – +3 EV in increments of 1/3 EV (user controlled in P, S, and A modes)
Exposure lock	Luminosity locked at metered value with  (AE-L/AF-L) button
ISO sensitivity (Recommended Exposure Index)	ISO 160–6400 in steps of 1 EV; auto ISO sensitivity control (ISO 160–6400, 160–3200, 160–800) available (user controlled in P, S, A, and M modes)
Active D-Lighting	On, off
Focus	
Autofocus	Hybrid autofocus (phase detection/contrast-detect AF); AF-assist illuminator
Lens servo	<ul style="list-style-type: none"> • Autofocus (AF): Single AF (AF-S); continuous AF (AF-C); auto AF-S/AF-C selection (AF-A); full-time AF (AF-F) • Manual focus (MF)
AF-area mode	Single-point, auto-area, subject tracking
Focus area	<ul style="list-style-type: none"> • Single-point AF: 135 focus areas; the center 73 areas support phase-detection AF • Auto-area AF: 41 focus areas
Focus lock	Focus can be locked by pressing shutter-release button halfway (single AF) or by pressing  (AE-L/AF-L) button
Face priority	On, off



Flash	
Built-in flash	Raised by pressing flash button
Guide Number (GN)	Approx. 5/16 (m/ft, ISO 100, 20 °C/68 °F; at ISO 160, Guide Number is approx. 6.3/20.7)
Control	i-TTL flash control using image sensor
Mode	Fill flash, fill flash + slow sync, red-eye reduction, red-eye reduction + slow sync, rear-curtain sync, rear curtain + slow sync
Flash compensation	-3–+1 EV in increments of 1/3 EV
Flash-ready indicator	Lights when flash is fully charged
White balance	
	Auto, incandescent, fluorescent, direct sunlight, flash, cloudy, shade, preset manual, all except preset manual with fine tuning
Movie	
Metering	TTL metering using image sensor
Metering method	<ul style="list-style-type: none"> • Matrix • Center-weighted: Meters 4.5 mm circle in center of frame • Spot: Meters 2 mm circle centered on selected focus area
Frame size (pixels)/ recording rate	HD movies and movies recorded in , P, S, A, and M modes (aspect ratio 16 : 9) <ul style="list-style-type: none"> • 1920 × 1080/60i (59.94 fields/s*) • 1920 × 1080/30p (29.97 fps) • 1280 × 720/60p (59.94 fps) • 1280 × 720/30p (29.97 fps) Slow-motion movies (aspect ratio 8 : 3) <ul style="list-style-type: none"> • 640 × 240/400 fps (plays at 30p/29.97 fps) • 320 × 120/1200 fps (plays at 30p/29.97 fps) Motion Snapshot (aspect ratio 16 : 9) <ul style="list-style-type: none"> • 1920 × 1080/60p (59.94 fps) (plays at 24p/23.976 fps)
File format	MOV
Video compression	H.264/MPEG-4 Advanced Video Coding
Audio recording format	AAC
Audio recording device	Built-in or optional external ME-1 stereo microphone; sensitivity adjustable

* Sensor output is about 60 fps.



Monitor	7.5 cm (3-in.), approx. 921k-dot, TFT LCD with brightness adjustment
Playback	Full-frame and thumbnail (4, 9, or 72 images or calendar) playback with playback zoom, movie playback, slide show, histogram display, auto image rotation, and rating option
Interface	
USB	Hi-Speed USB
HDMI output	Type C mini-pin HDMI connector
Multi accessory port	Used for designated accessories
Audio input	Stereo mini-pin jack (3.5 mm diameter)
Supported languages	Arabic, Chinese (Simplified and Traditional), Czech, Danish, Dutch, English, Finnish, French, German, Greek, Hindi, Hungarian, Indonesian, Italian, Japanese, Korean, Norwegian, Polish, Portuguese (European and Brazilian), Romanian, Russian, Spanish, Swedish, Thai, Turkish, Ukrainian, Vietnamese
Power source	
Battery	One rechargeable Li-ion EN-EL21 battery
AC adapter	EH-5b AC adapter; requires EP-5D power connector (available separately)
Tripod socket	1/4-in. (ISO 1222)
Dimensions/weight	
Dimensions (W × H × D)	Approx. 107.8 × 81.6 × 45.9 mm (4.2 × 3.2 × 1.8 in.), excluding projections; thickness of body (from mount to monitor) is 33.2 mm (1.3 in.)
Weight	Approx. 337 g (11.9 oz) with battery and memory card but without body cap; approx. 278 g (9.8 oz), camera body only



Operating environment	
Temperature	0 °C–40 °C (+32 °F–104 °F)
Humidity	85% or less (no condensation)

- Unless otherwise stated, all figures are for a camera with a fully-charged battery operating at the temperature specified by the Camera and Imaging Products Association (CIPA): 23 ±3 °C (73.4 ±5.4 °F).
- Nikon reserves the right to change the specifications of the hardware and software described in this manual at any time and without prior notice. Nikon will not be held liable for damages that may result from any mistakes that this manual may contain.

MH-28 battery charger	
Rated input	AC 100–240 V, 50–60 Hz, 0.2 A
Rated output	DC 8.4 V/0.6 A
Supported batteries	Nikon EN-EL21 rechargeable Li-ion batteries
Charging time	Approx. 2 hours at an ambient temperature of 25 °C (77 °F) when no charge remains
Operating temperature	0 °C–40 °C (+32 °F–104 °F)
Dimensions (W × H × D)	Approx. 67.0 × 28.0 × 104.0 mm (2.6 × 1.1 × 4.1 in.), excluding plug adapter
Weight	Approx. 88 g (3.1 oz), excluding plug adapter

EN-EL21 rechargeable Li-ion battery	
Type	Rechargeable lithium-ion battery
Rated capacity	7.2 V, 1485 mAh
Operating temperature	0 °C–40 °C (+32 °F–104 °F)
Dimensions (W × H × D)	Approx. 37.6 × 49.7 × 18.1 mm (1.5 × 2.0 × 0.7 in.)
Weight	Approx. 57 g (2.0 oz), excluding terminal cover



1 NIKKOR VR 10–30mm f/3.5–5.6	
Type	1 mount lens
Focal length	10–30 mm
Maximum aperture	f/3.5–5.6
Construction	12 elements in 9 groups (including 3 aspherical elements)
Angle of view	77°–29° 40'
Vibration reduction	Lens shift using voice coil motors (VCMs)
Minimum focus distance	0.2 m (0.7 ft) from focal plane at all zoom positions
Diaphragm blades	7 (rounded diaphragm opening)
Diaphragm	Fully automatic
Aperture range	<ul style="list-style-type: none"> • 10 mm focal length: f/3.5–16 • 30 mm focal length: f/5.6–16
Filter-attachment size	40.5 mm (P=0.5 mm)
Dimensions	Approx. 57.5 mm diameter × 42 mm (distance from camera lens mount flange when lens is retracted)
Weight	Approx. 115 g (4.1 oz)

1 NIKKOR 11–27.5mm f/3.5–5.6	
Type	1 mount lens
Focal length	11–27.5 mm
Maximum aperture	f/3.5–5.6
Construction	8 elements in 6 groups (including 1 ED lens element and 1 aspherical lens element), 1 protective glass element
Angle of view	72°–32° 20'
Minimum focus distance	0.3 m (1.0 ft) from focal plane at all zoom positions
Diaphragm blades	7 (rounded diaphragm opening)
Diaphragm	Fully automatic
Aperture range	<ul style="list-style-type: none"> • 11 mm focal length: f/3.5–16 • 27.5 mm focal length: f/5.6–16
Filter-attachment size	40.5 mm (P=0.5 mm)
Dimensions	Approx. 57.5 mm diameter × 31 mm (distance from camera lens mount flange when lens is retracted)
Weight	Approx. 83 g (3.0 oz)

Specifications subject to change without notice. Nikon will not be held liable for damages that may result from any mistakes that this manual may contain.



■ 1 NIKKOR Lenses

1 NIKKOR VR 10–30mm f/3.5–5.6

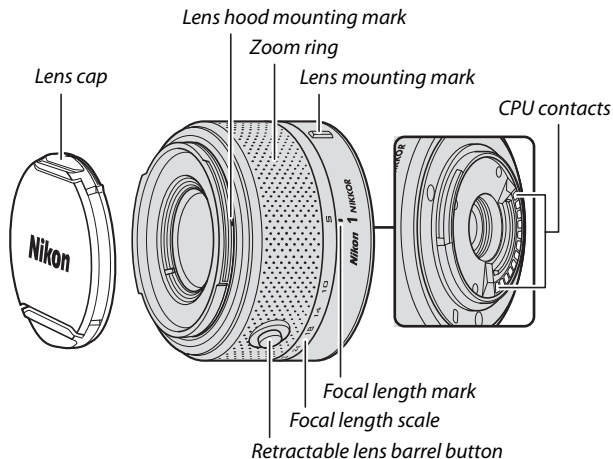

1 NIKKOR 11–27.5mm f/3.5–5.6

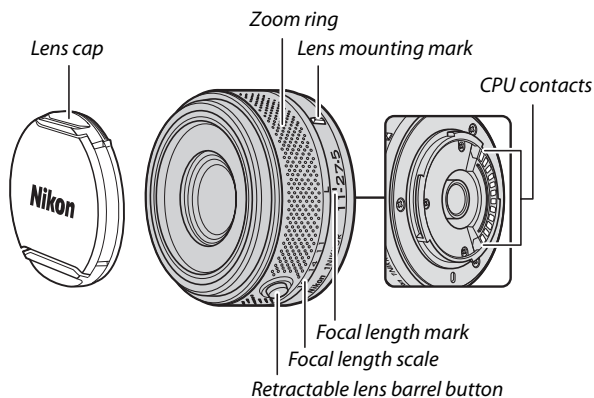

1 NIKKOR lenses are exclusively for Nikon 1 interchangeable lens format digital cameras. The angle of view is equivalent to a 35 mm format lens with a focal length about 2.7× longer. The 1 NIKKOR VR 10–30mm f/3.5–5.6 supports normal and active vibration reduction and vibration reduction off (☐ 148).

Use the zoom ring to zoom in and out.

Detaching the Lens

Before removing or exchanging lenses, retract the lens and turn the camera off (☐ 17). To remove the lens, press and hold the lens release button (①) while turning the lens clockwise (②). After removing the lens, replace the lens caps and camera body cap.

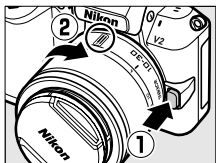

Lens Care

- When using an optional lens hood, do not pick up or hold the lens or camera using only the hood.
- Keep the CPU contacts clean.
- Use a blower to remove dust and lint from the lens surfaces. To remove smudges and fingerprints, apply a small amount of ethanol or lens cleaner to a soft, clean cotton cloth or lens-cleaning tissue and clean from the center outwards using a circular motion, taking care not to leave smears or touch the glass with your fingers.
- Never use organic solvents such as paint thinner or benzene to clean the lens.
- A lens hood or NC filter can be used to protect the front lens element.
- Attach the front and rear caps when the lens is not in use.
- If the lens will not be used for an extended period, store it in a cool, dry location to prevent mold and rust. Do not store in direct sunlight or with naphtha or camphor moth balls.
- Keep the lens dry. Rusting of the internal mechanism can cause irreparable damage.
- Leaving the lens in extremely hot locations could damage or warp parts made from reinforced plastic.



Supplied Accessories

- 40.5 mm snap-on Front Lens Cap LC-N40.5
- Rear Lens Cap LF-N1000

Optional Accessories

- 40.5 mm screw-on filters
- Bayonet Hood HB-N101 (for use with the 1 NIKKOR VR 10–30mm f/3.5–5.6; attaches as shown below).

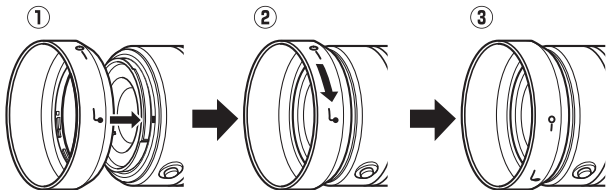

- 40.5 mm screw-on Hood HN-N102 (for use with the 1 NIKKOR 11–27.5mm f/3.5–5.6; attaches as shown below)

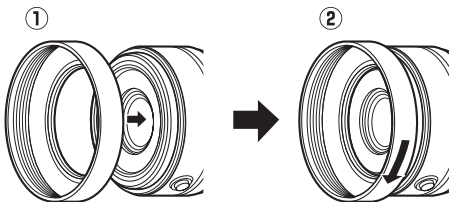

■ The Optional FT1 Mount Adapter

Read this section for information on using the optional FT1 mount adapter. Before proceeding, be sure that you have read and understood this manual and the documentation for the FT1 and lenses.

Autofocus

Autofocus is available only with AF-S lenses; other lenses support manual focus only. Set the camera focus mode to **AF-S** (the camera will not focus in other autofocus modes). The only AF-area mode available is **Single-point** and the camera focuses on the subject in the center focus area only. Face priority is not supported. In some cases, a beep may sound, the in-focus indicator may be displayed, and pictures can be taken when the camera is not in focus; if this occurs, focus manually.

Manual Focus

Follow the steps below to focus manually when using the FT1 with a NIKKOR F mount lens.

1 Select manual focus mode.

Select **Manual focus** for **Focus mode** in the shooting menu.

2 Focus.

Rotate the lens focus ring until the subject is in focus.

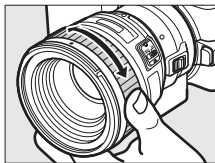

If the lens supports autofocus with manual override, after focusing using autofocus you can keep the shutter-release button pressed halfway and rotate the lens focus ring to fine-tune focus manually. To refocus using autofocus, press the shutter-release button halfway again.



To zoom in on the display for more precise focus, press  (note that this feature is not available during movie recording or in slow-motion movie mode). A navigation window will appear in a gray frame at the bottom right of the display.

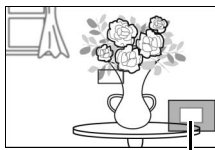

Navigation window

Rotate the command dial right to zoom in to a maximum of 10 \times , left to zoom out. Use the multi selector to scroll to areas of the frame not visible in the display. Press  to exit zoom.

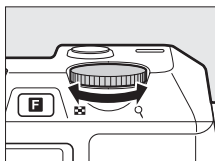

Command dial

The Electronic Rangefinder

If a CPU lens is attached in manual focus mode, the focus indicator can be used to check whether the camera is focused on the subject in the center focus area.

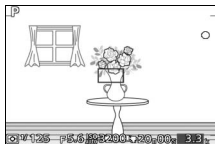

Focus indicator	Status
●	In focus.
▶	Camera focused in front of subject.
◀	Camera focused behind subject.
▶ ◀ (flashes)	Unable to determine focus.

Note that with some subjects, the in-focus indicator (●) may be displayed when the camera is not in focus. Check focus in the display before shooting.



Error Messages and Displays

The following warnings appear in the camera aperture display.

Display	Problem	Solution
FEE	Lens aperture ring is not locked at minimum aperture.	When using CPU lenses, lock aperture ring at minimum aperture (highest f-number).
F---	Non-CPU lens is attached, or no lens is attached.	When using non-CPU lens, rotate lens aperture ring to adjust aperture.

Restrictions

- Auto and best moment capture modes are not supported.
- Motion Snapshots can be recorded only when an AF-S lens is attached and **AF-S (Single AF)** is selected for focus mode and then only when the camera is in focus. Do not attempt to adjust focus using the focus ring.
- Shutter speeds of 1 s or slower are not available.
- The sound monitor switch and focus operation button (Focus Lock/MEMORY RECALL/AF Start) have no effect.

Precautions for Use

- Lenses over 380 g (13.4 oz) should be supported at all times. Do not hold the camera or carry the camera by the strap without supporting the lens. Failure to observe this precaution could damage the camera lens mount.
- Lines may appear in photographs taken with non-CPU lenses stopped down to minimum aperture.
- The camera continues to adjust exposure during movie recording. Select mode **A** or **M** to prevent sounds made by the lens being picked up by the microphone.
- During continuous shooting, focus is fixed at the position for the first shot in each burst. Frame rates will slow when **5 fps** is selected for **Continuous**.



- Certain lenses will block the AF-assist illuminator and, at some distances, the flash.
- The tops and bottoms may be missing from circular *bokeh* shapes created at wide apertures using lenses with a maximum aperture of f/1.4.

■ Supported Standards

- **DCF Version 2.0:** The Design Rule for Camera File Systems (DCF) is a standard widely used in the digital camera industry to ensure compatibility among different makes of camera.
- **DPOF:** Digital Print Order Format (DPOF) is an industry-wide standard that allows pictures to be printed from print orders stored on the memory card.
- **Exif version 2.3:** The camera supports Exif (Exchangeable Image File Format for Digital Still Cameras) version 2.3, a standard in which information stored with photographs is used for optimal color reproduction when the images are output on Exif-compliant printers.
- **PictBridge:** A standard developed through cooperation with the digital camera and printer industries, allowing photographs to be output directly to a printer without first transferring them to a computer.
- **HDMI:** High-Definition Multimedia Interface is a standard for multimedia interfaces used in consumer electronics and AV devices capable of transmitting audiovisual data and control signals to HDMI-compliant devices via a single cable connection.



Trademark Information

Macintosh, Mac OS, and QuickTime are registered trademarks of Apple Inc. in the United States and/or other countries. Microsoft, Windows, and Windows Vista are either registered trademarks, or trademarks of Microsoft Corporation in the United States and/or other countries. The PictBridge logo is a trademark. Google Play is a trademark of Google Inc. The SD, SDHC, and SDXC logos are trademarks of SD-3C, LLC. HDMI, the HDMI logo and High-Definition Multimedia Interface are trademarks or registered trademarks of HDMI Licensing LLC.

HDMI

All other trade names mentioned in this manual or the other documentation provided with your Nikon product are trademarks or registered trademarks of their respective holders.

FreeType License (FreeType2)

Portions of this software are copyright © 2012 The FreeType Project (<http://www.freetype.org>). All rights reserved.

MIT License (HarfBuzz)

Portions of this software are copyright © 2012 The HarfBuzz Project (<http://www.freedesktop.org/wiki/Software/HarfBuzz>). All rights reserved.



Battery Life

The number of shots or movie footage that can be recorded with fully-charged batteries varies with the condition of the battery, temperature, the interval between shots, and the length of time menus are displayed. Sample figures for EN-EL21 (1485 mAh) batteries are given below.

- **Still images: Approximately 310 shots**
- **Movies: Approximately 65 minutes of HD footage at 1080/60i**

Measured according to CIPA standards at 23 ± 3 °C (73.4 ± 5.4 °F) with the camera at default settings, a fully-charged battery, a 1 NIKKOR VR 10–30mm f/3.5–5.6 lens, and a 16 GB Toshiba SD-E016GUX UHS-I SDHC card. Value for still images obtained under the following test conditions: photographs taken at intervals of 30 s with the built-in flash fired with every other shot and the camera turned off and then on after every ten shots. Value for movies obtained under the following test conditions: a series of 20 minute movies with a file size of up to 4 GB were recorded; recording was only interrupted when temperature warning was displayed.

The following can reduce battery life:

- Keeping the shutter-release button pressed halfway
- Repeated autofocus operations
- Taking NEF (RAW) photographs
- Slow shutter speeds
- Using a wireless mobile adapter or Eye-Fi cards
- Using vibration reduction mode with VR lenses
- Using zoom with power zoom lenses

To ensure that you get the most from rechargeable Nikon EN-EL21 batteries:

- Keep the battery contacts clean. Soiled contacts can reduce battery performance.
- Use batteries immediately after charging. Batteries will lose their charge if left unused.



Index

Symbols

(Auto mode)	23
P (Programmed auto)	34, 122
S (Shutter-priority auto)	35, 122
A (Aperture-priority auto) ...	36, 122
M (Manual)	37, 122
(Best moment capture mode)	41
(Advanced movie mode)	49
(Motion Snapshot mode)	59
(Scene auto selector)	122
(Portrait)	26
(Landscape)	26
(Night portrait)	26
(Close up)	26
(Night landscape)	26
(Auto)	26
* (flexible program)	34
MENU (menu) button	10, 109, 119, 159
(playback) button	30, 47, 62
(delete) button	48, 57, 62, 87
DISP (display) button	5, 81
F (feature) button ..	9, 28, 52, 61, 88
(OK) button	47, 56, 62
(AE-L/AF-L)	129, 155, 163
(exposure compensation)	68
(continuous shooting/self-timer) .	63, 65
(flash mode)	70
PRE (Preset manual)	132
(matrix)	128
(centerweighted)	128
(spot)	128
(auto-area)	153
[] (single-point)	153
(subject tracking)	153
(Single frame)	63
(Continuous)	63
(Self-timer)	63
(Remote control)	63

(red-eye reduction)	69
SLOW (slow sync)	69
REAR (rear curtain sync)	69
(flash-ready indicator)	69, 73

A

AC adapter	169, 174
Accessories	169
Active D-Lighting	144
Adobe RGB	143
Advanced movie mode	49
AE lock	129, 163
AE-L	129, 155
AF	149, 153
AF-A	149
AF-area mode	153
AF-assist illuminator	151, 156
AF-C	149
AF-F	149
AF-S	149
Aperture	36, 37
Aperture-priority auto	36
Assign AE/AF-L button	163
Assisted GPS	78
Attaching the lens	17
Auto distortion control	142
Auto image rotation	166
Auto mode	23
Auto power off	18, 77, 162
Auto-area AF (AF-area mode)	153
Autofocus	149, 153
Automatic scene selection	26
Auto-select AF	149
Available settings	181

B

Background track	62, 89, 98
Battery	12, 14, 21, 200
Beep	24, 65
Best moment capture mode	41
Best shot	44, 47

Body cap 1, 2, 171
Border 107
Bounce lighting 74
Brightness 138
Buffering 45, 60
Built-in AF assist 151, 156
Built-in Flash 69
Bulb 38

C

Calendar 85, 89
Calendar playback 85
Capture illuminator 42, 45, 61, 74
Capture NX 2 124, 141, 171
CEC 101
Center-weighted (Metering) 128
Change theme 117
Charging a battery 12
Clean image sensor 180
Clock 19, 20, 77, 165
Clock battery 20
Close up 26
Color space 143
Color temperature 134
Command dial 9, 30, 152
Compatible lens 169
Computer 91
Continuous 63, 125
Continuous AF 149
Contrast 138, 144
Creating short movies 97, 98
Crop 107, 115
Custom Picture Control 137, 140

D

Date and time 19, 165
Date format 19, 165
Daylight saving time 19, 165
DCF version 2.0 143, 208
Defaults 185
Delete 31, 48, 57, 62, 87
Delete all images 87
Delete selected images 87

Detailed display 4, 5
Detailed photo information 5, 82
Digital Print Order Format 208
Diopter adjustment control 6
Display brightness 161
D-Lighting 113
DPOF 104, 108, 208
DPOF print order 104, 108

E

Edit movie 116
Electronic viewfinder 6, 161
Exif version 2.3 143, 208
Exposure 68, 122, 128, 129
Exposure compensation 68
Exposure indicator 38
Exposure lock 129, 163
Exposure mode 122
Eye sensor 6
Eye-Fi 173

F

Face priority 27, 156
File format 128
Fill flash 69
Filter effects 138, 139
Fine-tuning white balance 131
Firmware version 167
Flash 69, 72, 157, 158, 170
Flash compensation 158
Flash control 157
Flash mode 70
Flash range 71
Flash-ready indicator 69, 73
Flexible program 34
Flicker reduction 164
Focal length 27, 82
Focal length scale 27, 202
Focal plane mark 2, 152
Focus 149, 153
Focus area 24, 153
Focus lock 154
Focus mode 149



Focusing the viewfinder	6
Format	15, 161
Format memory card	15, 161
Frame rate	81, 125
FT1	205
Full-frame playback	30, 81
Full-time AF	149

G

GP-N100	76
GPS	76
Grid display	6, 162

H

H.264	198
HD Movies	49, 126
HDMI	100, 208
HDMI device control	101
HDMI-CEC	101
HDR	145
High definition	100, 208
High ISO noise reduction	146
Histogram	83
Hue	138

I

Image quality	123
Image review	112
Image selection	111
Image size	123
Index print	104
Infrared receiver	2, 66
ISO sensitivity	135

J

JPEG	123
------------	-----

L

Landscape	26, 136
Language	19, 165
Lens	17, 27, 148, 169, 201
Lens cap	203
Lens mount	152
Live image control	28

Load from/save to card	141
Long exposure NR	146

M

Manual	37, 122
Manual focus	151
Matrix (Metering)	128
Maximum aperture	201
Memory card ...14, 16, 161, 172, 186	
Memory card access lamp	25
Memory card capacity	186
Metering	128
Microphone	50, 147
Mode dial	7
Monitor	4, 5, 161
Monitor brightness	161
Monochrome	136
Motion Snapshot mode	59
Mount adapter	169, 205
MOV	124
Movie before/after	127
Movie settings	126
Movie sound options	147
Movie type	52
Movie-record button ..32, 40, 50, 54	
Movies	49, 126
Multi accessory port	72, 76
Multi selector	8

N

NEF	123, 124
NEF (RAW)	123, 124
Neutral	136
Night landscape	26
Night portrait	26
Nikon Transfer 2	95
Number of shots saved	125

O

Optional flash	72
----------------------	----

P

Photo information	5, 81
-------------------------	-------



PictBridge	102, 208
Picture Control	136, 140
Pixel mapping	167
Playback	30, 81
Playback menu	109
Playback zoom	86
Portrait	26, 136
Power connector	169, 174
Power drive zoom switch	27
Power switch	18
Preset manual	130, 132
Press the shutter-release button all the way down	25, 26
Press the shutter-release button halfway	24, 26
Print date	108
Print DPOF print order	104
Printing	102
Programmed auto	34, 122
Protect	112

Q

Quick adjust	138
--------------------	-----

R

Rating	88, 112
Rear-curtain sync	69
Red-eye reduction	69
Remote control	63, 163
Remote on duration	163
Removing the lens from the camera 203	
Reset file numbering	164
Reset setup options	160
Reset shooting options	122
Resize	114
Retractable lens barrel button	17, 18, 202
Rotate tall	112

S

Saturation	138
Scene auto selector	122

SD card	172
Select by date	104
Select images for printing	104
Self-timer	63, 162
Sensitivity	135
Setup menu	159
Sharpening	138
Shooting menu	119
Short Movie Creator	91, 97, 98
Shutter button AE lock	163
Shutter speed	35, 37
Shutter-priority auto	35
Shutter-release button	24, 26, 42, 45, 60, 163
Silent photography	125
Simple photo information	81
Simplified display	5
Single AF	149
Single frame	63
Single-point	153
Size	114, 123, 126, 195, 198
Slide show	89
Slot empty release lock	161
Slow motion	53, 125
Slow sync	69
Slow view	41, 43
Smart photo selector	43, 44
Speaker	2
Speedlight	72
Spot (Metering)	128
sRGB	143
Standard	136
Strap	12
Subject tracking	153
System Requirements	93

T

Television	100
Temperature warnings	xvi
Theme	61
Thumbnail playback	84
Time	19, 38, 165



Time stamp	107
Time zone	165
Time zone and date	165
Timer	63
Toning	138, 139
Trimming movies	116

U

USB	79, 95, 102
USB cable	95, 102
Use GPS to set clock	77
UTC	77

V

Vibration reduction	148
Viewfinder	6, 161
Viewfinder brightness	161
ViewNX 2	91
Vivid	136
Volume	56, 90
VR	148

W

White balance	130
Wind noise reduction	147
Wireless mobile adapter	79, 171

Z

Zoom guide	27
Zoom ring	27, 202



No reproduction in any form of this manual, in whole or in part (except for brief quotation in critical articles or reviews), may be made without written authorization from NIKON CORPORATION.

NIKON CORPORATION

© 2012 Nikon Corporation



SB2J01(11)

6MVA3611-01

Download from www.Softmanuals.com. All Manuals Search And Download.

Free Manuals Download Website

<http://myh66.com>

<http://usermanuals.us>

<http://www.somanuals.com>

<http://www.4manuals.cc>

<http://www.manual-lib.com>

<http://www.404manual.com>

<http://www.luxmanual.com>

<http://aubethermostatmanual.com>

Golf course search by state

<http://golfingnear.com>

Email search by domain

<http://emailbydomain.com>

Auto manuals search

<http://auto.somanuals.com>

TV manuals search

<http://tv.somanuals.com>