

# Marshall Electronics

**NCB-1004**

Network Control Box for IMD Monitors

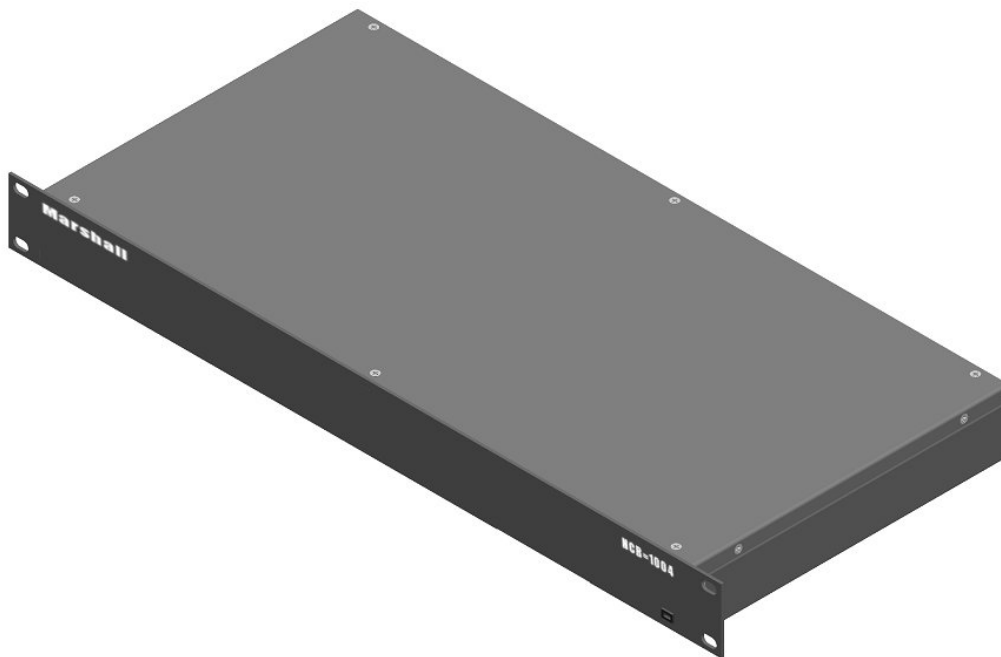

## Operating Instructions



# Contents

---

<b>Product Overview</b> .....	<b>4</b>
<b>Features</b> .....	<b>4</b>
<b>Installation and Initial Setup</b> .....	<b>5</b>
Unpacking.....	5
Installation .....	5
Power-On Procedure.....	5
<b>Front and Rear Panel Features</b> .....	<b>6</b>
RS-422 Outputs.....	6
Control Input.....	6
RJ-45 Network Interface .....	6
Power Input .....	6
Power LED .....	6
<b>Connecting to the NCB-1004</b> .....	<b>7</b>
Overview.....	7
Connecting the NCB-1004 to a Single Computer .....	7
Connecting the NCB-1004 to an Local Area Network.....	9
<b>Changing the IP Address of the NCB-1004</b> .....	<b>10</b>
Overview.....	10
Required Software.....	10
Procedure.....	10
<b>System Configuration</b> .....	<b>13</b>
Overview.....	13
Basic Remote Control of IMD Monitors.....	13
Overview.....	13
Wiring Diagram.....	13
Monitor Configuration.....	13
Remote Control with Image Video Pass-Through.....	14
Overview.....	14
Wiring Diagram.....	14
Monitor Configuration.....	14
Remote Control with TSL Pass-Through .....	15
Overview.....	15
Wiring Diagram.....	15
Monitor Configuration.....	15
<b>Web Interface</b> .....	<b>16</b>
Overview.....	16
Target Monitor .....	16
Window Management.....	17
Key & Image Enhancement.....	17
Preset Configuration.....	18
Test Mode.....	18
OSD Configuration & IMD.....	19
System.....	20
Message Box.....	20
Table of Web Interface Commands .....	21
<b>Specifications</b> .....	<b>22</b>
<b>Warranty</b> .....	<b>23</b>

# Product Overview

---

The NCB-1004 Network Control box is a comprehensive remote control solution for Marshall's IMD (In-Monitor Display) line of monitors. The NCB-1004 offers complete control of each monitor's menu settings and adjustments such as contrast, color, curtain color, aspect ratio, and more. The NCB-1004 can control up to 256 monitors individually by ID#, or up to 512 monitors simultaneously on a global scale. The NCB-1004 also enables the use of third party UMD controllers such as Image Video or TSL, while maintaining remote control of the monitor's settings and adjustments. The NCB-1004 is operated with a web interface via a standard TCP/IP network connection. No special application or additional software is needed other than a standard web browser.

## Features

---

- **Full Remote Control**

The NCB-1004 offers complete control of all monitor settings and adjustments, such as brightness, color, contrast, aspect ratio, screen markers, curtain color, IMD text, etc.

- **Control Entire Video Walls or Individual Monitors**

The NCB-1004 can send global commands to affect all monitors in a video wall, or individual commands to affect single monitors identified by ID#.

- **Support for Third Party UMD Protocols**

The NCB-1004 accepts and transmits Image Video or TSL v4.0 protocol commands, while maintaining full remote control of the monitors settings and adjustments.

- **No Additional Software Needed**

As the NCB-1004 is operated with a built-in web interface via a standard TCP/IP network, no special application or additional software is needed other than a standard web browser.

# Installation and Power-On

---

## ■ Unpacking

Carefully unpack the NCB-1004 and verify that the following items are included:

- NCB-1004 Network Control Box
- V-PS12-5V-1 Power Supply with 2-Pin Twist Lock Connector
- Operating Instructions

Inspect the unit for any physical damage that may have occurred during shipping. Should there be any damage, immediately contact Marshall Electronics at (800) 800-6608. If you are not located within the continental United States, call +1 (310) 333-0606.

## ■ Installation

The NCB-1004 can be mounted in any standard EIA 19" equipment rack. If additional equipment is installed directly above and below the NCB-1004 in a rack, adequate ventilation of the rack is required to prevent overheating.

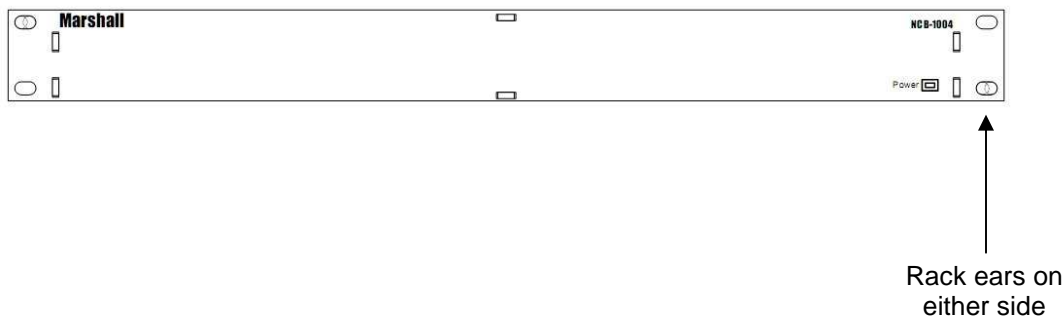

## ■ Power-On Procedure

Plug the V-PS12-5V-1 power supply into an AC power source (100-240 V @ 50/60 Hz). Attach the 2-pin twist lock connector to the back of the unit. The NCB-1004 will automatically turn 'ON' when power is supplied.

**NOTE THAT THE NCB-1004 TAKES ABOUT 3 MINUTES AFTER POWER ON BEFORE IT IS FUNCTIONAL. WAIT 3 MINUTES AFTER POWER ON BEFORE ACCESSING THE NCB-1004 VIA A NETWORK CONNECTION.**

# Front and Rear Panel Features

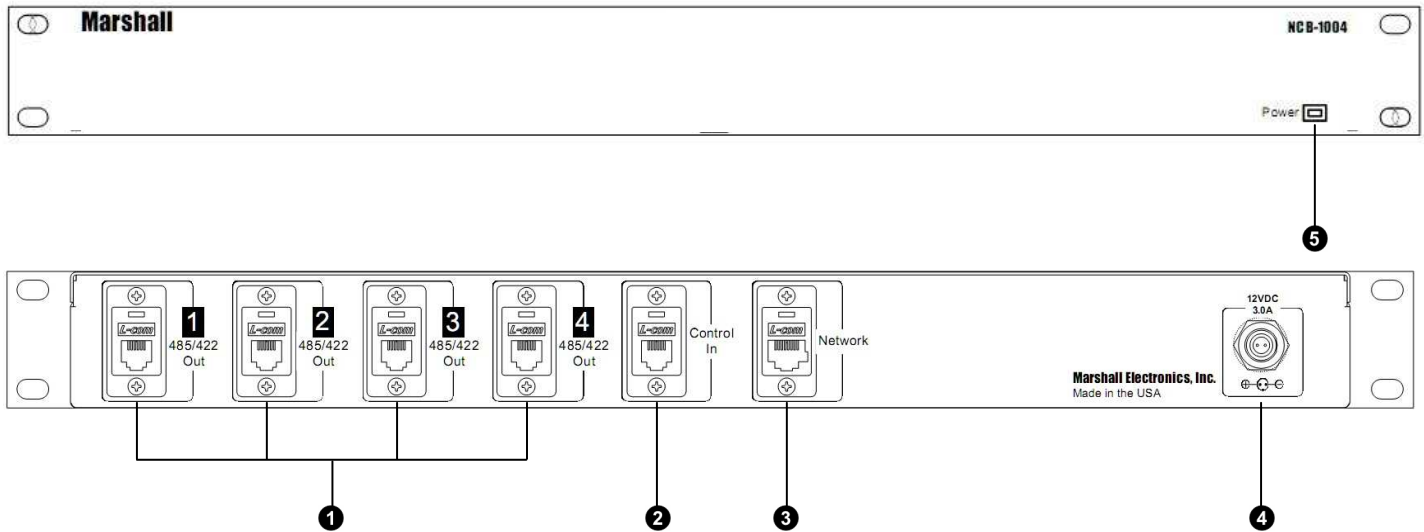

## ❶ RS-422 Outputs

The RS-422 outputs send MEI protocol commands to Marshall's IMD line of monitors. Each output has exactly the same signal. Up to 128 screens can be connected to each output. These output ports also pass Image Video or TSL v4.0 protocol commands from the Control Input, embedded in the MEI protocol. **See Page 22 for specifications.**

## ❷ Control Input

The RS-422 Control Input receives Image Video or TSL v4.0 protocol commands from an external controller. These commands are then embedded in MEI protocol and sent to the IMD monitors. **See page 22 for specifications.**

## ❸ RJ-45 Network Interface

The RJ-45 network interface is used to connect the NCB-1004 to a standard TCP/IP network. The NCB-1004 is operated via an embedded web interface. **See page 7 for configuration details.**

## ❹ Power Input

Connect the 12VDC input to the 2-Pin twist lock power input connector. *Note that the NCB-1004 takes about 3 minutes to start up after power on, before the unit is functional.*

**IMPORTANT:** If using a power source other than the included power supply, be sure that the polarity of the DC input is correct:



## ❺ Power LED

The Power LED illuminates green when power is supplied to the unit.

# Connecting to the NCB-1004

## Overview

The NCB-1004 can be operated by any computer with a web browser, via a TCP/IP network connection. No additional software is needed. The NCB-1004 may be connected directly to a single computer, or connected to a local area network and accessed by multiple computers. **The NCB-1004 is shipped with the default IP address 192.168.0.233.**

The following procedures describe the two ways to connect to the NCB-1004.

## Connecting the NCB-1004 to a Single Computer

To use the NCB-1004 for the first time, you will most likely need to connect the NCB-1004 directly to a single computer. After this connection is made, you can change the unit's IP address to be suitable for your network. (See the next section "Changing the IP Address.")

1. Connect the NCB-1004 to a Windows-based computer using a standard ethernet cable. ***In general, a standard "straight" ethernet cable should be used. If the PC's ethernet jack is not auto-switching, it may be necessary to use a cross-over cable.***
2. Supply power to the NCB-1004 with the included power supply.
3. In Windows, open the **Network Connections** control panel. (Start > Control Panel > Network Connections)
4. A **Local Area Connection** should be listed. Right-Click on Local Area Connection, and select **Properties**.
5. Scroll down the list in the Local Area Connection Properties, click on **Internet Protocol (TCP/IP)**, and click the **Properties** button.
6. Enter the information as shown in the picture below:

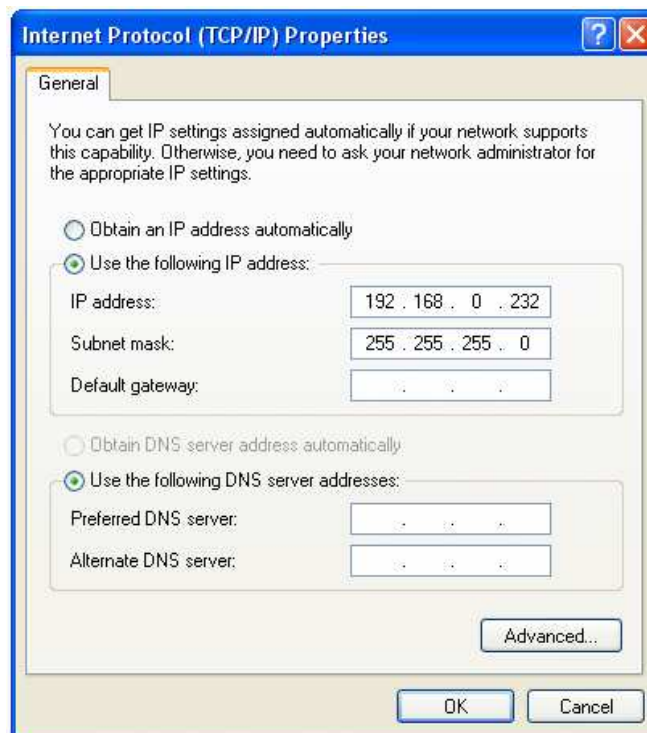

7. Note that the last number in the IP address in the picture above is 232, rather than 233.

# Connecting to the NCB-1004 (continued)

## Connecting the NCB-1004 to a Single Computer (continued)

- Click **OK** in the **Internet Protocol (TCP/IP) Properties** window, and then click **Close** in the **Local Area Connection Properties** window.
- Open any web browser application (Internet Explorer, Firefox, etc.)
- Enter the address <http://192.168.0.233/>
- Click OK if the following dialog appears:

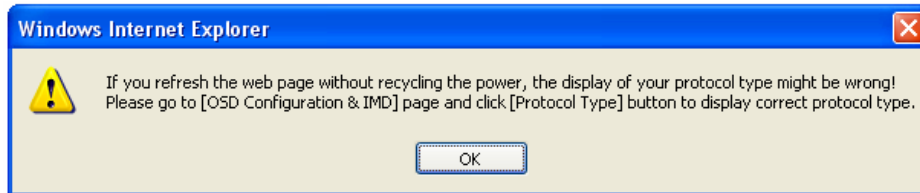

- If successfully connected, the web interface of the NCB-1004 will be shown in the browser windows as shown below. Make sure the NCB-1004 has been powered on for at least 3 minutes before attempting to access the web interface.





# Connecting to the NCB-1004 (continued)

## Connecting the NCB-1004 to a Local Area Network

If the network portion of the unit's IP address (first three numbers) matches your network, the NCB-1004 can be connected to a local area network and accessed from any computer on the network. The unit's IP address must also be available on the network and reserved for the NCB-1004.

1. Connect the NCB-1004 to the network, using a standard ethernet cable:

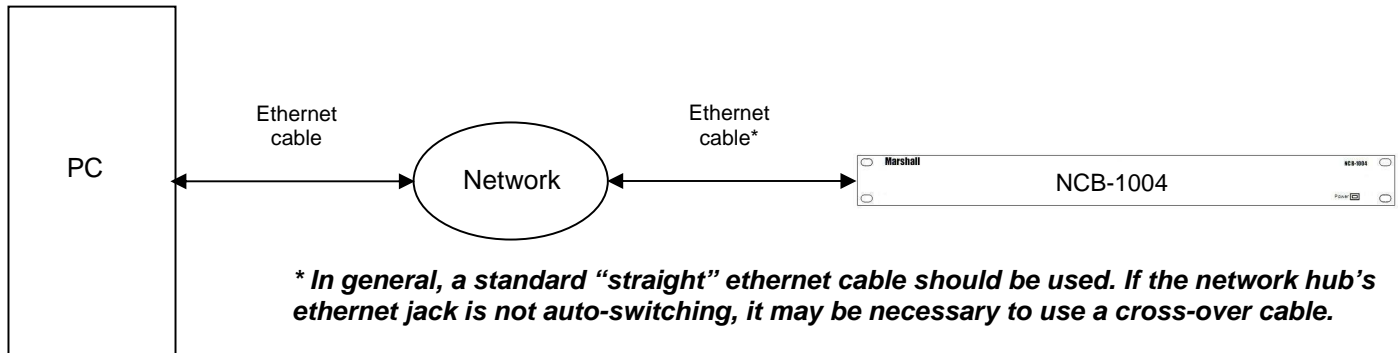

2. Using any computer connected to the network, enter the unit's IP address in a web browser to access the NCB-1004 web interface.
3. If successfully connected, the web interface of the NCB-1004 will be shown in the browser windows as shown below:

The screenshot shows the web interface of the NCB-1004. At the top, there is a header with a globe icon and the text 'Marshall Electronics'. Below this is a section titled 'Control Box'. Under 'Control Box', there are two rows of controls. The first row has a 'Target Monitor' section with radio buttons for 'All/Global' (selected) and 'Address' followed by an input field. To the right of this are two status indicators: 'Image Video Protocol' and 'Pass-Through : ON'. The second row contains a navigation menu with tabs: 'Window Management', 'Key & Image Enhancement', 'Preset Configuration', 'Test Mode', 'OSD Configuration & IMD', and 'System'. Below the navigation menu, there are several configuration options. On the left, there are four aspect ratio options: '4:3 Aspect Ratio', 'Scaled 4:3 Aspect Ratio', '16:9 Aspect Ratio', and 'Centered 16:9 Aspect Ratio'. On the right, there are four dropdown menus and four buttons: 'Off', 'Set Marker', 'Off', 'Set Center', 'Transparent', 'Set Background', and 'Blue', 'Set Curtain Color'. At the bottom of the interface is a 'Message Box' section with two rows: 'Status' and 'Error', each followed by a large empty text area.

# Changing the IP Address of the NCB-1004

## Overview

The NCB-1004 is shipped with a default IP address of **192.168.0.233**. This IP address can be changed via the network connection. **Note that the existing IP address must be known to make this change. If the existing IP address is unknown, please contact Marshall Electronics for assistance.**

## Required Software

The following procedure requires Tera Term software for Windows, or a similar SSH tool. Tera Term is free software available on the internet at the following location:

<http://www.ayera.com/teraterm/>

## Procedure

1. Connect the NCB-1004 to your network or directly to your Windows-based PC, with a standard ethernet patch cable. (When connecting the NCB-1004 directly to a computer, **do not** use a crossover cable.)
2. Verify connection of the NCB-1004 by loading the web interface in a browser window, at the current IP address.
3. Run the Tera Term software, and connect to the NCB via SSH at its existing IP address. Use the setting shown in the picture below:

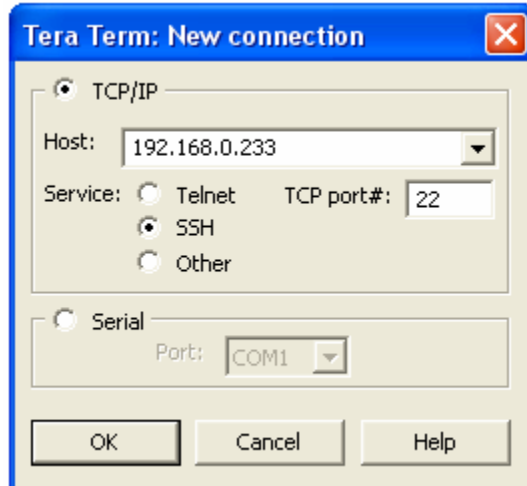

4. At the username prompt shown below, login as **root**:

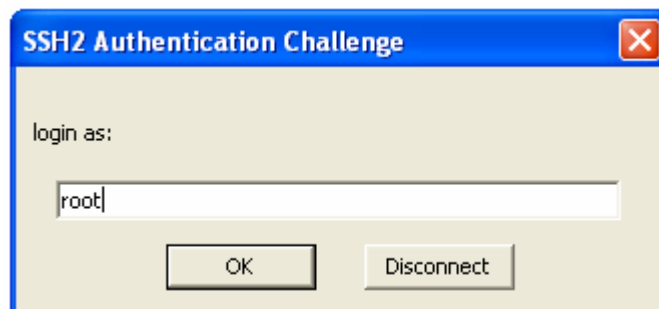

## Changing the IP Address of the NCB-1004 (continued)

### Procedure (continued)

- At the password prompt shown below, *do not* enter a password and simply click **OK**:

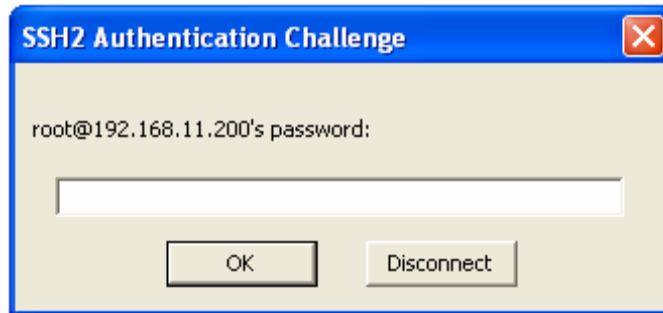

- Then, the following command line interface should appear:

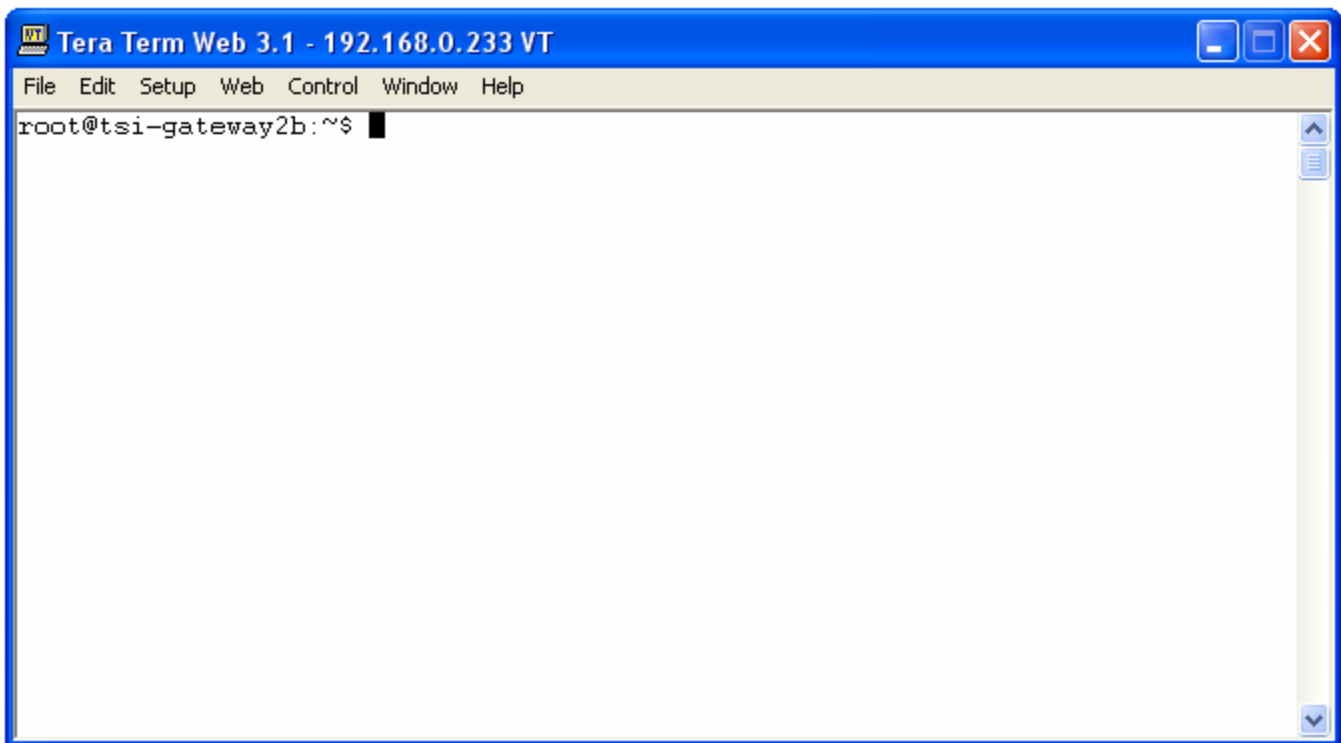

- Type the following command at the command prompt, and press enter:

```
vi /etc/network/interfaces
```

## Changing the IP Address of the NCB-1004 (continued)

### Procedure (continued)

8. The following file information should appear:

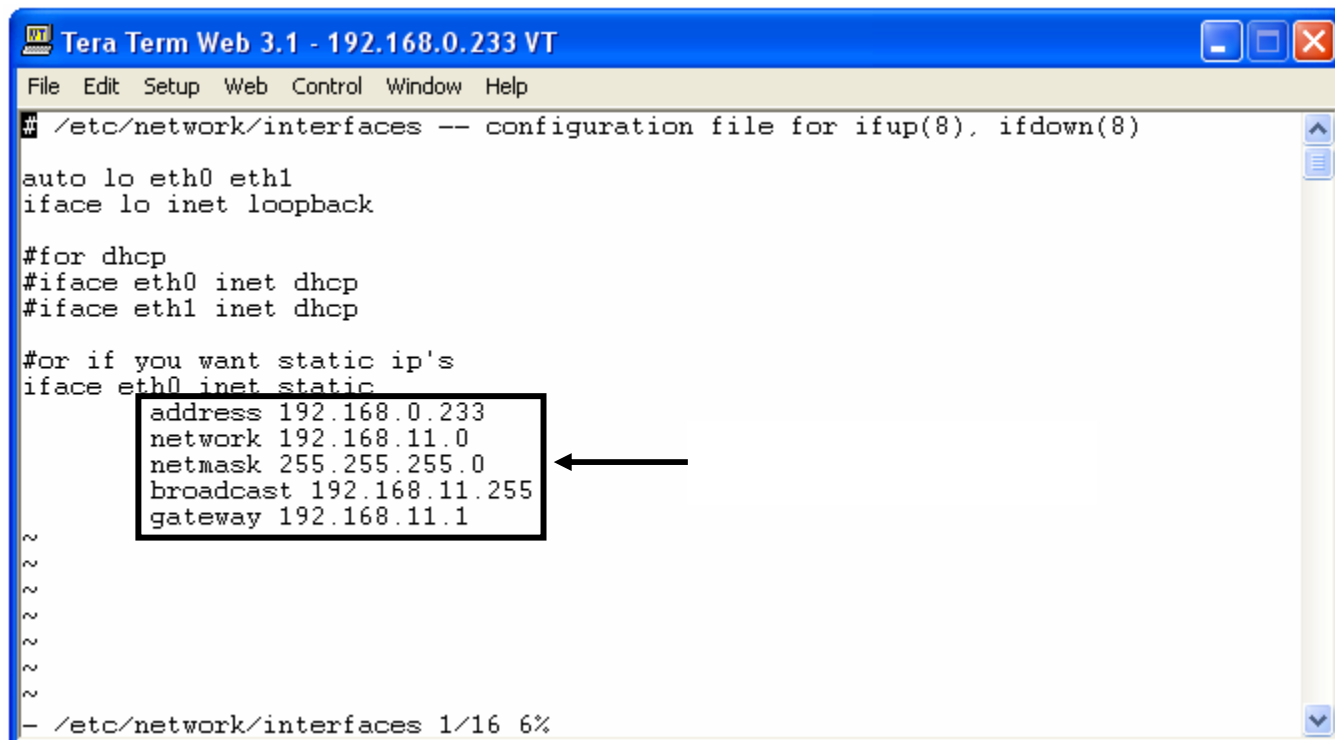

```
Tera Term Web 3.1 - 192.168.0.233 VT
File Edit Setup Web Control Window Help
# /etc/network/interfaces -- configuration file for ifup(8), ifdown(8)

auto lo eth0 eth1
iface lo inet loopback

#for dhcp
#iface eth0 inet dhcp
#iface eth1 inet dhcp

#or if you want static ip's
iface eth0 inet static
    address 192.168.0.233
    network 192.168.11.0
    netmask 255.255.255.0
    broadcast 192.168.11.255
    gateway 192.168.11.1
~
~
~
~
~
~
- /etc/network/interfaces 1/16 6%
```

9. This file must be edited to save the new IP address. Use the following commands to edit the file. **Edit only the numbers. Do not press the enter key after each command.**

To **move the cursor**, use arrow keys or the following keys:

<b>h</b>	left
<b>l</b>	right
<b>j</b>	down
<b>k</b>	up

To **edit the text**, use the following keys:

<b>x</b>	delete single character under cursor
<b>r</b>	replace single character under cursor with single character
<b>i</b>	insert characters before cursor (press esc when finished typing)
<b>a</b>	insert characters after cursor (press esc when finished typing)

**Save the file and exit the file editor** using the following commands:

<b>ZZ</b>	exit and save changes
<b>:q!</b>	exit without saving changes
<b>:w</b>	save file without exiting

10. Be sure to note the new IP address. Reboot the NCB-1004 for the new IP address to take effect.

# System Configuration

## Overview

The NCB-1004 can be used in three different system configurations. The following diagrams show the different configurations:

## Basic Remote Control of IMD Monitors

### ■ Overview

Use the following configuration for basic remote control of Marshall IMD series monitors. This setup allows remote control of all features in the on-screen menu of each IMD monitor.

### ■ Wiring Diagram

Use the following configuration for basic remote control of Marshall IMD series monitors.

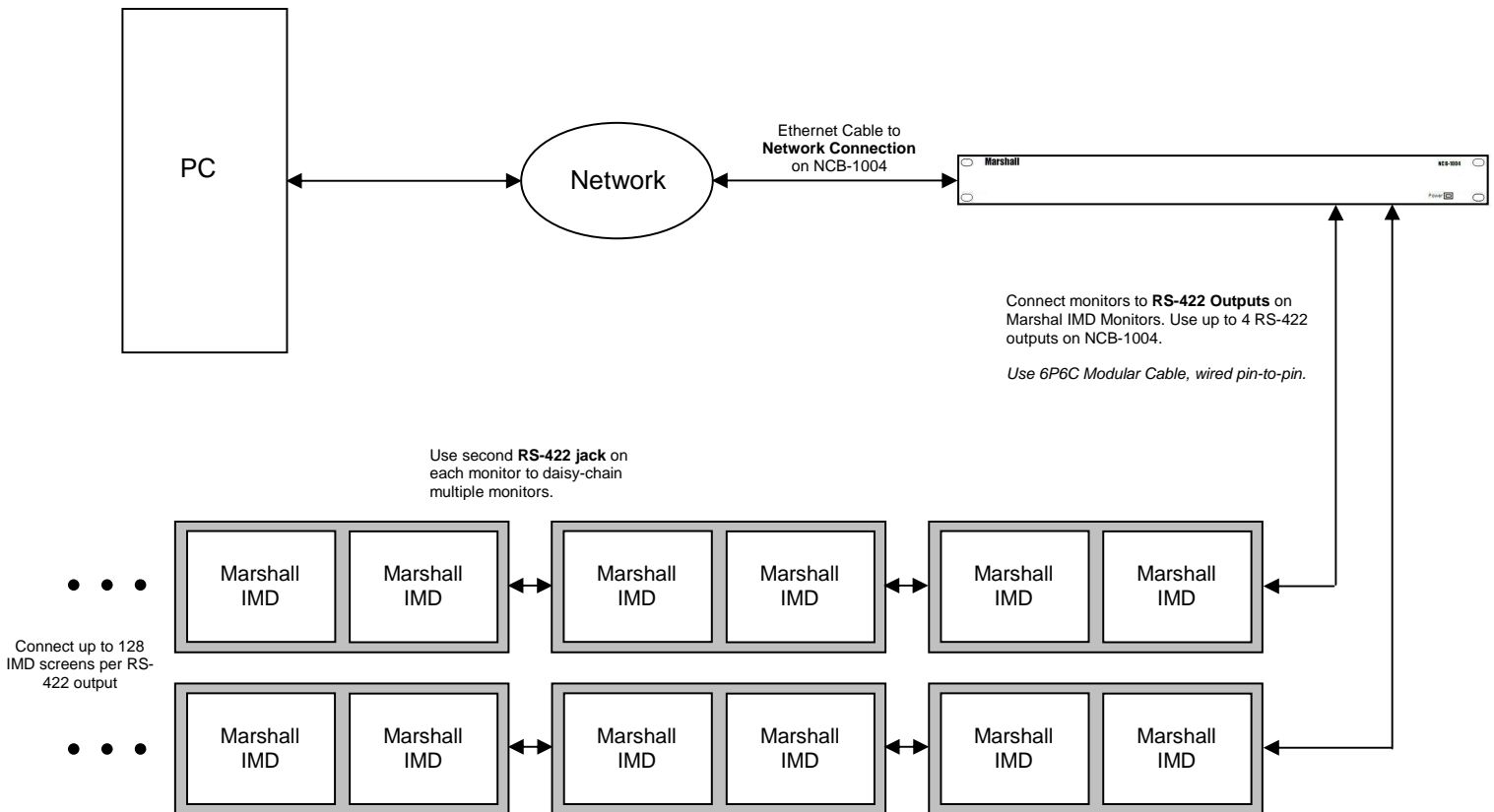

### ■ Monitor Configuration

The following settings are required on each IMD monitor:

IMD Protocol:	<b>MEI</b>
IMD Baud Rate:	<b>57600</b>
ID#:	<b>Each monitor must have a unique ID# for remote control of individual monitors.</b>

# System Configuration (continued)

## Remote Control with Image Video Pass-Through

### ■ Overview

Use the following configuration for basic remote control of Marshall IMD series monitors, while also passing through Image Video protocol. This setup allows remote control of the IMD monitor, and pass-through of Image Video text and tally commands from an Image Video TSI-1000 or other Image Video protocol source.

### ■ Wiring Diagram

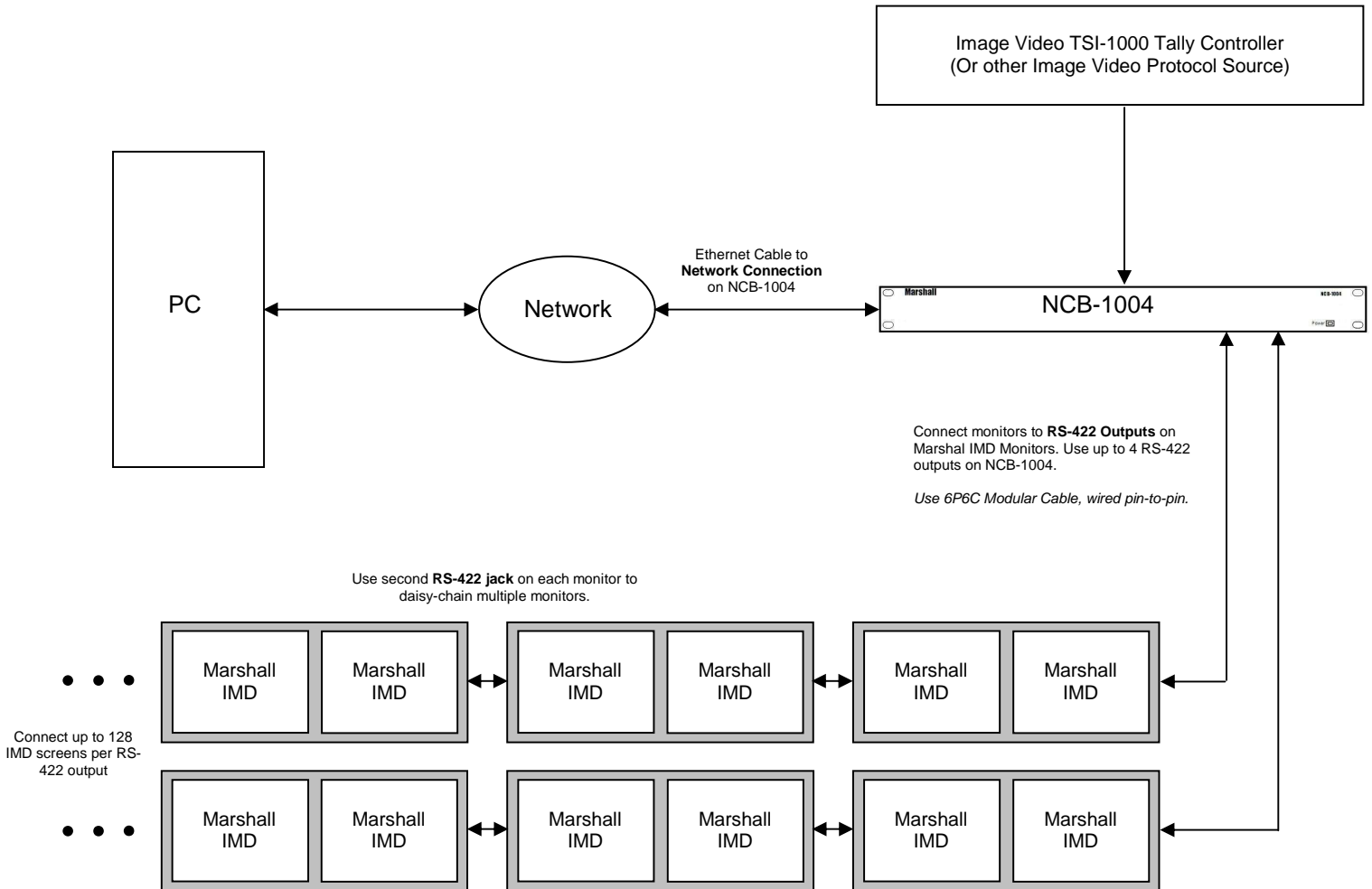

### ■ Monitor Configuration

The following settings are required on each IMD monitor:

IMD Protocol: **MEI-Image Video**  
IMD Baud Rate: **57600**  
ID#: **Each monitor's ID# will be set automatically by Image Video controller.**  
IMD Name (S/N): **Each monitor must have a unique string in this field.**

**In this configuration, Pass-Through must be set to "ON" and to "Image Video" in the OSD Configuration & IMD Page of the web interface. See page 19 for details.**

## Remote Control with TSL Pass-Through

### ■ Overview

Use the following configuration for basic remote control of Marshall IMD series monitors, while also passing through TSL v4.0 protocol. This setup allows remote control of the IMD monitor along with pass-through of TSL text and tally commands from a TSL Tally Man controller or other TSL protocol source.

### ■ Wiring Diagram

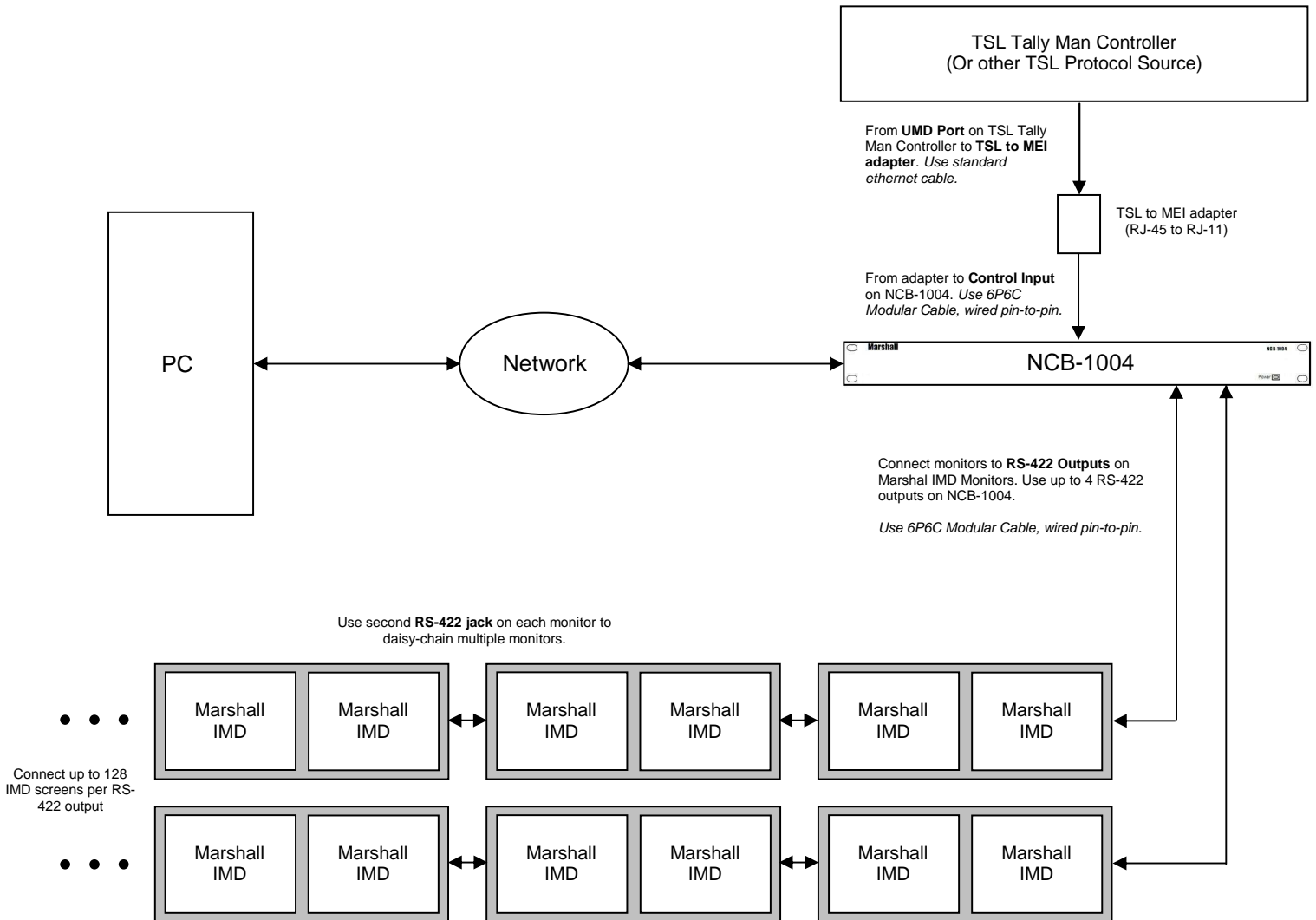

### ■ Monitor Configuration

The following settings are required on each IMD monitor:

IMD Protocol:	<b>MEI</b>
IMD Baud Rate:	<b>57600</b>
ID#:	<b>Each monitor must have a unique ID# for remote control of individual monitors.</b>

**In this configuration, Pass-Through must be set to "ON" and to "TSL" in the OSD Configuration & IMD Page of the web interface. See page 19 for details.**

# Web Interface

## Overview

The web interface is used to operate the NCB-1004. Once the NCB-1004 is connected to a network, access the web interface by entering the units IP address in any web browser on any computer on the network. The web interface allows remote control of all on-screen menu features of individual monitors or all monitors connected. The web interface also controls the pass-through of Image Video or TSL protocol.

## Target Monitor

The target monitor frame is always visible at the top of the NCB-1004 web page:



Marshall Electronics

### Control Box

Target Monitor

All/Global  Address

Image Video Protocol Pass-Through : ON

### ■ Target Monitor

On the right side of the frame, choose which monitors to address:

- When the “All/Global” option is selected, all commands will be globally sent to all IMD monitors connected to the NCB-1004.
- When the “Address” option is selected, all commands will be sent only to the IMD monitor with the ID# in the adjacent field.

*Note that to control individual monitors, each monitor must be pre-assigned a unique ID#. Also note that GET commands do not work in “All/Global” mode.*

### ■ Protocol Pass-Through Status

On the right side of the frame, two windows show the protocol pass-through status:

- The first window displays “Image Video Protocol” or “TSL 4.0 Protocol,” according to which protocol is selected for pass-through in the OSD Configuration & IMD page.
- The second window displays “Pass-Through: ON” or “Pass-Through: OFF,” according to the pass-through setting in the OSD Configuration & IMD page.



## Window Management

The Window Management page is shown below:

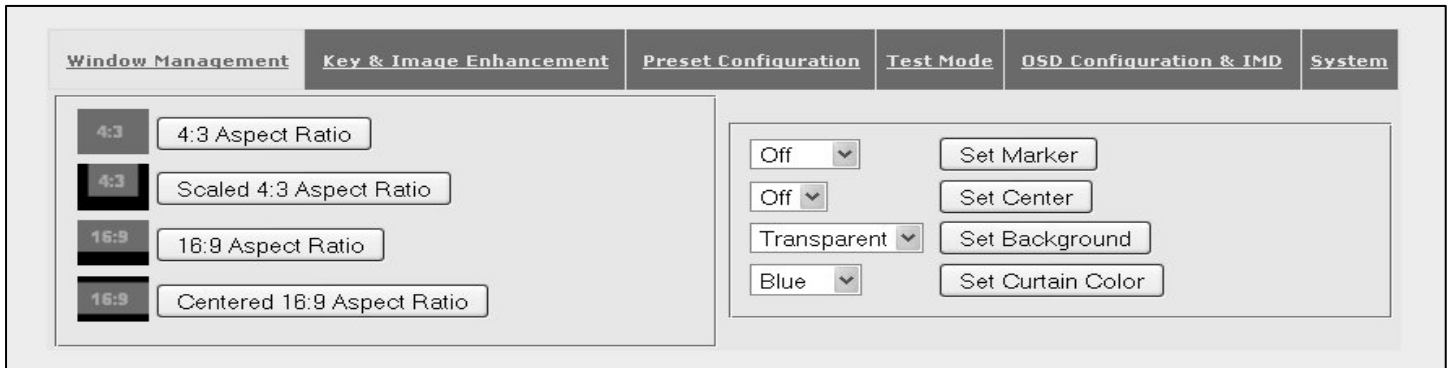

Use the buttons and menus shown above for the following settings:

- Aspect Ratio (4:3, Scaled 4:3, 16:9, Centered 16:9 / Full Screen)
- On-Screen Markers (Aspect Ratio and Safe Area Markers)
- Center Marker
- Marker Background
- Curtain Color

## Key & Image Enhancement

The Key & Image Enhancement page is shown below:

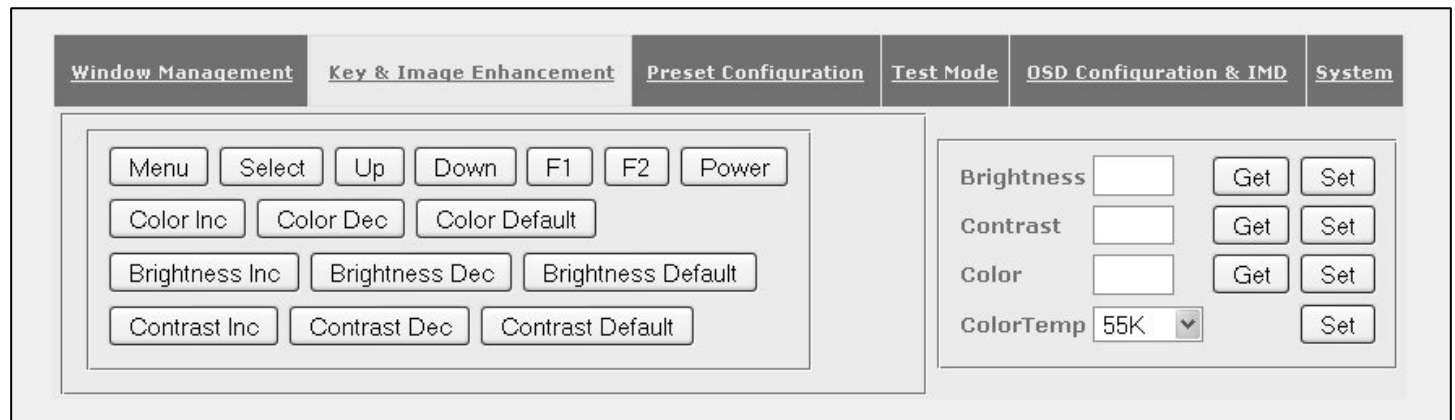

Use the buttons and menus shown above for the following settings:

- **Keypad Commands (Menu, Select, Up, Down, F1, F2, Power)** – These commands simulate pressing keypad buttons on a monitor. The entire on-screen menu can be navigated using this commands alone.
- **Color, Brightness and Contrast (Increment, Decrement, Default)** – Use these commands to manually increment or decrement the value of the corresponding control by 1 unit.
- **Brightness, Contrast and Color Value (0-100)** – Use the SET command to assign a fixed value to the corresponding control. Use the GET command to read the current value of a control
- **ColorTemp Setting** – Set the color temperature preset

## Preset Configuration

The Preset Configuration page is shown below:

The screenshot shows a navigation menu at the top with six tabs: **Window Management**, **Key & Image Enhancement**, **Preset Configuration** (which is highlighted), **Test Mode**, **OSD Configuration & IMD**, and **System**. Below the menu, there are two rows of buttons. The first row is labeled "Load" and contains buttons for "User1", "User2", "User3", "User4", "User5", "User6", and "Factory". The second row is labeled "Save" and contains buttons for "User1", "User2", "User3", "User4", "User5", and "User6".

Use the buttons shown above to load and save presets in each monitor. Note that these controls affect the presets in each monitor only. There are no presets in the NCB-1004 itself.

- Load (Load presets User1 – User6, or Factory Default Settings)
- Save (Save the current settings on each monitor to presets User1 – User6)

## Test Mode

The Test Mode page is shown below:

The screenshot shows a navigation menu at the top with six tabs: **Window Management**, **Key & Image Enhancement**, **Preset Configuration**, **Test Mode** (which is highlighted), **OSD Configuration & IMD**, and **System**. Below the menu, there is a "Reset Test Mode" button. Underneath, there are three rows of controls, each with a label and two buttons: "SetBlueOnly" with "Off" and "On" buttons, "Monochrome" with "Off" and "On" buttons, and "PixelToPixel" with "Off" and "On" buttons.

Use the buttons shown above to send the following commands:

- Reset Test Mode – This command turns Blue mode, Monochrome Mode, and PixelToPixel mode OFF.
- Blue Mode (Off, On)
- Monochrome Mode (Off, On)
- PixelToPixel Mode (Off, On)

## OSD Configuration & IMD

The OSD Configuration & IMD page is shown below:

Use the first section of the OSD & IMD page to set the **protocol pass-through settings**:

- **Set Protocol (Image Video, TSL)** – Select the protocol type to be passed through the NCB-1004. *Note that this option must be set according to the protocol that is applied to the Control In input on the NCB-1004.*
- **Pass-Through (On, Off)** – Enable or disable the pass-through of Image Video or TSL protocol.
- **Read Protocol Type** – Refresh the Protocol Type display in the Target Monitor page.
- **Read TSL Status** – Read the TSL error status. Results are displayed in the Message Box at the bottom of the page.

Use the left-hand section of the page to **configure the OSD** with following commands:

- IMD State (Off, On)
- Status Display (Off, On)
- Timecode (Off, LTC, VITC)
- Audio Monitor (Off, On)

Use the left-hand section of the page to configure the In-Monitor Display:

- **Show IMD Address** – This command displays the current of each monitor on each screen.
- **Set IMD Intensity (0-100)**
- **Send IMD Alignment (Left, Center, Right)** – Set the fixed string alignment of a monitor.
- **Send IMD Color (Red, Green, Yellow/Amber)** – Set the fixed string color of a monitor.
- **Send IMD String** – Set the fixed string in a monitor.
- **Send IMD Name** – Set the IMD Name (S/N) of a monitor.
- **Get IMD Name** – Get the IMD Name (S/N) of the selected monitor.
- **Show IMD** – Show the fixed string on a monitor.
- **Show IMD Name** – Show the IMD Name on a monitor.

## System

The System page is shown below:

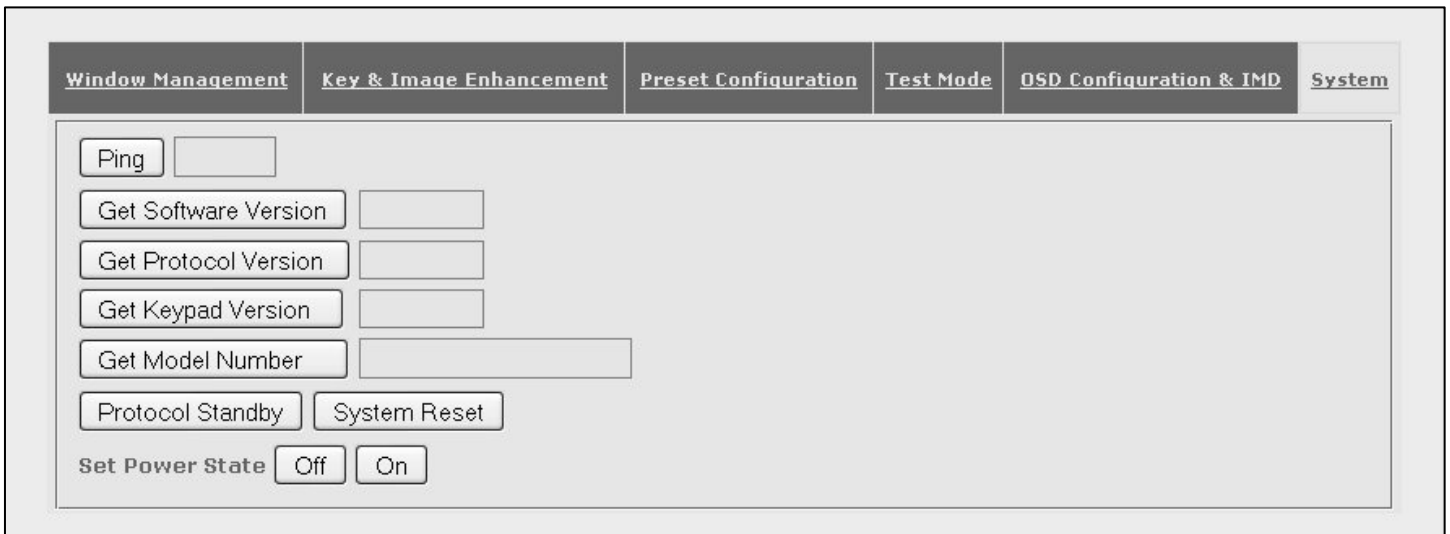

The screenshot shows the 'System' page of the web interface. At the top, there is a navigation bar with six tabs: 'Window Management', 'Key & Image Enhancement', 'Preset Configuration', 'Test Mode', 'OSD Configuration & IMD', and 'System'. The 'System' tab is selected. Below the navigation bar, the main content area contains several controls:

- A 'Ping' button next to a text input field.
- A 'Get Software Version' button next to a text input field.
- A 'Get Protocol Version' button next to a text input field.
- A 'Get Keypad Version' button next to a text input field.
- A 'Get Model Number' button next to a text input field.
- 'Protocol Standby' and 'System Reset' buttons.
- 'Set Power State' with 'Off' and 'On' radio buttons.

Use the buttons shown above to send the following commands:

- **Ping (Healthy, Unhealthy)** – Test a command and response with a monitor.
- **Get Software Version** – Reads the main software version of a monitor.
- **Get Protocol Version** – Reads the protocol version of a monitor.
- **Get Keypad Version** – Reads the keypad software version of a monitor
- **Get Model Number** – Reads the model number of a monitor.
- **Protocol Standby** – Set monitor into “serial ignore” mode, for programming other monitors on same bus
- **System Reset** – Resets the system software on a monitor
- **Set Power State (Off, On)** – Switches the monitor on or off. Note that although the backlight is off, power is still supplied to monitor even when monitor is set to off.

## Message Box

The Message Box frame is shown below:

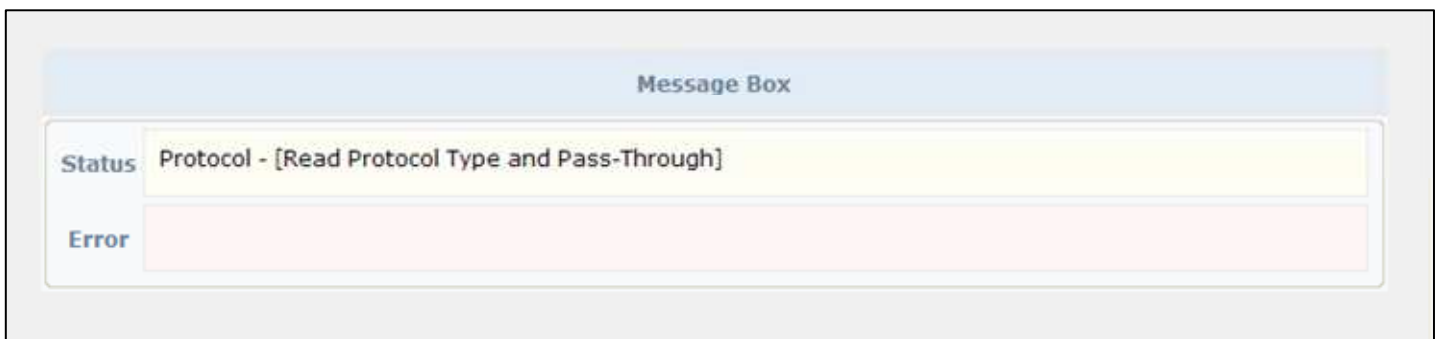

The screenshot shows the 'Message Box' frame. It has a light blue title bar with the text 'Message Box'. Below the title bar, there are two sections:

- Status**: A yellow box containing the text 'Protocol - [Read Protocol Type and Pass-Through]'. The label 'Status' is on the left.
- Error**: A pink box that is currently empty. The label 'Error' is on the left.

The Message Box shows the current status of commands being sent and acknowledged, as well as any error messages.

## Table of Web Interface Commands

<b>Main</b>	<b>Window Management</b>	<b>Aspect Ratio</b>	4:3, Scaled 4:3, 16:9, 16:9 Centered
		<b>Set Marker</b>	Off, On
		<b>Set Center</b>	Off, On
		<b>Set Background</b>	Transparent, 50% Gray, Black
		<b>Set Curtain Color</b>	Blue, Red, Green, White, Black
	<b>Key &amp; Image Enhancement</b>	<b>Menu Controls</b>	Menu, Select, Up, Down, F1, F2 Power
		<b>Color</b>	Increase Value, Decrease Value, Default, Set Value, Get Value
		<b>Brightness</b>	Increase Value, Decrease Value, Default, Set Value, Get Value
		<b>Contrast</b>	Increase Value, Decrease Value, Default, Set Value, Get Value
		<b>Color Temp</b>	55K, 65K, 93K, Linear
	<b>Preset Configuration</b>	<b>Load</b>	Mfg, User 1, User 2, User 3, User 4, User 5, User 6
		<b>Save</b>	User 1, User 2, User 3, User 4, User 5, User 6
	<b>Test Mode</b>	<b>Reset Test Mode</b>	Restore Test Mode Defaults
		<b>Blue Only</b>	Off, On
		<b>Monochrome</b>	Off, On
		<b>Pixel-to-Pixel</b>	Off, On
	<b>OSD Configuration &amp; IMD</b>	<b>Set Protocol</b>	Image Video, TSL
		<b>Pass-Through</b>	On, Off
		<b>Protocol Type</b>	Verify Protocol Type
		<b>TSL Status</b>	Verify TSL Status
		<b>IMD State</b>	Off, On
		<b>Status Display</b>	Off, On
		<b>Timecode</b>	Off, LTC, VITC
		<b>Audio Monitor</b>	Off, On
		<b>Show IMD Address</b>	Display Address On-Screen
		<b>Set IMD Inensity</b>	Set Value
		<b>Send IMD Alignment</b>	Left, Center, Right
		<b>Send IMD Color</b>	Red, Green, Yellow/Amber
		<b>Send IMD String</b>	Send String
		<b>Send IMD Name</b>	Send Name
		<b>Get IMD Name</b>	Get Name
		<b>Show IMD</b>	Display IMD String On-Screen
		<b>Show IMD Name</b>	Display IMD Name On-Screen
	<b>System</b>	<b>Ping</b>	Healthy, Unhealthy
<b>Get Software Version</b>		Display Software Version	
<b>Get Protocol Version</b>		Display Protocol Version	
<b>Get Keypad Version</b>		Display Keypad Version	
<b>Get Model Number</b>		Display Model Number	
<b>Protocol Standby</b>		Enable Protocol Standby	
<b>System Reset</b>		Enable System Reset	
<b>Set Power State</b>		Off, On	

# Specifications

## ■ CONTROL INPUT

### Connector

1 x RJ12 (Modular 6P6C)

### Physical Layer

RS-422

### Data Protocols

Image Video:

*Start Bits*            1  
*Data Bits*             7  
*Parity*                 Even  
*Stop Bits*             1  
*Baud Rate*            38400

TSL v4.0 Protocol:

*Start Bits*            1  
*Data Bits*             8  
*Parity*                 Even  
*Stop Bits*             1  
*Baud Rate*            38400

### Pinout

Pin No.	Signal
1	N/C
2	Ground
3	Rx+
4	Rx-
5	N/C
6	N/C

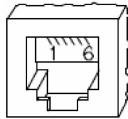

## ■ MONITOR OUTPUTS

### Connectors

4 x RJ12 (Modular 6P6C)

### Physical Layer

RS-422

### Data Protocol

MEI

*Start Bits*            1  
*Data Bits*             8  
*Parity*                 None  
*Stop Bits*             1  
*Baud Rate*            57600

### Pinout

Pin No.	Signal
1	Rx-
2	Ground
3	Tx+
4	Tx-
5	N/C
6	Rx+

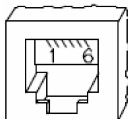

## ■ NETWORK CONNECTION

### Connector

1 x RJ45 (Modular 8P8C)

### Physical Layer

10BASE-T or 100BASE-T Ethernet

### Data Protocol

TCP/IP

## ■ ELECTRICAL

Power Consumption    3.0A @ 12VDC (36 W)

Voltage Requirement   12 VDC

V-PS12-5V-1 Power Supply:

Input                    100V-240V, 1.5A, 50-60Hz

Output                  12VDC, 5A, 60W Max

## ■ MECHANICAL

Dimensions (w x h x d): 18.96" x 1.72" x 8.37"

Rack Height:            1RU

Weight:                   5.5 lbs

Operating Temperature 32°F to 120°F (0°C to 50 °C)

Storage Temperature   -4°F to 120°F (-20°C to 50°C)

Compliance            CE, FCC-Class A, ANSI-63.4  
 (Certificates on file)

RoHs                     Do not dispose. Return to  
 Manufacturer or Authorized  
 Recycle Facility.

## Specifications (continued)

---

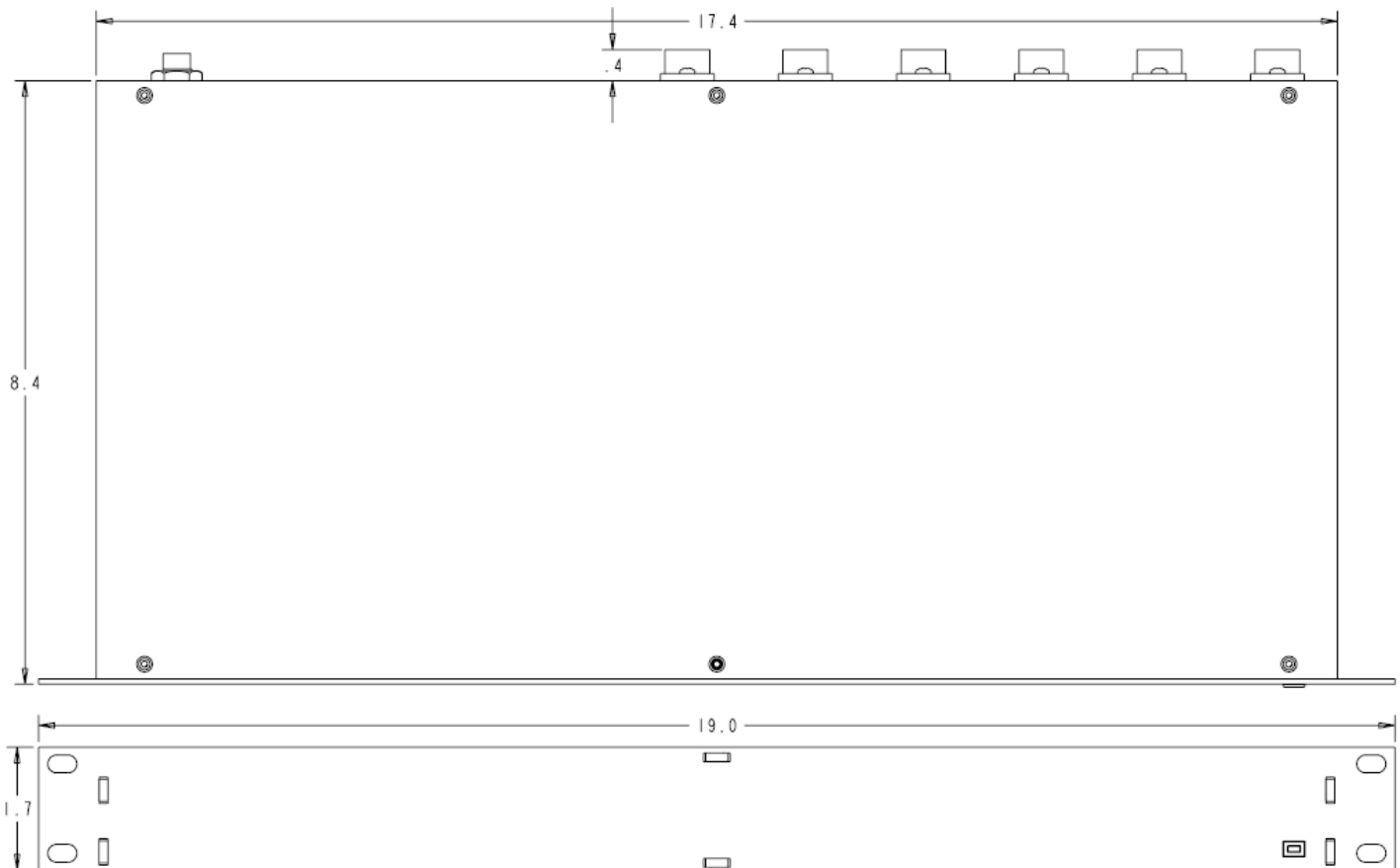

## Warranty

---

Marshall Electronics warrants to the first consumer that this **NCB-1004** LCD monitor will, under normal use, be free from defects in workmanship and materials, when received in its original container, for a period of one year from the purchase date. This warranty is extended to the first consumer only, and proof of purchase is necessary to honor the warranty. If there is no proof of purchase provided with a warranty claim, Marshall Electronics reserves the right not to honor the warranty set forth above. Therefore, labor and parts may be charged to the consumer. This warranty does not apply to the product exterior or cosmetics. Misuse, abnormal handling, alterations or modifications in design or construction void this warranty. *It is considered normal for a minimal amount of pixels, not to exceed three, to fail on the periphery of the display active viewing area.* Marshall Electronics reserves the option to refuse service for display pixel failure if deemed unobtrusive to effective use of the monitor by our technicians. No sales personnel of the seller or any other person is authorized to make any warranties other than those described above, or to extend the duration of any warranties on behalf of Marshall Electronics, beyond the time period described above. Due to constant effort to improve products and product features, specifications may change without notice.

**Marshall Electronics, Inc.**

1910 East Maple Ave.  
El Segundo, CA 90245

Tel: (800) 800-6608 / (310) 333-0606 • Fax: 310-333-0688

[www.LCDRacks.com](http://www.LCDRacks.com) • [sales@lcdracks.com](mailto:sales@lcdracks.com)



## Free Manuals Download Website

<http://myh66.com>

<http://usermanuals.us>

<http://www.somanuals.com>

<http://www.4manuals.cc>

<http://www.manual-lib.com>

<http://www.404manual.com>

<http://www.luxmanual.com>

<http://aubethermostatmanual.com>

Golf course search by state

<http://golfingnear.com>

Email search by domain

<http://emailbydomain.com>

Auto manuals search

<http://auto.somanuals.com>

TV manuals search

<http://tv.somanuals.com>