





**marantz**<sup>®</sup>

AV Surround Receiver

**SR4003**

User Guide

	<b>CAUTION</b> <b>RISK OF ELECTRIC SHOCK</b> <b>DO NOT OPEN</b>	
<b>CAUTION: TO REDUCE THE RISK OF ELECTRIC SHOCK, DO NOT REMOVE COVER (OR BACK) NO USER-SERVICEABLE PARTS INSIDE REFER SERVICING TO QUALIFIED SERVICE PERSONNEL</b>		



The lightning flash with arrowhead symbol within an equilateral triangle is intended to alert the user to the presence of uninsulated "dangerous voltage" within the product's enclosure that may be of sufficient magnitude to constitute a risk of electric shock to persons.



The exclamation point within an equilateral triangle is intended to alert the user to the presence of important operating and maintenance (servicing) instructions in the literature accompanying the product.

## WARNING

**TO REDUCE THE RISK OF FIRE OR ELECTRIC SHOCK, DO NOT EXPOSE THIS APPLIANCE TO RAIN OR MOISTURE.**

**CAUTION: TO PREVENT ELECTRIC SHOCK, MATCH WIDE BLADE OF PLUG TO WIDE SLOT, FULLY INSERT.**

**ATTENTION: POUR EVITER LES CHOCS ELECTRIQUES, INTRODUIRE LA LAME LA PLUS LARGE DE LA FICHE DANS LA BORNE CORRESPONDANTE DE LA PRISE ET POUSSER JUSQU'AU FOND.**

### NOTE TO CATV SYSTEM INSTALLER:

This reminder is provided to call the CATV (Cable-TV) system installer's attention to Section 820-40 of the NEC which provides guidelines for proper grounding and, in particular, specifies that the cable ground shall be connected to the grounding system of the building, as close to the point of cable entry as practical.

### NOTE:

This equipment has been tested and found to comply with the limits for a Class B digital device, pursuant to Part 15 of the FCC Rules. These limits are designed to provide reasonable protection against harmful interference in a residential installation. This equipment generates, uses and can radiate radio frequency energy and, if not installed and used in accordance with the instructions, may cause harmful interference to radio communications. However, there is no guarantee that interference will not occur in a particular installation. If this equipment does cause harmful interference to radio or television reception, which can be determined by turning the equipment off and on, the user is encouraged to try to correct the interference by one or more of the following measures:

- Reorient or relocate the receiving antenna.
- Increase the separation between the equipment and receiver.
- Connect the equipment into an outlet on a circuit different from that to which the receiver is connected.
- Consult the dealer or an experienced radio/TV technician for help.

### NOTE:

Changes or modifications may cause this unit to fail to comply with Part 15 of the FCC Rules and may void the user's authority to operate the equipment.

This Class B digital apparatus complies with Canadian ICES-003.

Cet appareil numerique de la Classe B est conforme a la norme NMB-003 du Canada.

## DECLARATION OF CONFORMITY

This device complies with Part 15 of the FCC rules. Operation is subject to the following conditions: (1) This device may not cause harmful interference, and (2) this device must accept any interference received, including interference that may cause undesired operation.

**U.S. Responsible Party: Marantz America, Inc.**  
**100 Corporate Drive,**  
**Mahwah, NJ, 07430, U.S.A.**  
**TEL: 201-741-6500**

Type of Product: Receiver

Model: SR4003

# IMPORTANT SAFETY INSTRUCTIONS

## READ BEFORE OPERATING EQUIPMENT

This product was designed and manufactured to meet strict quality and safety standards. There are, however, some installation and operation precautions which you should be particularly aware of.

1. Read these instructions.
2. Keep these instructions.
3. Heed all warnings.
4. Follow all instructions.
5. Do not use this apparatus near water.
6. Clean only with dry cloth.
7. Do not block any ventilation openings. Install in accordance with the manufacture's instructions.
8. Do not install near any heat sources such as radiators, heat registers, stoves, or other apparatus (including amplifiers) that produce heat.
9. Do not defeat the safety purpose of the polarized or grounding-type plug. A polarized plug has two blades with one wider than the other. A grounding type plug has two blades and a third grounding prong. The wide blade or the third prong are provided for your safety. If the provided plug does not fit into your outlet, consult an electrician for replacement of the obsolete outlet.
10. Protect the power cord from being walked on or pinched particularly at plugs, convenience receptacles, and the point where they exit from the apparatus.
11. Only use attachments/accessories specified by the manufacturer.
12. Use only with the cart, stand, tripod, bracket, or table specified by the manufacturer, or sold with the apparatus. When a cart is used, use caution when moving the cart/apparatus combination to avoid injury from tip-over.



13. Unplug this apparatus during lightning storms or when unused for long periods of time.
14. Refer all servicing to qualified service personnel. Servicing is required when the apparatus has been damaged in any way, such as power-supply cord or plug is damaged, liquid has been spilled or objects have fallen into the apparatus, the apparatus has been exposed to rain or moisture, does not operate normally, or has been dropped.

### Additional Safety Information!

- This product should not be placed in a built-in installation such as a bookcase or rack unless proper ventilation is provided or the manufacturer's instructions have been adhered to.
- Apparatus shall not be exposed to dripping or splashing and that no objects filled with liquids, such as vases, shall be placed on the apparatus.
- When the switch is in the OFF position, the apparatus isn't completely switched-off from the MAINS.
- The equipment shall be installed near the power supply so that the power supply is easily accessible.
- Do not touch hot spots during and immediately after use.
- During and immediately after use, this product is hot in areas other than the controls and rear panel connection jacks.
- Do not touch hot spots and especially the top panel. Contact with hot areas can cause burns.
- Do not expose the unit and batteries to excessive heat such as direct sunlight, fire or the like.
- Make a space of about 8 inches (0.2 m) around the unit.

# INTRODUCTION

Thank you for purchasing the Marantz SR4003 Surround receiver. This remarkable component has been engineered to provide you with many years of home theater enjoyment. Please take a few minutes to read this manual thoroughly before you connect and operate the SR4003. As there are a number of connection and configuration options, you are encouraged to discuss your own particular home theater setup with your Marantz authorized dealer.

## ACCESSORIES CHECK

Before use, check the below accessories were included in the package.

### Remote Controller

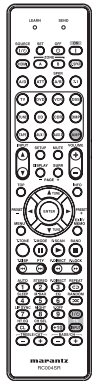

### AM Loop Antenna

### FM Antenna

### AC Power Cable

### Warranty Card USA × 1 Canada × 1

### AAA-size batteries (× 2)

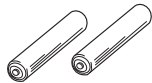

### Microphone MC-10

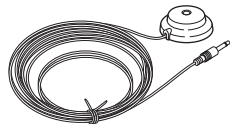

### User Guide



# TABLE OF CONTENTS

<b>INTRODUCTION</b> .....	<b>1</b>	<b>ADVANCED CONNECTIONS</b> .....	<b>18</b>
ACCESSORIES CHECK .....	1	CONNECTING MULTI CHANNEL AUDIO COMPONENT .....	18
<b>TABLE OF CONTENTS</b> .....	<b>1</b>	CONNECTING AN EXTERNAL POWER AMPLIFIER .....	18
<b>FEATURES</b> .....	<b>2</b>	CONNECTING THE REMOTE CONTROL JACKS.....	19
<b>BEFORE USE</b> .....	<b>2</b>	<b>SETUP</b> .....	<b>20</b>
OPERATION OF REMOTE CONTROLLER.....	3	ON SCREEN DISPLAY MENU SYSTEM .....	20
<b>NAMES AND FUNCTIONS</b> .....	<b>4</b>	1 INPUT SETUP (ASSIGNABLE DIGITAL INPUT AND COMPONENT VIDEO INPUT).....	21
FRONT PANEL.....	4	2 SPEAKER SETUP.....	21
FL DISPLAY AND INDICATOR .....	5	3 PREFERENCE .....	24
REMOTE CONTROLLER .....	6	4 SURROUND .....	24
REAR PANEL .....	8	5 PL <b>II</b> x (PRO LOGIC <b>II</b> x) MUSIC PARAMETER .....	25
<b>BASIC CONNECTIONS</b> .....	<b>9</b>	6 CS <b>II</b> (CIRCLE SURROUND <b>II</b> ) PARAMETER .....	25
SPEAKER PLACEMENT .....	9	7 7.1 CH INPUT LEVEL.....	25
CONNECTING SPEAKERS.....	10	<b>ADVANCED OPERATION</b> .....	<b>26</b>
CONNECTING AUDIO COMPONENTS.....	11	AMP OPERATION .....	26
CONNECTING VIDEO COMPONENTS.....	12	SURROUND SPEAKER B SYSTEM .....	30
CONNECTING HDMI COMPONENTS.....	13	TUNER OPERATION (PRESET MEMORY).....	30
CONNECTING THE ANTENNA TERMINALS.....	14	REMOTE CONTROLLER OPERATION .....	32
CONNECTING THE AC POWER CABLE .....	14	BASIC OPERATION (REMOTE CONTROLLER) .....	34
<b>BASIC OPERATION</b> .....	<b>15</b>	<b>TROUBLESHOOTING</b> .....	<b>36</b>
AMP OPERATION .....	15	FRONT KEY (BUTTON) LOCK OF THE UNIT .....	37
TUNER OPERATION .....	16	GENERAL MALFUNCTION .....	37
REMOTE CONTROLLER OPERATION.....	17	HOW TO RESET THE UNIT .....	37
		<b>OTHERS</b> .....	<b>38</b>
		SURROUND MODE .....	38
		DESCRIPTION .....	40
		TECHNICAL SPECIFICATIONS .....	42
		CLEANING OF EQUIPMENT EXTERNAL SURFACES .....	42
		REPAIRS.....	42

NAMES AND FUNCTIONS  
BASIC CONNECTIONS  
BASIC OPERATION  
ADVANCED CONNECTIONS  
SETUP  
TROUBLESHOOTING  
ADVANCED OPERATION  
OTHERS

## FEATURES

This unit incorporates the latest generation of digital surround sound decoding technology such as Dolby Digital EX, Dolby Digital, DTS-ES (Discrete 6.1 and Matrix 6.1), DTS Neo:6 (Cinema, Music), Dolby Pro-Logic IIx (Movie, Music and Game), Circle Surround II (Cinema and Music).

In addition, Marantz has focused on the future. By utilizing pre-out jacks, 7.1 direct inputs, the unit is tomorrow's technology, today!

This unit features a fully discrete 7 channel amplifier section capable of delivering 80 watts of high-current amplification, for continuously clean and stable power into each of the 7 channels. It employs a massive EI power transformer in combination with oversized filter capacitors. This design configuration is capable of a clear and powerful reproduction of the most demanding action movie soundtracks and full range (multichannel) music discs. Through its ability to generate very high output voltages, the unit can easily drive the most demanding speakers with optimum results.

This unit incorporates the most advanced Digital Signal Processing circuitry, along with a Crystal® 192 kHz/24 bit D/A converter in each of the 7 channels. Independent power supply circuits are incorporated for the FL display, audio and video sections for maximum separation, clarity and dynamic range. Together with hand-selected customized components, all elements work in harmony to recreate the emotion, exactly as the artist had intended.

An easy-to-use universal remote controller allows full access to all of the operating functions and can be used for system operation as well.

- Dolby Digital EX, Dolby Digital
- Dolby Pro Logic IIx (Movie, Music, Game)
- Dolby Headphone 2
- DTS ES (Discrete 6.1, Matrix 6.1)
- DTS 96/24
- DTS Neo:6
- Circle Surround II (Movie, Music, Mono)
- HDCD decoding
- MRAC (Marantz Room Acoustic Calibration) available
- Improved Station Name Input Method, 50 Presets
- Auto Adjust Function for Speaker Distance Settings (Delay Time)
- 7 × 80 Watts (8 Ohm), Discrete Amplifiers
- Massive Energy Power Supply, Huge EI Transformer.
- 192 kHz/24 bit Crystal® DAC for all 8 Channels
- 32 bit Digital Surround Processing Chipsets
- Large Heavy Duty Speaker Terminals for all Channels
- Auto Input Signal Detection
- Front AUX Input (Digital Camera, Portable DVD)
- Video Off Mode
- Set Up Menu via all Video Output (Composite, S-Video and Component video)
- Video convert system
- Learning backlight remote controller
- HDMI (Ver. 1.1) 3 Input/1 Output

## BEFORE USE

This section must be read before any connection is made to the mains supply.

### EQUIPMENT MAINS WORKING SETTING

Your Marantz product has been prepared to comply with the household power and safety requirements that exist in your area. SR4003 can be powered by 120V AC only.

### COPYRIGHT

Recording and playback of any material may require consent. For further information refer to the following:

- Copyright Act 1956
- Dramatic and Musical Performers Act 1958
- Performers Protection Acts 1963 and 1972
- Any subsequent statutory enactments and orders

### DO NOT LOCATE IN THE FOLLOWING PLACES

To ensure long-lasting use, do not locate the unit where:

- Exposed to direct sunlight.
- Near to sources of heat such as heaters.
- Highly humid or poorly ventilated.
- Dusty.
- Subjected to mechanical vibrations.
- On wobbly, inclined or otherwise unstable surfaces
- Radiated heat is blocked such as in cramped audio racks.

To ensure proper heat radiation, ensure the below clearance from walls and other equipment.

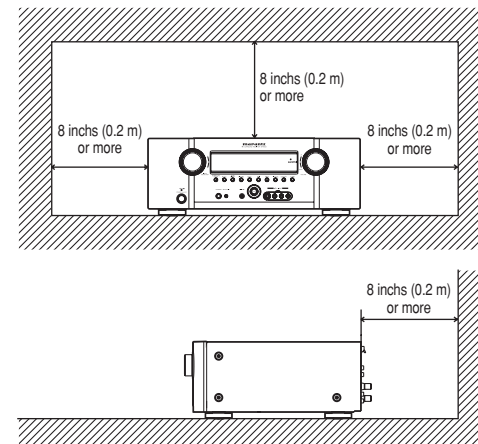

### KEEP OBJECTS OFF

Keep objects off the unit. Blocking the vent can result in accident and damage.

### DO NOT TOUCH HOT SPOTS DURING AND IMMEDIATELY AFTER USE

During and immediately after use, the unit is hot in areas other than the controls and rear panel connection jacks. Do not touch hot spots and especially the top panel. Contact with hot areas can cause burns.

## OPERATION OF REMOTE CONTROLLER

### REMOTE CONTROL

Operate the remote controller within a distance of approx. 5m from the infrared receptor window on the front of the unit.

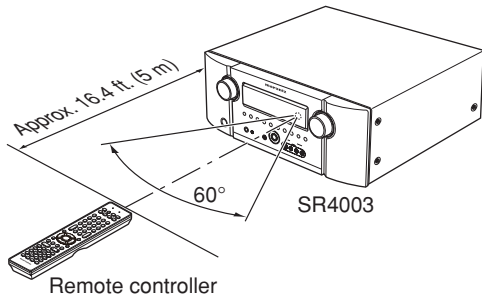

#### Caution:

- Do not allow direct sunlight, an inverter fluorescent light or other strong source of light to shine onto the player's infrared receptor window. Otherwise, the operation of the remote controller may be disabled.
- Bear in mind that operating the remote controller may cause other devices operated by infrared rays to be operated by mistake.
- The remote controller cannot be operated if the space between the controller and the player's infrared receptor window is obstructed.
- Do not place any objects on top of the remote controller. Doing so may cause one or more buttons to be held down which will cause the batteries to run down.

### LOADING BATTERIES

Before using the remote controller for the first time, load the batteries in the remote controller. The batteries provided are used to verify the operations of the remote controller only.

1. Remove the battery cover.

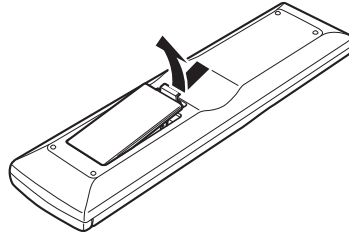

2. Load the two new size "AAA" batteries inside the battery compartment while taking care to align their polarities correctly with the polarity markings (+ with (+ and - with (-).

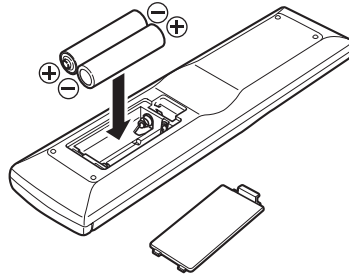

3. Close the battery cover until it clicks shut.

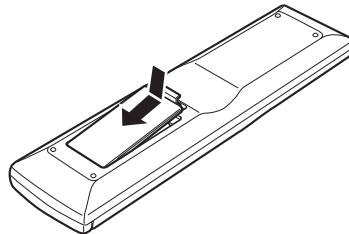

### CAUTIONS ON BATTERIES

- Use "AAA" type batteries in this remote controller.
- We recommend that you use alkali batteries.
- If the remote controller does not operate from close to the unit, replace the batteries with new ones, even if less than a year has passed.
- The included battery is only for verifying operation. Replace it with a new battery as soon as possible.
- When inserting the batteries, be careful to do so in the proper direction, following the + and - marks in the remote controller's battery compartment.
- To prevent damage or battery fluid leakage:
  - Do not use a new battery with an old one.
  - Do not use two different types of batteries.
  - Do not short-circuit, disassemble, heat or dispose of batteries in flames.
- Remove the batteries when not planning to use the remote controller for a long period of time.
- If the batteries should leak, carefully wipe off the fluid from the inside of the battery compartment, then insert new batteries.
- When disposing of used batteries, please comply with governmental regulations or environmental public instruction's rules that apply in your country or area.

# NAMES AND FUNCTIONS

## FRONT PANEL

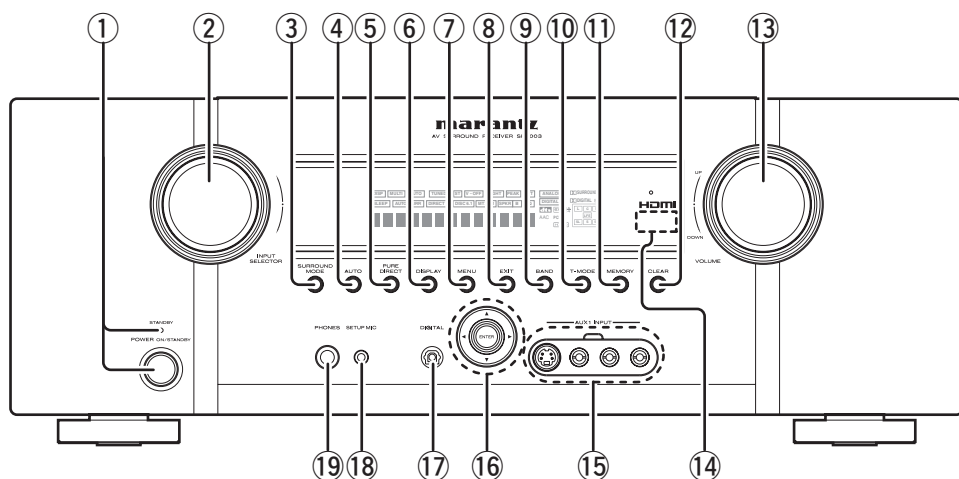

### ① POWER switch and STANDBY indicator

When this switch is pressed once, the unit turns ON and the display illuminates. When pressed again, the unit turns OFF and the STANDBY indicator will be illuminated.

### ② INPUT SELECTOR knob (AUDIO/VIDEO)

This knob is used to select the input sources. (See page 15)

### ③ SURROUND MODE button

Press this button to select the surround mode.

### ④ AUTO (Auto surround) button

Press this button to select the AUTO mode from the surround modes. When this mode is selected, the unit determines the surround mode corresponding to a digital input signal automatically.

### ⑤ PURE DIRECT button and indicator

When this button is pressed once, "SOURCE DIRECT" appears on the FL display. If pressed again, "PURE DIRECT" appears. After 2 seconds, the FL display indication goes out, and then the video output signal stops.

In the source/pure direct mode, the tone control circuitry and bass management are bypassed.

#### Notes:

- The surround mode is automatically switched to AUTO when the pure direct/source direct function is turned on.
- Additionally, speaker configurations are fixed automatically as follows.  
Front SPKR = LARGE  
Center SPKR = LARGE  
Surround SPKR = LARGE  
Surround Back SPKR = LARGE  
Sub woofer = YES

### ⑥ DISPLAY button

Press this button to change the FL display mode. (See page 26)

### ⑦ MENU button

Press this button to enter the SETUP MAIN MENU.

### ⑧ EXIT button

Press this button to exit from the SETUP MAIN MENU.

### ⑨ BAND button

Press this button to switch between FM and AM in the TUNER mode.

### ⑩ T-MODE button

Press this button to select the auto stereo mode or mono mode when the FM band is selected. "AUTO" indicator will be illuminated in the display. (See page 16)

### ⑪ MEMORY button

Press this button to enter the tuner preset memory numbers or station names. (See page 30)

### ⑫ CLEAR button

Press this button to cancel the station-memory setting mode or preset scan tuning. (See page 31)

### ⑬ VOLUME control knob

This knob is used to adjust the overall sound level. Turning the control clockwise increases the sound level. (See page 15)

### ⑭ INFRARED receiving sensor area

This area receives infrared signals for the remote control.

### ⑮ AUX1 INPUT jacks

These auxiliary video/audio input jacks accept the connections of a camcorder, portable DVD, game etc. These jacks are protected by the jack cover when these are not using.

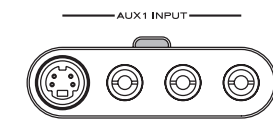

↓ Open and close the cover using the tab.

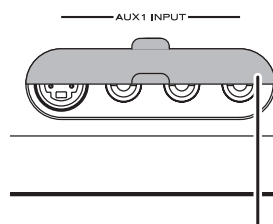

Front AUX jack cover

### ⑯ Cursor (◀, ▶, ▲, ▼) / ENTER button

Press these buttons to operate the SETUP MAIN MENU and TUNER function.

### ⑰ DIGITAL INPUT (Front)

This is the optical digital audio input terminal. The inputs accept digital audio signals from a DMP, GAME, or other digital source component.

### ⑱ SETUP MIC jack

Automatically measure speaker characteristics using the included microphone (MC-10). (See page 23)

### ⑲ HEADPHONE jack for stereo headphones

This jack may be used to listen to the unit's output through a pair of headphones. Be certain that the headphones have a standard 1 / 4" stereo phono plug.

## FL DISPLAY AND INDICATOR

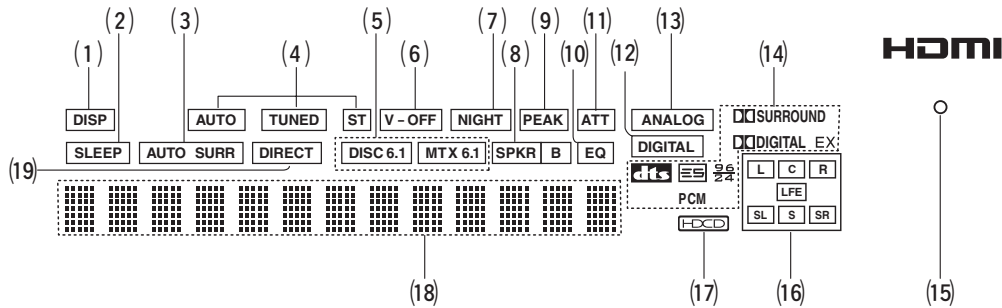
**(1) DISP (Display Off) indicator**

This indicator is illuminated when this unit is in the display off mode.

**(2) SLEEP timer indicator**

This indicator is illuminated when the sleep timer function in the main-room is in use.

**(3) AUTO SURR (Auto Surround mode) indicator**

This indicator is illuminated to show that the AUTO SURROUND mode is in use.

**(4) TUNER's indicators**

**AUTO** : This indicator illuminates when the tuner's Auto mode is in use.

**TUNED** : This indicator illuminates when the tuner receives a sufficiently strong radio signal.

**ST(Stereo)** : This indicator illuminates when an FM station is being tuned into stereo condition.

**(5) DTS-ES mode indicators (DISC6.1, MTX6.1)**

These indicators will illuminate to show the DTS-ES decoding mode (Discrete 6.1 or Matrix 6.1).

**(6) V (video)-OFF mode indicator**

This indicator is illuminated when the Video-OFF function is active.

**(7) NIGHT mode indicator**

This indicator is illuminated when this unit is in the Night mode, which reduces the dynamic range of digital program material at low volume levels.

**(8) SPKR (speaker) B indicator**

This indicator is illuminated when the S (Surround) speaker B system is active.

**(9) PEAK indicator**

This indicator is a monitor for an analog audio input signal. If the selected analog audio input signal is greater than the capable level of internal processing, this will illuminate. If this happens, you should press the **ATT** button on the remote controller.

**(10) EQ mode indicator**

This indicator is illuminated when the HT-EQ function is active.

**(11) ATT (Attenuation) indicator**

This indicator is illuminated when the attenuation function is active.

**(12) DIGITAL Input Indicator**

This indicator is illuminated when a digital input has been selected.

**(13) ANALOG input indicator**

This indicator is illuminated when an analog input source has been selected.

**(14) SIGNAL FORMAT indicators****DIGITAL**

This indicator is illuminated when a Dolby Digital signal is input.

**EX**

This indicator is illuminated when a Dolby Digital EX signal is input.

**dts**

This indicator is illuminated when a DTS signal is input.

**ES**

This indicator is illuminated when a DTS ES signal is input.

**96/24**

This indicator is illuminated when a DTS 96/24 signal is input.

**PCM**

This indicator is illuminated when the input signal is PCM (pulse code modulation).

**SURROUND**

This indicator is illuminated when a Dolby Surround signal is input.

**(15) HDMI indicator**

This indicator is illuminated when input terminal of the HDMI component is connected to the unit.

**(16) ENCODED CHANNEL STATUS indicators**

These indicators display the channels that are encoded with a digital input signal.

If the digital input signal is Dolby Digital 5.1ch or DTS 5.1ch, "L", "C", "R", "SL", "SR" and "LFE" will be illuminated.

If the digital input signal is 2 channel PCM-audio, "L" and "R" will be illuminated.

If the digital input signal is Dolby Digital 5.1ch signal with Surround EX flag or DTS-ES, "L", "C", "R", "SL", "S", "SR" and "LFE" will be illuminated.

**(17) HDCD indicator**

This indicator is illuminated when the HDCD signal is decoded from digital input signal.

**(18) Main Information Display**

This display shows messages relating to the status, input source, surround mode, tuner, volume level or other aspects of unit's operation.

**(19) DIRECT (Puredirect) indicator**

This indicator is illuminated when this unit is in the SOURCE DIRECT or PURE DIRECT mode.



REMOTE CONTROLLER

The provided remote controller is a universal remote controller. The **POWER** button, numeric buttons and control buttons are used in common across different input source components. The input source controlled with the remote controller changes when one of the input selector buttons is pressed.

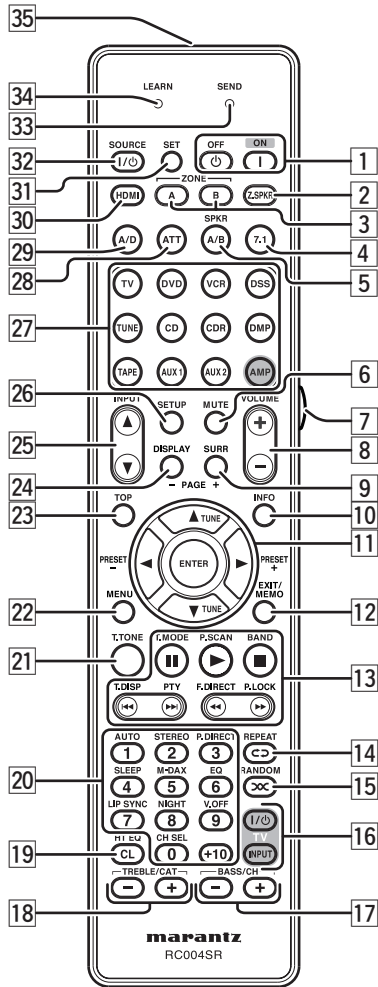

1 | / ⏻ POWER ON and OFF buttons

*(When AMP mode is selected)*

These buttons are used to turn the unit on or off.

2 | Z.SPKR button

This button is used to select the surround speaker B Mode.

3 | ZONE A / B button

These buttons are not used for this unit.

4 | 7.1 (7.1CH IN) button

This button is used to select the output of an external multi channel decoder.

5 | SPKR A/B button

This button is not used for this unit.

6 | MUTE button

This button is used to mute the audio for the amplifier.

7 | LIGHT button

This button is used to turn on the backlight for the buttons.

8 | VOLUME +/- buttons

These buttons are used to adjust the volume for the amplifier.

9 | SURR (SURROUND) button

*(When AMP mode and a mode other than DMP mode are selected)*

This button is used to selects the surround mode.

10 | INFO button

*(When AMP mode is selected)*

When this button is pressed, the current setting of AV receiver are displayed on the connected TV monitor.

11 | ◀, ▶, ▲, ▼ (CURSOR) / ENTER buttons

These buttons are used when controlling the cursor of the unit, DVD or other AV equipment.

*(When Tuner mode mode is selected)*

**PRESET + / PRESET - buttons**

Used to select a preset station up and down.

**TUNE ▲ / TUNE ▼ buttons**

Used to tune a frequency station up and down.

12 | EXIT / MEMO button

*(When AMP mode is selected)*

This button is used to cancel setting in the setup menu.

*(When TUNER mode is selected)*

This button is used to store the setting of preset channel and others.

13 | CONTROL buttons

These buttons are used when operating PLAY, STOP, PAUSE and other commands of a source.

*(When TUNER mode is selected)*

**T.MODE button**

This button is used to select auto stereo mode or mono mode when the FM band is selected.

The "AUTO" indicator lights in the auto stereo mode.

**P.SCAN button**

This button is used to start preset scan.

**BAND button**

This button is used to select a radio band.

**T.DISP button**

This button is not used for this unit.

**PTY button**

This button is not used for this unit.

**F.DIRECT button**

This button is used to select the "Frequency direct input".

**P.LOCK button**

This button is not used for this unit.

14 | REPEAT ⏮ button

This button is used to select the REPEAT mode of a source.

15 | RANDOM ⏮ button

This button is used to select the RANDOM mode of a source.

16 | TV CONTROL buttons

These buttons are used to control the TV or monitor.

17 | BASS / CH +/- buttons

*(When AMP mode is selected)*

These buttons are used to adjust the tone control of low frequency sound for left, right and subwoofer speaker.

*(When TV/DSS mode are selected)*

These buttons are used to change the channels.

18 | TREBLE / CAT +/- buttons

*(When AMP mode is selected)*

These buttons are used to adjust the tone control of high frequency sound for left and right speaker.

19 | CL (Clear) / HT EQ button

This button is used to erase the memory or program of a source include the Tuner mode.

*(When AMP mode is selected)*

This button is used to turn on or off HT(Home Theater)-EQ mode.

**20 Numeric buttons**

These buttons are used to switch between 0 to +10 of the source components.  
If the source is set to the amplifier, these buttons are used to perform operations.

*(When AMP mode is selected)*

**1/AUTO button**

This button is used to select auto surround.

**2/STEREO button**

This button is used to select STEREO mode.

**3/P.DIRECT button**

When this button is pressed once, SOURCE DIRECT mode is selected.

If pressed again, PURE DIRECT mode is selected.

**4/SLEEP button**

This button is used for setting the sleep timer.

**5/M-DAX button**

This button is not used for this unit.

**6/EQ button**

This button is not used for this unit.

**7/LIP SYNC button**

This button is not used for this unit.

**8/NIGHT button**

Pressing this button prevents the Dolby Digital signal from playback at a loud voice.

When this button is pressed, the "NIGHT" indicator is illuminated.

**9/V.OFF button**

This button is used to turn off the video signal.

**0/CH SEL button**

This button is used to call up CH LEVEL ADJUST and adjust speaker levels or 7.1 ch input level.

**21 T.TONE button**

This button is used to enter the test tone menu.

**22 MENU button**

*(When AMP mode is selected)*

This button is used to call up the SETUP MAIN MENU of the unit.

**23 TOP button**

This button is used during setup to return to the top screen of the Setup Main Menu.

**24 DISPLAY button**

*(When AMP mode and a mode other than DMP mode are selected)*

This button is used to select the display mode for the front display of the unit.

**25 INPUT ▲ button**

This button is for forward-feeding the input source to select a desired source.

**INPUT ▼ button**

This button is for backward-feeding the input source to select a desired source.

**26 SETUP button**

This button is used to setup for DVD and other device.

**27 SOURCE buttons**

These buttons are used to switch the source of your A/V Receiver. Each time a source button is pressed, the remote controller changes to the source which was pressed.

This remote controller can control 12 types of equipment. To change the A/V Receiver source, press this button twice within two seconds. The signal is sent when it is pressed the second time.

**Notes:**

- Select the AMP as the source to use this remote controller with the unit.
- In the case of this unit, the DMP button cannot be used.

**28 ATT button**

When the input signal is too high and the voice distorts even by throttling the unit VOLUME control, turn on this function.

"ATT" is indicated when this function is activated.

The input level reduced. Attenuator is invalid for the output signal of "REC OUT".

**Note:**

This function is unavailable while the digital input is selected.

**29 A/D button**

This button is used to switch between the analog and digital inputs.

**30 HDMI button**

This button is not used for this unit.

**31 SET button**

This button is used to enter the learn mode and the preset mode.

**32 | / ⏻ SOURCE ON/OFF button**

This button is used to turn a specific source (such as a DVD player) on or off independently from the rest of the system.

**33 SEND indicator**

Indicates when the remote controller is transmitting a signal.

**34 LEARN indicator**

Indicates when the remote controller is in the LEARN mode.

**35 Infrared Transmitter and Learning Sensor**

This transmitter emits infrared light. Press the buttons while pointing the transmitter towards the infrared receiver window of the unit or other AV equipment. Be sure to also point towards other remote controllers when using the learning function.

REAR PANEL

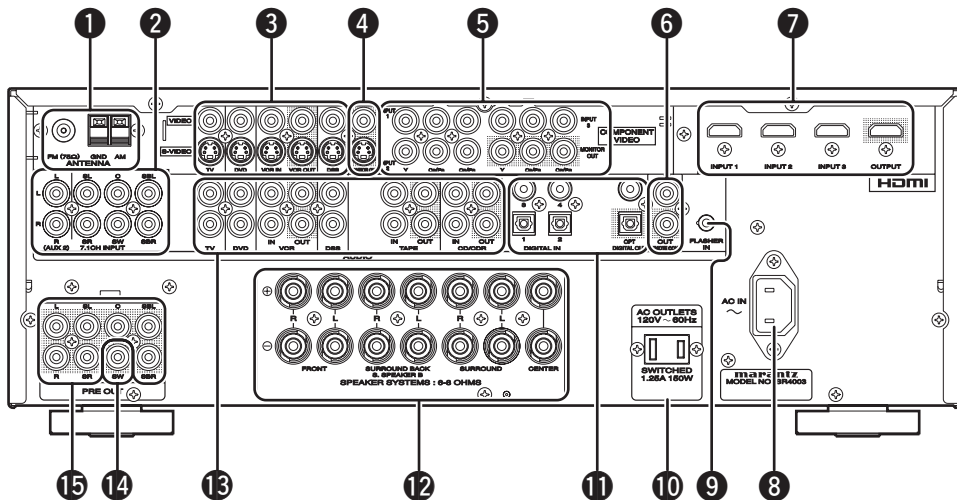

NAMES AND FUNCTIONS  
 BASIC CONNECTIONS  
 BASIC OPERATION  
 ADVANCED CONNECTIONS  
 SETUP  
 ADVANCED OPERATION  
 TROUBLESHOOTING  
 OTHERS

**1 FM antenna terminal (75 ohms)**

Connect an external FM antenna with a coaxial cable, or a cable network FM source.

**AM antenna and ground terminals**

Connect the supplied AM loop antenna. Use the terminals marked "AM" and "GND". The supplied AM loop antenna will provide good AM reception in most areas. Position the loop antenna until you hear the best reception.

**2 7.1 CHANNEL or AUX2 INPUT**

By connecting a DVD Audio player, Super Audio CD multichannel player, or other components that has a multichannel port, you can playback the audio with 5.1 channel or 7.1 channel outputs.

**3 VIDEO IN/OUT (TV, DVD, VCR, DSS)**

These are the video inputs and outputs. There are 4 video inputs and 2 video outputs and each one includes both composite video and S-video configurations. Connect VCRs, DVD players, and other video components to the video inputs. The 2 video output channels can be used to be connected to video tape recorders for making recordings.

**4 MONITOR OUT**

This is a monitor output and each one includes both composite video and S-video configurations. When connecting two video monitors or televisions, be aware that the OSD interface can be used with both MONITOR OUT connections.

**5 COMPONENT VIDEO INPUT/OUTPUT**

If your DVD player or other device has component video connectors, be sure to connect them to these component video connectors on the unit. This unit has two component video input connectors to obtain the color information (Y, C<sub>B</sub>, C<sub>R</sub>) directly from the recorded DVD signal or other video component and one component video output connector to output it directly into the matrix decoder of the display device. By sending the pure DVD component video signal directly, the DVD signal forgoes the extra processing that normally would degrade the image. The result is vastly increased image quality, with incredibly life like colors and crisp detail. When the video convert function is enabled, video and S-video images can be output to the COMPONENT MONITOR OUT jack.

**6 REMOTE CONT. IN/OUT terminals**

Connect to a Marantz component equipped with remote control (RC-5) terminals.

**7 HDMI INPUT/OUTPUT**

This unit has 3 HDMI inputs and 1 HDMI output. The input function can be selected from the OSD menu system. (See page 21)

**8 AC INLET**

Plug the supplied power cable into this AC INLET and then into the power outlet on the wall. This unit can be powered by 120V AC only.

**9 Flasher IN**

This terminal controls the unit from each zone. Connect the control signal from a Keypad, etc.

**10 AC OUTLETS**

Connect the AC power cable of component such as a DVD or CD player to this outlet. This outlet provides power only when this unit is turned on.

**Caution:**

- In order to avoid potential turn-off thumps, anything plugged into this outlet should be powered up before this unit is turned on.
- The capacity of this AC outlet is 150W. Do not connect devices that consume electricity more than the capacity of this outlet. If the total power consumption of the connected devices exceeds the capacity, the protection circuit shuts down the power supply.

**11 DIGITAL INPUT**

These are the digital audio inputs and outputs. This unit has 2 coaxial digital inputs and 2 optical digital inputs. The inputs accept digital audio signals from a CD, DVD, or other digital source component. This unit has 1 optical digital output. The digital output can be connected to MD recorders, CD recorders, or other similar components.

**12 Speaker outputs terminals**

Seven terminals are provided for the front left, front right, front center, surround left, surround right, surround back left and surround back right speakers.

**Note:**

You can use surround back speaker terminals as S (Surround) SPEAKER B terminals, when you use no surround back speaker.

**13 AUDIO IN/OUT (CD, TAPE, CD-R, TV, DVD, VCR, DSS)**

These are the analog audio inputs and outputs. There are 6 audio inputs (4 of which are linked to video inputs) and 3 audio outputs (1 of which are linked to video outputs). The audio jacks are nominally labeled for cassette tape decks, compact disc players, DVD players and etc.... The audio inputs and outputs require RCA-type connectors.

**14 Subwoofer Output**

Connect this jack to the line level input of a powered subwoofer. If an external subwoofer amplifier is used, connect this jack to the subwoofer amplifier input. If you are using two subwoofers, either powered or with a 2 channel subwoofer amplifier, connect a "Y" connector to the subwoofer output jack and run one cable from it to each subwoofer amplifier.

**15 Preamp Outputs (L, R, SL, SR, SBL, SBR, C)**

Jacks for L (front left), R (front right), C (Center), SL (surround left), SR (surround right), SBL (surround back left) and SBR (surround back right). Use these jacks for connection to external power amplifiers.

# BASIC CONNECTIONS

## SPEAKER PLACEMENT

The ideal surround speaker system for this unit is 7-speaker systems, using front left and right speakers, a center speaker, surround left and right speakers, a surround back left and right speakers, and a subwoofer.

For best results we recommend that all front speakers be of the same type, with identical or similar driver units. This will deliver smooth pans across the front sound stage as the action moves from side to side. Your center channel speaker is very important as over 80% of the dialog from a typical motion picture emanates from the center channel.

It should possess similar sonic characteristics to the main speakers. Surround channel speakers need not be identical to the front channel speakers, but they should be of high quality.

The surround back speaker is useful for playback of Dolby Digital Surround EX or DTS-ES. One of the benefits of both Dolby Digital and DTS is that surround channels are discrete full range, while they were frequency limited in earlier "Pro Logic" type systems.

Bass effects are an important part of home theater. For optimal enjoyment a subwoofer should be used as it is optimized for low frequency reproduction. If you have full range front speakers, however, they may be used in place of a subwoofer with proper setting of the switches in the menu system.

Bass effects are an important part of home theater. For optimal enjoyment a subwoofer should be used as it is optimized for low frequency reproduction. If you have full range front speakers, however, they may be used in place of a subwoofer with proper setting of the switches in the menu system.

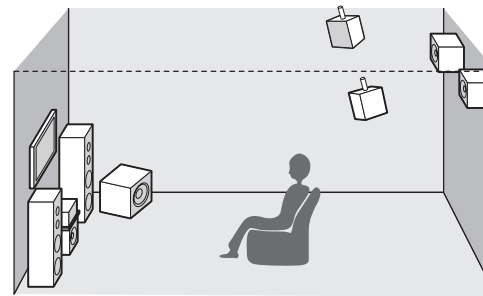
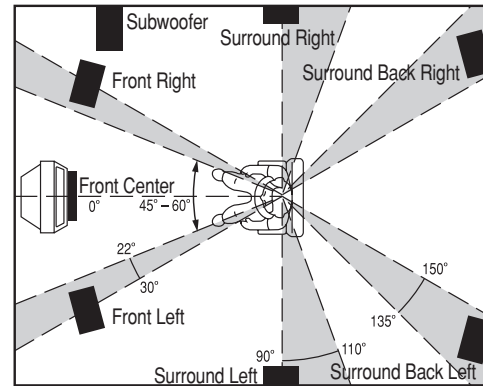

### Front left and right speakers

We recommend to set the front L and R speakers with 45-60 degrees from the listening position.

### Center speaker

Align the front line of the center speaker with the front L/R speakers. Or place the center speaker a little backward from the line.

### Surround left and right speakers

When this unit is used in surround operation, the preferred location for surround speakers is on the side walls of the room, at or slightly behind the listening position.

The center of the center speaker should face the center of the room.

### Surround back left and right speakers

Surround back speakers are required when a full 7.1-channel system is installed.

Speakers should be placed on a rear wall, behind the listening position.

The center of the center speaker should face the center of the room.

### Subwoofer

We recommend using a sub-woofer to have maximum bass effect. As the subwoofer only handles low frequencies, you can place it any where in the room.

## HEIGHT OF THE SPEAKER UNITS

### Front left and right speakers, and a center speaker

Align the tweeters and mid-range drivers on the three front speakers at the same height, as best as possible.

### Surround left and right speakers, and surround back speaker

Place the surround left, right and surround back speakers higher than your ears by about 27-9/16 – 39-3/8 inches (70cm – 1m). Also place the speakers at the same height, as best as possible.

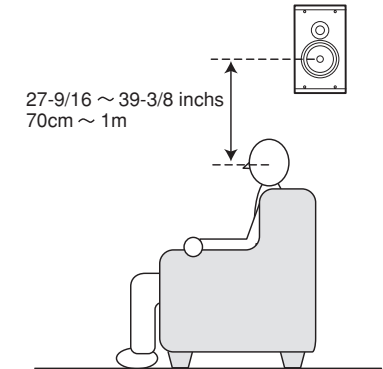

### Note:

Use magnetically-shielded speakers for front left, right and the center speakers when the speakers are installed near the TV.

## CONNECTING SPEAKERS

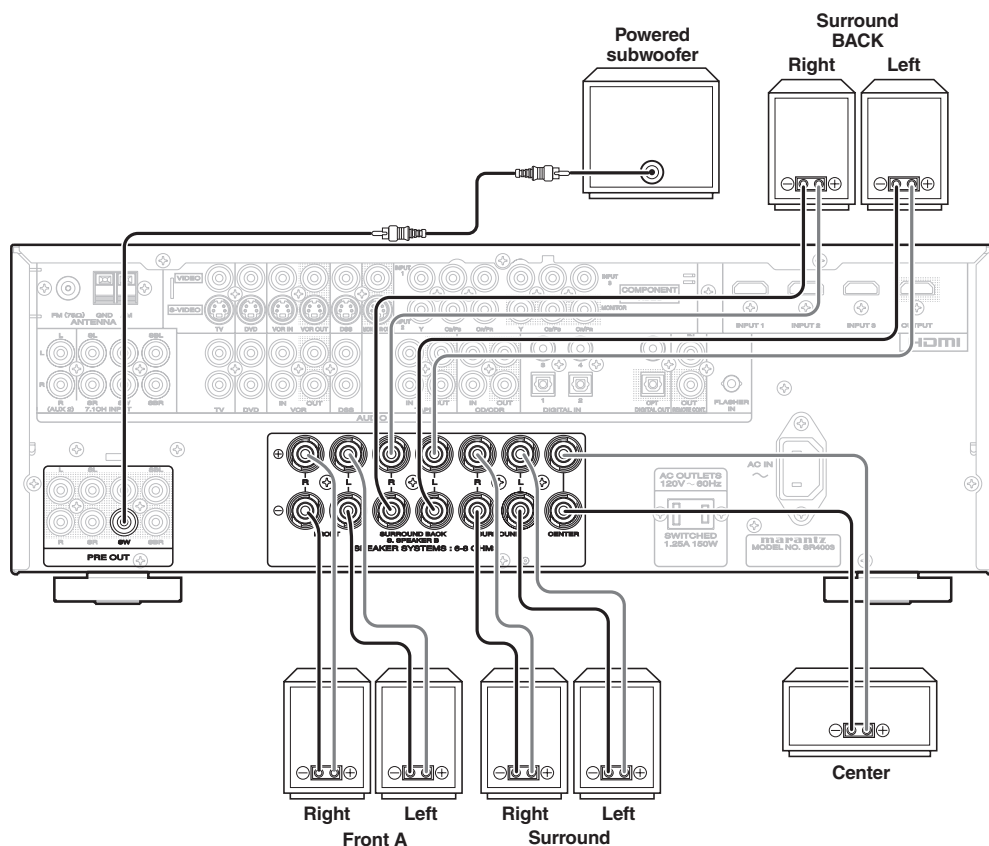

## CONNECTING SPEAKER WIRE

1. Strip away approx. 3/8 inch (10 mm) of wire insulation.
2. Twist the bared wire ends tight, to prevent short circuits.
3. Loosen the knob by turning it counterclockwise.
4. Insert the bare part of the wire into the hole in side of each terminal.
5. Tighten the knob by turning it clockwise to secure the wire.

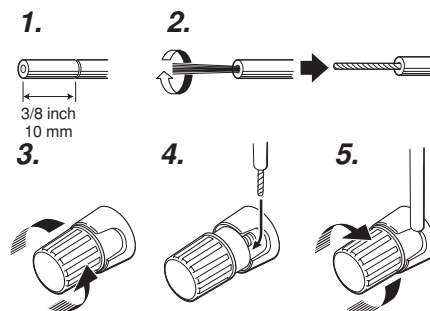
**Caution:**

- Be sure to use speakers with the specified impedance as shown on the rear panel of this unit.
- To prevent damage to circuitry, do not let the bare speaker wires touch each other and do not let them touch any metal part of this unit.
- Do not touch the speaker terminals when the power is on. It may cause you to receive an electric shocks.
- Do not connect more than one speaker cable to one speaker terminal. Doing so may damage this unit.

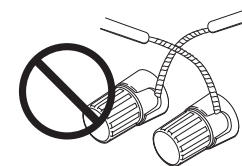
**Note:**

Be sure to connect the positive and negative cables for the speaker properly. If they are miss-connected, the signal phase will be reversed and the signal quality will be corrupted.

## CONNECTING A SUBWOOFER

Use the PRE OUT SUBWOOFER jack to connect a powered subwoofer (power amplifier built in).

CONNECTING AUDIO COMPONENTS

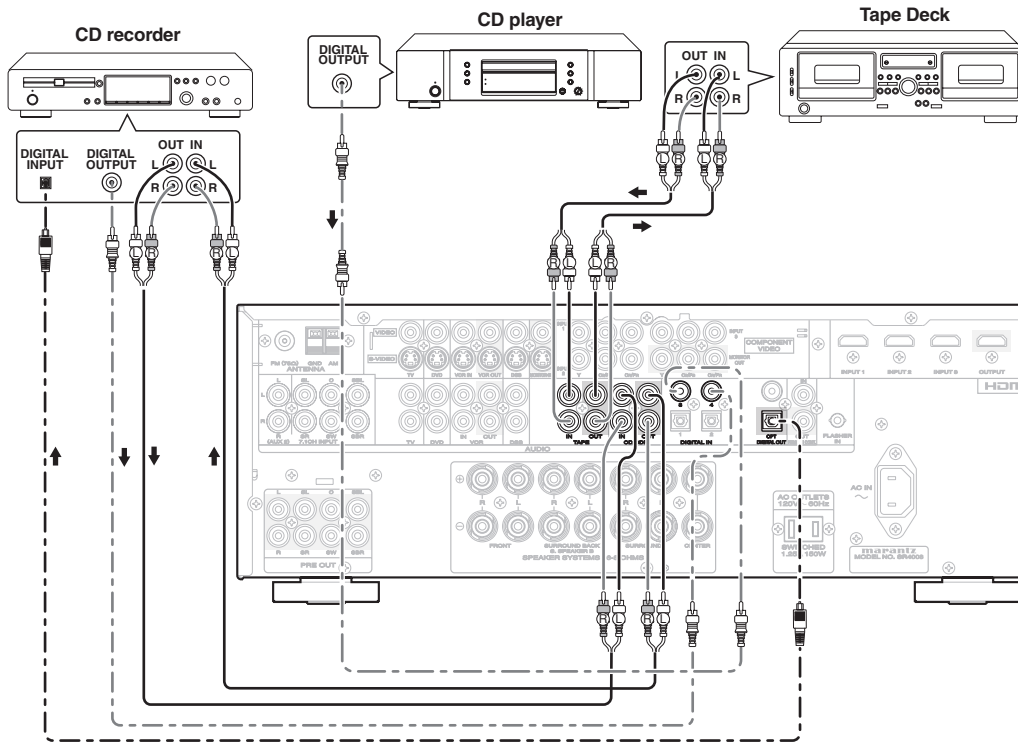

Analog Audio

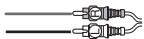

Digital Audio (coaxial)



Digital Audio (optical)



The output audio signal from the TAPE OUT jack and the CD/CD-R OUT jack is the same signal which is currently selected.

**Caution:**

Do not connect this unit and other components to mains power until all connections between components have been completed.

**Notes:**

- Insert all plugs and connectors securely. Incomplete connections may make noise.
- Be sure to connect the left and right channels properly. Red connectors are for the R (right) channel, and white connectors are for the L (left) channel.
- Be sure to connect input and output properly.
- Refer to the instructions for each component that is connected to this unit.
- Do not bind audio/video connection cables with power cords and speaker cables this will result in generating a hum or other noise.

CONNECTING DIGITAL AUDIO COMPONENTS

- There are 4 digital inputs, 2 coaxial jacks and 2 optical jacks, on the rear panel. You can use these jacks to input PCM, Dolby Digital and DTS bitstream signals from a CD, DVD, or other digital source components.
- There is one optical output jack on the rear panel. These jacks can be connected to a CD recorder, or a MD deck inputs, respectively.
- Refer to the instructions for each component. To setup the digital audio format of DVD player, or other digital source's connected to digital input jacks.
- Use fiber optical cables (optical) for DIG-1,2, input jacks. Use 75 ohms coaxial cables (for digital audio or video) for DIG-3,4, input jacks.
- You can designate the input for each digital input/output jacks according to your component. See page 21.

**Notes:**

- There is no Dolby Digital RF input jack. Please use an external RF demodulator Dolby Digital decoder when connecting the Dolby Digital RF output jack of the video disc player to the digital input jack.
- The digital signal jacks on this unit conform to the EIA standard. If you use a cable that does not conform to this standard, this unit may not function properly.
- Each type of audio jack works independently. Signals input through the digital and analog jacks are output through the corresponding digital and analog jacks, respectively.

CONNECTING VIDEO COMPONENTS

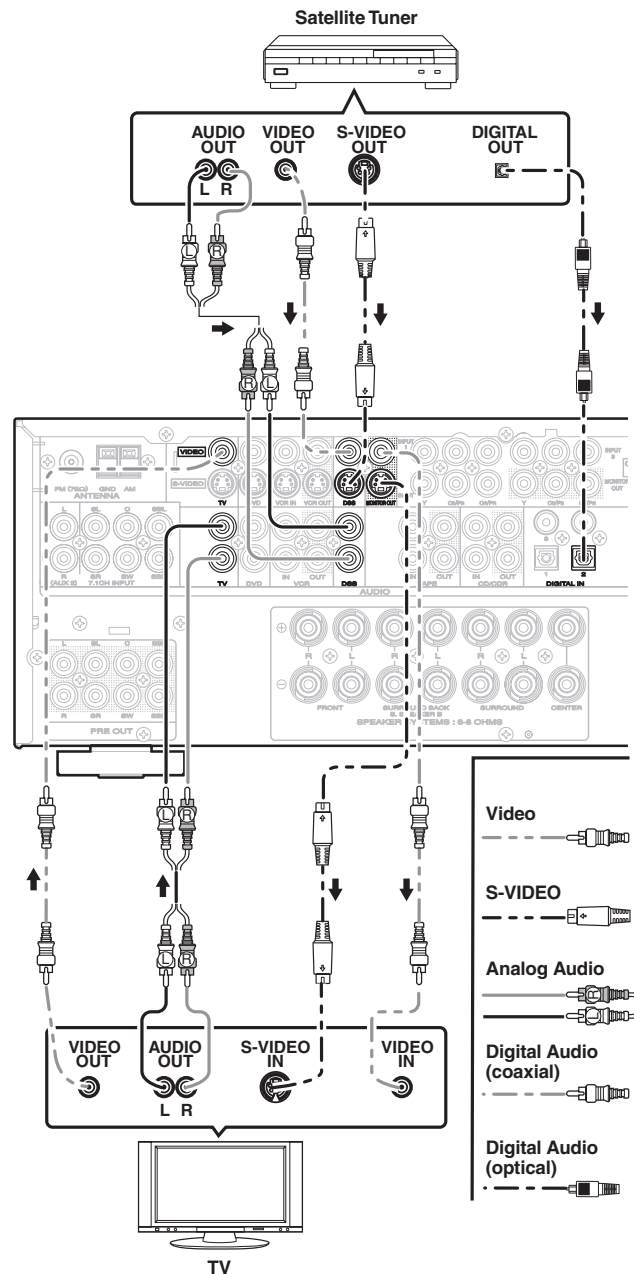
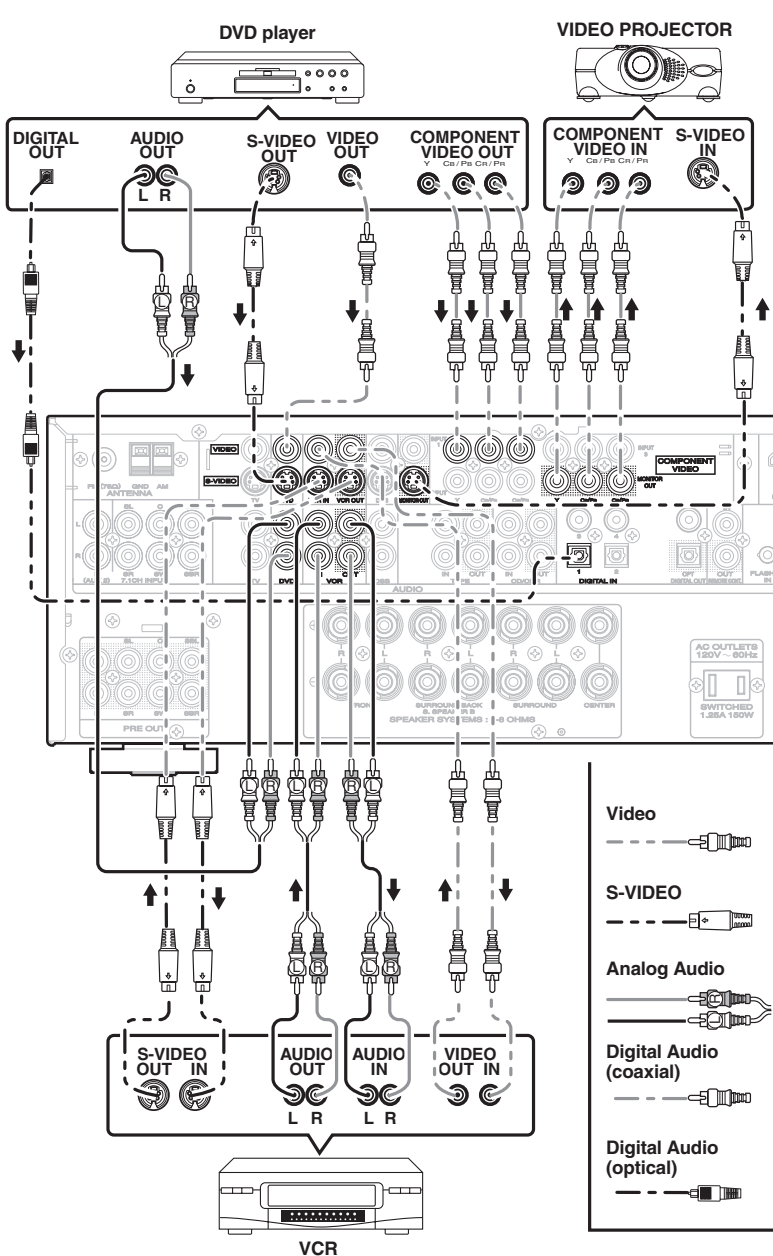

VIDEO, S-VIDEO, COMPONENT JACKS

There are 3 types of video jacks on the rear panel.

**VIDEO jack**

The video signal for the VIDEO jacks is the conventional composite video signal.

**S-VIDEO jack**

The video signal is separated into luminance (Y) and color (C) signals for the S-VIDEO jack. The S-VIDEO signals enables high-quality color reproduction. If your video component has an S-VIDEO output, we recommend to use it. Connect the S-VIDEO output jack on your video component to the S-VIDEO input jack on this unit.

**Component jack**

Make component video connections to a TV or monitor with component inputs to produce higher quality video images. Use a component video cable or 3 video cords to connect the component video out jacks on the unit to the monitor.

**Notes:**

- Be sure to connect the left and right audio channels properly. Red connectors are for the R (right) channel, and white connectors are the for L (left) channel.
- Be sure to connect the inputs and outputs of the video signals properly.
- This unit has the "TV-AUTO ON/OFF" function to turn the TV ON or OFF automatically, by sensing the incoming video signal from the VIDEO jacks.
- You may need to setup the digital audio output format of your DVD player, or other digital source components. Refer to the instructions of the each component connected to the digital input jacks.
- There is no Dolby Digital RF input jack. Use an external RF demodulator with a Dolby Digital decoder to connect the Dolby Digital RF output jack of the DVD player to the digital input jack on this unit.
- For details concerning the connection of Video equipment, please see VIDEO CONVERT (page 29).

## CONNECTING HDMI COMPONENTS

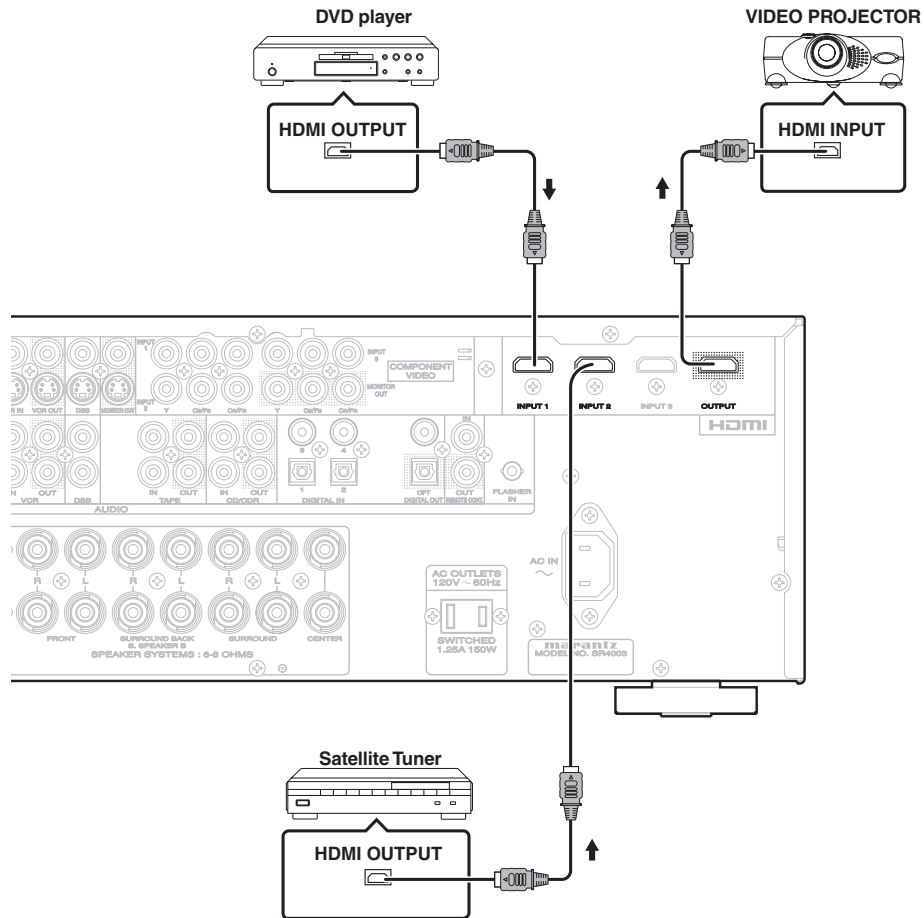

## HDMI JACK

This unit has 3 HDMI inputs and one HDMI output. It can send digital video and audio signals from DVDs and other sources directly to a display. It minimizes signal degradation caused by analog conversion so that high quality images can be enjoyed. Select an input source from the OSD menu system. (See page 21)

**Notes:**

- When the HDMI output is connected to a display monitor that does not support HDCP\*, signals are not output. To view images in HDMI, it is necessary to connect to a display that supports HDCP\*.
- There may be no image output if connected to a TV or display that is not compatible with the above format.
- Refer to the instruction manual of the TV or display to be connected to the unit for detailed information regarding the HDMI terminal.

\* **HDCP: High-bandwidth Digital Content Protection**

## CONNECTING HDMI COMPONENTS

An HDMI cable (sold separately) is used to connect the HDMI jack on the unit with the HDMI jack on a DVD player, TV, projector or other component. To transmit multichannel audio via HDMI, the connected player must support multichannel audio transmission through its HDMI jack.

HDMI video streaming is compatible with DVI in principle. Therefore, it is possible to connect to a TV or monitor that has a DVI terminal using an HDMI-DVI conversion cable or plug. When connecting to a DVI terminal, connect the audio signal separately.

**Notes:**

- Some HDMI components can be controlled over the HDMI cable, but this unit cannot control other components this way.
- When connected to a monitor (i.e., TV, projector, etc.) that does not support HDCP, video and audio are not output.
- DVI cables come with 24-pin and 29-pin plugs. This unit supports 24-pin DVI-D cables; 29-pin DVI cables cannot connect to it.
- Some source devices such as DVD players does not support HDMI repeater like those of the unit. In such case, pictures are not properly projected on monitors such as TVs and projectors.

- When multiple components are connected to this unit, turn power to unused components off to prevent interference between them.
- Disconnecting or connecting cables with the power on can damage the equipment. Turn the power off before disconnecting or connecting cables.
- Some DVD-Audio disks disable downmixing. These types of disks are not played back correctly unless the left, center, right and surround left and right speakers, and subwoofer are connected.
- If a DVD player that does not support HDMI 1.1 is connected to the unit, multi channel PCM playback is not possible even with DVD-Audio disks.
- If a DVD player or other device with DVI output is connected to the unit, a separate audio cable (optical-digital, coaxial digital or analog) is needed for the audio signals. In this case, select the connected audio input as explained in "1 INPUT SETUP". (See page 21)
- Multi channel PCM signals and audio signals of 64 kHz or higher that are input from the HDMI jack are not output from the DIGITAL OUT jacks.
- Depending on the quality of the cable used, the HDMI signal may be affected by noise.
- Audio units that use sampling frequencies of 128 kHz and above are not supported.
- When only HDMI components are connected, OSD will not be displayed. (See page 20)



**CONNECTING THE ANTENNA TERMINALS**

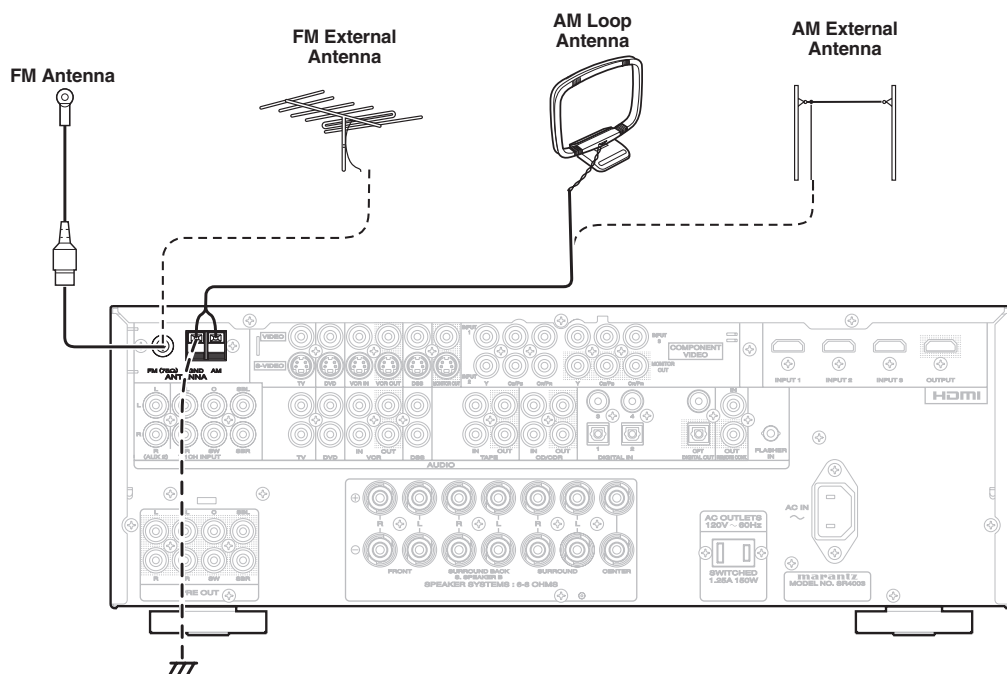

**ASSEMBLING THE AM LOOP ANTENNA**

1. Release the vinyl tie and take out the connection line.
4. Place the antenna on stable surface.



2. Bend the base part in the reverse direction.



3. Insert the hook at the bottom of the loop part into the slot at the base part.



**CONNECTING THE SUPPLIED ANTENNAS**

**Connecting the supplied FM antenna**

The supplied FM antenna is for indoor use only. During use, extend the antenna and move it in various directions until the clearest signal is received. Fix it with push pins or similar implements in the position that will cause the least amount of distortion. If you experience poor reception quality, an outdoor antenna may improve the quality.

**Connecting the supplied AM loop antenna**

The supplied AM loop antenna is for indoor use only. Set it in the direction and position it to where you receive the clearest sound. Put it as far away as possible from the unit, televisions, speaker cables, and power cords. If you experience poor reception quality, an outdoor antenna may improve the quality.

1. Press and hold down the lever of the AM antenna terminal.
2. Insert the bare wire into the antenna terminal.
3. Release the lever.

**CONNECTING AN FM OUTDOOR ANTENNA**

**Notes:**

- Keep the antenna away from noise sources (neon signs, busy roads, etc.).
- Do not put the antenna close to power lines. Keep it well away from power lines, transformers, etc.
- To avoid the risk of lightning and electrical shock, grounding is necessary.

**CONNECTING AN AM OUTDOOR ANTENNA**

An outdoor antenna will be more effective if it is stretched horizontally above a window or outside.

**Notes:**

- Do not remove the AM loop antenna.
- To avoid the risk of lightning and electrical shock, grounding is necessary.

**CONNECTING THE AC POWER CABLE**

1. Plug the supplied AC power cable to the AC IN socket on the rear panel of the unit.

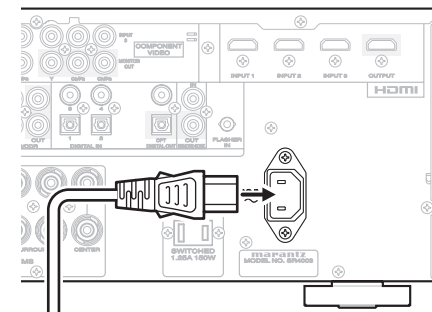

2. Plug the power cable into an AC outlet.

# BASIC OPERATION

## AMP OPERATION

### TURNING ON THE UNIT

1. Connect the AC power cord to the wall outlet.
2. Turn on the power to the devices that are connected to the unit.
3. Press the **POWER ON/STANDBY** button on the unit. Each time you press the button, the power to the unit switches between on and standby.

To turn on the power with the remote controller, first press the **AMP** button and then press the **POWER ON** or **SOURCE ON/OFF** button on the remote controller.

### SELECTING AN INPUT SOURCE

Before you can listen to any input media, you must first select the input source on the unit.

#### Example : DVD

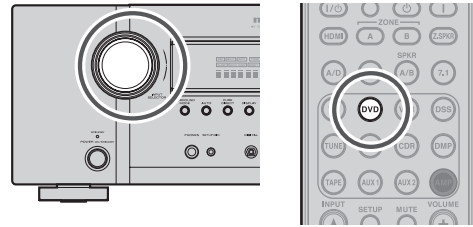

To select DVD, turn the **INPUT SOURCE** knob on the front panel or simply press the **DVD** button on the remote controller.

After you have selected DVD, simply turn on the DVD player and play the DVD.

- As the input source is changed, the new input name will appear momentarily an OSD information on the video display. The input name will also appear in the display, on the front-panel.
- As the input is changed, this unit will automatically switch to the digital input, surround mode, attenuation, and night mode status which were entered during the configuration process for that source.
- When an audio source is selected, the last video input used remains routed to the **VCR** Output and **Monitor** Output. This permits simultaneous viewing and listening to different sources.
- When a Video source is selected, the video signal for that input will be routed to the **Monitor Output** jacks and will be viewable on a TV monitor connected to the unit.  
If a component video input is connected to the **DVD** or **DSS** component inputs, it will be routed to the **Component Video Output**. Make certain that your TV is set to the proper input to view the signal.

### ADJUSTING THE MAIN VOLUME

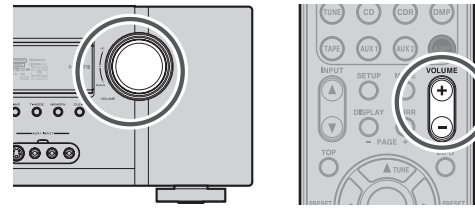

Adjust the volume to a comfortable level using the **VOLUME** control knob on the front panel or **VOLUME ▲ / ▼** buttons on the remote controller.

To increase the volume, turn the **VOLUME** knob clockwise or press **VOLUME ▲** button on the remote controller, to decrease the volume, turn counterclockwise or press **VOLUME ▼** button on the remote controller.

#### Notes:

- The volume can be adjusted within the range of  $-\infty$  to 18 dB, in steps of 1 dB.
- However, when the channel level is set as described on page 22, if the volume for any channel is set at +1 dB or greater, the volume cannot be adjusted up to 18 dB.

(In this case the maximum volume adjustment range is “18 dB - Maximum value of channel level”)

### ADJUSTING THE TONE (BASS & TREBLE) CONTROL

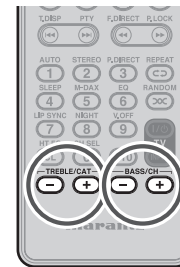

During a listening session you may wish to adjust the Bass and Treble Control to suit your listening tastes or room acoustics.

#### (Using the remote controller)

To adjust the bass effect, press **BASS +** or **BASS -** on the remote controller.

To adjust the treble effect, press **TREBLE +** or **TREBLE -** on the remote controller.

#### Note:

The tone control function can work in the AUTO Surround, Stereo, Dolby PLIix, DTS, DTS-ES, and Multi Ch. Stereo mode.

### TEMPORARILY TURNING OFF THE SOUND



To temporarily silence all speaker outputs such as when interrupted by a phone call, press the **MUTE** button on the remote controller.

This will interrupt the output to all speakers and the head-phone jack, but it will not affect any recording or dubbing that may be in progress.

When the system is muted, the display will show “MUTE”.

Press the **MUTE** button again to return to normal operation.

## TUNER OPERATION

Frequency scan step for AM is selectable. Default setup is 10 kHz step, if your country's standard is 9 kHz step, Press **BAND** button on the remote controller more than 6 seconds. Scan step will change.

### Note:

Preset memory for the tuner will clear by changing this setup.

## AUTO TUNING

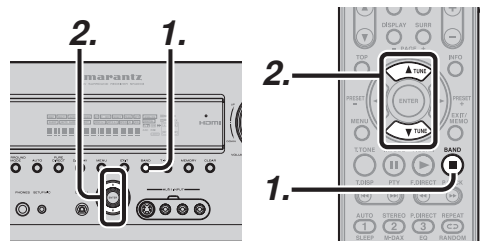

### (Using the unit)

1. To select tuner and desired band (FM or AM), press the **BAND** button on the front panel.
2. Press the **▲** or **▼** cursor buttons on the front panel for more than 1 second to start the auto tuning function.
3. Automatic searching begins then stops when a station is tuned in.

### (Using the remote controller)

1. To select tuner and desired band (FM or AM), press the **BAND** button on the remote controller.
2. Press the **TUNE ▲** or **▼** for more than 1 second on the remote controller.
3. Automatic searching begins then stops when a station is tuned in.

If tuning does not stop at the desired station, use to the "Manual tuning" operation.

## MANUAL TUNING

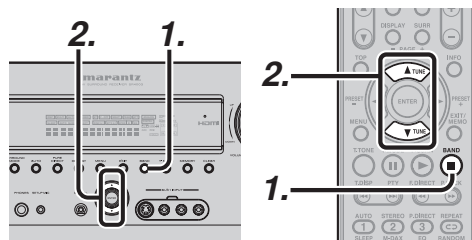

### (Using the unit)

1. To select tuner and desired band (FM or AM), press the **BAND** button on the front panel.
2. Press the **▲** or **▼** cursor buttons on the front panel to select the desired station.

### (Using the remote controller)

1. To select tuner and desired band (FM or AM), press the **BAND** button on the remote controller.
2. Press the **TUNE ▲** or **▼** on the remote controller to tune in the desired station.

## DIRECT FREQUENCY CALL

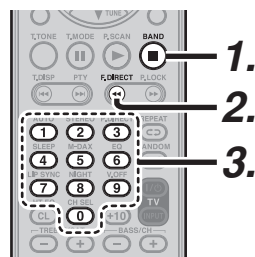

1. To select tuner and desired band (FM or AM), press the **BAND** button on the remote controller.
2. Press the **F.DIRECT** on the remote controller, display will show "**FREQ - - -**".
3. Input your desired station's frequency with the **numeric** buttons on the remote controller.
4. The desired station will automatically be tuned.

## (FM) TUNING MODE (AUTO STEREO OR MONO)

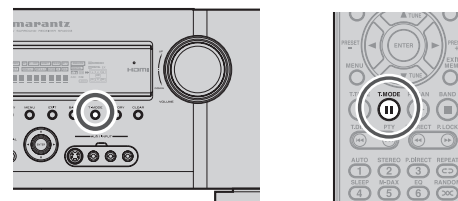

When in the auto stereo mode, **AUTO** indicator will be illuminated on the display.

The "**ST**" indicator is illuminated when a stereo broadcast is tuned in.

At open frequencies, the noise is muted and the "**TUNED**" and "**ST**" indicators are not illuminated.

If the signal is weak, it may be difficult to tune into the station in stereo. In such a case, press the **T-MODE** button on the front panel or remote controller.

"**AUTO**" indicator is not illuminated, if FM stereo broadcasts are received in monaural and the "**ST**" indicator is not illuminated.

To return to auto stereo mode, press the **T-MODE** button or press **T-MODE** button on the remote controller again. **AUTO** indicator is illuminated on the display.

**REMOTE CONTROLLER OPERATION**

To control the unit by your remote controller, you have to select the device AMP or TUNER by pressing the **SOURCE** button. Please refer below for the details in AMP and TUNER mode.

**AMP MODE**

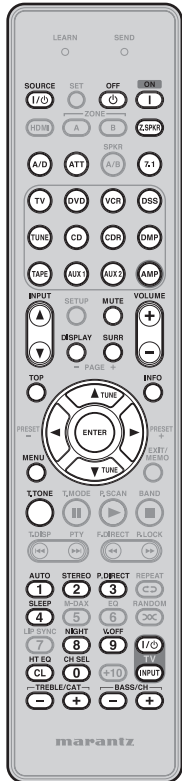

SOURCE ON/OFF	Turns the SR4003 on and off
POWER OFF	Turns the SR4003 off
POWER ON	Turns the SR4003 on
Z.SPKR	Turns on or off Surround Speaker B
A/D	Switches between the analog or digital inputs
ATT	Reduces the input level
7.1	Selects the 7.1CH IN
SOURCE	Selects a particular source component
AMP	Selects AMP mode of remote unit
INPUT ▲ / ▼	Change the input selector of SR4003
DISPLAY	Changes the front display mode
MUTE	Decreases the sound temporarily
SURR	Selects the surround mode
VOLUME+/-	Adjusts the over all sound level
TOP	Back to the TOP of SETUP MENU
INFO	Displays the current setting on the monitor
Cursor	Moves the cursor for setting in "SETUP MENU" mode
ENTER	Confirms the setting in "SETUP MENU" mode
MENU	Enters the "SETUP MENU"
EXIT	Exits from SETUP MENU
T.TONE	Enters the test tone menu
AUTO(1)	Selects auto surround
STEREO(2)	Selects STEREO mode
P.DIRECT(3)	Selects the pure direct mode
SLEEP(4)	Sets the sleep timer function
NIGHT(8)	Turns on or off NIGHT mode
V-OFF(9)	Turns on or off video output
HT EQ(CL)	Turns on or off HT-EQ mode
CH SEL(0)	Calls up CH LEVEL ADJUST and adjusts speaker levels or 7.1ch input level
TV POWER	Turns the TV on and off
TV INPUT	Selects the TV video input
TREBLE-/+	Adjusts the tone control of high frequency sound
BASS-/+	Adjusts the tone control of low frequency sound

**TUNER MODE**

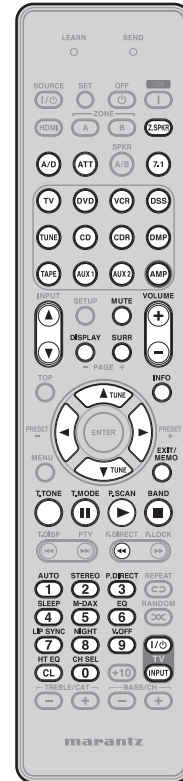

- The remote controller dose not have the PRESET code library for this device.

Z.SPKR	AMP function enabled
A/D	AMP function enabled
ATT	AMP function enabled
7.1 IN	AMP function enabled
SOURCE	AMP function enabled
AMP	AMP function enabled
INPUT ▲ / ▼	AMP function enabled
DISPLAY	AMP function enabled
MUTE	AMP function enabled
SURR	AMP function enabled
VOLUME+/-	AMP function enabled
INFO	Shows preset information
TUNE ▲ / ▼	Tunes a frequency station up and down
PRESET + ► / - ◀	Selects a preset station up and down
EXIT/MEMO	Enters the tuner preset memory numbers
T.TONE	AMP function enabled
T.MODE	Selects the auto stereo mode or mono mode
P.SCAN	Starts preset scan
BAND	Selects a radio band
F.DIRECT	Selects the "Frequency direct input"
0-9	Inputs the numeric
CL	Clears the inputting
TV POWER	Turns the TV on and off
TV INPUT	Selects the TV video input

# ADVANCED CONNECTIONS

## CONNECTING MULTI CHANNEL AUDIO COMPONENT

The 7.1CH INPUT jacks are for multichannel audio source such as a Super Audio CD multichannel player, DVD audio player or external decoder.

If you use these jacks, switch on the 7.1CH INPUT and set the 7.1CH INPUT level by using the SETUP MAIN MENU. See page 25.

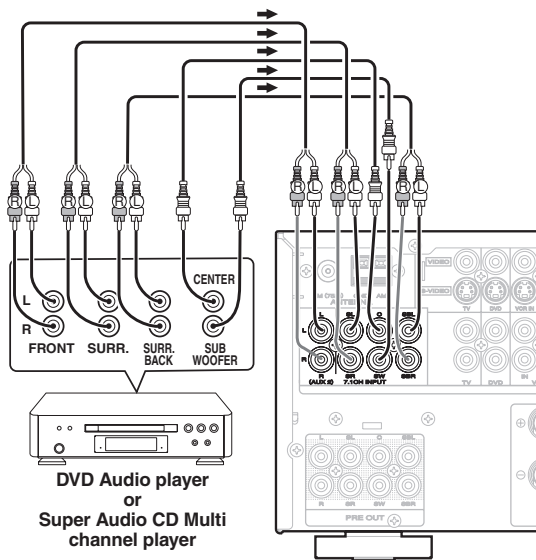

## CONNECTING AN EXTERNAL POWER AMPLIFIER

The PREOUT jacks are for connecting external power amplifiers.

Be sure to connect each speaker to the corresponding external power amplifier.

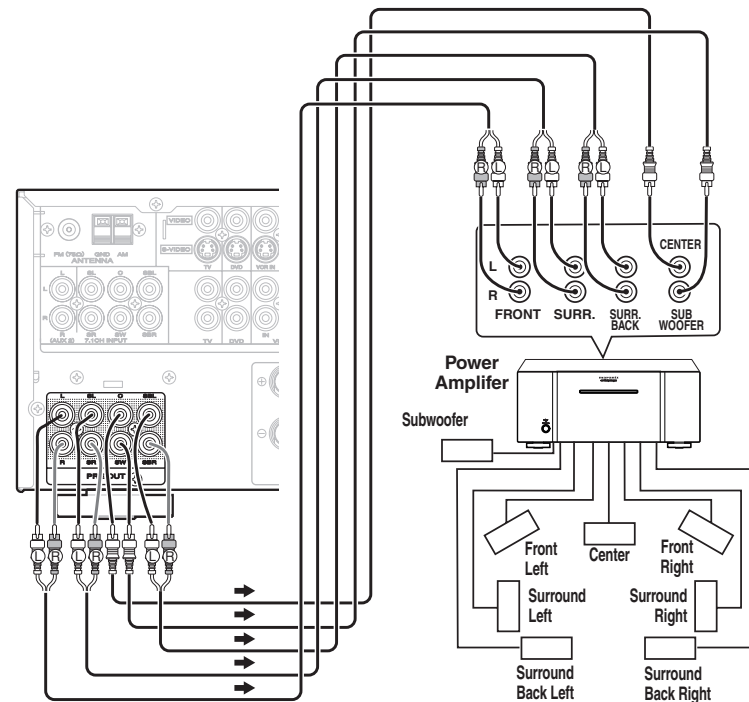

- NAMES AND FUNCTIONS
- BASIC CONNECTIONS
- BASIC OPERATION
- ADVANCED CONNECTIONS
- SETUP
- ADVANCED OPERATION
- TROUBLESHOOTING
- OTHERS

## CONNECTING THE REMOTE CONTROL JACKS

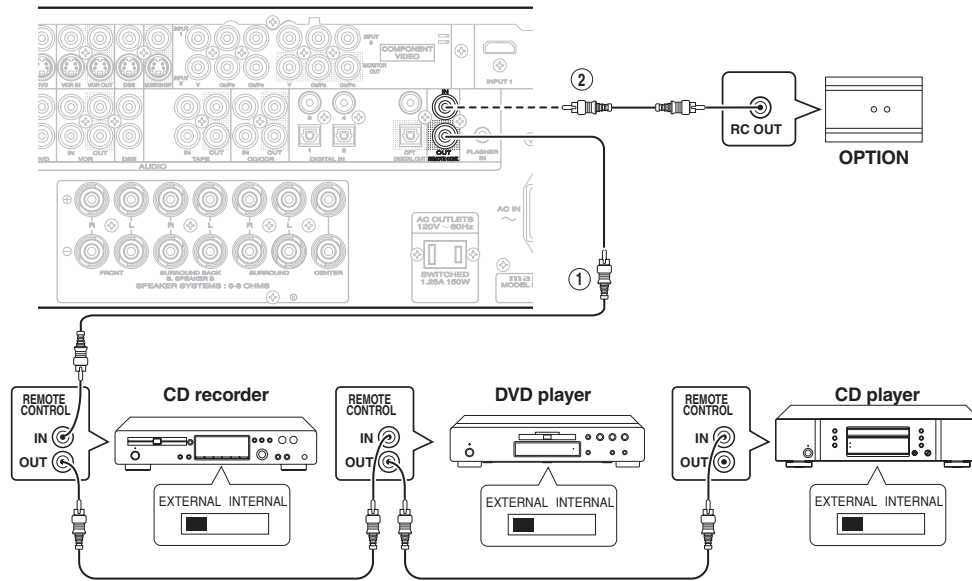

①

You can control other Marantz products through this unit with the remote controller by connecting the REMOTE CONTROL terminals on each unit.

The signal transmitted from the remote controller is received by the remote sensor on this unit. Then the signal is sent to the connected device through this terminal. Therefore you need to aim the remote signal only to the unit. Also, if a Marantz power amplifier (some models excluded) is connected to one of these terminals, the power amplifier's, power switch is synchronized with this unit's power switch.

Set the REMOTE CONTROL SWITCH on the back of other units (not the SR4003) to "EXT".(EXTERNAL) to use this feature.

②

Whenever external infrared sensors or similar devices are connected to RC-5 IN of the unit, be sure to always disable operation of the infrared sensor on the unit by using the following procedure.

1. Hold down the **SURROUND MODE** button and **MENU** button on the front panel at the same time for five seconds.
2. The setting "IR=ENABLE" is shown on the FL DISPLAY.
3. Press the ◀ or ▶ cursor button to change this to "IR=DISABLE".
4. Press the **ENTER** button. Once this setting is made, the infrared sensor on the unit is disabled.

**Note:**

Be sure to set to "IR=ENABLE" when external infrared sensors or similar devices are not connected. Otherwise, the unit will be unable to receive remote control commands.

5. To restore the original setting, perform steps 1 to 4 to set to "IR=ENABLE".

# SETUP

After all components are connected, initial setup must be performed.

## ON SCREEN DISPLAY MENU SYSTEM

This unit incorporates an on-screen menu system, which makes various operations possible by using the cursor (▲, ▼, ◀, ▶) and **ENTER** buttons on the remote control or on the front panel.

**Note:**

To view the on-screen displays, make certain you have made a connection from the Monitor Out jack on the rear panel to the composite, S-Video, component video input of your TV or projector. (see page 12)

1. Press the **AMP** button of the remote controller. (This step is not needed when operating the setup menus from the unit itself.)
2. Press the **MENU** button on the remote controller or set to display the "SETUP MAIN MENU" of the OSD menu system.

There are 8 items in the SETUP MAIN MENU.

3. Select a desired sub-menu with the ▲ or ▼ cursor buttons, and press the **ENTER** button to enter. The display will change to the selected sub-menu. You can lock the condition of setup to each sub-menu with the ◀ or ▶ or cursor buttons.

**Note:**

If you desire to adjust any sub-menu, you need to set it to UNLOCKED.

4. If you desire to exit from this menu system, press the **EXIT** button, or move the cursor to **EXIT** and press the **ENTER** button.

When only HDMI components are connected, the OSD menu will not be displayed on the screen.

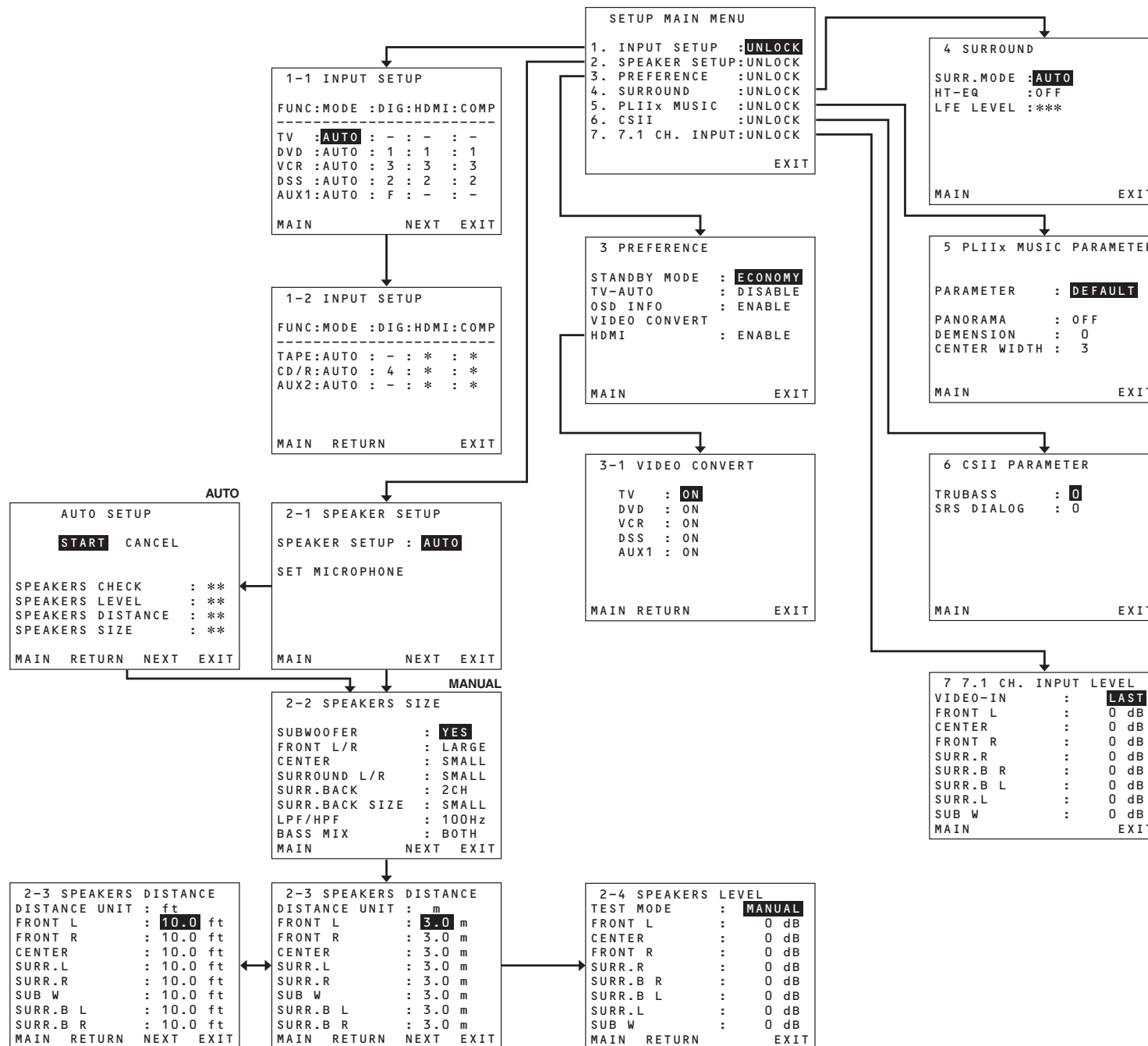

## 1 INPUT SETUP (ASSIGNABLE DIGITAL INPUT AND COMPONENT VIDEO INPUT)

Use this menu to select the input jack to be assigned to the input source.

1. Select "INPUT SETUP" in SETUP MAIN MENU with ▲ or ▼ cursor button, and press the ENTER button.

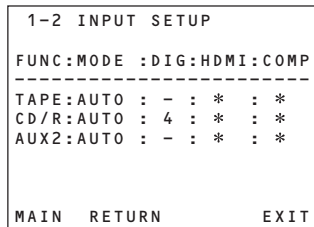
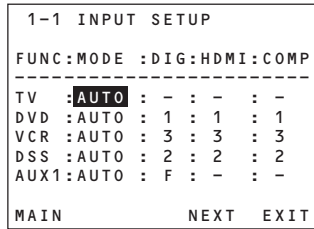

2. To select the input source and MODE, press the ▲ or ▼ cursor buttons.
3. To select "DIG" "HDMI" or "COMP" for the input jack, press the ◀ or ▶ cursor buttons.  
Select "AUTO" for input sources, for automatic detection of the digital input signal condition.  
If there is not a digital signal present, but there is an analog signal present, the analog signal will be played.  
Select "DIG", when only a digital signal will be used. Select "ANA" for input sources for which no digital input jacks are used.
4. To select the video source, select "HDMI" or "COMP" by pressing the ▲ or ▼ cursor buttons, and press the ◀ or ▶ cursor buttons to select the video source to be assigned.
5. After you complete this portion of the set up, move the cursor to MAIN with the ▲ or ▼ cursor buttons and press the ENTER button.

### Notes:

- When the TUNER is fixed to the analog input, you can not select any digital input.
- When a DTS-LD or DTS-CD is playing, this setup is not available. This is to avoid noise being generated from the analog input.
- If "AUTO" is selected and a DVD, compact disc or LD is fast-forwarded during playback, decoded signals may produce a skipping sound. In such cases, change the setting to "DIG".

## 2 SPEAKER SETUP

After you have installed the unit, connected all the components, and determined the speaker layout, it is now time to perform the settings in the Speaker Setup menu for the optimum sound acoustics for your environment and speaker layout. Before you perform the following settings, it is important that you first determine the following characteristics:

1. Select "SPEAKER SETUP" in SETUP MAIN MENU with ▲ or ▼ cursor button, and press the ENTER button.

### 2-1 SPEAKER SETUP

Speakers are set up by selecting either MANUAL or AUTO using the ◀ and ▶ cursor buttons. For operation when AUTO has been selected, see MRAC on page 23.

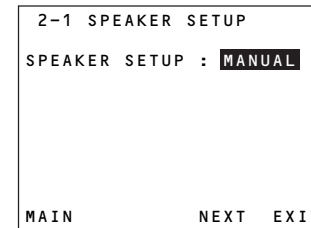

### 2-2 SPEAKERS SIZE

When setting the speaker size in the SPEAKER SIZE sub-menu, use the guidelines given below.

#### LARGE:

The complete frequency range for the channel you are setting will be output from the speaker.

#### SMALL:

Frequencies of the channel you are setting lower than approx. 100 Hz will be output from the subwoofer.

If the Subwoofer is set to "NONE", the setting of the front speakers will be fixed to "LARGE," and the sound will be output from both the left and right speakers.

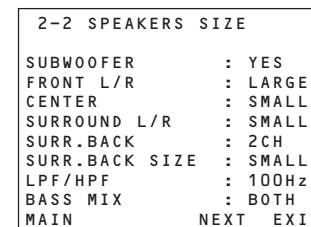

1. To select the each speaker, press the ▲ or ▼ cursor buttons.
2. To select the setting of each speaker size, press the ◀ or ▶ cursor buttons.
3. After you complete this portion of the set up, move the cursor to "NEXT" with the ▲ or ▼ cursor buttons and then press the ENTER button to go to the next page.

### SUBWOOFER:

#### YES:

Select when a subwoofer is connected.

#### NONE:

Select when a subwoofer is not connected.

### FRONT L/R

#### LARGE:

Select if the front speakers are large.

#### SMALL:

Select if the front speakers are small.

- If "NONE" is selected for the Subwoofer setting, then this setting is fixed to "LARGE."

### CENTER

#### NONE:

Select if no center speaker is connected.

#### LARGE:

Select if the center speaker is large.

#### SMALL:

Select if the center speaker is small.

### SURROUND L/R

#### NONE:

Select if no surround left and right speakers are connected.

#### LARGE:

Select if the surround left and right speakers are large.

#### SMALL:

Select if the surround left and right speakers are small.

### SURR. BACK

#### NONE:

Select if no surround back left and right speakers are connected.

#### 2CH:

Select if the surround back left and right speakers are connected.

#### 1CH:

Select if the one surround back speaker is connected.

In this case, the audio signal is emitted from the Surround back L output terminal.



**Note:**

- If "NONE" is selected for the Surround L/R setting, then this setting is fixed to "NONE."

**SURR. BACK SIZE**

**LARGE:**

Select if the surround back speaker is large.

**SMALL:**

Select if the surround back speaker is small.

**Note:**

If "NONE" is selected for the Surround L/R setting, then this setting is not available.

**LPF/HPF**

When you use a subwoofer, you can select the cutoff frequency for the small speakers used. Select one of the crossover frequency levels according to the size of the small speaker connected.

80Hz → 100Hz → 120Hz → 150Hz → 180Hz

**Notes:**

- If using small front speakers, set a slightly higher frequency. If using large front speakers, set a slightly lower frequency.
- If Pure-Direct mode, 7.1CH Input is in use, this function does not take effect.

**BASS MIX**

- The bass mix setting is only valid when "LARGE" is set for the front speakers and "YES" is set for the subwoofer during stereo playback .

This setting has effect only during playback of PCM or analog stereo sources.

- When "BOTH" is selected, the low frequencies will be played through the main L&R, as well as the sub woofer.

In this playback mode, the low frequency range expand more uniformly through the room, but depending on the size and shape of the room, interference may result in a decrease of the actual volume of the low frequency range.

- By selecting "MIX", the low frequencies will play through the main L&R ONLY.

**Note:**

LFE signals during playback of Dolby Digital or DTS, will be played through the sub woofer.

**2-3 SPEAKERS DISTANCE**

Use this parameter to specify the distance of each speaker's position from the listening position. The delay time is automatically calculated according to these distances.

Begin by determining the ideal or most commonly used seating position in the room.

This is important for the timing of the acoustics to create the proper sound space that the unit and today's sound systems are able to produce.

**Note:**

For speakers that you have selected "NONE" the Speaker Configuration sub-menu will not appear here. (There are several useful books and special DVD and LD's available to guide you through proper home theater configuration. If you are unsure, have your Marantz dealer perform the installation for you. They are trained professionals familiar with even the most sophisticated custom installations. Marantz recommends the WWW.CEDIA.ORG website for further information about this).

2-3 SPEAKERS DISTANCE	
DISTANCE UNIT :	m
FRONT L :	3.0 m
FRONT R :	3.0 m
CENTER :	3.0 m
SURR. L :	3.0 m
SURR. R :	3.0 m
SUB W :	3.0 m
SURR. B L :	3.0 m
SURR. B R :	3.0 m
MAIN RETURN	NEXT EXIT

1. To select each speaker , press the ▲ or ▼ cursor buttons.
2. To set the distance for each speaker , press the ◀ or ▶ cursor buttons.
3. After you complete this portion of the set up, move the cursor to "NEXT" with the ▲ or ▼ cursor buttons and then press the ENTER button to go to the next page.

**FRONT L:**

Set the distance from the front left speaker to your normal listening position.

**CENTER:**

Set the distance from the center speaker to your normal listening position.

**FRONT R:**

Set the distance from the front right speaker to your normal listening position.

**SURR. L:**

Set the distance from the surround left speaker to your normal listening position.

**SURR. R:**

Set the distance from the surround right speaker to your normal listening position.

**SUB W:**

Set the distance from the subwoofer to your normal listening position.

**SURR. B L:**

Set the distance from the surround back left speaker to your normal listening position.

**SURR. B R:**

Set the distance from the surround back right speaker to your normal listening position.

**Notes:**

- Set the distance to each speaker in meters (m) or feet (ft) as follows.  
m: 0.1 - 9 m in 0.1 m steps  
ft: 0.3 - 30 ft in 0.3 ft steps
- For the speakers that you have selected "NONE" the Speaker Size menu will not appear.
- The setting for Surr.Back L and Surr.Back R appears if you set for it to, two surround back speakers in the Speaker Size menu.
- The setting of Surr.Back appears if it is set for one surround back speaker in the Speaker Size menu.

**2-4. SPEAKERS LEVEL SETTING WITH TEST TONE**

Here you will set the volume for each speaker so that they are all heard by the listener at the same level. We recommend using a SPL (Sound Pressure Level) meter, when available.

**Note:**

The speaker level settings are not available in 7.1 Channel Input mode, CS mode and Multi Channel Stereo mode.

2-4 SPEAKERS LEVEL	
TEST MODE :	MANUAL
FRONT L :	0 dB
CENTER :	0 dB
FRONT R :	0 dB
SURR. R :	0 dB
SURR. B R :	0 dB
SURR. B L :	0 dB
SURR. L :	0 dB
SUB W :	0 dB
MAIN RETURN	EXIT

**TEST MODE :**

Selects "MANUAL" or "AUTO" for generating the mode of the test tone with the ◀ or ▶ cursor buttons.

If you select "AUTO" , the test tone will be cycled through in a circular pattern which is Left → Center → Right → Surround Right → Surround Back Right → Surround Back Left → Surround Left → Subwoofer → Left → .. increments of 2 seconds for each channel.

Using the ◀ or ▶ cursor buttons, adjust the volume level of the noise from the speaker so that it is the same level for all the speakers.

If you select "MANUAL", adjust the output level of each speaker as listed below.

1. When you move the cursor to FRONT L by pressing the ▼ cursor button, the unit will emit a pink noise from the front left speaker. Remember the level of this noise and then press the ▼ cursor button. (Note that this can be adjusted to any level between -10 and +10 dB in 1 dB intervals except the subwoofer setting. The subwoofer can be adjusted to any level between -15 and +10 dB in 1 dB intervals.) The unit will now emit the pink noise from the center speaker.
2. Using the ◀ and ▶ cursor buttons, adjust the volume level of the noise from the center speaker so that it is the same level as the front left speaker.
3. Press the ▼ cursor button again. The unit will now emit the pink noise from the front right speaker.
4. Repeat steps 2 and 3 above for the front right and other speakers until all speakers are adjusted to the same volume level.

After you complete this portion of the set up, press the ENTER button, the cursor will move to "MAIN" and then press the ENTER button to go to SETUP MAIN MENU.

**Notes:**

- Speakers that you selected "NONE" for in the Speaker Size menu will not appear.
- The setting of Surr.Back L and Surr.Back R appears if you have set it for two surround back speakers in the Speaker Size menu.
- The setting of Surr.Back appears if you have set it for one surround back speaker in the Speaker Size menu.
- To adjust the speaker levels for 7.1-channel input sources, you will need to use the 7.1CH-INPUT sub menu. (See page 25).

**MRAC (Marantz Room Acoustic Calibration)**

Speaker settings that were difficult by MANUAL setup can now be made by automatically measuring speaker characteristics using the included microphone.

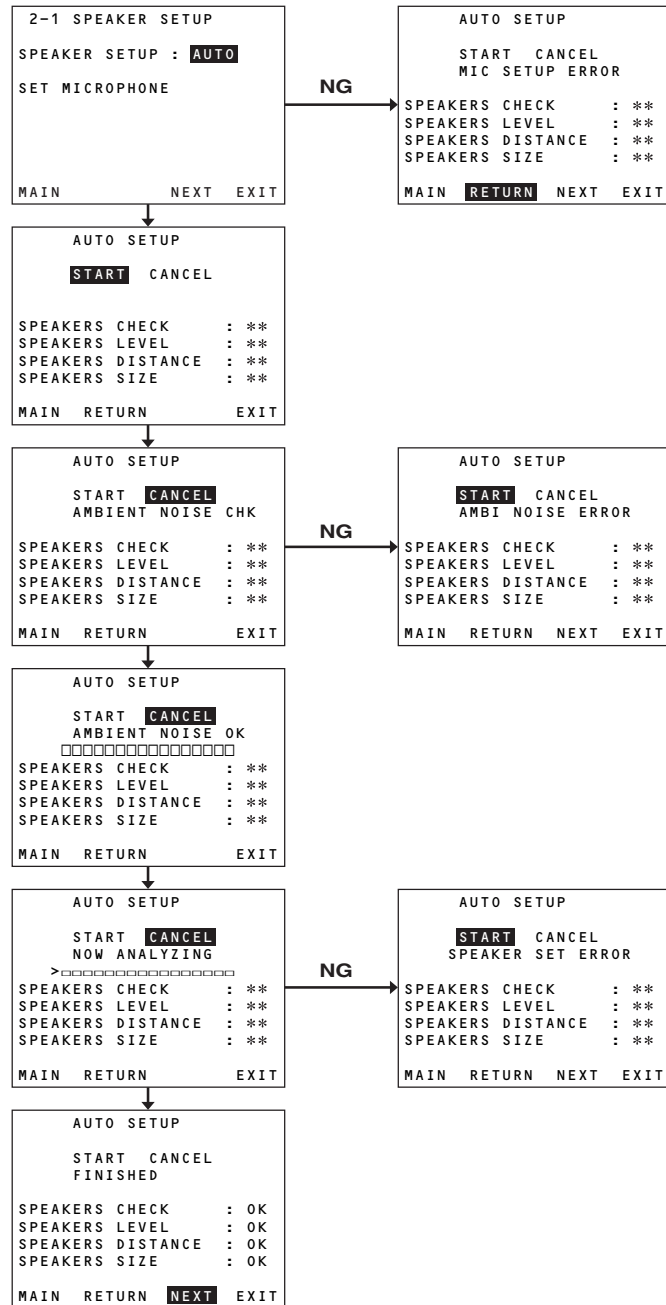

**Measurement**

During measurement, a test tone is output from the speakers, which is then measured and analyzed through the microphone. The measurement flow and items are as follows.

Display	Status
MIC CHECK	Microphone connection check
AMBIENT NOISE	Ambient noise measurement
SPEAKER CHECK	Speaker connected/not connected check
SPEAKER LEVEL	Speaker output level check
SPEAKER DISTANCE	Distance from speaker (delay time) check
SPEAKER SIZE	Speaker characteristics check

**How to Operate**

Settings are displayed on the monitor during setup, therefore turn the monitor on.

1. Connect the included microphone to the MRAC jack of the unit.

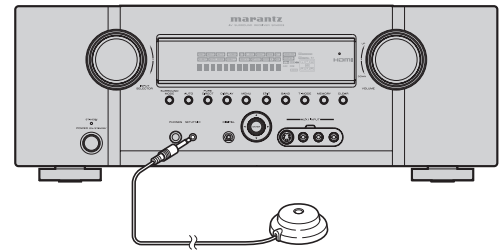

2. Set the microphone at ear height as in the actual listening position. Use a stand or tripod to position the microphone.

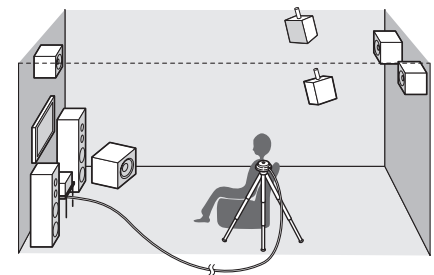

**Notes:**

- Remove any obstructions between the speakers and the microphone.
- Keep the room quiet during measurement.
- The test tone emitted during measurement is loud. Take considerations for neighboring homes and children.

- Step away from the listening position during measurement and operate the unit with the remote controller from outside the speaker path.
- About surround back speakers :  
When the surround back speaker is set to NONE in the SPEAKER SETUP, it is skipped in the AUTO setup. To use the surround back speaker, set it to YES by MANUAL setup before using the MRAC feature.
- The MRAC feature is available except in the following modes.  
- 7.1 CH INPUT  
- PURE-DIRECT  
- SOURCE DIRECT

3. Select "2. SPEAKER SETUP" on the SETUP MAIN MENU, then select AUTO for "2-1 SPEAKER SETUP". Move the cursor to "NEXT" with the ▲ or ▼ cursor buttons and then press the ENTER button.

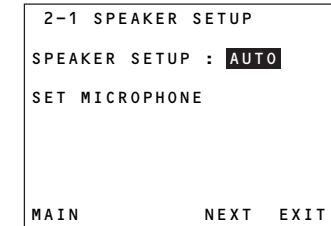

4. Select START on the AUTO SETUP display and press the ENTER button to start measurements.

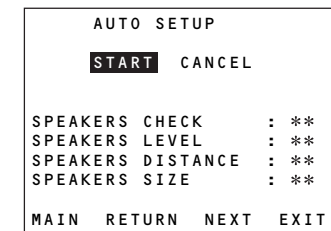

5. For measurement items, see "Measurement".
6. When measurements are completed, "FINISHED" appears on the monitor.
7. Once finished, disconnect the microphone from the unit.
8. Measurement results can be seen by selecting "NEXT" and press the ENTER button or selecting "2. SPEAKER SETUP" on the SETUP MAIN MENU. Then select MANUAL for "2-1 SPEAKER SETUP".

**Notes:**

- The measured speaker distance may differ from the actual distance from speakers. Nevertheless, the measured value is suitable for the speakers.
- To make changes to individual speakers, select 2. SPEAKER SETUP on the SETUP MAIN MENU, then select MANUAL for 2-1 SPEAKER SETUP.
- The included microphone is designed specifically for this receiver. Other microphones do not guarantee suitable measurement results. Use the included microphone to conduct measurements.
- During measurement, press the **ENTER** or **EXIT** button to cancel measurement.
- In some rooms, an error may occur during auto speaker setup or it may not be possible to set Speaker distance correctly because of room acoustics. In such case, set the speaker distance by MANUAL setup.
- Please set any THX Certified speakers manually to "Small" and the crossover to "80 Hz" after Auto setup operation.
- When only HDMI components are connected, OSD will not be displayed.

**Error Indications During Measurement**

If trouble occurs during measurement, an error message is displayed on the monitor screen and FL display. Those errors and their remedies are described below. The message appearing on the FL display is given in ( ).

<b>MIC SETUP ERROR (MIC SET ERROR)</b>
The microphone (MC-10) is not properly connected. → Check the microphone connection.
<b>AMBI NOISE ERROR (AMBI NOISE ER)</b>
Measurement cannot be done correctly because of excessive ambient noise. → Either temporarily turn off power to noisy devices such as air conditioning or move them out of the room. → Retry measurement when the room is quiet.
<b>SPEAKER SET ERROR (SPK SET ERROR)</b>
The speakers are not properly connected. → Recheck speaker layout and connections.

**3 PREFERENCE**

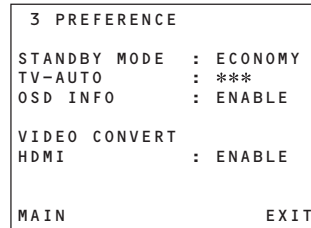

1. Select "**PREFERENCE**" in the SETUP MAIN MENU with the ▲ or ▼ cursor buttons, and press the **ENTER** button.
2. To select a desired content, press the ▲ or ▼ cursor buttons.

**STANDBY MODE:**

When this function is set to "**ECONOMY**", you can reduce the power consumption when the unit is in the standby mode.

**Note:**

TV-AUTO is disabled in the "**ECONOMY**" setting.

**TV AUTO:**

Select the TV AUTO ON/OFF function to enable or disable with the ◀ or ▶ cursor buttons.

**OSD Info:**

Select the OSD information function to enable or disable with the ◀ or ▶ cursor buttons. If you select "**ENABLE**", the unit will display the status of the feature (Volume up/down, input select, etc..) on the TV monitor. But if you do not desire this information, select "**DISABLE**".

**VIDEO CONVERT:**

Select the VIDEO CONVERT function to enable or disable with the ◀ or ▶ cursor buttons. (Video cable connection: Refer to page 12)

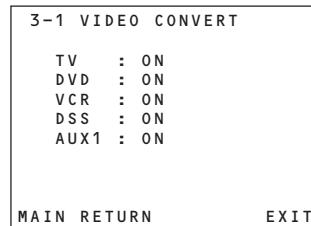

After you complete this portion of the set up, move the cursor to "**MAIN**" with the ▲ or ▼ cursor buttons and press the **ENTER** button.

**HDMI AUDIO:**

This setting determines whether to playback audio input to the HDMI jacks through the unit or output it through the unit to a TV or projector.

**ENABLE:** The audio input to the HDMI jacks can be played back by this unit. In such case, audio signals are not output to the TV or projector.

**THROUGH:** The audio input to the HDMI jacks is not output from the speaker terminals of the unit. Audio data is output directly to the TV or projector. This setting is used to listen to audio on a multi channel TV, etc.

**4 SURROUND**

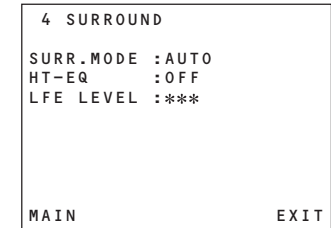

1. Select "**SURROUND**" in the SETUP MAIN MENU with the ▲ or ▼ cursor buttons, and press the **ENTER** button.
2. To select a desired content, press the ▲ or ▼ cursor buttons.

**SURR.MODE:**

Select the desired surround mode with the ◀ or ▶ cursor buttons.

**HT-EQ:**

Select to active the HT-EQ with the ◀ or ▶ cursor buttons.

The tonal balance of a film soundtrack will be excessively bright and harsh when played back over audio equipment in the home. This is because film soundtracks were designed to be played back in large movie theater environments.

Activating the HT-EQ feature when watching a film made for movie theaters corrects this and restores the correct tonal balance.

The HT-EQ feature is available except in the following modes.

- 7.1 CH INPUT
- PURE-DIRECT
- SOURCE DIRECT
- When VIRTUAL is set for the surround mode

**LFE LEVEL:**

Select the output level of the LFE signal included in the Dolby Digital signal or the DTS signal. Select 0 dB, -10 dB or OFF with the ◀ or ▶ cursor buttons.

After you complete this portion of the set up, move the cursor to "**MAIN**" with the ▲ or ▼ cursor buttons and press the **ENTER** button.

## 5 PL IIx (PRO LOGIC IIx) MUSIC PARAMETER

Pro Logic IIx-Music mode creates a rich and enveloping surround ambience from stereo sources such as CDs.

In this mode, this unit include three controls to fine-tune the soundfield as follows.

5 PLIIx MUSIC PARAMETER	
PARAMETER	: DEFAULT
PANORAMAA	: OFF
DIMENSION	: 0
CENTER WIDTH	: 3
MAIN	EXIT

Select "PL IIx MUSIC" in the SETUP MAIN MENU with the ▲ or ▼ cursor buttons, and press the **ENTER** button.

### PARAMETER:

Select "DEFAULT" or "CUSTOM" with the ◀ or ▶ cursor buttons.

If you select "CUSTOM", you can adjust three parameters as listed below.

### PANORAMA:

Select the Panorama mode On or Off with the ◀ or ▶ cursor buttons.

Panorama wraps the sound of the front left and right speakers around you, for an exciting perspective.

### DIMENSION:

Set the Dimension level between +3 and -3 level in 1 level intervals with the ◀ or ▶ cursor buttons.

Adjust the soundfield either towards the front or towards the rear.

This can be useful to help achieve a more suitable balance from all the speakers with certain recordings.

### CENTER WIDTH:

Set the Center width level between 0 and 7 in 1 level intervals with the ◀ or ▶ cursor buttons.

Center Width allows you to gradually spread the center channel sound into the front left and right speakers.

At its widest setting, all the sound from the center is mixed into the left and right.

This control may help achieve a more spacious sound or a better blend for the front image.

If "NONE" was selected for the Center speaker setting, in the Speaker size set up menu, then this setting will not appear.

After you complete this portion of the set up, move cursor to "MAIN" with the ▲ or ▼ cursor buttons and press the **ENTER** button.

## 6 CS II (CIRCLE SURROUND II) PARAMETER

6 CSII PARAMETER	
TRUBASS	: 0
SRS DIALOG	: 0
MAIN	EXIT

1. Select "CS II" in the SETUP MAIN MENU with the ▲ or ▼ cursor buttons, and press the **ENTER** button.
2. To Select desired contents as below, press the ▲ or ▼ cursor buttons.

### TRUBASS:

Set the TRUBASS level between 0 and 6 level in 1 level interval with the ◀ or ▶ cursor buttons.

TRUBASS produced by the speakers are an octave below the actual physical capabilities of the speakers adding exciting, deeper bass effects.

### SRS DIALOG:

Set the SRS DIALOG level between 0 and 6 in 1 level intervals with the ◀ or ▶ cursor buttons.

This can be popped out of the surround audio effects, allowing the listener to easily discern what the actors say.

If "NONE" was selected for the Center speaker setting, in the Speaker size set up menu, then this setting will not appear.

After you complete this portion of the set up, move cursor to "MAIN" with the ▲ or ▼ cursor buttons and press the **ENTER** button.

## 7 7.1 CH INPUT LEVEL

This sub-menu is to adjust the speaker levels for 7.1-channel input sources.

Here you will adjust the volume for each channel so that they are all heard by the listener at the same level.

7 7.1 CH. INPUT LEVEL		
VIDEO-IN	:	LAST
FRONT L	:	0 dB
CENTER	:	0 dB
FRONT R	:	0 dB
SURR. R	:	0 dB
SURR. B R	:	0 dB
SURR. B L	:	0 dB
SURR. L	:	0 dB
SUB W	:	0 dB
MAIN	:	EXIT

1. Select "7.1CH INPUT" in the SETUP MAIN MENU with the ▲ or ▼ cursor buttons, and press the **ENTER** button.
2. To select "VIDEO IN", press ▲ or ▼ cursor button.
3. Using the ◀ or ▶ cursor buttons, select the video input source which is emitted from Monitor out in the 7.1 CH INPUT function.  
The input source is switched by pressing the ◀ or ▶ cursor buttons as follows;  
LAST ↔ TV ↔ DVD ↔ VCR ↔ DSS ↔ AUX1 ↔ V-OFF ↔ LAST ↔

### Notes:

- When select LAST, the source is set previous source before 7.1 CH INPUT function is activated.
- When select V-OFF, no signal is emitted from monitor out terminal.

4. To Select desired channel , press the ▲ or ▼ cursor buttons.
5. Using the ◀ or ▶ cursor buttons, adjust the volume level of each channel.
6. After you complete this portion of the set up, move the cursor to "MAIN" with the ▲ or ▼ cursor buttons and press the **ENTER** button.

### Notes:

- These settings will be memorized to 7.1CH INPUT source.
- This feature can be directly selected with the **CH.SEL** button of the remote controller.

# ADVANCED OPERATION

## AMP OPERATION

### USING THE SLEEP TIMER



To program this unit for automatic standby, press the **SLEEP** button on the remote controller. Each press of the button will increase the time before shut down in the following sequence.

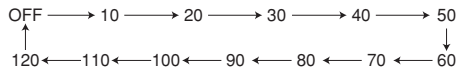

The sleep time will be shown for a few seconds in the display on the front panel, and it will count down until the time has elapsed.

When the programmed sleep time has elapsed, the unit will automatically turn off.

Note that the **SLEEP** indicator on the display will illuminate when the Sleep function is programmed. To cancel the Sleep function, press the **SLEEP** button until the display shows "SLEEP OFF" and the **SLEEP** indicator will disappear.

### DISPLAY MODE

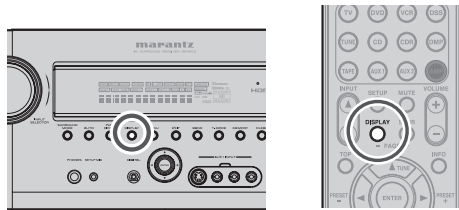

You can select the display mode for the front display of the unit.

To select this mode, press the **DISPLAY** on the front panel or the remote controller.

When this button is pressed, the display mode is switched in the following sequence.

→ Surround Mode → Auto-display Off → Display Off → Input Function → Surround Mode...

In Auto display off mode, the display is off. But, if you make a change to the unit such as input or surround mode, the display will show that change, then go back to off after about 3 seconds. When changing the volume, it is not displayed.

In Display off mode, the display is off completely.

#### Note:

Only the DISP indicator will be illuminated on the front display in display off condition

### RECORDING AN ANALOG SOURCE

In normal operation, the audio or video source selected for listening through this unit is sent to the record outputs.

This means that any program you are watching or listening to may be recorded simply by placing machines connected to the outputs for **TAPE OUT**, **CD/CDR OUT**, **VCR OUT** in the record mode.

*To record the input source signal you are currently watching or listening to*

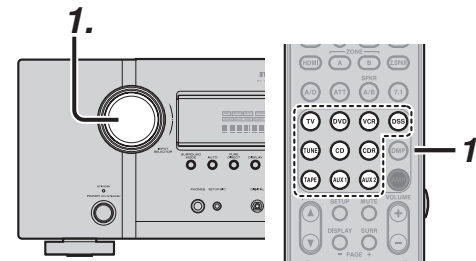

1. Select the input source to record by turning the **INPUT SOURCE** knob on the front panel or simply press the **input selector** buttons on the remote controller.

The input source is now selected and you may watch or listen to it as desired.

2. The currently selected input source signal is output to the **TAPE OUT**, **CD/CDR OUT**, **VCR OUT** outputs for recording.

3. Start recording to the recording component as desired.

### Recording the video from one source and the audio from another

You can add the sound from one source to the video of another source to make your own video recordings.

Below is an example of recording the sound from a compact disc player connected to CD IN and the video from a video camera connected to DSS to video cassette recorder connected to the VCR OUT jack.

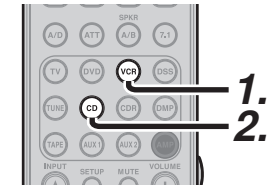

1. Switch the video output source to VCR by simply pressing the **input selector** buttons on the remote controller.
2. Switch the audio input source to CD by simply pressing the **input selector** buttons on the remote controller.
3. Now "CD" has been selected as the audio input source and "VCR" as the video input source.

#### Notes:

- If you change the input source during recording, you will record the signals from the newly selected input source.
- You cannot record the surround effects.
- Digital input signals are only output to the digital outputs. There is no conversion from digital to analog.

When connecting CD players and other digital components, do not connect only the digital terminals, but the analog ones as well.

## SELECTING ANALOG AUDIO INPUT OR DIGITAL AUDIO INPUT



If you have already assigned the digital inputs, you can temporarily select the audio input mode for each input source as following procedures.

Press the **AMP** button and press the **A/D** button. When this button is pressed, the input mode is switched in the following sequence.  
→ HDMI Auto → HDMI → Digital → Analog → HDMI Auto....

In HDMI Auto mode, the types of signals being input to the digital and analog input jacks for the selected input source are detected automatically.

If no digital signal is being input, the analog input jacks are selected automatically.

In Digital and HDMI mode, input is fixed to an assigned digital input terminal.

In analog mode, the analog input jacks are selected. This selecting is temporary, so the result will not be stored in memory.

If you need to change the input mode completely, use INPUT SETUP in OSD menu system. (see page 21)

## SELECTING THE SURROUND MODE

### Example: AUTO SURROUND

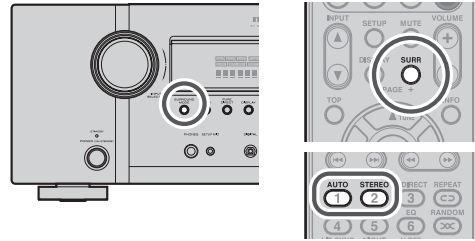

To select the surround mode during playback, press the **SURROUND MODE** button on the front panel or the **SURROUND MODE** buttons on the remote controller.

### NIGHT MODE



Press the **NIGHT** button on the remote controller to turn on the NIGHT mode.

Selecting the Night Mode ON is effective in Dolby Digital only, and it compresses the dynamic range. This softens loud passages such as sudden explosions, to help prevent disturbing others late at night.

To turn off the Night mode, press the **NIGHT** button again.

## LISTENING THROUGH HEADPHONES

This jack may be used to listen to the unit's output through a pair of headphones. Be certain that the headphones have a standard 1/4" stereo phone plug.

Note that the speakers will automatically be turned off when the headphone jack is in use.

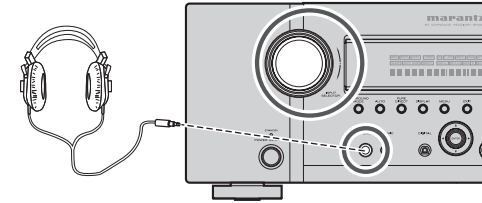

### Notes:

- When using headphones, the surround mode will change to BYPASS and Dolby Headphone by MENU and Cursor button.
- The surround mode returns to the previous setting as soon as the headphone plug is removed from the jack.
- The tone control function can not work through the headphones output.

## DOLBY HEADPHONE MODE

This feature simulates the waveforms of the actual sounds heard from the speakers.

When headphones are used, the **MENU** button automatically switches to the Dolby headphone mode.

The OSD that appears when the **MENU** button is pressed is shown below.

HEAD PHONE	
DOLBY HP MODE	: ON
SURROUND	: OFF
L LEVEL	: 0 dB
R LEVEL	: 0 dB

DOLBY HP (Headphone) MODE can be selected with the left and right cursor buttons.

BYPASS → ON → BYPASS

BYPASS: Bypasses the Dolby headphone mode and delivers ordinary 2-channel stereo.

ON: Dolby headphone mode active.

When the PURE DIRECT and SOURCE DIRECT mode is selected, Dolby surround processing is bypassed and "\*\*\*" is displayed as the mode indication.

The surround mode can be selected when mode is ON.

L/R LEVEL can be set in the ±10 dB range.

### Notes:

- The surround mode returns to the previous setting as soon as the plug is removed from the jack.
- The Dolby Headphone function will not work when 32 or 96 kHz PCM digital signals are input.

**ATTENUATION TO ANALOG INPUT SIGNAL**



If the selected analog audio input signal is greater than the capable level of internal processing, the "PEAK" indicator will light up on the front display. If this happens, you should press the **ATT** button on the remote controller.

"ATT" indicator will be illuminated when this function is activated. The signal-input level is reduced by about half. Attenuation will not work with the output signal of TAPE-OUT, CD/CDR-OUT and VCR-OUT. This function is memorized for each individual input source.

**7.1 CH INPUT**

This unit is equipped for future expansion through the use of Multi channel Super Audio CD multichannel player or DVD-Audio player.

When this is selected, the input signals connected to the L(front left), R (front right), CENTER, SL (surround left), SR (surround right) and SBL (surround back left) and SBR (surround back right) channels of the 7.1 CH. In jacks are output directly to the front (left and right), center, surround (left and right) and surround back speaker systems as well as the pre-out jacks without passing through the surround circuitry.

In addition, the signal input to the SW (subwoofer) jack is output to the PRE OUT SW (subwoofer) jack. When 7.1 CH. INPUT is selected, the last video input used remains routed to the **Monitor Outputs**. This permits simultaneous viewing with video sources.

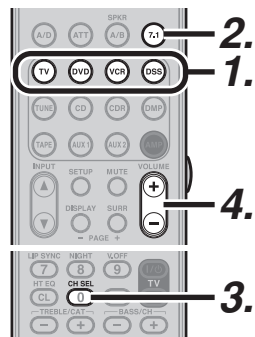
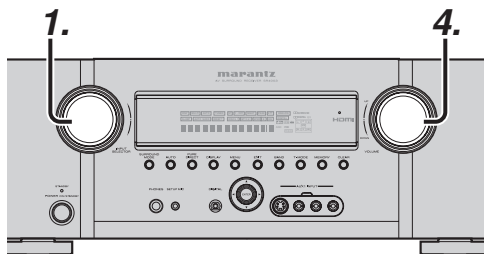

1. Select a desired Video source to decide the routed video signal to the **Monitor Outputs**.
2. Press the **7.1** button on the remote controller to switch the 7.1 channel input.
3. If it is necessary to adjust the output level of each channel, press the **CH.SEL** button on the remote controller.

Adjust the speaker output levels so that you can hear the same sound level from each speaker at the listening position. For the front left, front right, center, surround left, surround right and surround back speakers, the output levels can be adjusted between -10 to +10 dB.

The subwoofer can be adjusted between -15 and +10 dB.

These adjustments result will be stored to 7.1 CH. INPUT memory.

4. Adjust the main volume with the **MAIN VOLUME** knob or the **VOLUME** buttons on the remote controller.

To cancel the 7.1 CH. INPUT setting, press **7.1** on the remote controller.

**Notes:**

- 7.1 CH. Input mode bypasses the internal surround processing, so SURROUND mode cannot be selected.
- In addition, there is no signal at the record outputs when the 7.1 CH. Input is in use.

**AUX2 INPUT**

If you don't need to connect 7.1 Ch. input terminals with multi channel decoder, L(front left) and R (front right) inputs terminals are available as AUX2 input.

In this case, You can connect additional audio source to AUX2 as other audio input terminals.

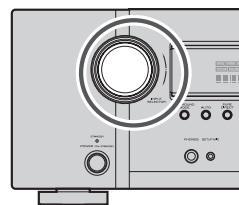

**HT-EQ (HOME THEATER EQUALIZER)**

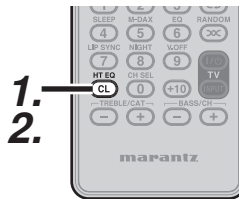

At cinemas, the front left, front right and center speakers are located behind the screen. So, screen damping is taken into account when mastering movie software, with an emphasis on high frequencies. When playing back such software at home, the signal takes on different characteristics from those at the cinema. This unit includes HT-EQ to rectify the sound difference between that experienced at a cinema and in a home theater, allowing you to enjoy the same sound you would experience at the cinema at home. The HT-EQ feature is available except in the following modes.

- 7.1 CH INPUT
- PURE-DIRECT
- SOURCE DIRECT
- When VIRTUAL is set for the surround mode

1. Press the **HT EQ** button on the remote controller.

"EQ" indicator on the front panel will illuminate, indicating the HOME THEATER EQUALIZER has been activated.

2. To cancel this function, press the **HT EQ** button again.

"EQ" indicator on the front panel will be turned off, indicating the HOME THEATER EQUALIZER has been deactivated.

**TV AUTO ON/OFF FUNCTION**

This function allows the component connected to the TV-VIDEO in jack to control the power (ON/OFF) to the unit.

**AUTO POWER ON**

1. Be sure the TV auto mode is ENABLED. (Refer page 22 : System Setup)
2. Connect your TV TUNER (etc) to the TV-VIDEO in terminal. Be sure to connect the VIDEO input.
3. Turn OFF the power to the TV TUNER and the unit.
4. Turn ON the TV TUNER and tune in a receivable station.
5. When the station is received, this unit turns ON and TV is selected automatically.

**AUTO POWER OFF**

1. In the above situation, turn the TV TUNER OFF or select a channel that does not contain any broadcast.
2. The power to the unit switches to STANDBY after approx. 5 minutes.

**Notes:**

- AUTO POWER OFF is canceled if this unit is set to a source other than TV.  
The function reactivates when TV is selected again.
- Some TV broadcasts may cause the TV AUTO FUNCTION to turn ON.
- The S-Video terminal does not support "TV AUTO ON/OFF" function.

**VIDEO ON/OFF**

When no video signal is connected to the unit or a DVD, etc., is connected directly to your TV, the unnecessary video circuit can be turned off by selecting the "VIDEO OFF" setting. To select video off, press the **AMP** button and press the **V.OFF** button.

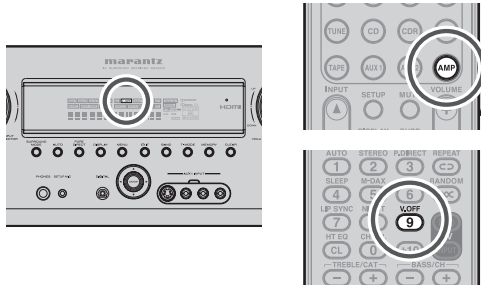
**VIDEO CONVERT**

When this function is activated, the video or S-video signal can be emitted from the video, S-video or component video output terminal. To activate this function, select VIDEO CONVERT in PREFERENCE menu and set ENABLE.

**Notes:**

- The component video signal is emitted only from component video output terminal.
- When the video equipment is connected by component terminal, connect the monitor and the unit by the component terminal.
- This function is unavailable for the REC out terminal.
- This function is unavailable for the still picture, fast forward and reverse playing of the video component.
- If, while attempting to use the video convert feature, the unit cannot synchronize with the display device, "NO SIGNAL" appears on the monitor, or noise is generated, this feature cannot be used. All of these signs are caused by equipment incompatibility; there is nothing wrong with the unit.

In such case, set VIDEO CONVERT in the PREFERENCE menu to DISABLE. Also, connect the video input signal to the display device via the MONITOR OUT terminal under VIDEO and the S-video input signal to the display device via the MONITOR OUT terminal under S-VIDEO.

**Example:**

Monitor is connected with the component.

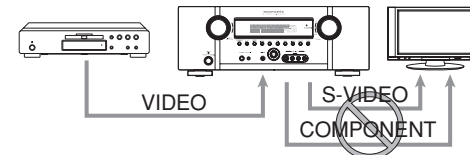
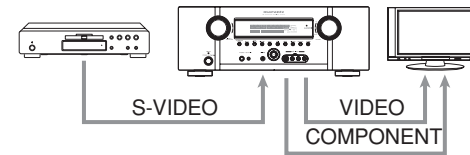

The signal cannot be converted from the video to component or S-Video.

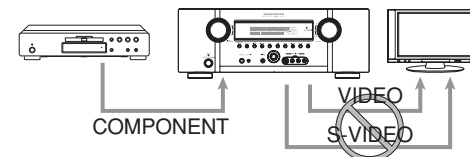

The signal cannot be converted from the component to the video or S-video.

**Notes of OSD menu:**

- The setup menu can be displayed through all video out (COMPONENT, S-VIDEO, VIDEO).
- The setting informations (e.g. volume setting) are displayed through all video out when the VIDEO CONVERT function are set ON.

**Note:**

No setting information is displayed when the signal is emitted from the COMPONENT IN to COMPONENT OUT.

- The setting informations (e.g. volume setting) are displayed through the S-VIDEO or VIDEO out when the VIDEO CONVERT function are set DISABLE. When the S-VIDEO and VIDEO outputs are used simultaneously, the setting informations are displayed through the S-VIDEO out only.

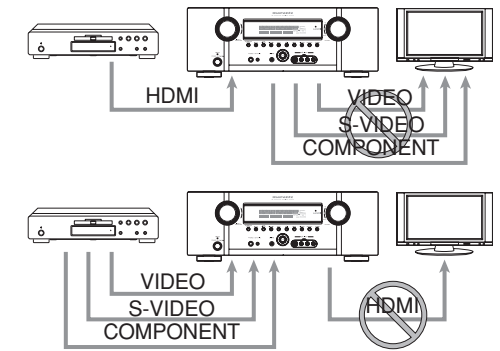
**HDMI****Notes of OSD menu:**

HDMI: OSD menu is not displayed.  
VIDEO/S-VIDEO/component: VIDEO CONVERT of HDMI is not possible, thus the OSD menu is not displayed.



### SURROUND SPEAKER B SYSTEM

The Surround Speaker B system is a function which allows you to listen to the same source in a room other than the room in which the unit is located. The operations possible with the Surround speaker function are explained briefly below.

### ANOTHER ROOM PLAYBACK USING THE S (SURROUND) SPEAKER B TERMINALS

The unit allows you to connect another set of speakers and place them in a another room or separated area for listening to music.

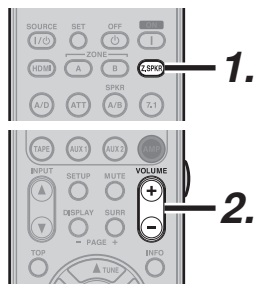

1. Press the **Z.SPKR** button on the remote controller. The unit enters surround speaker B mode and the **"SPKR B"** will appear on the display.
2. The volume of S. SPEAKER B is interlocked with the main volume.

#### Notes for SURROUND SPEAKER B

- SURROUND SPEAKER B On/ Off is available in main room only.
- SURROUND SPEAKER B output terminals can be used when the SURROUND BACK SPEAKER is set NONE in SPEAKER SETUP menu. (See SPEAKER SETUP, page 21)
- "The Surr. Back Speakers are in use" is displayed by pressing the **Z. SPKR** button on the remote controller when the SURROUND BACK SPEAKER is set except NONE in SPEAKER SETUP menu. (See SPEAKER SETUP, page 21)
- Surround Speaker B function is unavailable, while the unit is 7.1 CH input mode.

### TUNER OPERATION (PRESET MEMORY)

With this unit you can preset up to 50 FM/AM stations in any order. For each station, you can memorize the frequency and reception mode if desired.

#### AUTO PRESET MEMORY

This function automatically scans the FM and AM band and enters all stations with proper signal strength into the memory.

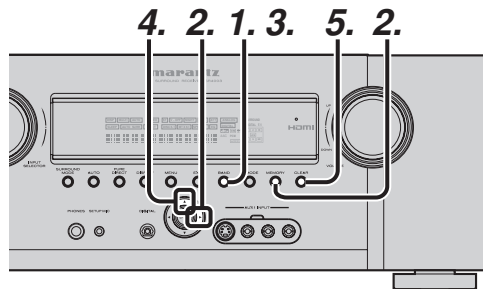

1. To select FM, press the **BAND** button on the front panel.
2. While pressing the **MEMORY** button, press the **▶** cursor button. **"AUTO PRESET"** will appear on the display, and scanning starts from the lowest frequency.
3. Each time the tuner finds a station, scanning will pause and the station will be played for five seconds. During this time, the following operations are possible. The band can be changed by the **BAND** button.
4. If no button is pressed during this period, the current station is memorized in location Preset 01. If you wish to skip the current station, press the **▲** cursor button during this period, this station is skipped and auto presetting continues.
5. Operation stops automatically when all 50 preset memory positions are filled or when auto scanning attains the highest end of all bands. If you desire to stop the auto preset memory at anytime, press the **CLEAR** button.

#### Note:

It is possible that existing preset memory positions will be overwritten.

### MANUAL PRESET MEMORY

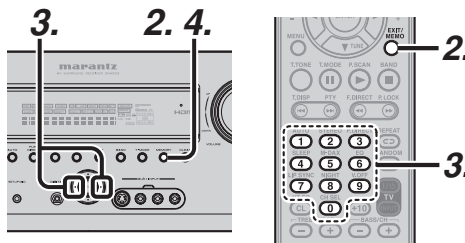

#### (Using the unit)

1. Tune into the radio station you desire (Refer to the **"MANUAL TUNING"** or **"AUTO TUNING"** section).
2. Press the **MEMORY** button on the front panel. **"- -"** (preset number) starts blinking on the display.
3. Select the preset number by pressing the **◀** or **▶** cursor buttons, while this is still blinking (approx. 5 seconds)
4. Press the **MEMORY** button again to enter. The display stops blinking. The station is now stored in the specified preset memory location.

#### (Using the remote controller)

1. Tune into the radio station you desire (Refer to the **"MANUAL TUNING"** or **"AUTO TUNING"** section).
2. Press the **MEMO** button on the remote controller. **"- -"** (preset number) starts blinking on the display.
3. Enter the desired preset number by pressing the **numeric** buttons.

#### Note:

When entering a single digit number (2 for example), either input "02" or just input "2" and wait for a few seconds.

### RECALLING A PRESET STATION

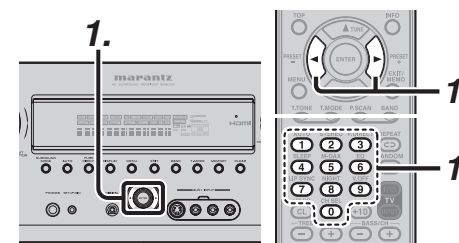

#### (Using the unit)

1. Select the desired preset station by pressing the **◀** or **▶** cursor buttons on the front panel

#### (Using the remote controller)

1. Press the **PRESET +** or **-** buttons to select the desired preset station, or input your desired preset channel with the **numeric** buttons on the remote controller.

### PRESET SCAN

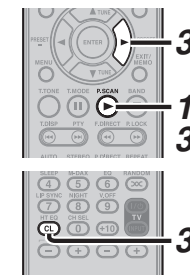

#### (Using the remote controller)

1. Press the **P.SCAN** on the remote controller. **"PRESET SCAN"** appears on the display and then the preset station with the lowest preset number is recalled first.
2. Preset stations are recalled in sequence (No.1 → No.2 → etc.) for 5 seconds each. No stored preset number will be skipped.
3. You can fast forward the preset stations by pressing the **PRESET +** continuously. When the desired preset station is received, cancel the preset scan operation by pressing the **CL** button or **P.SCAN** on the remote controller.

### CLEARING STORED PRESET STATIONS

You can remove preset stations from the memory using the following procedure.

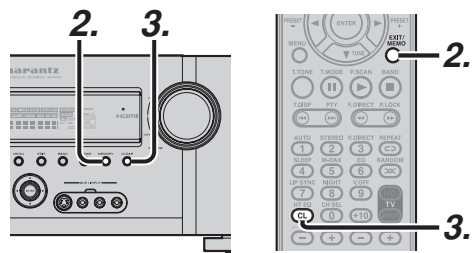

1. Recall the preset number to be cleared with the method described in "Recalling" a preset station.
2. Press the **MEMORY** button on the front panel or press the **MEMO** button on the remote controller.
3. The stored preset number blinks in the display for 5 seconds. While blinking, press the **CLEAR** button on the front panel or the **CL** button on the remote controller.
4. "xx CLEAR" appears on the display to indicate that the specified preset number has been cleared.

**Note:**

To clear all stored preset stations, press and hold the **T.MODE** and the **ENTER** buttons for two seconds.

### SORTING PRESET STATIONS

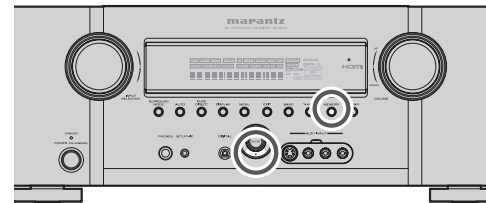

If you have stations memorized, and there is a gap in the sequential order:

I.e. the stations are stored as follows

- 1) 87.5 MHz
- 2) 93.1 MHz
- 3) 94.7 MHz
- 10) 105.9 MHz

(notice there is no stations programmed for pre sets for 4-9), you can have pre set 10 become pre set 4: To sort the numbers, press the **▼** cursor button while pressing the **MEMORY** button. "PRESET SORT" will appear on the display and sorting will be done.

### NAME INPUT OF THE PRESET STATION.

This function allows the name of each preset channel to be entered using alphanumeric characters. Before name inputting, you need to store preset stations with the preset memory operation.

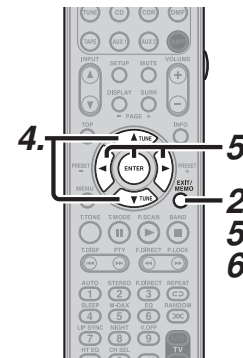
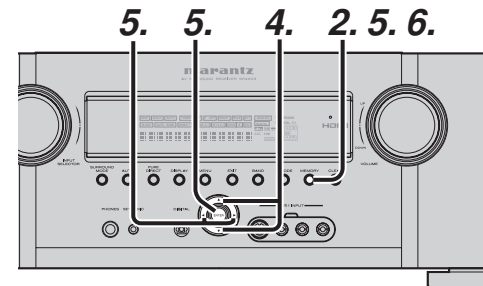

1. Recall the preset number to be inputted name with the method described in "Recalling" a preset station.
2. Press the **MEMORY** button on the front panel or press the **MEMO** button on the remote controller for more than 3 seconds.
3. The left most column of the station name indicator flashes, indicating the character entry ready status.
4. When you press the **▲** or **▼** cursor buttons on the front panel or the **TUNE ▲ / ▼** buttons on the remote controller, alphabetic and numeric characters will be displayed in the following order:

A → B → C ... Z → 1 → 2 → 3 ..... 0 → - → + → / → (Blank) → A

UP →  
← DOWN

5. After selecting the first character to be entered, press the **MEMORY** or **ENTER** buttons, press the **MEMO** button on the remote controller.

The entry in this column is fixed and the next column starts to flash. Fill the next column the same way.

To move back and forth between the characters, press the **◀/▶** cursor buttons or press **PRESET** + or - buttons on the remote controller.

**Note:**

Unused columns should be filled by entering blanks.

6. To save the name, press the **MEMORY** button on the front panel or remote controller for more than 2 seconds.

Ten keypad	Press, press again, press again, etc.
1	A → B → C → 1 → A
2	D → E → F → 2 → D
3	G → H → I → 3 → G
4	J → K → L → 4 → J
5	M → N → O → 5 → M
6	P → Q → R → 6 → P
7	S → T → U → 7 → S
8	V → W → X → 8 → V
9	Y → Z → space → 9 → Y
0	- → + → / → 0

REMOTE CONTROLLER OPERATION

CONTROLLING MARANTZ COMPONENTS

1. Press the desired **SOURCE** button.
2. Press the desired operation buttons to play the selected component.
  - For details, refer to the component's user guide.
  - It may not be possible to operate some models.

CONTROLLING A MARANTZ TV (TV MODE)

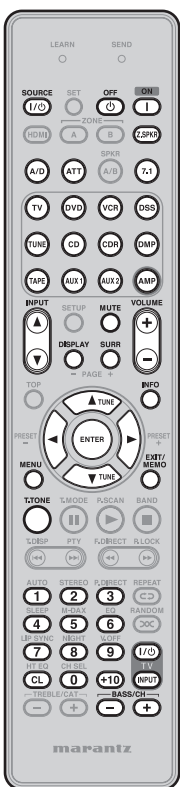

SOURCE ON/OFF	Turns the TV on and off
POWER ON	Turns the TV on(*)
POWER OFF	Turns the TV off(*)
Z.SPKR	AMP function enabled
A/D	AMP function enabled
ATT	AMP function enabled
7.1 IN	AMP function enabled
SOURCE	AMP function enabled
AMP	AMP function enabled
INPUT ▲ / ▼	AMP function enabled
DISPLAY	AMP function enabled
MUTE	AMP function enabled
SURR	AMP function enabled
VOLUME+/-	AMP function enabled
INFO	Display the information of TV(*)
Cursor	Moves the cursor for setting (*)
ENTER	Enters the setting(*)
MENU	Calls up the menu(*)
EXIT	Exits from MENU(*)
T.TONE	AMP function enabled
0-9,+10	Inputs the numeric(*)
HT EQ(CL)	Clears the inputting(*)
TV POWER	Turns the TV on and off
TV INPUT	Select the TV video input
BASS/CH	Selects TV channel up or down

(\*) RC004SR dose not have the PRESET code library for this key

CONTROLLING A MARANTZ DVD (DVD MODE)

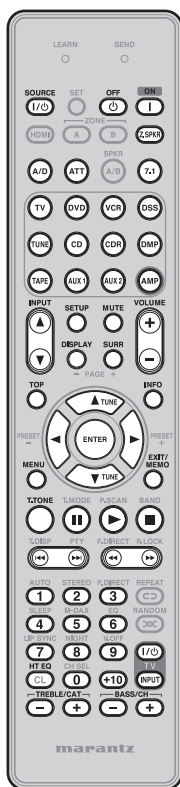

SOURCE ON/OFF	Turns the DVD player on and off
POWER ON	Turns the DVD player on(*)
POWER OFF	Turns the DVD player off(*)
Z.SPKR	AMP function enabled
A/D	AMP function enabled
ATT	AMP function enabled
7.1 IN	AMP function enabled
SOURCE	AMP function enabled
AMP	AMP function enabled
INPUT ▲ / ▼	AMP function enabled
SETUP	Calls up the setup menu of the DVD player(*)
DISPLAY	AMP function enabled
MUTE	AMP function enabled
SURR	AMP function enabled
VOLUME+/-	AMP function enabled
TOP	Calls up the top menu of DVD disc(*)
INFO	Displays the disc information(*)
Cursor	"Moves the cursor for setting in "On Screen Display"" mode
ENTER	Enters the setting
MENU	Calls up the menu of DVD disc
EXIT	Exits from SETUP MENU(*)
T.TONE	AMP function enabled
PAUSE	PAUSE
PLAY	PLAY
STOP	STOP
Previous/Next	Sk ips forward or previous chapter/track
Rewind/Forward	Searchs forward or backward
0-9,+10	Inputs the numeric(*)
HT EQ(CL)	Clears the inputting(*)
REPEAT	Select REPEAT PLAY(*)
RANDOM	Select RANDOM PLAY(*)
TV POWER	Turns the TV on and off
TV INPUT	Select the TV video input
TREBLE+/-	AMP function enabled
BASS+/-	AMP function enabled

(\*) RC004SR dose not have the PRESET code library for this key

CONTROLLING A MARANTZ DSS (DSS MODE)

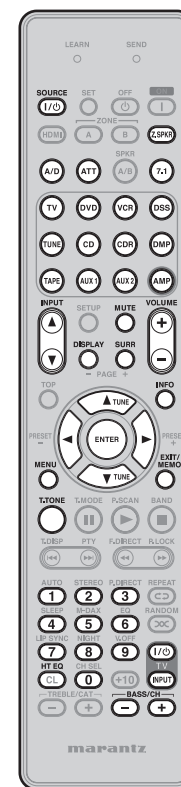

SOURCE ON/OFF	Turns the satellite broadcasting tuner on and off
Z.SPKR	AMP function enabled
A/D	AMP function enabled
ATT	AMP function enabled
7.1 IN	AMP function enabled
SOURCE	AMP function enabled
AMP	AMP function enabled
INPUT ▲ / ▼	AMP function enabled
DISPLAY	AMP function enabled
MUTE	AMP function enabled
SURR	AMP function enabled
VOLUME+/-	AMP function enabled
INFO	Display the information of the satellite broadcasting tuner(*)
Cursor	Moves the cursor for setting
ENTER	Enters the setting
MENU	Calls up the menu
EXIT	Exits from MENU(*)
T.TONE	AMP function enabled
0-9	Inputs the numeric
HT EQ(CL)	Clears the inputting(*)
TV POWER	Turns the TV on and off
TV INPUT	Select the TV video input
BASS/CH	Selects the satellite broadcasting tuner channel up or down

(\*) RC004SR dose not have the PRESET code library for this key

NAMES AND FUNCTIONS  
BASIC CONNECTIONS  
BASIC OPERATION  
ADVANCED CONNECTIONS  
SETUP  
ADVANCED OPERATION  
TROUBLESHOOTING  
OTHERS

**CONTROLLING A MARANTZ CD (CD MODE)**

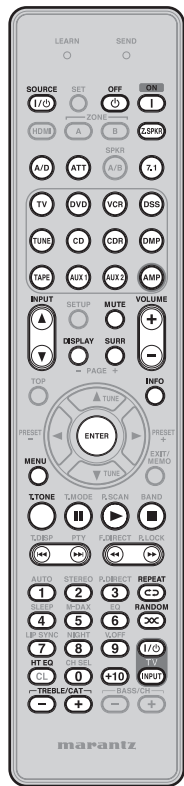

SOURCE ON/OFF	Turns the CD player on and off
POWER ON	Turns the CD player on(*)
POWER OFF	Turns the CD player off(*)
Z.SPKR	AMP function enabled
A/D	AMP function enabled
ATT	AMP function enabled
7.1 IN	AMP function enabled
SOURCE	AMP function enabled
AMP	AMP function enabled
INPUT ▲ / ▼	AMP function enabled
DISPLAY	AMP function enabled
MUTE	AMP function enabled
SURR	AMP function enabled
VOLUME +/-	AMP function enabled
INFO	AMP function enabled
ENTER	Enters the setting(*)
MENU	Calls up the menu(*)
T.TONE	AMP function enabled
PAUSE	PAUSE
PLAY	PLAY
STOP	STOP
Previous/Next	Sk ips forward or prev ious chapter/track
Rewind/Forward	Searchs forward or backward
0-9,+10	Inputs the numeric(*)
HT EQ(CL)	Clears the inputting(*)
REPEAT	Select REPEAT PLAY(*)
RANDOM	Select RANDOM PLAY(*)
TV POWER	Turns the TV on and off
TV INPUT	Select the TV video input
TREBLE-/+	AMP function enabled
BASS-/+	AMP function enabled

(\*) RC004SR dose not have the PRESET code library for this key

**CONTROLLING A MARANTZ TAPE DECK (TAPE MODE)**

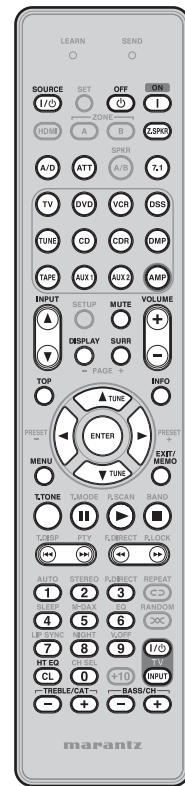

SOURCE ON/OFF	Turns the TAPE deck on and off
POWER ON	Turns the TAPE deck on
POWER OFF	Turns the TAPE deck off
Z.SPKR	AMP function enabled
A/D	AMP function enabled
ATT	AMP function enabled
7.1 IN	AMP function enabled
SOURCE	AMP function enabled
AMP	AMP function enabled
INPUT ▲ / ▼	AMP function enabled
DISPLAY	AMP function enabled
MUTE	AMP function enabled
SURR	AMP function enabled
VOLUME +/-	AMP function enabled
TOP	AMP function enabled
INFO	AMP function enabled
Cursor	AMP function enabled
ENTER	AMP function enabled
MENU	AMP function enabled
EXIT	AMP function enabled
T.TONE	AMP function enabled
PAUSE	PAUSE
PLAY	PLAY
STOP	STOP
Previous/Next	Sk ips forward or prev ious chapter/track
Rewind/Forward	Searchs forward or backward
0-9	Inputs the numeric
HT EQ(CL)	Clears the inputting
TV POWER	Turns the TV on and off
TV INPUT	Select the TV video input
TREBLE-/+	AMP function enabled
BASS-/+	AMP function enabled

RC004SR dose not have the PRESET code library for this device.

**CONTROLLING A MARANTZ UNIVERSAL DOCK (AUX MODE)**

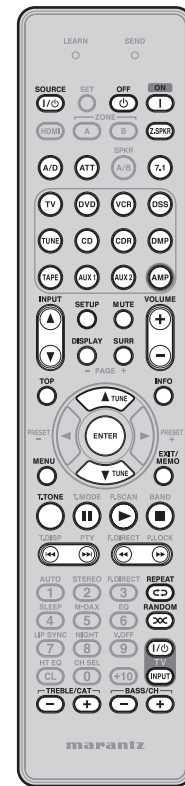

SOURCE ON/OFF	Turns the UNIVERSAL DOCK (Dock connector) ON and OFF
POWER ON	Turns the UNIVERSAL DOCK (Dock connector) ON
POWER OFF	Turns the UNIVERSAL DOCK (Dock connector) OFF
Z.SPKR	AMP function enabled
A/D	AMP function enabled
ATT	AMP function enabled
7.1 IN	AMP function enabled
SOURCE	AMP function enabled
AMP	AMP function enabled
INPUT ▲ / ▼	AMP function enabled
SETUP	MODE
DISPLAY	AMP function enabled
MUTE	AMP function enabled
SURR	AMP function enabled
VOLUME +/-	AMP function enabled
INFO	AMP function enabled
Cursor Up	Select contents Up
ENTER	Enter the setting
Cursor Down	Select contents Down
MENU	Call up the menu
T.TONE	AMP function enabled
PAUSE	PAUSE
PLAY	PLAY
STOP	STOP
Previous/Next	Sk ips forward or prev ious chapter/track
Rewind/Forward	Searchs forward or backward
REPEAT	Select REPEAT PLAY
RANDOM	Select RANDOM PLAY
TV POWER	Turns the TV on and off
TV INPUT	Select the TV video input
TREBLE-/+	AMP function enabled
BASS-/+	AMP function enabled

RC004SR dose not have the PRESET code library for this device.

**BASIC OPERATION (REMOTE CONTROLLER)**

**NORMAL MODE**

*(When operating Marantz AV equipment products)*

This remote controller is preset with a total of 12 types of remote codes, including Marantz TV (television), DVD, VCR (VCR deck), DSS (satellite broadcasting tuner), TUNER, CD, CD-R, DMP, TAPE (tape deck), AUX1, AUX2, and AMP (amplifier).

Learning is not necessary for Marantz products. You can use these products without setting any codes.

1. Press the **SOURCE** button.  
For this example, press DVD.  
Pressing the **SOURCE** button once changes the remote control to the settings for the source that was pressed.  
To change the amplifier on other source, press the **SOURCE** button twice (double-click). The code is sent, and then the amplifier source changes to DVD.

**SETTING THE BACK LIGHT**

Pressing the Light button located on the side of the remote controller lights the remote controller's backlight. Pressing the button again while the backlight is lit lights the backlight for another 2 seconds.  
To turn off back light, press and hold down the **SET** and **OFF** button until SEND indicator blinks twice.  
To turn on it again, press and hold down the **SET** and **ON** button until SEND indicator blinks twice.  
Initial is back light ON.

**PRESET MODE**

*(When operating non-Marantz AV equipment products)*

This remote controller is preset with remote control codes from AV equipment by other manufacturers. The preset codes are TV, CD, DVD and DSS. Settings can be made in one of two ways.  
When the preset codes are set, the following codes are contained in the source button of the remote controller.

See the attached manufacturer number list for the preset manufacturers, devices, preset numbers, and other settings.

Remote controller source name	Corresponding preset code	Device name
TV	TV	Television
DVD	DVD	DVD player
CD	CD	CD player
DSS	SATELLITE	Satellite broadcasting tuner equipment

**Important:**

- Some codes may be not match your equipment. In this case, you can use LEARN mode to store these codes.
- The preset codes do not cover full functions. If you need extra function, use LEARN mode to store extra function.
- When the batteries are getting weak, the preset procedure is not successful.

**PROGRAMMING WITH THE 4-DIGIT CODE**

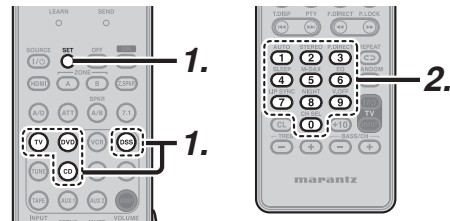

1. Press and hold down the **SOURCE** button for the appliance which should be controlled and press **SET** button until the SEND indicator blinks twice. Then back light flashes.
2. Press the 4-digit code by **numeric** buttons for appliance (code table at the end of this book) When the procedure is successful, the SEND indicator will blink twice.

**Note:**

If the indicator did not blink twice, then repeat steps 1 through 2 and try entering the same code again.

**SCANNING THE CODE TABLE**

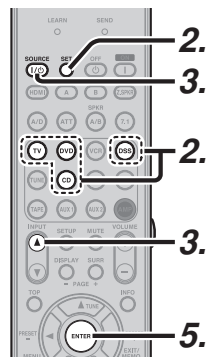

1. Switch on the appliance which should be controlled.

2. Press and hold down the **SOURCE** button for appliance which should be controlled and press **SET** button until the SEND indicator blinking twice. Then back light flashes.
3. Aim the remote control at the appliance and slowly alternate between pressing **INPUT ▲** button and the **SOURCE ON/OFF** button for the appliance.
4. Stop when the appliance turns off.
5. Press **ENTER** button once to lock in the code.

**CHECKING THE CODE**

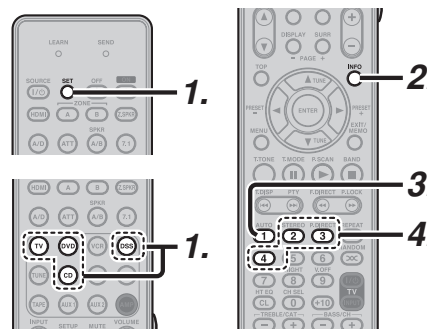

1. Press and hold down the **SOURCE** button for appliance which should be controlled and press **SET** button until the SEND indicator blinking twice then back light flashes.
2. Press the **INFO** button.  
The SEND indicator will blink twice.
3. To view the code for first digit, press **1** once.  
Wait 3 seconds, count the SEND indicator blinks (e.g. 3 blinks = 3) and write down the number.

**Note:**

If a code digit is "0", the SEND indicator will not blink.

4. Repeat step **3** three more times for remaining digits. Use **2** for the second digit, **3** for the third digit, and **4** for the fourth digit.

**RESETTING THE CODE**

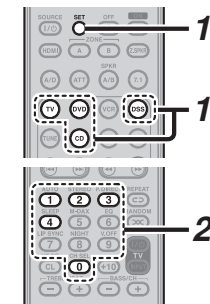

1. Press and hold down the **SOURCE** button for appliance which should be controlled and press **SET** button until the SEND indicator blinking twice.  
Then back light flashes.
2. Press the below codes to reset.  
TV : 1000  
DVD : 2000  
CD : 3000  
DSS : 4000  
The indicator will blink twice.

**Note:**

After this procedure, the selected **SOURCE** button is set initial code.

## LEARN MODE

This remote controller is capable of learning and storing codes used by other remote controls that you already own.

For codes which are not learned, the remote controller will transmit either the Marantz preset codes from the initial settings, or remote codes from another manufacturer's AV equipment which is set by the customer.

The receiver sensor for the remote controller signals is located at the top of the remote controller.

### Notes:

- This remote controller is capable to learn around 60 codes.
- When the batteries are getting weak, the learning procedure is not successful.

## LEARNING PROCEDURE

1. Place the remote controller so that its infrared signal transmitter is facing the infrared signal receiver on the Marantz remote controller at a distance of about 0.05 m (2 inches).

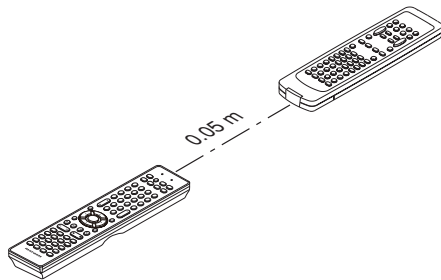

2. Press and hold down the **SET** and **SETUP** buttons until LEARN indicator blinks.

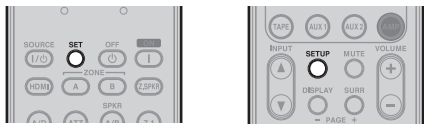

3. Select the **SOURCE** button to select the SOURCE.

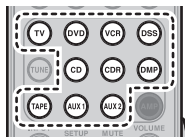

4. Select the button to be learned.
  - LEARN indicator lights up.

### Notes:

- The learning function is unavailable for all SOURCE buttons and HDMI button in any mode.
- The learning function is unavailable for all buttons in TUNER mode and AMP mode.

5. Press and hold the button of the original remote controller to learn until the SEND indicator blinks twice.

### Notes:

- When the SEND indicator blinks once, repeat this step.
- If the LEARN indicator flashes when the SEND indicator is lit, then the button cannot be learned.
- When the memory of the remote controller is full, the LEARN and SEND indicators blink once. If you want to learn the code, you should erase other learned button.

6. Repeat steps 4 and 5 to learn other buttons in same SOURCE.

7. Repeat steps 3 to 6 to learn other SOURCE.

8. When you have finished programming the remote controller, press the **SET** button, then LEARN indicator stops blinking and exits from the LEARN mode.



### Notes:

- When the SEND indicator blinks once again, the transmitting code is unavailable for remote controller, or the transmitting signal is intercepted by noise.
- If no buttons are pressed for approximately 1 minutes while in the LEARN mode, the remote controller automatically exits from the LEARN mode.

## ERASING PROGRAMMED CODES (RETURNING TO INITIAL SETTINGS)

Codes can be erased in three ways: by buttons, sources, and by all memory contents.

### Erasing the code by buttons

1. Press and hold down the **SET** and **SETUP** buttons until LEARN indicator blinks.



2. Select the **SOURCE** button to select the button to be erased.

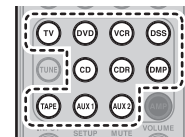

3. Press and hold down the **HDMI** button and press the learned button twice to be erased.
  - SEND indicator blinks twice and the mode returns to LEARN mode.



4. To return the NORMAL mode, press the **SET** button.

### Erasing the code by SOURCE

1. Press and hold down the **SET** and **SETUP** buttons until LEARN indicator blinks.



2. Press and hold down the **HDMI** button and press the learned **SOURCE** button twice to be erased.
  - LEARN indicator lights.

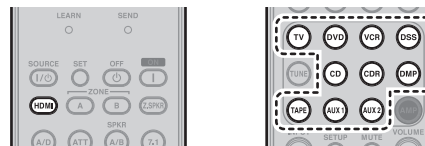

3. Press **ENTER** button to continue erasing.
  - The SEND indicator blinks twice and the mode returns to LEARN mode.
  - To cancel the erasing operation, do not press **ENTER** button and simply touch any other button.

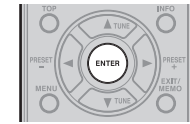

4. To return the NORMAL mode, press the **SET** button.

### Erasing the all SOURCES

1. Press and hold down the **SET** and **SETUP** buttons until LEARN indicator blinks.



2. Press and hold down the **HDMI** button and press **POWER ON** and **POWER OFF** button.
  - LEARN indicator lights.



3. Press **ENTER** button to continue erasing.
  - The SEND indicator blinks twice and the mode returns to LEARN mode.
  - To cancel the erasing operation, do not press **ENTER** button and simply touch any other button.

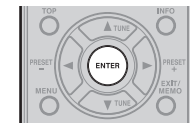

4. To return the NORMAL mode, press the **SET** button.

### Note:

Erasing codes will return to the factory preset code, or there will leave empty if the button has no factory preset code.

# TROUBLESHOOTING

In case of trouble, check the following before calling for service:

1. Are the connections made properly ?
2. Are you operating the unit properly following the user's guide ?
3. Are the power amplifiers and speaker working properly ?

If the unit does not operate properly, check items shown in the following table.  
If your trouble cannot be recovered with the remedy actions listed in the following table, malfunction of the internal circuitry is suspected; immediately unplug the power cable and contact your dealer, nearest Marantz authorized dealer or the Marantz Service Center in your country.

SYMPTOM	CAUSE	REMEDY
This unit cannot be turned up.	The power plug is not connected.	Connect the power plug to the outlet.
No sound and picture are output even when power is on.	Mute is on.	Cancel mute using the remote controller.
	The input cable is not connected correctly.	See the connection diagram and connect the cables correctly.
	The master volume control is turned all the way down.	Adjust the master volume.
	The SOURCE position is wrong.	Select correct position.
No speaker output.	The headphones are connected to the headphone jack.	Disconnect the headphones. (Speakers will not output sound when headphones are connected.)
Incorrect Audio or Video for selected source.	Input cable connected incorrectly.	Connect the cable correctly by referring to the connection diagram.
Incorrect Audio from a channel.	Speaker cable connected incorrectly.	Connect the cable correctly by referring to the connection diagram.
No Audio output from the center channel speaker.	The center speaker cable connection is incomplete.	Connect the cable correctly.
	STEREO has been selected for Surround mode.	When STEREO is selected for Surround mode, no sound will be output from the center speaker. Set another Surround mode.
	Center = NONE has been selected in SETUP mode.	Make the correct setting.
No Audio output from the surround speakers.	The surround speaker cable connection is incomplete.	Connect the cable correctly.
	STEREO has been selected for Surround mode.	When STEREO has been selected for Surround mode, no sound will be output from the surround speaker. Set another Surround mode.
	Surround = NONE has been selected in SETUP mode.	Make the correct setting.
No Audio output from the surround back speakers.	The surround back speaker cable connection is incomplete.	Connect the cable correctly.
	Surround mode is not EX/ES mode.	Set surround mode EX/ES.
	Surround back = NONE has been selected in SPEAKERS SIZE SETUP	Make the correct setting.

SYMPTOM	CAUSE	REMEDY
Can not select EX/ES mode.	Surround center= NONE has been selected in SPEAKERS SIZE SETUP	Make the correct setting.
	Input signal is incompatible.	Use 5.1channel source.
Can not select Pro Logic Iix mode.	Input signal is incompatible.	Use 2 channel Dolby Digital input signal, PCM input signal or analog input signal.
Can not select Neo:6 mode.	Input signal is incompatible.	Use 2 channel Dolby Digital input signal, PCM input signal or analog input signal.
Can not select CSII mode.	Input signal is incompatible.	Use 2 channel Dolby Digital input signal, PCM input signal or analog input signal.
No output to Sub Woofer Out.	Sub-woofer = NONE has been selected in SETUP mode.	Select Sub-woofer = YES.
Noise is produced during DTS-encoded CD or laser disc play.	Analog has been selected for input.	Be sure to perform digital connection, select digital input, then play.
A specific channel does not produce output.	Nothing recorded on source.	Check the encoded channel on the source side.
FM or AM reception fails.	Antenna connection is incomplete.	Correctly connect the indoor FM and AM antennas to FM and AM antenna outlets.
Noise is heard during AM reception.	Reception is affected by other electrical fields.	Try changing location where the AM indoor antenna is set up.
Noise is heard during FM reception.	The radio waves from the broadcasting station are weak.	Install an FM outdoor antenna.
Cannot get programmed station when the PRESET button is pressed.	Preset data has been erased.	Disconnecting power plug for long periods of time will erase preset data. If that happens, input the preset data again.
Control with the remote controller fails.	Batteries are consumed.	Replace all the batteries with new ones.
	Remote controller's function-key setting is wrong.	Select different position from which equipment will be controlled.
	The distance between this unit and the remote commander is too far.	Move closer to this unit.
MRAC is not working.	Headphones are connected.	Something is blocking this unit and the remote commander.
		Remove offending object.

HDMI

SYMPTOM	CAUSE	REMEDY
The display does not appear over an HDMI connection.	The connected monitor or projector does not support HDCP.	<ul style="list-style-type: none"> <li>Connect to equipment that supports HDCP.</li> <li>Please change the method of connection.</li> </ul>
	The HDMI input of on the TV is not on.	Set HDMI input so that it turns on, as explained in the TV's instruction manual.
	The HDMI output on the source component (DVD, Set Top Box, etc.) is not on.	Set HDMI output so that it turns on, as explained in the source component's instruction manual.
	The HDMI mode is not correctly set on the unit.	Set HDMI input on the FUNC INPUT SETUP menu as explained on page 15.
	The HDMI output video resolution of the source component (DVD, Set Top Box, etc.) does not match the TV specifications.	Set the resolution so that it matches, as explained in the instruction manuals of both components.
	The device is connected with a non-standard HDMI cable.	The 5 m or shorter cable is recommended to ensure stable operation and prevent image quality deterioration.
	Power to the unit is off. (When the unit is on standby, HDMI connections cannot be turned on.)	Turn on the power to the unit.
The OSD menu does not appear over an HDMI connection.	The connection between HDMI components was not authenticated.	Shut off and then turn the power back on to the unit, TV and source component.
	The unit SETUP menu does not support HDMI output.	Use the COMPONENT VIDEO, S-VIDEO or VIDEO output.
Time is needed for the display of an HDMI connection to appear.	The connection is being authenticated between the HDMI devices.	There is nothing wrong with the system. Some HDMI devices require time for authentication.
Audio is not played back over an HDMI connection.	The HDMI audio output of the source component (DVD, Set Top Box, etc.) is not on.	Set the HDMI audio output so that it turns on, as explained in the source component's instruction manual.
	The signal format of the source component (DVD, Set Top Box, etc.) is not supported by the unit.	Set the HDMI audio output so that it can connect to the unit, as explained in the source component's instruction manual.
	The unit is set to the HDMI audio "THROUGH" mode.	In the "THROUGH" mode, sound is not produced from the unit. Set it to "ENABLE". (see page 24)
DVD-Audio is not played back over an HDMI connection.	The DVD player does not support CPPM, therefore it cannot output HDMI audio.	<ul style="list-style-type: none"> <li>Use a DVD-Audio player that supports CPPM.</li> <li>Turn on PCM downsampling on the DVD player.</li> <li>Use an analog connection.</li> </ul>
Super Audio CD is not played back over an HDMI connection.	The current HDMI connection does not support Super Audio CDs.	Use an analog connection.

**Note:**

Sometimes, when "PROTECT" is shown on the unit's display, the standby indicator flashes slowly (twice a second). When this happens, turn off the unit's power and remove the power cable. Then follow the procedure described below:

- Check to ensure that the speaker cables connected to the unit have not been connected with + and - connections reversed.
- Check to ensure that the speaker cables connected to the unit are not short-circuiting (check the connections both on the unit and on the speakers).  
(Check that the playback volume is not greater than the unit can handle.)
- Check that the playback volume is not greater than the unit can handle.

After completing the above checks, connect the power cable and switch the unit back ON using the remote control. Then, after reducing the volume, start playback and check that "PROTECT" is not appearing on the display and that there is no problem with speaker connections to the unit or with sound reproduction.

If the same problem re-occurs, please contact your local service center to have it repaired.

On rare occasions, the unit will go into standby mode with the standby indicator flashing rapidly (eight times a second). When this happens, it means that some major problem has occurred with the unit. Quickly disconnect the power cable and take the unit to your local service center to have it repaired.

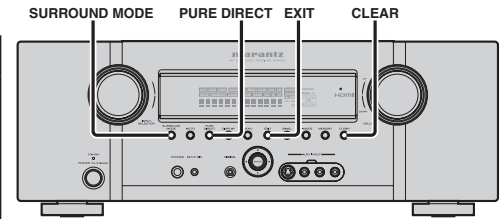

**FRONT KEY (BUTTON) LOCK OF THE UNIT**

If the **PURE DIRECT** and **EXT** buttons on the front panel are both pressed at the same time for three seconds or more, all the buttons on the front panel, (excluding the **POWER ON/OFF** button), as well as the **INPUT SELECTOR** knob and **VOLUME** knob, will become locked. "F-KEY LOCK!" will appear in the display. Release the lock by pressing the same two keys again at the same time for three seconds or more. "F-KEY UNLOCK" will appear in the display, and the keys will unlock.

**GENERAL MALFUNCTION**

If the equipment malfunctions, this may be because an electrostatic discharge or AC line interference has corrupted the information in the equipment memory circuits. Therefore:

- disconnect the plug from the AC line supply
- after waiting at least three minutes, reconnect the plug to the AC line supply
- re-attempt to operate the equipment

**Memory backup**

- In case a power outage occurs or the power cord is accidentally unplugged, this unit is equipped with a backup function to prevent memory data such as the preset memory from being erased.

**HOW TO RESET THE UNIT**

Should the operation or display seem to be abnormal, reset the unit with the following procedure. To turn on the unit, press and hold the **SURROUND MODE** and **CLEAR** buttons simultaneously for 3 seconds or more. Remember that the procedure will reset the settings of the SOURCE, Surround mode, delay time, TUNER PRESET etc., to their initial settings.



# OTHERS

## SURROUND MODE

This unit is equipped with many surround modes. These are provided to reproduce a variety of surround sound effects, according to the content of the source to be played. The available surround modes may be restricted depending on the input signal and speaker setup.

### The relation between the selected surround mode and the input signal

The surround mode is selected with the surround mode selector on this unit or the remote controller. However, the sound you hear is subject to the relationship between the selected surround mode and input signal. That relationship is as follows;

Surround Mode	Input Signal	Decoding	Output Channel					Front information display		
			L/R	C	SL/SR	SBL/SBR	SubW	Signal format indicators	Channel status	
AUTO	Dolby Surr. EX	Dolby Digital EX	○	○	○	○	○	□□ DIGITAL EX	L, C, R, SL, SR, S, LFE	
	Dolby D (5.1ch)	Dolby Digital 5.1	○	○	○	-	○	□□ DIGITAL	L, C, R, SL, SR, LFE	
	Dolby D(2ch)	Dolby Digital 2.0	○	-	-	-	-	□□ DIGITAL	L, R	
	Dolby D (2ch Surr)	Pro Logic IIx movie	○	○	○	○	○	□□ DIGITAL , □□ SURROUND	L, R, S	
	DTS-ES	DTS-ES	○	○	○	○	○	dts, ES	L, C, R, SL, SR, S, LFE	
	DTS 96/24	DTS 96/24	○	○	○	-	○	dts 96/24	L, C, R, SL, SR, LFE	
	DTS (5.1ch)	DTS 5.1	○	○	○	-	○	dts	L, C, R, SL, SR, LFE	
	Multi Ch-PCM	Multi Ch-PCM	○	○	○	-	○	PCM	L, C, R, SL, SR, LFE	
	Multi Ch-PCM 96kHz	Multi Ch-PCM 96kHz	○	○	○	-	○	PCM	L, C, R, SL, SR, LFE	
	PCM(Audio)	PCM (Stereo)	○	-	-	-	○	PCM	L, R	
	PCM 96kHz	PCM (96kHz Stereo)	○	-	-	-	○	PCM	L, R	
	HDCCD	PCM (Stereo)	○	-	-	-	○	PCM HDCCD	L, R	
	Analog	Stereo	○	-	-	-	○	ANALOG	-	
	SOURCE DIRECT PURE DIRECT	Dolby Surr. EX	Dolby Digital EX	○	○	○	○	○	□□ DIGITAL EX	L, C, R, SL, SR, S, LFE
Dolby D (5.1ch)		Dolby Digital 5.1	○	○	○	-	○	□□ DIGITAL	L, C, R, SL, SR, LFE	
Dolby D (2ch)		Dolby Digital 2.0	○	-	-	-	-	□□ DIGITAL	L, R	
Dolby D (2ch Surr)		Pro Logic IIx movie	○	○	○	-	-	□□ DIGITAL , □□ SURROUND	L, R, S	
DTS-ES		DTS-ES	○	○	○	○	○	dts, ES	L, C, R, SL, SR, S, LFE	
DTS 96/24		DTS 96/24	○	○	○	-	○	dts 96/24	L, C, R, SL, SR, LFE	
DTS (5.1ch)		DTS 5.1	○	○	○	-	○	dts	L, C, R, SL, SR, LFE	
Multi Ch-PCM		Multi Ch-PCM	○	○	○	-	○	PCM	L, C, R, SL, SR, LFE	
Multi Ch-PCM 96kHz		Multi Ch-PCM 96kHz	○	○	○	-	○	PCM	L, C, R, SL, SR, LFE	
PCM (Audio)		PCM (Stereo)	○	-	-	-	○	PCM	L, R	
PCM 96kHz		PCM (96kHz Stereo)	○	-	-	-	○	PCM	L, R	
HDCCD		PCM (Stereo)	○	-	-	-	○	PCM HDCCD	L, R	
Analog		Stereo	○	-	-	-	-	ANALOG	-	
EXES		Dolby Surr. EX	Dolby Digital EX	○	○	○	○	○	□□ DIGITAL EX	L, C, R, SL, SR, S, LFE
	Dolby D (5.1ch)	Dolby Digital EX	○	○	○	○	○	□□ DIGITAL	L, C, R, SL, SR, LFE	
	DTS-ES	DTS-ES	○	○	○	○	○	dts, ES	L, C, R, SL, SR, S, LFE	
	DTS 96/24	DTS-ES	○	○	○	○	○	dts 96/24	L, C, R, SL, SR, LFE	
	DTS(5.1ch)	DTS-ES	○	○	○	○	○	dts	L, C, R, SL, SR, LFE	
	Multi CH-PCM	Multi Ch-PCM + Dolby EX	○	○	○	○	○	PCM	L, C, R, SL, SR, LFE	
	AAC (5.1ch)	AAC EX	○	○	○	-	○	AAC	L, C, R, SL, SR, LFE	
	DOLBY (PL IIx movie) (PL IIx music) (PL IIx game) (Pro Logic)	Dolby Surr. EX	Dolby Digital 5.1	○	○	○	*	○	□□ DIGITAL EX	L, C, R, SL, SR, S, LFE
		Dolby D (5.1ch)	Dolby Digital 5.1	○	○	○	*	○	□□ DIGITAL	L, C, R, SL, SR, LFE
		Dolby D (2ch)	Pro Logic IIx	○	○	○	○	○	□□ DIGITAL	L, R
		Dolby D (2ch Surr)	Pro Logic IIx	○	○	○	○	○	□□ DIGITAL , □□ SURROUND	L, R, S
		Multi Ch-PCM	Multi Ch-PCM + PLIIx	○	○	○	○	○	PCM	L, C, R, SL, SR, LFE
		PCM (Audio)	Pro Logic IIx	○	○	○	○	○	PCM	L, R
	DTS (Neo:6 Cinema) (Neo:6 Music)	Analog	Pro Logic IIx	○	○	○	○	○	ANALOG	-
DTS-ES		DTS 5.1	○	○	○	-	○	dts, ES	L, C, R, SL, SR, S, LFE	
DTS 96/24		DTS 96/24	○	○	○	-	○	dts 96/24	L, C, R, SL, SR, LFE	
DTS (5.1ch)		DTS 5.1	○	○	○	-	○	dts	L, C, R, SL, SR, LFE	
PCM (Audio)		Neo:6	○	○	○	○	○	PCM	L, R	
Analog		Neo:6	○	○	○	○	○	ANALOG	-	
CS II Cinema CS II Music CS II Mono	Dolby D (2ch)	Neo:6	○	○	○	○	○	□□ DIGITAL	L, R	
	Dolby D (2ch Surr)	Neo:6	○	○	○	○	○	□□ DIGITAL , □□ SURROUND	L, R, S	
	PCM (Audio)	CS II	○	○	○	○	○	PCM	L, R	
	Analog	CS II	○	○	○	○	○	ANALOG	-	
	Dolby D (2ch)	CS II	○	○	○	○	○	□□ DIGITAL	L, R	
	Dolby D (2ch Surr)	CS II	○	○	○	○	○	□□ DIGITAL , □□ SURROUND	L, R, S	

Surround Mode	Input Signal	Decoding	Output Channel					Front information display		
			L/R	C	SL/SR	SBL/SBR	SubW	Signal format indicators	Channel status	
STEREO	Dolby Surr. EX	Stereo	○	-	-	-	○	□□ DIGITAL EX	L, C, R, SL, SR, S, LFE	
	Dolby D (5.1ch)	Stereo	○	-	-	-	○	□□ DIGITAL	L, C, R, SL, SR, LFE	
	Dolby D (2ch)	Stereo	○	-	-	-	○*	□□ DIGITAL	L, R	
	Dolby D (2ch Surr)	Stereo	○	-	-	-	○*	□□ DIGITAL , □□ SURROUND	L, R, S	
	DTS-ES	Stereo	○	-	-	-	○	dts, ES	L, C, R, SL, SR, S, LFE	
	DTS 96/24	Stereo	○	-	-	-	○	dts 96/24	L, C, R, SL, SR, LFE	
	DTS (5.1ch)	Stereo	○	-	-	-	○	dts	L, C, R, SL, SR, LFE	
	Multi Ch-PCM	Stereo	○	-	-	-	○	PCM	L, C, R, SL, SR, LFE	
	PCM (Audio)	Stereo	○	-	-	-	○	PCM	L, R	
	PCM 96kHz	Stereo	○	-	-	-	○	PCM	L, R	
	HDCCD	PCM (Stereo)	○	-	-	-	○	PCM HDCCD	L, R	
	Analog	Stereo	○	-	-	-	○	ANALOG	-	
	Virtual	Dolby Surr. EX	Virtual	○	-	-	-	-	□□ DIGITAL EX	L, C, R, SL, SR, S, LFE
		Dolby D (5.1ch)	Virtual	○	-	-	-	-	□□ DIGITAL	L, C, R, SL, SR, LFE
Dolby D (2ch)		Virtual	○	-	-	-	-	□□ DIGITAL	L, R	
Dolby D (2ch Surr)		Virtual	○	-	-	-	-	□□ DIGITAL , □□ SURROUND	L, R, S	
DTS-ES		Virtual	○	-	-	-	-	dts, ES	L, C, R, SL, SR, S, LFE	
DTS (5.1ch)		Virtual	○	-	-	-	-	dts	L, C, R, SL, SR, LFE	
Multi Ch-PCM		Virtual	○	-	-	-	-	PCM	L, C, R, SL, SR, LFE	
PCM (Audio)		Virtual	○	-	-	-	-	PCM	L, R	
Analog		Virtual	○	-	-	-	-	ANALOG	-	
Multi Ch. Stereo		Dolby Surr. EX	Dolby Digital EX	○	○	○	○	○	□□ DIGITAL EX	L, C, R, SL, SR, S, LFE
	Dolby D (5.1ch)	Dolby Digital 5.1	○	○	○	-	○	□□ DIGITAL	L, C, R, SL, SR, LFE	
	Dolby D (2ch)	Multi Channel Stereo	○	○	○	○	○*	□□ DIGITAL	L, R	
	Dolby D (2ch Surr)	Multi Channel Stereo	○	○	○	○	○*	□□ DIGITAL , □□ SURROUND	L, R, S	
	DTS-ES	DTS-ES	○	○	○	○	○	dts, ES	L, C, R, SL, SR, S, LFE	
	DTS 96/24	DTS 96/24	○	○	○	○	○	dts 96/24	L, C, R, SL, SR, LFE	
	DTS (5.1ch)	DTS 5.1	○	○	○	-	○	dts	L, C, R, SL, SR, LFE	
	Multi Ch-PCM	Multi Ch-PCM	○	○	○	-	○	PCM	L, C, R, SL, SR, LFE	
Multi Ch-PCM 96kHz	Multi Ch-PCM 96kHz	○	○	○	-	○	PCM	L, C, R, SL, SR, LFE		
PCM (Audio)	Multi Channel Stereo	○	○	○	○	○*	PCM	L, R		
Analog	Multi Channel Stereo	○	○	○	○	○*	ANALOG	-		

\* : Depending on the particular setup, there may be differences compared to the information contained in these tables.

○\* : When L/R (FRONT Speaker) = SMALL.

### Notes:

- Dolby Digital (2 ch: Lt/Rt): signal with Dolby Surround flag Speakers are full set.
- No sound outputs from the surround speaker, center speaker and subwoofer if the DVD disc has no surround data.

### Abbreviations

- L/R : Front speakers
- C : Center speaker
- SL/SR : Surround speakers
- SBL/SBR : Surround Back speakers
- SubW : Sub woofer speaker

**AUTO**

When this mode is selected, the unit determines whether the digital input signal is Dolby Digital, Dolby Digital Surround EX, DTS, DTS-ES, DTS 96/24 or PCM-audio.

Surround EX & DTS-ES will operate for multichannel source that has a Dolby Digital Surround EX or DTS-ES auto trigger flag in the digital signal.

When a Dolby Digital or DTS signal is input, the number of channels for which the corresponding signal is encoded will be played.

Inputting a Dolby Digital two channel signal with Dolby surround status automatically subjects that signal to Pro Logic IIx movie processing before play. PCM 96 kHz source material can be played in this mode.

**Notes:**

- When you use this mode with certain DVD and CD players, performing operations such as “Skip” or “Stop” may momentarily interrupt the output.
- When the signal is not decoded, the mode is changed to AUTO mode automatically. Refer to page 38 to confirm the available decoding mode.

**SOURCE DIRECT**

In the Source Direct mode, the tone control circuit and bass management configuration are bypassed for full-range frequency response and the purist audio reproduction.

**Notes:**

- Speaker size is set to Front L/R = LARGE, Center = LARGE, Surround L/R = LARGE and Subwoofer = YES automatically. Tone controls, equalizer and additional processing are deactivated.
- When you use this mode with certain DVD and CD players, performing operations such as skip or stop may momentarily interrupt the output.

**PURE DIRECT**

The Pure Direct mode further reduces sources of noise in addition to effect of the Source Direct mode, by blocking output from the video jacks (VIDEO, S-VIDEO, COMPONENT VIDEO and HDMI) and turning the FL display off.

**EX/ES**

This mode provides 6.1 channel surround for DOLBY DIGITAL EX, DTS-ES encoded source material such as DVD.

This mode cannot be used when an analog input has been selected.

**Dolby Digital EX**

In a movie theater, film soundtracks that have been encoded with Dolby Digital surround EX technology are able to reproduce an extra channel which has been added during the mixing of the program.

This channel, called Surround Back, places sounds behind the listener in addition to the currently available front left, front center, front right, surround right, surround left and subwoofer channels.

This additional channel provides the opportunity for more detailed imaging behind the listener and brings more depth, spacious ambience and sound localization than ever before.

Dolby Digital EX is not available in the system without surround back speaker(s).

**DTS-ES (Discrete 6.1, Matrix 6.1)**

DTS-ES adds the surround back channel audio to the DTS 5.1-channel format to improve the acoustic positioning and makes acoustic image movement more natural with the 6.1-channel reproduction.

This unit incorporates a DTS-ES decoder, which can handle DTS-ES Discrete-encoded and DTS-ES Matrix-encoded program sources from DVD, etc..

DTS-ES Discrete 6.1 features digital discrete recording of all channels including the surround back channel(s) and higher quality of audio reproduction.

DTS-ES is not available in the system without a surround back speaker.

**Dolby MODE**

**(Dolby Digital, Pro Logic IIx MOVIE, Pro Logic IIx MUSIC, Pro Logic IIx GAME, Pro Logic)**

This mode is used with source materials encoded in Dolby Digital and Dolby Surround.

**DOLBY DIGITAL**

This mode is enabled when playing source materials encoded in Dolby Digital.

Playing multichannel encoded 6.1 or 7.1-channel Dolby Digital sources provides five main audio channels (left, center, right, surround left and surround right) and Low Frequency Effect channel.

Dolby Digital EX decoding is not available in this mode.

Dolby Pro Logic IIx brings the excitement of surround sound to any stereo mix, while making existing Dolby Surround mixes sound more like discrete 5.1 channels Surround sound.

Dolby Pro Logic IIx has 3 modes. Please see below.

**Pro Logic IIx MOVIE**

This mode provides 6.1 or 7.1 channel surround sound from Dolby Surround encoded stereo movie sound tracks.

**Pro Logic IIx MUSIC**

This mode provides 6.1 or 7.1 channel surround sound from conventional stereo sources, analog or digital, such as CD, Tape, FM, TV, Stereo VCR, etc.

**Pro Logic IIx GAME**

Game mode restores the impact low-frequency surround effects by routing them to the system's subwoofer.

**Pro Logic**

This mode emulated original Dolby Pro Logic decoding (3/1 surround) suit for Dolby Surround encoded stereo movie soundtracks.

**Notes:**

- Pro Logic IIx mode will decode as Pro Logic II mode when the SURROUND BACK SPEAKER is set NONE in SPEAKER SETUP menu. (See SPEAKER SETUP, page 21)
- Pro Logic IIx mode is available for a 2ch input signal which is encoded in Dolby Digital or PCM format.
- PCM-audio signals can be subjected to Pro Logic processing when the sampling frequency is 32 kHz, 44.1 kHz or 48 kHz.

**dts MODE**

**(dts, Neo:6 Cinema, Neo:6 Music)**

This mode is for DTS encoded source materials such as LASER DISC, CD, and DVD. Neo:6 is for some 2 channel sources.

**dts** : This mode is enabled when playing source materials encoded in dts multichannel.

Playing multichannel encoded 5.1-channel dts sources provides five main audio channels (left, center, right, surround left and surround right) and Low Frequency Effect channel.

dts-ES decoding is not available in this mode.

The DTS mode cannot be used when an analog input has been selected.

**Neo:6 Cinema, Neo:6 Music**

This mode decodes 2-channel signals into 6-channel signals using high-accuracy digital matrix technology.

The DTS NEO:6 decoder has near-discrete properties in the frequency characteristics of the channels as well as in channel separation.

According to the signals to be played back, DTS NEO:6 uses either the NEO:6 CINEMA mode optimized for movie playback or the NEO:6 MUSIC mode optimized for music playback.

**Notes:**

- Neo:6 mode is available to 2ch input signals which are encoded in Dolby Digital or PCM Analog format.
- PCM-audio signals can be subjected to Neo:6 processing when the sampling frequency is 32 kHz, 44.1 kHz or 48 kHz.

## CIRCLE SURROUND II (CSII-CINEMA, CSII-MUSIC, CSII-MONO)

Circle Surround is designed to enable multichannel surround sound playback of non-encoded and multichannel encoded material.

Backward compatibility provides listeners with up to 6.1 channels of surround performance from entire collection of music and film, including broadcast, videotape and stereo recorded music.

Depending on source material, you can select **CSII-Cinema** mode, **CSII-Music** mode or **CSII-Mono** mode.

### CSII Cinema mode

This mode is suited for playing back Circle Surround-encoded and non-encoded film and television soundtracks. Cinema Mode enables 6.1-channel surround playback of 2-channel sources such as Video Cassettes, TV broadcasts, streaming media and DVDs.

### CSII Music mode

This mode is suited for playing back Circle Surround-encoded and non-encoded music. Music Mode decodes, music DVDs, radio and TV music broadcasts and CDs into enveloping 6.1-channel surround.

### CSII-Mono mode

This mode plays back monaural recordings from any source, including CDs, DVDs and TV and radio broadcasts in compelling 6.1-channel surround.

#### Notes:

- CS II mode is available for 2ch input signals which are encoded in Dolby Digital or PCM format.
- PCM-audio signals can be subjected to CS II processing when the sampling frequency is 32 kHz, 44.1 kHz or 48 kHz.

## STEREO

This mode bypasses all surround processing.

In stereo program sources, the left and right channels play normally when PCM-audio or analog stereo is input.

With Dolby Digital and DTS sources, the 5.1 multichannels are converted to two channel stereo. 96 kHz PCM source material can be played back in stereo mode.

## VIRTUAL

This mode creates a virtualized surround sound experience from a two-speaker (front L and R) playback system playing any multichannel audio source (such as found on DVDs and digital broadcasts), including Dolby Digital, Dolby Pro Logic or DTS.

## MULTI.CH.ST

This mode is used to create a wider, deeper and more natural soundstage from two channel source material. This is done by feeding the left channel signal to both left front and left surround speaker and the right channel signal to both right front and right surround speaker. Additionally, the center channel reproduces a mix of the right and left channel.

## CAUTION

### NOTE for DTS signal

- \* Connected DVD player, laserdisc player or CD player needs to support DTS digital output. You may not be able to play some DTS source signals from certain CD players and LD players even if you connect the player to this unit digitally. This is because the digital signal has been processed (such as the output level, sampling frequency or frequency response), and this unit cannot recognize the signal as DTS data.
- \* You can not listen to DTS-encoded software in a multiroom.
- \* Depending on the player used, DTS play may produce a short noise. This is not a malfunction.
- \* While signals from a DTS laserdisc or CD are playing in another surround mode, you cannot switch to digital input or from digital input to analog input from the INPUT SETUP in the MAIN MENU or by pressing the **A/D** button.
- \* The outputs for VCR 1 OUT, DSS/VCR 2 OUT, TAPE OUT, and CD-R OUT output analog audio signals only. Do not record from CDs or LDs that support DTS using these outputs. If you do, the DTS-encoded signal will be recorded as noise.

### NOTE for Dolby Digital Surround EX signal

- \* When playing Dolby Digital Surround EX-encoded software in 6.1 channels, it is required to set the EX/ES mode.
- \* Note that some of Dolby Digital Surround EX-encoded software does not contain the identification signal. In this case, set the EX/ES mode manually.

### NOTE for 96 kHz/192 kHz PCM audio

- \* The AUTO, Pure Direct, and Stereo modes can be used when playing PCM signals with a sampling frequency of 96/192 kHz (such as from DVD-Video/Audio discs).
- \* Certain DVD player models inhibit digital output. For details, refer to the player's operation manual.
- \* Some DVD discs feature copy protection. When using such disc, 96 kHz PCM signal is not output from the DVD player. For details, refer to the player's operation manual.

### NOTE for HDCD signal

- \* HDCD is effective only through digital input.
- \* You may not be able to play some HDCD source signals from certain CD players if you connect the player to this unit digitally. This is because the digital signal has been processed (such as the output level, sampling frequency or frequency response) and this unit cannot recognize the signal as HDCD data.

## DESCRIPTION



Manufactured under license under U.S. Patent #'s: 5,451,942; 5,956,674; 5,974,380; 5,978,762; 6,226,616; 6,487,535; 7,003,467; 7,212,872 & other U.S. and worldwide patents issued & pending. DTS, DTS Digital Surround, ES, and Neo:6 are registered trademarks and the DTS logos, Symbol and DTS 96/24 are trademarks of DTS, Inc. © 1996-2007 DTS, Inc. All Rights Reserved.

### • dts Digital Surround

DTS was introduced in 1994 to provide 5.1 channels of discrete digital audio into home theater systems. DTS brings you premium quality discrete multichannel digital sound to both movies and music. DTS is a multichannel sound system designed to create full range digital sound reproduction. The no compromise DTS digital process sets the standard of quality for cinema sound by delivering an exact copy of the studio master recordings to neighborhood and home theaters. Now, every moviegoer can hear the sound exactly as the moviemaker intended. DTS can be enjoyed in the home for either movies or music on of DVD's, LD's, and CD's.

### • dts Neo:6

The advantages of discrete multichannel systems over matrix are well known. But even in homes equipped for discrete multichannel, there remains a need for high-quality matrix decoding. This is because of the large library of matrix surround motion pictures available on disc and on VHS tape; and analog television broadcasts. The typical matrix decoder of today derives a center channel and a mono surround channel from two-channel matrix stereo material. It is better than a simple matrix in that it includes steering logic to improve separation, but because of its mono, band-limited surround it can be disappointing to users accustomed to discrete multichannel.

Neo:6 offers several important improvements as follow,

- Neo:6 provides up to six full-band channels of matrix decoding from stereo matrix material. Users with 6.1 and 5.1 systems will derive six and five separate channels, respectively, corresponding to the standard home-theater speaker layouts.

- Neo:6 technology allows various sound elements within a channel or channels to be steered separately, and in a way which follows naturally from the original presentation.
- Neo:6 offers a music mode to expand stereo nonmatrix recordings into the five- or six-channel layout, in a way which does not diminish the subtlety and integrity of the original stereo recording.

#### • dts Digital Surround ES

DTS-ES Extended Surround is a new multichannel digital signal format developed by Digital Theater Systems Inc. While offering high compatibility with the conventional DTS Digital Surround format, DTS-ES Extended Surround greatly improves the 360-degree surround impression and space expression thanks to further expanded surround signals. This format has been used professionally in movie theaters since 1999.

In addition to the 5.1 surround channels (FL, FR, C, SL, SR and LFE), DTS-ES Extended Surround also offers the SB (Surround Back) channel for surround playback with a total of 6.1 channels. DTS-ES Extended Surround includes two signal formats with different surround signal recording methods, as DTS-ES Discrete 6.1 and DTS-ES Matrix 6.1.

#### • dts Digital Surround 96/24

The stereo CD is a 16-bit medium with sampling at 44.1 kHz. Professional audio has been 20- or 24-bit for some time, and there is increasing interest in higher sampling rates both for recording and for delivery into the home. Greater bit depths provide extended dynamic range. Higher sampling rates allow wider frequency response and the use of anti-alias and reconstruction filters with more favorable aural characteristics.

DTS 96/24 allows for 5.1 channel sound tracks to be encoded at a rate of 96kHz/24bits on DVD-Video titles.

When DVD-video appeared, it became possible to deliver 24-bit, 96 kHz audio into the home, but only in two channels, and with serious limitations on picture. This capability has had little use.

DVD-audio allows 96/24 in six channels, but a new player is needed, and only analog outputs are provided, necessitating the use of the D/A converters and analog electronics provided in the player.

DTS 96/24 offers the following:

1. Sound quality transparent to the original 96/24 master.

2. Full backward compatibility with all existing decoders. (Existing decoders will output a 48 kHz signal)
3. No new player required: DTS 96/24 can be carried on DVD-video, or in the video zone of DVD-audio, accessible to all DVD players.
4. 96/24 5.1-channel sound with full-quality full-motion video, for music programs and motion picture soundtracks on DVD-video.



Dolby Digital identifies the use of Dolby Digital audio coding for such consumer formats as DVD and DTV. As with film sound, Dolby Digital can provide up to five full-range channels for left, center, and right screen channels, independent left and right surround channels, and a sixth (".1") channel for low-frequency effects.

Dolby Surround Pro Logic II is an improved matrix decoding technology that provides better spatiality and directionality on Dolby Surround program material; provides a convincing three-dimensional soundfield on conventional stereo music recordings; and is ideally suited to bring the surround experience to automotive sound. While conventional surround programming is fully compatible with Dolby Surround Pro Logic II decoders, soundtracks will be able to be encoded specifically to take full advantage of Pro Logic II playback, including separate left and right surround channels. (Such material is also compatible with conventional Pro Logic decoders.)

Dolby Digital EX creates six full-bandwidth output channels from 5.1-channel sources. This is done using a matrix decoder that derives three surround channels from the two in the original recording. For best results, Dolby Digital EX should be used with movies soundtracks recorded with Dolby Digital Surround EX.

#### About Dolby Pro Logic IIx

Dolby Pro Logic IIx technology delivers a natural and immersing 7.1-channel listening experience to the home theater environment. A product of Dolby's expertise in surround sound and matrix decoding technologies, Dolby Pro Logic IIx is a complete surround sound solution that maximizes the entertainment experience from stereo as well as 5.1-channel encoded sources.

Dolby Pro Logic IIx is fully compatible with Dolby Surround Pro Logic technology and can optimally decode the thousands of commercially available Dolby Surround encoded video cassettes and television programs with enhanced depth and spatiality. It can also process any high-quality stereo or Advanced Resolution 5.1-channel music content into a seamless 6.1- or 7.1-channel listening experience.



The Dolby Headphone technology provides a surround sound listening experience over headphones. When listening to multichannel content such as DVD movies over headphones, the listening experience is fundamentally different than listening to speakers. Since the headphone speaker drivers are covering the pinna of the ear, the listening experience differs greatly from traditional speaker playback. Dolby utilizes patented headphone perspective curves to solve this problem and provides a non-fatiguing, immersive, home theater listening experience. Dolby Headphone also delivers exceptional 3D audio from stereo material.

Manufactured under license from Dolby Laboratories. "Dolby", "Pro Logic", and the double-D symbol are trademarks of Dolby Laboratories.



Circle Surround II (CS-II) is a powerful and versatile multichannel technology. CS-II is designed to enable up to 6.1 multichannel surround sound playback from mono, stereo, CS encoded sources and other matrix encoded sources. In all cases the decoder extends it into 6 channels of surround audio and a LFE/subwoofer signal. The CS-II decoder creates a listening environment that places the listener "inside" music performances and dramatically improves both hi-fi audio conventional surround-encoded video material. CS-II provides composite stereo rear channels to greatly improve separation and image positioning – adding a heightened sense of realism to both audio and A/V productions.

CS-II is packed with other useful feature like dialog clarity (SRS Dialog) for movies and cinema-like bass enrichment (TruBass). CS-II can enable the dialog to become clearer and more discernable in movies and it enables the bass frequencies contained in the original programming to more closely achieve low frequencies – overcoming the low frequency limitations of the speakers by full octave.

Circle Surround II, TruSurround, SRS and  symbol are trademarks of SRS Labs, Inc. Circle Surround II, and TruSurround technology are incorporated under license from SRS Labs, Inc.



HDCD® (High Definition Compatible Digital®) is a patented process for delivering on Compact Disc the full richness and details of the original microphone feed.

HDCD encoded CDs sound better because they are encoded with 20-bits of real musical information as compared to 16-bits for all other CDs.

HDCD overcomes the limitation of the 16-bit CD format by using a sophisticated system to encode the additional four bits onto the CD while remaining completely compatible with the CD format.

When listening to HDCD recordings, you hear more dynamic range, a focused 3-D sound stage, and extremely natural vocal and musical timbre. With HDCD, you get the body, depth and emotion of the original performance not a flat, digital imitation.

HDCD system manufactured under license from Microsoft. This product is covered by one or more of the following: In the United States 5,479,168 5,638,074 5,640,161 5,808,574 5,838,274 5,854,600 5,864,311 5,872,531 and in Australia 669,114 with other patents pending.



HDMI, the  and High-Definition Multimedia Interface are trademarks or registered trademarks of HDMI Licensing LLC.

**TECHNICAL SPECIFICATIONS**

**FM TUNER SECTION**

Frequency Range ..... 87.5 – 108.0 MHz  
 Usable Sensitivity ..... IHF 1.8 µV/16.4 dBf  
 Signal to Noise Ratio ..... Mono/Stereo 75/70 dB  
 Distortion..... Mono/Stereo 0.2/0.3 %  
 Stereo Separation..... 1 kHz 45 dB  
 Alternate Channel Selectivity..... ± 400 kHz 60 dB  
 Image Rejection..... 98 MHz 70 dB  
 Tuner Output Level ..... 1 kHz, ± 75 kHz Dev 800 mV

**AM TUNER SECTION**

Frequency Range ..... 520 – 1710 kHz  
 Signal to Noise Ratio ..... 50 dB  
 Usable Sensitivity ..... Loop 400µV/m  
 Distortion..... 400Hz, 30 % Mod. 0.5 %  
 Selectivity..... ± 20 kHz 70 dB

**AUDIO SECTION**

Power Output (20 Hz – 20 kHz/THD=0.08%)  
 Front L&R ..... 8 ohms 80 W / Ch  
 Center ..... 8 ohms 80 W / Ch  
 Surround L&R ..... 8 ohms 80 W / Ch  
 Surround Back L&R ..... 8 ohms 80 W / Ch

Front L&R ..... 6 ohms 105 W / Ch  
 Center ..... 6 ohms 105 W / Ch  
 Surround L&R ..... 6 ohms 105 W / Ch  
 Surround Back L&R ..... 6 ohms 105 W / Ch

Input Sensitivity/Impedance..... 180 mV/ 47 Kohms  
 Signal to Noise Ratio(Analog Input / Pure Direct) .... 105 dB  
 Frequency Response  
 (Analog Input / Pure Direct)  
 ..... 8 Hz – 100 kHz (± 3 dB)  
 (Digital Input / 96 kHz PCM)  
 ..... 8 Hz – 45 kHz (± 3 dB)

**VIDEO**

Television Format.....NTSC  
 Input Level/Impedance ..... 1 Vp-p/75 ohms  
 Output Level/Impedance..... 1 Vp-p/75 ohms  
 Video Frequency Response ..... 5 Hz to 8 MHz (– 1 dB)  
 Video Frequency (Component) ..... 5 Hz to 80 MHz (– 1 dB)  
 S/N..... 60 dB

**GENERAL**

Power Requirement.....AC 120 V 60Hz  
 Power Consumption ..... 500 W  
 Weight ..... 25.6 lbs (11.6 kg)

**ACCESSORIES**

Remote Controller..... 1  
 AAA-size batteries ..... 2  
 FM Antenna ..... 1  
 AM Loop Antenna ..... 1  
 AC Power Cord..... 1  
 Microphone MC-10 ..... 1  
 User Guide..... 1

**DIMENSIONS**

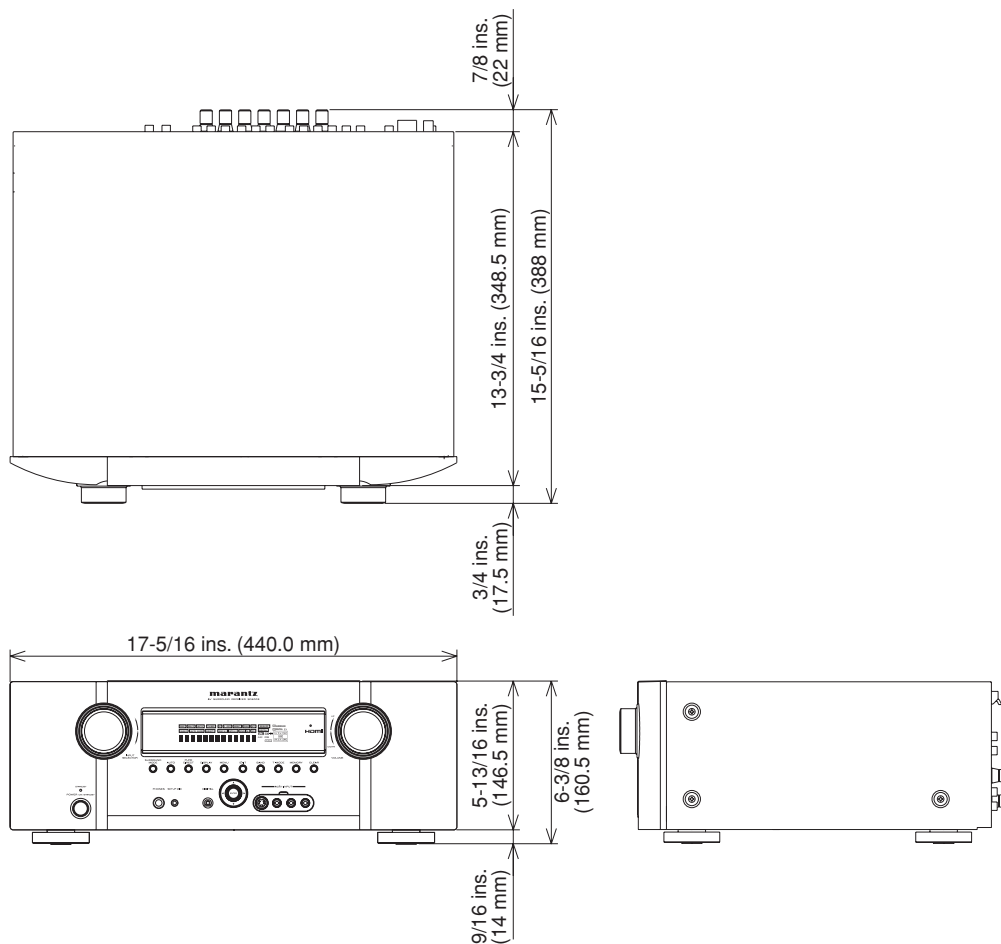

Specifications subject to change without prior notice.

**CLEANING OF EQUIPMENT EXTERNAL SURFACES**

The exterior finish of your unit will last indefinitely with proper care and cleaning. Never use scouring pads, steel wool, scouring powders or harsh chemical agents (e.g., lye solution), alcohol, thinner, benzene, insecticide or other volatile substances as these will mar the finish of the equipment. Likewise, never use cloths containing chemical substances. If the equipment get dirty, wipe the external surfaces with a soft, lint-free cloth.

If the equipment becomes heavily soiled:

- dilute some washing up liquid in water, in a ratio of one part detergent to six parts water.
- dip a soft, lint free in the solution and wring the it is damp.
- wipe the equipment with the damp cloth.
- dry the equipment by wiping it with a dry cloth.



**REPAIRS**

Only the most competent and qualified service technicians should be allowed to service the factory-trained warranty station personnel have the knowledge and special facilities needed for repair and calibration of this precision equipment. After the warranty period has expired, repairs will be performed for a charge if the equipment can be returned to normal operation.

In the event of difficulty, refer to your dealer or write directly to the nearest location to you that is listed on the Marantz Authorized Service Station list. If writing, please include the model and serial number of the equipment together with a full description of what you think is abnormal about the equipment's behaviour.

## RC004SR SETUP CODES

### TV

Acer	1141
Admiral	1002, 1009, 1089
Aiko	1059
Aiwa	1117, 1118
Akai	1001
Amtron	1023
Anam	1113
Anam National	1023, 1069, 1092
AOC	1003, 1024, 1049, 1127
Audiovox	1023
Bell & Howell	1009, 1025
Benq	1104, 1142
Broksonic	1003, 1097, 1098, 1113
Celebrity	1001
Citizen	1003, 1013, 1023 1026, 1059, 1063
Colortyme	1003, 1043
Contec	1113
Contec/Cony	1023, 1045, 1047
Craig	1020, 1022, 1023, 1113
Crown	1023, 1067
Curtis Mathes	1003, 1013, 1025 1026, 1062, 1103, 1110
Daewoo	1003, 1013, 1024, 1035 1036, 1059, 1084, 1101
Daytron	1003, 1013, 1016
Dimensia	1103, 1110
Dumont	1003, 1010, 1153
Electroband	1001
Electrohome	1001, 1003, 1069, 1133
Emerson	1003, 1013, 1015 1020, 1021, 1022, 1023 1025, 1038, 1044, 1045 1048, 1055, 1061, 1094 1096, 1099, 1101, 1113
Envision	1003
Fisher	1025, 1051, 1091, 1160
Fujitsu	1038, 1124, 1125, 1155
Funai	1023, 1038, 1113
Gateway	1150
GE	1003, 1018, 1022, 1046 1054, 1069, 1085, 1103 1110, 1113, 1133, 1136, 1153
Goldstar	1003, 1013, 1024 1030, 1045, 1080 1100, 1112, 1154
Hallmark	1003
Hisense	1116

Hitachi	1003, 1012, 1031, 1032 1037, 1041, 1045, 1047 1065, 1068, 1082, 1088 1094, 1139, 1140, 1145, 1159
Infinity	1067
Janeil	1134
JBL	1067
JC Penney	1003, 1013, 1018 1019, 1024, 1026 1046, 1047, 1054 1063, 1083, 1085 1100, 1103, 1110 1112, 1133, 1154
Jensen	1003
JVC	1028, 1029, 1045 1047, 1050, 1060, 1065
Kawasho	1001, 1003
Kenwood	1003
Kloss Novabeam	1023, 1056, 1057, 1134
KTV	1013, 1023, 1033 1034, 1073, 1099, 1113
LG	1024, 1030
M.Wards	1002, 1009, 1038
Magnavox	1003, 1052, 1053 1056, 1057, 1063 1067, 1081, 1106
Marantz	1003, 1031, 1067, 1122
Mitsubishi	1003, 1024, 1051 1115, 1122, 1133
Motorola	1014, 1069
NEC	1003, 1012, 1024, 1043, 1069
NET-TV	1137, 1150
Orion	1020, 1096
Panasonic	1017, 1067, 1069, 1095, 1111
Philips	1003, 1011, 1045, 1052 1054, 1056, 1057, 1058 1063, 1067, 1069, 1106
Pioneer	1003, 1018, 1037 1070, 1071, 1094 1145, 1147, 1149
Plasmsync	1135
Portland	1003, 1013, 1024, 1059
Price Club	1026
Prism	1018
Proscan	1004, 1005, 1006, 1007 1008, 1085, 1103, 1110
Proton	1003, 1045
Quasar	1010, 1069, 1073, 1111, 1153
Radio Shack	1003, 1013, 1015 1023, 1024, 1025, 1045 1100, 1103, 1110, 1113

RCA	1003, 1004, 1005 1006, 1007, 1008 1014, 1024, 1049, 1069 1075, 1079, 1085, 1087 1088, 1093, 1094, 1101 1103, 1110, 1113, 1153
Realistic	1013, 1015, 1023, 1025 1045, 1100, 1103, 1110
Runco	1010, 1153
Sampo	1150
Samsung	1003, 1013, 1024, 1026 1040, 1045, 1062, 1078 1083, 1090, 1100, 1105, 1114 1120, 1121, 1146, 1148, 1157
Sansui	1119
Sanyo	1003, 1025, 1051, 1072 1077, 1091, 1156, 1157, 1158
Sharp	1003, 1013, 1014 1015, 1045, 1055, 1064 1066, 1076, 1089, 1123
Signature	1009
Sony	1001, 1102, 1108
Soundesign	1003, 1023, 1038, 1063, 1113
Starlite	1023
Supre-Macy	1134
Sylvania	1003, 1039, 1042 1052, 1053, 1056, 1057 1063, 1067, 1089, 1151
Symphonic	1023, 1039, 1044
Tandy	1014
Tatung	1069
Technics	1018
Techwood	1003, 1018
Teknika	1003, 1009, 1013, 1023 1024, 1026, 1038, 1045 1047, 1059, 1063, 1111, 1113
Telecaption	1074
Toshiba	1003, 1019, 1025 1026, 1042, 1074, 1098 1107, 1111, 1135, 1136
Totevision	1013
Universal	1046, 1054
Video Concepts	1113
Viewsonic	1006, 1022, 1109 1128, 1129, 1130, 1131 1138, 1143, 1145, 1150
Wards	1003, 1009, 1015 1024, 1038, 1044, 1046 1052, 1054, 1056, 1057 1067, 1086, 1103, 1110
White Westinghouse	1001, 1101

Yamaha	1003, 1024
Zenith	1003, 1009, 1010 1132, 1144, 1153
<b>CD</b>	
AIWA	3001, 3002, 3003
AKAI	3004, 3005, 3006
AUDIO	3007
AUDIO LABS	3008
CALIFORNIA	3008
CARVER	3010, 3011, 3009
CASIO	3012, 3020
CURTIS	3020, 3012
DENON	3013
EMERSON	3014
FISHER	3011, 3015, 3016, 3017, 3018
GE	3019
GENEXXA	3014, 3021, 3020
HARMON	3022, 3023, 3051
HITACHI	3020
INKEL	3024
JC PENNEY	3012, 3020, 3025
JVC	3026, 3027
KARDON	3022, 3051, 3023
KENWOOD	3028, 3029, 3030, 3031 3032, 3033
KRELL	3010
LUXMAN	3035, 3036, 3037, 3038
LX I	3012, 3020, 3014
MAGNAVOX	3010, 3039, 3040
MARANTZ	3010, 3041, 3042, 3043
MATHES	3012, 3020
MCS	3012, 3020
MGA	3023
MISSION	3010
MINISUBISHI	3023, 3044
NAD	3034, 3045
NAKAMICHI	3046, 3047, 3048
NEC MCS	3025
NIKKO	3007, 3016
ONKYO	3049, 3050, 3051, 3052 3055, 3102, 3103
OPTIMUS	3011, 3014, 3020, 3028, 3053 3054, 3056, 3057, 3058, 3059
PANASONIC	3008, 3060, 3061
PHILIPS	3009, 3010, 3010, 3040
PIONEER	3020, 3021, 3062, 3063, 3064
QUASAR	3008
RCA	3011, 3014, 3065, 3066, 3067 3068, 3069

REALISTIC .....	3011, 3014, 3020, 3042 3054, 3057
ROTEL .....	3010
RS ORIGINAL .....	3070
SAE .....	3010, 3083
SAMSUNG .....	3071
SANSUI .....	3014, 3068, 3072, 3073
SANYO .....	3011, 3018, 3074, 3075, 3076
SCOTT .....	3014
SEARS .....	3012, 3014, 3020, 3028, 3042
SHARP .....	3028, 3042, 3077
SHERWOOD .....	3042, 3056, 3070, 3078, 3024
SHURE .....	3025
SONY .....	3039, 3079, 3080, 3081, 3082, 3097 3098, 3099, 3100, 3101
SYLVANIA.....	3010
SYMPHONIC.....	3083
TEAC.....	3016, 3042, 3057, 3083, 3084 3085, 3086
TECHNICA .....	3007, 3008, 3061, 3087, 3088
THETA DIGITAL.....	3040
TOSHIBA.....	3045
VICTOR.....	3026
YAMAHA.....	3007, 3089, 3090, 3091, 3092
ZENITH.....	3016, 3093, 3094, 3095, 3096

## DVD

Aiwa.....	2036, 2037
Apex .....	2012, 2017, 2018, 2019, 2021, 2034
BOSE.....	2038, 2039, 2063
Denon.....	2047, 2048
Funai.....	2049
GE .....	2009, 2020, 2029, 2033
Harman Kardon.....	2061
Hitachi.....	2008, 2012, 2031
JVC.....	2006, 2010, 2040 2041, 2042, 2043
Kenwood.....	2053, 2054
Koss.....	2058
Magnavox.....	2007, 2011, 2023, 2025
Marantz.....	2025
Marantz (Blu-ray).....	2064
Mitsubishi.....	2011, 2015
Onkyo .....	2062
Oritron.....	2009, 2030
Panasonic.....	2003, 2015, 2016, 2055
Philips.....	2007, 2011, 2058
Pioneer .....	2002, 2014, 2056
Proscan .....	2009, 2020, 2032
RCA.....	2005, 2009, 2020, 2035, 2057
Sampo .....	2041
Samsung .....	2008, 2012, 2022, 2024, 2027
Sanyo .....	2050, 2052
Sharp .....	2044, 2045
Sherwood .....	2051
Sony .....	2001, 2013, 2059
Toshiba.....	2004, 2008, 2026, 2028
Yamaha .....	2046, 2060
Zenith.....	2010

## DSS

Alphastar .....	4027
Amstrad.....	4046, 4047, 4050
Atsky.....	4048
B Sky B.....	4021, 4045, 4046
Chaparral.....	4039
DIRECTV.....	4001, 4016, 4044
DISH Network.....	4030
Drake.....	4026
Echostar .....	4007, 4017, 4018, 4019, 4020 4062, 4063, 4064
Eurosky.....	4047, 4056
Express Vu .....	4017
Foxtel.....	4051
Freesat .....	4056
Fujitsu.....	4025
GE .....	4002, 4008, 4009
General Instruments.....	4036, 4037
Gradiente.....	4044, 4057
Hitachi.....	4001, 4015
Hughes .....	4001, 4016
Humax .....	4049, 4050, 4051, 4052, 4053
Janeil .....	4025
JVC.....	4017
Mitsubishi.....	4001
Nokia .....	4058, 4059, 4060, 4061
Optima.....	4048
Panasonic.....	4004, 4010
Philips.....	4031, 4035, 4044, 4057
Proscan .....	4002, 4008, 4009, 4011
Radio Shack .....	4036, 4037
RCA.....	4002, 4008, 4009, 4029
Realistic.....	4040
Rural Cable.....	4036
Samsung .....	4022, 4027, 4042, 4043, 4050, 4054, 4055
Schneider .....	4041, 4043
SKY .....	4044, 4045, 4057
Skyplus.....	4048
Skysat.....	4041, 4047, 4056
Sony .....	4003, 4012, 4014, 4065, 4066, 4067
Star Choice.....	4032
Star Trak.....	4024
STS.....	4038
SuperDish.....	4028
Teac.....	4049
Thomson.....	4046, 4056
Toshiba .....	4001, 4034
Uniden .....	4005, 4006, 4013
Universum .....	4056
Video Pall .....	4025
Zenith.....	4023, 4025, 4033

**www.marantz.com**

You can find your nearest authorized distributor or dealer on our website.

**marantz**<sup>®</sup> is a registered trademark.





## Free Manuals Download Website

<http://myh66.com>

<http://usermanuals.us>

<http://www.somanuals.com>

<http://www.4manuals.cc>

<http://www.manual-lib.com>

<http://www.404manual.com>

<http://www.luxmanual.com>

<http://aubethermostatmanual.com>

Golf course search by state

<http://golfingnear.com>

Email search by domain

<http://emailbydomain.com>

Auto manuals search

<http://auto.somanuals.com>

TV manuals search

<http://tv.somanuals.com>