

PROFESSIONAL

Model PMD910 User Guide

DVD Player

marantz®

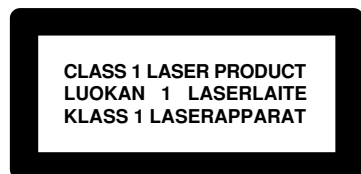

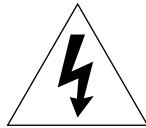
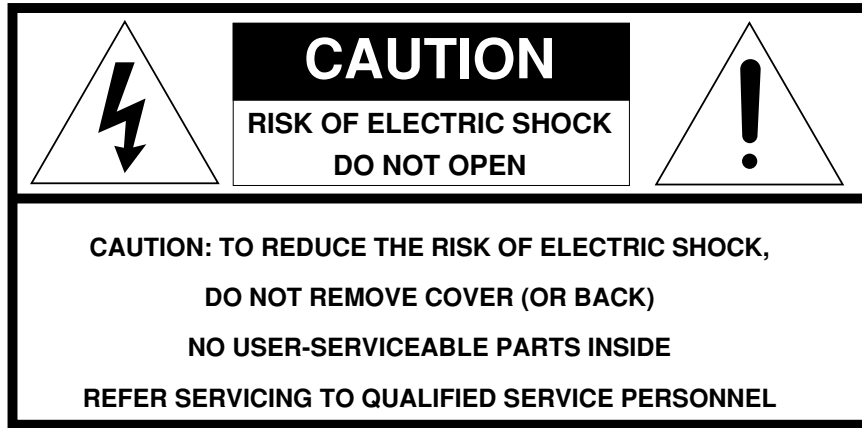

The lightning flash with arrowhead symbol within an equilateral triangle is intended to alert the user to the presence of uninsulated “dangerous voltage” within the product’s enclosure that may be of sufficient magnitude to constitute a risk of electric shock to persons.



The exclamation point within an equilateral triangle is intended to alert the user to the presence of important operating and maintenance (servicing) instructions in the literature accompanying the product.

WARNING

**TO REDUCE THE RISK OF FIRE OR ELECTRIC SHOCK,
DO NOT EXPOSE THIS PRODUCT TO RAIN OR MOISTURE.**

**CAUTION: TO PREVENT ELECTRIC SHOCK, MATCH WIDE
BLADE OF PLUG TO WIDE SLOT, FULLY INSERT.**

**ATTENTION: POUR ÉVITER LES CHOC ÉLECTRIQUES,
INTRODUIRE LA LAME LA PLUS LARGE DE LA FICHE DANS LA
BORNE CORRESPONDANTE DE LA PRISE ET POUSSER
JUSQU’AU FOND.**

NOTE TO CATV SYSTEM INSTALLER:

This reminder is provided to call the CATV (Cable-TV) system installer’s attention to Section 820-40 of the NEC which provides guidelines for proper grounding and, in particular, specifies that the cable ground shall be connected to the grounding system of the building, as close to the point of cable entry as practical.

NOTE:

This equipment has been tested and found to comply with the limits for a Class B digital device, pursuant to Part 15 of the FCC Rules. These limits are designed to provide reasonable protection against harmful interference in a residential installation. This equipment generates, uses and can radiate radio frequency energy and, if not installed and used in accordance with the instructions, may cause harmful interference to radio communications. However, there is no guarantee that interference will not occur in a particular installation. If this equipment does cause harmful interference to radio or television reception, which can be determined by tuning the equipment off and on, the user is encouraged to try to correct the interference by one or more of the following measures:

- Reorient or relocate the receiving antenna.
- Increase the separation between the equipment and receiver.
- Connect the equipment into an outlet on a circuit different from that to which the receiver is connected.
- Consult the dealer or an experienced radio/TV technician for help.

NOTE:

Changes or modifications not expressly approved by the party responsible for compliance could void the user’s authority to operate the equipment.

IMPORTANT SAFETY INSTRUCTIONS

READ BEFORE OPERATING EQUIPMENT

This product was designed and manufactured to meet strict quality and safety standards. There are, however, some installation and operation precautions which you should be particularly aware of.

1. Read Instructions – All the safety and operating instructions should be read before the product is operated.
2. Retain Instructions – The safety and operating instructions should be retained for future reference.
3. Heed Warnings – All warnings on the product and in the operating instructions should be adhered to.
4. Follow Instructions – All operating and use instructions should be followed.
5. Cleaning – Unplug this product from the wall outlet before cleaning. Do not use liquid cleaners or aerosol cleaners. Use a damp cloth for cleaning.
6. Attachments – Do not use attachments not recommended by the product manufacturer as they may cause hazards.
7. Water and Moisture – Do not use this product near water—for example, near a bath tub, wash bowl, kitchen sink, or laundry tub, in a wet basement, or near a swimming pool, and the like.
8. Accessories – Do not place this product on an unstable cart, stand, tripod, bracket, or table. The product may fall, causing serious injury to a child or adult, and serious damage to the product. Use only with a cart, stand, tripod, bracket, or table recommended by the manufacturer, or sold with the product. Any mounting of the product should follow the manufacturer's instructions, and should use a mounting accessory recommended by the manufacturer.
9. CART – A product and cart combination should be moved with care. Quick stops, excessive force, and uneven surfaces may cause the product and cart combination to overturn.



10. Ventilation – Slots and openings in the cabinet are provided for ventilation and to ensure reliable operation of the product and to protect it from overheating, and these openings must not be blocked or covered. The openings should never be blocked by placing the product on a bed, sofa, rug, or other similar surface. This product should not be placed in a built-in installation such as a bookcase or rack unless proper ventilation is provided or the manufacturer's instructions have been adhered to.
11. Power Sources – This product should be operated only from the type of power source indicated on the marking label. If you are not sure of the type of power supply to your home, consult your product dealer or local power company. For products intended to operate from battery power, or other sources, refer to the operating instructions.

12. Grounding or Polarization – This product may be equipped with a polarized alternating-current line plug (a plug having one blade wider than the other). This plug will fit into the power outlet only one way. This is a safety feature. If you are unable to insert the plug fully into the outlet, try reversing the plug. If the plug should still fail to fit, contact your electrician to replace your obsolete outlet. Do not defeat the safety purpose of the polarized plug.

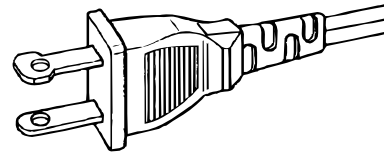

AC POLARIZED PLUG

13. Power-Cord Protection – Power-supply cords should be routed so that they are not likely to be walked on or pinched by items placed upon or against them, paying particular attention to cords at plugs, convenience receptacles, and the point where they exit from the product.
14. Protective Attachment Plug – The product is equipped with an attachment plug having overload protection. This is a safety feature. See Instruction Manual for replacement or resetting of protective device. If replacement of the plug is required, be sure the service technician has used a replacement plug specified by the manufacturer that has the same overload protection as the original plug.
15. Outdoor Antenna Grounding – If an outside antenna or cable system is connected to the product, be sure the antenna or cable system is grounded so as to provide some protection against voltage surges and built-up static charges. Article 810 of the National Electrical Code, ANSI/NFPA 70, provides information with regard to proper grounding of the mast and supporting structure, grounding of the lead-in wire to an antenna discharge unit, size of grounding conductors, location of antenna-discharge unit, connection to grounding electrodes, and requirements for the grounding electrode. See Figure 1.
16. Lightning – For added protection for this product during a lightning storm, or when it is left unattended and unused for long periods of time, unplug it from the wall outlet and disconnect the antenna or cable system. This will prevent damage to the product due to lightning and power-line surges.
17. Power Lines – An outside antenna system should not be located in the vicinity of overhead power lines or other electric light or power circuits, or where it can fall into such power lines or circuits. When installing an outside antenna system, extreme care should be taken to keep from touching such power lines or circuits as contact with them might be fatal.
18. Overloading – Do not overload wall outlets, extension cords, or integral convenience receptacles as this can result in a risk of fire or electric shock.
19. Object and Liquid Entry – Never push objects of any kind into this product through openings as they may touch dangerous voltage points or short-out parts that could result in a fire or electric shock. Never spill liquid of any kind on the product.

20. Servicing – Do not attempt to service this product yourself as opening or removing covers may expose you to dangerous voltage or other hazards. Refer all servicing to qualified service personnel.
21. Damage Requiring Service – Unplug this product from the wall outlet and refer servicing to qualified service personnel under the following conditions:
 - a. When the power-supply cord or plug is damaged.
 - b. If liquid has been spilled, or objects have fallen into the product.
 - c. If the product has been exposed to rain or water.
 - d. If the product does not operate normally by following the operating instructions. Adjust only those controls that are covered by the operating instructions as an improper adjustment of other controls may result in damage and will often require extensive work by a qualified technician to restore the product to its normal operation.
 - e. If the product has been dropped or damaged in any way, and
 - f. When the product exhibits a distinct change in performance – this indicates a need for service.
22. Replacement Parts – When replacement parts are required, be sure the service technician has used replacement parts specified by the manufacturer or have the same characteristics as the original part. Unauthorized substitutions may result in fire, electric shock, or other hazards.
23. Safety Check – Upon completion of any service or repairs to this product, ask the service technician to perform safety checks to determine that the product is in proper operating condition.
24. Wall or Ceiling Mounting – The product should be mounted to a wall or ceiling only as recommended by the manufacturer.
25. Heat – The product should be situated away from heat sources such as radiators, heat registers, stoves, or other products (including amplifiers) that produce heat.

FIGURE 1
EXAMPLE OF ANTENNA GROUNDING AS PER
NATIONAL ELECTRICAL CODE, ANSI/NFPA 70

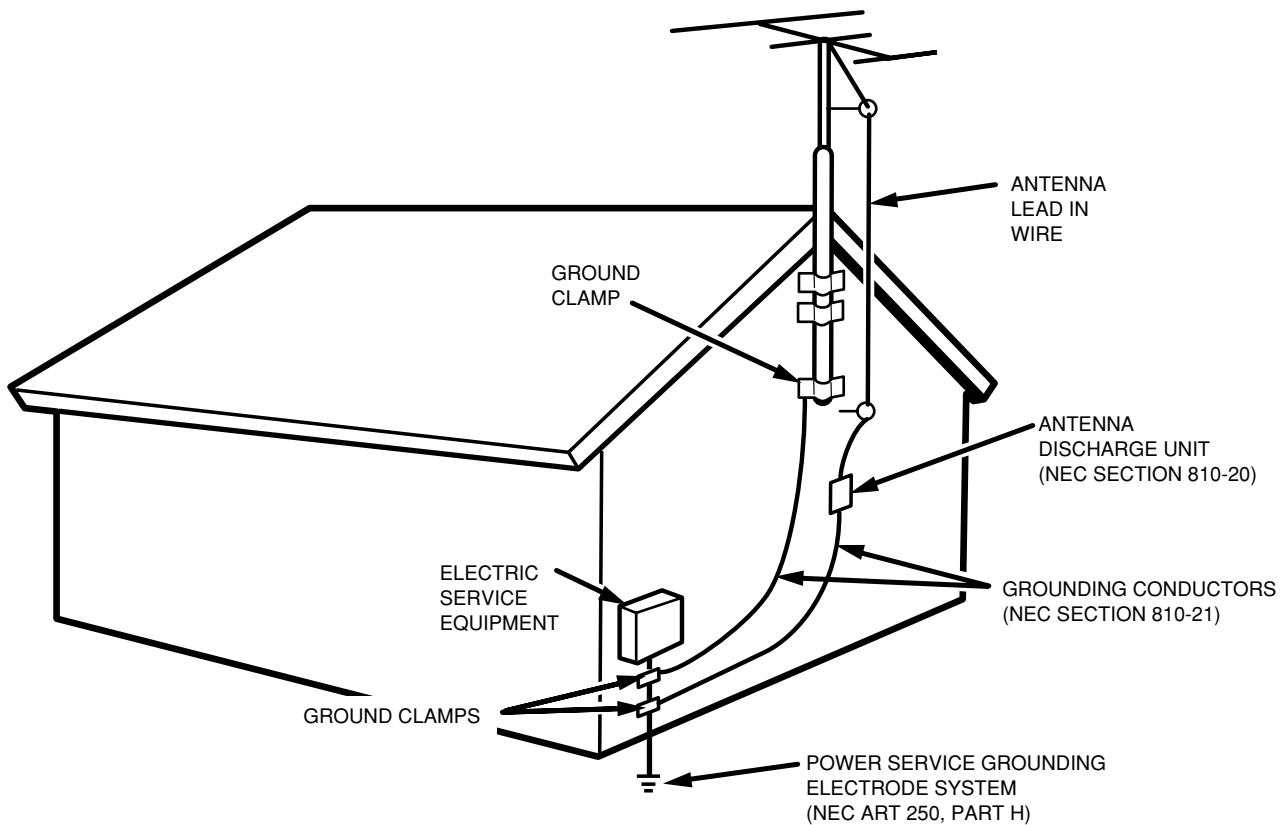

NEC - NATIONAL ELECTRICAL CODE

This Class B digital apparatus complies with Canadian ICES-003.

Cet appareil numérique de la Classe B est conforme à la norme NMB-003 du Canada.

Operating Environment

Operating environment temperature and humidity:
+5°C to +35°C (+41°F to +95°F); less than 85%RH (cooling vents not blocked) Do not install in the following locations

- Location exposed to direct sunlight or strong artificial light
- Location exposed to high humidity, or poorly ventilated location

This product is for general household purposes. Any failure due to use for other than household purposes (such as long - term use for business purposes in a restaurant or use in a car or ship) and which requires repair will be changed for even during the warranty period.

LASER SAFETY

This unit employs a laser. Only a qualified service person should remove the cover or attempt to service this device, due to possible eye injury.

USE OF CONTROLS OR ADJUSTMENTS OR PERFORMANCE OF PROCEDURES OTHER THAN THOSE SPECIFIED HEREIN MAY RESULT IN HAZARDOUS RADIATION EXPOSURE.

CAUTION VISIBLE AND INVISIBLE LASER RADIATION WHEN OPEN AVOID EXPOSURE TO BEAM (WARNING LOCATION: INSIDE ON LASER COVERSIELD)

This product incorporates copyright protection technology that is protected by method claims of certain U. S. patents and other intellectual property rights owned by Macrovision Corporation and other rights owners. Use of this copyright protection technology must be Authorized by Macrovision Corporation, and is intended for home and other limited viewing uses only unless otherwise authorized by Macrovision corporation. Reverse engineering or disassembly is prohibited.

Manufactured under license from Dolby Laboratories. "Dolby" and the double-D symbol are trademarks of Dolby Laboratories. Confidential unpublished works. © 1992-1997 Dolby Laboratories, Inc. All rights reserved.

DTS" and "DTS Digital" are trademarks of Digital Theater Systems, Inc.

CONGRATULATIONS ON YOUR PURCHASE OF THIS FINE MARANTZ PRODUCT.

MARANTZ is on the leading edge of DVD research for consumer products and this unit incorporates the latest technological developments. We are sure you will be fully satisfied with the DVD player. Thank you for your support.

Please read through these operating instructions so you will know how to operate your model properly. After you have finished reading the instructions, put them away in a safe place for future reference.

- This player is not suitable for commercial use.

TABLE OF CONTENTS

BEFORE YOU START	3	ADVANCED FUNCTION	25
What's in the box	3	3D sound effect (MP3, CDDA , Dolby Digital 2CH Stereo)	25
Putting the batteries in the remote control	3	Utilizing Repeat Function	26
Using the remote control	3	SHUFFLE (VCD with PBC off, MP3, CDDA only)	27
Discs compatible with this player	4	PROGRAM (VCD, MP3, CDDA only)	27
DVD Video regions	4	Digest (VCD, JPEG, Kodak picture CD, CDDA only)	28
MP3 compatibility information	4	MARKER (DVD, VCD WITH PBC OFF, CDDA)	29
Caution!	4	Display	29
		Zoom screen	31
BASIC CONNECTION	5	CUSTOMIZING DVD PERFORMANCE	32
S -Video Out Connection	5	Audio	32
Composite video out Connection	6	Video	33
Component video out connection (480i/480p)	6	Other	35
Analog Audio Connection	7	Languages (DVD only)	35
Digital Audio Connection	8	Parental Lock (DVD only)	36
System Control Connection	9	ADDITIONAL INFORMATION	37
CONTROLS & DISPLAY	10	Handling discs	37
Front Panel	10	Cleaning the pickup lens	37
Display	11	Problems with condensation	37
Rear Panel	12	Hints on installation	38
Remote Controller Unit	13	Moving the player	38
BASIC FUNCTION	16	Power cord caution	38
Open / Close Disc Tray	16	Resetting the player	38
Basic play of DVD, VIDEO-CD or CDDA	17	Malfunctioning of this unit	38
Basic play of MP3	18	Glossary	39
Selecting VIDEO MODE	18	TROUBLESHOOTING	40
Selecting MENU ITEMS (DVD or Video CD with PBC only)	19	SPECIFICATIONS	42
STOP and POWER OFF	19		
SEARCH	20		
SKIP	21		
SLOW	21		
Selecting Audio Languages (DVD only)	22		
Selecting Subtitles (DVD only)	23		
Selecting Angles (DVD only)	23		
Kodak picture CD play	24		
JPEG file play	24		

BEFORE YOU START

What's in the box

Thank you for buying this MARANTZ product. Please confirm that the following accessories are in the box when you open it.

- Remote control
- AAA/R03 dry cell batteries x2
- Audio/Video cable
- System control cable
- Operating instruction (this manual)
- Warranty card

Putting the batteries in the remote control

- 1 Open the battery compartment cover on the back of the remote control.

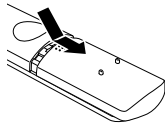

- 2 Insert two AAA/R03 batteries into the battery compartment following the indications (+, -) inside the compartment.

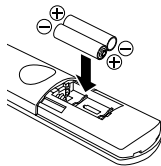

- 3 Close the cover.

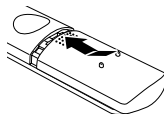

Note

Incorrect use of batteries can result in hazards such as leakage and bursting. Please observe the following:

- Don't mix new and old batteries together.
- Don't use different kinds of battery together—although they may look similar, different batteries may have different voltages.
- Make sure that the plus and minus ends of each battery match the indications in the battery compartment.
- Remove batteries from equipment that isn't going to be used for a month or more.

When disposing of used batteries, please comply with governmental regulations or environmental public instruction's rules that apply in your country or area.

Using the remote control

Keep in mind the following when using the remote control:

- Make sure that there are no obstacles between the remote and the remote sensor on the unit.
- Use within the operating range and angle, as shown.

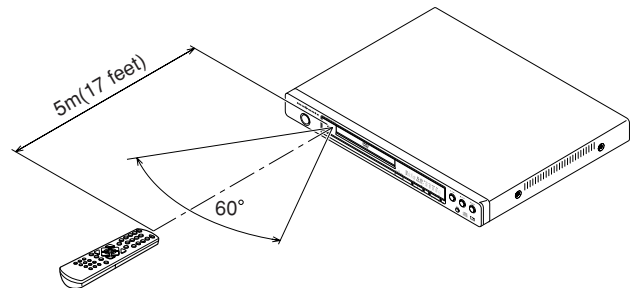

- Remote operation may become unreliable if strong sunlight or fluorescent light is shining on the unit's remote sensor.
- Remote controllers for different devices can interfere with each other. Avoid using remotes for other equipment located close to this unit.
- Replace the batteries when you notice a fall off in the operating range of the remote.

Note

When using this player independently, set a **REMOTE CONTROL** switch on the rear panel to **INTERNAL**. (page 9)

Discs compatible with this player

Any disc that displays one of the following logos should play in this player. Other formats, including DVD-RAM, DVD-ROM, CD-ROM (except those that contain MP3 files), and Photo CD will not play.

DVD Video compatibility:

- Logos: 
- Single-sided or double-sided discs
- Single layer or dual layer discs
- Dolby Digital, DTS (Digital out only), MPEG or Linear PCM digital audio
- MPEG-2 digital video

Discs are generally divided into one or more titles. Titles may be further subdivided into chapters.

DVD-R compatibility:

This unit can play DVD-R discs. Please note the following points when using these discs:

- Logo: 
- This unit can play DVD-R discs recorded as DVD video format.

Audio CD compatibility:

- Logos: 
- 12cm or 8cm discs
- Linear PCM digital audio
- CD-Audio, CD-R* and CD-RW* formats

CDs are divided into tracks.

*This unit can play CD-R and CD-RW discs recorded in CD Audio or Video CD format, or with MP3 audio files, or Kodak picture CD files.

Video CD compatibility:

- Logo: 
- 12cm or 8cm discs
- MPEG-1 digital audio
- MPEG-1 digital video

Video CDs are divided into tracks.

Super VCD compatibility:

- Logo: 
- 12cm (5in.) or 8cm (3in.) discs
- MPEG-1 digital audio
- MPEG-2 digital video

Super VCDs are divided into tracks.

DVD Video regions



All DVD Video discs carry a region mark on the case somewhere that indicates which region(s) of the world the disc is compatible with. Your DVD player also has a region mark, which you can find on the rear panel. Discs from incompatible regions will not play in this player. Discs marked ALL will play in any player.

MP3 compatibility information

- The CD-ROM must be ISO 9660 compatible.
- Mono or stereo MPEG-1 Audio Layer 3 format, 32 or 44.1 or 48kHz, fixed bit-rate. Incompatible files will not play.
- Not compatible with variable bit-rate (VBR) files.
- This player only plays tracks that are named with the file extension ".mp3" or ".MP3".
- This player is compatible with multi-session discs.
- Use CD-R or CD-RW media for recording your MP3 files. The disc must be finalized in order to play.
- Audio encoded at 128Kbps should sound close to regular audio CD quality. Although this player will play 56 to 256k bit-rate MP3 tracks, the sound quality becomes noticeably worse at lower bit-rates.
- This player can recognize a maximum of 126 folders and 255 tracks.

Caution!

- DVD-R and CD-R/RW discs recorded using a personal computer or a DVD or CD recorder may not play if the disc is damaged or dirty, or if there is dirt or condensation on the player's lens.
- If you record a disc using a personal computer, even if it is recorded in a compatible format, there are cases in which it may not play because of the settings of the application software used to create the disc. (Check with the software publisher for more detailed information.)
- Unfinalized DVD-R discs cannot be played.
- Unfinalized CD-R/RW discs can be played, but not all time information (playing time, etc.) will be displayed.
- For more information on using DVD-R and CD-R/RW discs, see Handling discs starting on page 37.

BASIC CONNECTION

- First of all, read through the instructions before connecting other equipment. Make sure that this unit and other equipment to be connected are set to the standby mode or off, and disconnect the AC mains before starting connection. In order for air to circulate freely, please do not block ventilation holes of any of the equipment. Select the appropriate screen size at the initial setting according to your TV set, conventional 4:3 or wide screen 16:9.

• TV MODE SETTING

Setup Menu / Video		Video Output		
Progressive	Output mode	Video Jack	S-Video Jack	Component Jack
OFF	YCbCr	Composite	–	Interlace mode (480i)
ON	YCbCr	–	–	Progressive mode (480p)
OFF	S-Video	Composite	S-Video	–

Note

- Do not connect your DVD-player via your VCR, because the video quality could be distorted by the copy protected system.

S -VIDEO OUT CONNECTION

Note

From the SETUP menu display, set the OUTPUT MODE to S-VIDEO.

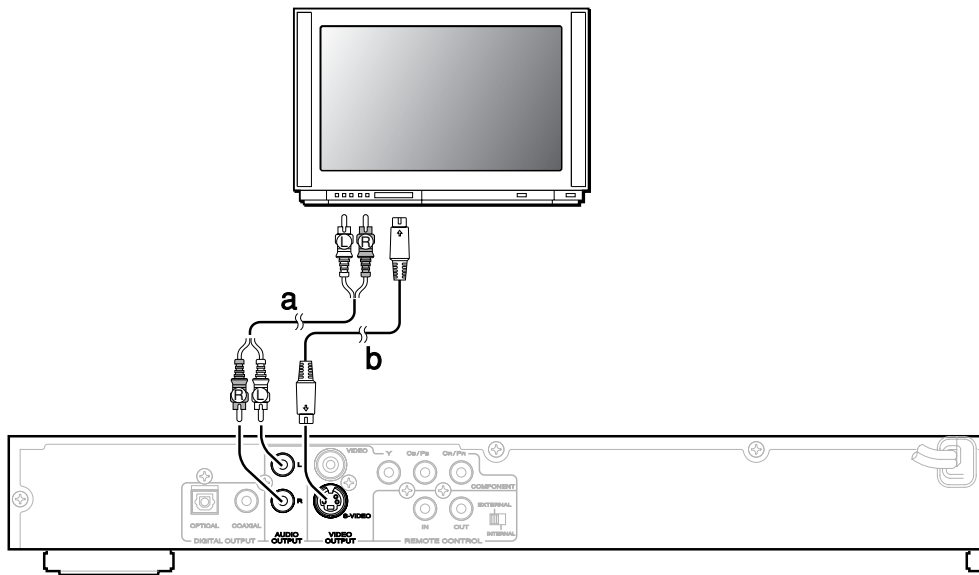

a. audio cable (optional)
To audio input connectors on TV. (red, white)

b. S-Video cable (optional)
To S-Video input connector on TV.

Composite video out Connection

Note

From the SETUP menu display, set the Progressive to OFF.

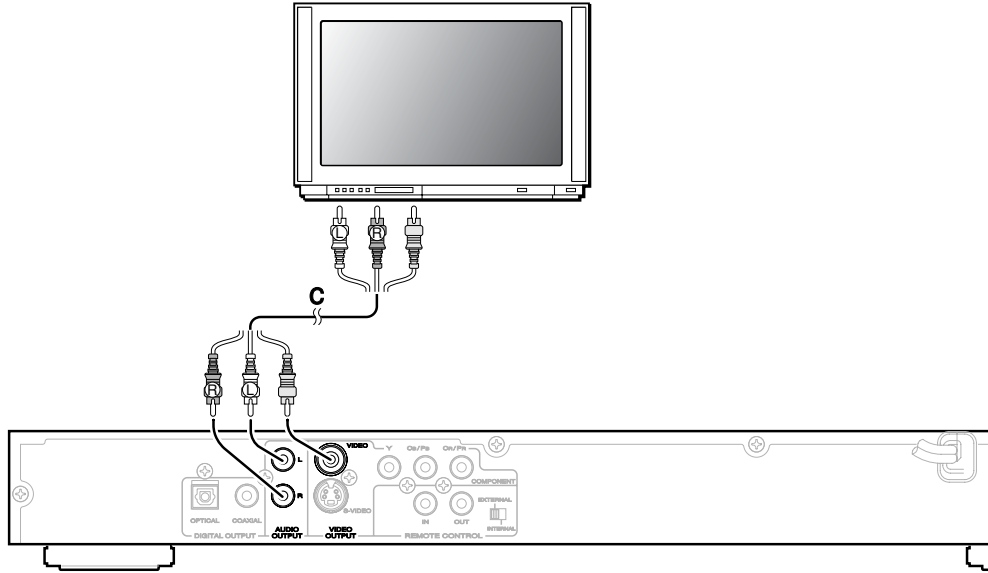

- C. Video/audio cable (accessory)**
 To audio input connectors on TV. (red, white)
 To video input connector on TV. (yellow)

Component video out connection (480i/480p)

Note

- If your TV has progressive (480p) video input, from the SETUP menu display, set the progressive mode to ON and also set the output mode to YCbCr.
- If your TV has interlace (480i) video input, from the SETUP menu display, set the progressive mode to OFF and also set the output mode to YCbCr.
- All HD TV are compatible with this player but some TV may cause artifacts in the picture.
- If you set progressive mode to ON [progressive scan mode], you can't see the picture with your Analog TV or some digital TV. In this case, press stop button for 5 seconds of your remote controller then you can see the picture on the interlace mode with your TV.

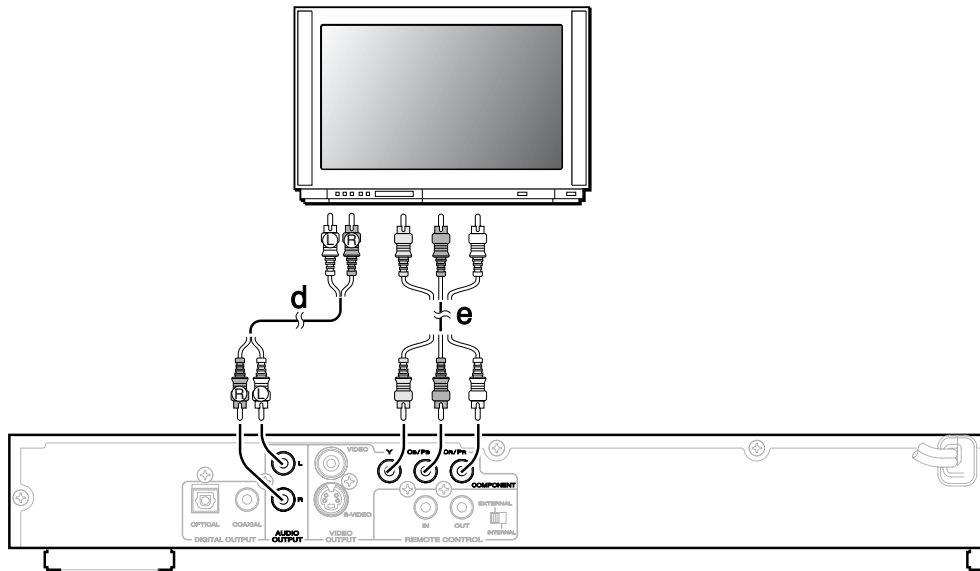

- d. Audio cable (optional)**
 To audio input connectors on TV. (red, white)

- e. Component-Video cable (optional)**
 To Component video input connectors on TV.

Analog Audio Connection

Note

- Make analog audio connections to a stereo amplifier or receiver.
- Analog audio connections can also be made to a TV or monitor with stereo input jacks.
- When playing DTS-encoded discs, excessive noise may be output from the Analog Audio out jack. This is not a malfunction.

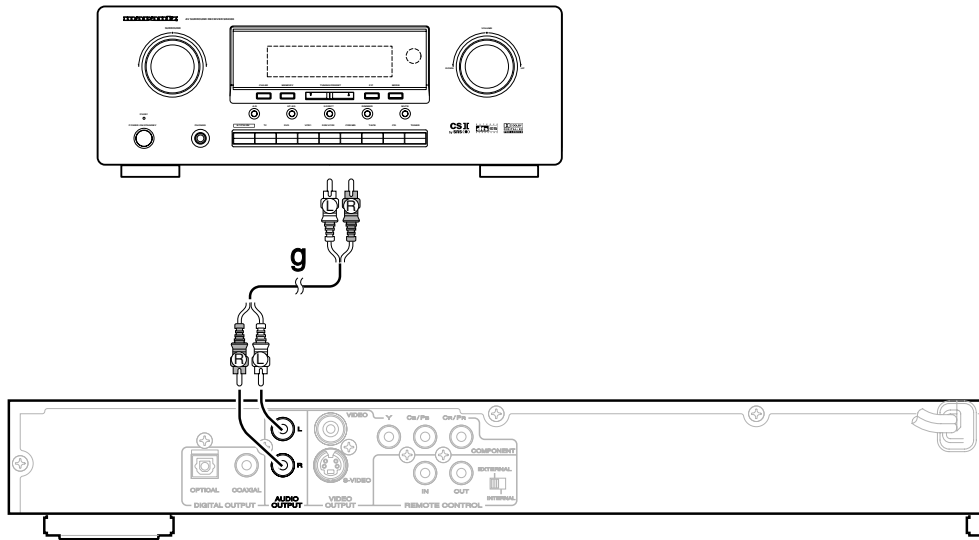

g. Audio cable (optional)
To audio input connectors on AV amplifier or receiver.

Digital Audio Connection

Note

- When a recorded in a Dolby Digital or DTS is loaded, noise will be output if you have made connections via the digital audio jacks to a receiver or amplifier that cannot decode a Dolby Digital or DTS digital bitstream. In this case, be sure to set up the SETUP, Audio setting; Digital out to PCM or OFF.

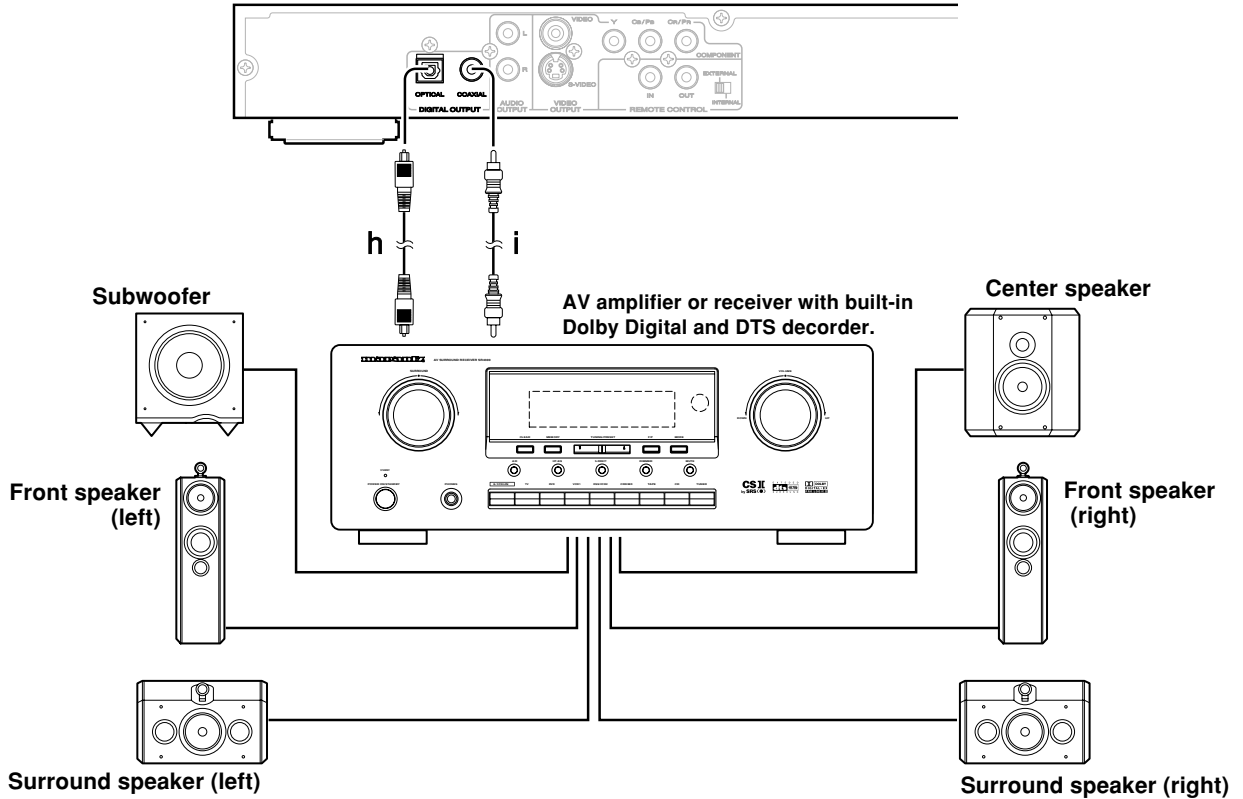

h, i. Optical (h) or coaxial (i) audio cable (optional)
To optical or coaxial digital input connectors on AV amplifier or receiver.

• **DIGITAL OUT SETTING**

SETUP menu Digital Out	DISC	DIGITAL OUT
OFF	Dolby Digital	—
	DTS	—
	PCM	—
	MPEG 2	—
BTSTREAM	Dolby Digital	Dolby Digital
	DTS	DTS
	PCM	PCM
	MPEG 2	MPEG 2
PCM	Dolby Digital	PCM
	DTS	DTS
	PCM	PCM
	MPEG 2	PCM

System Control Connection

By connecting this DVD player to another Marantz audio component using a supplied System Control cable, you can remotely operate the components as a single system.

- When connecting to component with a remote sensor, be sure to connect the REMOTE CONTROL IN jack of this DVD player to the REMOTE CONTROL OUT jack of the component with the remote sensor.
- When connecting to component which is not equipped with a remote sensor, be sure to connect the component to the REMOTE CONTROL OUT jack of this DVD player.

Remote switch

- When using this DVD player independently, set this switch to INTERNAL. When using this DVD player in a system with a Marantz receiver equipped with a remote sensor, set the switch to EXTERNAL.

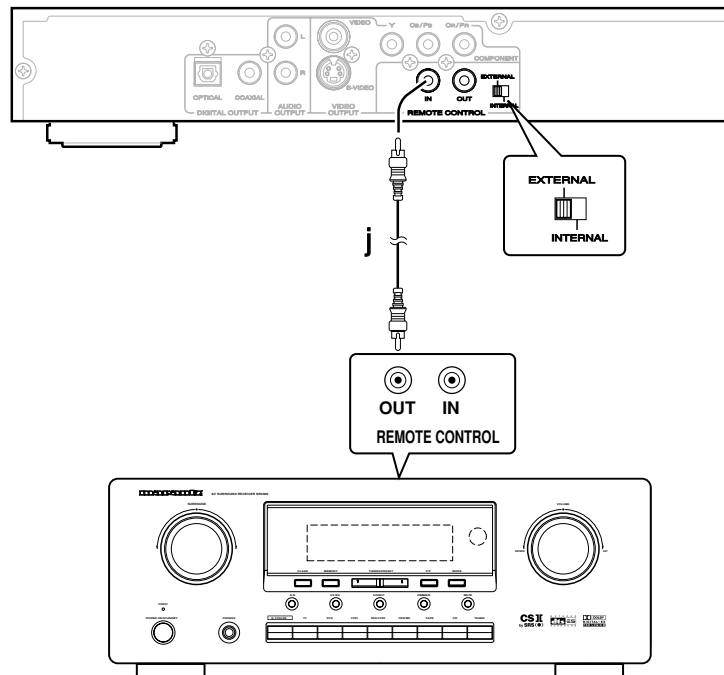

- j. System control cable (optional)**
To remote control output connector on AV amplifier or receiver.

CONTROLS & DISPLAY

Front Panel

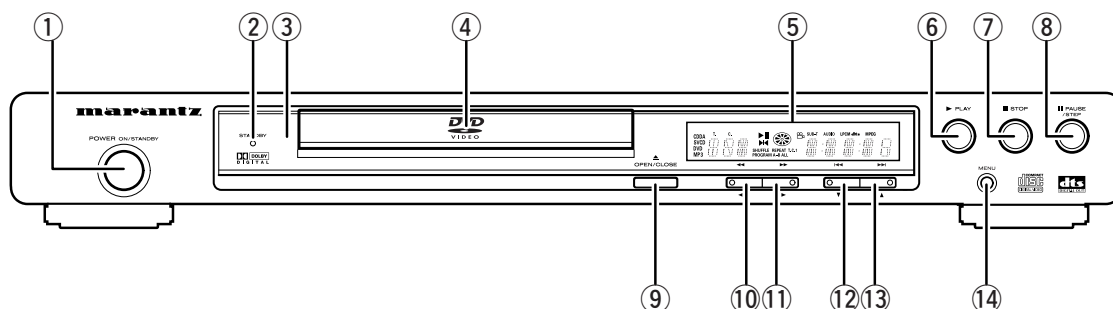

① POWER (STANDBY/ON) button

To switch the unit On or into STAND BY when connected to AC power outlet.

② STAND BY indicator

Lights when Power is STAND BY mode.

③ REMOTE SENSOR

Receives a light signal from the remote controller.

④ DISC TRAY

To load or unload a disc. Put a disc to be played on here.

⑤ FL DISPLAY

Displays operation status (Refer to Page11 FL Display).

⑥ PLAY button

To play the loaded disc. Press this button to go to the preferred item when the menu is displayed on the TV screen.

⑦ STOP button

To stop playing. If using a Video CD 2.0, SVCD or CVD with PBC, this button works as a RETURN function to move to the previous menu.

⑧ PAUSE/STEP button

Used to view one frame at a time during play. When you continue pressing this button, it will function continuously. Press PLAY button for normal play.

⑨ OPEN/CLOSE button

To open or close the disc tray.

⑩ FR (Fast Reverse) button

To play the disc fast reverse. It can also be used as a Slow Reverse button when in pause or step mode, and also a left arrow(◀) button when in menu mode.

⑪ FF (Fast Forward) button

To play the disc fast forward. It can also be used as a Slow Forward button when in pause or step mode, and also a right arrow(▶) button when in menu mode.

⑫ PREV button

To skip back from the current chapter (for DVD) or track (for VCD or CD). When in menu mode, this button also works as a down arrow(▼) button. If playing a Video CD with PBC, this button works as the PREV button to move to the previous play list.

⑬ NEXT button

To skip forward to the next chapter (for DVD) or track (for VCD or CD). When in menu mode, this button also works as an up arrow(▲) button. If playing a Video CD with PBC, this button works as the NEXT button to move to the next play list.

⑭ MENU button

To view the general information for the current loaded disc such as language selection, audio output selection and subtitle language selection and so on.

Display

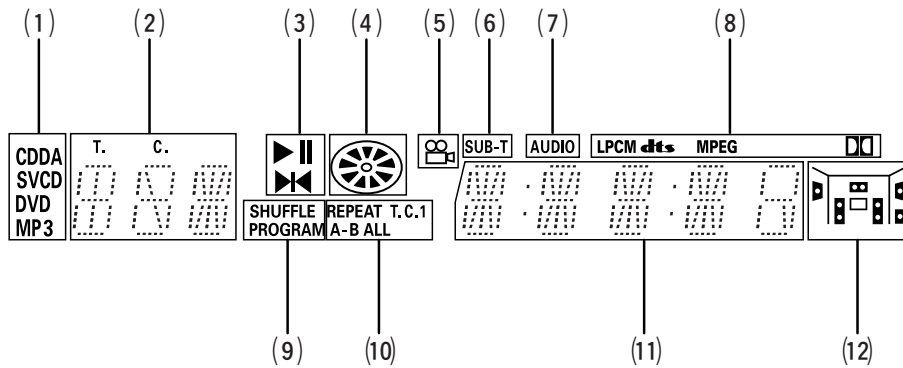

(1) **CDDA/SVCD/DVD/MP3**

Illuminates the type of a disc loaded on disc tray.

(2) **TITLE/CHAPTER**

Illuminates the information of the TITLE or CHAPTER of the DVD disc under play.

(3) **PLAY/PAUSE/STEP**

Illuminates the current operation mode.

(4) **ROTATION**

Rotates when the disc is spinning.

(5) **ANGLE**

Indicates the current disc being played is viewed as multi angle. This function only works for discs having scenes recorded at different angles.

(6) **SUB-T**

Indicates the current disc under play has multi subtitle. This function only works for discs having recordings with multiple subtitle languages.

(7) **AUDIO**

Indicates the current disc under play has multi audio soundtrack languages. This function only works for discs having recordings in multiple audio soundtrack languages.

(8) **DTS, LPCM, MPEG, []**

Indicates the audio type of the disc under play is DTS, LPCM, MPEG or [].

(9) **SHUFFLE/PROGRAM**

Illuminates under shuffle/program mode. (Video CD with PBC off or CDDA only)

(10) **REPEAT T, C, 1, A-B, ALL**

Illuminates when the current play mode is under repeat title, chapter, track (single), A-B, disc (all) respectively.

(11) **TIME**

Indicates time information and sometimes system information like STOP, MENU and so on.

(12) **L, C, R, LFE, LS, S, RS**

Indicates the audio channel information of the disc under play. For DVD discs having the Dolby Digital audio.

Rear Panel

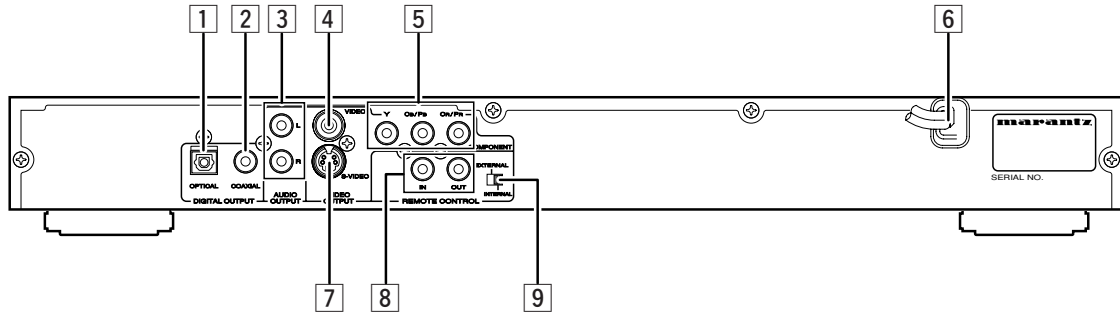
**1 DIGITAL OUT (OPTICAL)**

Connects digital audio under play mode into an AV amplifier or a receiver equipped with digital audio decoder for you to enjoy the theatre-quality sound in your home.

Note

- Remove the dust protection cap from the optical digital audio output connector and connect the cable firmly so that the configurations of both the cable and connector match.
- Do not connect to the digital audio input of an amplifier that does not have Dolby Digital and dts decoder when you set the digital out option of setup information to BITSTREAM.

2 DIGITAL OUT (COAXIAL)

Connects digital audio under play mode into an AV amplifier or a receiver equipped with digital audio decoder for you to enjoy the theatre-quality sound in your home.

3 AUDIO OUT

Analogue 2 channel (L/R) audio output in order to connect to a TV or stereo amplifier.

4 VIDEO OUT

Connects composite video signal to Composite Video input connector of TV or monitor to achieve high fidelity colour reproduction.

5 COMPONENT VIDEO OUT (480i or 480p)

Connects component video signal to component video input connector on TV, if your TV supports interlace video input (480i) or Progressive video input (480p).

6 AC in power cord connection terminal

Creates POWER between wall outlet and the unit.

7 S-VIDEO OUT

Connects to TV or monitor equipped with S-VIDEO input. In order to achieve a sharper and cleaner picture than that when connected via VIDEO OUT (composite video).

8 System Control in / out jack

Connect this DVD player to another Marantz Component, to operate the components as a single system (page 9).

9 System Control external / internal switch

When using this DVD player independently, set this switch to "INTERNAL" (page 9).

Remote Controller Unit

Numbers for each button on the remote control unit will be indicated in parenthesis mark starting from the next page.

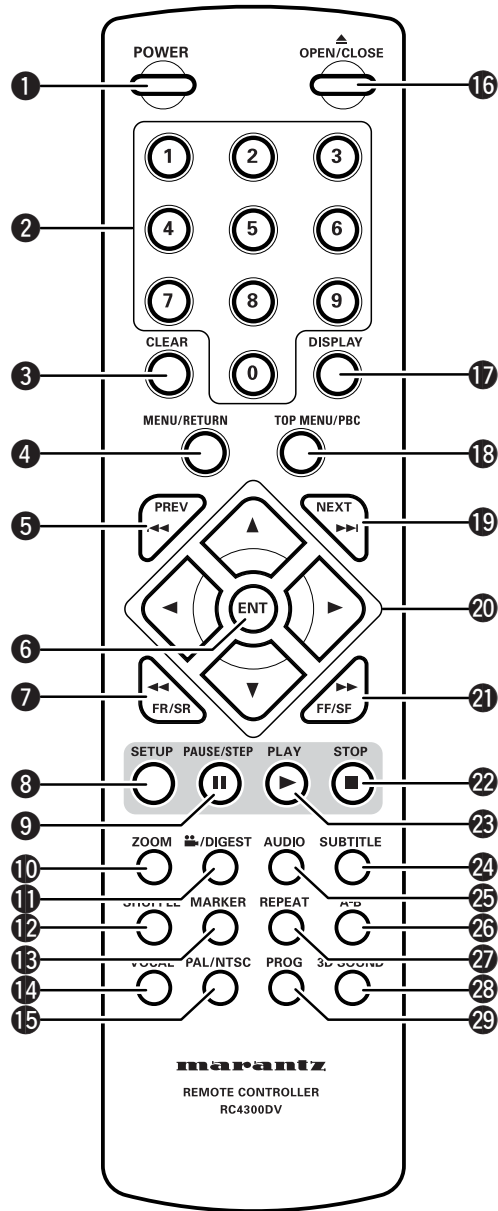

- ① POWER
- ② NUMERIC BUTTONS (1-9, 0)
- ③ CLEAR
- ④ MENU/RETURN
- ⑤ PREV
- ⑥ ENT (ENTER)
- ⑦ FR/SR
- ⑧ SETUP
- ⑨ PAUSE/STEP
- ⑩ ZOOM
- ⑪  (ANGLE) / DIGEST
- ⑫ SHUFFLE
- ⑬ MARKER
- ⑭ VOCAL
- ⑮ PAL/NTSC
- ⑯ OPEN/CLOSE
- ⑰ DISPLAY
- ⑱ TOP MENU/PBC
- ⑲ NEXT
- ⑳ ARROW (Left, Right, Up, Down)
- ㉑ FF/SF
- ㉒ STOP
- ㉓ PLAY
- ㉔ SUBTITLE
- ㉕ AUDIO
- ㉖ A-B
- ㉗ REPEAT
- ㉘ 3D SOUND
- ㉙ PROG (PROGRAM)

1. General Function for Remote Control Unit

1. POWER ❶

Activates the unit POWER ON or into STANDBY.

2. OPEN/CLOSE ❷

After pressing power button, press OPEN/CLOSE button to open or close the disc tray. If pressed under STANDBY, power is automatically turned on and the tray is opened.

3. NUMERIC ❸

Used from the menu to select, title/chapter search, time search and direct track number.

4. CLEAR ❹

Used when discarding wrong number input, returning to normal play during slow or search. This button can also be used when clearing zoom state.

5. PAL/NTSC ❺

Set up TV type according to type supported by user's TV.

2. Basic Function

1. PLAY button ❶, ▶

Use this button to play.

2. STOP button ❷, ■

To stop the current playing mode, press STOP button. Press the stop key for 5 seconds to convert progressive scan mode into interlace mode.

3. PAUSE / STEP button ❸, ||

Use this button to play one frame at a time. To do step backward, press this button during reverse operation i.e. fast reverse or slow reverse.

4. FF/SF ❹, ▶▶

To play a disc fast forward or slow forward. During pause or step state, this button works as Slow Forward. (Page 21)

5. FR/SR ❺, ◀◀

To play a disc fast reverse or slow reverse. During pause or step state, this button works as Slow Reverse. (Page 21)

6. NEXT ❻, ▶▶

Used to move to the next chapter (DVD) or track (VCD or CDDA) from the current chapter or track. Pressing this button shows next play list when playing VCD with PBC. (Page 21)

7. PREV ❼, ◀◀

Used to move to the previous chapter (DVD) or track (VCD or CDDA) from the current chapter or track. Pressing this button shows previous play list when playing VCD with PBC. (Page 21)

3. Advanced Functions

1. REPEAT ❶ (Except VCD with PBC on)

To set up the repeat viewing during play. Two repeat modes are possible. When using a DVD, "CHAPTER REPEAT ON" repeats the current chapter and "TITLE REPEAT ON" repeats all chapters in the current title.

When using a VCD with PBC off or CDDA, "REPEAT ONE" repeats the current track and "REPEAT ALL" repeats all tracks on the disc. To clear the repeat function, press this button until you see REPEAT OFF on the TV screen. Turn off PBC to use this function on VCD with PBC included. (Page 26)

2. A-B ❷ (Except MP3)

To repeat the selected segment. The moment you press this button during play, the starting point for the desired segment is selected. When you press this button again, the ending point is selected and starts repeated play of the selected segment automatically. Press this button again to cancel the repeating of the selected segment. (Page 25)

3. PROG (PROGRAM ❸ (VCD with PBC off and CDDA only))

Use this button to play the tracks, which you want to watch. You can program desired tracks up to the total programmed time of 99 minutes. Turn off PBC to use this function on VCD with PBC included. (Page 27)

4. SHUFFLE ❹ (VCD with PBC off and CDDA only)

Use this button to play the loaded disc in a random order. Turn off PBC to use this function on VCD with PBC included. (Page 27)

5. DIGEST ❶ (VCD with PBC off and CDDA only)

Use this button to do quick search or preview the disc contents. This function shows thumbnail contents of the loaded disc. Turn off PBC to use this function on VCD with PBC included. (Page 28)

6. ZOOM ❷ (Except CDDA and MP3)

Enlarges DVD or VCD screen images up to eight times. You may also move the image using left, right, up and down arrow button ❸. (Page 31)

7. MARKER ❸ (Except MP3)

Stores playing point up to five locations for the easy search, when you want to move to the stored playing point. (Page 29)

8. DISPLAY ❹ (Except MP3)

This button has multiple functions. Supports search of a chapter/title for DVD or a track for VCD and CDDA. Also shows information for elapsed or remaining time. On DVD, you may see bit rate meter. (Page 29)

9. 3D SOUND ❺ (CDDA and MP3 only)

Adds 3D surround effect to analogue audio output. There are 4 surround modes. (Page 25)

10. PBC ❻ (VCD with PBC only)

You may turn on or off the PBC function by pressing this button. When the VCD with PBC is loaded, PBC function is enabled automatically. Video CD 2.0, SVCD and CVD are PBC controllable.

11. VOCAL ❷

If the disc is a Dolby Digital Karaoke disc, the following modes are available:

No vocal / Left vocal / Right vocal / Both vocal / Mixed vocal
"Mixed vocal" means sending (Left vocal + Right vocal) / 2 to both left and right speaker.

4. DVD Function

1. TOP MENU

Used to display the title menu of the loaded DVD disc. This function is disc dependent. A DVD disc may not contain the title menu. (Page 19)

2. MENU

Used to display the contents menu of the loaded DVD disc. This function is disc dependent. A DVD disc may not contain a contents menu. (Page 19)

3. (ANGLE)

Used to select a different angle when the loaded DVD disc supports multiple angles. This function is a disc dependent. Many DVD discs don't support multiple angles. (Page 23)

4. SUBTITLE

Used to change the subtitle language to a different language or off from the one selected at the initial settings, when the loaded disc supports multiple languages. (Page 23)

5. AUDIO

Used to change the audio language to a different language from the one selected at the initial settings, when the loaded disc supports multiple audio languages. (Page 22)

5. SETUP Function

1. ARROW ,



Used to move to the desired menu and moves the image center of an enlarged screen in zoom mode. Also can be used in marker or display function.

2. ENT(ENTER)

Used to select the menu item. When pressed during STOP, PAUSE, STEP, SEARCH or SLOW state, it also cancels the current state and converts to PLAY mode.

3. SETUP

Sets up the various operation information of this unit to customize DVD performance. (Page 32)

- This remote control supports two remote control codes: DVD1 and DVD2.
- When the unit is shipped from the factory, the remote control is set to DVD1.
- To set the remote control to DVD2, hold down both the "■ (Stop)" button and the "2" number button on the remote control for at least five seconds. (If the batteries in the remote control are replaced while the remote control is set to DVD2, the setting will revert to DVD1.)
- To set the remote control back to DVD1, hold down both the "■ (Stop)" button and the "1" number button on the remote control for at least five seconds.
- To check which remote control code is set at STOP mode, hold down both the Stop and PAUSE buttons; the current setting (either "DVD1" or "DVD2") will be displayed in the display window on the main unit.
- Also set the REMOT CODE on the main unit to the same setting as the remote control.
Press SETUP button for longer than five seconds in stop mode.
Use the Up/Down button ( / ) to select the type of REMOTE CODE (DVD1/DVD2), and press ENTER you want to set.
To exit the REMOTE CODE setting, press SETUP.
(This setting is set to DVD1 when the unit is shipped from the factory.)

BASIC FUNCTION

Open / Close Disc Tray

1. Connect to AC power

When AC power is connected, the STAND-BY INDICATOR on the front panel is turned on.

2. Press POWER button

When the POWER button is pressed, the STAND-BY INDICATOR turns off. TV or monitor screen shows the initial pictures as shown below.

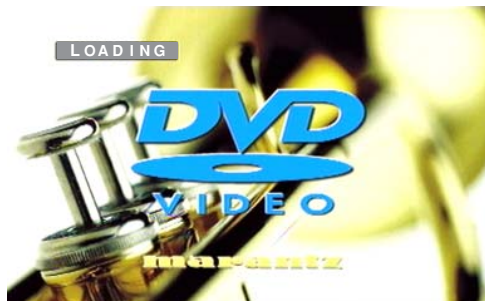

3. Press OPEN/CLOSE button

When the disc tray opens, OPEN message is displayed on TV screen and Fluorescent display on front panel simultaneously.



4. Load your selected disc using disc tray guide with logo-printed side up

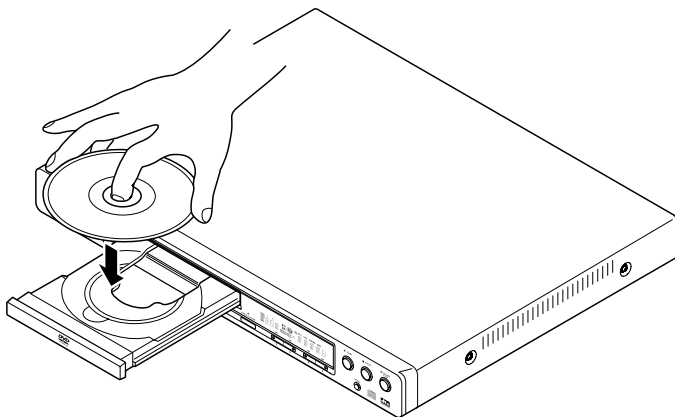

5. Press OPEN/CLOSE button again to close the disc tray

Basic play of DVD, VIDEO-CD or CDDA

1. Press PLAY button

When you press the PLAY button, the disc tray will be closed if opened and play will start automatically. In case of many DVD movies, an interactive DVD or Video CD with PBC, a menu screen appears on the TV. In this case you should follow next instruction.

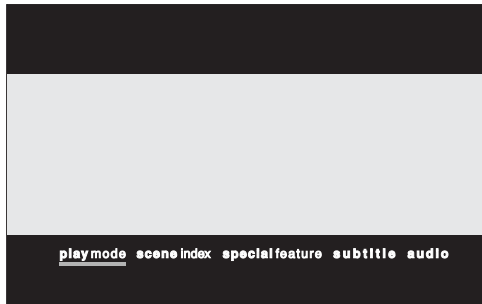

DVD menu screen

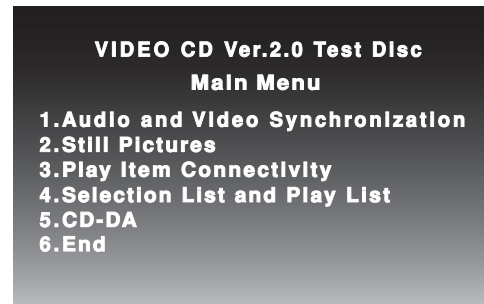

Video CD menu screen

2. When a menu screen appears on the TV screen

When a DVD disc is loaded, select desired menu item using arrow button or numeric button (remote only) and then press ENT (ER) button to start play. When a VCD is loaded, select desired menu item using numeric button (remote only) and then press ENT (ER) button to start play.

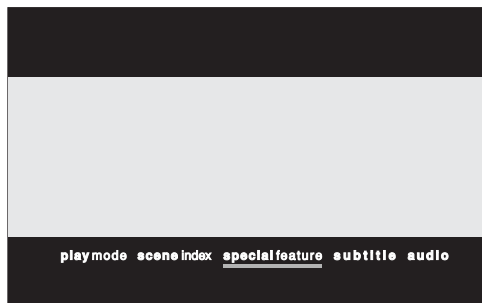

Selecting DVD Menu

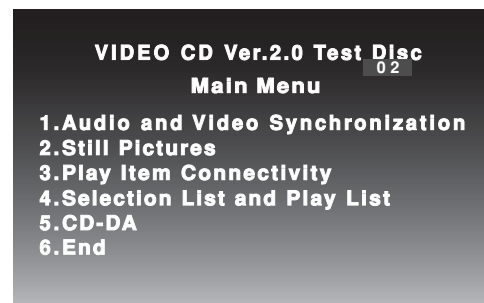

Selecting Video CD Menu

Basic play of MP3

1. Load MP3 disc

When an MP3 disc is loaded, MP3 menu screen is displayed automatically depending on MP3 disc's folder (directory) structure as shown below.



2. Select desired folder

Use the arrow button to select the folder you want to play, by pressing the ENT (ER) button. This button allows, you to see the file lists under the folder.

3. Select MP3 title when stopped

Use arrow button and select an MP3 title using the ENT (ER) button then play will start automatically. When you know the title number, enter the MP3 title number using the numeric buttons on the remote controller and then press the ENT (ER) button.

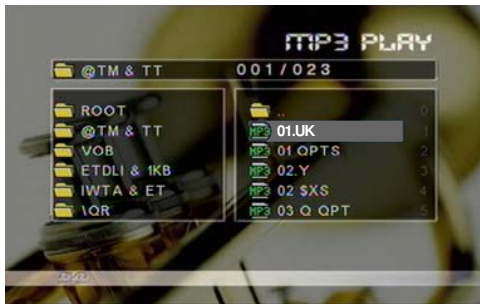

Selecting MP3 file

4. Select MP3 title when playing

Press NEXT button on remote controller to choose next title. Press PREV button for previous title.

When you know the title number, enter MP3 title number using the numeric buttons on the remote controller and then press the ENT (ER) button.

Note This player can recognize a maximum of 126 folders and 255 tracks.

Selecting VIDEO MODE

1. Using PAL/NTSC button

If TV or MONITOR does not display output image properly, keep pressing NTSC/PAL button on the remote controller until the output displays normal images. Each pressing of NTSC/PAL button changes VIDEO MODE in turn of, MULTI and NTSC.

2. Using SETUP

Press the SETUP button and select VIDEO submenu on SETUP screen. After that, select TV type by pressing DOWN button until your TV mode is selected. (Page34)

3. The information will remain effective when the POWER is turned ON next time.

Disc Format	Position of TV Type	
	MULTI	NTSC
NTSC	NTSC	NTSC
PAL	PAL	NTSC

Selecting MENU ITEMS (DVD or Video CD with PBC only)

MENU screen is displayed on DVD disc with MENU data or VIDEO CD with PBC Junction.

1. Selecting 3rd menu item when DVD menu screen appears as shown below

Ex1) Press the numeric 3 button on remote controller and then press ENT (ER) button

Ex2) Press DOWN button twice to highlight the 3rd menu item then press ENT (ER) button

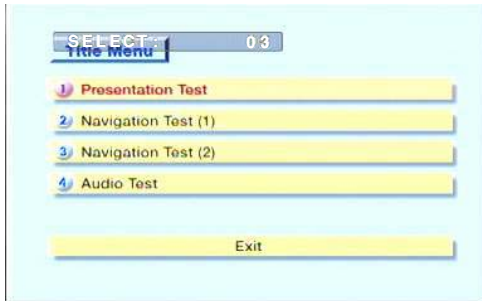

Select using numeric button

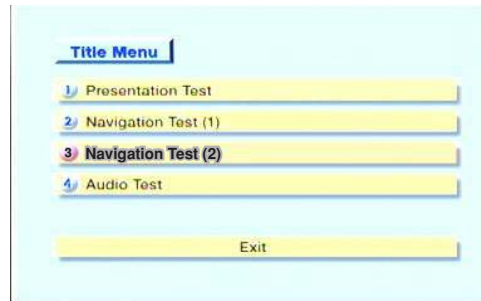

Select using arrow button

2. Selecting the 3rd menu item when Video CD menu screen appears as shown below

Ex) Press the numeric 3 button on remote controller and then press SELECT button

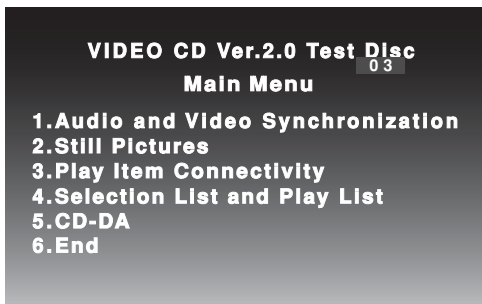

STOP and POWER OFF

1. Stop playing

Press the STOP button during play mode. If a DVD disc is playing, PRESTOP OSD is displayed when you press the STOP button once showing time information and the play mark (▶) will be blinking on the Fluorescent Display instead of the STOP message. This state is called PRESTOP. If you press PLAY in a PRESTOP state, the picture is played from the point you previously stopped.

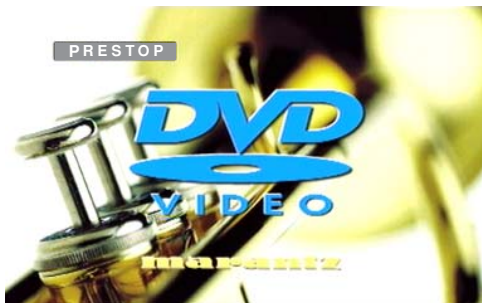

DVD PRESTOP



VCD STOP

2. Removing DISC from the disc tray

Press OPEN/CLOSE button to open disc tray. When the disc tray is opened, take out the disc from the tray.

3. Press POWER button

When POWER is pressed, disc tray is closed and POWER is into STAND BY mode and STAND BY indicator turns on.

If power is stand by, after pressing POWER button during PLAY or PRESTOP state, play is resumed from the point where it was stopped. It is called RESUME function. If you switch OFF by disconnecting AC cord, the machine will start playing from the first track or chapter.

SEARCH

Use this function to play the DISC contents in fast forward or fast reverse. During searching, audio will be muted (except CDDA).

1. FAST FORWARD**1. Press FF/SF button during play mode**

▶▶ FAST 2X is displayed on TV screen and the speed of forward direction becomes faster.

2. Press FF/SF button again

▶▶ FAST 4X is displayed on TV screen and the speed of forward direction becomes faster. When a DVD disc is loaded, it changes faster and faster from FAST 16X, FAST 32X and FAST 64X. If you press the FF/SF button again during FAST 64X if playing a DVD (FAST 16X when VCD, FAST 8X when CDDA), it goes back to FAST 2X.

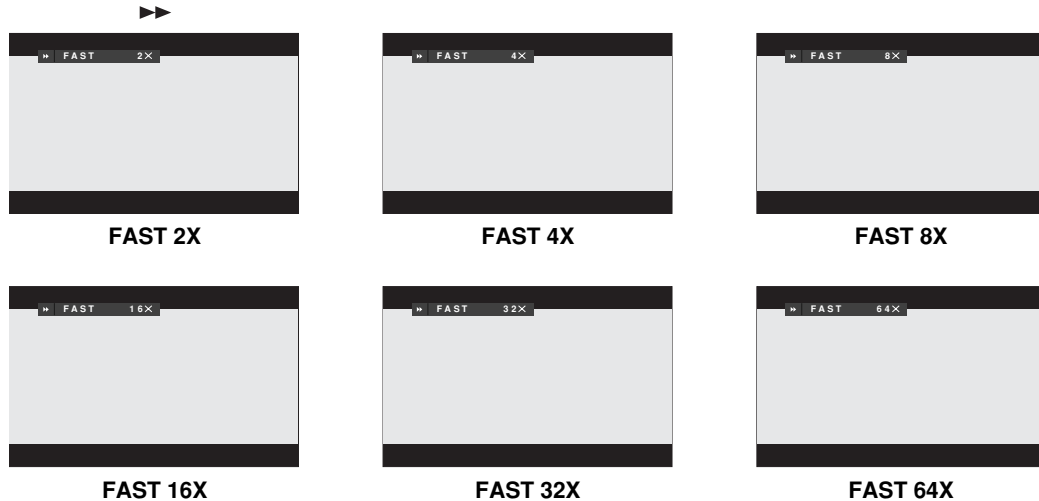
**2. FAST REVERSE****1. Press FR/SR button during play mode**

◀◀ FAST 2X is displayed on TV screen and the speed of reverse direction becomes faster.

2. Press FR/SR button again

◀◀ FAST 4X is displayed on TV screen and the speed of reverse direction becomes faster. When a DVD disc is loaded, it changes faster and faster from FAST 16X, FAST 32X and FAST 64X. If you press the FR/SR button again during FAST 64X if playing a DVD (FAST 16X when VCD, FAST 8X when CDDA), it goes back to FAST 2X.



SKIP

Use this function to move to the next or previous chapter for DVD, track for VCD and CDDA.

1. SKIP FORWARD**1. Press NEXT button during play mode**

If NEXT button is pressed, the current chapter or track stops and starts playing the next chapter or track. By pressing this button continuously, you may locate the desired chapter or track even faster. When the last chapter or track is encountered, if playing a VCD or CDDA, it stops playing and goes to the stop status. If playing a DVD, it depends on the disc's content. It may display the menu contents of the disc.

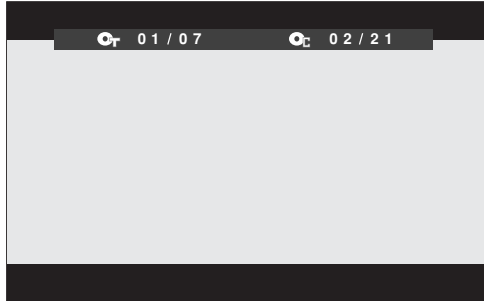
**SKIP FORWARD****2. SKIP REVERSE****1. Press PREV button during playing**

If PREV button is pressed, the current chapter or tracks stop and start playing the previous chapter or track. By pressing this button continuously, you may locate the desired chapter or track even faster. When the first chapter or track is encountered, if playing a VCD or CDDA, it stops playing and goes to the stop status. If playing a DVD, it starts playing from the first chapter.

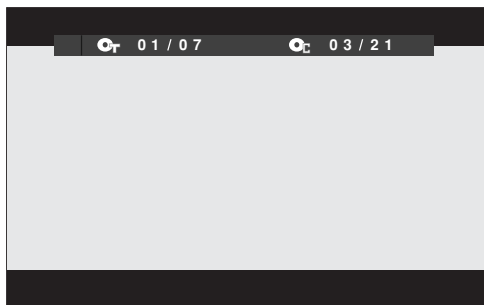
**SKIP REVERSE****SLOW**

Use this function when you want to view the movie slowly. This function works only for DVD or VCD.

1. SLOW FORWARD**1. Press PAUSE / STEP button during play mode**

By pressing PAUSE / STEP button, it pauses the playing temporarily.

2. Press FF/SF button

If FF/SF button is pressed under PAUSE or STEP, ► SLOW 1/2 is displayed and the speed of forward direction becomes slower.

3. Press FF/SF button again

If FF/SF button is pressed again, ► SLOW 1/4 is displayed and the speed changes even slower.

If pressed again ► SLOW 1/8 is displayed and it changes slower in conformity to the ratio. To return to normal play, press PLAY button (DVD and VCD). The CLEAR button clears slow state at any speed of slow.

**SLOW 1/2****SLOW 1/4****SLOW 1/8****Note**

- There is no sound when viewing pause/STEP or slow playback.
- Pause/STEP or slow play may not be possible with certain titles.

2. SLOW REVERSE (DVD ONLY)

1. Press PAUSE/STEP button during play mode

By pressing PAUSE/STEP button, the play mode is temporarily paused.

2. Press FR/SR button

If FR/SR button is pressed under PAUSE/STEP, ◀ SLOW 1/2 is displayed and the speed of the reverse direction becomes slower.

3. Press FR/SR button again

If FR/SR button is pressed again, ◀ SLOW 1/4 is displayed and the speed changes even slower.

If pressed again ◀ SLOW 1/8 is displayed and it changes slower in conformity to the ratio. To return to normal play, Press PLAY button. The CLEAR button clears slow state at any speed of slow.

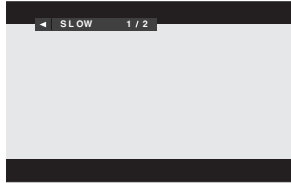

SLOW 1/2



SLOW 1/4



SLOW 1/8

Selecting Audio Languages (DVD only)

It is possible to change the audio soundtrack language to a different language from the one selected at the initial settings. This operation works only with discs on which multiple audio soundtrack languages are recorded. If the loaded disc supports multiple languages, you can see AUD indicator on FL display.

1. Press AUDIO button during play

If a disc does have multiple languages, the audio information is displayed as the figure shown below and the audio language is changed. If the loaded disc does not support multiple audio, the forbidden mark (⊘) is displayed.

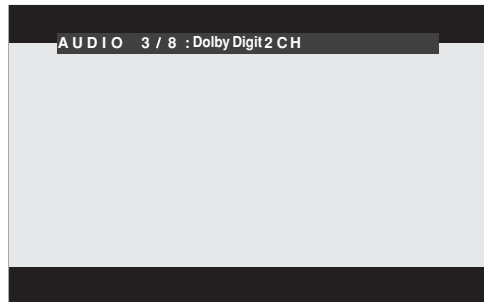

Audio Change

2. Choosing desired audio language

Pressing the AUDIO button continuously until the desired audio language is displayed.

This function is a disc dependent. There are some DVD discs that prevent selecting languages even though the disc supports multiple languages. If this is the case, languages should be selected via the disc menu.

Selecting Subtitles (DVD only)

It is possible to change the subtitle language to a different language from the one selected at the initial settings. This operation works only with discs on which multiple subtitle languages are recorded. If the loaded disc supports multiple subtitles, you can see SUB-T indicator on FL display.

1. Press SUBTITLE button during playing

If playing a disc with multiple subtitles, the subtitle information is displayed as the figure shown below and the subtitle language is changed. If the loaded disc does not support multiple subtitle, the forbidden mark (⊘) is displayed.

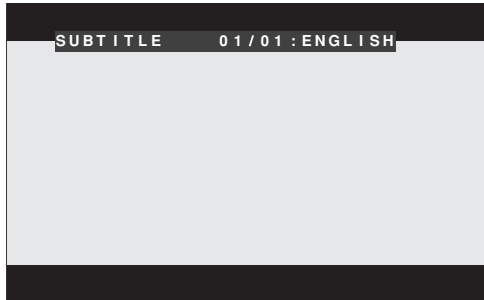

SUBTITLE Change

2. Choosing desired subtitle language

Press the SUBTITLE button continuously until the desired subtitle language is displayed.

This function is a disc dependent. There are some DVD discs that prevent selecting subtitle even though the disc supports multiple subtitles. In this case, the subtitle should be selected via the disc menu.

Selecting Angles (DVD only)

Some DVD discs may contain scenes, which have been shot simultaneously from a number of different angles. For these discs, the same scene can be viewed from each of these different angles using the ANGLE button. If the loaded disc supports multiple angles, you can see  indicator on the FL display and TV screen.

1. Press ANGLE button during play mode

When playing a disc with multiple angles recorded, the camera angle is changed as shown in the figure.

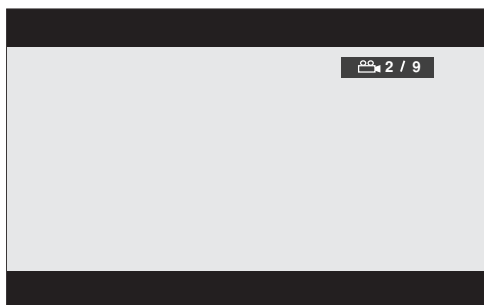

Angle Change

2. Choosing desired angle

Press the ANGLE button continuously until the desired angle is displayed.

This function is a disc dependent. There are some DVD discs that prevent selecting angle using ANGLE button even though the disc supports multiple angles. In this case, angle changes should be selected via the disc menu.

Kodak picture CD play

When a Kodak Picture CD is inserted, an automated slide show is launched.
 You can see nine thumbnail pictures by using the digest key .
 Twelve slideshow transition modes are provided. Use Menu key to switch the slideshow effect Mode.

1. Slideshow modes

- 0 : no effect(default)
- 1 : wipe from top to bottom
- 2 : wipe from bottom to top.
- 3 : wipe from top/ bottom to center.
- 4 : wipe from center to top/ bottom
- 5 : vertical blind
- 6 : wipe from left to right
- 7 : wipe from right to left.
- 8 : wipe from left /right to center
- 9 : wipe from center to left/right.
- 10 : wipe from edge to center
- 11 : horizontal blind
- 12 : random

2. Image rotation.

There are four modes to rotate a picture: Left,Right,Invert,Mirror

▲ key : invert ▼ key :mirror ◀ : Turn left ▶ : Turn right

JPEG file play

When a JPEG file is loaded, an automated slide show is launched.
 You can enjoy Twelve slideshow effects(same as Kodak picture CD slideshow mode) by using Menu key of the remote controller.
 And You can see nine thumbnail pictures by using the Digest key .
 You also rotate image same as Kodak picture CD playing.

1. Zoom effect

You can see a picture at 25% ~ 200% size.

Press zoom button in the slideshow mode, use FF and FR key to control the amount of zoom in and out, and press the zoom button again, zoom function is off and return to slideshow mode.

3D sound effect (MP3, CDDA, Dolby Digital 2CH Stereo only)

This function outputs 3D effects on the stereo audio analog output. 3D effects are broken down into 4 surround modes.

1. Press 3D SOUND button

3D SOUND MODE 1 is displayed on TV screen. And analog stereo output is changed to surround mode 1.

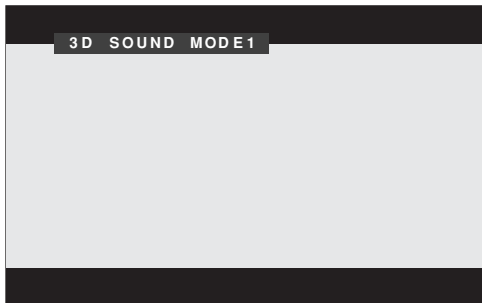

3D SOUND MODE1

2. Press 3D SOUND button again

Press the 3D SOUND button continuously until the desired 3D sound mode is selected.

3D SOUND MODE2 → 3D SOUND MODE3 → 3D SOUND MODE4 → NORMAL

Note This function is only for CDDA, MP3 and Dolby Digital 2CH Stereo.

Repeat selected segment

Use this function to repeat the play of a selected segment. This is very useful for studying foreign languages because it repeats the selected segment until canceled.

1. Press A-B button

Press A-B button at the point of where repeat play is to start. A TO B, SET A and A-★ are displayed, followed by A- indicator on FL display turning on, and the starting point of your selected segment is set up.

2. Press A-B button again

Press A-B button at the point of where repeat play is to end. While A TO B, SET B and A-B are displayed again and A-B indicator on FL display is turned on, the ending point is set up and PLAY starts from the A point right away.

3. Press A-B button once more

Press A-B button one more time to cancel the repeat play. A TO B, CANCELLED and ★-★ are displayed on TV screen

We recommend you set up the desired segment within a minimum 3 seconds for smooth repeat play.



A TO B SET A

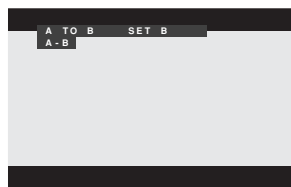

A TO B SET B

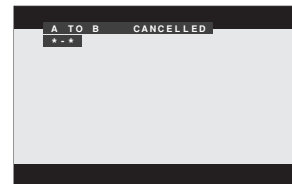

A TO B CANCELLED

Utilizing Repeat Function

Use this button to repeat the chapter/title for DVD or track/disc for VCD and CDDA.

1. Press REPEAT button

When playing a DVD, CHAPTER REPEAT ON is displayed on the TV screen and REPEAT C indicator on the FL display is turned on. In this status, the selected chapter is played repeatedly forever. Whilst if playing a VCD or CDDA, REPEAT ONE is displayed on the TV screen and REPEAT 1 indicator on the FL display is turned on. In this case, the selected track is played repeatedly forever.



In case of DVD

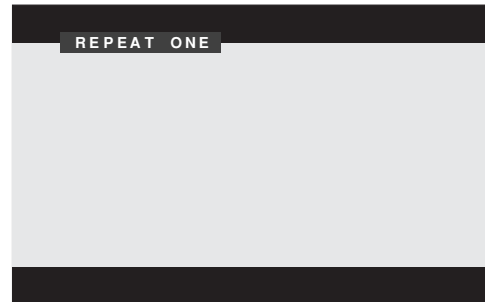

In case of VCD

In order to use the repeat function on a VCD with PBC, you should turn off PBC by pressing PBC button on the remote controller.

2. Press REPEAT button again

If playing a DVD, TITLE REPEAT ON is displayed on the TV screen and REPEAT T indicator on the FL display is turned on. In this state, the selected title is played repeatedly forever. Whilst if playing a VCD or CDDA, REPEAT ALL is displayed on the TV screen and REPEAT ALL indicator on the FL display is turned on. In this case, all tracks on disc are played repeatedly forever.



In case of DVD

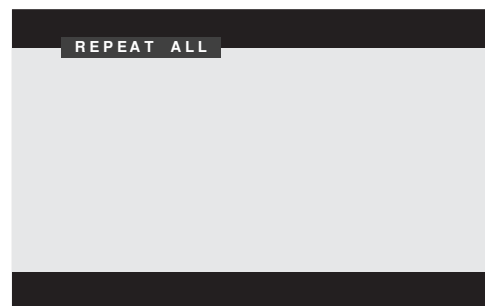

In case of VCD

3. Press REPEAT button again

If you press the REPEAT button in REPEAT TITLE or REPEAT ALL state, REPEAT OFF is displayed on the TV screen and REPEAT T or ALL on the FL display is cleared. The repeat function becomes cleared and the playing state changes to normal.

Note With some DVD discs, there may be times when repeat playback is not possible.

SHUFFLE (VCD with PBC off, MP3, CDDA only)

This function selects random tracks and plays all the tracks on the disc just once in random order.

1. Press SHUFFLE button on remote controller

When the SHUFFLE button is pressed, SHUFFLE is displayed on the TV screen and the SHUFFLE indicator on the FL display is turned on.

2. Press PLAY button

When the PLAY button is pressed, the shuffled track starts playing.

3. Press SHUFFLE button to cancel SHUFFLE operation

To cancel SHUFFLE operation, press SHUFFLE button. When the SHUFFLE button is pressed, SHUFFLE OFF is displayed on TV and the SHUFFLE indicator on the FL display is turned off.



Shuffle On



Shuffle Off

- In order to use the shuffle function on a VCD with PBC, you should turn off the PBC by pressing the PBC button on remote controller.
- In case of MP3 Playing, if shuffle button is pressed, random play is engaged and RANDOM is displayed on the TV screen and the SHUFFLE indicator on the FL display is turned on.

If shuffle button is pressed again, shuffle play is engaged and SHUFFLE is displayed on the TV screen and the SHUFFLE indicator on the FL display is turned on. (RANDOM is that all the trucks is played in random order till shuffle is cancelled)

PROGRAM (VCD, MP3, CDDA only)

This function is used to play the tracks on the disc in an order you program.

1. Press STOP button

Press the STOP button to stop playing because this function is valid only for the STOP state.

2. Press PROGRAM button on remote controller

When the PROGRAM button is pressed, PROGRAM P00:00 is displayed on the TV screen, the PROGRAM indicator on the FL display is turned on, the title number on the FL display is 0 and time information is 00:00.

3. Enter track number to program

Enter the number of the desired TRACK and press the ENTER button. When the number of the desired TRACK is entered, PROGRAM PXX:YY is displayed on the TV screen and FL displays entered TRACK number (XX is the number of programmed tracks and YY is the last entered track number). In the following figure, a total of 4 tracks are programmed and the last track number is 5.



Program Initial Screen



Programmed – Total 4 tracks

4. **Press a PLAY**
When all the desired TRACK numbers are entered, press PLAY to play according to the programmed order
5. **PROGRAM**
Press PROGRAM after STOP button, when the PROGRAM button is pressed repeatedly, status of PROGRAM appeared on the TV screen and FL display.
6. **Press CLEAR after STOP button**
To cancel the PROGRAM operation, press the STOP button to stop programmed playing and then press the CLEAR button for longer than 3sec. If press the CLEAR button rapidly, the last entered track is cancelled.

Digest (VCD, JPEG, Kodak picture CD, CDDA only)

This function helps speedy search to the desired track by displaying 9 different small screens per page showing information regarding the tracks recorded on the disc. When an CDDA is loaded, only the 1. INTRO function will work so be careful.

1. **Press STOP button**
Press the STOP button to stop playing because this function is valid only for the STOP state.
2. **Press DIGEST button**
If the DIGEST button is pressed, 4 submenus are displayed on the TV screen as shown below.
Select the submenu, which you want, by pressing the appropriate number button and the ENTER button. If you don't want this function, press number 4 for exit.



Digest submenu for VCD



Digest submenu for CDDA

1. INTRO plays each track for 10 seconds (VCD and CDDA)
2. DISC shows digest screen based on the disc. It plays each track on the thumbnail screen for about 5 seconds (VCD only).
3. TRACK shows digest screen based on the track. It plays partitioned track on thumbnail screen for about 5 seconds (VCD only).
4. EXIT just exits digest function

3. **When you choose INTRO**
All the tracks on the disc are played for 10 seconds if no key is pressed. After all the tracks are played, it stops and displays STOP on the TV.
4. **When you choose DISC or TRACK**
Digest function will play and display in the small screen in the center. Each screen plays approximately five seconds while displaying a total of nine screens as shown in the figure. Press NEXT button to see the next page and press PREV button to see the previous page.

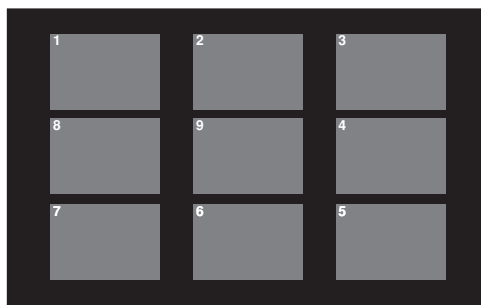

Digest - DISC



Digest - TRACK

5. **Press the desired screen number**
If you press the desired number of small screen, it starts playing from the position where the small screen begins. You don't need to press the ENTER button.

- In case of JPEG, Kodak Picture CD, See page 24.

MARKER (DVD, VCD WITH PBC OFF, CDDA)

This function is to move to the desired location fast and easily during play by storing up to 5 markers in advance.

1. Press MARKER button during play mode

When MARKER button is pressed during play, the screen is displayed as shown the figure below.

2. Storing marker

Go to the desired marker point using arrow buttons and press the ENTER button to store the data to be viewed. ✓ will be marked at the selected point.

3. Repeat storing marker as you want

By repeating the above 2 steps, you may store a maximum of 5 markers.

4. Choose stored marker

To play the marker point, press the MARKER button to shows maker information and select the desired marker using arrow buttons, and press the ENTER.

5. Deleting stored marker

To cancel the marker function, press up, down or CLEAR button at the marker you want to delete



Marker Initial Screen



1 Marker Stored

Display

The unit features On-Screen Menu icons showing disc information such as TITLE and CHAPTER for DVD, TRACK for VCD, and TIME or Bit Rate (DVD only) during play. There are 10 sub functions for DVD, 8 sub functions for VCD or CDDA. DVD sub functions are TITLE/CHAPTER search, TIME SEARCH, TITLE ELAPSED, TITLE REMAIN, CHAPTER ELAPSED, CHAPTER REMAIN, BIT RATE METER, SHUFFLE, PROGRAM and REPEAT. VCD sub functions are TRACK/TIME search, SINGLE ELAPSED, SINGLE REMAIN, TOTAL ELAPSED, TOTAL REMAIN, SHUFFLE, PROGRAM and REPEAT.

Note Depending on the format and type of disc being used, not all screens may be displayed.

1. Display function for DVD

1. Perform TITLE and CHAPTER search

When the DISPLAY button is pressed during play. TITLE and CHAPTER information are displayed as shown in the figure below. For TITLE search, Enter the number of your desired title number using numeric buttons and then press the ENTER button or adjust title number using up and down buttons and press the ENTER button at the TITLE column. For Chapter search, Adjust chapter number in the same manner as for title search.

2. Perform TIME SEARCH

When the DISPLAY button is pressed twice during play, TIME SEARCH sub function is activated.

After entering the time you want to jump, press the ENTER button. If you want to go to 0:31:23 (0 hour, 31 min, 23 sec) press the numeric buttons in this order (0, 3, 1, 2, 3) then press the ENTER button. The time you want to enter should be in the title boundary. After you press the ENTER button, it starts playing from the time entered, if valid.

3. Viewing time information

When the DISPLAY button is pressed three times during play, title elapsed time information is displayed on top of TV screen at the left corner. When the DISPLAY button is pressed again title remain time information is displayed. If pressed again, CHAPTER elapsed time information is displayed. Pressing the DISPLAY button once more activates CHAPTER remain time information. Press of DISPLAY button displays the Bit Rate Meter.

Finally, press of the DISPLAY button displays the SHUFFLE / PROGRAM / REPEAT information.

4. Displaying Off

Press DISPLAY button when SHUFFLE / PROGRAM / REPEAT are activated.

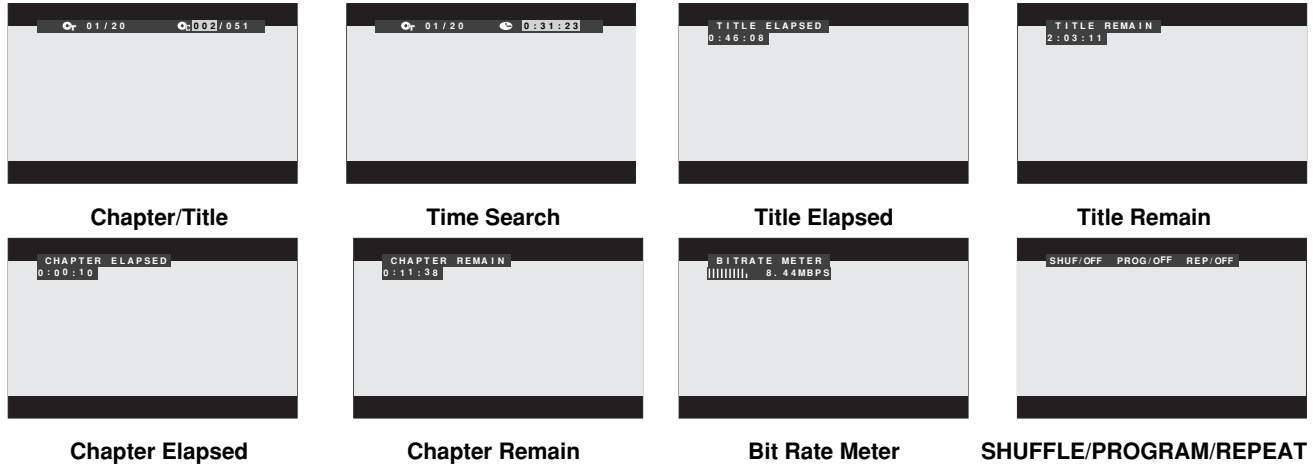

2. Display function for VCD (PBC off only)

1. Perform TRACK search

When the DISPLAY button is pressed during play, TRACK information and TIME search is displayed as shown in the figure below. For TRACK search, enter the number of your desired track using numeric buttons and then press the ENTER button or adjust track number using up and down buttons and press the ENTER button at the TITLE column.

2. Perform TIME search

Press the Right arrow button go to the TIME search, during TRACK information and TIME search is displayed. After entering the time you want to jump, press the ENTER button. If you want to go to 01:23 (1 min, 23 sec), press the numeric buttons in this order (0, 1, 2, 3) and press the ENTER button. The time you want to enter should be in this current track boundary. After you press the ENTER button, it starts playing from the time entered if valid.

3. Viewing time information

When the DISPLAY button is pressed twice during play, track (single) elapsed time information is displayed on the top of the TV screen at the left corner. When the DISPLAY button is pressed again, a track (single) remain time information is displayed on the screen. If pressed again, disc (total) elapsed time information is displayed on the screen. And next DISPLAY button activates disc (total) remain time information. Press of the DISPLAY button displays the SHUFFLE / PROGRAM / REPEAT information.

4. Display Off

Press DISPLAY button when SHUFFLE / PROGRAM / REPEAT are activated.

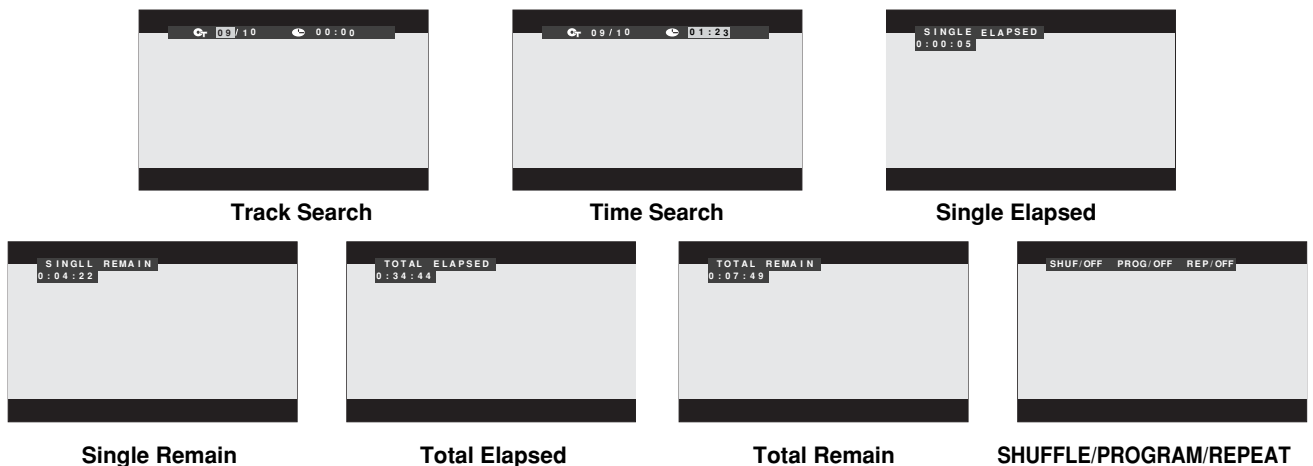

Zoom screen

1. Zoom screen by X2

If the ZOOM button is pressed during play, ZOOM X2 is displayed and the screen is magnified to twice the size.

2. Zoom screen by X4

If the ZOOM button is pressed again, ZOOM X4 is displayed and the screen size is quadrupled.

3. Zoom screen by X8

If the ZOOM button is pressed again, ZOOM X8 is displayed and the screen is magnified by eight times.

4. Zoom off

If the ZOOM button is pressed again when in ZOOM X8 state, ZOOM function is turned off and a normal screen is displayed. Pressing the CLEAR button at any time of ZOOM state clears ZOOM function.



Zoom 2X



Zoom 4X



Zoom 8X

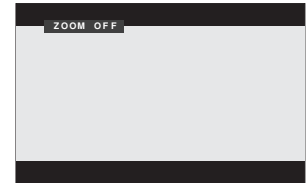

Zoom Off

CUSTOMIZING DVD PERFORMANCE

Once the initial settings have been completed, the player can always be operated under the same conditions whenever the power is switched on. These settings are called SETUP data that are easily modified and stored using the SETUP menu. The SETUP menu includes the information for AUDIO, VIDEO, OTHER system controls, LANGUAGES and parental LOCK. AUDIO and VIDEO submenus deal with items related to AUDIO and VIDEO. The OTHER submenu deals with items related to other system controls. LOCK submenu deals with items related to parental locks, they are parental levels and passwords. The submenu of SETUP is differentiated by two categories. One is submenu changeable during play mode. The other is not. The ability to change during play is on the AUDIO and VIDEO submenu. The other is OTHER, LANGUAGE and parental LOCK.

Audio

There are six sub items in the AUDIO submenu. They are DIGITAL OUT, LPCM OUTPUT, DOWNMIX, DUAL MONO, OPERATIONAL and DYNAMIC RANGE. When you press the SETUP button and select AUDIO among the six submenus, the sub items for AUDIO are displayed as shown in the figure below.



1. DIGITAL OUT

DIGITAL OUT item controls the output condition of digital out (coaxial or optical) connector. There are 3 values possible for DIGITAL OUT. They are OFF, BITSTREAM and PCM. In case of OFF value, No digital signal can be output. Only analog audio can be output. In case of BITSTREAM value, the original audio stream recorded on the disc is output through the digital out connector. In case of PCM value, the decoded audio stream will be output through the digital out connector. The relation of amplifier and DIGITAL OUT option is shown below.

DISC	DVD									VCD & CD & MP3		
	Dolby Digital Disc			LPCM Disc			DTS Disc			Bitstream	PCM	OFF
	Bitstream	PCM	OFF	Bitstream	PCM	OFF	Bitstream	PCM	OFF			
Digital OUT Setting												
Digital Audio output	Dolby Digital	PCM	-	PCM	PCM	-	DTS	DTS	-	VCD : MPEG CD/MP3 : PCM	PCM	-

Note

- When a recorded in a Dolby Digital or DTS is loaded, noise will be output if you have made connections via the digital audio jacks to a receiver or amplifier that cannot decode a Dolby Digital or DTS digital bitstream. In this case, be sure to set up the SETUP, Audio setting; Digital out to PCM or OFF as above mentioned.

2. LPCM OUTPUT

If your AV amplifier is compatible with high sampling rate (96kHz), set this to LPCM 96k.

LPCM out setting	ANALOG OUT		DIGITAL OUT	
	48k Disc	96k Disc	48k Disc	96k Disc
LPCM 48k	48k sampling	48k sampling	48k sampling	48k sampling
LPCM 96k	48k sampling	96k sampling	48k sampling	96k sampling

Note

- Even when set to LPCM 96k, some discs will only output down sampled audio.

3. DOWNMIX (Dolby Digital DVD disc only)

DOWNMIX is used to reproduce the proper analog audio when the audio channel recorded on the disc differs from the output audio channel configuration. Assume that 5.1 channels audio are recorded on the disc but you can receive only stereo audio channels. In this case downmix is unavoidable and you will hear all the channels recorded on disc. There are two ways of downmixing. One is LT/RT and the other is LO/RO. If you are using Dolby Surround Pro Logic decoder, please set the downmix mode to LT/RT otherwise LO/RO.

4. DUAL MONO (Valid for Dolby Digital DVD disc)

DUAL MONO are two independent mono channels defined in Dolby Digital. DUAL MONO programs are mainly used for different language versions in one program. This functions in a similar fashion to TV or VCR supporting secondary audio program. From two MONO channels, STEREO, LEFT MONO, RIGHT MONO and MIXED MONO may be output in 4 different combinations.

STEREO	L channel on L speaker, R channel on R speaker
LEFT MONO	L channel on L and R speaker
RIGHT MONO	R channel on L and R speaker
MIXED MONO	Mix two mono and output mixed mono on both (L, R) speaker

5. OPERATIONAL

To simplify the implementation of dialogue normalization, dynamic range control, and downmixing, Dolby Digital decoder implementations offer standard operational modes called Line Mode and RF Mode. There are 2 values for OPERATIONAL. They are Line Mode and RF Mode. Choose Line Mode when connecting to an amplifier, RF Mode for TV.

6. DYNAMIC RNG (Valid for Dolby Digital DVD disc)

A consistent problem in the delivery of audio programming is that different members of the audience desire or even need different amounts of dynamic range depending on the listening situation. Original high quality programs, such as feature films, are typically mixed with a wide dynamic range. Using dialogue as a reference, loud sounds like explosions are often 20 dB louder, and faint sounds like leaves rustling may be 50 dB quieter. In many listening situations, it is objectionable to allow the sound to become very loud, and the loudest sounds must be compressed downwards in level. Likewise the very quiet sounds would be inaudible and must be brought upwards in level to be heard. If you want to hear the original dynamic range recorded on disc set the DYNAMIC RNG to 0. Otherwise set to 8 then the dynamic range is reduced by bringing down the level of the loud sounds and bringing up the level of the quiet sounds.

Video

There are 6 submenus for VIDEO. They are OSD, TV ASPECT, TV TYPE, PROGRESSIVE, OUTPUT MODE, CAPTIONS. If you select VIDEO, VIDEO sub items are displayed as shown in the figure.

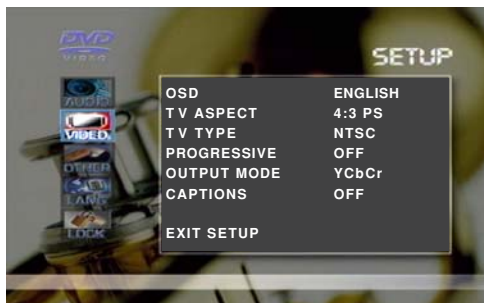

1. OSD LANG



This item is to select the language for On-Screen Display messages that will be displayed on the TV screen. When your desired language is selected, all OSD messages are displayed in the selected language.

2. TV ASPECT

Set up TV aspect according to your TV set. If WIDE screen is supported on your TV, select 16:9 WIDE. If your TV supports only 4:3, you may select both 4:3 PS (Pan & Scan) and 4:3 LB (Letter Box).



When using a wide screen TV (16:9 aspect ratio)

Select 16:9 WIDE in the TV ASPECT value. Discs may be recorded in more than one screen format. Following the chart below, make screen aspect adjustments in your wide screen TV according to the aspect ratio on the disc you are viewing.

	Wide Screen Disc (16:9)	Standard Screen Disc (4:3)
Screen		
TV Setting	Wide	Standard

When using a standard TV (4:3 aspect ratio)

Select 4:3 LB (Letter Box) or 4:3 PS (Pan & Scan) in the TV ASPECT value. Following the chart below, make screen aspect adjustments according to the aspect ratio on the disc you are viewing.

	Wide Screen Disc (16:9)	Standard Screen Disc (4:3)
Screen	 Letter Box (4:3 LB)	 No setting required (Always Standard 4:3 screen)
	 Pan & Scan (4:3 PS)	

Note : Some disc will not allow you to change the aspect ratio.

3. TV TYPE

Set up TV type according to type supported by your TV or monitor. When you select MULTI, the output video type is dependent on the disc loaded. If the recorded video type is NTSC then it outputs NTSC.

Disc Format	Position of TV Type	
	MULTI	NTSC
NTSC	NTSC	NTSC
PAL	PAL	NTSC

4. PROGRESSIVE

Set up PROGRESSIVE ON/OFF according to type supported by your TV or monitor. A progressive scan TV is capable of stable, flicker-free images.

Note

- If you connect aTV or monitor, that is not compatible with progressive scan signal and choose “ON” of the progressive scan setting, you will not be able to see any picture at all.
- Push stop button for longer than 5 second to set progressive scan setting into OFF.

5. OUTPUT MODE

If you want to see the picture in S-VIDEO, choose S-VIDEO and connect to the TV set using S-VIDEO cable. Set to YCbCr to view in component video via Y, Cb/Pb, Cr/Pr connect.

Setup Menu / Video		Video Output		
Progressive	Output mode	Video Jack	S-Video Jack	Component Jack
OFF	YCbCr	Composite	–	Interlace mode (480i)
ON	YCbCr	–	–	Progressive mode (480p)
OFF	S-Video	Composite	S-Video	–

6. CAPTIONS (NTSC only)

CLOSED CAPTION was invented for hearing impaired person. But it is very useful when learning foreign languages. If your TV supports closed caption, select ON. If not, closed caption won't be displayed.

Other

If you select OTHER, OTHER's sub item is displayed as shown in the figure below. The sub item of OTHER is related to system control on various subjects.



1. ANGLE MARK (Valid for DVD only)

It is possible to have 9 different angles on a DVD disc. This selects whether to display OSD (On Screen Display) showing multi-angle on the TV screen or not, when playing DVD disc supporting multiple angles. If you select ON, you can see the OSD when multi-angle is detected while playing.

2. SCREEN SAVER

If a bright picture does not move for a long time, the TV may be damaged. If on longer than 5 minutes, the screen saver works when ON is selected. The screen saver protects the CRT (Cathode Ray Tube) from damage by displaying a moving DVD logo continuously on the screen.



3. FLT DISPLAY

There are three levels of brightness to control FL display on the front panel. They are BRIGHT, MEDIUM and DIM. In the bright daylight, you may select BRIGHT and DIM for dark nights.

4. FLT AUDIO CH (Dolby Digital DVD only)

If playing a Dolby Digital DVD disc, the audio channel configuration is varied according to the disc loaded. When you select ON, this feature displays the audio channel configuration on the FL display on the front panel.

5. FRONT KEY

To prevent children from pressing buttons on the front panel, you can select lock. This feature is only effective when the power is on. Whenever you turn on the power, you should select LOCK again to protect the front panel buttons.

6. AUTO POWER OFF

If there is no key input for 5 minutes in status of stop, prestop, pause, setup, top menu, menu, open, no disc, step, screen saver will be executed. Auto power off will be executed after 30 minutes in above condition.

7. DEFAULTS

If you are not confident about what you have selected in setup submenu items, you can initialize them to the factory adjusted values. Be aware that, the password you already have set, remains the same even after the values are changed to the factory defaults.

Languages (DVD only)

If you select LANG., LANG's sub item is displayed as shown in the figure below. The sub item of LANG is related to preferable language for audio, subtitle or disc menu.



1. AUDIO

Set this value to the preferred audio language. If an audio language is selected, whenever you start playing a new disc, the selected audio language is played, if the selected language is contained in the disc. For example, if you select ENGLISH as the preferred audio language and ENGLISH audio language is contained in the disc, when the disc plays it will be in English.

2. SUBTITLE

Set this value to the preferred subtitle language. If a subtitle language is selected, whenever you start playing a new disc, the selected subtitle language is played, if the selected language is contained in the disc. For example, if you select ENGLISH as the preferred subtitle language and ENGLISH subtitle language is contained in the disc. When you start playing the disc, you can see English subtitles.

3. DISCMENU

Set this value to the preferred disc menu language. If a disc menu language is selected, whenever you start playing a new disc, the selected disc menu language is played if the selected language is contained in the disc. For example, if you select ENGLISH as the preferred disc menu language and ENGLISH disc menu language is contained in the disc. When you start playing the disc, you can see the disc menu in English.

Parental Lock (DVD only)

This function is to disable the playing of specified DVD discs that are unsuitable for children. As each disc has slightly different codes, please refer to the disc instruction. There are a total of 8 levels. If the level is 8, the contents of the disc are suitable for adult. If the level is 1, the contents of the disc are suitable for children. If you didn't set a new password, there is no restriction in changing parental level. When you turn on this unit for the first time, a new password set is recommended.

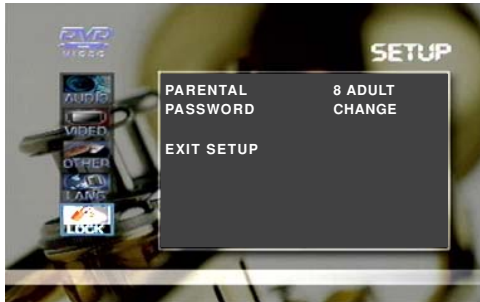

1. PARENTAL

Used to adjust the level of parental lock. Once selected, whenever you play a disc, the selected parental level is compared to the level on the disc. If the level you selected is greater than the level of the disc, you may play the loaded disc. If not, you may not play the disc. To set appropriate parental level do the following instructions. If you move to the PARENTAL sub item, you can see the values for the PARENTAL sub item. You can move to the value position by pressing the RIGHT arrow button. Select proper value using UP and DOWN arrow button and then press the SELECT button. If you press the ENTER button then it asks for the current password. If there is no current password then it doesn't ask. A parental level change will be done by entering the current stored password.



PARENTAL Values

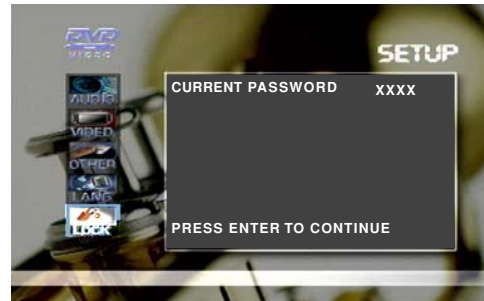

Current PASSWORD

2. PASSWORD

Used to change the saved password to a new one. To change the current password, move to PASSWORD sub item using UP and DOWN arrow buttons. If you move to the PARENTAL sub item, you can see the value for the PASSWORD. Just one sub item CHANGE can be shown. You can move to the value position by pressing RIGHT arrow button. Press ENTER button to change password. If you press ENTER button, password change window appears as shown below. If it is the first time change then there is no old password. If not, you should enter old password. Enter new password in 4 digits. Re-enter new password for confirm then press ENTER button. To store the password press ENTER button, password change is finished.



Change Sub item



Password Change Finish

Note

- If you forget the password, press "8095" as old password in password change.

ADDITIONAL INFORMATION

Handling discs

When holding discs of any type, take care not to leave fingerprints, dirt or scratches on the disc surface. Hold the disc by its edge or by the center hole and edge.

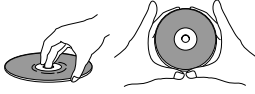

Damaged or dirty discs can affect playback performance. Take care also not to scratch the label side of the disc. Although not as fragile as the recorded side, scratches can still result in a disc becoming unusable.

Should a disc become marked with fingerprints, dust, etc., clean using a soft, dry cloth, wiping the disc lightly from the center to the outside edge as shown in the diagram below.



Wipe lightly from the center of the disc using straight strokes.

Don't wipe the disc surface using circular strokes.

If necessary, use a cloth soaked in alcohol, or a commercially available CD/DVD cleaning kit to clean a disc more thoroughly. Never use benzine, thinner or other cleaning agents, including products designed for cleaning vinyl records.

Storing discs

Although CDs and DVD discs are more durable than vinyl records, you should still take care to handle and store discs correctly. When you're not using a disc, return it to its case and store upright. Avoid leaving discs in excessively cold, humid, or hot environments (including under direct sunlight).

Don't glue paper or put stickers onto the disc, or use a pencil, ball-point pen or other sharp-tipped writing instrument. These could all damage the disc.



For more detailed care information see the instructions that come with discs.

Do not load more than one disc into the player.

Discs to avoid

Discs spin at high speed inside the player. If you can see that a disc is cracked, chipped, warped, or otherwise damaged, don't risk using it in your player—you could end up damaging the unit.

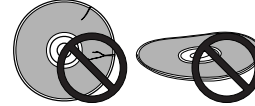

This unit is designed for use with conventional, fully circular discs only. Use of shaped discs is not recommended for this product.

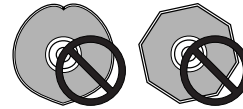

Cleaning the pickup lens

The DVD player's lens should not become dirty in normal use, but if for some reason it should malfunction due to dust or dirt, consult your nearest MARANTZ-authorized service center. Although lens cleaners for CD players are commercially available, we do not recommend using them since some may damage the lens.

Problems with condensation

Condensation may form inside the player if it is brought into a warm room from outside, or if the temperature of the room rises quickly. Although the condensation won't damage the player, it may temporarily impair its performance. For this reason you should leave it to adjust to the warmer temperature for about an hour before switching on and using.

Hints on installation

We want you to enjoy using this unit for years to come, so please bear in mind the following points when choosing a suitable location for it:

Do...

- ✓ Use in a well-ventilated room.
- ✓ Place on a solid, flat, level surface, such as a table, shelf or stereo rack.

Don't...

- ✗ Use in a place exposed to high temperatures or humidity, including near radiators and other heat-generating appliances.
- ✗ Place on a window sill or other place where the player will be exposed to direct sunlight.
- ✗ Use in an excessively dusty or damp environment.
- ✗ Place directly on top of an amplifier, or other component in your stereo system that becomes hot in use.
- ✗ Use near a television or monitor as you may experience interference—especially if the television uses an indoor antenna.
- ✗ Use in a kitchen or other room where the player may be exposed to smoke or steam.
- ✗ Use on a thick rug or carpet, or cover with cloth—this may prevent proper cooling of the unit.
- ✗ Place on an unstable surface, or one that is not large enough to support all four of the unit's feet.

Moving the player

If you need to move the player, first press **POWER** button on the front panel to turn the player off, then the unplug the power cord. Never lift or move the unit during playback—discs rotate at a high speed and may be damaged.

Power cord caution

Handle the power cord by the plug part. Do not pull out the plug by tugging the cord, and never touch the power cord when your hands are wet, as this could cause a short circuit or electric shock. Do not place the unit, a piece of furniture, or other object on the power cord or pinch the cord in any other way. Never make a knot in the cord or tie it with other cords. The power cords should be routed so that they are not likely to be stepped on. A damaged power cord can cause a fire or give you an electric shock. Check the power cord once in a while. If you find it damaged, ask your nearest MARANTZ authorized service center or your dealer for a replacement.

Resetting the player

Resetting the player returns setup menu to their factory defaults. To reset the player, press and hold ◀◀ (FR) and ▶▶ (NEXT) on the front panel simultaneously.

Malfunctioning of this unit

Static electricity or other external influences may cause malfunctioning of this unit. In this case,

1. Press the power button on the front panel till power is turned off .
2. unplug the power cord and then plug back in.

This will usually reset the unit for proper operation. If this does not correct the problem, please consult your nearest MARANTZ service center.

Glossary

Analog audio

An electrical signal that directly represents sound. Compare this to digital audio which can be an electrical signal, but is an indirect representation of sound. See also Digital audio.

Aspect ratio

The width of a TV screen relative to its height. Conventional TVs are 4:3 (in other words, the screen is almost square); widescreen models are 16:9 (the screen is almost twice as wide as it is high).

Chapter (DVD-Video)

Just as a book is split up into several chapters, a title on a DVD disc is usually divided into chapters. See also Title.

Digital audio

An indirect representation of sound by numbers. During recording, the sound is measured at discrete intervals (44,100 times a second for CD audio) by an analog-to-digital converter, generating a stream of numbers. On playback, a digital-to-analog converter generates an analog signal based on these numbers. See also Sampling frequency and Analog audio.

Dolby Digital

The maximum 5.1 channels of audio used in the surround system (Surround Digital) for movie theaters is digital data compressed by the third generation algorithm encoder.



In order to enjoy Dolby Digital discs, this unit's digital output jack (either coaxial or optical) must be connected to the digital input jack of an AV amplifier or Dolby Digital decoder to enjoy the sound of Dolby Digital soundtracks.

DTS

DTS stands for Digital Theater System. DTS is a surround system different from Dolby Digital that has become a popular surround sound format for movies. In order to enjoy the benefits of DTS encoded discs, the digital output jack (either coaxial or optical) of this player needs to be connected to an AV amplifier or receiver or to a DTS decoder to be able to enjoy the surround sound of DTS audio. DTS audio is not output from the analog audio outputs.



Dynamic range

The difference between the quietest and loudest sounds possible in an audio signal (without distorting or getting lost in noise). Dolby Digital and DTS soundtracks are capable of a very wide dynamic range, delivering dramatic cinema-like effects.

File extension

A tag added to the end of a filename to indicate the type of file. For example, ".mp3" indicates an MP3 file.

Interraced video

A method of displaying a picture in which odd-numbered lines are updated in one pass, then even-numbered lines updated in the next. See also Progressive scan video.

MP3

MP3 (MPEG1 audio layer 3) is a compressed audio file format. Files are recognized by their file extension ".mp3" or ".MP3".

MPEG video

The video format used for Video CDs and DVDs. Video CD uses the older MPEG-1 standard, while DVD uses the newer and much better quality MPEG-2 standard.

Multi-session

A CD-R/RW that contains two or more 'sessions'. Each session is a complete recording process, so each session is read as a complete disc. This player can only read the first session on a disc.

Optical digital output

A jack that outputs digital audio in the form of light pulses. Connect components with optical digital jacks using a special optical cord, available from good audio dealers.

PCM (Pulse Code Modulation)

The most common system of encoding digital audio, found on CDs and DAT. Excellent quality, but requires a lot of data compared to formats such as Dolby Digital. For compatibility with digital audio recorders (CD, MD and DAT) and AV amplifiers with digital inputs. See also Digital audio.

PBC (PlayBack Control) (Super VCD / Video CD only)

A system of navigating a Super VCD / Video CD through on-screen menus recorded onto the disc. Especially good for discs that you would normally not watch from beginning to end all at once—karaoke discs, for example.

Progressive scan video

Also called non-interlaced video, this method of displaying a picture updates all the lines in one pass, resulting in one pass, resulting in a more stable, flicker-free image than interlaced video (for a given scanning rate). See also interlaced video.

Regions (DVD only)

These associate discs and players with particular areas of the world. This unit will only play discs that have compatible region codes. You can find the region code of your unit by looking on the rear panel. Some discs are compatible with more than one region (or all regions).

Sampling frequency

The rate at which sound is measured to be turned into digital audio data. The higher the rate, the better the sound quality, but the more digital information is generated. Standard CD audio has a sampling frequency of 44.1kHz, which means 44,100 samples (measurements) per second. See also Digital audio.

Title (DVD-Video only)

A collection of chapters on a DVD-Video disc.

Track

Audio CDs and Super Video CDs / Video CDs discs all use tracks to divide up the content of a disc. The DVD-Video equivalent is called a chapter. See also Chapter.

TROUBLESHOOTING

Incorrect operation is often mistaken for trouble or malfunction. If you think that there is something wrong with this component, check the points below. Sometimes the trouble may lie in another component. Inspect the other components and electrical appliances being used. If the trouble cannot be rectified after checking the items below, ask your nearest MARANTZ authorized service center or your dealer to carry out repair work.

The disc is ejected automatically after loading.

- **Dirty or damaged disc.**
See pages 37 for disc care information.
- **Disc not seated properly in the disc guide.**
Align the disc properly.
- **Incompatible region number.**
If the region number on a DVD-Video disc does not match the number on the player, the disc cannot be used (page 4).
- **Condensation inside the player.**
Allow time for condensation to evaporate. Avoid using the player near an air-conditioning unit.

Playback is not possible.

- **Disc is loaded upside down.**
Reload the disc with the label side face up.
- **A Super VDC is does not conform with the IEC.**
standard might not play normally.

⊖ mark appears on screen.

- The operation is prohibited by the player and / or disc.

Picture playback stops and the operation buttons cannot be used.

- Press **■**, then start playback again (**▶**).
- Switch the power off once using the front panel POWER button and then switch on again using the front panel POWER button.

New settings made in the Setup screen menus while a disc is playing are ineffective.

- Some settings can be changed while a disc is playing, but are not effective until the disc is stopped then restarted. This is not a malfunction.
Make the same setting when the player is stopped.

Settings are canceled.

- When the power is cut due to power failure or by unplugging the power cord, settings will be canceled. Before unplugging the power cord, press POWER button and checking that STANDBY indicator light on the front panel.

No picture / No color

- Incorrect video connections.
Check that connections are correct and that plugs are inserted fully.
- TV/monitor or AV amplifier settings are incorrect.
Check the instruction manual of the connected equipment.
- The VIDEO-Progressive menu is set to ON but your TV/monitor is not compatible with progressive scan.
Reconnect the player to your TV using a composite or S-Video cord and set the TV to appropriate input. Now choose the OFF setting in the VIDEO-progressive menu, then switch the TV input back to the component input.
Or Push stop button for longer than 5 sec to set progressive scan setting into OFF.

Screen is stretched or aspect does not change.

- The TV ASPECT setting in the Setup menu is incorrect.
Set the TV ASPECT option to match the TV/monitor you're using (pages 33).

Picture disturbance during playback or dark.

- This player is compatible with Macro-Vision System copy guard. Some discs include a copy prevention signal, and when this type of disc is played back, stripes etc., may appear on some sections of the picture depending on the TV. This is not a malfunction.
- Discs respond differently to particular player functions. This may result in the screen becoming black for a brief instant or shaking slightly when the function is executed. These problems are largely due to differences between discs and disc content and are not malfunctions of this player.
- The TV type may be set in appropriately. See setting the TV type on page 34.
- When using progressive scan. If your TV is connected using COMPONENT VIDEO OUT Jack, set the PROGRESSIVE menu to OFF (page 34).

When recorded on a VCR or passed through an AV selector, there is disturbance in the playback picture.

- Due to the player's copy protection circuits, connection of this device through a VCR or an AV selector may prevent recording or cause picture problems.
This is not a malfunction.

The remote control doesn't seem to work.

- The Control In jack on the rear panel is connected.
Check that REMOTE CONTROL SW is set to the external position (page 9).
- The remote control is too far from the player, or the angle with the remote sensor is too wide.
Use the remote within its operating range (page 3).
- The batteries are exhausted.
Put in new batteries (page 3).
- Check that REMOTE CODE setting is set to the correct position (page 15).

No audio, or audio is distorted.

- **Some DVD discs do not output digital audio.**
Switch your amplifier to the player's analog outputs.
- **Dirt, dust, etc. on the disc.**
Clean the disc (page 37).
- **Interconnects are not fully inserted into the terminals (or are not connected).**
Check that all interconnects are firmly inserted.
- **Dirty or oxidized plugs/terminals.**
Clean the plugs/terminals.
- **Incorrect audio cable connection.**
Check the audio connections (page 7).
- **Player's output is connected to the amplifier's phono (turntable) inputs.**
Connect to any set of inputs except phono.
- **The disc is paused.**
Press ► (play) to exit the pause mode.
- **Incorrect amplifier settings.**
Check that the volume is turned up, that the speakers are on, the input function set correctly, etc.

The analog audio is OK, but there appears to be no digital audio signal.

- **Incorrect Audio menu settings.**
Make sure that the Digital Out setting is set to BITSTREAM or PCM (page 32).
Check that the BITSTREAM and PCM settings are suitable for your amplifier —check the amp's instruction manual.

Noticeable difference in DVD and CD volume.

- DVDs and CDs use different recording methods.
This is not a malfunction.

No DTS audio output.

- If this unit is connected to a non-DTS compatible amplifier or decoder using a digital audio cable, please connect to a DTS compatible amplifier or decoder. If you do not do this, noise will be output if you try and play a DTS disc.
- If this unit is connected to a DTS-compatible amplifier or decoder using a digital audio cable, check the amplifier settings, and that the cable is properly connected.

The disc containing the MP3 tracks won't play.

- If the disc is a recordable CD, make sure that the disc is finalized.
Check that the track(s) are in the MPEG1 Audio Layer 3 format.
Check that the sampling rate of the track(s) are 32 or 44.1 or 48kHz.

Some MP3 tracks appear to be missing from a disc.

- If a track name does not end in ".mp3" or ".MP3", this player will not recognize it as an MP3 track.
- This player only recognizes the first 126 folders and 255 tracks on a disc. If there are more folders/tracks than this, you will not be able to play them.

Note

Static electricity or other external influences may cause malfunctioning of this unit. In this case, unplug the power cord and then plug back in. This will usually reset the unit for proper operation. If this does not correct the problem, please consult your nearest MARANTZ service center.

SPECIFICATIONS

General

System DVD-Video, DVD-R
 Super VCD, Video-CD
 CD and MP3 files

Power requirements AC 100 V- 240 V, 50/60 Hz
 Power consumption 14 W
 Weight 6.6 lbs
 3 kg

Dimensions 17 5/16 (W) x 2 2/16 (H) x 11 (D) inch
 440 (W) x 54 (H) x 280 (D) mm

Operating temperature +5°C to +35°C
 Operating humidity 5% to 85% (no condensation)

S-Video output

Y (luminance) - Output level 1 Vp-p (75 Ω)
 C (color) - Output level 286 mVp-p (75 Ω)
 Jacks S-VIDEO jack

Video output

Output level 1 Vp-p (75 Ω)
 Jacks RCA jack
 Component video output (Y, Cb/Pb, Cr/Pr)
 Output level Y: 1.0 Vp-p (75 Ω)
 Cb/Pb, Cr/Pr: 0.7 Vp-p (75 Ω)
 Jacks RCA jacks

Audio output

Output level
 During audio output 200 mVrms (1 kHz, -20 dB)
 Number of channels 2
 Jacks RCA jack

Audio characteristics

Frequency response 4 Hz to 44 kHz (DVD fs: 96 kHz)
 S/N ratio 101 dB
 Dynamic range 100 dB
 Total harmonic distortion 0.003 %
 Wow and flutter
 Limit of measurement (±0.001% W. PEAK) or lower

Digital output

Optical digital output Optical digital jack
 Coaxial digital output RCA jack

Accessories

Audio/Video cable 1
 System control cable 1
 Remote control unit 1
 "AAA" size (R03) batteries 2
 Operating Instructions 1
 Warranty card 1

Note: The specifications and design of this product are subject to change without notice, due to improvement.

Dimensions

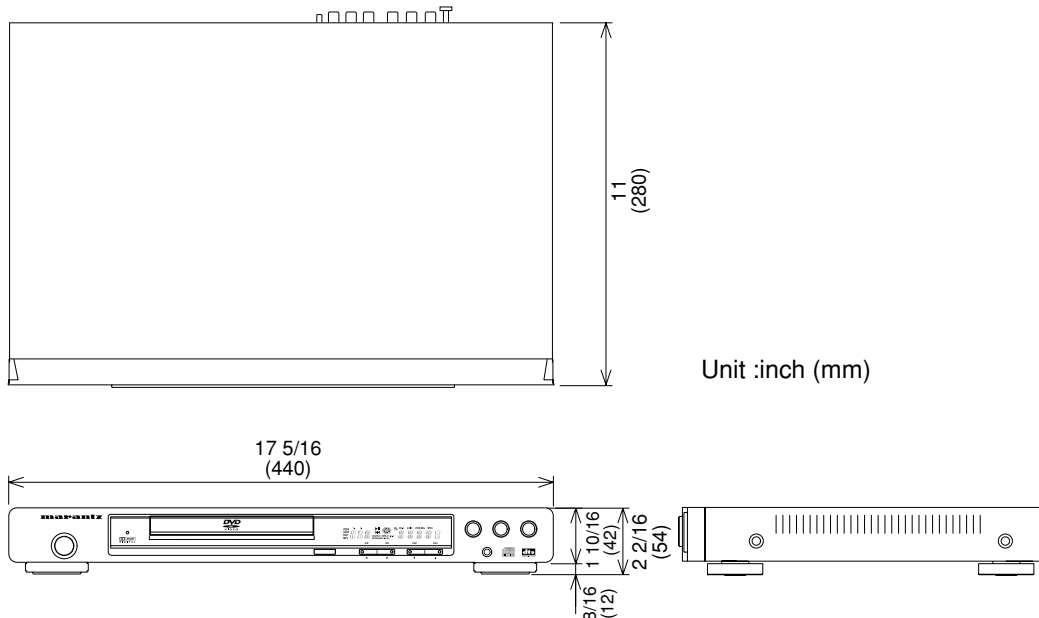

Limited Warranty

Your Marantz Professional product is warranted against manufacturer defect for period of one year parts and labor.

Except as specified below this warranty covers defects in material and workmanship. The following are not covered under warranty.

1. a) Damage, deterioration, malfunction or failure to meet performance specification resulting from:
 - b) Accidents, acts of nature, misuse, abuse, neglect or unauthorized product modification.
 - c) Improper installation, removal or maintenance, or failure to follow supplied instruction.
 - d) Repair or attempted repair by a non Marantz authorized agent.
 - e) Any shipment of the product (claims must be presented to the carrier).
 - f) Any cause other than a defect in manufacturing.
2. Cleaning, check-ups with no fault found, or changes incurred for installation, removal or reinstallation of the product.
3. Any serialized product on which the serial number has been defaced, modified or removed.
4. Batteries and battery chargers.
5. Accessories, including but not limited to, cables, mounting hardware and brackets, cleaning accessories, power cords and adaptors, and carry cases.
6. Product purchased outside the United States, its possessions or territories.

Non-Transferable Warranty

This warranty may be enforced only by the original purchaser.

What We Will Pay For

We will pay for all labor and material expense for items covered by the warranty.

How You Can Get Service

1. If your unit needs service, contact our service referral at the appropriate telephone number indicated below. We will advise you of the name and location of one or more warranty authorized service centers from which service may be obtained. Please do not return your unit directly to us.
2. You must pay any shipping charges if it is necessary to ship the product for service. If the necessary repairs are covered by the warranty, we will pay the return shipping charges to your location anywhere in the United States or its territories.
3. Whenever warranty service is required, you must present the original dated sales receipt or other proof of date purchased.

Limitation of Implied Warranties

All implied warranties, including warranties of merchantability and fitness for a particular purpose, are limited in duration to the length of this warranty.

Exclusion of Damages

Liability for any defective product is limited to repair or replacement of the product at manufacturer's option. Manufacturer shall not be liable for damage to other products caused by any defects in Marantz products, damages based upon inconvenience or loss of use of the product, or any other damages, whether incidental, consequential, or otherwise.

Some states do not allow limitations on how long an implied warranty lasts and/or do not allow the exclusion or limitation of incidental or consequential damages, so the above limitations and exclusions may not apply to you.

How State Law Relates to the Warranty

This warranty gives you specific legal rights, and you may have other rights which may vary from state to state.

Marantz Professional Service Number:

Marantz Professional Factory Service (630) 820-4800

This warranty is enforceable only in the United States and its possessions and territories.

marantz[®] is a registered trademark.

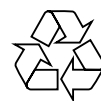

Free Manuals Download Website

<http://myh66.com>

<http://usermanuals.us>

<http://www.somanuals.com>

<http://www.4manuals.cc>

<http://www.manual-lib.com>

<http://www.404manual.com>

<http://www.luxmanual.com>

<http://aubethermostatmanual.com>

Golf course search by state

<http://golfingnear.com>

Email search by domain

<http://emailbydomain.com>

Auto manuals search

<http://auto.somanuals.com>

TV manuals search

<http://tv.somanuals.com>