

# marantz®

**Model SA7001 / SA7001 KI User Guide**

---

Super Audio CD Player

CLASS 1 LASER PRODUCT  
LUOKAN 1 LASERLAITE  
KLASS 1 LASERAPPARAT

  
SUPER AUDIO CD

**COMPACT**  
**disc**  
**DIGITAL AUDIO**

## ENGLISH

### **WARRANTY**

For warranty information, contact your local Marantz distributor.

### **RETAIN YOUR PURCHASE RECEIPT**

Your purchase receipt is your permanent record of a valuable purchase. It should be kept in a safe place to be referred to as necessary for insurance purposes or when corresponding with Marantz.

### **IMPORTANT**

When seeking warranty service, it is the responsibility of the consumer to establish proof and date of purchase. Your purchase receipt or invoice is adequate for such proof.

### **FOR U.K. ONLY**

This undertaking is in addition to a consumer's statutory rights and does not affect those rights in any way.

## FRANÇAIS

### **GARANTIE**

Pour des informations sur la garantie, contacter le distributeur local Marantz.

### **CONSERVER L'ATTESTATION D'ACHAT**

L'attestation d'achat est la preuve permanente d'un achat de valeur. La conserver en lieu sûr pour s'y reporter aux fins d'obtention d'une couverture d'assurance ou dans le cadre de correspondances avec Marantz.

### **IMPORTANT**

Pour l'obtention d'un service couvert par la garantie, il incombe au client d'établir la preuve de l'achat et d'en corroborer la date. Le reçu ou la facture constituent des preuves suffisantes.

## DEUTSCH

### **GARANTIE**

Bei Garantiefragen wenden Sie sich bitte an Ihren Marantz-Händler.

### **HEBEN SIE IHRE QUITTING GUT AUF**

Die Quittung dient Ihnen als bleibende Unterlage für Ihren wertvollen Einkauf. Das Aufbewahren der Quittung ist wichtig, da die darin enthaltenen Angaben für Versicherungswecke oder bei Korrespondenz mit Marantz angeführt werden müssen.

### **WICHTIG!**

Bei Garantiefragen muß der Kunde eine Kaufunterlage mit Kaufdatum vorlegen. Ihre Quittung oder Rechnung ist als Unterlage ausreichend.

## NEDERLANDS

### **GARANTIE**

Voor inlichtingen omtrent garantie dient u zich tot uw plaatselijke Marantz.

### **UW KWITANTIE, KASSABON E.D. BEWAREN**

Uw kwitantie, kassabon e.d. vormen uw bewijs van aankoop van een waardevol artikel en dienen op een veilige plaats bewaard te worden voor evt. verwijzing bijv. in verband met verzekering of bij correspondentie met Marantz.

### **BELANGRIJK**

Bij een evt. beroep op de garantie is het de verantwoordelijkheid van de consument een gedateerd bewijs van aankoop te tonen. Uw kassabon of factuur zijn voldoende bewijs.

## ESPAÑOL

### **GARANTIA**

Para obtener información acerca de la garantía póngase en contacto con su distribuidor Marantz.

### **GUARDE SU RECIBO DE COMPRA**

Su recibo de compra es su prueba permanente de haber adquirido un aparato de valor. Este recibo deberá guardarlo en un lugar seguro y utilizarlo como referencia cuando tenga que hacer uso del seguro o se ponga en contacto con Marantz.

### **IMPORTANTE**

Cuando solicite el servicio otorgado por la garantía el usuario tiene la responsabilidad de demostrar cuándo efectuó la compra. En este caso, su recibo de compra será la prueba apropiada.

## ITALIANO

### **GARANZIA**

L'apparecchio è coperto da garanzia di buon funzionamento della durata di un anno, o del periodo previsto dalla legge, a partire dalla data di acquisto comprovata da un documento attestante il nominativo del Rivenditore e la data di vendita. La garanzia sarà prestata con la sostituzione o la riparazione gratuita delle parti difettose.

Non sono coperti da garanzia difetti derivanti da uso improprio, errata installazione, manutenzione effettuata da personale non autorizzato o, comunque, da circostanze che non possano riferirsi a difetti di funzionamento dell'apparecchio. Sono inoltre esclusi dalla garanzia gli interventi inerenti l'installazione e l'allacciamento agli impianti di alimentazione.

Gli apparecchi verranno riparati presso i nostri Centri di Assistenza Autorizzati. Le spese ed i rischi di trasporto sono a carico del cliente.

La casa costruttrice declina ogni responsabilità per danni diretti o indiretti provocati dalla inosservanza delle prescrizioni di installazione, uso e manutenzione dettagliate nel presente manuale o per guasti dovuti ad uso continuato a fini professionali.

## SVENSKA

### **GARANTI**

För information om garantin, kontakta Marantz lokagent.

### **SPAR KVITTOT**

Kvittot är ett inköpsbevis på en värdefull vara. Det skall förvaras säkert och hänvisas till vid försäkringsfall eller vidkorrespondens med Marantz.

### **VIKTIGT**

Fö att garantin skall gälla är det kundens sak att framställa bevis och datum om köpet. Kvitto eller faktura är tillräckligt bevis för detta.

# CE MARKING

- English**  
The SA7001 is in conformity with the EMC directive and low-voltage directive.
- Français**  
Le SA7001 est conforme à la directive EMC et à la directive sur les basses tensions.
- Deutsch**  
Das Modell SA7001 entspricht den EMC-Richtlinien und den Richtlinien für Niederspannungsgeräte.
- Nederlands**  
De SA7001 voldoet aan de EMC eisen en de vereisten voor laag-voltage.
- Español**  
El SA7001 está de acuerdo con las normas EMC y las relacionadas con baja tensión.
- Italiano**  
Il SA7001 è conforme alle direttive CEE ed a quelle per i bassi voltaggi.
- Svenska**  
SA7001 är tillverkad i enlighet med EMC direktiven och direktiven för lågvoltsutrustning.

## English

### WARNINGS

- Do not expose the equipment to rain or moisture.
- Do not remove the cover from the equipment.
- Do not insert anything into the equipment through the ventilation holes.
- Do not handle the mains cord with wet hands.
- Do not cover the ventilation with any items such as tablecloths, newspapers, curtains, etc.
- No naked flame sources, such as lighted candles, should be placed on the equipment.
- When disposing of used batteries, please comply with governmental regulations or environmental public instruction's rules that apply in your country or area.
- Make a space of about 0.1 meter around the unit.
- No objects filled with liquids, such as vases, shall be placed on the apparatus.
- When the switch is in the OFF position, the equipment is not completely switched off from MAINS.

## Français

### AVERTISSEMENTS

- Ne pas exposer l'appareil à la pluie ni à l'humidité.
- Ne pas essayer de retirer le boîtier de l'appareil.
- Ne rien insérer dans l'appareil par les orifices de ventilation.
- Ne pas manipuler le cordon d'alimentation avec les mains mouillées.
- Ne pas recouvrir les ouïes de ventilation avec un objet quelconque comme une nappe, un journal, un rideau, etc.
- Ne placer aucune source de flamme nue, comme une bougie allumée, sur l'appareil.
- Pour mettre au rebut les piles usées, respecter les lois gouvernementales ou les règlements officiels concernant l'environnement qui s'appliquent à votre pays ou région.
- Veiller à ce qu'aucun objet ne soit à moins de 0,1 mètre des côtés de l'appareil.
- Aucun objet rempli de liquide, un vase par exemple, ne doit être placé sur l'appareil.
- Lorsque l'interrupteur est sur la position OFF, l'appareil n'est pas complètement déconnecté du SECTEUR (MAINS).

## Deutsch

### WARNHINWEISE

- Das Gerät nicht Regen oder Feuchtigkeit aussetzen.
- Die Abdeckung nicht vom Gerät abnehmen.
- Keine Gegenstände durch die Belüftungsschlitze stecken.
- Das Netzkabel nicht mit feuchten oder nassen Händen anfassen.
- Decken Sie die Lüftungsöffnungen nicht mit einem Tischtuch, einer Zeitung, einem Vorhang usw. ab.
- Es dürfen keine Gegenstände mit offener Flamme, wie etwa brennende Kerzen, auf dem Gerät aufgestellt werden.
- Beachten Sie bei der Entsorgung der verbrauchten Batterien alle geltenden lokalen und überregionalen Regelungen.
- Auf allen Geräteseiten muß ein Zwischenraum von ungefähr 0,1 meter vorhanden sein.
- Auf das Gerät dürfen keine mit Flüssigkeiten gefüllte Behälter, wie etwa eine Vase, gestellt werden.
- Wenn der Schalter ausgeschaltet ist (OFF-Position), ist das Gerät nicht vollständig vom Stromnetz (MAINS) abgetrennt.

## Nederlands

### WAARSCHUWINGEN

- Stel het apparaat niet bloot aan regen of vocht.
- Verwijder de afdekplaat van het apparaat niet.
- Duw niets door de ventilatieopeningen in het apparaat.
- Raak het netsnoer niet met natte handen aan.
- Bedek de ventilatieopeningen niet met enige voorwerpen, zoals tafelkleden, kranten, gordijnen, enz.
- Plaats geen brandende voorwerpen, zoals kaarsen, op het apparaat.
- Volg bij het weggooien van verbruikte batterijen de overheidswetgeving of milieuvoorschriften op die van kracht zijn in het land of de regio waarin u zich bevindt.
- Zorg dat er 0,1 meter vrije ruimte rond het toestel is.
- Plaats geen voorwerpen met een vloeistof erin, zoals een bloemenvaas, op het apparaat.
- Als de schakelaar op OFF staat, is het apparaat niet volledig losgekoppeld van de netspanning (MAINS).

## **Español**

### **ADVERTENCIAS**

- No exponga el equipo a la lluvia ni a la humedad.
- No extraiga la tapa del equipo.
- No introduzca nada en el interior del equipo a través de los orificios de ventilación.
- No maneje el cable de alimentación con las manos mojadas.
- No cubra la ventilación con objetos como manteles, periódicos, cortinas, etc.
- No deben colocarse sobre el equipo elementos con fuego, por ejemplo velas encendidas.
- Cuando se eliminen baterías usadas, deben cumplirse las reglamentaciones oficiales o las normas de protección medioambiental aplicables en su país o en su zona.
- Deje un espacio de unos 0,1 metro alrededor de la unidad.
- No se deben colocar sobre el aparato recipientes que contengan líquidos, como por ejemplo jarrones.
- Cuando el interruptor está en la posición OFF, el equipo no está completamente desconectado de la alimentación MAINS.

## **Italiano**

### **AVVERTENZE**

- Non esporre l'apparecchio alla pioggia o all'umidità.
- Non rimuovere il coperchio dell'apparecchio.
- Non introdurre oggetti all'interno dell'apparecchio attraverso i fori di ventilazione.
- Non toccare il cavo di alimentazione con le mani bagnate.
- Non coprire le fessure di ventilazione con tovaglie, giornali, tende od oggetti analoghi.
- Non posare sull'apparecchio sorgenti di fiamme scoperte quali candele accese.
- Smaltire le pile usate in conformità alle norme governative o disposizioni ambientali vigenti nel proprio paese o zona.
- Lasciare 0,1 metro liberi tutto intorno l'unità.
- Non mettere sull'apparecchiatura alcun contenitore di liquido, come ad esempio dei vasi.
- Quando l'interruttore è nella posizione OFF, l'apparecchiatura non è completamente scollegata da MAINS.

## **Svenska**

### **VARNINGAR**

- Utsätt inte utrustningen för regn eller fukt.
- Ta inte bort utrustningens hölje.
- För inte in föremål i utrustningen genom ventilationshålen.
- Hantera inte nätsladden med våta händer.
- Täck inte för ventilationsöppningarna med några föremål som till exempel bordsdukar, dagstidningar, gardiner e.d.
- Inga föremål med öppen låga, som till exempel tända stearinljus, bör placeras på utrustningen.
- Följ de lagar och miljöskyddsråd som gäller i det land eller område där du bor när du gör dig av med batterier.
- Se till att det finns omkring 0,1 meter fri plats runt omkring enheten.
- Inga objekt som är fyllda med någon vätska, till exempel blomstervaser, bör placeras på apparaten.
- Även om strömbrytaren står i det avstängda läget OFF, så är utrustningen inte helt bortkopplad från det elektriska nätet (MAINS).

# CONTENTS

<b>FOREWORD</b> .....	<b>1</b>	<b>OPERATION</b> .....	<b>9</b>
EQUIPMENT MAINS WORKING SETTING ..	1	CONNECTING THE POWER SUPPLY .....	9
COPYRIGHT .....	1	NORMAL PLAYBACK .....	9
<b>INTRODUCTION</b> .....	<b>2</b>	START SOUND MODE .....	10
PRODUCT FEATURES .....	2	PLAYING YOUR FAVORITE TRACKS OF A	
ABOUT SUPER AUDIO .....	2	DISC .....	10
PLAYING CD-RW DISCS .....	2	PLAYING YOUR FAVORITE PARTS OF A	
APPLICABLE DISCS TO THE UNIT .....	2	DISC (SEARCH) .....	10
<b>BEFORE USING</b> .....	<b>2</b>	REPEATED DISC PLAY (REPEAT PLAY) ...	10
NOTES ABOUT THE DISCS .....	2	PLAYING TRACKS IN A RANDOM	
INAPPROPRIATE PLACES FOR INSTALLATION ..	3	SEQUENCE (RANDOM PLAY) .....	10
PRECAUTIONS .....	3	PLAYING TRACKS IN A SPECIFIC	
USING REMOTE CONTROL UNIT .....	3	SEQUENCE (PROGRAM PLAY) .....	11
LOADING BATTERIES .....	3	SEARCHING YOUR FAVORITE TRACKS	
<b>NAMES AND FUNCTIONS</b> .....	<b>4</b>	(AMS (AUTOMATIC MUSIC SCAN) PLAY) ..	11
FRONT PANEL .....	4	QUICK REPLAY .....	11
REMOTE CONTROLLER .....	5	ABOUT THE TEXT INFORMATION DISPLAY ...	12
REAR PANEL .....	6	TIMER PLAY .....	12
DISPLAY .....	7	<b>TROUBLE SHOOTING</b> .....	<b>12</b>
<b>CONNECTIONS</b> .....	<b>8</b>	<b>SPECIFICATIONS</b> .....	<b>13</b>

# FOREWORD

This section must be read before any connection is made to the mains supply.

## EQUIPMENT MAINS WORKING SETTING

Your Marantz product has been prepared to comply with the household power and safety requirements that exist in your area. SA7001 can be powered by 230V AC only.

## COPYRIGHT

Recording and playback of any material may require consent. For further information refer to the following:

- Copyright Act 1956
- Dramatic and Musical Performers Act 1958
- Performers Protection Acts 1963 and 1972
- Any subsequent statutory enactments and orders

# A NOTE ABOUT RECYCLING



This product's packaging materials are recyclable and can be reused. This product and the accessories packed together are the applicable product to the WEEE directive except batteries.

Please dispose of any materials in accordance with your local recycling regulations.

When discarding the unit, comply with your local rules or regulations.

Batteries should never be thrown away or incinerated but disposed of in accordance with your local regulations concerning chemical wastes.

## INTRODUCTION

Thank you for selecting the Marantz SA7001 Super Audio CD Player for your Audio system.

This Player incorporates a number of features designed to enhance the listening of your favorite audio sources.

Please read these operating instructions carefully. We recommend that you read the entire user guide before you attempt to connect or operate the player. After you have reviewed the contents of this manual, we suggest that you make all system connections before you attempt to operate the unit.

## PRODUCT FEATURES

This unit can playback the outstanding sound performance in Super Audio CD. This unit has the following unique features.

- Low-noise low-distortion filter circuit and high-speed current-feedback-type output amplifier with the differential input type HDAM.
- Text information display function that can display disc titles, track titles etc. in Super Audio CD.
- CD-R/CD-RW discs can be played.

### SA7001 KI Version Features

Compared to the SA7001, the SA7001 KI version contains the following upgrades.

- **Newly Developed Toroidal Transformer**  
A newly developed Toroidal power transformer, which produces less vibration and magnetic leakage flux than previously, has been incorporated. The materials and manufacturing process of the ring-shaped core are strictly controlled to reduce vibration, while the short-ring attached to the perimeter of the transformer reduce magnetic leakage flux.
- **Large Capacitance Block Capacitor**  
A large capacity 3300 $\mu$ F block capacitor is incorporated into the power supply circuit.
- **Film capacitors and electrochemical capacitors etc.**  
The capacitors used in high end models are incorporated into the SA7001 Super Audio CD player.
- **Copper-coated Chassis**
- **High Grade Audio Output Terminal**

## ABOUT SUPER AUDIO

The Super Audio standard is based on Direct Stream Digital (DSD) technology. This new direct-stream digital format comprises a 1-bit system that has a digital sampling frequency that is 64 times higher than that of conventional audio CD. The results are spectacular: a frequency response of over 100k Hz and a 120 dB dynamic range over the entire audible spectrum. Mixed with as many of the original frequencies as possible, the audio information audible for human ears sounds much more natural. All audible frequencies are, after all, embedded in the frequency range as emitted by the sound source. A better reproduction does not exist! For the first time your ears will relive reality.

## PLAYING CD-RW DISCS

This unit can play back the CD-RW (ReWritable) discs as well as ordinary Audio CD and CD-R (Recordable) discs.

- The CD-R and CD-RW discs should contain properly-recorded TOC information so that they can be played back. In CD recorders, the task of writing TOC information is referred to as finalizing the disc. Discs that are not finalized cannot be properly recognized as an Audio CD and played back by regular CD players and Super Audio CD players. For details, please read the instruction manual provided with a CD recorder.

- \* TOC stands for Table Of Contents and contains information such as the total number of tracks and total playing time of the disc.
- This unit can play only the discs recorded in the CD-DA format designed for music reproduction. Do not attempt to play a disc containing other data, such as a CD-ROM for PCs, on this unit.
- As the playback of a CD-RW disc necessitates partial change of the player setup, it may take longer time for reading the TOC information than when an Audio CD or CD-R disc is played.

## APPLICABLE DISCS TO THE UNIT

### 1. Super Audio CD



There are three types of Super Audio CDs.

- **Single-layer Disc**
- **Dual-layer Disc**
- **Hybrid-layer Disc**

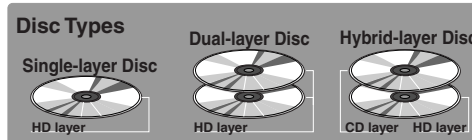

And each type may contain two areas of recorded information.

- **High quality stereo area**
- **High quality multi-channel area\*\***
- **Single Layer Disc**  
It can contain both high quality stereo area and high quality multi-channel area\*\* information.
- **Dual Layer Disc**  
It can contain both high quality stereo area and high quality multi-channel area\*\* information. And a double amount of information can be stored on the disc thanks to the second layer.
- **Hybrid Layer Disc**  
Not only does this disc contain both high sound quality stereo area and high sound quality multi-channel area\*\* information, it also has a CD layer in the second layer, so it can be played on a CD player.

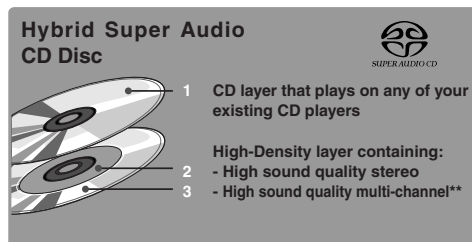

The number of tracks recorded may vary per layer. It will be shown on the display window of the unit.

\*\* This unit is a stereo-only player, and so it cannot play high-quality multi-channel audio areas. (It does not recognize multi-channel areas.)

### 2. Audio CD (CDDA)



Audio CDs contain music tracks only.

## BEFORE USING

### NOTES ABOUT THE DISCS

- \* **Handle the discs carefully so as not to scratch their surfaces.**
- \* **Keep the surfaces of the discs clean at all times.**  
When cleaning the surfaces of discs, always be sure to use the special cleaner and wipe the surfaces in the directions shown in the figure below.

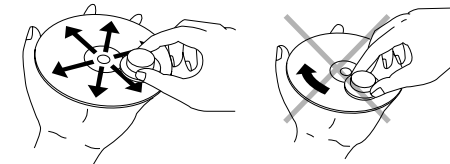

- Wipe the surface radially from the center.
- Do not wipe the surface in the circumferential direction.

- \* **Do not attach pieces of paper or stickers to the label surfaces of the discs.**

When a disc has a piece of plastic tape or rental CD label with paste protruding from the edge or when a disc still bears traces of sticky tape or adhesive labels, do not attempt to play it. If such a disc is played on the CD player, you may find that you cannot remove it or that some other kind of malfunctioning may occur.

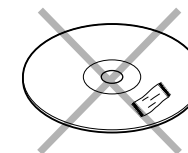

- \* **Do not use discs which come in special shapes.**

Do not attempt to play heart-shaped or octagonal discs or discs with any other special shapes. You may find that you cannot remove them or that some other kind of malfunctioning may occur in the player.

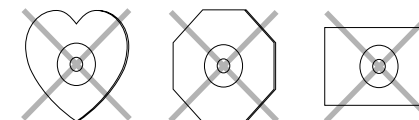

- \* **Use discs which satisfy the CD standards such as those with the "CD logo" or "compact disc" mark on their disc label surfaces.**

No guarantees are made for playback if discs which do not satisfy the appropriate CD standards are used.

Similarly, no guarantees are made for their sound quality even if it is possible to play such discs.



- \* **To protect your discs from damage, avoid placing them in the following locations.**
  - Where they will be exposed to direct sunlight or where they will be close to a heater or other heat-radiating appliance
  - Where the humidity level is high or it is very dusty
  - Near a window or other such location where they may be exposed to rain
- \* **Get into the habit of putting the discs back in their cases after use.**

### INAPPROPRIATE PLACES FOR INSTALLATION

To keep your player in perfect working order for the longest possible time, avoid installing the player in the following locations.

- Wherever it will be exposed to direct sunlight
- Wherever it will be close to a heater or other heat-radiating appliance
- Wherever the humidity is high or ventilation is poor
- Wherever it is very dusty
- Wherever it will be subject to vibration
- On top of a rickety stand or in an unstable location which is tilted at an angle
- In an audio rack with little space at the top and bottom or other location where the heat dissipation will be obstructed

To ensure proper heat dissipation, install the player while leaving clearances between the player and wall or other components, as shown in the figure below.

- On top of an amplifier or other component which dissipates a great deal of heat
- \* **The quality of the laser and other components can be harmed if the player is placed directly on top of an amplifier or other device which generates heat.**

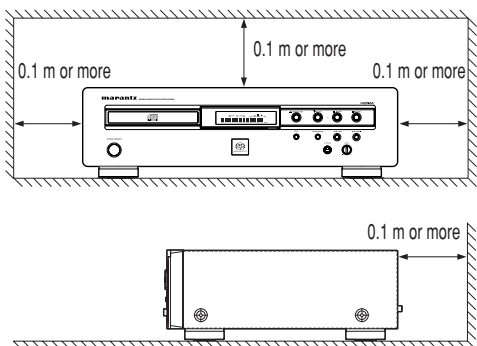

### Do not place objects on top

- Refrain from placing any objects on top of the player.

### Cautions on handling power cord

- Do not touch the power cord with wet hands.
- When disconnecting the power cord, always make sure that you take hold of the plug. Yanking out or bending the cord can damage it and/or cause electric shocks or a fire.
- Get into the habit of disconnecting the power plug before leaving home.

### Do not attempt repairs yourself

- Refrain from lubricating the player: doing so can cause malfunctioning.
- Only qualified engineers with specialized expertise are authorized to repair the pick-up and parts inside the player.

### PRECAUTIONS

- In winter, droplets of water form on the insides of the windows of a heated room: this is called condensation. This player uses an optical lens, so the condensation may form in the following cases.
  - In a room immediately after the heating has been turned on
  - In a room where the humidity level is high
  - When the player has been suddenly brought from a cold location into a warm room

Since, in cases like this, the track numbers may not be read and the player is prevented from operating properly, wait about 30 minutes, and then operate the player.

- This player may cause interference on a tuner or TV set. If this is the case, place it further away from the tuner or TV set.
- Compact discs have much less noise than analog records and hardly any noise is heard before play starts. Bear in mind, therefore, that if the volume control on the amplifier is set too high, you will risk damaging other audio components.
- This player is designed to play Super Audio CD and normal Audio CDs only. It cannot play CD-ROMs used with personal computers, game CDs, video CDs or DVDs (video/audio).
- We do not recommend the use of lens cleaners.

### USING REMOTE CONTROL UNIT

#### Cautions on handling batteries

Misuse of the batteries can result in electrolyte leakage, rupturing, corrosion, etc. Bear in mind the following points when using batteries.

- Remove the batteries from the remote control unit if the unit is not going to be used for a prolonged period (a month or more).
- Do not use an old battery together with a new one.
- Insert the batteries while ensuring that their ⊕ and ⊖ poles are properly aligned with the corresponding markings on the remote control unit.
- Batteries with the same shape may have different voltages. Do not use different types of batteries together.
- If electrolyte has leaked, thoroughly wipe the inside of the battery compartment, and then insert new batteries.
- When batteries which are no longer required are to be discarded, follow the directions (regulations) laid down by the local authorities in the area concerned for their disposal.

- Insert the batteries with correct +/- orientation.

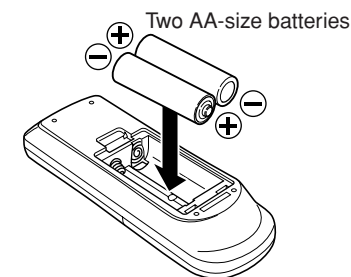

- Close the battery cover until it clicks shut.

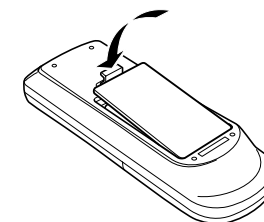

### Remote control

Operate the remote control unit (RC7001SA) within a distance of approx. 5 m from the infrared signal reception window (remote sensor) on the front of the Super Audio CD player.

Remote control operation may not be possible if the remote control unit's transmitter is not pointing in the direction of the remote sensor or if there is an obstruction between the transmitter and the remote sensor.

Remote control operating range

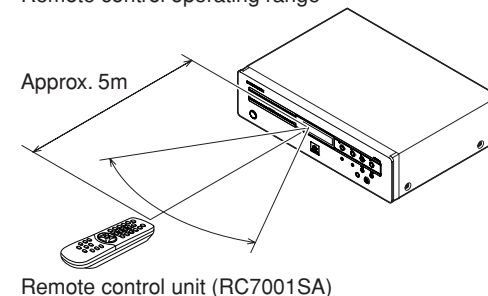

### LOADING BATTERIES

Batteries in this remote control unit have a life of approximately 1 year under normal operating conditions. If the remote control unit is not going to be used for an extended period of time, remove the batteries. Also, if you notice that the batteries are starting to run down, replace them as soon as possible.

- Remove the battery cover.

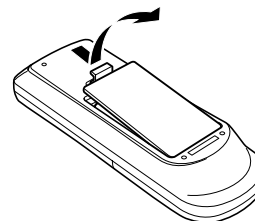

# NAMES AND FUNCTIONS

## FRONT PANEL

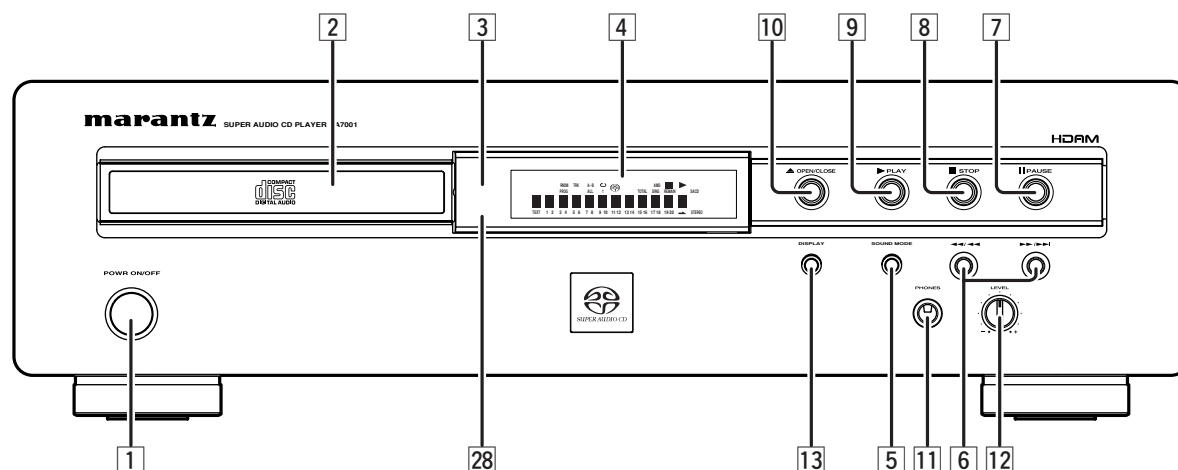

### 1 POWER ON/OFF switch

This switch is used to turn the power ON and OFF. When it is pressed, the display window lights up, and the power comes on. When it is pressed again, the display window is extinguished, and the power goes off.

### 2 Disc tray

The disc to be played is placed on the tray.  
\* Close the tray by pressing the operation button, not by pressing it in with your hand.

### 3 Remote sensor

The infrared control signal emitted from the remote control unit are sensed here.

### 4 Display window

This screen shows the operating status.

### 5 SOUND MODE button

Press this button to select the Super Audio CD sound mode. Super Audio CD (stereo) or Audio CD (if discs are supported) (See page 9)

### 6 <<</>>>, >>>/<<< buttons

#### (Track Skip/Search buttons)

These buttons can be used as both track skip and track search buttons. (The buttons on the main unit only.)

>>>/<<< : Each time this button is pressed, the track being played is skipped forward. When this button is held down, tracks are searched forward (Fast Forward).

<<</>>> : When this button is pressed, the unit goes back to the beginning of the current track. If the button is pressed more times, the track being played is skipped back. When this button is held down, tracks are searched backward (Fast Rewind).

In program play, Fast Forward and Fast Rewind can be done in the playing track only.

### 7 PAUSE button

Press this button to pause playback. If pressed again, the unit returns to playback.

### 8 STOP button

Press this button to stop playback. Also this button is used to clear all programs.

### 9 PLAY button

Press this button to start playback.

### 10 OPEN/CLOSE button

Press this button to open the tray. Put on a disc label side up. Press the button again to close the tray.

### 11 PHONES (headphones) jack

The headphones are connected to this jack.  
\* Use headphones with a standard plug.

### 12 LEVEL (headphone volume) control

This control is used to adjust the headphone volume.  
Turn it clockwise to increase the headphone volume.

### 13 DISPLAY button

This button is used to turn lighting ON and OFF of the display window.  
Pressing this button once darkens the display. The third time this button is pressed, the display will be extinguished and the indicator in 28 lights.

### 28 DISPLAY OFF indicator

This indicator turns on when the display screen is turned off (Off mode).



## REMOTE CONTROLLER

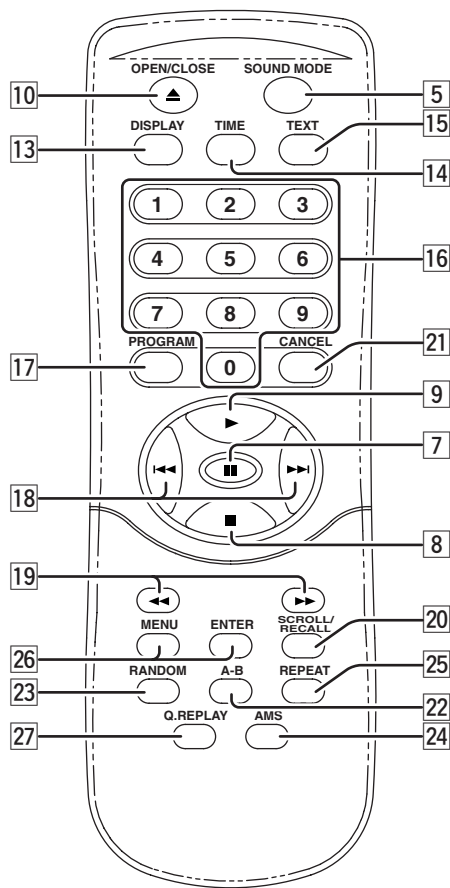

5 **SOUND MODE** button

7 **PAUSE** button

8 **STOP** button

9 **PLAY** button

10 **OPEN/CLOSE** button

13 **DISPLAY** button

This button switches the display screen on and off. The indicator turns on when Display Off is set.

The buttons listed above are the same to the buttons on the front panel of the main unit. Please see the correspond items in "Front Panel" section.

14 **TIME** button

This button is used to switch from the text display to the time display when using a text-compatible Super Audio CD. It is also used to change the time display. Each time that it is pressed, the displayed time cycles from track elapsed time → track remaining time → total remaining time → track elapsed time. (See page 9)

15 **TEXT** button

This button is pressed to switch the main screen from the time display to the text display when using a text-compatible Super Audio CD. (See page 12)

16 **0 - 9** (Numerical buttons)

Use these buttons to select tracks directory.

17 **PROGRAM** button

This button is for program play. (See page 11)

18 **Track skip buttons**

: When this button is pressed, the unit goes back to the beginning of the current track. If the button is pressed more times, the track being played is skipped back.

: Each time this button is pressed, the track being played is skipped forward.

\* Search buttons are provided separately for the remote control unit. Use Search buttons for search function.

19 **Search buttons**

: While this button is pressed during playback, tracks are searched backward.

: While this button is pressed during playback, tracks are searched forward.

20 **SCROLL/RECALL** button

Use this button to scroll text while displaying text information in a Super Audio CD disc that supports TEXT.

This button is also used for checking the programmed tracks during a program or when a program is stopped. (See page 11)

21 **CANCEL** button

Use this button to cancel a programmed track. (See page 11)

22 **A-B** (A-B Repeat button)

This button is to determine starting and ending points for A-B repeat play. (See page 10)

23 **RANDOM** button

This button is for random play. (See page 10)

24 **AMS** (Automatic Music Scan button)

Use this button for AMS play. (See page 11)

25 **REPEAT** button

This button is for repeat play. Each time this button is pressed, repeat mode changes as follows. "All Repeat" → "Track Repeat" → "Repeat Off" (See page 10)

26 **MENU** button and **ENTER** button (Menu setup)

These buttons are used to set the time for quick replay. (See page 11)

27 **Q.REPLAY** (Quick replay) button

This button is used to do quick replay of the tracks. (See page 11)

\* In this instruction manual, some operations can only be performed with the remote control. For operations that can be performed with buttons both on the main unit and on the remote control, the button names are shown in the mark. And for operations that can only be performed with buttons on the remote control, the button names are shown in the mark.

## REAR PANEL

## SA7001

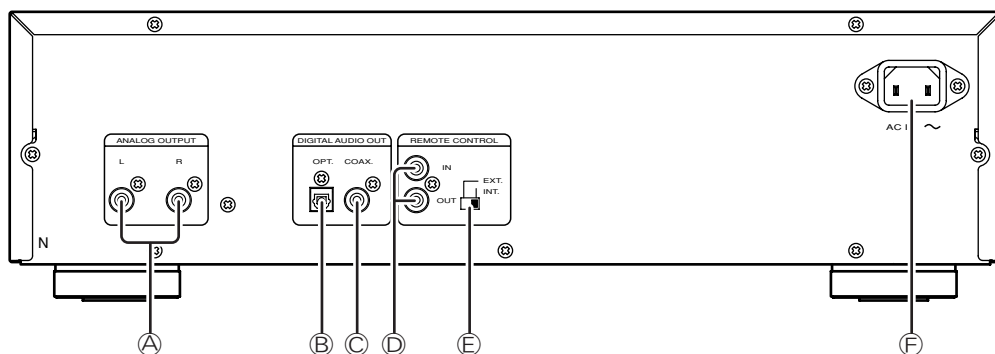

## SA7001 KI

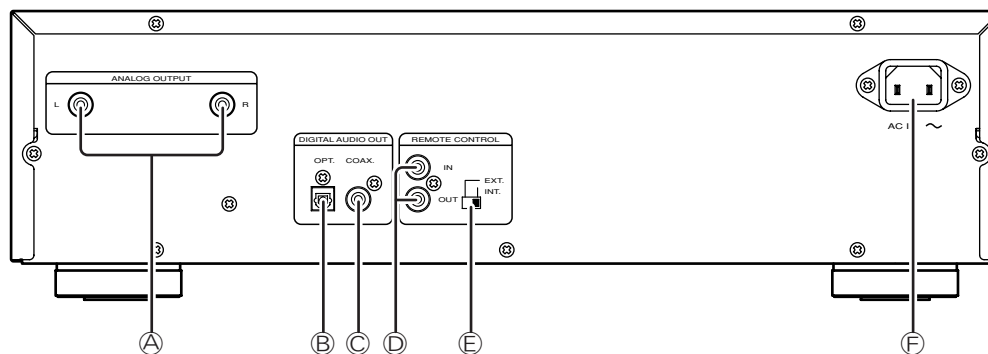

#### Ⓐ ANALOG OUTPUT connectors

These are the output jacks of the analog audio signals. The supplied analog connection cord can be connected to the CD, AUX, or other connectors on an amplifier. Be sure to connect the L and R channels correctly to the corresponding jacks.

\* Never connect to the PHONO connector on the amplifier.

#### Ⓑ DIGITAL AUDIO OUT OPT.

It outputs the playing Audio CD signal in digital format. This jack is to be connected with a recording device, amplifier, D/A converter, etc that has optical digital input using an optional square type optical digital cable.

\* No signal will be output when a Super Audio CD is played.

#### Ⓒ DIGITAL AUDIO OUT COAX.

It outputs the playing Audio CD signal in digital format. This jack is to be connected with a recording device, amplifier, D/A converter, etc that has coaxial digital input using an optional coaxial digital cable.

\* No signal will be output when a Super Audio CD is played.

#### Ⓓ REMOTE CONTROL IN, OUT (input and output) connectors

When the remote control connectors on the player and on a Marantz AV component are connected using the accessory remote control connecting cables, the components can be operated as a system by remote control.

- When connecting to a component which is equipped with remote control connectors, the player's REMOTE CONTROL IN connector must always be connected to the REMOTE CONTROL OUT connector on the other component to be connected.
- When connecting a component which is not equipped with an infrared remote sensor, this component must always be connected to the player's REMOTE CONTROL OUT connector.

#### Ⓔ EXT./INT. (Ext./Internal switch)

When this unit is used as a standalone component, set this switch to the INT. side. When it is used connected to external component by a remote connecting cable and to audio component with a remote sensor that supports remote controls by Marantz, set this switch to the EXT. side.

\* If the unit is used as standalone and the switch is set to EXT. position, remote control unit cannot be used.

#### Ⓕ AC POWER INPUT JACK

Connect the supplied power cord to this jack and a household AC power outlet.

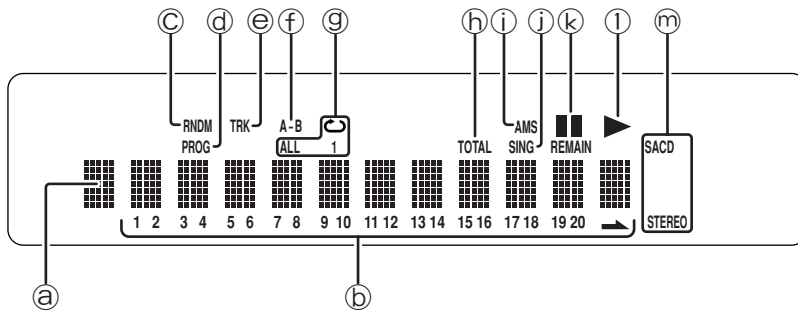

**(a) Main display**

The time display and text information of the disc to be played as well as the setting menus and other displays appear on the main display.

**(b) 1-20, ► (music calendar)**

The number of tracks recorded on the disc to be played, the number of remaining tracks to be played, and the number of tracks programmed by program play appear here. "►" light when 21 or more tracks have been recorded on the disc.

**(c) RNDM (random) indicator**

This lights during random play.

**(d) PROG (program) indicator**

This lights during program play.

**(e) TRK (track) indicator**

This lights above the display of the track number now playing, for instance.

**(f) A-B (A-B repeat) indicator**

This lights during A-B repeat play.

**(g) ◂, ALL, 1 (repeat) indicator**

This lights during repeat play.

**(h) TOTAL (total time) indicator**

When the total remaining time or the total program time is displayed, this lights above the display.

**(i) AMS (auto music search) indicator**

This lights during AMS playback.

**(j) SING indicator**

This lights when the remaining time of the track now playing is displayed.

**(k) || (pause) indicator**

This lights when play is paused (temporarily stopped).

**(l) ► (play) indicator**

This lights during disc play.

**(m) CD, SACD, STEREO Disc indicator**

This indicates the type of disc on the disc tray.

# CONNECTIONS

Depending on your amplifier/receiver/Stereo System, there are various ways to connect to this player. For correct connection please refer to instruction manuals of stereo system to be connected.

Caution: Do not connect output from this unit to PHONO input of your audio system.

1. Connect the audio cable ① to this unit's front speaker outputs and the stereo inputs on your amplifier, receiver or stereo system.
  2. Connect the optical cable ②, coaxial cable ③ to the digital input on your AV amplifier, D/A converter, CD-R, etc..
- \* Signal will be output from the digital audio out jacks (OPT./COAX.) only when an Audio CD disc is played. No signal is output when playing a Super Audio CD.

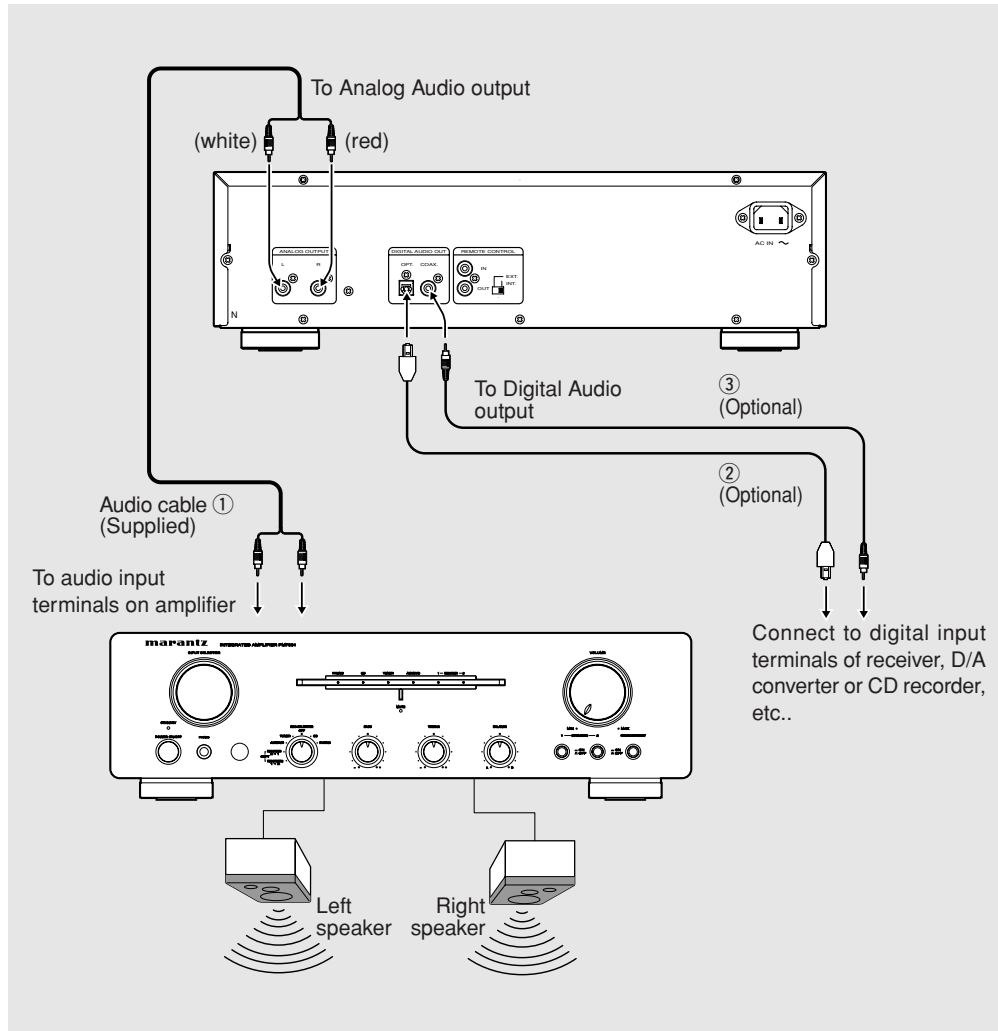

## SA7001

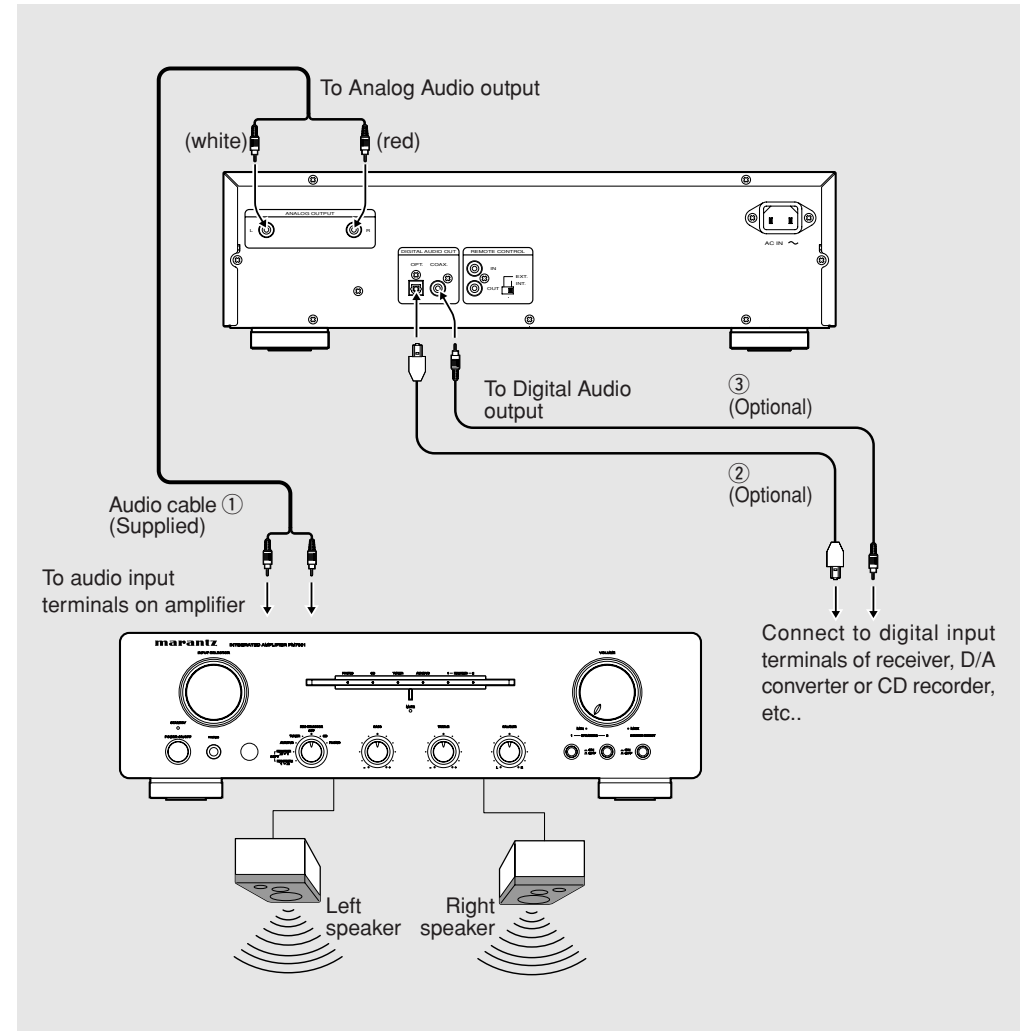

## SA7001 KI



# OPERATION

\* In this instruction manual, some operations can only be performed with the remote control. For operations that can be performed with buttons both on the main unit and on the remote control, the button names are shown in the  mark. And for operations that can only be performed with buttons on the remote control, the button names are shown in the  mark.

## CONNECTING THE POWER SUPPLY

- 1 Plug the power cable into AC IN jack on the back panel.

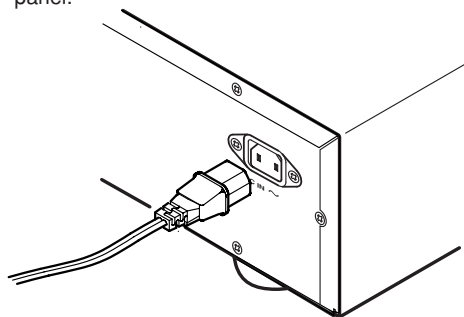

- 2 Turn on the power switch of the audio unit (amplifier, etc.) that is connected with this unit. Set the selector on the connected unit to this unit.
- 3 Plug the power cable into an AC outlet.

## NORMAL PLAYBACK

### ■ Super Audio CD player playback

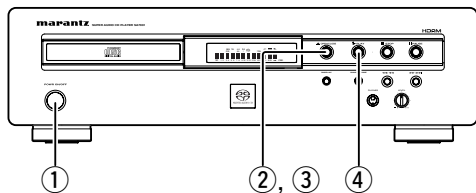

- ① Press **POWER** switch to turn on.

Display

SuperAudioCD

The display cycles from TOC Reading → No Disc (when no disc is loaded) → Super Audio CD (when the start sound mode setting is Super Audio CD).

- ② Press the **OPEN/CLOSE** button

The disc tray comes out. Place the disc with label side up on the tray. To play a single (8cm) CD, place the disc with the indentation at the center of the tray.

- ③ Press **OPEN/CLOSE** button.

- ④ Press **PLAY** button.

Disc type is automatically detected and playback is started. Track number and track elapsed time (minute, second) appear on the display.

\* For Super Audio CD/CD hybrid-layer discs (See page 2), the layer that is set in the start sound mode (See page 10) is played. To change the layer, use the **SOUND MODE** button. (See page 9)

(Exp.: Track 6, Elapsed time 2 min 8 sec)

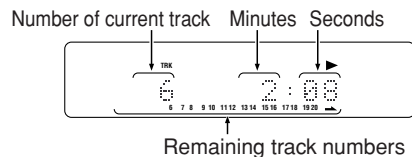

Playback automatically stops at the end of the final track.

### To start playback from the first track

Press **PLAY** button.

### To stop playback

Press **STOP** button.

### To eject disc

Press **OPEN/CLOSE** button to open the disc tray and take the disc off. Press the button again to close the tray.

Disc tray must be closed when the unit is not be used.

### To pause playback

Press **PAUSE** button.

PAUSE indicator will light and playback is paused at the point that the button is pressed. To restart playback, press **PAUSE** button again or press **PLAY** button.

### To change time display

Press the **TIME** button on the remote control.

Each time **TIME** button is pressed, display will change in the following order. "Track elapsed time" → "Track remaining time" → "Total remaining time" → "Track elapsed time".

#### • Track remaining time

(The remaining playing time from the playing point to the end of the current track)

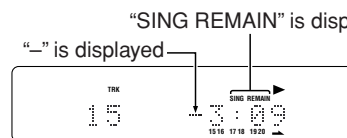

#### • Total remaining time

(The remaining playing time from the playing point to the end of the last track)

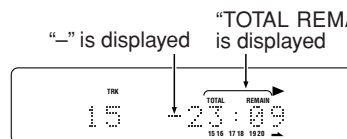

\* If **TIME** button is pressed when Super Audio CD disc that supports text is in use, time display is given priority and the text information will not be displayed afterward. To see the text information, press **TEXT** button.

## ■ Switching Sound Mode (Super Audio CD)

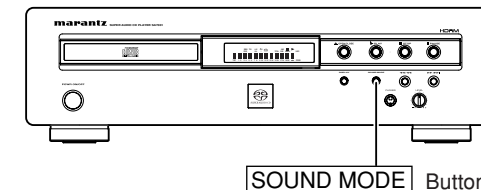

- ① Press **SOUND MODE** button in stop mode (not playing).

The currently selected layer or area is shown on the display. (CD or Super Audio CD)

If **SOUND MODE** button is pressed again, a playable layer or area will be shown, and the layer or area will be switched to new one.

\* When layer or area is switched, TOC will be read again.

\* The sound mode cannot be changed for Audio CDs and discs with only a Super Audio CD area.

\* The sound mode on hybrid layer discs will be changed in the following order. Super Audio CD stereo area → CD layer → Super Audio CD stereo area

\* Sound mode can be selected while the tray is open. Select a desired layer or area and press **PLAY** button then the tray will close and playback will be started.

- ② Press the **SOUND MODE** button during playback.

The currently selected layer or area is shown on the display. (CD or Super Audio CD)

If **SOUND MODE** button is pressed again, the playback is stopped, and the layer or area will be switched to new one.

When you want to listen at that area, press **PLAY** button again. The playback will be started.

## START SOUND MODE

When a Super Audio CD hybrid layer discs that has both a Super Audio CD high sound quality stereo area and an Audio CD area information are to be played, this player makes it possible to set the layer/area (Super Audio CD or Audio CD) to be preferentially played.

This setting can be made when the tray is closed and there is no disc in the disc tray.

- ① Press **[SOUND MODE]** button on the player.  
The currently selected layer/area is displayed.  
If the Super Audio CD is selected : Super Audio CD  
If the Audio CD is selected : CD
- ② Press the **[SOUND MODE]** button again to display the layer/area to be played first, and then leave the setting for at least two seconds to register the setting for the start sound mode.

### Caution

- \* Start sound mode has a memory retention function where the settings remain stored and unchanged even when the disc is changed or the power is turned off.
- \* At the time of shipment, the sound mode is set to Super Audio CD.

## PLAYING YOUR FAVORITE TRACKS OF A DISC

### ■ Specify track number to play (Direct Search)

**Specify track number with numerical buttons (0-9) on the remote**

(example)

3rd track : Press **[3]**.  
12th track : Press **[1]** and then press **[2]**  
(within approximately 1.5 seconds).

If the first pressed number is only in the digit of ones and not in the digit of tens, search begins approximately 0.5 second after.

### If a wrong number is pressed

Press correct number again.

- \* If you specify a track number that doesn't exist on the disc, the indicator returns to the display shown prior to this operation. Please specify a correct track.

### ■ Skipping to the previous or next track (Track Skip)

#### To listen to a track posterior to the current track

Press **[▶▶/▶▶]** buttons on the main unit or **[▶▶]** button on the remote the number of times you want to proceed tracks.

#### To listen to a track prior to the current track

Press **[◀◀/◀◀]** buttons on the main unit or **[◀◀]** button on the remote go back to the beginning of the current track. Then press **[◀◀/◀◀]** buttons on the main unit or **[◀◀]** button on the remote the number of times you want to go back.

## PLAYING YOUR FAVORITE PARTS OF A DISC (SEARCH)

If **[◀◀/◀◀]**, **[▶▶/▶▶]** buttons on the main unit or **[◀◀]**, **[▶▶]** buttons on the remote are kept pressing during playback, track search begins. Release the button when the point you want to listen to gets close.

- \* No sound is output during the search operation.

## REPEATED DISC PLAY (REPEAT PLAY)

### ■ All track repeat

When **[REPEAT]** button on the remote is pressed, "♫" "ALL" indicator will light up and all track repeat play begins.

#### To Return to Normal Play

Press **[REPEAT]** button two times. "♫" "ALL" indicator will disappear, repeat mode will be off and it returns to normal play mode.

- \* If **[REPEAT]** button is pressed when in program mode, programmed tracks are played repeatedly.

### ■ One Track Repeat

Press **[REPEAT]** button on the remote two times. "♫", "1" indicators will light and the track will be played repeatedly.

#### To Exit from One Track Repeat

Press **[REPEAT]** button. "♫" "1" indicator will disappear, repeat mode will be off and it returns to normal play mode.

### ■ A-B Repeat

- ① Press **[A-B]** button on the remote at your chosen starting point. The "A-B" indicator will blink.
- ② Press **[A-B]** button again at your chosen end point. "A-B" "♫" indicator will light up and the chosen section will be played repeatedly.

#### To Exit from A-B Repeat

Press **[A-B]** button on the remote. "A-B" "♫" indicator will disappear, A-B repeat mode will be off and it returns to normal play mode.

- \* A-B repeat cannot be done when random play is going on.

- \* The end point (where "A-B" indicator is blinks) of the repeat section cannot be set before the time of the starting point (where "A-B" "♫" indicator light up) of the repeat section.

## PLAYING TRACKS IN A RANDOM SEQUENCE (RANDOM PLAY)

When **[RANDOM]** button on the remote is pressed in stop mode, and then **[▶PLAY]** button is pressed, the unit shuffles track order automatically and plays all the tracks in the shuffled order. The RNDM (random) indicator lights.

- The gap between tracks will be approximately 2 seconds during random play.

### To Exit from Random Play and Return to Normal Play

Press the **[■STOP]** button, and then press the **[RANDOM]** button while playback is stopped. The RNDM (random) indicator goes off, and random play is released.

### If **[▶▶/▶▶]** buttons on the main unit or **[▶▶]** button on the remote are Pressed during Random Play

It jumps to the next track of the shuffled order.

### If **[◀◀/◀◀]**, **[▶▶/▶▶]** buttons on the main unit or **[◀◀]**, **[▶▶]** buttons on the remote are Pressed during Random Play

Search will be done only in the current track. Search does not go to the previous or next track.

### To Listen to Random Play Repeatedly

Press **[REPEAT]** button on the remote once during random play. Every time the order will be shuffled.

- If **[RANDOM]** button is pressed during program play, the programmed tracks will be shuffled.



## PLAYING TRACKS IN A SPECIFIC SEQUENCE (PROGRAM PLAY)

You can arrange and play tracks in a specific sequence. Up to 30 tracks to be played can be programmed.

(Example: To program the 7th track after 15th track in a disc with 25 tracks)

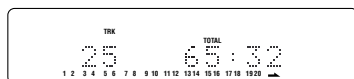

- Press **[PROGRAM]** button on the remote in stop mode. "PROG" indicator will light up and it goes to program mode.

Lights up

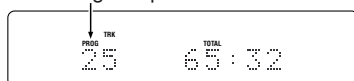

- Choose a track to be programmed with numeric buttons on the remote.

(Example: The 15th track is chosen and it's length is 4min30sec)

Lights up

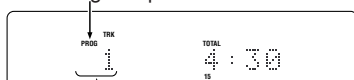

1st track programmed      Only the numbers of programmed tracks light up

- With the sequence described in step 2 above, program another track. Repeat that sequence to program all the tracks you want. You can program up to 30 tracks.

(Example: The 7th track is chosen and total length of 7th and 15th is 7min50sec)

Lights up

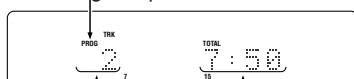

Total programmed number      Total playing time of programmed tracks

- Press **[PLAY]** button to starts playback in programmed order.

\* When 21 or more tracks are programmed, **[▶]** will light up instead of the track number indicator.

### To Check the Programmed Tracks

Press the **[SCROLL/RECALL]** button on the remote control during the program or when the program is stopped ("PROG" lights up).

Every time press **[SCROLL/RECALL]** button, the programmed tracks will be displayed one after the other in order.

### To Delete a Programmed Track

- Press **[CANCEL]** button in stop mode when program has been made (When "PROG" indicator is lighting up).

- Every time press **[CANCEL]** button, the programmed tracks are deleted in order from the last track programmed. Also, the deleted track's track number indicator will disappear.

### To Clear Whole Program

Press **[STOP]** button two times while in program play. In the stop mode, press **[STOP]** button once. Program can also be cleared by pressing **[OPEN/CLOSE]** key to open the disc tray.

### To Add Tracks to Program

Tracks can be added to the end of program when program is remaining ("PROG" indicator is lighting up) and in stop mode.

However tracks cannot be added to the program when the RNDM (random) indicator is lighting up.

### \* Please be careful about the following matters.

- When programming 1st through 9th tracks in a disc that has over 10 tracks by using numeric buttons. For instance, programming the 3rd track after programming the 1st track, press 3 button more than approximately 1.5 seconds after 1 button is pressed. When a program is finalized, the time is updated.
- Likewise, when programming a track at 10th or after. For example, to program 13th track, press 3 button within approximately 1.5 seconds after 1 button is pressed.
- When programming a track in a disc that has less than 9 tracks. For instance, to program the 5th track after 4th track has been programmed, press 5 button more than approximately 0.5 second after 4 button is pressed.

## Q&A

- How many tracks can be programmed?**  
Up to 30 tracks can be programmed for program play.
- Can I listen to program play repeatedly?**  
Press **[REPEAT]** button once. "ALL" indicator will light and program play will be repeated.
- Can I shuffle the programmed track order?**  
Press **[RANDOM]** button in stop mode.

## SEARCHING YOUR FAVORITE TRACKS (AMS (AUTOMATIC MUSIC SCAN) PLAY)

This feature is convenient to search where your favorite track is.

If **[AMS]** button on the remote is pressed in stop mode, the PLAY "▶" indicator will blink and the beginnings of all the tracks will be played for 10 seconds each starting from the first track.

Also, if the **[AMS]** button is pressed during playback, the PLAY indicator "▶" will blink, and the program will jump to the next track after a display time of approximately 10 seconds.

Light up



When you find a song that you want to listen to, press the **[AMS]** button again or press the **[PLAY]** button. PLAY indicator will light up constantly and normal playback will begin from the current track.

\* If the **[AMS]** button is pressed after the tracks are programmed, only the programmed tracks are played by AMS.

## QUICK REPLAY

When **[Q.REPLAY]** button is pressed during playback, the unit goes back to the amount of time set by the MENU and starts playback from there.

\* Playback that goes beyond the track is not allowed. Also, when the total time of the track being played is shorter than the time set for quick replay, or when the playback time is shorter than the time set for quick replay, if **[Q.REPLAY]** button is pressed, the track will be goes back to the start of that track and playback is started from there.

### To Set Quick Replay Time

- If a disc is loaded in the disc tray, eject the disc and close the tray.
- Press the **[MENU]** button on the remote control.

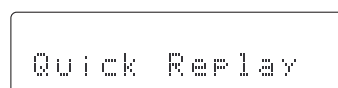

- Press the **[ENTER]** button on the remote control while Quick Replay is displayed (approx. 3 seconds). The current time setting appears on the display. (The default setting is 10 seconds.)

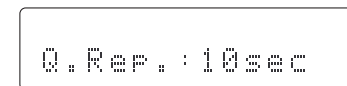

- Use the **[◀▶]** or **[▶▶]** button to set the time. (10 seconds/20 seconds/30 seconds)
- After making the setting, press the **[MENU]** button twice. The display returns to the normal display.
- The time setting is retained even when the power is turned off.

### Caution:

\* When there is no key input for about 4 seconds during this series of operations, the setting will be configured to the conditions at that time and the display will return the time display.

## ABOUT THE TEXT INFORMATION DISPLAY

The following items of text information in Super Audio CD discs can be displayed by pressing (TEXT) button on the remote.

Nevertheless, which items of information are recorded depends on discs so some information may not be displayed. This unit skips unrecorded information to display.

### • During playback

When (TEXT) button is pressed on the remote, "Track Title" of the currently playing will be displayed.

### • In Stop Mode

Each time (TEXT) button on the remote is pressed, text information will be displayed in the following order.

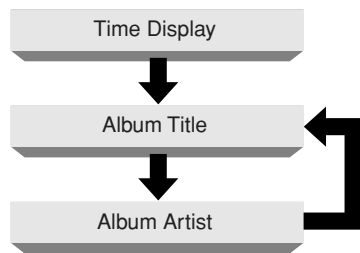

- This unit can display 12 characters in one time. If information is longer than 12 characters, the display will scroll right to left.
- This unit can display only alphabets, numeric numbers and symbols. Chinese and Japanese characters cannot be displayed. If information is in Chinese and Japanese characters, the unit displays nothing.

## TIMER PLAY

This unit can perform timer play by cooperating with your audio timer.

Connect this unit's power cord to the audio timer's power socket and the timer's power cord to power outlet.

\* For connection to audio timer and its operation, please refer to the instruction manual of your audio timer.

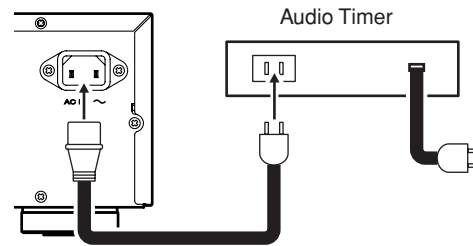

### Setting method of Timer Play

- ① Press POWER switch to turn ON the power.
- ② Insert the disc to be played.  
\* In timer play mode, tracks are played normally.
- ③ Set the audio timer.

## TROUBLE SHOOTING

If you think a malfunction has occurred, first check the points listed below. The problem is likely to have been caused by a simple operational error or a connection problem. If the problem cannot be corrected even after carrying out the following checks, consult your dealer or nearest Marantz sales office or service counter.

### • The disc fails to rotate.

1. Is the mains lead plugged in properly?
2. Is the POWER switch ON?
3. Is the disc placed in the correct position on the disc tray?
4. Is the disc placed properly with the label side facing up?
5. Is the disc dirty?
6. Is the disc scratched?
7. Is the disc warped?

### • The disc is rotating but no sound is heard.

1. Are the amplifier and speakers connected properly?
2. Is the amplifier switch ON?
3. Is the amplifier's function or selector switch set to "CD" or "AUX" or such (to whatever you have connected this unit to)?
4. Is the amplifier's volume control set at the minimum level?

### • The disc stops in mid-operation.

#### The sound drops out or noise is heard.

1. Is the disc dirty?
  2. Is the disc scratched?
  3. Is the disc warped?
- \* In the case of a CD-R or CD-RW disc, this problem may occur when the conditions under which its data was originally written were substandard or when the quality of the disc itself is poor.
- \* This condition may occur in Mixed-Mode CDs, CD Extra, and other discs that have CDDA format mixed with other data.  
Noise may also be heard momentarily when skipping tracks.

### • Remote control operation is not possible.

1. Is the transmitter of the remote control unit (RC7001SA) pointed correctly at the remote sensor on the front of the player (this unit)?  
Or is there an obstruction between the transmitter and the remote sensor?
2. Are the batteries in the remote control unit exhausted?
3. Is there another strong light (from a window, etc.) striking the Super Audio CD player's remote sensor?

### • A Super Audio CD cannot be played.

1. Is the disc scratched, dirty or warped?
2. Is the amplifier's input selector set to digital?  
\* Digital audio signal will not be output when a Super Audio CD is played.
3. Is the disc a Super Audio CD multi-channel only disc? (This unit does not support Super Audio CD multi-channel.)

### • A CD-R/CD-RW disc cannot be played.

1. Is the disc placed upside down?
2. Is the disc contains properly written TOC?
3. Is the recorded information in an audio (CD-DA) format?

### • A specific CD cannot be played

Copy control CDs (CDs with copy guard) are special discs that do not comply with current CD standards. Marantz cannot guarantee the ability to play such discs on your CD player. When normal CDs can be played without a problem and problems occur only when playing these special discs, it is not a problem with this unit.  
Please ask the seller of the copy control CD for detailed information regarding copy control CDs.

### • The unit makes a clicking sound when the tray closes

This is the adhesion click of the clasper for securing the disc. This does not cause any problem in using the unit.

### • While the disc is spinning, a spinning sound is heard or a slight vibration occur.

Depending on the disc, a spinning sound may occur or the unit may vibrate slightly due to disc eccentricity or such. This is not a problem with this unit.

# SPECIFICATIONS

	Super Audio CD	Audio CD
<b>Audio Characteristics</b>		
Analog output		
Channels	2channels	2channels
Frequency range	2Hz — 100kHz	2Hz — 20kHz
Frequency characteristics	2Hz — 50kHz (-3dB)	2Hz — 20kHz
Dynamic range	112dB	100dB
THD (1kHz)	0.0020%	0.0020%
wow & flutter	Precision of quartz	Precision of quartz
Output level		
Unbalanced	2.3V RMS stereo	2.3V RMS stereo
Digital output		
output level (cinch JACK)	—	0.5Vp-p (75Ω)
output level (optical)	—	-19dBm
<b>Optical Readout System</b>		
Laser	AlGaAs	AlGaAs
Wave length	650nm	780nm
<b>Signal format</b>		
Sampling frequency	<b>1-bit DSD</b> 2.8224MHz	<b>16-bit linear PCM</b> 44.1kHz

## Power Supply

N Version ..... AC 230V 50Hz  
 Power Consumption ..... 19W

## Cabinet, etc.

Dimensions (Width × Height × Depth) ..... 440 × 126.5 × 335.5mm  
 Net weight ..... 6.3kg  
 Net weight (SA7001 KI) ..... 8.0kg  
 Operating temperatures ..... +5°C ~ +35°C  
 Operating humidity ..... 5 ~ 90% (without dew)

## Accessories

- Remote control unit (RC7001SA) ..... 1
- Dimensions (Width × Height × Depth) ..... 48 × 25.7 × 145mm
- Net weight ..... 160g
- AA Batteries ..... 2
- AC Power cord ..... 1
- Audio cable ..... 1
- Remote connection Cable ..... 1
- User's Guide ..... 1
- Warranty Card ..... 1

Specifications subject to change without prior notice.

## ■ Dimensions (unit: mm)

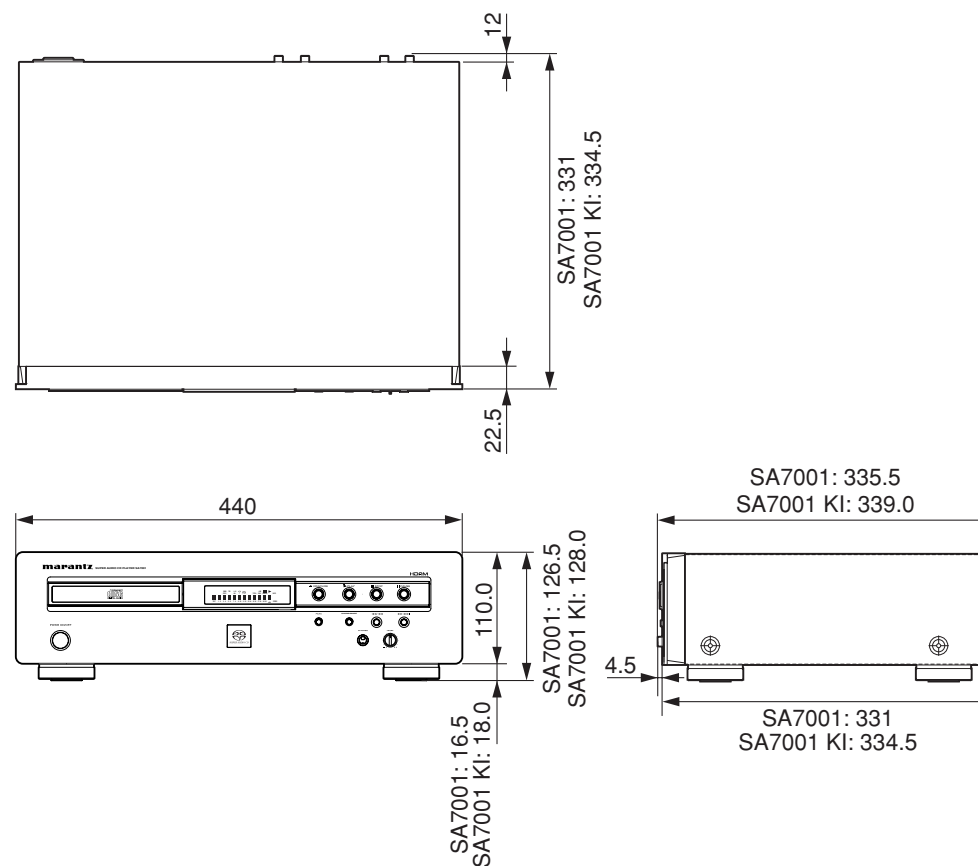

**www.marantz.com**

You can find your nearest authorized distributor or dealer on our website.

---

**U.S.A.** Marantz America, Inc. 1100 Maplewood Drive, Itasca, IL 60143, U.S.A.

**EUROPE** Marantz Europe B.V. P.O. Box 8744, 5605 LS Eindhoven, The Netherlands

---

**marantz**<sup>®</sup> is a registered trademark.

## Free Manuals Download Website

<http://myh66.com>

<http://usermanuals.us>

<http://www.somanuals.com>

<http://www.4manuals.cc>

<http://www.manual-lib.com>

<http://www.404manual.com>

<http://www.luxmanual.com>

<http://aubethermostatmanual.com>

Golf course search by state

<http://golfingnear.com>

Email search by domain

<http://emailbydomain.com>

Auto manuals search

<http://auto.somanuals.com>

TV manuals search

<http://tv.somanuals.com>