

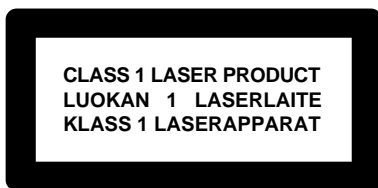

PROFESSIONAL **Model CDR500 User Guide**
CD Recorder/CD Player

marantz®







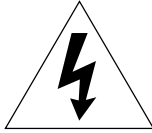

CAUTION

RISK OF ELECTRIC SHOCK

DO NOT OPEN



CAUTION: TO REDUCE THE RISK OF ELECTRIC SHOCK,

DO NOT REMOVE COVER (OR BACK).

NO USER-SERVICEABLE PARTS INSIDE.

REFER SERVICING TO QUALIFIED SERVICE PERSONNEL.

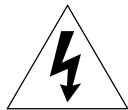

The lightning flash with arrowhead symbol, within an equilateral triangle, is intended to alert the user to the presence of uninsulated "dangerous voltage" within the product's enclosure that may be of sufficient magnitude to constitute a risk of electric shock to persons.



The exclamation point within an equilateral triangle is intended to alert the user to the presence of important operating and maintenance (servicing) instructions in the literature accompanying the product.

WARNING

TO REDUCE THE RISK OF FIRE OR ELECTRIC SHOCK, DO NOT EXPOSE THIS APPLIANCE TO RAIN OR MOISTURE.

CAUTION: TO PREVENT ELECTRIC SHOCK, MATCH WIDE BLADE OF PLUG TO WIDE SLOT, FULLY INSERT.

ATTENTION: POUR ÉVITER LES CHOCs ÉLECTRIQUES, INTRODUIRE LA LAME LA PLUS LARGE DE LA FICHE DANS LA BORNE CORRESPONDANTE DE LA PRISE ET POUSSER JUSQU'AU FOND.

NOTE:

This equipment has been tested and found to comply with the limits for a Class B digital device, pursuant to Part 15 of the FCC Rules. These limits are designed to provide reasonable protection against harmful interference in a residential installation. This equipment generates, uses and can radiate radio frequency energy and, if not installed and used in accordance with the instructions, may cause harmful interference to radio communications. However, there is no guarantee that interference will not occur in a particular installation. If this equipment does cause harmful interference to radio or television reception, which can be determined by turning the equipment off and on, the user is encouraged to try to correct the interference by one or more of the following measures:

- Reorient or relocate the receiving antenna.
- Increase the separation between the equipment and receiver.
- Connect the equipment into an outlet on a circuit different from that to which the receiver is connected.
- Consult the dealer or an experienced radio/TV technician for help.

NOTE: Changes or modifications may cause this unit to fail to comply with Part 15 of the FCC Rules and may void the user's authority to operate the equipment.

LASER SAFETY

This unit employs a LASER. Only a qualified service person should remove the cover or attempt to service this device, due to possible eye injury.

CAUTION-USE OF CONTROLS OR ADJUSTMENTS OR PERFORMANCE OF PROCEDURE OTHER THAN THOSE SPECIFIED HEREIN MAY RESULT IN HAZARDOUS RADIATION EXPOSURE.

This Class B digital apparatus meets all requirements of the Canadian Interference-Causing Equipment Regulations.

Cet appareil numérique de la Classe B respecte toutes les exigences du Règlement sur le matériel brouilleur du Canada.

i

IMPORTANT SAFETY INSTRUCTIONS

READ BEFORE OPERATING EQUIPMENT

This product was designed and manufactured to meet strict quality and safety standards. There are, however, some installation and operation precautions which you should be particularly aware of.

1. Read Instructions — All the safety and operating instructions should be read before the appliance is operated.
2. Retain Instructions — The safety and operating instructions should be retained for future reference.
3. Heed Warnings — All warnings on the appliance and in the operating instructions should be adhered to.
4. Follow Instructions — All operating and use instructions should be followed.
5. Water and Moisture — The appliance should not be used near water — for example, near a bathtub, wash-bowl, kitchen sink, laundry tub, in a wet basement, or near a swimming pool, etc.
6. Carts and Stands — The appliance should be used only with a cart or stand that is recommended by the manufacturer.
7. An appliance and cart combination should be moved with care. Quick stops, excessive force, and uneven surfaces may cause the appliance and cart combination to overturn.



8. Wall or Ceiling Mounting — The appliance should be mounted to a wall or ceiling only as recommended by the manufacturer.
9. Ventilation — The appliance should be situated so that its location or position does not interfere with its proper ventilation. For example, the appliance should not be situated on a bed, sofa, rug, or similar surface that may block the ventilation openings; or, placed in a built-in installation, such as a bookcase or cabinet that may impede the flow of air through the ventilation openings.
10. Heat — The appliance should be situated away from heat sources such as radiators, heat registers, stoves, or other appliances (including amplifiers) that produce heat.
11. Power Sources — The appliance should be connected to a power supply only of the type described in the operating instructions or as marked on the appliance.

12. Grounding or Polarization — The precautions that should be taken so that the grounding or polarization means of an appliance is not defeated.

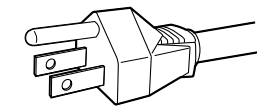

AC POLARIZED PLUG

13. Power-Cord Protection — Power-supply cords should be routed so that they are not likely to be walked on or pinched by items placed upon or against them, paying particular attention to cords at plugs, convenience receptacles, and the point where they exit from the appliance.
14. Cleaning — The appliance should be cleaned only as recommended by the manufacturer.
15. Nonuse Periods — The power cord of the appliance should be unplugged from the outlet when left unused for a long period of time.
16. Object and Liquid Entry — Care should be taken so that objects do not fall and liquids are not spilled into the enclosure through openings.
17. Damage Requiring Service — The appliance should be serviced by qualified service personnel when:
 - A. The power-supply cord or the plug has been damaged; or
 - B. Objects have fallen, or liquid has spilled into the appliance; or
 - C. The appliance has been exposed to rain; or
 - D. The appliance does not appear to operate normally or exhibits a marked change in performance; or
 - E. The appliance has been dropped, or the enclosure damaged.
18. Servicing — The user should not attempt to service the appliance beyond that described in the operating instructions. All other servicing should be referred to qualified service personnel.

ii



CONTROLS AND CONNECTIONS

Player front

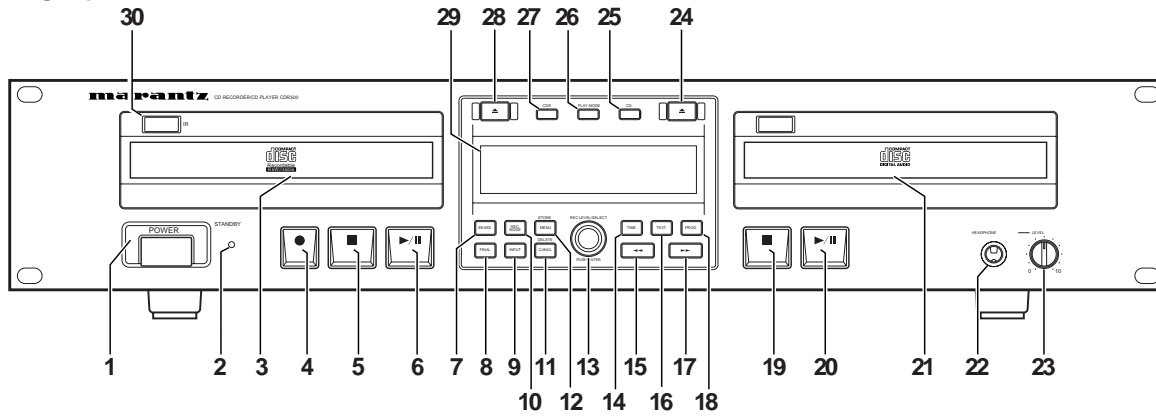

Player back

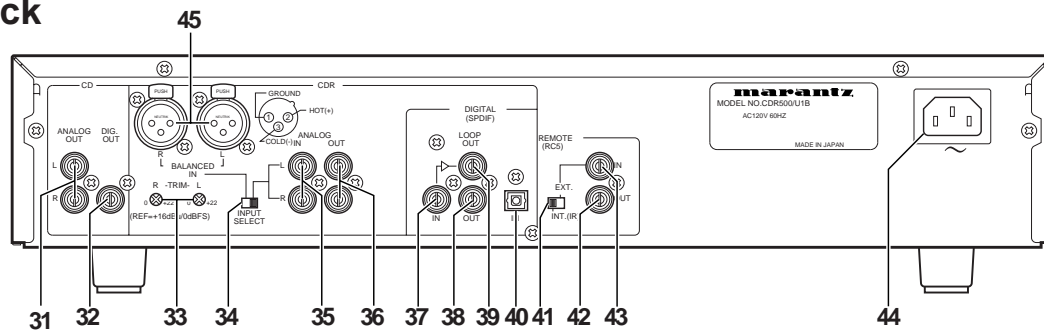

Remote control

Display

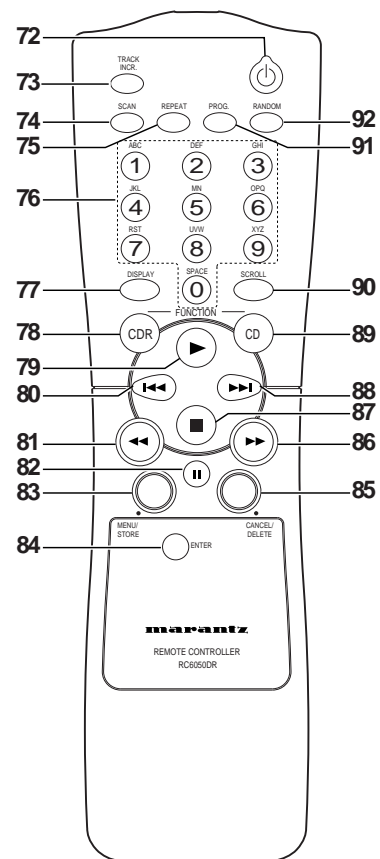
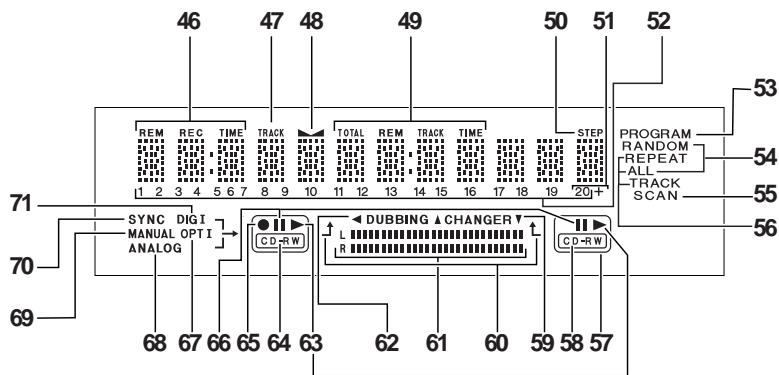



TABLE OF CONTENTS

CONTROLS AND CONNECTIONS	iii	MENU MODE	20
Player front	iii	About MENU MODE	20
Player back	iii	Text Submenus	20
Display	iii	About TEXT	21
Remote control	iii	Recording submenu	22
INTRODUCTION	1	DISPLAY	25
CD-R and CD-RW Discs	1	General	25
Unpacking	1	Recording	25
Setup	1	Play	25
Compact Discs Care	1	Others	25
Maintenance	2	Menu messages	26
CONTROLS AND CONNECTIONS	3	OTHER INFORMATION	26
INSTALLATION	5	Fixing problems	26
The following options are available:	5	EXTERNAL DIMENSIONS	Last page
Balanced analog connections	5	TECHNICAL SPECIFICATIONS	Last page
Unbalanced analog connections	5		
Digital Coaxial connections	6		
Digital Optical connections	6		
Digital cascade connections	6		
REMOTE CONTROL (RC5) CONNECTION ...	7		
Remote control cable connections	7		
INITIAL SETUP	8		
Switching ON and OFF	8		
Using the remote control	8		
Inserting discs	8		
RECORDING	9		
Recording modes	9		
Remarks about recording	9		
Double speed recording	10		
Normal speed recording	11		
Disc At Once (DAO) recording	12		
Manual start recording	13		
Sync Recording	14		
FINALIZING/UNFINALIZING	15		
Finalizing CD-R & CD-RW discs	15		
Unfinalizing CD-RW discs	15		
ERASING	16		
Erasing	16		
Erasing one or more tracks from the end	16		
Erasing the entire disc	16		
PLAYING	17		
Changer Mode	17		
Dual Mode	17		
Selecting a track	18		
Scan play	18		
Search	18		
Random play	18		
Repeat play	18		
PROGRAMMING	19		
Programmed play	19		



INTRODUCTION

Copyright

Recording and playback of some material may require permission. For further information refer to the following:

- Copyright Act 1956
- Dramatic and Musical Performers Act 1958
- Performers Protection Acts 1963 and 1972
- Any subsequent statutory enactments and orders

Congratulations on your purchase of the CDR500 CD recorder. This unit enables you to record, play, and erase (using CD-RW discs) your own audio Compact Discs. Naturally the recorder can also be used to play all pre-recorded CDs.

CD-R and CD-RW Discs

With the exception of legal restrictions pertaining to copying, you can create your own high-quality audio recordings on CD. The discs used to record must bear the logos shown below.

There are two types of recordable discs:

1 CD-R (record once):

CD-R discs are only able to be recorded onto a single time but will playback in most CD players.

CD-R discs can be recognized by the following logos:



2 CD-RW (multiple recording):

CD-RW discs are able to be recorded onto many times but will only playback in CD players offering CD-RW compatibility. Products that offer CD-RW playback compatibility are available from Marantz, Marantz Professional, and Superscope. Please contact your dealer for more information on these products.

CD-RW discs can be recognized by the following logos:



Note:

- Most DVD players cannot playback CD-R discs and some cannot playback CD-RW discs because of laser power differences.
- Some CD players may be able to playback finalized CD-RW discs.
- Some CD players can not play the finalized CD-R discs because of the low reflectivity of such discs.

The CDR500 is able to record onto any 1X or 2X compatible CD-R and CD-RW disc, including discs for Consumer use and Professional (computer) discs. For a list of recommended discs, please see the Marantz Professional website at www.marantz.com

Note:

For both CD-R and CD-RW discs, only discs that are compatible with 1X or 2X recording should be used.

It is forbidden to copy material protected by copyright, including computer programs, films, television and audio recordings. This appliance may not be used for applications of this type.

Unpacking

First check the contents of the packaging. It should contain the following:

- CD-Recorder/CD-Player CDR500
- Remote control with batteries packaged separately
- Power cord
- Digital coaxial cable (black)
- Stereo RCA Audio cable (red and white)
- Instructions

If one of these components is missing, please inform your supplier immediately. Save the packaging material it may come in handy if you move the appliance.

Setup

- Place the recorder on a strong, vibration-free surface.
- Do not use the recorder under extremely damp conditions.
- If the recorder is placed in a cabinet, make sure that a 1"(2.5 cm) space remains free on all sides of the recorder for proper ventilation.

Attention!

If this unit is not used or operated in accordance with the instructions, this may result in exposure to dangerous radiation or other risks.

Only authorized technicians are allowed to open the appliance casing or to perform repairs or maintenance.

Compact Discs Care

The glossy side shining like a rainbow is the front side of the disc, and the side on which the label is printed is the back.

Handle discs carefully so as not to damage or scratch the front side.

To protect the disc, avoid placing it in the following locations:

- In direct sunlight or near a source of heat like a heater.
- In a place which is damp or dirty.
- In a place which could be exposed to rain, such as near a window.

Always keep the disc surface clean.

Up to six billion data units are recorded on the front side of the disc. When cleaning the disc surface, always be sure to use a special compact disc cleaner and wipe as shown below.

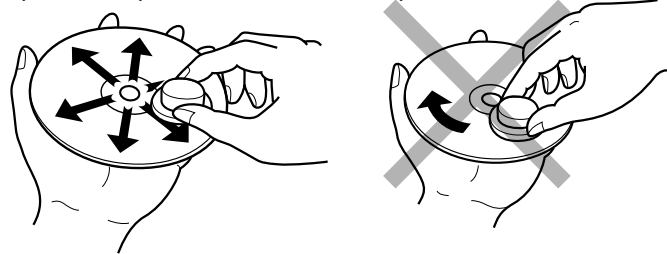

Wipe in a radial direction. Do not wipe in circumferential direction.

INTRODUCTION

- Do not use record cleaner to clear a disc, as this will adversely affect the disc surface.
- Store discs properly by placing them in their disc cases.
- Do not attach a piece of paper or sticker on the label side of disc. When a disc has a piece of plastic tape or rental CD label with paste protruded from the edge or when a disc has a trace of such a sticky object, do not attempt to play the disc. If such a disc is played on the CD player, impossibility of taking out the disc or other malfunction may result.

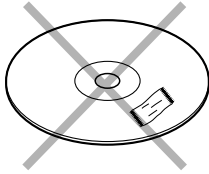

- Write only on the printed side of a CD-R or CD-RW, and only with a soft felt-tipped pen.
- Do not use a disc with a special shape.
- Do not attempt to play a disc with a special shape such as a heart-shaped disc or octagonal disc. Otherwise the equipment malfunction may result.

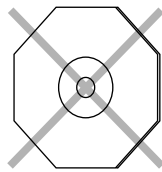
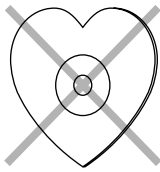

Maintenance

Clean the CDR500 with a soft, slightly dampened lint-free cloth. Do not use any cleaning agents as they may have a corrosive effect.



Do not expose the CDR500, batteries or CDs to humidity, rain, sand or excessive heat (caused by heating equipment or direct sunlight).

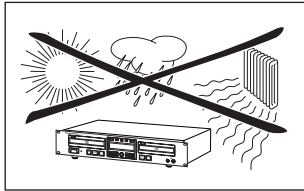

If the CDR500 is unable to read CDs correctly, use a commonly available cleaning CD to clean the lens before taking the CD player to be repaired. Other cleaning methods may destroy the lens. Always keep the tray closed to avoid dust on the lens.

The lenses may cloud over when the CDR500 is suddenly moved from cold to warm surroundings. It is not possible to play a CD then. Leave the CDR500 in a warm environment until the moisture evaporates.

CONTROLS AND CONNECTIONS

Controls on the front

CD-Recorder

- (1) **POWER** turns the CD-Recorder ON and OFF
- (2) **Standby indicator**
- (3) **Disc tray (Deck1)** records CD-R/RW and plays CD and CD-R/RW
- (4) ● starts recording, finalizing, erasing
- (5) ■ stops/clears a program
- (6) ►/|| starts play/interrupts play or recording
- (7) **ERASE** selects erasing mode
- (8) **FINAL** selects finalize mode
- (9) **INPUT** selects external input source
- (10) **REC MODE** selects recording modes
- (27) **CDR** selects CDR display/keys (left side)
- (28) ▲ opens/closes disc tray

General

- (11) **CANCL/DELETE** - deletes tracks from a program
- deletes text in Menu mode
- returns to a higher level in the menu
- (12) **STORE/MENU** - enters Menu mode
- stores Menu settings
- (13) **REC LEVEL/SELECT** - previous/next track (Play and Program mode)
- recording level control (recording)
- selects settings (menu on)
- PUSH ENTER** - plays selected tracks
- selects settings in Menu mode
- programs track numbers
- (14) **TIME** selects display information/text
- (15) ◀◀ searches backward
- (16) **TEXT** activates scrolling of text over the display
- (17) ▶▶ searches forward
- (18) **PROG** opens/closes program memory
- (22) **HEADPHONE** socket for headphones
- (23) **LEVEL** adjusts the headphones volume
- (26) **PLAY MODE** selects if the CD-Recorder drive plays in conjunction with the CD-Player drive or separately
- (29) **Display** information screen
- (30) **IR sensor** receives signals from the remote control.

CD-Player

- (19) ■ stops/clears a program
- (20) ►/|| starts play/pauses play
- (21) **Disc tray (Deck2)** plays CD and CD-R/RW
- (24) ▲ opens/closes disc tray
- (25) **CD** selects CD display/keys (right side)

Note:





Some functions are only on the remote control.

Connections at the back

- (31) **ANALOG OUTPUT CD** .. connects CD-Player drive to the line input of an external analog source (left and right)
- (32) **DIGITAL OUTPUT CD** ... connects CD-Player drive to the digital coaxial input of external digital source
- (33) **TRIM** adjusts the XLR input level
- (34) **INPUT SELECT** selects the analog input
- (35) **ANALOG IN** connects to the line output of an external analog source (left and right)
- (36) **ANALOG OUT** connects to the line input of an analog pre-amp (left and right)
- (37) **DIGITAL (SPDIF) IN** connects to the digital coaxial output of an external digital source
- (38) **DIGITAL (SPDIF) OUT** connects to the digital coaxial input another digital device
- (39) **DIGITAL (SPDIF) LOOP OUT** connects to the digital coaxial input another digital device
- (40) **DIGITAL (SPDIF) OPT INPUT** connects to the digital optical output of an external digital source
- (41) **REMOTE CONTROL SWITCH** ... selects remote control from the IR sensor on the front panel (INT.) or the REMOTE (RC5) input (EXT.)
- (42) **REMOTE CONTROL OUT** connects to a remote control input
- (43) **REMOTE CONTROL IN** connects to a remote control output
- (44) **Connection to AC power**
- (45) **BALANCED IN** connects to the balanced output of an analog source (left and right)









ENGLISH

DISPLAY indications

- (46) **REM/REC TIME** remaining recording time / re-
cording time
- (47) **TRACK** track number
- (48)  balance (lights during balance
adjustment)
- (49) **TOTAL REM
TRACK TIME** total or remaining time of disc or
track
- (50) **STEP** indicates the number of tracks in
a program
- (51) **20 +** disc or program contains more
than 20 tracks
- (52) **Track Number** tracks on a discs or in a program
track in play
- (53) **PROGRAM** flashes during programming/
lights in program mode
- (54) **RANDOM** plays tracks in random order
- (55) **SCAN** plays First 10 seconds of each
track
- (56) **REPEAT TRACK/ALL** ... lights up when a track/ complete
disc (or program) is repeated.
- (57)  CD player selected
- (58) **CD** CD inserted (a pre-recorded CD
or finalized CD-R or CD-RW
disc)
- (59) **▲ CHANGER ▼** changer mode selected
- (60) **(DUAL MODE) ↑↓** Dual mode selected
- (61) **L/R** record/play level bar. Indicates
the audio signal level.
- (62) **◀ DUBBING** lights during recording from the
internal CD
- (63)  lights during play
- (64) **CD-RW** indicates the type of disc in the
disc tray
- (65)  lights during recording
- (66)  indicates pause mode
- (67) **OPT I→** optical input selected for external
recording
- (68) **ANALOG ↗** analog input selected for external
recording
- ANALOG** analog recording
- (69) **MANUAL** manual track increment
- (70) **SYNC** automatic or synchronized start
of external recording
- (71) **DIG I ↘** coaxial digital input selected for ex-
ternal recording

REMOTE CONTROL

Remote control commands

- (72) **STANDBY**  switches Standby On/Off
- (73) **TRACK INCR.** increases track numbers during
recording
- (74) **SCAN** plays the first 10 seconds of each
track
- (75) **REPEAT** repeat play(All, program or track)
- (76) **Number/alphabet keys 0 - 9** .. - selects a track by number
- selects character for text input
- (77) **DISPLAY** selects display information/text
- (78) **CDR** selects CD-Recorder control
- (79)  starts play
- (80)  previous track (Play and Pro-
gram mode)
- (81)  - searches backward
- (82)  pauses play/recording
- (83) **MENU/STORE** - enters Menu mode
- stores Menu settings
- (84) **ENTER** - selects settings in Menu mode
- programs track numbers
- starts playback of selected
track
- (85) **CANCEL/DELETE** - deletes tracks from a program
- deletes text in Menu mode
- returns to a higher level in the
menu
- (86)  - searches forward
- (87)  stops CD-R/RW and clears a
program
- (88)  next track (Play and Program
mode)
- (89) **CD** selects CD player control
- (90) **SCROLL** activates scrolling of text over the
display
- (91) **PROG. (ram)** opens/closes program memory
- (92) **RANDOM** plays discs or program in random
order

INSTALLATION

The numbers between parentheses refer to the fold-out.

The CDR500 can be used to record from any digital or analog audio source, either directly or through a mixer/pre-amplifier. In addition, this unit can also be used as a regular CD player.

For correct connection to other audio equipment, please refer to the operating instructions for those units.

The following options are available:

- Balanced analog connections (XLR)
- Unbalanced analog connections (RCA)
- Digital Coaxial connections
- Digital Optical connections
- Digital cascade connections

Balanced analog connections

1 For recording, connect an analog balanced cable from the CDR500 to a source based on the diagram below:

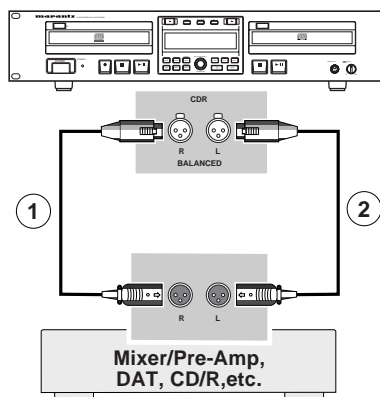

2 Set INPUT SELECT switch (34) to BALANCED IN.

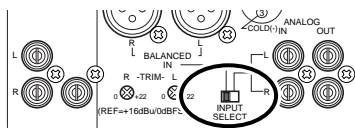

Note:

- The default (set at factory) input level is +16dBu / 0dBFS. If you want to change the level, rotate the TRIM control (33) to adjust input level for both L and R.

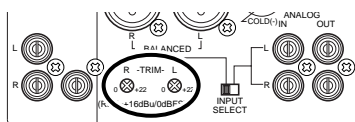

- Make sure that all balanced inputs do not carry phantom power. It may damage the unit.

Unbalanced analog connections

1 For recording and playing, connect the CDR500 to other equipment based on the diagram below:

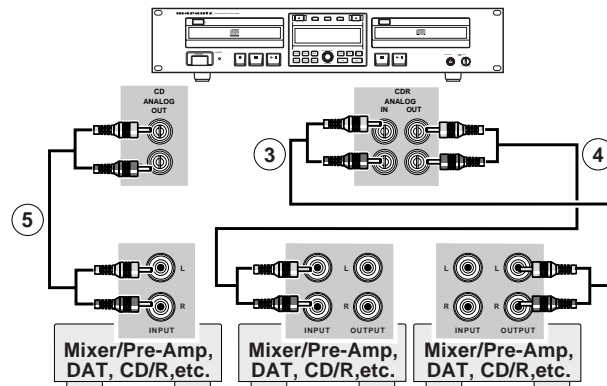

2 Set INPUT SELECT switch (34) to ANALOG L/R (RCA).

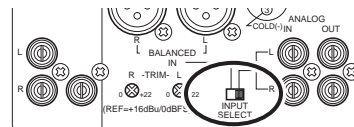

Note:

- During the default playback mode (see changer Mode, page 17), the CD-Player will output to both the CDR and CD analog and digital outputs.
- Never connect the CDR500 to the PHONO input on a Pre-Amp or Receiver.

ENGLISH

INSTALLATION

The numbers between parentheses refer to the fold-out.

Digital Coaxial connections

- 1 For recording and playing, connect coaxial cables from the CDR500 to digital equipment based on the diagram below:

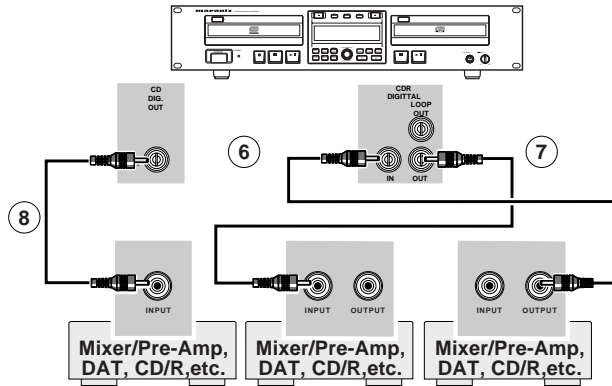

Note:

- During the default playback mode (see Changer Mode, page 17), the CD-Player drive will output to both the CDR and CD analog and digital outputs.
- You can also connect the LOOP OUT jack on the CDR500 to the coaxial digital input jack of a digital device when the DIGITAL (SPDIF) IN is used.

Digital Optical connections

- 1 For recording, connect a fiber-optic cable to the CDR500 with a digital equipment based on the diagram below.

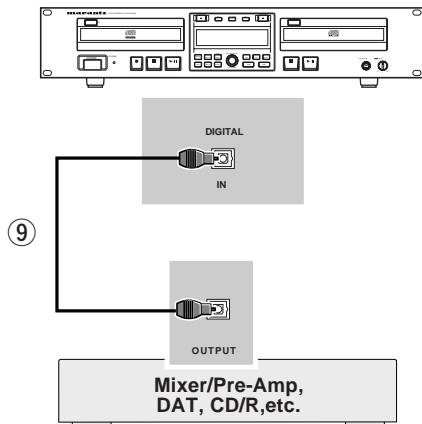

Note:

Before Connecting the cables, remove the dust caps from the digital optical connections. We recommend that you save the caps.

Digital cascade connections

Cascade recording allows, via the LOOP OUT jack, multiple units to record all using the exact same digital signal. The LOOP OUT can also be used to pass a digital signal to other equipment without being processed by the CDR500.

Use the following steps to setup multiple CDR500s for recording from a single digital source:

- 1 Connect the coaxial digital output of a digital source machine (CD, DAT, etc.) to the DIGITAL IN jack on the CDR500 as indicated in step 10.
- 2 Connect the LOOP OUT of the first CDR500 to the DIGITAL IN on the next CDR500 as indicated in step 11.
- 3 Continue to connect units as indicated in step 11 and 12.

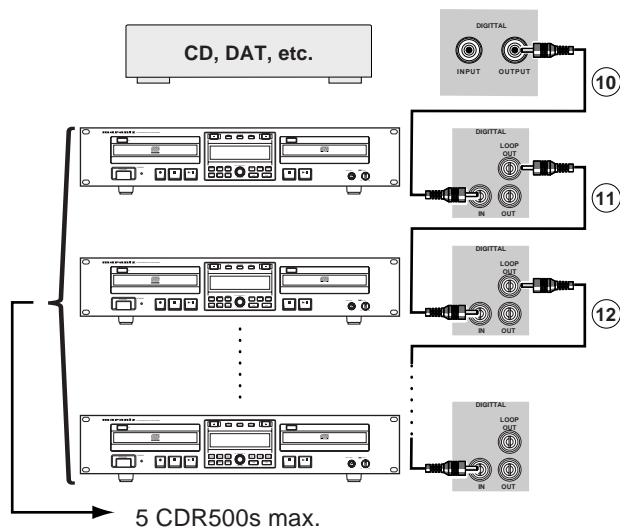

Note:

The LOOP OUT jacks will pass-through an input digital signal only when the power is ON or while the unit is in the STANDBY mode (see Switching ON and OFF on page 8)

REMOTE CONTROL (RC5) CONNECTION

The numbers between parentheses refer to the fold-out.

Remote control cable connections

The REMOTE CONTROL (RC5) jacks on the back panel allow an external remote control system to control the playback functions of the CDR500. The control system is called RC5 and the chart on the right provides the control code list. For more information on the RC5 system and details regarding its operation, please contact Marantz Professional.

1. Connect a remote control cable to the CD recorder from a control system based on the diagram below:

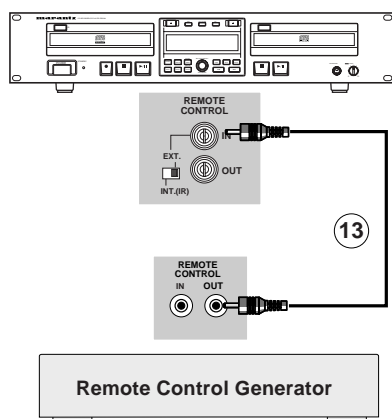

Note:

- When the external remote control is not used, it is recommended to leave the REMOTE CONTROL (RC5) switch in the IR position.
- A heavily shielded single-conductor wire is recommended.
- If it is desirable, for example in a professional studio, to disable the IR receiver, set the REMOTE CONTROL (RC5) switch to the EXT. position.

2. Set **REMOTE (RC5) switch (41) to EXT.**

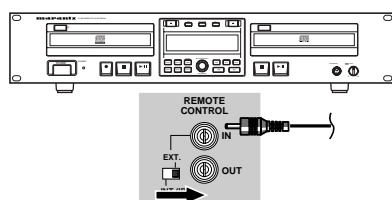

RC5 command list

Function	CDR Code		CD Code	
	System code (dec)	Command code (dec)	System code (dec)	Command code (dec)
Standby(on/off toggle)	26	12	—	—
Select CDR	26	63	—	—
Select CD	—	—	20	63
0	26	00	20	00
1	26	01	20	01
2	26	02	20	02
3	26	03	20	03
4	26	04	20	04
5	26	05	20	05
6	26	06	20	06
7	26	07	20	07
8	26	08	20	08
9	26	09	20	09
Search BWD	26	50	20	50
Search FWD	26	52	20	52
Play	26	53	20	53
Stop	26	54	20	54
Pause	26	48	20	48
Track increm.	26	114	—	—
Next	26	32	20	32
Previous	26	33	20	33
Program	26	36	20	36
Menu/store	26	82	20	82
Cancel/delete	26	49	20	49
Enter	26	87	20	87
Random	26	28	20	28
Repeat	26	29	20	29
Scroll	26	11	20	11
Display	26	15	20	15
Intro scan	26	43	20	43

RC5 extend command

Fanction	System code (dec)	Command code (dec)	Data code (dec)
Power off (standby)	26	12	02
Power on	26	12	01

ENGLISH

INITIAL SETUP

The numbers between parentheses refer to the fold-out.

Switching ON and OFF

- 1 Plug the power cord supplied into the AC IN socket on the CDR500, then into a AC power outlet.

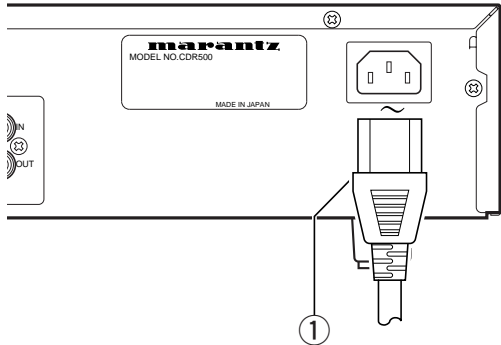

- 2 Press the **POWER (1)** button on the front of the CDR500 to turn it on or off.

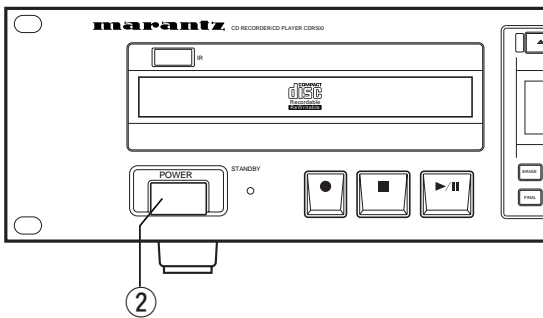

Note:

When the power is switched ON, the *STANDBY* function on the remote control (72) allows the CDR500 to be turned OFF except for the IR receiver circuit that will wait for the standby signal to turn power back on.

Using the remote control

- 1 Open the battery compartment cover.
- 2 Insert 2 batteries (AA, LR-6 or UM-3; as supplied) as shown.
- 3 Replace the cover.



Note:

We recommend you use **2 batteries of the same type and condition.**

This remote control can switch "STANDBY ON/OFF" but cannot switch "POWER ON/OFF" on the CD-Recorder.

Batteries contain chemical substances, so they should be disposed of properly.

Inserting discs

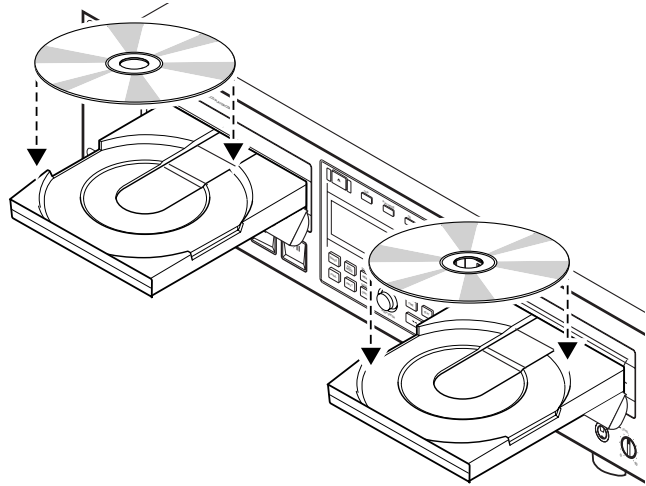

- 1 Press **▲ (28)** to open the disc tray.
→ **OPEN** lights up.
- 2 Insert a CD, CD-R or CD-RW in the appropriate recess in the tray, label side up.
- 3 Press **▲ (28)** to close the tray.
→ **CLOSE** lights up, followed by **READING** and the display will show the type of disc you inserted.

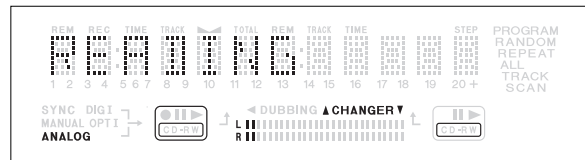

- If a CD-R/RW is finalized it will show CD on the display.
- If CD-text is available the TITLE/ARTIST will scroll by.

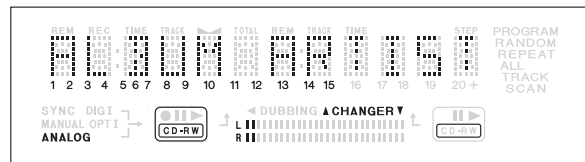

Note:

The CD-Player drive is able to read un-finalized CD-R and CD-RW discs.

CD-Recorder drive only

- For recording it is important that the blank disc is completely free from dust particles or scratches. (see Compact Discs Care, page 1).
- If you insert a blank or partly-recorded CD-R/RW or an unfinalized CD-R/RW, the CD-Recorder will calibrate the disc for optimum recording. During this process the display will first show **INITIALIZING** and then the number of audio tracks. Calibration can take up to 30 seconds.

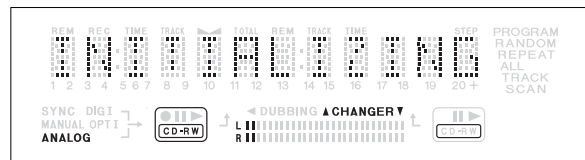

RECORDING

The numbers between parentheses refer to the fold-out.

Recording modes

The CDR500 offers several recording modes.

For recording from internal CD-Player:

- **RECORD FAST** (double speed recording) - fast recording of a disc or programmed tracks.
- **REC LISTEN** (normal speed recording) - listening to a recording while making it.
- **MAKE CD** (double speed recording and auto-finalize) - fast recording of a disc or programmed tracks. Recording will be finalized automatically.
- **DISC AT ONCE** (Disc-At-Once double speed recording and auto-finalize) - fast recording of a complete disc for mastering purposes. Disc will be recorded as a finalized disc.

For recording from external sources:

- **REC EXT DISC** (SYNC recording) - to make an automatic recording of an external source simply by starting the source.
- **REC EXT MAN** (manual start recording) - to start a manual recording from an external source.

Note:

- When **Auto track is on** (default setting) during manual recording, **track numbers will automatically be increased during recording.**

Notes about CD-Text:

- Discs and tracks copied from the internal CD-Player drive will have the same CD-Text information as the source.
- CD-Text information is not passed through external analog and digital connections. Therefore, discs and tracks copied from an external CD source that contains CD-Text information will not receive any CD-Text information from the source.

Warning:

Recording is no longer possible after finalizing a CD-R disc!

Remarks about recording

- The recording procedure is the same for CD-Rs and CD-RWs.
- If the disc already contains recordings, the CD-Recorder will automatically search for the end of the last track, so that recording can start from there.
- **There must be at least 7 seconds of recording time left on the disc**, otherwise you will not be able to enter record standby mode. **DOES NOT FIT** will light up.
- A maximum of 99 tracks can be recorded on a disc. Minimum allowable track length is 4 seconds.
- Recordings from DAT or DCC players will not always stop automatically.
- SRC (Sample Rate Conversion)
This CD-Recorder can perform Sample Rate Conversion on the incoming digital signal, it is capable of handling sources ranging from 11 kHz up to 56 kHz.
If a non 44.1 kHz (± 100 PPM) source is connected, this CD-Recorder will automatically switch on the SRC.
- If the digital source is 44.1kHz (± 100 PPM) the SRC will be automatically bypassed.
- If the recording source is a special disc such as HDCD or DTS, you have to
 - set source sampling frequency to 44.1kHz.
 - use a digital connection.
 - set the digital rec-volume of the CDR500 to 0 dB.
- When you copy the tracks from a DAT recorded by different sampling frequencies, noise might be recorded in the disc when the sampling rate changes.
- See page 23 for information about the recording menu settings.

Important:

If you want to play a recorded CD-R disc on any regular CD player, it must first be finalized. (See FINALIZING/ UNFINALIZING page 15.)

Finalized CD-RW discs play only on CD-RW compatible CD players.

If the disc is a CD-RW and is already finalized you must unfinalize it first to record onto it.

- If a finalized CD-R disc is inserted in the CD-Recorder drive, **FINALIZED CD** will be displayed. **Recording is not possible.**
- If a finalized CD-RW disc is inserted in the CD-Recorder drive, **UNFINALIZE** and **PRESS ENTER** will be displayed when the **REC MODE** (10) is pressed. If the **REC LEVEL/SELECT** (13) knob is pressed, the disc will be unfinalized.

See page 1 for more information on CD-R and CD-RW discs and compact Disc Care.

RECORDING (FROM INTERNAL CD-PLAYER)

The numbers between parentheses refer to the fold-out.

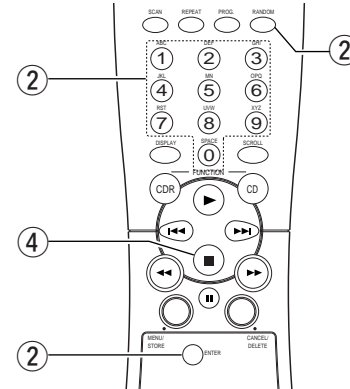
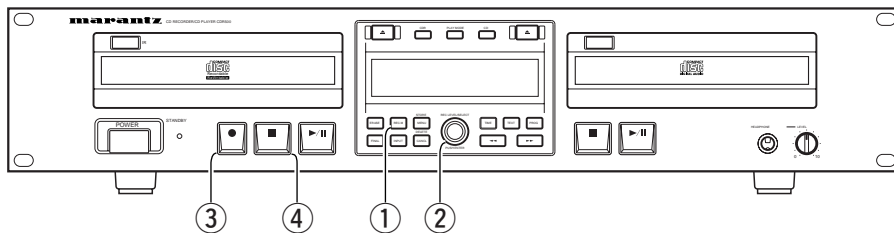

Double speed recording

Using the internal CD-Player drive.

- During double speed recording the sound is not audible.
- ① **Make sure that the recording disc is absolutely free of scratches and dust particles.**

- ② **To choose the type of recording, press *REC MODE* (10).**
once: to select *RECORD FAST* if you wish to make a fast recording of a disc or programmed tracks.
three times: to select *MAKE CD* if you wish to make a fast recording of a disc or programmed tracks and to automatically finalize the recording. Also see 'FINALIZING CD-R & CD-RW' discs on page 15.

The **DUBBING** display starts blinking. After 3 seconds the display shows the remaining CD-R/RW recording time on the left and total time of source on the right. (every 2 seconds *PRESS RECORD* is displayed.) Both selection indicators are lit.

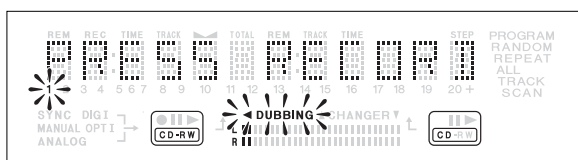
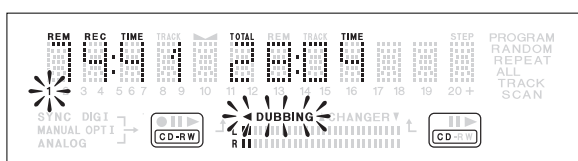
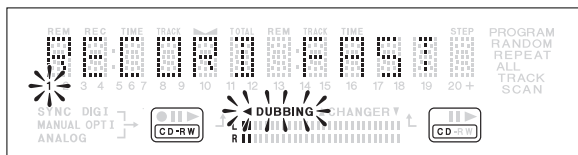

- ③ **Press *PROG* (18 or 91) to select one or more tracks for recording (see PROGRAMMING):**
 - rotate the *REC LEVEL/SELECT* (13) key to the required track number, then press *REC LEVEL/SELECT* (13).
- or:
- directly select the track number via the *10-key pad* (76) on the remote control, then press *REC LEVEL/SELECT* (13).

- ④ **To start recording press ● (4).**

→ The display shows the real remaining time for the selected recording. High speed recording starts.

◀ **DUBBING** lights continuously.

- To check the elapsed recording time, press *TIME* (14) or *DISPLAY* (77). This can be done during recording.
- Recording will stop automatically.

- ⑤ **To stop recording manually, press ■ *STOP* (5, 87).**

→ ◀ **DUBBING** goes out and recording stops.

- If ■ *STOP* (5, 87) is pressed within 3 seconds after ● (4) is pressed, no recording will take place.
- After recording, the display shows *UP DATE* for several seconds. The Total time indications can differ slightly. However, no music information is lost.

Note:

- In this Recording mode, the Pause function is not operative.

Important:

If you want to play the recorded CD-R/RW disc on any regular CD player, it must first be finalized. (See **FINALIZING/UNFINALIZNG** page 15).

Finalized CD-RW discs play only on CD-RW compatible CD players.

There is a chance that the sound will be distorted if the recording level is set at a value that exceeds 0 dB for digital sound sources and -12dB for analog sound sources. The factory settings at the time of shipping are 0 dB for digital sound sources and -12dB for analog sound sources.

RECORDING (FROM INTERNAL CD-PLAYER)

The numbers between parentheses refer to the fold-out.

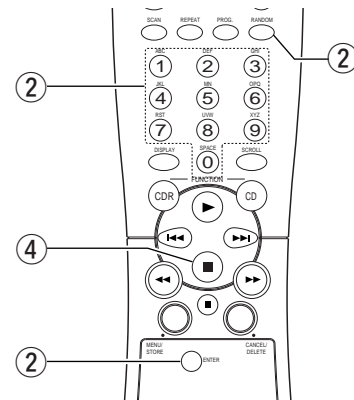
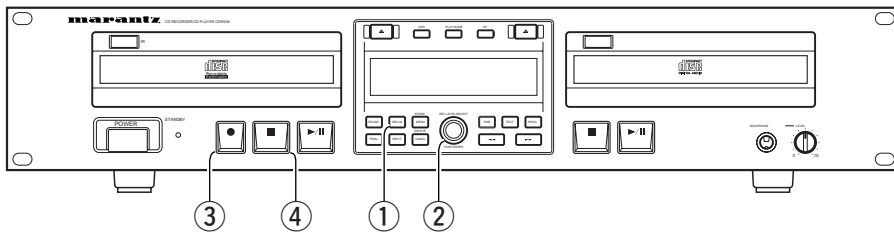

ENGLISH

Normal speed recording

Using the internal CD-Player drive.

- During the normal speed recording, you can listen to the recording while you are making it.
- ① **Make sure that the recording disc is absolutely free of scratches and dust particles.**
- ② **Press REC MODE (10) twice.**
 - The ◀ **DUBBING** display starts blinking. After 3 seconds the display shows the remaining CD-R/RW recording time on the left and total time of source on the right. (every 2 seconds PRESS RECORD is displayed) Both selection indicators are lit.

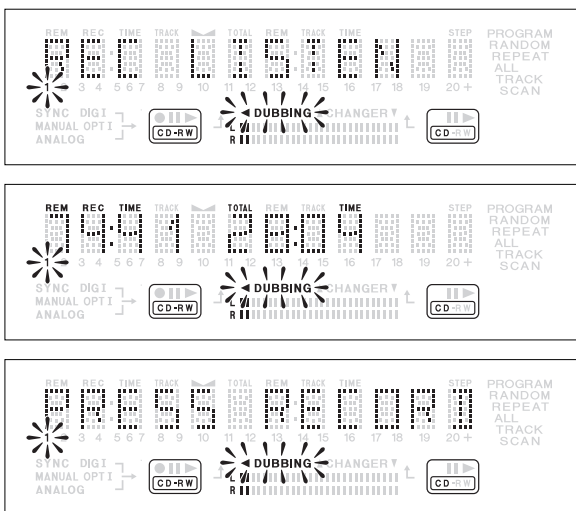

- ③ **Press PROG (18 or 91) to select one or more tracks for recording (see PROGRAMMING page 19):**
 - rotate the REC LEVEL/SELECT (13) key to the required track number, then press PUSH ENTER (13).
- or:
- directly select the track number via the 10-keypad (76) on the remote control, then press REC LEVEL/SELECT (13).
- ④ **To start recording, press ● (4).**
 - ➔ ◀ **DUBBING** lights continuously and the selected track or program is copied at normal speed. The recording time left will appear.

- To check the elapsed recording time, press TIME (14) or DISPLAY (77) on the remote control. This can be done during recording.
- Recording will stop automatically.
- ⑤ **To stop recording, press ■ (5, 87).**
 - ➔ ◀ **DUBBING** goes out and recording stops.
- If ■ STOP (5, 87) was pressed within 3 seconds after ● (4), no recording will take place.
- After recording, the display shows UPDATE for several seconds. The Total time indications can differ slightly. However, no music information is lost.

Note:

In this recording mode, the Pause function is not operative.

Important:

If you want to play the recorded CD-R/RW disc on any regular CD player, it must first be finalized. (See FINALIZING/UNFINALIZING page 15.)

Finalized CD-RW discs play only on CD-RW compatible CD players.

There is a chance that the sound will be distorted if the recording level is set at a value that exceeds 0 dB for digital sound sources and -12dB for analog sound sources. The factory settings at the time of shipping are 0 dB for digital sound sources and -12dB for analog sound sources.

RECORDING (FROM INTERNAL CD-PLAYER)

The numbers between parentheses refer to the fold-out.

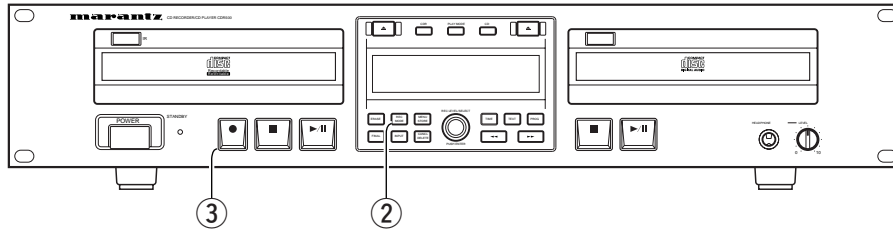

Disc At Once (DAO) recording

The DAO function makes a complete copy of a source CD without stopping. Therefore, the lead-in (TOC), program (audio data), and lead-out portions of the disc are all recorded without linking point errors. Linking point errors occur every time the laser starts and stops a recording, including when a disc is finalized.

A disc recorded using DAO should be completely free of any linking point errors which will allow DAO recorded discs to be used as a master for duplication. The DAO function can also be used for discs that are having trouble playing in some CD players, where the DAO function can act as a "clean up" so that a clean, error free copy can be made of a bad disc.

- ① Make sure that the recording and source disc are absolutely free of scratches and dust particles.
 - ② Press **REC MODE** (10) four times so that **DISC AT ONCE** appears on the display.
- The **◀ DUBBING** starts blinking. After 3 seconds, the remaining CD-R/RW recording time, total time of CD disc, and **PRESS RECORD** will be shown continuously on the display.

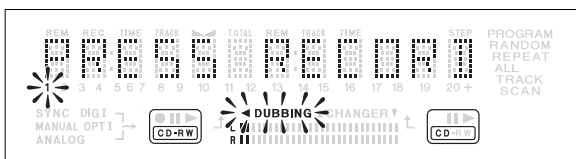
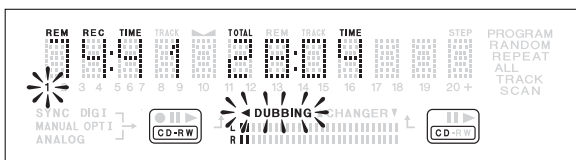
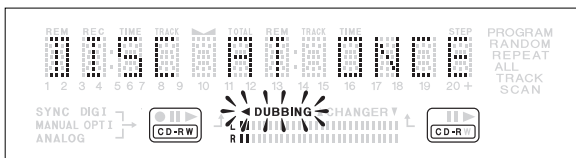

- ③ To start recording, press **●** (4).
 - ➔ The total remain time of recording appears on the display. It starts recording.
 - ◀ **DUBBING** lights continuously.

Note:

- Once DAO recording is started, you cannot stop recording.
- The DAO function cannot record correctly if the source CD disc has scratches or dust particles.

Important:

The DAO function will not allow copying in the following situations:

- The source disc is an un-finalized CD-R or CD-RW.
- The recording disc is not blank.

Because the DAO function will record the lead-in area, the program area and read-out area continuously, you don't have to finalized the recorded disc.

If you unfinalize a DAO recorded CD-RW disc, all the disc information will be lost.

RECORDING

The numbers between parentheses refer to the fold-out.

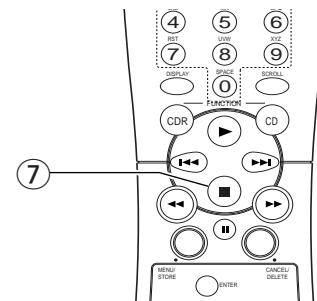
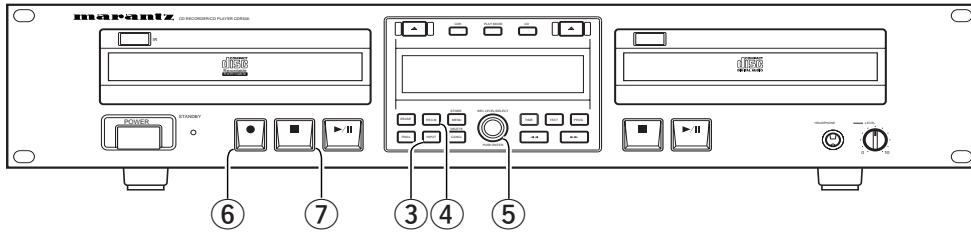

ENGLISH

Manual start recording

About AUTO TRACK and AUTO STOP

- AUTO TRACK is a function to increment track numbers either manually or automatically.
 - AUTO TRACK ON** : track numbers will be automatically incremented according to the source. (See the table on page 23)
 - AUTO TRACK OFF**: track numbers are manually incremented by pressing **TRACK INCR.** (73).
- When AUTO TRACK is ON, you can also set the AUTO STOP function.
 - AUTO STOP ON** : the recording will be stopped automatically. (See the Table on page 23.)
 - AUTO STOP OFF**: the recording has to be stopped manually.

- Make sure the disc is absolutely free of scratches and dust particles.
- Connect the CDR500 to an external source. (see INSTALLATION page 5 and 6.)
- Press **INPUT** (9) repeatedly until the selected external source appears on the display (depending on the connection used):
 - **DIGI**, **OPT I** or **ANALOG** lights up and **DIGITAL I**, **OPTICAL** or **ANALOG** appears on the display.

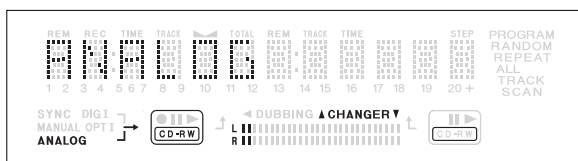

- With the recorder stopped, press **REC MODE** (10) five times to enter the Manual Record standby mode.
 - **REC EXT MAN.**

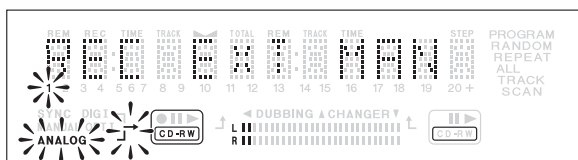

- If **DIG I** or **OPT I** flashes, the digital data is not being received correctly. Check all connections and settings on both the source unit and the CDR500.

5 Set the optimal recording level on the CD-Recorder.

- Play the source first to set the optimal recording level on the CD-Recorder.
- Rotate the **REC LEVEL/SELCT** (13) key until, on the Record/Play Level bar, all the blue segments light but the red segments do not light continuously during the loudest passages.
 - DIGITAL RECORDING : +6dB ~ -63dB
 - ANALOG RECORDING: 0dB ~ -63dB
- Stop the source.
 - To record a 3-second silence at the start of a track, press **▶/||** (6) or **||** (82) before starting the source.

6 To start recording, press ● (4) on the CD-Recorder and immediately start the source.

- The track number and recording time left appear on the display.
- If **■** (5, 87) is pressed within 3 seconds after **●** (4), no recording will take place.
 - To check the elapsed recording time, press **TIME** (14) or **DISPLAY** (77). (This can also be done during the recording.)

7 To stop recording, press ■ (5, 87).

- To pause recording, press **▶/||** (6) or **||** (82).

After recording, the display will show **UPDATE** for several seconds as it finishes recording.

Note:

The recorded sound might be distorted when you adjust the recording level above 0dB for digital recording and -12dB for analog recording. The default setting of record level for digital is 0dB and analog is -12dB.

Important:

If you want to play the recorded CD-R/RW disc on any regular CD player, it must first be finalized. See finalizing discs on page 15.

Finalized CD-RW discs play only on CD-RW compatible CD players.

RECORDING

The numbers between parentheses refer to the fold-out.

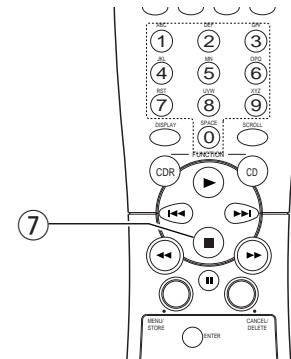
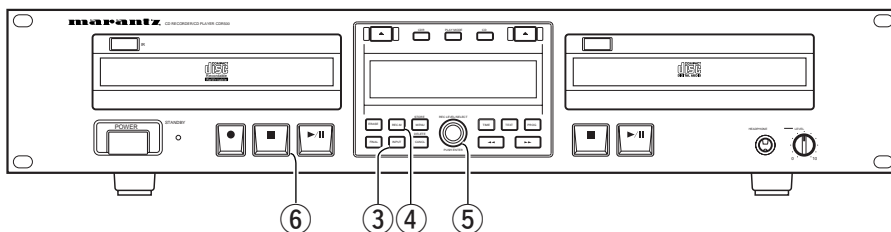

Sync Recording

The SYNC feature enables you to make fast and easy recordings from an externally connected CD, DAT, or MD. Track increments are automatically detected from the source material and cannot be added manually. For analog source material, a silence of 2.7 seconds or more is automatically detected as a track increment. (See page 22 for more detail)

- ① Make sure the disc is absolutely free of scratches and dust particles.
- ② Connect the CDR500 to an external source. (see INSTALLATION from page 5 and 6.)
- ③ Press **INPUT** (9) repeatedly until the selected source appears on the display (depending on the digital connection used):
 - **DIGI**, **OPT I** or **ANALOG** lights up and **DIGITAL**, **OPTICAL** or **ANALOG** appears on the display.

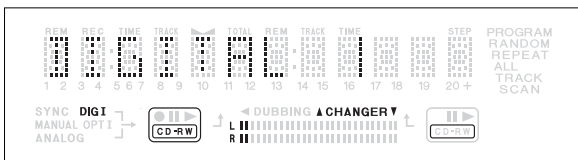

- ④ With the CD-Recorder stopped, press **REC MODE** (10) six times.
 - **SYNC** start to flash and the display shows **REC EXT DISC**.

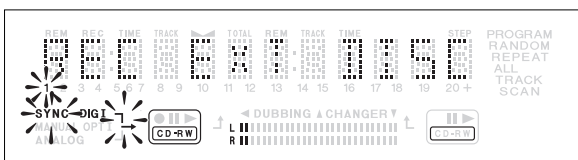

- If **DIGI** or **OPT I** flashes, the digital data is not being received correctly. Check all connections and settings on both the source unit and the CDR500.

Note:

- You can adjust the recording level by rotating **REC LEVEL/SELECT** (13).
- DIGITAL RECORDING : +6dB ~ -63dB
- ANALOG RECORDING : 0dB ~ -63dB

- You can adjust the recording balance by pressing the **STORE/MENU** (12 or 83) button and then pressing **REC LEVEL/SELECT** (13). Rotate **REC LEVEL/SELECT** to adjust the balance. Press **STORE/MENU** when finished.
- EQUAL BALANCE : L = 100 , R = 100
- ALL LEFT CHANNEL : L = 200 , R = 0
- ALL RIGHT CHANNEL : L = 0 , R = 200

- ⑤ To start recording, press **PLAY** on the selected source.
 - The CDR500 automatically starts to record. The recording time left appears on the display.
 - If, however, you start the source in the middle of a track, SYNC recording starts at the beginning of the next track (or track ID) or after 2.7 seconds of silence in analog recordings.
 - To check the elapsed recording time, press **TIME** (14) or **DISPLAY** (77). (This can also be done during recording)
 - The recorder stops automatically.

- ⑥ To stop recording manually, press **■** (5, 87).
 - If **■** (5, 87) is pressed within 3 seconds after pressing **PLAY** on the selected source, no recording will take place.
 - To pause recording, press **▶/||** (6) or **||** (82). To resume recording, press **●** (4) on the CDR500.

After recording, the display will show **UPDATE** for several seconds as it finishes recording.

Note:

- Recordings from DAT, DCC or analog sources will only stop after 20 seconds silence.
- **MAKE CD** is a recording mode that will auto finalize after synchronized recording. It takes about 1 minute to start auto finalizing after the last track is finished. (**WAIT** appears on the display.)
- The recorded sound might be distorted when you adjust the recording level above 0dB for digital recording and -12dB for analog recording. The default setting of record level for digital is 0dB and analog is -12dB.

Important:

If you want to play the recorded CD-R/RW disc on any regular CD player, it must first be finalized. See finalizing discs on page 15.

Finalized CD-RW discs play only on CD-RW compatible CD players.

FINALIZING/UNFINALIZING

The numbers between parentheses refer to the fold-out.

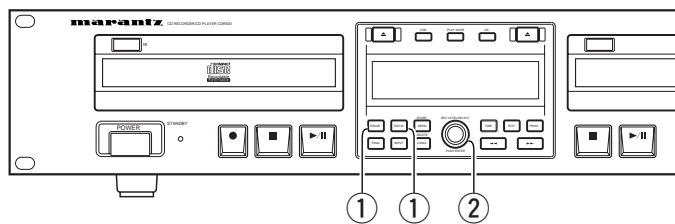
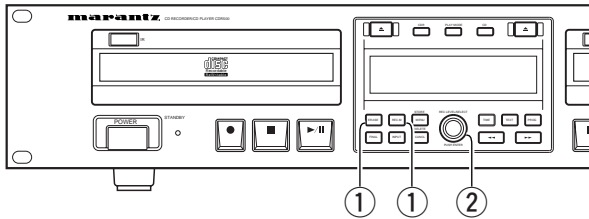

ENGLISH

Finalizing CD-R & CD-RW discs

Finalizing is necessary to:

- be able to play the recorded CD-R/RW disc on a CD player.
- avoid further unwanted recordings on a disc.
- avoid erasure of tracks on a CD-RW.

Note:

- A finalized CD-R disc can never be recorded onto again.
- A finalized CD-RW disc can be unfinalized for continued recording.
- Finalizing is the process of writing the TOC (Table of Contents) on a disc so that a CD player can recognize the contents of the disc.
- The CD-Player drive is able to play back un-finalized CD-R and CD-RW discs.

Auto finalizing

Auto finalizing is possible when using the **MAKE CD** recording function.

Manual finalizing

① With the recorder stopped press **FINAL (8)**.

- The display shows **FINALIZE CD** and **PRESS RECORD**.

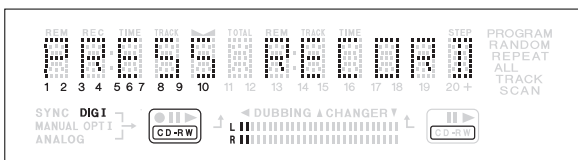
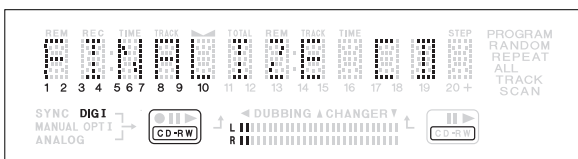

② Press **● (4)**.

- **xxxx FINAL** and the approximate finalization time appears on the display. Finalizing will take at least 2 - 4 minutes. The display counts down through the finalization. On completion, the total number of tracks and the total time recorded appears on the display. The CD-R or CD-RW indication in the display will change to CD.

Note:

During finalization, the CDR500 accepts no operating commands.

Unfinalizing CD-RW discs

For CD-RW discs only.

If you want to make more recordings or erase unwanted tracks on a finalized disc, you must unfinalize it first. The unfinalize process erases the TOC (Table of Contents) from the disc.

① With the CD-Recorder stopped, press **REC MODE (10)** or **ERASE (7)**.

- **UNFINALIZE** and **PRESS ENTER** will appear on the display.

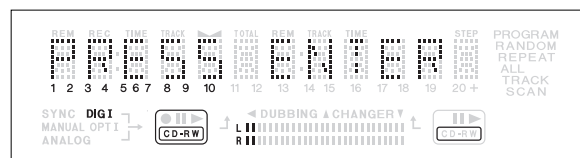
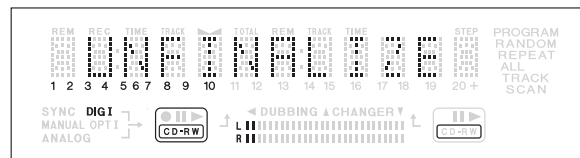

② Press **REC LEVEL/SELECT (13)**.

- The disc will now be unfinalized and can be recorded on again.

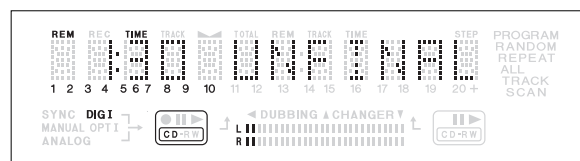

Note:

- Unfinalizing will take approximately 1.5 minutes.
- When Unfinalizing a CD-RW disc with text written on it, the text will be transferred to the CDR500Text Memory. If the Text Memory of the CDR500 is full because of text from other unfinalized discs, the **MEMORY FULL/FINALIZED CD** message will be displayed. In order to obtain memory space, text on this disc or on the other discs must be erased or other discs with stored text need to be finalized. See page 20 and 21 for more information regarding CD-Text and the Text Memory.

ERASING

The numbers between parentheses refer to the fold-out.

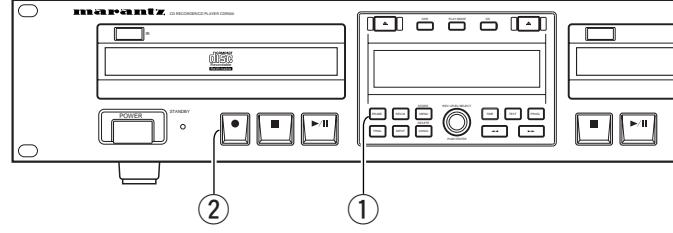
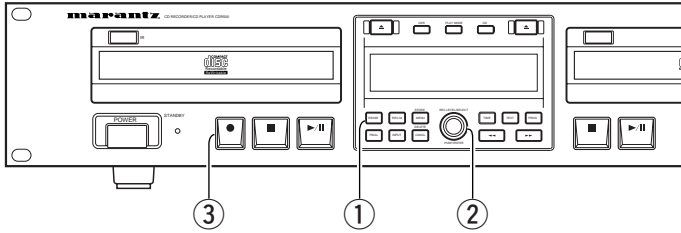

Erasing

For unfinalized CD-RW discs only.

You can erase:

- one or more tracks from the end, or
- the entire disc.

Erasing one or more tracks from the end

1 Press ERASE (7) once.

→ The display shows the number of tracks and their total playing time. ERASE TRACK and PRESS RECORD lights up.

- If the disc is finalized, CD appears on the display after inserting a CD-RW in the recorder drive. The CDR500 will ask you to confirm Unfinalizing first. Confirm by pressing the REC LEVEL/SELECT (13) knob or ENTER (84) on the remote control.

2 Select the number of track(s) you wish to erase by turning the REC LEVEL/SELECT (13) knob to the left and confirm by pushing the knob.

- The selected track numbers start blinking on the track bar.
- The display shows the remaining number of tracks and the remaining playing time after erasing the selected track(s).

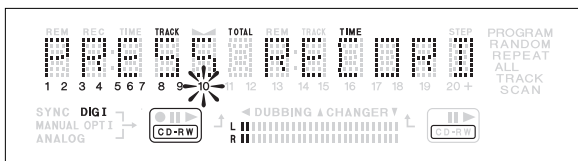
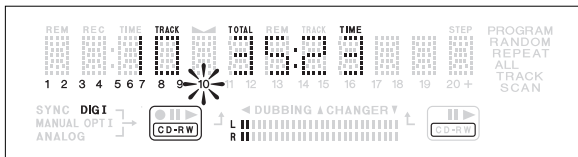

3 Press ● (4).

- The display shows the total countdown time and ERASE appears on the display.
- After the selected track(s) have erased, the display shows the remaining tracks and their total playing time.

Erasing the entire disc

1 Press ERASE (7) twice.

→ The display shows the number of tracks and their total playing time. ERASE DISC and PRESS RECORD light up.

- If the disc is finalized, CD appears on the display after inserting a CD-RW in the recorder drive. The CDR500 will ask you to confirm Unfinalizing first. Confirm by pressing the REC LEVEL/SELECT (13) knob or ENTER (84) on the remote control.

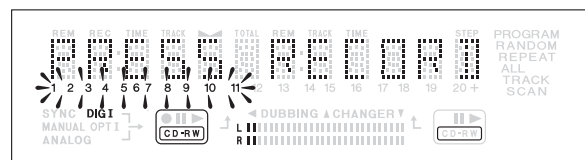
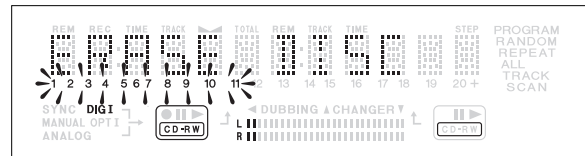

2 Press ● (4).

→ The display shows the total countdown time and ERASE appears on the display. The complete disc will be erased.

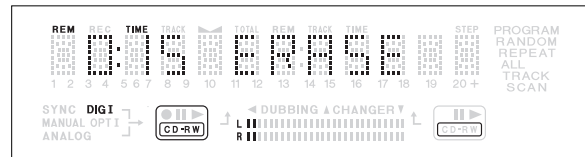

Erasure of a complete disc may take up to 15 seconds.



PLAYING

The numbers between parentheses refer to the fold-out.

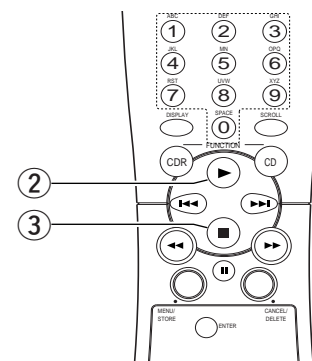
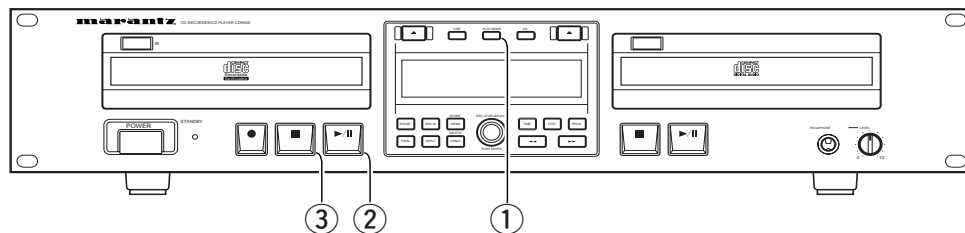

ENGLISH

Changer Mode

The Changer Mode is the default play mode of the CDR500 and will operate in such a way that both the CD-Recorder and CD-Player drive of the unit work together as one. Only one deck can play at a time and both output from the CDR jacks.

The Changer Mode can be used to continuously play two discs or a program can be created that is a mix of tracks between two discs.

Note:

- Recording can only be started while in the Changer Mode.
- The CD-Player drive will also always output to the CD jacks.

① Select Changer mode using the **PLAY MODE (26)** button.

- **CHANGER** appears on the display and **▲CHANGER▼** lights up.

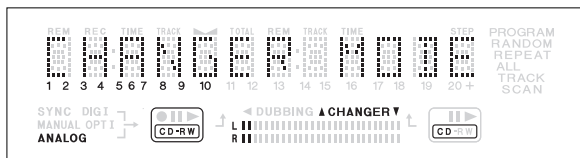

② On the deck you want to play, press **▶/|| (6, 20)** to start playback.

- The track number and track time of the selected track appear on the display.
- After the first disc has finished playing, the disc in the other deck will automatically start playing from the beginning.
- After the second deck has finished playing the unit will enter the stop mode.
- Press **TIME (14)** or **DISPLAY (77)** once, twice or three times to see:
 - remaining track time, total remaining time, text information (see MENU MODE page 21).
- To interrupt play temporarily, press **▶/|| (6, 20)**.
 - **||** lights on the display.
- To continue play, press **▶/|| (6, 20)** again.

③ To stop play, press **■ (5, 87)**.

- The number of tracks and the total playing time appear on the display.

Note:

DISPLAY (77) button is only on the remote control.

Dual Mode

The Dual Mode allows both the CD-Recorder and CD-Player drive to playback and operate independently of each other, so as to simulate two separate CD players. Both can play back at the same time and are output to separate jacks.

The Dual Mode can be used to playback two discs in two separate locations or in a DJ-type mixing application.

Note:

- Recording can only be started while in the Changer Mode. Press the **PLAY MODE (26)** button in order to start recording.

① Select Dual Mode using the **PLAY MODE (26)** button.

- **DUAL MODE** appears on the display and **↕** lights up.

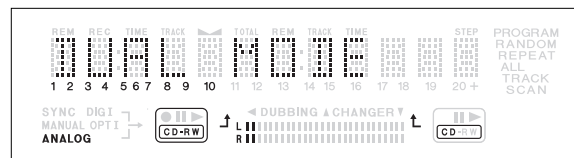

② On the deck you want to play, press **▶/|| (6, 20)** to start playback.

- **▶** lights up and the track number and track time of the track in play appear on the display.
- Press **TIME (14)** or **DISPLAY (77)** once, twice or three times to see:
 - remaining track time, total remaining time, text information (see MENU MODE page 21).
 - If you want to see this information about the other deck, press **CDR (27)** or **CD (25)**.
- To interrupt play temporarily, press **▶/|| (6, 20)**.
 - **||** lights on the display.
- To continue play, press **▶/|| (6, 20)** again.

③ To stop play, press **■ STOP (5, 87)**.

- The number of tracks and the total playing time appear on the display.

PLAYING

The numbers between parentheses refer to the fold-out.

EX: Selecting a track when CD play is stopped

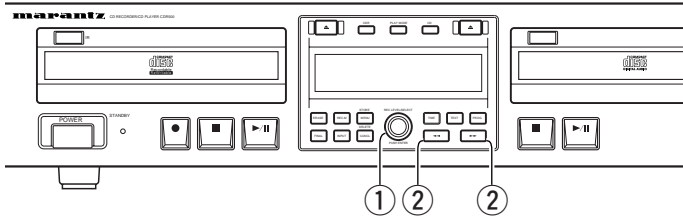

EX: Search

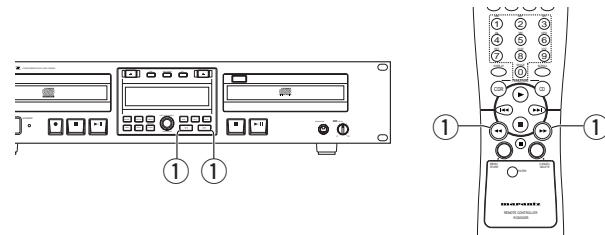

Selecting a track

Selecting a track during play

- **On the CDR500.**
 - ① Turn the *REC LEVEL/SELECT* (13) knob until the required track number appears on the display.
 - Play skips to the beginning of the selected track.
- **On the remote control <i>>**.
 - ② Key in the required track number using the *NUMERICAL* (76) keys. For 2-digit track numbers, press the keys in rapid succession.
 - Play skips to the beginning of the selected track.
- **On the remote control <i>ii>**.
 - ③ Press **◀◀** (80) or **▶▶** (88) one or more times.
 - Play skips to the beginning of the present, previous or subsequent tracks.

Selecting a track when CD play is stopped

- **On the CDR500.**
 - ① Turn the *REC LEVEL/SELECT* (13) knob until the required track number appears on the display.
 - ② Press *REC LEVEL/SELECT* (13) to confirm or press **▶/II** (6) to start playing.
- **On the remote control <i>>**.
 - ① Key in the required track number using the *NUMERICAL* (76) keys. For 2-digit track numbers, press the keys in rapid succession. Play starts.
- **On the remote control <i>ii>**.
 - ① Briefly press **◀◀** (80) or **▶▶** (88) one or more times.
 - ② Start playback by pressing **▶** (79) or *ENTER* (84).

Note:

When in Changer Mode, tracks can be selected from both the CD-Recorder and CD-Player drives without having to press any drive select buttons on the front panel or remote.

Scan play

- ① Press **SCAN** (74) on the remote control.
 - The first 10 seconds of each track will be played.
 - The CDR500 automatically stops after playing all tracks.
- ② To stop scan play, press **■** (87).
 - The SCAN indication disappears from the display.

Note:

Scan play is only available in Changer Mode.

Search

- ① Press **▶/II** (6) or **▶** (79).
- ② Hold down **◀◀** (15, 81) or **▶▶** (17, 86).
 - The drive first searches backwards or forwards at 10 times normal speed with sound at low volume, then goes to 50 times normal speed with sound muted.
- ③ Release the button at the desired point.
 - Play starts at the desired point.

Note:

During Random, Repeat Track or Programmed play, search is restricted to within the track being played at the time.

Random play

- ① Press **RANDOM** (92) before or during CD play to start random play.
 - All the tracks or programmed tracks on the discs in the CD-Recorder drive and the CD-Player drive will be randomly played.
- ② Press **RANDOM** (92) again to return to normal CD play.

Note:

- Random play is only available in Changer Mode.
- Random is also cleared if you open the disc tray.

Repeat play

- ① Press **REPEAT** (75) one or more times during CD play.
 - When **REPEAT TRACK** lights up, the current track plays repeatedly. When **REPEAT ALL** lights up, both discs or the program plays repeatedly.

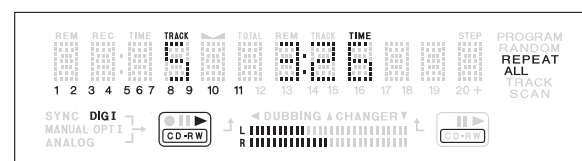

- ② To return to normal play, press **REPEAT** (75) one or more times until:
 - The **REPEAT** indication disappears from the display.

Note:

- If Repeat All is selected during Changer Mode, discs in both the CD-Recorder drive and CD-Player drive will be sequentially repeated.
- Repeat is also cleared if you open the disc tray.

PROGRAMMING

The numbers between parentheses refer to the fold-out.

Programmed play

- You can program up to 99 tracks to play in any desired sequence.
- Tracks can be programmed more than once.

Programming for playback

- Select **Changer mode** or **Dual mode** using the **PLAY MODE (26)** button.
 - **CHANGER** or **DUAL MODE** appears on the display.
- Press **CDR (27, 78)** or **CD (25, 89)** to select the required deck.
 - Selected deck lights up in the display.
- Press **PROG (18, 91)** to enter **Program mode**.
 - **PROGRAM** indication flashes and **PROGRAM** appears on the display.

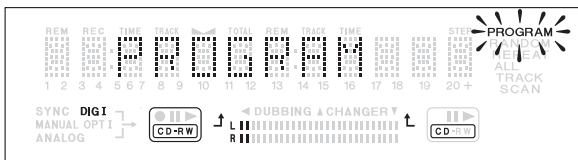

- Select the required track numbers by turning the **REC LEVEL/SELECT (13)** knob left or right and store by pressing the knob.

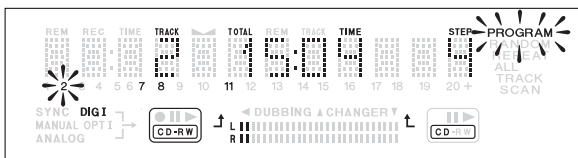

OR:

Key in a track number with the NUMERICAL (76) keys.
For 2-digit numbers, press the keys in rapid succession and store by pressing **REC LEVEL/SELECT (13)** or **ENTER (84)**.

- The track will be stored in the program.
- The track number, total program time and the number of programmed tracks (steps) are displayed.

- Repeat step ② - ④ for all tracks to be programmed.
- Press **■ (5, 87)** or **PROG (18, 91)** to end programming.
 - **PROGRAM** lights continuously.
- Press **▶/|| (6, 20)** or **▶ (79)** to start programmed play.

Clearing a program

- Press **■ (5, 87)** to stop programmed play.
 - Press **■ (5, 87)** again to clear the program.
 - **PROGRAM** indication disappears from the display.
- The program is also cleared if you open the disc tray.

Erasing a track from a program

- In **Stop mode** press **PROG (18, 91)** to enter **Program mode**.
- Use the **REC LEVEL / SELECT (13)** knob, the **◀◀ (80)** or **▶▶ (88)** keys, the **◀◀ (15, 81)** or **▶▶ (17, 86)** keys, or the **NUMERICAL (76)** keys to select the programmed tracks to be erased.
 - The track number and program step will be shown on the display.
- Press **DELETE/CANCEL (11, 85)** to erase the track from the program.
 - The remaining program steps and the remaining playing time of the program will be displayed.

Programming for recording

- Press **REC MODE (10)** to select the required recording mode (see 'RECORDING').
- Compile your program by repeating steps ③ to ⑤ as described in "programming for playback".
 - Only tracks from the disc in the CD-Player drive can be stored.
- Press **● (4)** to start recording.

Note:

- To review the program, press **PROG (18, 91)**, followed by **◀◀ (15,81)** or **▶▶ (17, 86)** with the CD-Player or CD-Recorder in stop mode.
- To add more tracks to the program, repeat steps ① to ⑤.
- If you try to store more than 99 tracks, **PROG FULL** appears on the display.

MENU MODE

The numbers between parentheses refer to the fold-out.

EX: Storing names of Text settings

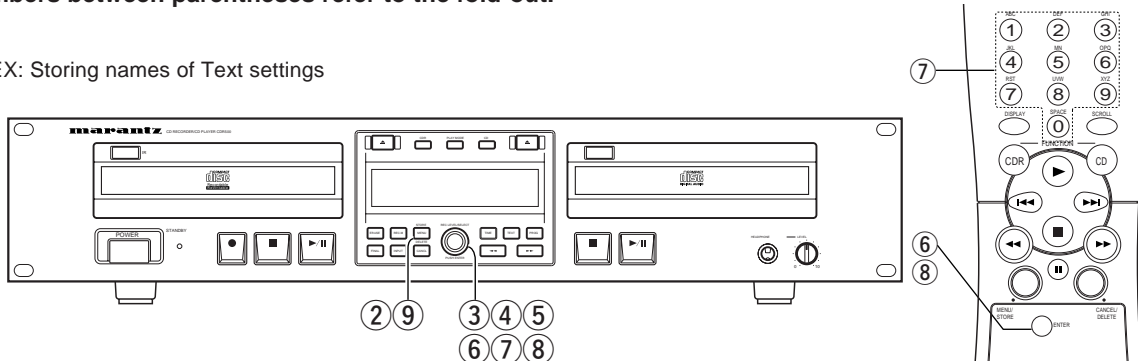

About MENU MODE

MENU MODE allows more sophisticated settings for making CDs. There are two kinds of submenus in the MENU MODE.

- Text submenus adding and erasing the CD-Text
- Recording submenus ... Auto track increment ON/OFF
 - ... Auto stop ON/OFF
 - ... Copy protection
 - ... Adjusting right-left balance during the recording

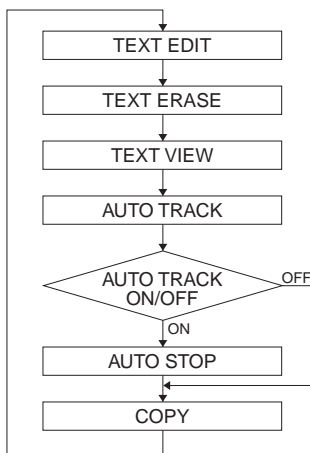

Structure of MENU in the STOPMODE

Note:

- When AUTO TRACK increment is OFF, AUTO STOP does not appear in the menu.
- CD-Text can only be edited on unfinalized discs. (finalized CD-RW discs must be unfinalized)

Text Submenus

The CD-Text feature allows the CD title, artist names, and the track names to be saved on any disc you record. When played back on the CDR500 or any other CD player/recorder that supports CD-Text, the CD-Text information stored on the disc will be displayed.

Note:

Products that offer CD-Text display are available from Marantz, Marantz Professional, and Superscope. Please contact your dealer for more information on these products.

Storing names

- 1 Press **STORE/MENU** (12, 83) to enter Menu mode. **TEXT EDIT** appears on the display.
- 2 Press **REC LEVEL/SELECT** (13) to select the **TEXT EDIT** submenus.
- 3 Press **PUSH ENTER** (13) or **ENTER** (84) to confirm.
- 4 Rotate **REC LEVEL/SELECT** (13) or press **◀◀** (80), **▶▶** (88) to select the required option in the submenu: CD Artist, CD Title, Track 1 Artist, Track 1 Title, etc.
- 5 Press **REC LEVEL/SELECT** (13) or **ENTER** (84) to confirm.
- 6 Select the characters by rotating the **REC LEVEL/SELECT** (13) or by pressing the corresponding numeric/alphabet key (76).

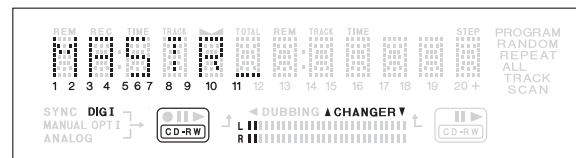

- 7 Press **REC LEVEL/SELECT** (13) or **ENTER** (84) to store the characters and move to the next cursor position.

Note:

- A maximum of 60 characters can be stored per item.
- With the **◀◀** (15, 81) **▶▶** (17, 86) keys you can move to a required cursor position.
- With the **CANCEL/DELETE** (11, 85) you can delete a character.
- By pressing the **REC LEVEL/SELECT** (13) or **ENTER** (84) without selecting a character first, you can insert a space between characters.
- When an artist's name has been stored for a certain track, the name will automatically be copied to the next track when you chose to edit the artist's name for the next track. To save the same name for the next track press **STORE/MENU** (12, 83) when it is displayed, or a new name can be entered as described above.

- 8 Press **STORE/MENU** (12, 83) to store a name you have entered and return to the submenu or **■** (5,87) to exit.

MENU MODE

The numbers between parentheses refer to the fold-out.

Erasing names

- ① Stay in the stop mode. (No Operation)
- ② Press **STORE/MENU** (12, 83) on the deck or the remote control to enter Menu mode.
- ③ Rotate **REC LEVEL/SELECT** (13) or press **◀◀** (80), **▶▶** (88) to select the submenu **TEXT ERASE**.
TEXT ERASE appears on the display.
- ④ Press **REC LEVEL/SELECT** (13) or **ENTER** (84) on the remote control to confirm.
- ⑤ Rotate **REC LEVEL/SELECT** (13) or press **◀◀** (80), **▶▶** (88) to select the required option in the submenu: All Text, CD Title, CD Artist, Track 1 Title, Track 1 Artist, etc.
- ⑥ Press **REC LEVEL/SELECT** (13) or **ENTER** (84) to confirm.
The display will ask you to reconfirm your selection.
- ⑦ Press **PUSH ENTER** (13) or **ENTER** (84) to reconfirm.
- ⑧ Press **STORE/MENU** (12, 83) to return to the submenu or **■** (5,87) to exit.

About TEXT

The input text data is saved in the text memory until the disc is finalized. Therefore, the data is not written in the CD-R/RW disc before finalizing the disc.

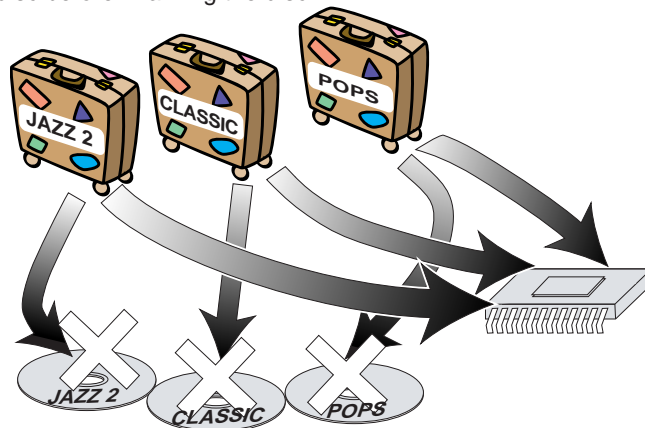

Finalizing the disc transfers the text data from the text memory to the disc.

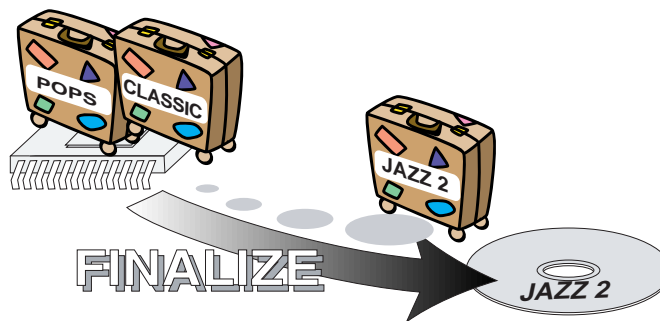

Unfinalizing the disc transfers the text data from the disc to the text memory.

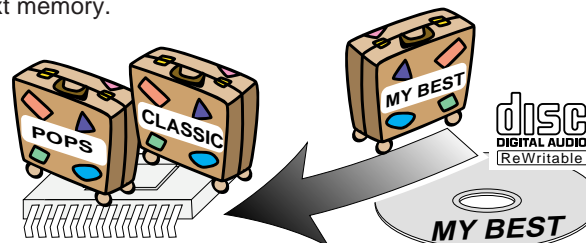

UNFINALIZE

When the text memory is full, **MEMORY FULL** appears on the display and you cannot add more text data.

In this case, you need to free up more space in text memory. You can either finalize one or more disc(s) to transfer the text data to each disc, or erase (part of) the text data in the text memory.

Note:

When the text memory is full depends on the amount of the input text data per disc and the number of discs. Typically the text memory can store for 50 discs of the text data consisting of 60 characters of an artist name or title for 20 tracks.

MENU MODE

The numbers between parentheses refer to the fold-out.

Text Memory Review/Erase Text Memory

All input CD-Text data is stored in the Text Memory of the CDR500 until the disc is finalized. If the text memory becomes full, the MEMORY FULL message will appear in the display and you will be unable to add more text. If you would like to add more text, you must finalize a disc that has text stored in the Text Memory or the text for a disc can be erased by following the procedure below.

Note:

The text for all unfinalized discs is accessible during the Text Memory Review mode. You do not need to insert the corresponding disc to erase its text.

- ① Stay in the stop mode. (No Operation)
- ② Press **STORE/MENU (12, 83)** on the deck or the remote control to enter Menu mode.
- ③ Rotate **REC LEVEL/SELECT (13)** or press **◀◀ (80), ▶▶ (88)** to select the **TEXT VIEW** submenu. **TEXT VIEW** appears on the display.
- ④ Press **REC LEVEL/SELECT (13)** or **ENTER (84)** to confirm.
- ⑤ Rotate **REC LEVEL/SELECT (13)** or press **◀◀ (80), ▶▶ (88)** to select the disc you wish to erase.

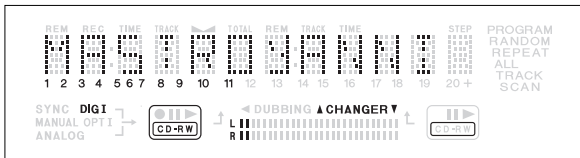

- ⑥ Press **REC LEVEL/SELECT (13)** or **ENTER (84)** to confirm. **ERASE MEMORY** appears on the display.

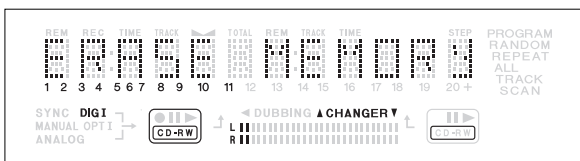

- ⑦ Press the **REC LEVEL/SELECT (13)** or **ENTER (84)** to confirm the erasure of the text for that particular disc.
- ⑧ Press **STORE/MENU (12, 83)** to return to the submenu or **■ (5,87)** to exit.

Note:

- If there are no discs in the memory, the message **MEMORY EMPTY** appears on the display.
- **MEMORY FULL/FINALIZE CD** may also appear when Unfinalizing a CD-RW disc for which text was stored (see 'UNFINALIZING CD-RW discs' page 15). The same action(s) should be taken in order to obtain memory space.

Recording submenus

The Auto Track increment menu selection determines whether the CDR500 automatically marks tracks based on the source (Auto Track ON) or if all track increments are made manually via the **TRACK INCR (73)** button (Auto Track OFF).

Note:

The **TRACK INCR (73)** buttons will mark a track mark during both Auto Track ON and OFF recording.

The most efficient way to record from a digital source is via a digital connection that contains user data. The user data part of a digital signal provides track information to the CD recorder. User data is usually found only in an SPDIF format digital connection. The AES/EBU standard does support user data information.

If Auto Track is ON and the source you are recording from is analog or digital without user data, the CDR500 will use a silence gap to mark tracks. As the chart below indicates, once the source signal drops below -55dB, the CDR500 will look for 2.7 seconds of no signal (-55dB or below). When the source signal returns and reaches a level of -35dB, the CDR500 will then mark a new track and continue recording.

Note:

If the silence gap is less than 2.7 seconds or the dB level never drops below -55dB, the CDR500 will probably not mark a track and continue to record on the same track number.

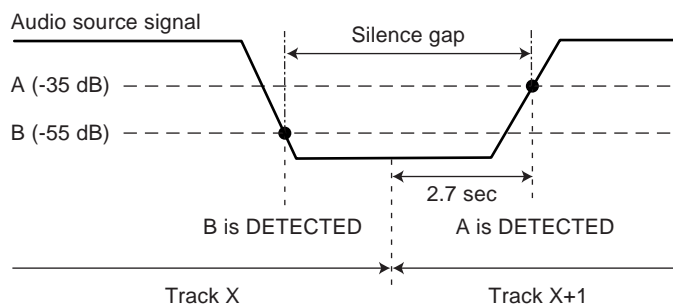

The chart below will help identify how each source will be handled by the Auto Track system.

AUTO TRACK	ON
Source	
CD/MD (with user data)	Track increment based on user data of incoming signal
DAT/DCC (with user data)	Track increment based on user data of incoming signal
Unknown (no user data)	Track increment after silence gap of 2.7 seconds on incoming signal
Analog	Track increment after silence gap of 2.7 seconds on incoming signal
No source (no lock)	None

MENU MODE

The numbers between parentheses refer to the fold-out.

Auto track increment

- ① Stay in the stop mode. (No Operation)
- ② Press **STORE/MENU** (12, 83) on the deck or the remote control to enter Menu mode.
- ③ Rotate **REC LEVEL/SELECT** (13) or press **◀◀ (80), ▶▶ (88)** to select the **AUTO TRACK** submenu. **AUTO TRACK** appears on the display.
- ④ Press **REC LEVEL/SELECT** (13) or **ENTER** (84) to confirm.
- ⑤ Select **Auto track ON** or **OFF** by rotating **REC LEVEL/SELECT** (13) or press **◀◀ (80), ▶▶ (88)**.

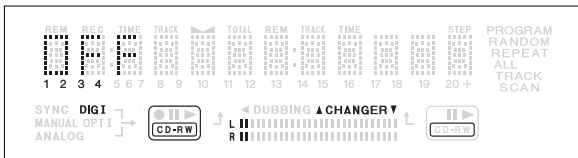

- ⑥ Press **REC LEVEL/SELECT** (13) or **ENTER** (84) to confirm.
 - When **ON** is selected, track numbers will be automatically incremented during recording.
 - When **OFF** is selected, you can mark the recorded tracks yourself by press **TRACK INCR** (73).
- ⑦ Press **STORE/MENU** (12, 83) to store settings and return to the submenu or **■ (5, 87)** to exit.

Note:

- The Auto Track menu item is also available during recording and in the record-standby mode.
- The Auto Track setting determines if the Auto Stop menu item is available. If Auto Track is OFF, Auto Stop is automatically OFF and the Auto Stop menu item is not displayed in the menu. If Auto Track is ON, the Auto Stop menu item is available and Auto Stop can be switched ON or OFF. See this page for information regarding the Auto Stop menu item.

Auto stop

If the Auto Track function is ON, the Auto Track menu item will become available. The Auto Stop function can then be turned ON or OFF depending on the recording requirements.

Note:

Auto Stop is automatically turned OFF and the menu item will not be displayed when Auto Track is OFF.

The benefit of turning Auto Stop OFF is, for example, when you are recording sources such as classical music, which could have long passages of low level sound. If Auto Stop is ON in such a case, the CDR500 may automatically stop during such a passage.

If Auto Stop is ON, the chart below indicates what amount of silence (-55dB or lower) is required for each source to trigger the CDR500 to stop recording. If Auto Stop is OFF, the CDR500 will record until stopped by the **STOP** (5,87) button or the end of the disc is reached.

AUTO STOP	ON
Source	
CD/MD (with user data)	Stop after 3 seconds of user DATA of stop pattern detected on the incoming source signal
DAT/DCC (with user data)	Stop after 20 seconds of silence
Unknown (no user data available)	Stop after 20 seconds of silence
Analog	Stop after 20 seconds of silence
No source (no lock)	Stop after 3 seconds of unlock

Note:

- The above silence time needed to stop will be recorded onto the last track of the recording.

- ① Stay in the stop mode.(No operation)
- ② Press **STORE/MENU** (12, 83) on the deck or the remote control to enter Menu mode.
- ③ Rotate **REC LEVEL/SELECT** (13) or press **◀◀ (80), ▶▶ (88)** to select the **AUTO STOP** submenus. **AUTO STOP** appears on the display.
- ④ Press **REC LEVEL/MENU** (13) or **ENTER** (84) to confirm.
- ⑤ Select **Auto stop ON** or **OFF** by rotating **REC LEVEL/SELECT** (13) or press **◀◀ (80), ▶▶ (88)**.
AUTO STOP ON : fully automatic stop.
AUTO STOP OFF : only manual stop during the recording.

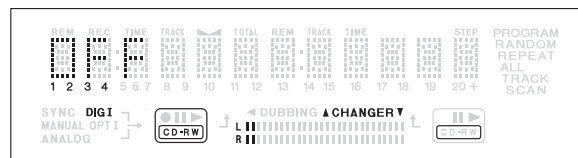

- ⑥ Press **REC LEVEL/SELECT** (13) or **ENTER** (84) on the remote control to confirm.
- ⑦ Press **STORE/MENU** (12, 83) to store setting and return to the submenu, or press **■ (5,87)** to exit.

Note:

- The Auto Track menu item is also available during the Record-Pause and Record modes.
- The Auto Track setting determines if the Auto Stop menu item is available. If Auto Track is OFF, Auto Stop is automatically OFF and the Auto Stop menu item is not displayed in the menu. If Auto Track is ON, the Auto Stop menu item is available and Auto Stop can be switched ON or OFF. See page 20 for information regarding the Auto Stop menu item.

MENU MODE

The numbers between parentheses refer to the fold-out.

Copy protection

All pre-recorded audio CDs include a digital mark indicating the copy protection status of the disc. This information is stored in the user data area of the disc and is transmitted in the SPDIF format digital output.

Since the CDR500 is a professional CD recorder, it will record from any digital source, ignoring the copy protection setting of the source material. Additionally, the CDR500 allows you to set the level of copy protection of each disc you record.

There are three settings for the copy protection on a disc:

Copy Protection OFF

This recording allows unlimited digital copying. A consumer digital recording device can digitally record this disc.

Copy Protection ON

This recording allows a single generation digital copy to be made for personal use. A consumer digital recording device will be able to digitally record this disc but the copy will have Copy Protection set to HCO so that further digital copies can not be made.

Copy Protection HCO (Home Copy protected Original)

This recording does not allow digital copying. A consumer digital recording device will not be able to make digital copies of this disc.

- ① Stay in the stop mode.(No operation)
- ② Press **STORE/MENU** (12, 83) to enter Menu mode.
- ③ Rotate **REC LEVEL/SELECT** (13) or press **◀◀ (80), ▶▶ (88)** to select the Copy submenus.
COPY appears on the display.
- ④ Press **REC LEVEL/SELECT** (13) or **ENTER** (84) to confirm.
- ⑤ Select Copy ON, OFF, or HCO by rotating **REC LEVEL/SELECT** (13) or press **◀◀ (80), ▶▶ (88)**.

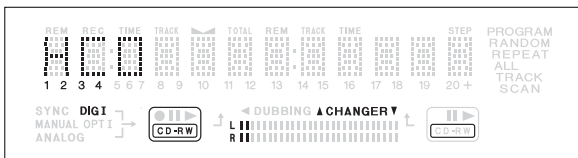

- ⑥ Press **REC LEVEL/SELECT** (13) or **ENTER** (84) to confirm.
- ⑦ Press **STORE/MENU** (12, 83) to store setting and return to the submenu, or press **■ (5,87)** to exit.

Note:

Analog sources do not carry copy protection.

Balance (Only active in Record/Standby mode)

During recording (with both analog and digital sources), the balance of the audio recorded onto the disc can be adjusted using the Balance menu item.

- ① Press **STORE/MENU** (12, 83) to enter Menu mode.
- ② Rotate **REC LEVEL/SELECT** (13) or press **◀◀ (80), ▶▶ (88)** to select the SET BALANCE submenu.
SET BALANCE appears on the display.

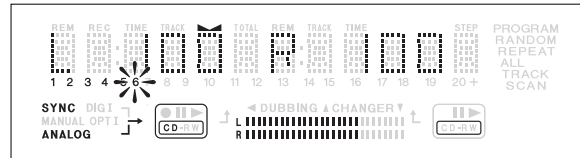

- ③ Press **REC LEVEL/SELECT** (13) or **ENTER** (84) to confirm.
→ **◀** and **L 100 R 100** appear on the display.
- ④ Adjust the recording balance by turning the **REC LEVEL/SELECT** (13) or press **◀◀ (80), ▶▶ (88)**.
- ⑤ Press **REC LEVEL/SELECT** (13) or **ENTER** (84) to confirm.
- ⑥ Press **STORE/MENU** (12, 83) to store settings.

Note:

The balance setting is not saved if a disc is changed or the power is switched off.



DISPLAY

Messages, as listed and explained here, may appear on the display for your guidance.

General

READING.....	reading disc information (page 8)
OPEN.....	during tray opening (page 8)
CLOSE.....	during tray closing (page 8)
NO DISC.....	no disc inserted, disc unreadable or disc inserted upside down
PROG FULL.....	program full (page 19)
INSERT DISC.....	insert disc or insert disc in correct way
WRONG DISC.....	inserted disc is not an audio CD (page 26)
UNFINALIZE D.....	unfinalized CD-R/RW disc
MEMORY ##P/B.....	indicates the amount of text memory used for unfinalized discs

Recording

WAIT.....	- when ■ STOP is pressed during recording - when ■ STOP is pressed during recording the first 4 seconds of a track
UPDATE.....	updating disc contents (page 10, 11, 13, 14)
DISC FULL.....	no more recording possible
DIGITAL I.....	digital coaxial input selected (page 13, 14)
OPTICAL.....	digital optical input selected (page 13, 14)
ANALOG.....	analog input selected (page 13, 14)
NOT FINALIZE D.....	when opening the tray with an unfinalized disc inserted (in the CD-Recorder)
RECORD FAST.....	High Speed recording selected (page 9, 10)
REC LISTEN.....	Normal Speed recording selected (page 9, 11)
MAKE CD.....	Start of synchronised recording of a complete disc and Auto Finalize function selected (page 9, 10, 15)
REC EXT DISC.....	Synchronised start of recording from external source selected (page 9, 14)
REC EXT MAN.....	Manual start of recording from external source selected (page 13, 14)
-XX D.....	Recording level is being adjusted
DOES NOT FIT.....	time left on CD-R/RW disc is not enough for proposed recording (page 9)
ERASE TRACK.....	when erasing one or more tracks (page 16)
ERASE DISC.....	when erasing a disc (page 16)

FINALIZE CD.....	when finalizing a disc (page 15)
CHECK INPUT.....	when ● is pressed while no digital source is detected
** ** ERASE.....	time countdown when erasing a track or a disc (page 16)
*** FINAL.....	time countdown when finalizing a disc (page 15)
PRESS RECORD.....	to start manual recording, finalizing or erasing (page 10, 11, 12, 15, 16)
START SOURCE.....	to start synchronised recording from a source
FINALIZED.....	when trying to record on a finalized CD-R/RW or a prerecorded CD
UNFINALIZE PRESS ENTER.....	when trying to record on a finalized CD-RW (page 9, 15)
PROF SOURCE.....	when a professional source is connected

Play

CHANGER.....	Changer Mode selected (page 17, 19)
DUAL MODE.....	Dual Mode selected (page 17, 19)
PROGRAM.....	program mode selected (page 19)
ALBUM TITLE.....	will be followed by album title
TRACK TITLE.....	will be followed by track title
ALBUM ARTIST.....	will be followed by artist name (page 8)
TRACK ARTIST.....	will be followed by track artist name
CHANGER MODE.....	a button is pressed during Dual Mode that only applies to Changer Mode (page 17)

Others

NO AUDIO TR.....	when the recorder finds a computer data track during recording
FINALIZED CD.....	CD-R/RW disc has been finalized (page 9)
INITIALIZING.....	during laser power calibration for unfinalized discs (page 8)
DISC RECOVER.....	during disc recovering after power failure (page 27)
OPC ERROR.....	OPC failure during OPC procedure (OPC = Optimum Power Calibration) meaning that the CD-R/RW disc is bad
RECORD ERROR.....	recording error in menu mode
DISC ERROR.....	when trying to record on or finalize a recovered disc (page 27), disc is no longer usable
MEMORY FULL FINALIZED CD.....	when text memory is full. To add a CD to the list, first finalize or erase another disc from the list. (page 15, 22, 26)

DISPLAY

Menu messages

NO TRACKS.....	when attempting to edit text on a disc which has no tracks
TEXT EDIT.....	when entering Text Edit mode (page 20)
CD ARTIST.....	when editing or erasing an artist name for a disc
CD TITLE.....	when editing or erasing a disc title
ARTIST TR N.....	when editing or erasing an artist name on a specific track
TITLE TR N.....	when editing or erasing a title on a specific track
TEXT ERASE.....	when entering Text Erase mode (page 21)
ALL TEXT.....	when entering All Text display mode
ERASE OK.....	when confirmation for erasing has to be given with ENTER key
ERASE ALL OK.....	when confirmation for erasing all tracks have to be given with ENTER key
ERASE MEMORY.....	when waiting for confirmation when erasing a disc (page 22)
TEXT VIEW.....	when selecting text review for all the unfinalized discs in memory (page 22)
MEMORY EMPTY.....	when REVIEW is selected while no text is in memory (page 22)
AUTO TRACK.....	when selecting auto track increment ON or OFF (page 23)
ON.....	Auto Track increment on (page 23)
OFF.....	Auto Track increment off (page 23)
SET BALANCE.....	when selecting BALANCE (page 24)
NO TEXT.....	no text stored for disc

OTHER INFORMATION

The numbers between parentheses refer to the fold-out.

Fixing problems

If you think your CD-Recorder is defective, it is wise to read this list first. Maybe you forgot a simple step.

Warning!

Under no circumstances should you attempt to repair the unit yourself as this will invalidate the guarantee.

No power

- ensure that the **POWER ON/OFF** (1) button is on: the CD-Recorder may be in standby mode, press any button to activate it
- ensure that the power cord is plugged in correctly
- switch the recorder OFF and then immediately back ON

Auto track does not work

- check if auto track is ON
- check if there are 2.7 seconds silence in between the tracks (analog recording only)
- check that the digital source conforms to the SPDIF (or IEC-958-II) standard
- source is a DVD video disc (DVD video discs do not contain track information)
- make sure analog source meet track marking criteria on page 22

No sound

- check the audio connections
- if using a amplifier or receiver, check that a signal is present using headphones or try a different amplification system

Amplified Sound is distorted

- check that the CD-Recorder analog output is not connected to a PHONE input.
- check that the disc is not defective by trying another disc

Play will not start

- ensure that the label of the CD is facing up
- clean the disc
- check that the disc is not defective by trying another disc

Remote control does not work

- set the remote control selector to 'INTERNAL' on the back panel
- point the remote control directly at the CD-Recorder
- check the batteries and replace if necessary
- select the right source first (CDR)

Will not record

- clean the disc
- check if CD-R/RW is an unfinalized disc
- check that the disc is recordable and replace if necessary
- the disc is not an audio disc (WRONG DISC)
- wrong input source chosen.
- text memory full (MEMORY FULL / FINALIZE CD). Erase text for other disc(s) or finalize other disc(s) to obtain memory space.
- check that the disc is not defective by trying another disc



OTHER INFORMATION

The numbers between parentheses refer to the fold-out.

Recording is distorted

- make sure the recording level was not too high
- check that the disc is not defective by trying another disc

20 second pause between recordings

- see 'RECORDING' SYNC on page 14

Player does not react

- use the **POWER ON/OFF** (1) button on the front of the Player to switch it off and back on

DISC RECOVER on display

- a power failure has occurred during recording the CD-Recorder is attempting to repair the disc
- If **DISC ERROR** then appears on the display, the disc cannot be recorded further, and cannot be Finalized. But it can still be played on the CDR500 or another CD-Recorder.
- on a CD-R/RW disc, the track being recorded is lost, but further recording and finalisation can still be done
- check that the disc is not defective by trying another disc

XLR input level is too low or too high

- adjust the R and L TRIM pots on the back panel to the optimum level

Digital input source indication is flashing

- check the digital cable connections
- check that the output of the digital source is conforms to the SPDIF (or IEC-958-II) standard
- try a different cable to make sure the digital cable is OK

Recorded disc playback quality on other CD players is poor

- make sure to use good quality discs when recording audio
- make sure the discs used for recording are compatible with 1X speed recording
- try recording onto a 'Music' (consumer) type blank disc because they are specially designed for 1X speed audio recording
- If using 80 minute discs, try a 74 minute disc because they provide a wider recording area and thus have a less chance for error

CD-Text appears on CD-Player but not on CD-Recorder

- the CD-Recorder drive does not display the CD-Text on "hybrid" CDs that contain audio and data together on the disc.



Rergarding addresses for your local Marantz organization,
please visit us on the web at
<http://www.marantz.com>.

marantz[®] is a registered trademark.

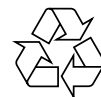

Printed in Japan

00/09 388K851310 (MITi)



Free Manuals Download Website

<http://myh66.com>

<http://usermanuals.us>

<http://www.somanuals.com>

<http://www.4manuals.cc>

<http://www.manual-lib.com>

<http://www.404manual.com>

<http://www.luxmanual.com>

<http://aubethermostatmanual.com>

Golf course search by state

<http://golfingnear.com>

Email search by domain

<http://emailbydomain.com>

Auto manuals search

<http://auto.somanuals.com>

TV manuals search

<http://tv.somanuals.com>