



RX 400h

HYBRID OVERVIEW



Lexus Hybrid Drive Quick Facts:

“Gives more to the driver, takes less from the world.”

- The Lexus RX 400h is powered by a Lexus Hybrid Drive system that combines the advantages of electric motor/generator and a gasoline engine.
- The Lexus RX 400h does not need to be plugged in like an electric car. The Lexus Hybrid Drive system automatically charges itself.
- The Lexus RX 400h hybrid drive provides the high level of performance associated with Lexus, along with an improved city gas mileage rating and reduced emissions when compared to the RX 350.
- The Lexus RX 400h offers the high level of quality and luxury features that is expected from a Lexus vehicle.

We invite you to discover more about the revolutionary Lexus RX 400h and Lexus Hybrid Drive in the pages of this booklet. For further details, contact your dealership, see the vehicle *Owner's Manual* and other owner information materials in the vehicle, or log onto www.lexus.com.



What's Inside...

PAGES



Driving the **RX400h**

1 - 2

Starting, driving, parking attendant instructions, long-term parking, running out of fuel, and battery facts.



The Benefits of Lexus Hybrid Technology

3 - 4

Impressive Performance; Low Levels of Noise, Vibration, and Harshness; Reduced Emissions; Improved Fuel Efficiency.



EPA Mileage Estimates & Fuel Economy

5 - 7

Quick Facts - EPA Mileage Estimates, Why you may not achieve the EPA estimates, Ten Tips for Improving Fuel Economy.



Multi-information Display & Monitors

8 - 16

Multi-information display, Energy Monitor Screen, Consumption Monitor, Power Gauge and Hybrid Battery Status.



RX 400h Hybrid Technology

17 - 20

How the system works, the system's components and what they do.



Frequently Asked Questions

21 - 22

A wide range of questions often asked about the RX 400h and hybrid technology.



RX 400h Hybrid Drive Specifications

23

Specifications pertaining to Lexus Hybrid Drive.

A

Glossary of Hybrid Technology Terms

24 - 26

Definitions of commonly used hybrid technology terms.

Index

27



Driving the RX 400h

On the whole, driving the RX 400h is not very much different from driving a conventional vehicle. However, there are some subtle differences you will notice.

- **Turning the ignition key "starts" the vehicle, but may not start the engine.**
Like starting a regular vehicle, turn the ignition key to the "START" position and release to start the vehicle. After a few seconds, the "READY" light in the Power Gauge will come on. Once the "READY" light comes on, place the transmission gear lever into the desired gear and start driving. When accelerating slowly, the RX 400h can drive at low speeds on electric power alone, so the gasoline engine may not start for awhile depending upon the need.
 - **The transmission will feel different.**
The RX 400h uses an Electronically-controlled Continuously Variable Transmission (ECVT). The transmission does not shift with fixed gear ratios like a conventional transmission, so it delivers power efficiently and smoothly. The "B" gear position is for engine braking.
 - **The brakes may feel different.**
The RX 400h has a regenerative braking system which works in conjunction with its conventional hydraulic braking system. As a result, the brakes may feel different from a conventional vehicle.
 - **The engine will turn off and on while you drive.**
The engine will automatically turn on and off as needed. At medium or high speeds, it is normal for the engine to be on most of the time. At low speeds or when stopped, the engine may or may not be on, depending on the need.
 - **You will notice different sounds while driving.**
The engine sound will be more steady than a conventional vehicle when accelerating due to the smooth operation of the ECVT. It is also normal for the new technology of the Lexus Hybrid Drive system to make a "whirring" sound while driving.
- ⚠ CAUTION:** While driving a hybrid vehicle, pay special attention to the area around the vehicle. Because there is little vehicle noise in electric-only mode, pedestrians, people riding bicycles or other people and vehicles in the area may not be aware of the vehicle starting off or approaching them, so take extra care while driving. *(continued next page)*

Driving the RX 400h (continued)

- **Some parking attendants may not be familiar with the RX 400h.**

To properly operate the vehicle, these basic tips are important:

1. Turn key to "START" and release.
2. Begin driving when "READY" light stays on.
3. The engine will start and stop automatically.

New RX 400h vehicles come with parking attendant key ring tabs, with these tips in English and Spanish.

- **When refueling, the fuel door may take a few moments to open.**

As part of emissions system operation, it may take up to 15 seconds for the fuel door to automatically release after the release button is pressed. The Multi-information Display in the instrument cluster will display "Refuel Ready" when the door releases.

- **Running out of fuel.**

Do not run your RX 400h out of fuel. The RX 400h is not designed to be operated with the fuel tank empty. If you try to start the RX 400h with the fuel tank empty, the hybrid system will become disabled on the third attempt. If you continue to drive with the fuel tank empty, the hybrid battery will rapidly discharge and the hybrid system will shut down. If you run out of fuel, immediately pull over to a safe location and turn off the vehicle. Be sure to add fuel before attempting to restart the vehicle or continuing to drive.

**Hybrid Battery cooling vents.**

Do not block the hybrid battery cooling vents located under the rear seats with cargo or other items. Doing so could cause overheating of the hybrid battery.

- **Maintaining charge for your 12-volt battery**

The following will help keep your vehicle's 12-volt battery fully charged: Drive vehicle at least weekly. Operate accessories with vehicle in "READY" mode. When parking, make sure all doors are closed and lights are turned off.

- **Long-term parking.**

If the vehicle has been parked for two weeks or longer, do not operate the power rear door until you have turned the key to "START" and the "READY" light stays on. If the vehicle has been parked for a long time, the 12-volt and the hybrid battery will discharge gradually. For parking longer than about 30 days, charging of the 12-volt battery may be required. See your dealership for details. To keep the hybrid battery in good condition, drive the vehicle at least once every several months for at least 30 minutes or ten miles. If the hybrid battery becomes fully discharged and the vehicle will not start, even with a jump start to the 12-volt battery, contact your Lexus dealership.



The Benefits of Lexus Hybrid Technology

Impressive Performance

- Lexus hybrid vehicles deliver impressive throttle response, even from a standing start. This is because the electric motors deliver maximum torque instantly.
- The Lexus Hybrid Drive system combined with the ECVT (Electronically controlled Continuously Variable Transmission) helps deliver smooth, seamless acceleration for excellent passing performance and drivability.

Low Levels of Noise, Vibration and Harshness (NVH)

- Since Lexus hybrid vehicles can operate on electric power only during start-up and lower speeds, the NVH level is about half that of conventional gasoline-powered vehicles.
- The gasoline engine does not have to be turned on in order for the electric air conditioner in Lexus hybrid vehicles to operate.
- The Electric Power Steering (EPS) system eliminates the hydraulic pump associated with steering noise and vibration.
- The ECVT eliminates the hesitation and noise level associated with shifting between fixed gear ratios.
- The acoustic windshield is laminated with a low-durometer triple-layer film that helps absorb engine, wind and road noise.

The Benefits of Lexus Hybrid Technology (continued)

Reduced Emissions

- Lexus hybrid vehicles produce **70% fewer smog-forming emissions** than the average new vehicle and are certified as an SULEV (Super Ultra-Low Emission Vehicle) by the California Air Resources Board.
- The gasoline engine is turned off much of the time during idle and acceleration, which means that zero emissions are being produced.
- The gasoline engine can be smaller in size than non-hybrid vehicles, producing fewer emissions without sacrificing performance.

Improved Fuel Efficiency

- By combining a hybrid battery, electric motors and engine, the Lexus Hybrid Drive system is able to reduce fuel consumption, while still delivering ample power for all types of driving situations.
- The RX 400h delivers an improved city gas mileage rating.*
- Fuel consumption is zero when the engine is turned off and the vehicle is operating in electric only mode.

* Actual mileage may vary.





EPA Mileage Estimates & Fuel Economy

Quick Facts - EPA Mileage Estimates

The EPA estimated fuel economy numbers are derived from vehicle testing conducted at the U.S. Environmental Protection Agency's (EPA's) National Vehicle and Fuel Emissions Laboratory in Ann Arbor, Michigan. Vehicle manufacturers also submit test results based on strict EPA standardized drive patterns. Each year, the EPA provides the data to the Department of Energy, which publishes the results at www.fueleconomy.gov.

Some quick facts about EPA estimated fuel economy tests:

Federal law requires EPA estimated fuel economy to be provided on a fuel economy label affixed to the window of every vehicle (see Figure 1). The EPA estimates serve as a useful guide for comparing the relative fuel efficiency of various vehicles and are intended for comparison only. Fuel economy estimates are determined under ideal laboratory conditions following a standardized test determined by federal law. Each vehicle must complete tests simulating a driving routine for:

- **City** - Low speeds in stop-and-go urban traffic.
- **Highway** - Free-flow traffic at highway speeds.
- **High Speed** - Higher speeds; harder acceleration and braking.
- **AC** - Air conditioner use under hot ambient conditions.

(See www.fueleconomy.gov for further details.)

EPA Mileage Estimates & Fuel Economy (continued)

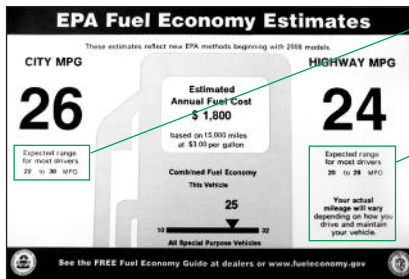
Typical EPA Mileage Estimate data found on vehicle window sticker
(Sticker and figures for AWD model) - Figure 1.

Expected range for most drivers
22 to 30 MPG

Expected range for most drivers
20 to 28 MPG

Your actual mileage will vary depending on how you drive and maintain your vehicle.

Why you may not achieve the EPA estimates

Because the EPA fuel economy estimates are derived in ideal laboratory conditions, they are just estimates, which may not reflect real world conditions. There are many factors which may cause your actual mileage with the RX 400h, or other vehicles, to vary from the EPA estimates:

- Quick acceleration and heavy braking may reduce mileage by as much as 33% in highway driving and as much as 5% in city driving.
- Driving at highway speeds above 60 mph. (The maximum EPA highway test speed is 60 mph, the average speed is 48 mph)
- Driving on hilly or mountainous terrain and unpaved roads. (EPA tests assume flat roads.)
- Short trips cause the engine to run more as a percentage of driving, as it warms the emissions system.
- Carrying extra weight or towing a trailer. (The EPA test assumes only 300 lbs. of passengers and cargo.)
- Cargo racks. (Vehicles are tested without cargo racks, which can increase wind drag.)
- Poor maintenance. (Vehicles tested are in top condition.)
- New vehicles. (Optimum fuel economy may not be realized until the engine is "broken-in," which may take up to 5,000 miles.)
- Some fuels contain less energy than others. Using oxygenated fuels or reformulated gasoline (RFG), for example, can cause a small decrease in fuel economy.

(Source for above information: www.fueleconomy.gov)

EPA Mileage Estimates & Fuel Economy (continued)

✓ Ten tips for improving fuel economy

The following tips can help you achieve the best possible fuel economy:

- 1) Plan ahead to combine short trips in order to minimize cold starts.
- 2) Accelerate slowly.
- 3) Avoid heavy braking. Monitor traffic to minimize braking and coast whenever possible.
- 4) Avoid speeds in excess of 60 mph; fuel economy suffers at speeds higher than 60 mph and drops significantly above 70 mph.
- 5) In stop-and-go traffic, accelerate to the desired level then lift off the accelerator pedal allowing the vehicle to run more on electric power.
- 6) Check tire pressure and maintain it at the recommended pressure.
- 7) Avoid carrying unnecessary loads; extra weight reduces fuel economy.
- 8) Use the air conditioner and defroster only as needed.
- 9) Use premium fuel to improve fuel economy and performance.
- 10) Use the "D" gear position rather than the "B" position. During normal driving conditions, always drive in "D" for best fuel economy. Only use "B" gear position if needed to help maintain vehicle speed when going down steep grades.



Multi-information Display & Monitors



All RX 400hs are equipped with a **Multi-information Display** that shows a simplified representation of the approximate flow of energy within the hybrid system. The display does not show all of the components of the system.



To show the Energy Monitor display, press the “DISP.” button located on the steering wheel, until you reach the Energy Monitor display. It may be necessary to press the button more than once to reach this display.



The vehicle is being primarily driven by the engine.

- The arrow points away from the engine and then to the wheel. *The level of hybrid battery charge, circled in red, will be shown by the amount of white within the battery image.*



The vehicle is being driven by the hybrid battery.

- The arrow points away from the hybrid battery and then to the wheel.



The vehicle is being driven by both the engine and the hybrid battery.

- The arrows point away from the hybrid battery and the engine and then to the wheel.



The vehicle is coasting or slowing down, regenerating electricity and charging the hybrid battery.

- The arrow points away from the wheel and then to the hybrid battery.



The vehicle is stopped and the hybrid battery is not being charged.

- No arrows are displayed.

Multi-information Displays & Monitors (continued)

The Energy Monitor Screen (Vehicles with optional Navigation Systems only.)

The optional Energy Monitor shows a simplified representation of the approximate flow of energy within the hybrid system. The display does not show all of the components of the system. The display is part of the RX 400h Navigation System and is located at the center console display.

The Energy Monitor display changes as the RX 400h transitions through different driving conditions. The Energy Monitor display will show the changes in energy and power flow through the system at a given time as the vehicle is driven.

To access the Energy Monitor screen, press the "INFO" button located on the lower edge of the navigation display. On the touch screen that appears, touch the "TRIP INFO" button.



Energy Monitor Screen description

Hybrid battery status. Outside temperature.

Energy flow

Orange = Mechanical drive power

Green = Electrical / regenerative power

Yellow = Electrical drive power

Press to go to the Consumption Monitor.

Current fuel economy in miles per gallon (MPG).

- "FRONT ELECTRIC MOTOR" represents Electric Motor/Generator (MG1) and Front Electric Motor/Generator (MG2) together.
- "REAR ELECTRIC MOTOR" represents Rear Electric Motor/Generator (MGR).*
- "BATTERY" represents the hybrid battery.

* Vehicles with optional All-Wheel Drive only.

(continued on next page)

Multi-information Displays & Monitors (continued)

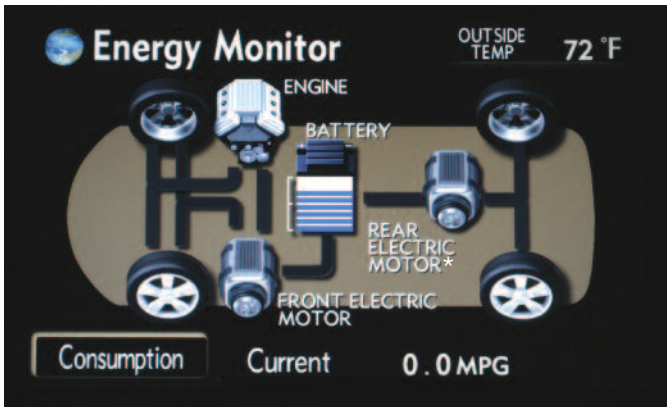
Typical Energy Monitor Screens (Vehicles with optional Navigation Systems only.)

The vehicle is stopped, the engine is off, and the hybrid battery is not being charged.

- No arrows are displayed.

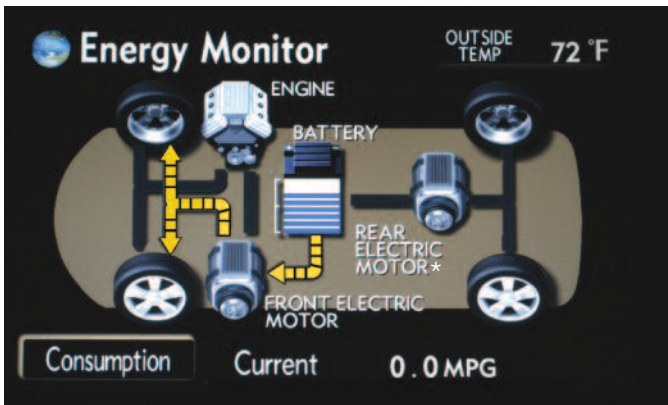

The vehicle is being driven by the front electric motor.

- The arrows point away from the hybrid battery to the front electric motor and then to the front wheels.

* Vehicles with optional All-Wheel Drive only.

(continued on next page)

Multi-information Displays & Monitors (continued)

Typical Energy Monitor Screens (continued)

(Vehicles with optional Navigation Systems only.)

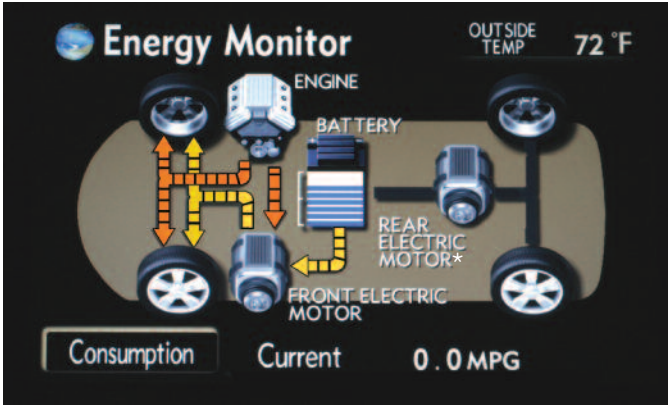

The vehicle is being driven by the engine and the front electric motor.

- The arrows point away from the hybrid battery, the engine, and the front electric motor and then to the front wheels.

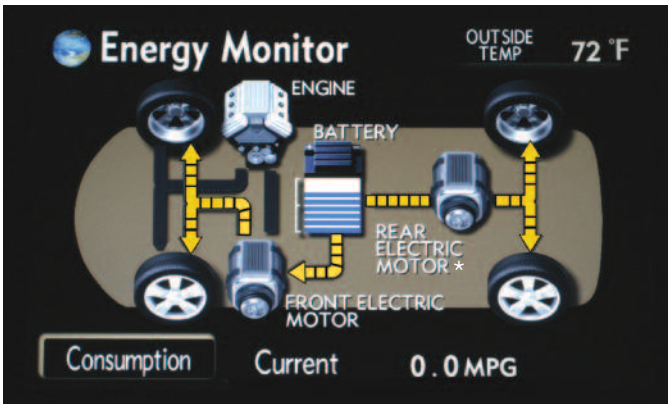

The vehicle is being driven by the front and rear* electric motors.

- The arrows point away from the hybrid battery and the front and rear* electric motors and then to the front and rear wheels.*

* Vehicles with optional All-Wheel Drive only.

(continued on next page)

Multi-information Displays & Monitors (continued)

Typical Energy Monitor Screens (continued)

(Vehicles with optional Navigation Systems only.)

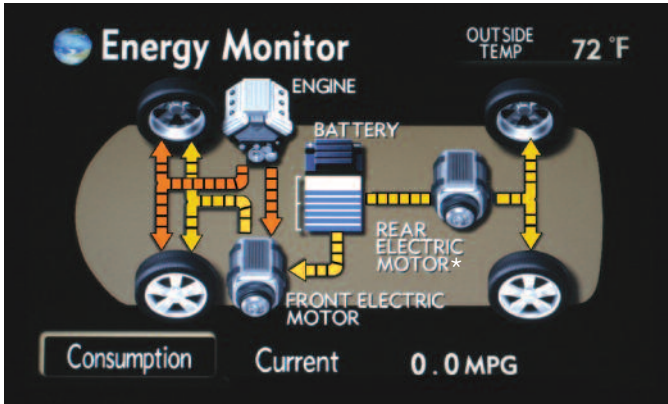

The vehicle is being driven by the engine and the front and rear electric motors.

- The arrows point away from the hybrid battery, the engine, and both front and rear* electric motors, and then to the front and rear wheels*.

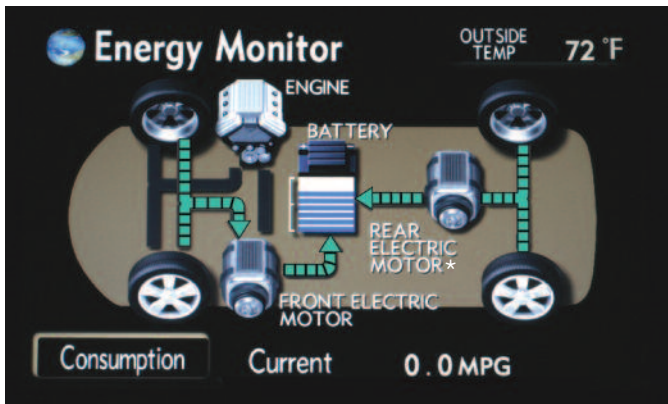

The vehicle is coasting or slowing down, regenerating electricity and charging the hybrid battery.

- The arrows point away from the wheels and electric motors and then to the battery.

* Vehicles with optional All-Wheel Drive only.

(continued on next page)

Multi-information Displays & Monitors (continued)

Typical Energy Monitor Screens (continued)

(Vehicles with optional Navigation Systems only.)

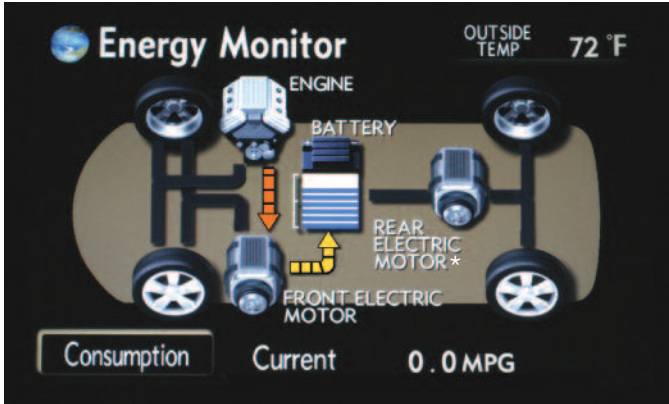

The vehicle is parked and the engine is charging the hybrid battery.

- The arrows point from the engine to the front electric motor, then to the hybrid battery.

Hybrid Battery Status information

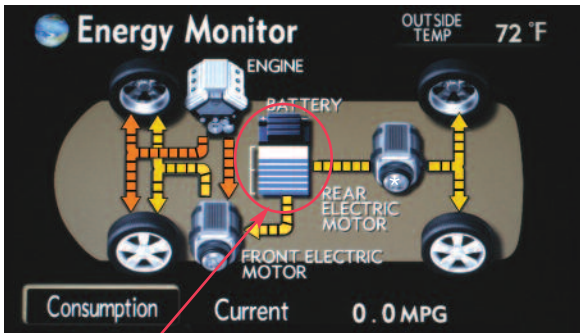

Battery status indicator showing six blue bars, indicating battery is at medium charge level.

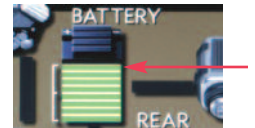

Hybrid Battery full.



Hybrid Battery low.

The approximate amount of electric charge available in the hybrid battery is displayed in one of 8 different levels. Unlike the vehicle fuel gauge, it is normal for the battery status indicator to actively move up and down and change color, depending on driving conditions. The top green bar may not appear except after driving down long mountain grades.

* Vehicles with optional All-Wheel Drive only.

Multi-information Displays & Monitors (Continued)

The Consumption Monitor (Vehicles with optional Navigation Systems only)

To access the Consumption Monitor screen, press the “INFO” button located on the lower edge of the navigation display. On the touch screen that appears, touch the “TRIP INFO” button.



The Consumption Monitor description

Annotations for the Consumption Monitor screen:

- Outside temperature: 70 °F
- Energy: Press to go to the Energy Monitor screen
- Average fuel economy in MPG: 23.9 MPG
- Distance travelled: 585 miles
- Reset: Press to clear the average fuel economy and distance travelled

(continued on next page)

Multi-information Displays & Monitors (continued)

The Consumption Monitor (continued)

(Vehicles with optional Navigation Systems only.)

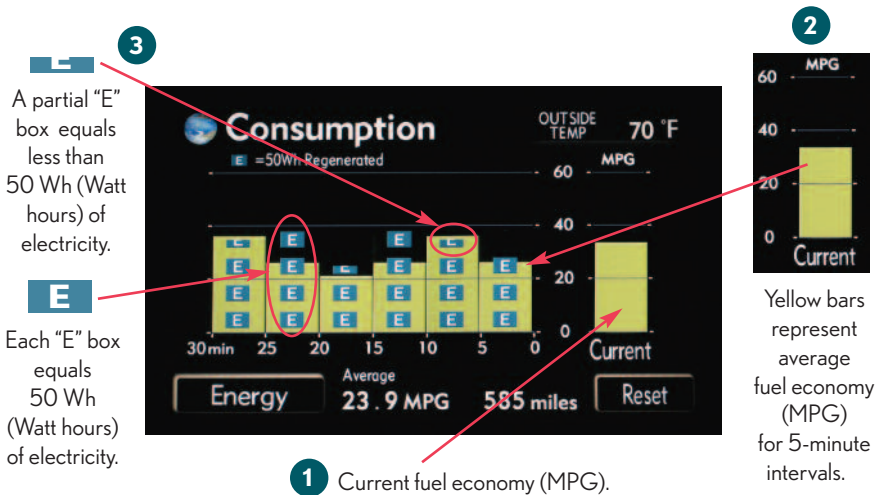

The Consumption Monitor displays three charts combined into one:

- 1** The **yellow bar display on the far right** represents fuel economy from moment to moment.
- 2** The **yellow bars** represent the average fuel economy in miles per gallon (MPG). The higher the bars reach, the better fuel economy the vehicle is getting. Each bar represents a 5 minute period. The bars shift to the left every 5 minutes, so the bar between 0 and 5 min. is the most recent 5 minute period. This information will clear when you turn off the vehicle.
- 3** The **small boxes** with "E" in the center represent the amount of electricity that has been regenerated in 50 Wh (Watt hour units). A partial box means less than 50Wh. Each column represents a 5 minute period. The columns shift to the left every 5 minutes, so the column between "0 and 5" is the most recent 5 minute period. The more boxes there are, the more regenerative energy is produced and stored in the hybrid battery. This information will clear when you turn off the vehicle.

(continued on next page)

Multi-information Displays & Monitors (continued)

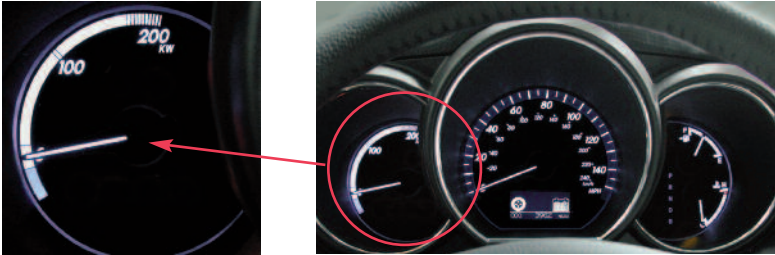
The Power Gauge

The **Power Gauge** indicates the approximate power in kilowatts the hybrid system delivers or receives. The needle will move up towards 200kW during acceleration and downward into the blue area when the hybrid system is regenerating power during coasting and braking conditions.





RX 400h Hybrid Technology

Lexus Hybrid Drive basics.

- **A hybrid vehicle is a vehicle that combines power from different sources to efficiently operate. Lexus has spent many years and logged millions of test miles developing and testing the hybrid technology found in the RX 400h.**
- **The Lexus Hybrid Drive system that powers your Lexus RX 400h is an advanced system that incorporates the advantages of both electric motors and gasoline engines.**
- **The RX 400h can be driven on hybrid battery power alone, for short distances at lower speeds, then the engine will start when power is needed to recharge the 12-volt and hybrid batteries, or when driving conditions call for more power.**
- **Lexus Hybrid Drive automatically controls energy usage in the most efficient way possible. The system even captures energy when the vehicle is slowing down.**

This chapter explains some of the components that make up the Lexus Hybrid Drive System and their functions.

RX 400h Hybrid Technology (continued)

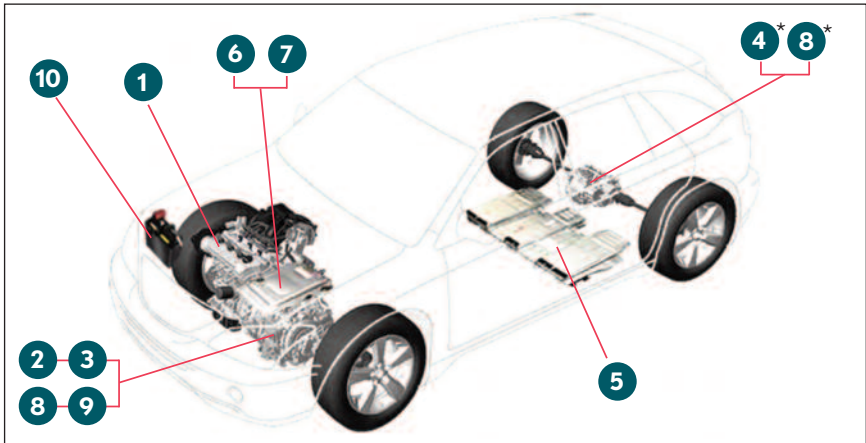
Lexus Hybrid Drive main components

- 1** **3.3 L 24-V DOHC V-6 Engine with VVT-i** – The primary power source for your vehicle, the engine works in conjunction with the hybrid battery to deliver power to the ECVT.
- 2** **Electric Motor / Generator (MG1)** – Serves as the starter motor for the engine and a “pathway” for the engine’s power to reach the front wheels.
- 3** **Front Electric Motor / Generator (MG2)** – Delivers power to the front wheels. It can run alone or with the engine. It is driven by electrical power from MG1 and/or the hybrid battery. During braking or deceleration, it generates electricity to recharge the hybrid battery.
- 4** **Rear Electric Motor* / Generator (MGR)*** – Operates when starting from a stop, during hard acceleration, sharp turning, and if the front wheels slip. It is driven by electrical power from the hybrid battery and MG1 as needed. During braking or deceleration, it generates electricity to recharge the hybrid battery. The All-Wheel Drive[♦] system operates automatically as needed.

* Vehicles with optional All-Wheel Drive only.

(continued on next page)

♦ The RX 400h is not designed to be driven off-road.

RX 400h Hybrid Technology (continued)

Lexus Hybrid Drive main components (continued)

- 5 Hybrid Battery** – Composed of sealed nickel-metal hydride modules, the 288-volt hybrid battery is located under the rear seat. It supplies power to the electric motors during start-up, acceleration, uphill driving, and reverse. It supplies power to the Inverter for use by the electric motors and stores regenerative energy captured during coasting and braking conditions.
- 6 Inverter** – Converts the hybrid battery's high voltage DC current into AC current for the electric motors and vice versa, depending on driving demands and electrical system needs. The inverter can also boost the hybrid battery's power up to 650 volts as needed.
- 7 Hybrid Electronic Control System** – Monitors and controls the power flow operation of MG1, MG2, MGR*, and the inverter.
- 8 Regenerative Braking System** – Helps recover energy used to slow the vehicle during braking or coasting. During braking or coasting, MG2 and MGR* turn into generators, which create electricity to help charge the hybrid battery. As they create electricity, they create drag, which helps slow the vehicle. The conventional brake system and the regenerative brake system work in conjunction with each other.
- 9 Electronically-controlled Continuously Variable Transmission (ECVT)** – Delivers smooth acceleration without conventional gear shifting, while enhancing efficiency. It has fewer parts than a conventional automatic transmission. MG1 and MG2 are part of the ECVT. During sustained highway cruising, the ECVT helps maximize fuel economy for the engine.
- 10 12-volt Battery** – Enables the Hybrid Electronic Control System to "start" the hybrid system (vehicle "READY" mode) and operates the basic electrical system. This battery is charged by the DC/DC converter, which is part of the inverter assembly.

* Vehicles with optional All-Wheel Drive only.

RX 400h Hybrid Technology (continued)

How Lexus Hybrid Drive works.

Lexus Hybrid Drive incorporates gas-engine power with electric motor efficiency in a seamless manner.

Typically, the system works as follows:

Starting from a stop

The front electric motor/generator (MG2) and the rear electric motor/generator (MGR*) both drive the vehicle. The engine is not required to start moving the vehicle, but may come on to charge the hybrid battery or make heat available for the climate control and emissions systems.

Normal acceleration

MG2 and the engine drive the vehicle. MGR* is not powered. The engine drives MG1 as a generator to power MG2 and charge the hybrid battery as needed.

Full acceleration

The engine, MG2, and MGR* work together to drive the vehicle. The hybrid battery supplies additional power to MG2 and MGR.

Cruising (constant speed)

Primarily, the engine will drive the vehicle. The engine, MG1, MG2, and MGR* will come on as needed depending on road conditions and other factors. MG2 and MGR* may act as motors or as generators depending on the need to make power or regenerate electricity to recharge the hybrid battery.

Coasting and braking

As part of the regenerative braking system, MG2 and MGR* act as generators to regenerate electricity to charge the hybrid battery. The engine may turn off before the vehicle comes to a complete stop.

Backing-up

MG2 and MGR* reverse direction to drive the vehicle. The engine is typically off, unless it is needed to recharge the hybrid battery or warm-up the engine.

* Vehicles with optional All-Wheel Drive only.



Frequently Asked Questions

Q: How should I choose between an RX 350 and an RX 400h hybrid?

A: If most of your driving is highway cruising or you leave your vehicle parked for several weeks at a time, the RX 350 may best meet your needs. If most of your driving is stop-and-go city and you want improved acceleration and fuel economy, the RX 400h may best meet your needs.

Q: What changes to the interior of the RX 350 were required to accommodate the hybrid system of the RX 400h?

A: The rear seat is raised slightly (about one inch) and the tool storage compartment is shallower to make room for hybrid system components. The rear cargo area is the same size.

Q: What is the warranty on the RX 400h? What is the warranty on the hybrid battery?

A: In addition to the Basic Warranty of 48-month/50,000 miles and the powertrain and restraint system coverage of 72 months/70,000 miles, there is a hybrid warranty. The Hybrid Vehicle System Warranty is 96 months (8 years)/100,000 miles from the vehicle's in-service date, whichever occurs first. It is applicable to certain components of the hybrid electronic control system and the hybrid battery. See the *Owner's Manual* and other owner information materials in the vehicle for details.

Q: Does the RX 400h qualify for the single-occupant vehicle in the high occupancy vehicle (HOV) lane?

A: We do not expect the RX 400h to qualify for the HOV lane. Check with your state department of motor vehicles for more information.

(continued on next page)

Frequently Asked Questions (continued)

Q: Do you have to charge it/plug it in?

A: Lexus Hybrid Drive automatically recharges the 12-volt and hybrid batteries using regenerative braking or by running the engine to generate electricity. However, if the vehicle has been parked for a long time, the 12-volt and the hybrid battery will discharge gradually. For parking longer than about 30 days, charging of the 12-volt battery may be required. See your dealership for details. To keep the hybrid battery in good condition, drive the vehicle at least once every several months for at least 30 minutes or ten miles. If the hybrid battery becomes fully discharged and the vehicle will not start, even with a jump start to the 12-volt battery, contact your Lexus dealership.

Q: What maintenance is required?

A: The maintenance requirements are comparable to what a gasoline-powered RX 350 requires. The hybrid battery and motor/generators do not require ongoing maintenance. However, to keep the hybrid battery in good condition drive the vehicle at least once every several months for at least 30 minutes. Lexus recommends having RX 400h maintenance and repairs performed by an authorized Lexus dealership. To locate your nearest authorized Lexus dealership, contact Lexus at (800) 255-3987 or log onto **www.lexus.com**. Maintenance and repairs not performed by an authorized Lexus dealership should be performed by a qualified technician following procedures in Lexus service and repair publications.

Q: What safety standards does the RX 400h comply with?

A: Lexus engineers have spent enormous effort to ensure this vehicle meets or exceeds all of the U.S. government's stringent safety standards, as do all Lexus vehicles. See the *Owner's Manual* and other owner information materials in the vehicle for important Safety Precautions.

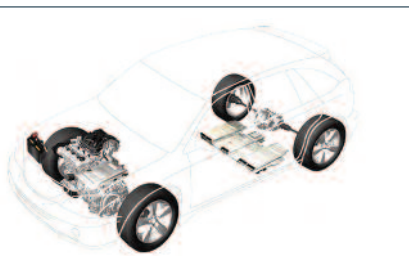

RX 400h Hybrid Drive Specifications

Hybrid System

Engine Type	60° V6, aluminum block and heads, certified Super Ultra-Low Emissions Vehicle (SULEV)
Displacement	3.3 liters (202 cubic inches)
Valvetrain	Four cam, four valves per cylinder, with continuously Variable Valve Timing with intelligence (VVT-i)
Electric-Drive Motors	2 Front and 1 rear* high output, permanent magnet, electric motor/generators
Hybrid Battery	Sealed, Nickel-Metal Hydride (NiMH) modules, 288-volt
Total System Horsepower	268 hp @ 5,600 rpm (combined engine and hybrid battery)

Body, dimensions

Curb Weight	Front-wheel drive 4,190 lb., All-wheel drive♦ 4,365 lb.
Fuel Tank Capacity	17.2 gallons

Performance

0-60 acceleration ¹	Front-wheel drive 7.5 seconds ³ , All-wheel drive♦ 7.3 seconds ³
Top Track Speed ¹	112 mph ¹ (electronically-limited)
Fuel Consumption ²	Front-wheel drive: 27/24 mpg (city/highway, estimated) All-wheel drive: 26/24 mpg (city/highway, estimated)

Drivetrain

Type	Front-wheel drive or optional part-time All-wheel drive (AWD)♦
Transmission	(ECVT) Electronically-controlled Continuously Variable Transmission

Chassis

Brakes	Four-wheel electronic power-assisted discs, with four-sensor, four-channel Anti-lock Braking system (ABS), Brake Assist and integrated regenerative brake system.
--------	---

¹ These performance capacity figures are for comparison only, and were obtained with prototype vehicles by professional drivers using special safety equipment and procedures. These should not be attempted on public streets or highways.

² EPA estimated ratings. Actual mileage may vary.

³ Source: Manufacturer's estimate

* Vehicles with optional All-Wheel Drive only.

♦ The RX 400h is not designed to be driven off-road.

Glossary of Hybrid Technology Terms



12-volt Battery

The low-voltage battery that provides electrical power to accessories and the vehicle's computer, similar to the battery of a conventional vehicle.

AC

Electrical current that reverses its flow in a circuit at regular intervals. The RX 400h's electric motors operate on AC current.

DC

Electrical current that flows continuously in one direction. The RX 400h's hybrid battery and 12-volt battery provide DC current.



Electronically-controlled Continuously Variable Transmission (ECVT)

A type of transmission with an infinite number of gear ratios that change depending on vehicle speed and engine rpm. As a result, the engine and the motors operate at their most efficient points regardless of the vehicle's speed. The ECVT in the RX 400h

provides seamless acceleration without the shift points felt with conventional transmissions. The front electric motor/generators and the planetary gear set are part of the ECVT, which has fewer parts than a conventional automatic transmission.



Engine

In a hybrid vehicle, the word "engine" refers to the gasoline engine, not an electric motor. The gasoline-powered 3.3L V-6 is the primary power source for the RX 400h.

(continued on next page)

Glossary of Hybrid Technology Terms (continued)

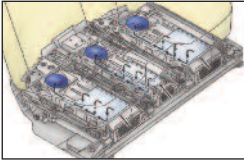
**Hybrid Battery**

Composed of sealed Nickel-Metal Hydride (NiMH) modules, the 288-volt hybrid battery provides electric motor power during start-up, acceleration, uphill driving, and reverse. It also stores energy captured during regenerative braking. The hybrid battery is covered for 8 years/100,000 miles which ever occurs first. In normal use, we expect the battery to last longer than the length of this warranty.

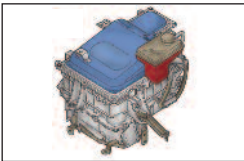
**Inverter**

The inverter converts the hybrid battery's high voltage DC current into AC current for the electric motors and vice versa, depending on driving demands and the needs of the electrical system. The inverter can also boost the battery's power up to 650 volts as needed for maximum power.

kW (Kilowatts)

A unit of electrical power equal to 1000 watts or 1.34 horsepower.

**Lexus Hybrid Drive**

Lexus hybrid technology that combines an advanced gasoline engine, electric motor/generators, a hybrid battery, an Electronically-controlled Continuously Variable Transmission (ECVT) and advanced electronic controls to provide powerful, seamless acceleration, outstanding fuel economy, and reduced emissions.

**Motor/Generator**

In a hybrid vehicle, the word "motor" refers to an electric motor which works with the vehicle's engine to efficiently drive the vehicle.

The RX 400h uses permanent magnet AC motors: a motor/generator (MG1), a front motor/generator (MG2), and a rear motor/generator (MGR*).

* Vehicles with optional All-Wheel Drive only.

(continued on next page)

Glossary of Hybrid Technology Terms (continued)

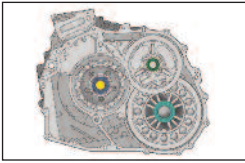
**Planetary gear set**

The component of the ECVT that delivers the efficient mix of engine and hybrid power to the front wheels. The operation of the planetary gear set provides seamless acceleration without shift points.

**Regenerative Braking**

Regenerative braking is a feature that allows an electric motor to act as a generator when braking. It converts the kinetic energy of the car's motion into electrical energy. Whenever the RX 400h is braking or slowing, the electrical energy made during regenerative braking is used to recharge the hybrid battery and is measured in Watt Hours (Wh) on the Consumption Monitor screen (vehicles with optional Navigation Systems only).

Volt

The unit of measure for voltage. Voltage is the electrical pressure which causes current to flow in an electrical circuit.

Watt

A unit of electrical power. One watt equals 1/746th horsepower.

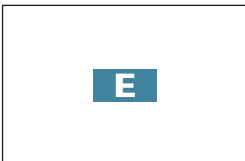
**Wh (Watt hours)**

Electrical power used, or in the case of the RX 400h, regenerated and measured in terms of time.

* Vehicles with optional All-Wheel Drive only.



Index

12-volt battery - 2, 19, 22, 24
 Acceleration - 3, 5-6, 16, 18-21, 23-26
 AWD (All-Wheel Drive) - 6, 9, 18, 23
 "B" gear position - 1, 7
 Backing-up - 20
 Battery, maintaining charge - 4
 Brakes - 1, 23
 Braking - 7, 16, 18-20, 22-23, 25-26
 Charging - 2, 8, 12-13, 22
 Coasting - 8, 12, 16, 19-20
 Consumption Monitor¹ - 9, 14-15, 26
 Cruising - 19-21
 "DISP" button¹ - 8
 Displacement - 23
 Dimensions - 23
 Drivetrain - 23
 "E" box¹ - 15
 ECVT (Electronically-controlled Continuously Variable Transmission) - 1, 3, 19, 23-24, 25-26
 Electric motor/generator - 9, 20, 23-25
 Energy Monitor¹ - 8-14
 Engine - 1-3, 6, 8, 10-13, 17-20, 22-26
 Emissions - 4
 EPA Mileage Estimates - 5-7
 Front electric motor/generator (MG2) - 9-12, 18-20, 24-25
 Fuel Door - 2
 Fuel Tank - 2, 23
 Horsepower (hp) - 23, 25-26
 HOV lane - 22
 Hybrid battery - 2-4, 8-13, 15, 17-26
 Hybrid battery status - 9, 13
 Hybrid electronic control system - 19, 21
 Hybrid technology - 17-20, 22, 24-26
 INFO button¹ - 9, 14
 Inverter - 19, 25

Lexus Hybrid Drive - 1, 17-20, 25
 Long-term parking - 2
 Maintenance - 6, 22
 MG1 - 9, 18-20, 25
 MG2 - 9, 18-20, 25
 MGR² - 9, 18-20, 25
 MPG (Miles Per Gallon) - 4, 6, 9, 14-15, 23
 Multi-information display¹ - 8
 NVH (Noise, Vibration, and Harshness) - 3
 Owner's Manual - 21-22
 Parking - 2
 Parking attendants - 2
 Performance - 3-4, 7, 23
 Planetary gear set - 24, 26
 Power gauge - 1, 16
 "READY" Light - 1-2, 19
 Rear electric motor/generator (MGR)² - 9, 11, 12, 18-20, 23, 25
 Refueling - 2
 Regenerative braking - 8, 12, 15-16, 18
 Running out of fuel - 2
 Safety standards - 22
 Specifications - 23
 Starting - 1, 18, 20
 SULEV (Super Ultra Low Emissions Vehicle) - 4, 23
 Tax credit - 21
 Transmission - 1, 19, 23-25
 "TRIP INFO" button¹ - 9, 14
 Valvetrain - 23
 VVT-i (Variable Valve Timing with intelligence) - 23
 Warranty - 21, 25
 Watt hours (Wh) - 15, 26

¹ Vehicles with optional Navigation Systems only.

² Vehicles with optional All-wheel drive only.

Specifications, features, equipment, technical data, performance figures, options, and color and trim are based upon information available at time of printing, are subject to change without notice, are for mainland USA vehicles and may differ in Hawaii, Puerto Rico, the US Virgin Islands and in other regions. Some vehicles may be shown with optional equipment. Optional equipment listed may not be available separately or in all regions. Technical photos and illustrations are from Lexus Technical Training and other photos are from CJE Automotive Marketing under contract with Lexus Product Coordination.



THE PURSUIT OF PERFECTION.

Free Manuals Download Website

<http://myh66.com>

<http://usermanuals.us>

<http://www.somanuals.com>

<http://www.4manuals.cc>

<http://www.manual-lib.com>

<http://www.404manual.com>

<http://www.luxmanual.com>

<http://aubethermostatmanual.com>

Golf course search by state

<http://golfingnear.com>

Email search by domain

<http://emailbydomain.com>

Auto manuals search

<http://auto.somanuals.com>

TV manuals search

<http://tv.somanuals.com>