



HEARTH PRODUCTS

P/N 875027M Rev. H 06/2011

This manual is part of a set of two supporting this product. Refer to P/N 850026M for Installation Instructions. Ce manuel est disponible en français, simplement en faire la demande. Numéro de la pièce 875027CF.

WHAT'S INSIDE

Table of Contents 2
Safety and Your Fireplace 2
FREE Safety Guard Offer (Protects Against Burns) 2
Important Safety Information 4
Attaching the Safety-in-Operation Warnings 5
[EN FRANÇAIS] L'information de sûreté importante 3-4
Apposition des mises en garde relatives à la sécurité d'utilisation 5
[EN ESPAÑOL] Información importante de seguridad 3-4
Colocación de advertencias de seguridad en operación 5

CARE AND OPERATION INSTRUCTIONS

Montebello®
Direct Vent Gas Fireplaces



MODELS

Table with 3 columns: MODEL, MILLIVOLT, ELECTRONIC. Rows include LSM40MN-2, LSM45MN-2, LSM40EN-2, LSM40MP-2, LSM45MP-2, LSM45EN-2.



OTL Report No. 116-F-22-5



INSTALLER: Leave this manual with the appliance.
CONSUMER: Retain this manual for future reference.
INSTALLATEUR : Laissez cette notice avec l'appareil.
CONSOMMATEUR : Conservez cette notice pour consultation ultérieure.



WARNING / AVERTISSEMENT / AVISO

- HOT GLASS WILL CAUSE BURNS.
DO NOT TOUCH GLASS UNTIL COOLED.
NEVER ALLOW CHILDREN TO TOUCH GLASS.



- UNE SURFACE VITRÉE CHAUDE PEUT CAUSER DES BRÛLURES.
LAISSER REFROIDIR LA SURFACE VITRÉE AVANT D'Y TOUCHER.
NE PERMETTEZ JAMAIS À UN ENFANT DE TOUCHER LA SURFACE VITRÉE.

- EL VIDRIO CALIENTE CAUSARÁ QUEMADURAS.
USTED DEBE NUNCA TOCAR EL VIDRIO CALIENTE.
LOS NIÑOS DEBEN NUNCA TOCAR EL VIDRIO.

WARNING: If the information in these instructions is not followed exactly, a fire or explosion may result, causing property damage, personal injury, or death.

- Do not store or use gasoline or other flammable vapors and liquids in the vicinity of this or any other appliance.
- WHAT TO DO IF YOU SMELL GAS:
• Do not try to light any appliance.
• Do not touch any electrical switch; do not use any phone in your building.
• Immediately call your gas supplier from a neighbor's phone. Follow the gas supplier's instructions.
• If you cannot reach your gas supplier, call the fire department.
- Installation and service must be performed by a qualified installer, service agency or the gas supplier.

AVERTISSEMENT : Assurez-vous de bien suivre les instructions données dans cette notice pour réduire au minimum le risque d'incendie ou d'explosion ou pour éviter tout dommage matériel, toute blessure ou la mort.

- Ne pas entreposer ni utiliser d'essence ni d'autres vapeurs ou liquides inflammables dans le voisinage de cet appareil ou de tout autre appareil.
- QUE FAIRE SI VOUS SENTEZ UNE ODEUR DE GAZ :
• Ne pas tenter d'allumer d'appareil.
• Ne touchez à aucun interrupteur. Ne pas vous servir des téléphones se trouvant dans le bâtiment où vous trouvez.
• Appelez immédiatement votre fournisseur de gaz depuis un voisin. Suivez les instructions du fournisseur.
• Si vous ne pouvez rejoindre le fournisseur de gaz, appelez le service des incendies.
- L'installation et l'entretien doivent être assurés par un installateur ou un service d'entretien qualifié ou par le fournisseur de gaz.

Thank you for your purchase. We appreciate your business!

Please carefully read and follow all instructions in this manual.  
**Pay special attention to all warnings and safety information.**

Following these safety, care, and operation instructions will help ensure many years of dependable and enjoyable service from your fireplace.

**• FREE SAFETY GUARD OFFER •**

*The Lennox® SAFETY GUARD protects against severe burns and injuries by preventing direct contact with the front glass surface of your fireplace.*

To receive your FREE **SAFETY GUARD**, call **1-800-786-7976** or visit **www.lennox.com** (Lennox Hearth Products / Owner Resources)

**Table of Contents**

**Safety and Your Fireplace** . . . . . 2  
**Important Safety Information** . . . . . 4  
**Attaching the Safety-in-Operation Warnings** . . . . . 5  
 General Information . . . . . 6  
 Maintenance . . . . . 9  
 Front Glass Enclosure Panel, Removal and Installation . . . . . 10  
 Log, Vermiculite, Volcanic Stone and Glowing Ember Placement . . . 11  
 Burner Adjustments . . . . . 13  
 Flame Appearance and Sooting . . . . . 13  
 Burner Air Shutter Adjustment . . . . . 14  
 Millivolt Appliance Checkout . . . . . 14  
 Electronic Appliance Checkout . . . . . 14  
 Warranty . . . . . 15  
 Product Reference Information . . . . . 15  
 Ordering Replacement Parts . . . . . 15  
 Wiring Diagrams . . . . . 15  
 Accessory Components . . . . . 16  
 Lighting Instructions – Millivolt . . . . . 18  
 Lighting Instructions – Electronic . . . . . 20  
 Maintenance Schedule . . . . . 22  
 Troubleshooting Guide – Millivolt . . . . . 23  
 Troubleshooting Guide – Electronic . . . . . 24  
 Replacement Parts List . . . . . 25



# Safety and Your Fireplace

## All parts of your Lennox Hearth Products fireplace get EXTREMELY HOT!

- To prevent severe burns and injuries, install a screen or physical barrier to prevent direct contact with the glass.

*To order a FREE Lennox® SAFETY GUARD for your fireplace, see details at left.*

- Follow the safety instructions below and be sure everyone in your household understands this burn hazard:

- **The surfaces on your fireplace get EXTREMELY HOT!**

- **The glass on the front of the fireplace reaches EXTREMELY HIGH temperatures and can cause severe burns if touched.**



- **Keep children away from an operating fireplace. Closely supervise children in any room where a fireplace is operating to prevent contact with glass.**

- **Keep clothing, furniture, gasoline, and other flammable liquids away from the fireplace.**



- **Even after the gas is turned off, fireplace surfaces remain extremely hot.**

- Be sure to attach the enclosed **Safety-in-Operation Warnings** where you turn on your fireplace, to help remind everyone of the dangers associated with high temperatures (see page 5).

- Read **Important Safety Information** on page 4.

[FRENCH]

## ***La sécurité et votre foyer***

**Toutes les parties de votre foyer Lennox Hearth Products deviennent EXTRÊMEMENT CHAUDES !**

- Afin d'éviter de vous brûler gravement ou de vous blesser, installez une grille ou une barrière physique pour empêcher tout contact direct avec la vitre.

***Pour commander un PANNEAU DE PROTECTION Lennox® GRATUIT pour votre foyer, consultez les détails dans la partie gauche.***

- Suivez les instructions de sécurité ci-dessous et veillez à ce que tous les membres de votre famille soient conscients du danger de brûlure encouru :
  - **Les surfaces de votre foyer deviennent EXTRÊMEMENT CHAUDES !**
  - **La vitre située à l'avant du foyer atteint des températures EXTRÊMEMENT ÉLEVÉES et peut causer de graves blessures en cas de contact.**
  - **Tenez les enfants à l'écart du foyer lorsqu'il fonctionne. Surveillez attentivement les enfants dans les pièces où un foyer est utilisé afin d'éviter qu'ils ne soient en contact avec la vitre.**
  - **Tenez tous les vêtements, les meubles, l'essence et tout autre liquide inflammable à l'écart du foyer.**
  - **Même après fermeture du gaz, les surfaces du foyer restent extrêmement chaudes.**
- Veillez à coller les **Étiquettes de mise en garde relatives à la sécurité d'utilisation** à l'endroit où vous utilisez le foyer, pour rappeler à tous les utilisateurs les dangers liés aux températures élevées (**voir page 5**).
- Lisez la section **Informations importantes relatives à la sécurité, page 4.**

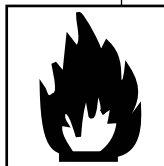

[SPANISH]

## ***Seguridad y su chimenea***

**¡Todas las partes de la chimenea Lennox Hearth Products se ponen MUY CALIENTES!**

- Instale una malla o barrera física para evitar el contacto directo con el vidrio y prevenir las quemaduras y lesiones graves.

***Ver los detalles a la izquierda para ordenar un Lennox® SAFETY GUARD GRATIS para su chimenea.***

- Siga las instrucciones de seguridad a continuación y asegúrese de que todos en su hogar sepan acerca de este peligro de quemadura:
  - **¡Las superficies de la chimenea se ponen MUY CALIENTES!**
  - **El vidrio delante de la chimenea alcanza temperaturas EXTREMADAMENTE ALTAS y puede causar quemaduras graves si se toca.**
  - **Mantenga a los niños alejados de la chimenea en funcionamiento. Supervise en forma cercana a los niños en cualquier cuarto donde haya una chimenea funcionando para impedir el contacto con el vidrio.**
  - **Mantenga la ropa, mobiliario, gasolina y otros líquidos inflamables alejados de la chimenea.**
  - **Aún después de haber apagado el gas, las superficies de la chimenea permanecen extremadamente calientes.**
- Asegúrese de colocar las **Etiquetas de advertencia de seguridad de operación** en el lugar donde enciende la chimenea, para que todos recuerden los peligros asociados con las altas temperaturas (**ver la página 5**).
- Lea la **Información importante** de seguridad en la **página 4.**

## Important Safety Information

- 1. WARNING: Do not operate appliance with the glass front removed, cracked or broken. Replacement of the glass should be done by a licensed or qualified service person .**
- 2. Do not use this appliance if any part has been under water. Immediately call a qualified service technician to inspect the appliance and to replace any part of the control system and any gas control which has been under water.**
- 3. Due to high temperatures, the appliance should be located out of traffic and away from furniture and draperies.**
- 4. Children and adults should be alerted to the hazards of high surface temperature and should stay away to avoid burns or clothing ignition.**
- 5. Clothing or other flammable material should not be placed on or near the appliance.**
- 6. Young children should be carefully supervised when they are in the same room as the appliance. Toddlers, young children, and others may be susceptible to accidental contact burns. A physical barrier is recommended if there are at-risk individuals in the house. To restrict access to a fireplace or stove, install an adjustable safety gate to keep toddlers, young children, and other at-risk individuals out of the room and away from hot surfaces.**
- 7. Any safety screen or guard removed for servicing an appliance must be replaced prior to operating the appliance.**
- 8. Installation and repair should be done by a qualified service person. The appliance should be inspected before use and at least annually by a professional service person. More frequent cleaning may be required due to excessive lint from carpeting, bedding material, et cetera. It is imperative that control compartments, burners, and circulating air passageways of the appliance be kept clean. See maintenance instructions on page 9.**

## L'information de sûreté importante

- 1. AVERTISSEMENT. Ne pas utiliser l'appareil si le panneau frontal en verre n'est pas en place, est craqué ou brisé. Confiez le remplacement du panneau à un technicien agréé**
- 2. Ne pas utiliser cet appareil s'il a été plongé, même partiellement, dans l'eau. Appeler un technicien qualifié pour inspecter l'appareil et remplacer toute partie du système de commande et toute commande qui a été plongée dans l'eau.**
- 3. En raison des températures élevées, l'appareil devrait être installé dans un endroit où il y a peu de circulation et loin du mobilier et des tentures.**
- 4. Les enfants et les adultes devraient être informés des dangers que posent les températures de surface élevées et se tenir à distance afin d'éviter des brûlures ou que leurs vêtements ne s'enflamment.**
- 5. On ne devrait pas placer de vêtements ni d'autres matières inflammables sur l'appareil ni à proximité.**
- 6. Les jeunes enfants devraient être surveillés étroitement lorsqu'ils se trouvent dans la même pièce que l'appareil. Les tout petits, les jeunes enfants ou les adultes peuvent subir des brûlures s'ils viennent en contact avec la surface chaude. Il est recommandé d'installer une barrière physique si des personnes à risques habitent la maison. Pour empêcher l'accès à un foyer ou à un poêle, installez une barrière de sécurité ; cette mesure empêchera les tout petits, les jeunes enfants et toute autre personne à risque d'avoir accès à la pièce et aux surfaces chaudes.**
- 7. Tout écran ou protecteur retiré pour permettre l'entretien de l'appareil doit être remis en place avant de mettre l'appareil en marche.**
- 8. L'installation et la réparation devrait être confiées à un technicien qualifié. L'appareil devrait faire l'objet d'une inspection par un technicien professionnel avant d'être utilisé et au moins une fois l'an par la suite. Des nettoyages plus fréquents peuvent être nécessaires si les tapis, la literie, et cetera produisent une quantité importante de poussière. Il est essentiel que les compartiments abritant les commandes, les brûleurs et les conduits de circulation d'air de l'appareil soient tenus propres. Voyez les instructions d'entretien à la page 9.**

[SPANISH]

## Información importante de seguridad

- 1. ADVERTENCIA: No opere el artefacto con el frente de vidrio quitado, agrietado o roto. Un técnico de servicio licenciado o capacitado debe reemplazar el vidrio.**
- 2. No use este artefacto si alguna de sus partes ha estado bajo agua. Llame de inmediato a un técnico de servicio calificado para que inspeccione el artefacto y reemplace cualquier parte del sistema de control y cualquier control de gas que haya estado bajo agua.**
- 3. Debido a las altas temperaturas, el artefacto debe situarse fuera de las áreas de tráfico y lejos del mobiliario y cortinas.**
- 4. Se debe alertar a los niños y adultos sobre los peligros de las altas temperaturas en la superficie y que se mantengan alejados para evitar quemaduras o ignición de la ropa.**
- 5. No debe colocarse ropa u otros materiales inflamables sobre y cerca del artefacto.**

- 6. Se debe supervisar de cerca a los niños cuando estén en el mismo cuarto que el artefacto. Los niños pequeños, los jóvenes y otras personas pueden ser susceptibles a quemaduras por contacto accidental. Se recomienda instalar una barrera física si hay personas en riesgo en la casa. Para restringir el acceso a una chimenea o estufa, instale una puerta de seguridad ajustable para mantener a los niños pequeños, jóvenes y otras personas en riesgo fuera del cuarto y lejos de las superficies calientes.**
- 7. Cualquier malla o resguardo de seguridad quitado para dar servicio a un artefacto, debe reinstalarse antes de operar el artefacto.**
- 8. Una persona de servicio competente debe realizar la instalación y reparación. Una persona de servicio profesional debe inspeccionar el artefacto antes de usar al menos una vez por año. Se puede requerir limpieza más frecuente debido a la pelusa excesiva del alfombrado, del material de cobijas, etc. Es imprescindible mantener limpios los compartimientos de control, los quemadores y los pasajes de circulación del aire del artefacto. Ver las instrucciones de mantenimiento en la página 9.**

## HOMEOWNER'S INSTRUCTIONS - ATTACHING SAFETY-IN-OPERATION WARNINGS

### ATTACHING SAFETY-IN-OPERATION WARNINGS

Your fireplace has been furnished with safety instruction labels that are to be affixed to the operation and control point of the fireplace. A safety instruction label should be affixed to the wall switch plate where the fireplace is turned on and off (*See Figure A*) or wall thermostat (*See Figure B*) and if used on the remote control handheld transmitter (*Figure C*). The warnings should already have been put in place when the fireplace initial set-up was completed. If they are not affixed at these spots, locate the multi-lingual adhesive labels provided with these instructions and proceed as follows:

1. Locate the wall switch or wall thermostat that controls the fireplace (verify the switch operates the fireplace by turning it on and off). Clean the wall switch plate or wall thermostat thoroughly to remove any dust and oils. Affix the label to the surface of the plate of the wall switch that controls the fireplace (*Figure A*) or the wall thermostat (*Figure B*). Choose the language primarily spoken in the home.
2. If a remote control is used to control the fireplace, locate the transmitter and clean it thoroughly to remove any dust and oils. Affix the label to the surface of handheld transmitter (*Figure C*). Choose the language primarily spoken in the home.
3. If you are unable to locate the labels, please call Lennox Hearth Products or your nearest Lennox Hearth Products dealer to receive additional safety instruction labels free of charge.

Cat. No. H8024 Replacement Label Kit

**LENNOX HEARTH PRODUCTS**  
1-800-9-LENNOX

*Note: English is red text on clear label. French and Spanish are white text on black label.*

### SAFETY LABEL DIAGRAMS



Figure A

### APPOSITION DES MISES EN GARDE RELATIVES À LA SÉCURITÉ D'UTILISATION

Votre foyer a été livré avec des étiquettes de sécurité qui doivent être collées à côté des dispositifs de contrôle du foyer. Une étiquette de sécurité doit être collée sur la plaque de l'interrupteur contrôlant l'allumage du foyer (*voir Figure A*) ou sur le thermostat mural (*voir Figure B*) et, le cas échéant, sur le boîtier de la télécommande (*Figure C*). Les mises en garde auraient dû être collées au moment de l'installation initiale du foyer. Si ce n'est pas le cas, prenez les étiquettes adhésives multilingues fournies avec ces instructions et procédez comme suit:

1. Repérez l'interrupteur ou le thermostat mural qui contrôle le foyer (vérifiez que l'interrupteur contrôle le fonctionnement du foyer en le faisant basculer de Marche à Arrêt, et vice-versa). Nettoyez soigneusement la plaque murale de l'interrupteur ou le thermostat mural pour éliminer la poussière et les traces de graisse ou d'huile. Collez l'étiquette sur la surface de la plaque de l'interrupteur mural qui contrôle le foyer (*Figure A*) ou du thermostat mural (*Figure B*). Choisissez la langue qui est principalement parlée dans la résidence du propriétaire.
2. Si une télécommande est utilisée pour contrôler le foyer, nettoyez la soigneusement pour éliminer la poussière et les traces de graisse ou d'huile. Collez l'étiquette sur le boîtier de la télécommande (*Figure C*). Choisissez la langue qui est principalement parlée dans la résidence du propriétaire.
3. Si vous ne trouvez pas les étiquettes, veuillez appeler Lennox Hearth Products ou votre distributeur Lennox Hearth Products local pour recevoir gratuitement des étiquettes supplémentaires.

Étiquettes de remplacement, n° cat. H8024

**LENNOX HEARTH PRODUCTS**  
1-800-9-LENNOX

*Remarque : Le texte anglais est rouge sur un support transparent. Le texte français et espagnol est blanc sur un support noir.*

### DIAGRAMMES DES ÉTIQUETTES DE SÉCURITÉ



Figure B

### COLOCACIÓN DE ADVERTENCIAS DE SEGURIDAD EN OPERACIÓN

Su chimenea incluye etiquetas de instrucciones de seguridad que deben colocarse en el punto de operación y control de la chimenea. Se debe colocar una etiqueta de instrucciones de seguridad en la placa del interruptor de pared desde el cual se enciende y se apaga la chimenea (*ver la Figura A*) o en el termostato de pared (*ver la Figura B*) y en el transmisor de control remoto (*Figura C*) si se usa. Las advertencias ya deben haberse colocado cuando se completó la instalación inicial de la chimenea. Si no están colocadas en estos lugares, encuentre las etiquetas adhesivas multilingües proporcionadas con estas instrucciones y prosiga de la siguiente manera:

1. Identifique el interruptor o el termostato de pared que controla la chimenea (verifique que el interruptor opera la chimenea encendiéndola y apagándola). Limpie bien la placa del interruptor o el termostato de pared para quitar el polvo y aceite. Pegue la etiqueta en la superficie de la placa del interruptor que controla la chimenea (*Figura A*) o en el termostato de pared (*Figura B*). Seleccione el idioma que más se habla en la casa.
2. Si se usa un control remoto para controlar la chimenea, encuentre el transmisor y límpielo bien para quitar el polvo y aceite. Pegue la etiqueta en la superficie del transmisor (*Figura C*). Seleccione el idioma que más se habla en la casa.
3. Si no puede encontrar las etiquetas, sírvase llamar a Lennox Hearth Products o al distribuidor de Lennox Hearth Products más cercano para recibir etiquetas de instrucciones de seguridad adicionales gratuitas.

Juego de etiquetas de repuesto - N° de cat. H8024

**LENNOX HEARTH PRODUCTS**  
1-800-9-LENNOX

*Nota: La etiqueta en inglés es transparente con texto rojo. Las etiquetas en francés y español son negras con texto blanco.*

### DIAGRAMAS DE ETIQUETAS DE SEGURIDAD



Figure C

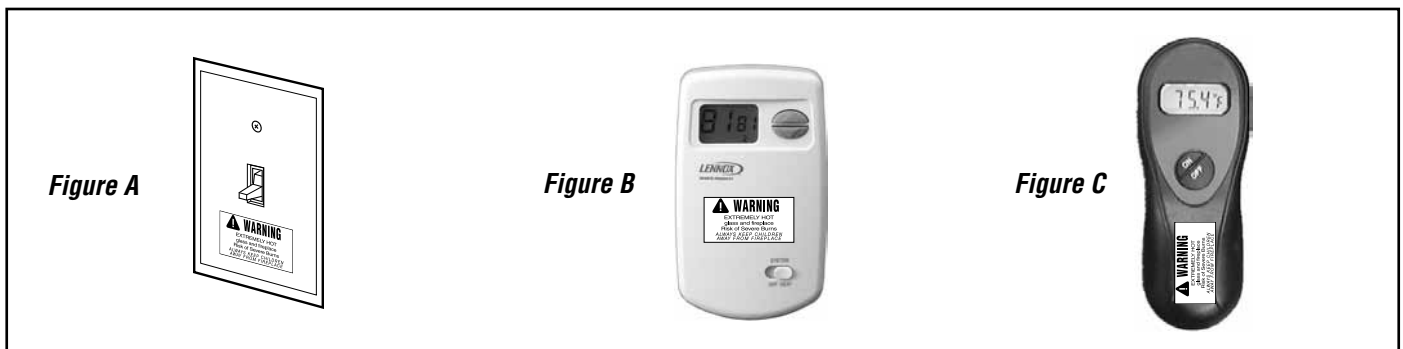

**APPLIANCE INSTALLATION, SERVICE, AND MAINTENANCE NOTICES**

**IMPORTANT:** Improper installation, adjustment, alteration, service, or maintenance can cause injury or property damage. Refer to this manual. For assistance or additional information, consult a qualified installer, service agency or the gas supplier.

Only trim kit(s) supplied by the manufacturer shall be used in the installation of this appliance.

Draft relief openings must not be covered or blocked.

These appliances must not be connected to a chimney or flue serving a separate solid fuel burning appliance.

Any change to this appliance and/or its operating controls is dangerous. Improper installation or use of this appliance can cause serious injury or death from fire, burns, explosion or carbon monoxide poisoning.

**CARBON MONOXIDE POISONING:** Early signs of carbon monoxide poisoning are similar to the flu with headaches, dizziness and/or nausea. If you have these signs, obtain fresh air immediately. Turn off the gas supply to the appliance and have it serviced by a qualified professional, as it may not be operating correctly. Some people are more affected by carbon monoxide than others, including pregnant women, people with heart or lung disease or anemia, those under the influence of alcohol, and those at high altitudes.

Turn off gas and electrical power to the fireplace and allow it to cool before cleaning or servicing the appliance.

The vent termination is hot while in operation and for a period of time following the use of the fireplace. Young children should be carefully supervised when they are in the same area as a hot termination

**APPLIANCE OPERATION NOTICES**

**Do not operate appliance with the glass front removed, cracked, or broken.**

**These fireplaces are vented gas appliances. Do not burn wood or other material in these appliances.**

**This appliance is only for use with the type of gas indicated on rating plate. This appliance is not convertible for use with other gases, unless a certified kit is used.**

**These appliances are designed to operate on natural gas or propane gas only. The use of other fuels or combinations of fuels will degrade the performance of this system and may be dangerous.**

**Provide adequate clearances around air openings and adequate accessibility clearance for service and proper operation. Never obstruct the front openings of the appliance.**

**Do not use this appliance if any part has been under water. Immediately call a qualified service technician to inspect the appliance and to replace any part of the control system and any gas control that has been under water.**

**These fireplaces are designed as supplemental heaters. Therefore, it is advisable to have an alternate primary heat source when installed in a dwelling.**

**WARRANTY INFORMATION**

Your gas appliance is covered by a limited twenty-year warranty. You will find a copy of the warranty accompanying this manual. Please read the warranty to be familiar with its coverage.

Retain this manual. File it with your other documents for future reference.

**Failure to comply with the installation and operating instructions provided will result in an improperly installed and operating appliance, voiding its warranty.**

**Do not attempt to alter or modify the construction of the appliance or its components. Any modification or alteration may void the warranty, certification, and listings of this unit.**

**GENERAL INFORMATION**

The fireplace models covered in this manual are direct-vent, sealed combustion gas fireplaces designed for residential application. Direct-vent appliances operate with the combustion chamber completely isolated from the indoor environment.

All air for combustion is brought in from the outside and exhaust gases are vented through the same direct-vent, co-axial (intake/exhaust) vent system.

The **Millivolt** appliances are designed to operate on either natural or propane gas and have a millivolt gas control valve with piezo ignition system.

The **Electronic** appliances are designed to operate on natural gas only and contain an electronic intermittent pilot system. External electrical power is required to operate these units.

These appliances comply with National Safety Standards and are tested and listed by OMNI-Test Laboratories, Inc. (Report No. 116-F-22-5) to ANSI Z21.50 (in Canada, CSA-2.22), and CAN/CGA-2.17-M91 in both the USA and Canada as vented gas fireplaces.

The Installation must conform to local codes or, in the absence of local codes, with the *National Fuel Gas Code, ANSI Z223.1/NFPA 54 - latest edition*, or the *Natural Gas and Propane Installation Code, CSA B149.1 - latest edition*. The appliance, when installed, must be electrically grounded in accordance with local codes or, in the absence of local codes, with the *National Electrical Code, ANSI/NFPA 70 - latest edition*, or the *Canadian Electrical Code, CSA C22.1 - latest edition*.

**BTU Input**

Millivolt and electronic models come standard with a manually-modulated gas valve; flame appearance and heat output can be controlled at the gas valve. The BTU Input for these appliances are shown in **Table 1**.

Input (BTU/HR) - All Models			
Natural Gas		Propane Gas	
Model No.	Input (BTU/Hr)	Model No.	Input (BTU/Hr)
LSM40-2	40,000 to 50,000	LSM40-2	40,000 to 50,000
LSM45-2	47,000 to 60,000	LSM45-2	48,000 to 60,000

**Table 1**

**Gas Pressure**

**Tables 2 and 3** show the appliances' gas pressure requirements.

Inlet Gas Supply Pressure (all models)		
Fuel #	Minimum	Maximum
Natural Gas	5.5" WC (1.37 kPa)	10.5" WC (2.61 kPa)
Propane	11.0" WC (2.74 kPa)	13.0" WC (3.23 kPa)

**Table 2**

Manifold Gas Supply Pressure (all models)		
Fuel #	Low	High
Natural Gas	(Lo) 2.2" WC (0.55 kPa)	(Hi) 3.5" WC (0.87 kPa)
Propane	(Lo) 6.3" WC (1.57 kPa)	(Hi) 10.0" WC (2.49 kPa)

**Table 3**

Test gauge connections are provided on the front of the millivolt and electronic gas control valve, identified IN for the inlet and OUT for the manifold side (see **Figures 2 and 3** on **Page 8**). The control valves have a 3/8" (10 mm) NPT thread inlet and outlet side of the valve.

These appliances must be isolated from the gas supply piping system (by closing their individual manual shut-off valve) during any pressure testing of the gas supply piping system at test pressures equal to or **less than** 1/2 psig (3.5 kPa).

These appliances and their individual shut-off valves must be disconnected from the gas supply piping system during any pressure testing of that system at pressures **greater than** 1/2 psig (3.5 kPa).

**Orifice Sizes - Sea Level to High Altitude**

**(All Models):** These appliances are tested and approved for installations at elevations of 0-4500 feet (0-1372 meters) above sea level using the standard burner orifice sizes (marked with an "\*" in **Table 4**).

For higher elevations, contact your gas supplier or qualified service technician.

Install the appliance according to the regulations of the local authorities having jurisdiction and, in the USA, the National Fuel Gas Code NFPA 54 / ANSI Z223.1 - latest edition or, in Canada, the CAN/CSA-B149.1 - latest edition.

Burner Orifice Sizes Elevation 0-4500 feet ( 0-1372 meters)		
Model	Nat. Gas drill size (inches)	Propane drill size (inches)
LSM40-2	0.1405" (#28)* • H2286	0.086" (#44)* • H2287
LSM45-2	0.161" (#20)* • H2288	0.093" (#42)* • H4816

**Table 4** \* Standard size installed at factory Part /Cat. Number

**Deration**

At higher elevations, the amount of BTU fuel value delivered must be reduced by either using gas that has been derated by the gas company or by changing the burner orifice to a smaller size as regulated by the local authorities having jurisdiction and by the (USA) National Fuel Gas Code NFPA 54/ANSI Z223.1 - latest edition or, in Canada, the CAN/CSA-B149.1 codes - latest edition.

**Burn-in Period**

During the first few fires of this appliance there will be some odor due to the curing of the paint and burning off of lubricants used in the manufacturing process. Depending on your use, the burn-in period may take a few hours or a few days.

**KEEP YOUR HOUSE WELL VENTILATED DURING THE CURING PROCESS. THE ODOR AND HAZE EMITTED DURING THE CURING PROCESS CAN BE QUITE NOTICEABLE AND MAY SET OFF A SMOKE DETECTOR.**

**NOTICE:** A white film may develop on the glass enclosure panel during the first few fires as part of the burn-in process. **The first few times you use the fireplace, clean the glass after each use (AFTER THE GLASS HAS COMPLETELY COOLED); otherwise, the white film will bake onto the glass and become difficult to remove.** See glass cleaning instructions on **Page 9**.

NOTE: DIAGRAMS & ILLUSTRATIONS ARE NOT TO SCALE.

**OPERATION AND CARE OF YOUR APPLIANCE**

**! WARNING**

Young children should be carefully supervised when they are in the same room as the appliance. Toddlers, young children and others may be susceptible to accidental contact burns. A physical barrier is recommended if there are at risk individuals in the house. To restrict access to a fireplace or stove, install an adjustable safety gate to keep toddlers, young children and other at risk individuals out of the room and away from hot surfaces.

**! AVERTISSEMENT**

Les jeunes enfants devraient être surveillés étroitement lorsqu'ils se trouvent dans la même pièce que l'appareil. Les tout petits, les jeunes enfants ou les adultes peuvent subir des brûlures s'ils viennent en contact avec la surface chaude. Il est recommandé d'installer une barrière physique si des personnes à risques habitent la maison. Pour empêcher l'accès à un foyer ou à un poêle, installez une barrière de sécurité; cette mesure empêchera les tout petits, les jeunes enfants et toute autre personne à risque d'avoir accès à la pièce et aux surfaces chaudes.

**Gas Controls / Control Compartment Access**

The gas controls can be found on the right hand side of the appliance as shown in **Figure 1**.

The standard controls for appliance operation are located behind the panel on the right side as shown in **Figure 1**. Optional control switches are also available (see **Page 16** - remote wall switch, remote control or wall thermostat).

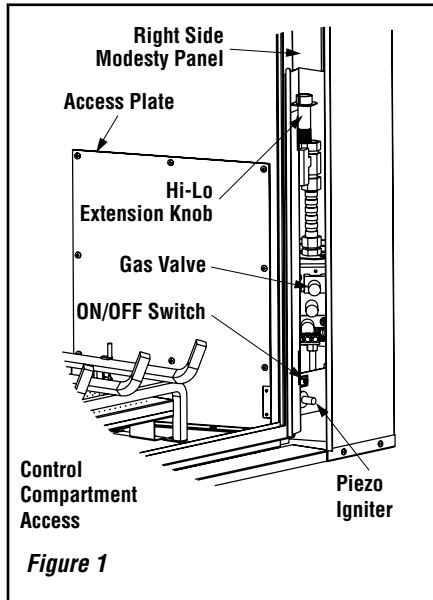

**Operation And Care Of Your Appliance**

Operation of millivolt and electronic gas control systems are different. Before lighting and operating your appliance determine if you have a millivolt or electronic appliance. Familiarize yourself with the gas control valve that your appliance uses. Refer to **Figure 1** for access to the gas control valve.

**Millivolt Appliances** - Appliances with Millivolt systems will be fitted with the gas control valve shown in **Figure 2**.

**Electronic Appliances** - Appliances with electronic systems will be fitted with the electronic valve shown in **Figure 3**.

To light the appliance refer to the detailed lighting instructions (see **Pages 18 and 19** for millivolt models and **Pages 20 and 21** for electronic models). The appliance lighting instructions may also be found on the pull out lighting instruction labels attached to the gas control valve.

These appliance are fitted with an ON/OFF rocker switch for appliance ON/OFF control. See **Figure 1** for its location. Once the pilot is lit, the ON/OFF rocker switch will control the appliance ON/OFF operation. To operate: Toggle the switch between its ON and OFF positions.

If your appliance is equipped with an optional remote switch kit, wall switch, remote control or wall thermostat, (millivolt models pilot must be lit), the appliance main burner may be turned on and off using the optional switch.

**Note:** To prevent excessive resistance in burner circuit (which can cause burner operation problems), only one burner control switch should be wired to valve.

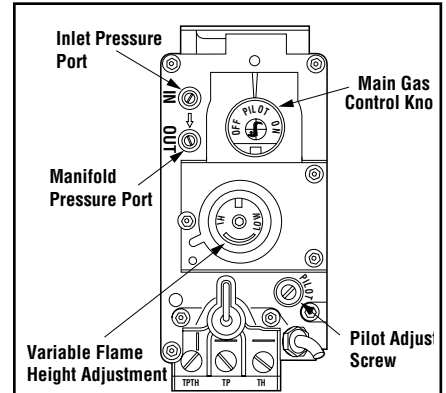

**Figure 2 - SIT Millivolt Gas Valve**

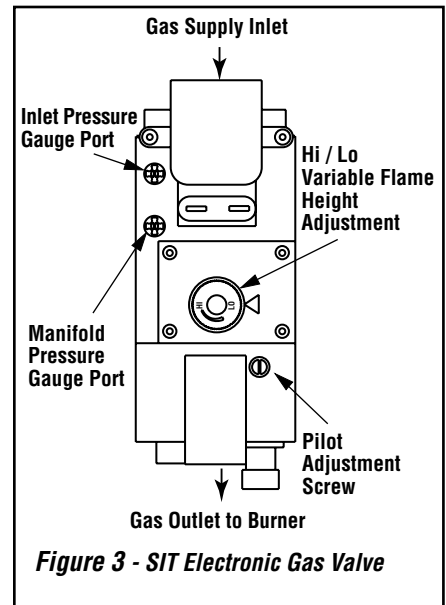

**Figure 3 - SIT Electronic Gas Valve**

**Variable Flame Height Adjustment (Millivolt And Electronic Appliances)**

All millivolt and electronic appliances are equipped with a variable gas control valve. Flame height for these models may be adjusted through a range between fixed low and high settings, alternately, while the appliance is in operation. Use the extension knob (refer to **Figure 1**), to adjust the flame height as desired by sliding the knob over the variable flame adjustment knob located on the front of the valve (refer to **Figures 1, 2 and 3**). Replace the extension knob back to the hanger after the adjustment.



## MAINTENANCE

(See Maintenance Schedule, **Page 22**)

Refer to the maintenance schedule for maintenance tasks, procedures, frequency and by whom they should be performed. Always verify proper operation of the appliance after servicing.

### WARNING

**Turn off gas and electrical power to the fireplace and allow it to cool before cleaning or servicing the appliance.**

**CAUTION:** Wear gloves and safety glasses for protection while doing required maintenance.

Verify proper operation after servicing.

S'assurer que l'appareil fonctionne adéquatement une fois l'entretien terminé.

Always turn off gas to the pilot (millivolt appliances) before cleaning. Before re-lighting, refer to the lighting instructions in this manual. Instructions are also found on a pull-out panel located in the control compartment.

Before re-lighting the fireplace, refer to the lighting instructions in this manual. Instructions are also found on pull-out panels located in the control compartment.

### Inspect Venting System

The appliance and venting system should be thoroughly inspected before initial use and at least annually by a qualified service technician (inspection should include ensuring that exhaust or intake passages are unobstructed and vent components are properly assembled and not damaged). **Homeowner must contact a qualified service technician at once if any abnormal condition is observed.**

If the venting system is disassembled for any reason, a qualified service technician should follow vent installation instructions for proper reassembly and proper sealing of the venting system components. However, more frequent periodic inspections and cleanings should be performed by the homeowner.

### Glass Cleaning

(See *Front Glass Enclosure Panel, Removal and Installation* on **Page 10**).

**Note:** Clean glass after first two weeks of operation (after Burn-In period is over) and then only when necessary and when the fireplace is cool. Wipe surface with clean, dampened, soft cloth. Follow with a dry, soft towel as desired. Take care not to scratch the glass surface.

**IMPORTANT: Do not use abrasive cleaners on glass. Never clean the glass when it is hot.**

The viewing glass should be cleaned periodically to remove any build-up caused from the following:

- During start-up, it is normal for condensation to form on the inside of the glass (this condensation and fog will usually disappear in a few minutes). The moisture can cause lint, dust and other airborne particles to cling to the glass surface.
- Initial curing of the high temperature paint and burning off of lubricants used in the manufacturing process may result in a film on the glass.
- A white coating may form on the glass as a result of impurities and minerals in the fuel.

It is recommended that the glass be cleaned two or three times during each heating season, depending on the circumstances present. The following cleaning solutions are approved for use to clean glass:

- Non-ammonia based household cleaner
- 50%-50% mix of white vinegar & water
- Gas fireplace/stove glass cleaner

**Inspect Glass Gasket** - Visually inspect the gasket on the backside of the glass enclosure panels. The gasket surface must be clean, free of irregularities and seated firmly.

### Clean Control Compartment

Keep control compartment clean by vacuuming or brushing at least twice a year. More frequent cleaning may be required due to excessive lint from carpeting, bedding materials, etc. It is important that control compartments, burners and circulating air passageways of the appliance be kept clean.

### Clean Logs and Burner

Carefully remove the logs (use care when handling the fiber logs, as they become quite fragile after curing). Vacuum out any foreign matter (lint, carbon, etc.) on the burner. Ensure the burner ports are "open." Remove any carbon deposits from the under side of the logs using a vacuum cleaner, or a soft bristled brush (i.e. paint brush).

**Note:** Improper positioning of logs can create carbon build-up and will alter the performance of the appliance.

### Replacing Logs

If the logs become damaged by accident or improper handling and need replacement, use only the proper replacement logs from manufacturer (see **Pages 25 and 26** for ordering information).

### Re-install Embers, Vermiculite, Volcanic stone and Logs

Carefully follow placement instructions on **Pages 11 and 12**). All logs should fit onto corresponding pins and/or log stoppers. This will ensure a proper flame and safe combustion.

### Inspect Wiring

Refer to wiring diagrams on **Page 15**.

**CAUTION:** Label all wires prior to disconnection when servicing controls. Wiring errors can cause improper and dangerous operation. Verify proper operation after servicing.

**ATTENTION:** Au moment de l'entretien des commandes, étiquetez tous les fils avant de les débrancher. des erreurs de câblage peuvent entraîner un fonctionnement inadéquat et dangereux.

Inspect and clean all wire connections. Ensure that there is no melting or damage. Inspection should include:

- Terminals at the Valve
- OFF/ON Switch
- (Optional Control Switch) Wall Thermostat, Remote Control or Remote Wall Switch

### Inspect Burner Flame Appearance

Ensure that the burner flame appearance resembles the flame shown in **Figures 13 and 14** and as described in *Flame Appearance and Sooting* on **Page 13**. The Homeowner must contact a qualified service technician at once if any abnormal condition is observed.

### Small Area Paint Touch-up

Only use a factory supplied paint kit for touch-ups. Paint is available at your local authorized Lennox Hearth Products dealer. Never attempt to paint a hot fireplace.

If the surface later becomes stained or marred, it may be lightly sanded and touched up with spray paint.

**Front Glass Enclosure Panel, Removal and Installation**

**! WARNING**

- When reinstalling the glass door, the door latch screws must be securely tightened to prevent the glass door from falling out, which could potentially cause damage and possible injury.
- Do not attempt to substitute the materials used on this door, or replace cracked or broken glass.
- Handle this glass with extreme care! Glass is susceptible to damage – Do not scratch or handle roughly while reinstalling the glass door frame.
- The glass door of this appliance must only be replaced as a complete unit as provided by the manufacturer. Do not attempt to replace broken, cracked or chipped glass separately.
- Do not attempt to touch the front enclosure glass with your hands while the fireplace is in use.

**! WARNING**

Do not operate appliance with the glass front removed, cracked or broken.

**! AVERTISSEMENT**

Ne pas utiliser l'appareil si le panneau frontal en verre n'est pas en place, est craqué ou brisé.

**! WARNING**

Any safety screen or guard removed for servicing the appliance must be replaced prior to operating the appliance.

**! AVERTISSEMENT**

Tout écran ou protecteur retiré pour permettre l'entretien de l'appareil doit être remis en place avant de mettre l'appareil en marche.

Only doors certified with the appliance shall be used.

Seules des portes certifiées pour cet appareil doivent être utilisées.

**CAUTION: DO NOT** abuse glass door by striking or slamming shut.

These are direct-vent appliances. They are designed to operate only when the front glass enclosure panel is installed. Generally the front glass enclosure panel should not be removed except to gain access to the components within the firebox.

**Removing Glass Enclosure Panel (see Figure 4)**

To remove the firescreens, lift up the center of the rod to disengage it from the center bracket, bend down at center, hold left side with hand until it disengages from left side, being careful not to scratch paint. Slowly remove the rod from the right side.

Remove the door modesty shield from the top flange glass door by pulling it up firmly with both hands until it is disengaged. Using a phillips screwdriver, unfasten two (2) screws located at the top of the glass frame.

Tilt the glass frame at the top away from the unit. Lift it carefully off the bottom door track and set the door aside, protecting it from inadvertent damage.

To install the front glass door assembly, proceed as follows:

1. Retrieve the glass door assembly. Visually inspect the gasket on the backside of the panel. The gasket surface must be clean, free of irregularities and seated firmly.
2. Position the door frame in front of the firebox opening and engage the bottom flange over the rail at the bottom of the firebox opening.
3. Swing the door up and back. Ensure the gasket seats evenly as the door draws shut. Engage the nut insert and fasten with two screws to secure the door.
4. Install the door modesty shield on top flange glass door as follows: grab the door modesty shield with both hands, with the open hem going down and engage it with the upper lip of the glass door frame by pushing it all the way down. Make sure the installed shield is firmly in place.
5. With the firescreen hanging on the screen rod, drop in the right side of the rod to the right modesty panel. Then drop in the left side of the rod through the slot of the left modesty panel. Make sure that the rod is supported by the bracket in the center of the fireplace.

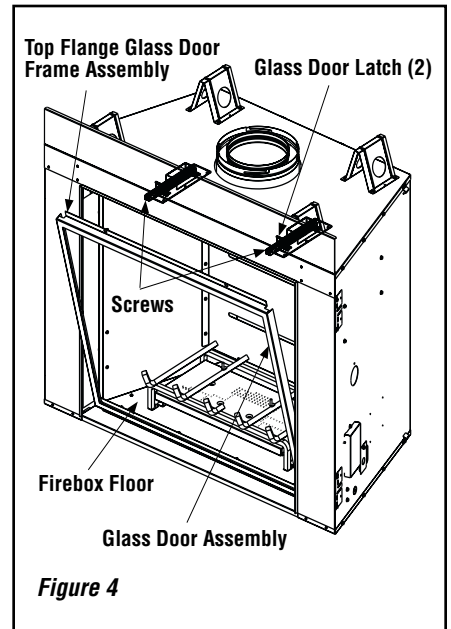

Figure 4

**LOG, VERMICULITE, VOLCANIC STONE AND GLOWING EMBER PLACEMENT**

**! WARNING**

- **DO NOT attempt to install the logs until the appliance installation has been completed, the gas line connected and tested for leaks and the initial burner operation has been checked out.**
- **The size and position of the log set was engineered to give the appliance a safe, reliable and attractive flame pattern. Any attempt to use a different log set in the firebox will void the warranty and will result in incomplete combustion, sooting, and poor flame quality.**
- **Logs get very hot and will remain hot up to one hour after gas supply is turned off. Handle only when logs are cool. Turn off all electricity to the appliance before you install grate, volcanic stone, vermiculite, embers and logs.**
- **This appliance is not designed to burn wood. Any attempt to do so could cause irreparable damage to the appliance and prove hazardous to your safety.**
- **If logs are not installed according to the log installation instructions, flame impingement and improper combustion could occur and result in soot and/or excessive production of carbon monoxide (CO), a colorless, odorless, toxic gas.**

**Step 1.** Install the ceramic panels, if necessary, per the instructions provided in kit (*reference form #750182M*).

**Step 2.** Place a mixture of volcanic stone and vermiculite around the burner as shown in *Figure 7*.

**Step 3.** Separate the glowing embers (rockwool) into pieces about the size of a quarter (see *Figure 5*). Keep the pieces fluffed, not matted. Distribute these pieces over the burner as shown in *Figure 6*. Do not use more than necessary. When properly positioned, the Glowing Embers will cover approximately 75% of the burner on natural gas. For propane gas, do not place embers on main ports.

**Note:** Excessive use of embers may result in sooting or poor flame. This appliance is provided with enough Glowing Embers for several applications, do not feel compelled to use all that is in a new bag. For best glowing effect, replace the ember material annually. Replacement Glowing Embers are available (*Catalog Number 88L53*).

**Step 4.** Position the individual logs as shown in *Figures 8 through 12*. Logs should be placed in the order shown. **Place logs 2 and 3 against the pins on the grate, NOT over them.**

Proper log and twig placement is critical to encourage outstanding flame appearance and prevent sooting. When positioned properly as shown, twigs will be positioned between flame peaks and will not impinge any flames. Positioning is the same for all colors of log sets.

REFERENCE - Firebox Accessories / Parts		
Cat. No.	Model	Description
88L53	FGE	Bag of Glowing Embers
80L42	FDVS	Bag of Volcanic Stone
H3696		Bag of Vermiculite

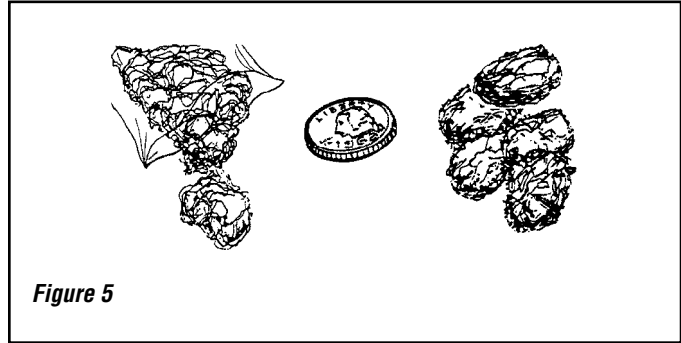

Figure 5

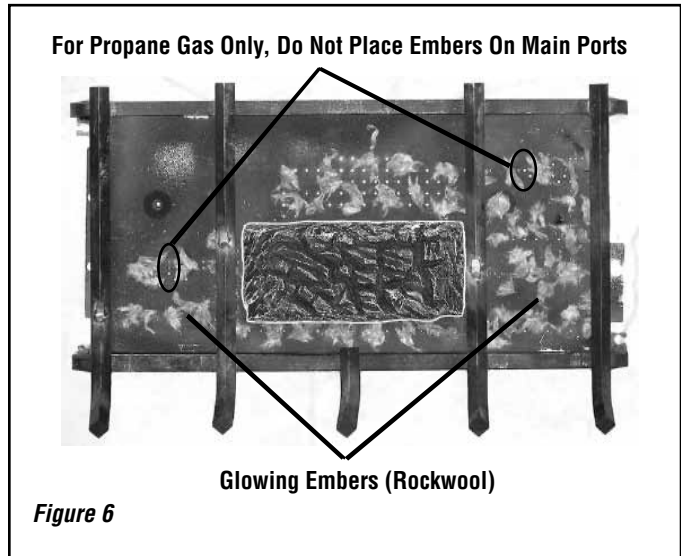

Figure 6

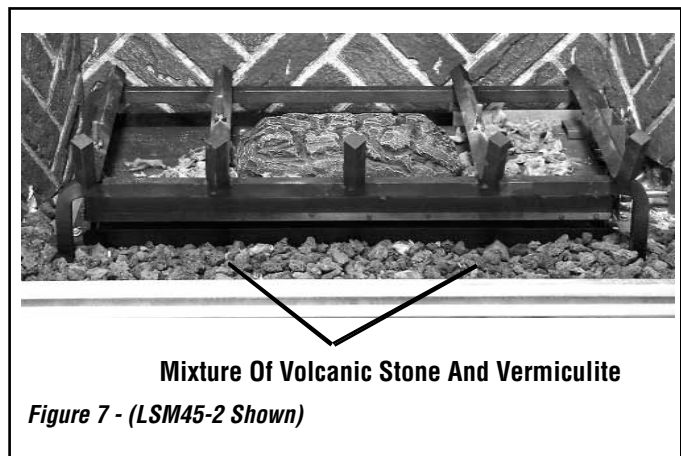
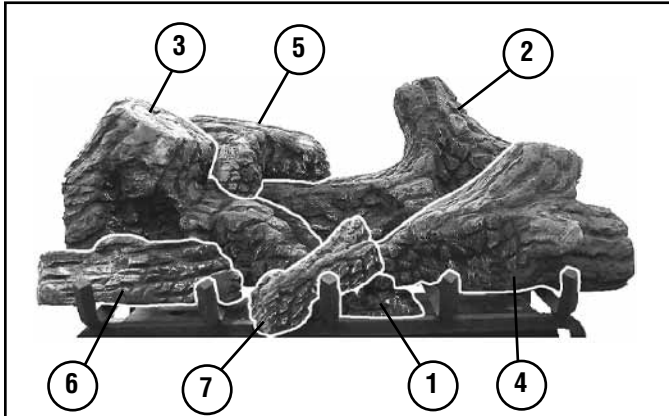

Figure 7 - (LSM45-2 Shown)

### LSM40-2 & LSM45-2 Log Placement



Log Number	Description
1	Log, Center
2	Log, Rear
3	Log, Center/Left
4	Log, Center/Right
5	Log, Rear/Top
6	Log, Front/Left
7	Log, Front/Center

Figure 8

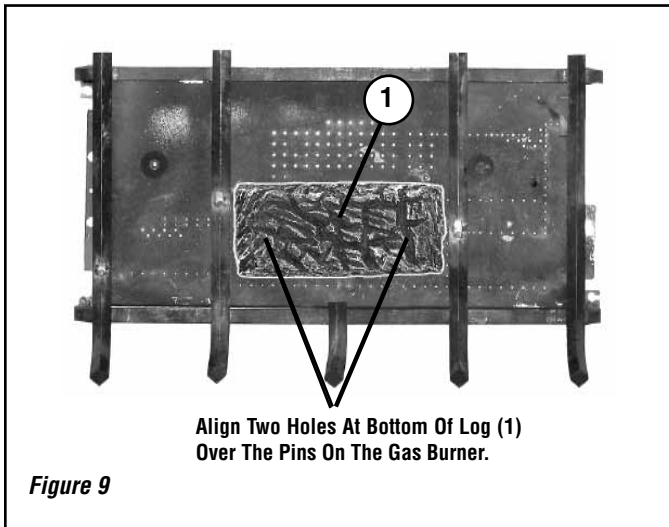

Align Two Holes At Bottom Of Log (1) Over The Pins On The Gas Burner.

Figure 9

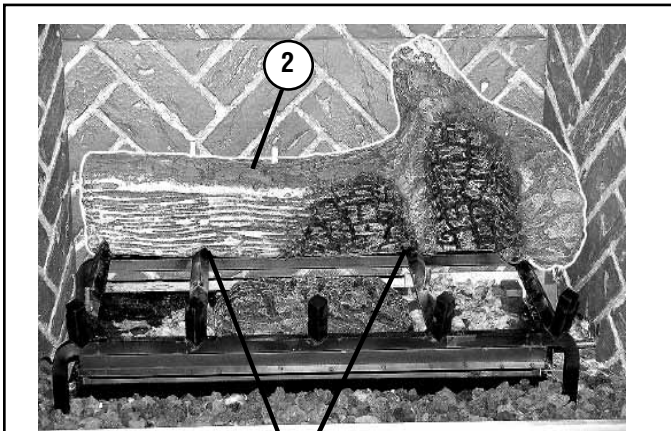

Figure 10

Align Groove At The Bottom Of Log (2) Over The Grate And Push It Towards The Rear.

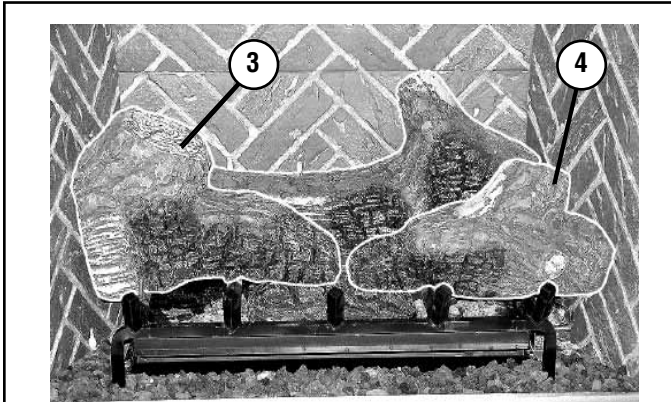

Figure 11

Engage Logs (3 & 4) With The Grate Pins And Align Grooves At The Bottom Of The Logs Over The Grate.

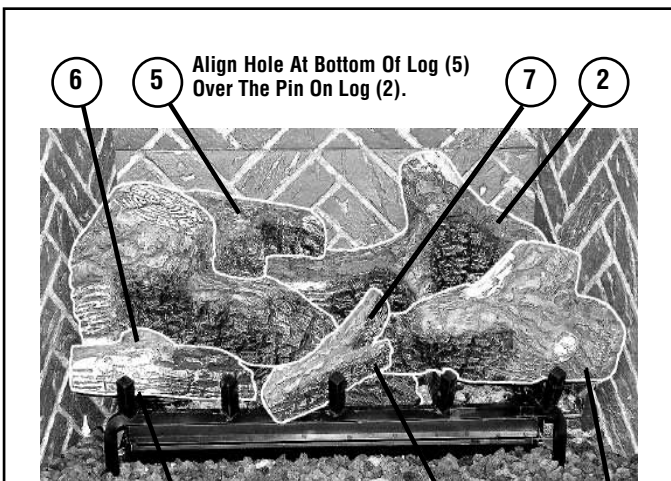

Figure 12

Align Hole At Bottom Of Log (5) Over The Pin On Log (2).  
Engage Log (6) With The Grate Pin And Align Groove At The Bottom Of The Log Over The Grate.  
Engage Log (7) With The Pin On Log (4).

**BURNER ADJUSTMENTS  
(QUALIFIED TECHNICIANS ONLY)**

**Flame Appearance and Sooting**

Proper flame appearance is a flame which is blue at the base and becomes yellowish-orange in the body of the flame. When the appliance is first lit, the entire flame may be blue and will gradually turn yellowish-orange during the first 15 minutes of operation. After 15 minutes of operation, if the flame is blue, or if the flame is orange with evidence of sooting (black tip), the air shutter opening may need to be adjusted.

If the air shutter opening is closed too far, sooting may develop. Sooting is indicated by black puffs developing at the tips of very long orange flames. Sooting results in black deposits forming on the logs, appliance inside surfaces and on exterior surfaces adjacent to the vent termination.

Sooting is caused by incomplete combustion in the flames and lack of combustion air entering the air shutter opening. To achieve a warm yellowish-orange flame with an orange body that does not soot, the shutter opening must be adjusted between these two extremes.

**Air Shutter Adjustment Guidelines**

- If there is smoke or soot present, first check the log set positioning to ensure that the flames are not impinging on any of the logs. If the log set is properly positioned and a sooting condition still exists, then the air shutter opening should be increased.
- The more offsets in the vent system, the larger the air shutter opening will need to be.
- An appliance operated with the air shutter opened too far, may have flames that appear blue and transparent. These weak, blue and transparent flames are termed anemic.
- Propane models may exhibit flames which candle or appear stringy. If this is present and persists, adjust the air shutter to a more closed position, then operate the appliance for a few more minutes to ensure that the flame normalizes and the flames do not appear sooty.

The following chart is provided to aid you in achieving the correct air shutter adjustment for your installation.

<b>Air Shutter Adjustment Guidelines:</b>		
<b>Amount of Primary Air</b>	<b>Flame Color</b>	<b>Air Shutter Adjustment</b>
If air shutter is closed too far →	Flame will be orange →	Air shutter gap should be increased
If air shutter is open too far →	Flame will be blue →	Air shutter gap should be decreased



**Figure 13 - Burner Flame Appearance**



**Figure 14 - Burner Flame Appearance**

NOTE: DIAGRAMS & ILLUSTRATIONS ARE NOT TO SCALE.

**Burner Air Shutter Adjustment Procedure**

**⚠ WARNING**

- Air shutter adjustment should only be performed by a qualified professional service technician.
- Ensure that the front glass door assembly is in place and sealed After adjustment.

**⚠ CAUTION**

Soot will be produced if the air shutter is closed too much. Any damage due to carboning resulting from improperly setting the air shutter is not covered under the warranty.

The following paragraphs address burner adjustment concerns and procedures.

When lit for the first time, this appliance will emit a slight odor for an hour or two. This is due to the “burn-in” of internal paints and lubricants used in the manufacturing process.

**Adjustment**

To adjust the flame, move the adjustment air shutter (located on the lower venturi) back or forward to increase or reduce the air shutter opening, respectively. **Position the air shutter to the factory setting as shown in Figure 15.** Allow the burner to operate for at least 15 minutes. Observe the flame continuously. If it appears weak or sooty as previously described, adjust the air shutter until the flame appearance is as desired.

Propane models may exhibit a flame pattern that may candle or appear stringy. If this is problematic or persists as the appliance is continually operated, adjust the air shutter open as described in the previous paragraphs. Operate the appliance for a period of time as the effect diminishes, ensuring that the appliance does not develop sooty flames.

When satisfied that the appliance operates properly, proceed to finish the installation. Leave the control knob in “ON” position and turn the remote switch “OFF.”

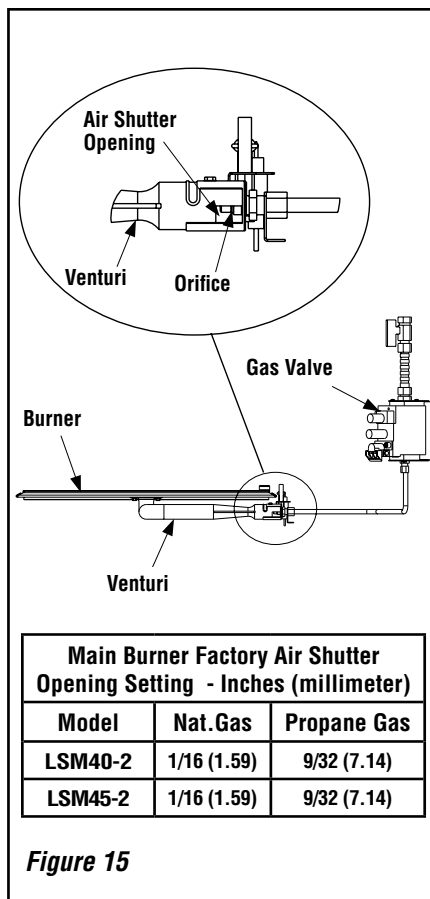

**Figure 15**

**Millivolt Appliance Checkout**

The pilot flame should be steady, not lifting or floating. Flame should be blue in color with traces of orange at the outer edge.

The top 3/8" (10 mm) at the pilot generator (thermopile) and the top 1/8" minimum (tip) of the quick drop out thermocouple should be engulfed in the pilot flame. The flame should project 1" (25 mm) beyond the hood at all three ports (see **Figure 16**).

To light the burner, refer to the lighting instructions on **Page 18**.

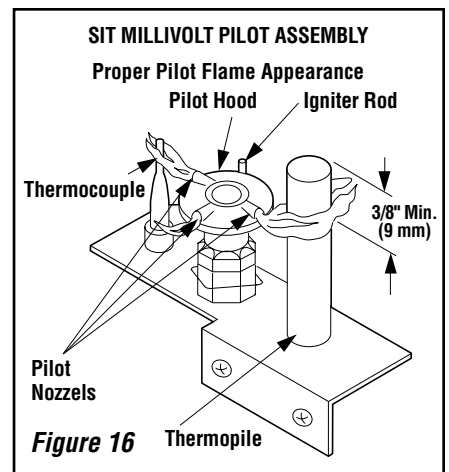

**Figure 16**

**Electronic Appliance Checkout**

To light the burner, refer to the lighting instructions on **Page 20**. Ensure the igniter lights the pilot. The pilot flame should engulf the flame sensor as shown in **Figure 17**.

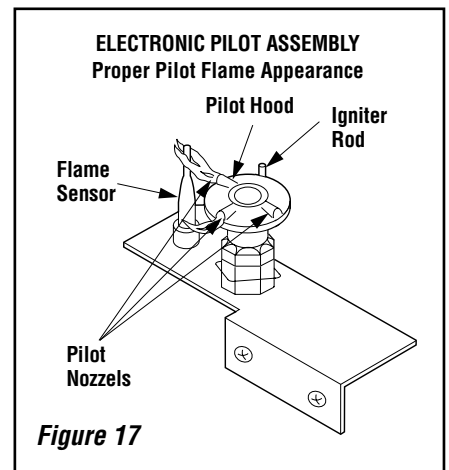

**Figure 17**

### ORDERING REPLACEMENT PARTS

A complete parts list is found at the end of this manual. Use only parts supplied from the manufacturer.

With proper care and maintenance, your appliance will provide many years of enjoyment. If you should experience any problem, first refer to the troubleshooting guide in this manual. If problem persists, contact your Lennox Hearth Products dealer or distributor.

Normally, all parts should be ordered through your Lennox Hearth Products distributor or dealer. Parts will be shipped at prevailing prices at time of order.

When ordering repair parts, always give the following information:

1. The model number of the appliance.
2. The serial number of the appliance.
3. The part number.
4. The description of the part.
5. The quantity required.
6. The installation date of the appliance.

If you encounter any problems or have any questions concerning the installation or application of this system, please contact your dealer or distributor.

**LENNOX HEARTH PRODUCTS**  
**1508 Elm Hill Pike, Suite 108**  
**Nashville, TN 37210**  
 visit us at [www.Lennox.com](http://www.Lennox.com)  
**1-800-9-LENNOX**

### PRODUCT REFERENCE INFORMATION

We recommend that you record the important reference information about your fireplace in the space provided below.

Please call Lennox Hearth Products for the phone number of your nearest Lennox Hearth Products dealer who will answer your questions or address your concerns.

Fireplace Model Number _____
Fireplace Serial Number _____
Date Installed _____
Type of Gas Used in Fireplace _____
Dealer Name _____

### WIRING DIAGRAMS

Wiring diagrams are provided here for reference purposes only. This information is also provided on schematics attached directly to the appliance on a pullout panel located within the control compartment.

**CAUTION: LABEL ALL WIRES PRIOR TO DISCONNECTION WHEN SERVICING CONTROLS. WIRING ERRORS CAN CAUSE IMPROPER AND DANGEROUS APPLIANCE OPERATION.**

**ATTENTION: AU MOMENT DE L'ENTRETIEN DES COMMANDES, ÉTIQUETEZ TOUS LES FILS AVANT DE LES DÉBRANCHER. DES ERREURS DE CÂBLAGE PEU-VENT ENTRAÎNER UN FONCTIONNEMENT INADÉQUAT ET DANGEREUX.**

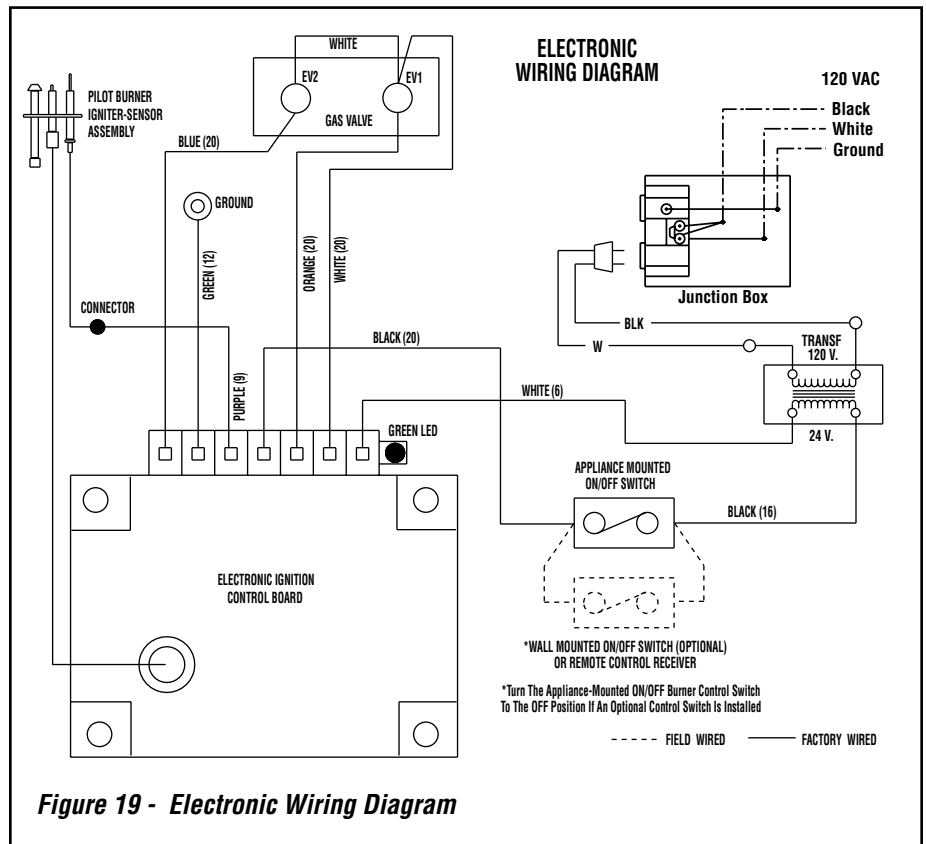
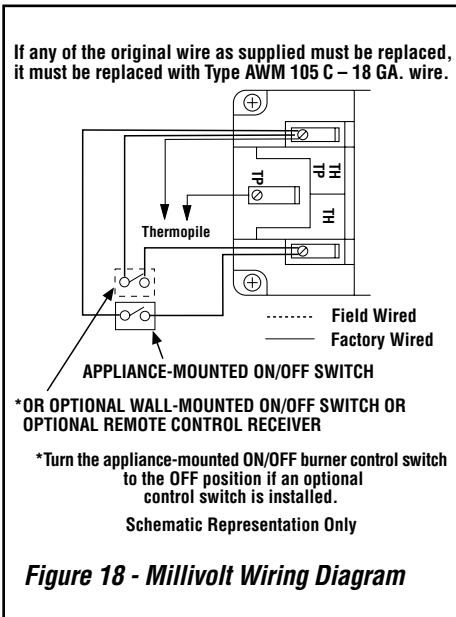

NOTE: DIAGRAMS & ILLUSTRATIONS ARE NOT TO SCALE.



Product Reference Information			
Cat. No.	Fireplace Model	Ship. Wt.	Ship. Volume
H4793	LSM40MN-2	261 lb.	45.8 cu. ft.
H4794	LSM40MP-2	268 lb.	45.8 cu. ft.
H4797	LSM40EN-2	307 lb.	57.1 cu. ft.
H4795	LSM45MN-2	307 lb.	57.1 cu. ft.
H4796	LSM45MP-2	307 lb.	57.1 cu. ft.
H4798	LSM45EN-2	307 lb.	57.1 cu. ft.

**ACCESSORY COMPONENTS**



**Digital Wall Thermostat**

The wall thermostat kit provides temperature control for optimum comfort.

Wall Thermostat, Millivolt		
Cat. No.	Model No.	Description
H4635	DWTK	Wall Thermostat Kit, White

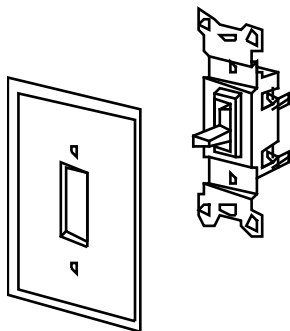

**ON/OFF Wall Switch Kit**

The ON/OFF wall switch kit may be used to control the operation of the fireplace burner as an alternative to the unit mounted ON/OFF switch. Install the ON/OFF wall switch in a convenient location near the fireplace.

ON/OFF Wall Switch Kit		
Cat. No.	Model	Description
85L87	FWSK	Wall Switch



**Standard Remote Control System**

The Model RCL (Standard) Remote Control System, features a simplistic OFF/ON control function for the fireplace. This model includes a hand-held transmitter, a remote receiver with wall-mount cover plate and all hardware required to install the unit. The remote receiver can be wall or hearth mounted.

The transmitter has ON and OFF functions that are activated by pressing either button on the face of the transmitter. When a button on the transmitter is pressed, a signal light illuminates briefly to verify that a signal has been sent.

The Model RCL is designed to operate with all millivolt ignition systems, as well as electronic ignition systems. It may be installed with use for either natural gas or propane gas appliances. The RCL offers ease of installation and allows you to execute on-off commands to the fireplace effortlessly with one simple motion.

The Model RCL comes complete with detailed operating instructions.

Remote Control Kit, Standard		
Cat. No.	Model No.	Description
H0249	RCL	Remote Control System (Standard)

(ref. Instruction P/N 750127M)



**Flame Modulating Remote Control**

Flame Modulating Remote Controls were developed to provide a safe, reliable and user-friendly remote control system for appliances equipped with a Millivolt Gas Valve. A detailed set of instructions are included with each remote.

Flame Modulating Remote Control Kits		
Cat. No.	Model No.	Description
H0301	RCL-MN	Natural Gas
H0302	RCL-ML	Propane Gas

(ref. Instruction P/N 750130M)

- Bag of Glowing Embers
- Bag of Volcanic Stone
- Bag of Vermiculite



Replacement ember material, volcanic stone and vermiculite are available for use with these appliances. Order them to replace materials as part of the periodic maintenance of the appliance.

Firebox Accessories		
Cat. No.	Model	Description
88L53	FGE	Bag of Glowing Embers
80L42	FDVS	Bag of Volcanic Stone
H6319	--	Bag of Vermiculite

(FDVS Instruction P/N 750010M)

**Touch-Up Paint Kit**

Repair of minor scratches and discoloration of the appliances black painted surfaces may be accomplished with the touch-up paint kit.



Touch-Up Paint (Black) Kit		
Cat. No.	Model	Description
90L73	FTP-K-B	Black Paint Kit

(ref. Instruction P/N 750050M)



## ACCESSORY COMPONENTS (continued)

### Brick Liner Kits

The brick panel liner kits include ceramic panels of the side and rear walls. The panels have brick-like features in relief.

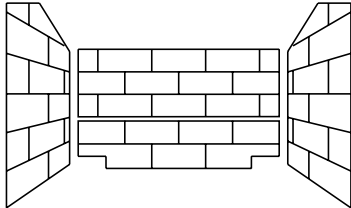

Brick Liner Kits		
LSM40-2		
H2219	BLKR-LSM40	Buff Rustic
H4801	BLK-REDR-LSM40	Red Rustic
H2220	BLKH-LSM40	Buff Herringbone
H4803	BLK-REDH-LSM40	Red Herringbone
H2221	BLKC-LSM40	Red Old Cottage
H2222	BLKB-LSM40	Black
LSM45-2		
H2223	BLKR-LSM45	Buff Rustic
H2224	BLKH-LSM45	Buff Herringbone
H2225	BLKC-LSM45	Red Old Cottage
H2226	BLKB-LSM45	Black
H4802	BLK-REDR-LSM45	Red Rustic
H4804	BLK-REDH-LSM45	Red Herringbone

(ref. Instruction P/N 750182M)

### Andiron Door Kits

The andiron kits attach to the grate assembly without the use of hardware.

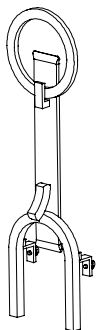

MISSION

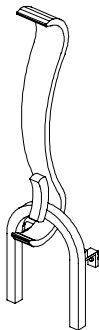

CLASSIC

Andiron Door Kits		
Fits Fireplace Models	Catalog No. (Model)	
	Mission	Classic
LSM40-2 & LSM45-2	H2227 (AKM-LSM)	H2228 (AKC-LSM)

(ref. Instruction P/N 750183M)

### Log Sets

Choose from two finely crafted log sets with detailing that replicates the natural look of real wood.



Birch Logs

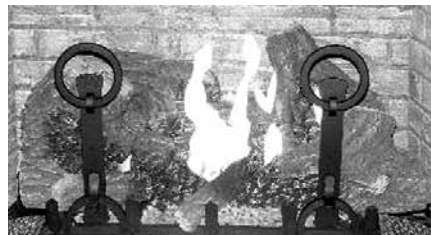

Rustic Oak

Log Sets		
Cat. No.	Model	Description
LSM40-2 and LSM45-2		
H4799	LOG-OAK-LSM-2	Oak Log Set
H4800	LOG-BIR-LSM-2	Birch Log Set

### Barrier Screen Kits

These Barrier Screen Panel kits can be installed on the glass enclosure panel to help prevent direct human contact with the hot glass surface.

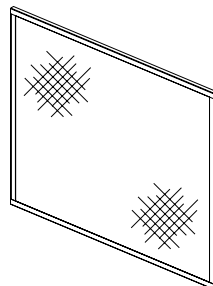

Barrier Screen Kits		
Cat. No.	Model	Description
LSM40-2		
H4805	BSK40	Barrier Screen
LSM45-2		
H4806	BSK45	Barrier Screen

(ref. Instruction P/N 750184M)

### Dual Arch Screen Kits

These Dual Arch screen kits can be installed on the glass enclosure panel to help prevent direct human contact with the hot glass surface.

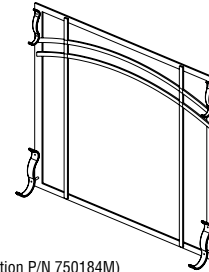

(ref. Instruction P/N 750184M)

Dual Arch Screen Kits		
Cat. #	Model	Description
H5051	DASK-LSM40-2	Dual Arch Screen
H5054	DASK-LSM45-2	Dual Arch Screen

### Arch Screen Kits

These Arch Screen kits can be installed on the glass enclosure panel to help prevent direct human contact with the hot glass surface.

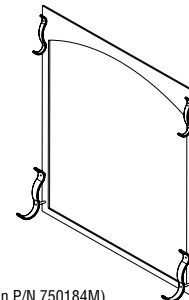

(ref. Instruction P/N 750184M)

Arch Screen Kits		
Cat. No.	Model	Description
H5053	ASK-LSM40-2	Arch Screen Kit
H5056	ASK-LSM45-2	Arch Screen Kit

### Classic Screen Kits

These Screen kits can be installed on the glass enclosure panel to help prevent direct human contact with the hot glass surface.

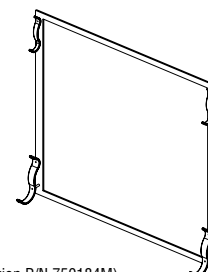

(ref. Instruction P/N 750184M)

Classic Screen Kits		
Cat. No.	Model	Description
H5052	SK-LSM40-2	Classic Screen Kit
H5055	SK-LSM45-2	Classic Screen Kit

NOTE: DIAGRAMS & ILLUSTRATIONS ARE NOT TO SCALE.





## LIGHTING INSTRUCTIONS – MILLIVOLT GAS VALVE

### FOR YOUR SAFETY READ BEFORE LIGHTING

**WARNING: IF YOU DO NOT FOLLOW THESE INSTRUCTIONS EXACTLY, A FIRE OR EXPLOSION MAY RESULT CAUSING PROPERTY DAMAGE, PERSONAL INJURY OR LOSS OF LIFE.**

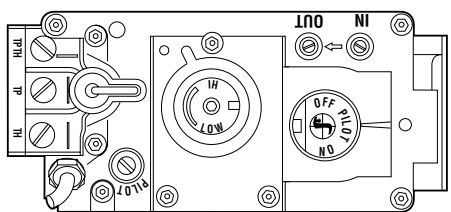
- A.** This appliance has a pilot which must be lighted with a piezo igniter. When lighting the pilot, follow these instructions exactly.
- B. BEFORE LIGHTING** smell all around the appliance area for gas. Be sure to smell next to the floor because some gas is heavier than air and will settle on the floor.
- WHAT TO DO IF YOU SMELL GAS**
- Do not try to light any appliance.
  - Do not touch any electric switch; do not use any phone in your building.
  - Immediately call your gas supplier from a neighbor's phone. Follow the gas supplier's instructions.
  - If you cannot reach your gas supplier, call the fire department.
- C.** Use only your hand to push in or turn the gas control knob. Never use tools. If the knob will not push in or turn by hand, do not try to repair it, call a qualified service technician. Force or attempted repair may result in a fire or an explosion.
- D.** Do not use this appliance if any part has been under water. Immediately call a qualified service technician to inspect the appliance and to replace any part of the control system and any gas control which has been under water.

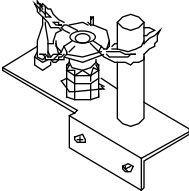
### LIGHTING INSTRUCTIONS

1. **STOP!** Read the safety information above on this Page.
  2. Set the thermostat to the lowest setting, if applicable.
  3. Turn off all electric power to the appliance, if applicable.
  4. Remove the control access panel.
  5. Push in gas control knob slightly and turn clockwise to "OFF." 
- 
- Note:** Knob cannot be turned from "PILOT" to "OFF" unless the knob is pushed in slightly. Do not force.
6. Wait five (5) minutes to clear out any gas. Then smell for gas, including near the floor. If you smell gas, STOP! Follow "B" in the safety information above (to the left) on this label. If you don't smell gas, go to the next step.
  7. Push in gas control knob slightly and turn counterclockwise to "PILOT." 
  8. Push in control knob all the way and hold in. Immediately light the pilot by triggering the spark igniter (pushing the button) until pilot lights. Continue to hold the control knob in for about 1-1/2 minutes after the pilot is lit. Release knob and it will pop back up. Pilot should remain lit. If it goes out, repeat steps 5 through 8.
- If knob does not pop up when released, stop and immediately call your service technician or gas supplier.
  - If pilot will not stay lit after several tries, turn the control knob to "OFF" and call your service technician or gas supplier.
- 
9. Turn gas control knob counterclockwise to "ON." 
  10. Close control access panel.
  11. If the appliance will not operate, follow the instructions "To Turn Off Gas To Appliance" and call your service technician or gas supplier.

### TO TURN OFF GAS TO APPLIANCE

1. Set the thermostat to the lowest setting.
2. Turn off all electric power to the appliance, if service is to be performed
3. Remove control access panel.
4. Depress gas control knob slightly and turn clockwise to "OFF." Do not force. 
5. Close control access panel.

NOTE: DIAGRAMS & ILLUSTRATIONS ARE NOT TO SCALE.

Download from Wwww.Somanuals.com. All Manuals Search And Download.

## INSTRUCTIONS D'ALLUMAGE – VANNE GAZ MILLIVOLT

### POUR PLUS DE SÉCURITÉ, LIRE AVANT D'ALLUMER

**AVERTISSEMENT. QUICONQUE NE RESPECTE PAS À LA LETTRE LES INSTRUCTIONS DANS LA PRÉSENTE NOTICE RISQUE DE DÉCLENCHER UN INCENDIE OU UNE EXPLOSION ENTRAÎNANT DES DOMMAGES, DES BLESSURES OU LA MORT.**

- A.** Cet appareil est muni d'une veilleuse qui doit être allumée avec un allumeur piézo-électrique. Lorsque vous allumez la veilleuse, suivre exactement ces instructions.
- B. AVANT L'ALLUMAGE:** Avant d'allumer la veilleuse, reniflez tout autour de l'appareil pour déceler une odeur de gaz. Reniflez près du plancher, car certains gaz sont plus lourds que l'air et peuvent s'accumuler au niveau du sol.
- QUE FAIRE SI VOUS SENTEZ UNE ODEUR DE GAZ :**
- Ne pas tenter d'allumer d'appareil.
  - Ne touchez à aucun interrupteur ; ne pas vous servir des téléphones se trouvant dans le bâtiment.
  - Appelez immédiatement votre fournisseur de gaz depuis un voisin. Suivez les instructions du fournisseur.
  - Si vous ne pouvez rejoindre le fournisseur, appelez le service des incendies.
- C.** Ne pousser ou tourner la manette d'admission du gaz qu'à la main. Ne jamais employer d'outil à cette fin. Si la manette reste coincée, ne tentez pas de la réparer; appelez un technicien qualifié. Quiconque tente de forcer la manette ou de la réparer peut provoquer une explosion ou un incendie.
- D.** N'utilisez pas cet appareil s'il a été plongé dans l'eau, même partiellement. Faites inspecter l'appareil par un technicien qualifié et remplacez toute partie du système de contrôle et toute commande qui ont été plongés dans l'eau.

### INSTRUCTIONS D'ALLUMAGE

- 1. ARRÊTEZ !** Lisez les instructions de sécurité sur la portion supérieure de cette étiquette.
- Ouvrez le compartiment de contrôle du bas.
- Tournez l'interrupteur mural à la position d'arrêt "OFF".
- Assurez-vous que la soupape d'arrêt de la canalisation principale est ouverte.
- Enfoncez légèrement le bouton de réglage du gaz et tournez-le dans le sens des aiguilles d'une montre  jusqu'à la position d'arrêt "OFF".

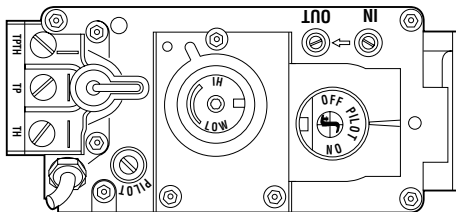

**Remarque:** Il est impossible de tourner le bouton de "PILOT" à "OFF" à moins qu'il ne soit légèrement enfoncé. Ne le forcez pas.

- Attendre cinq (5) minutes pour laisser échapper tout le gaz. Reniflez tout autour de l'appareil, y compris près du plancher, pour déceler une odeur de gaz. Si vous sentez une odeur de gaz, ARRÊTEZ ! Passez à l'étape B des instructions de sécurité sur la portion supérieure (à gauche) de cette étiquette. S'il n'y a pas d'odeur de gaz, passez à l'étape suivante.
- Enfoncez légèrement le bouton de réglage du gaz et tournez-le en sens inverse des aiguilles d'une montre jusqu'à la position de veilleuse  "PILOT".

- Enfoncez le bouton de réglage jusqu'au fond et gardez-le enfoncé. Allumez immédiatement la veilleuse en déclenchant l'allume-gaz à étincelle (en poussant le bouton) jusqu'à ce que la veilleuse s'enflamme. Continuez de tenir le bouton de réglage enfoncé pendant environ 90 secondes après l'allumage de la veilleuse. Relâchez le bouton et il sortira subitement. La veilleuse devrait rester allumée. Si elle s'éteint, répétez les étapes 5 à 8 inclusivement.

- Si le bouton ne sort pas automatiquement après avoir été relâché, arrêtez immédiatement et téléphonez à votre technicien de service ou à votre fournisseur de gaz.

- Si la veilleuse refuse de rester allumée après plusieurs tentatives, tournez le bouton de réglage jusqu'à sa position d'arrêt "OFF" et téléphonez à votre technicien de service ou à votre fournisseur de gaz.

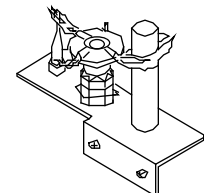

- Tournez le bouton de réglage du gaz en sens inverse des aiguilles d'une montre  jusqu'à sa position de marche "ON".

- Fermez le compartiment de contrôle du bas.

- Si l'appareil ne fonctionne pas, suivre les instructions intitulées "Pour fermer le gaz qui alimente l'appareil" et appeler un technicien ou le fournisseur de gaz.

### POUR FERMER LE GAZ QUI ALIMENTE L'APPAREIL

- Tournez l'interrupteur mural à la position d'arrêt "OFF". La veilleuse restera allumée jusqu'au retour du service normal.
- Pour une fermeture complète, tournez l'interrupteur mural à la position d'arrêt "OFF".
- Ouvrez le compartiment de contrôle du bas.
- Enfoncez légèrement le bouton de réglage du gaz et tournez-le dans le sens des aiguilles d'une montre  jusqu'à la position d'arrêt "OFF". Ne forcez pas le bouton.
- Fermez le compartiment de contrôle du bas.

REMARQUE : LES SCHÉMAS ET LES ILLUSTRATIONS NE SONT PAS À L'ÉCHELLE

## OPERATING INSTRUCTIONS — ELECTRONIC

### FOR YOUR SAFETY READ BEFORE OPERATING

**WARNING: IF YOU DO NOT FOLLOW THESE INSTRUCTIONS EXACTLY, A FIRE OR EXPLOSION MAY RESULT CAUSING PROPERTY DAMAGE, PERSONAL INJURY OR LOSS OF LIFE.**

- A.** This appliance is equipped with an ignition device which automatically lights the pilot. Do not try to light the pilot by hand.
- B. BEFORE OPERATING** smell all around the appliance area for gas. Be sure to smell next to the floor because some gas is heavier than air and will settle on the floor.
- WHAT TO DO IF YOU SMELL GAS**
- Do not try to light any appliance.
  - Do not touch any electric switch; do not use any phone in your building.
  - Immediately call your gas supplier from a neighbor's phone. Follow the gas supplier's instructions.
  - If you cannot reach your gas supplier, call the fire department.
- C.** If any portion of this appliance does not operate as the instructions indicate, do not try to repair it, call a qualified service technician. Do not use tools. Force or attempted repair may result in a fire or explosion.
- D.** Do not use this appliance if any part has been under water. Immediately call a qualified service technician to inspect the appliance and to replace any part of the control system and any gas control which has been under water.

### OPERATING INSTRUCTIONS

1. **STOP!** Read the safety information above on this Page.
2. Turn remote wall switch to "OFF" or set the thermostat to lowest setting, if applicable.
3. Turn the ON/OFF switch to "OFF" if Step 2 is applicable, this ON/OFF switch should always be in the "OFF" position.
4. Verify main line shut-off valve is open.
5. This appliance is equipped with an ignition device which automatically lights the burner. Do Not try to light the burner by hand.
6. Wait five (5) minutes to clear out any gas. Then smell for gas, including near the floor. If you smell gas, STOP! Follow "B" in the safety information above (to the left) on this label. If you don't smell gas, go to the next step.
7. Turn "ON" all electrical power to appliance (remote wall switch), or set the thermostat to the desired setting, if applicable.
8. Turn the ON/OFF switch on the appliance to "ON", if Step 7 is not applicable.
9. If the appliance will not operate, follow the instructions "To Turn Off Gas To Appliance" and call your service technician or gas supplier.

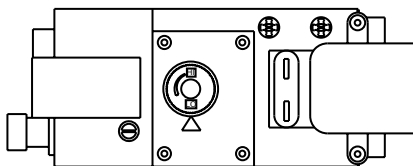

Gas Valve

#### TO SHUT OFF

1. Turn off all electrical power to the appliance (remote wall switch) or set the thermostat to the lowest setting, if applicable.
2. Turn the ON/OFF switch to "OFF", if Step 1 is not applicable.
3. Close the main line shut-off valve.

#### TO TURN OFF GAS TO APPLIANCE

1. For complete shut-down, turn remote wall switch to "OFF" or set the thermostat to the lowest setting, if applicable.
2. Turn the ON/OFF switch to "OFF", if Step 1 is not applicable.
3. Close the main line shut-off valve.

## INSTRUCTIONS D'ALLUMAGE — ELECTRONIC

## POUR PLUS DE SÉCURITÉ LIRE AVANT DE METTRE EN MARCHÉ

**AVERTISSEMENT: SI VOUS NE SUIVEZ PAS CES INSTRUCTIONS À LA LETTRE, IL POURRAIT S'EN SUIVRE UN INCENDIE OU UNE EXPLOSION CAUSANT DES DOMMAGES MATÉRIELS, DES BLESSURES CORPORELLES OU MÊME DES PERTES DE VIE.**

- A.** Cet appareil est muni d'un dispositif d'allumage qui allume automatiquement la veilleuse. Ne tentez pas d'allumer la veilleuse manuellement.
- B. AVANT DE FAIRE FONCTIONNER:** reniflez tout autour de l'appareil pour déceler une odeur de gaz. Reniflez près du plancher, car certains gaz sont plus lourds que l'air et peuvent s'accumuler au niveau du sol.
- QUE FAIRE SI VOUS SENTEZ UNE ODEUR DE GAZ :**
- Ne pas tenter d'allumer d'appareil.
  - Ne touchez à aucun interrupteur; ne pas vous servir des téléphones se trouvant dans le bâtiment.
  - Appelez immédiatement votre fournisseur de gaz depuis un voisin. Suivez les instructions du fournisseur.
  - Si vous ne pouvez rejoindre le fournisseur, appelez le service des incendies.
- C.** Si un élément de cette unité ne fonctionne pas tel que décrit dans les instructions, n'essayez pas de le réparer, appelez un technicien qualifié. N'utilisez pas d'outils. Le fait de forcer la manette ou de la réparer peut déclencher une explosion ou un incendie.
- D.** N'utilisez pas cet appareil s'il a été plongé dans l'eau, même partiellement. Faites inspecter l'appareil par un technicien qualifié et remplacez toute partie du système de contrôle et toute commande qui ont été plongés dans l'eau.

## INSTRUCTIONS DE MISE EN MARCHÉ

- 1. ARRÊTEZ !** Lisez les instructions de sécurité sur la portion supérieure (à gauche) de cette étiquette.
- 2.** Tournez l'interrupteur mural à la position d'arrêt "OFF" ou placez le thermostat à plissible, si requis.
- 3.** Tournez l'interrupteur "marche/arrêt" à la position "arrêt" (Off) si l'étape 2 est appropriée. Cet interrupteur "marche/arrêt" devrait toujours être en position "arrêt" (Off).
- 4.** Assurez-vous que la soupape d "arrêt" de la canalisation principale est ouverte.
- 5.** Cet appareil est équipé d'un dispositif d'allumage qui allume automatiquement le brûleur. N'essayez pas d'allumer le brûleur à la main.
- 6.** Attendez cinq (5) minutes pour laisser échapper tout le gaz. Reniflez tout autour de l'appareil, y compris près du plancher, pour déceler une odeur de gaz. Si vous sentez une odeur de gaz, ARRÊTEZ ! Passez à l'étape B des instructions de sécurité sur la portion supérieure (à gauche) de cette étiquette. S'il n'y a pas d'odeur de gaz, passez à l'étape suivante.
- 7.** Tournez l'interrupteur mural à distance à la position "marche" (On) ou placez le thermostat à la température désarmée, si requis.
- 8.** Tournez l'interrupteur "marche/arrêt" de l'appareil à la position "marche" (On), si aucune odeur de gaz n'a été détectée à l'étape 6.
- 9.** Si l'appareil ne se met pas en marche, suivre les instructions intitulées "Pour fermer le gaz qui alimente l'appareil" et appeler un technicien ou le fournisseur de gaz.

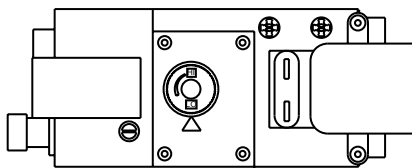

Vue De Face

## POUR ÉTEINDRE L'APPAREIL

- 1.** Coupez tout le courant électrique qui alimente l'appareil (interrupteur mural) ou placez le thermostat à la plus basse température, si requis.

## COMMENT COUPER L'ADMISSION DE GAZ DE L'APPAREIL

- 1.** Pour une fermeture complète, tournez l'interrupteur mural à la position d'arrêt "OFF".
- 2.** Tournez la manette de réglage du gaz à la position d'arrêt "OFF". Ne la forcez pas.
- 3.** Fermez la soupape d'arrêt de la canalisation principale.

REMARQUE : LES SCHÉMAS ET LES ILLUSTRATIONS NE SONT PAS À L'ÉCHELLE

## MAINTENANCE SCHEDULE

Turn off gas and electrical power to the fireplace and allow it to cool before cleaning or servicing the appliance.

### Annually (Before the onset of the Burning Season)

MAINTENANCE TASK	ACCOMPLISHING PERSON	PROCEDURE
Inspect/Clean Burner, Logs and Controls	Qualified Service Technician	Inspect valve and ensure it is properly operating. Check piping for leaks. Vacuum the control compartment, fireplace logs and burner area.
Check Flame Patterns and Flame Height	Qualified Service Technician	Refer to <b>Figure 13 (LSM40-2) or Figure 14 (LSM45-2) on Page 13</b> and verify the flame pattern and height displayed by the appliance conforms to the picture. Flames must not impinge on the logs. Ensure flames are steady (not lifting or floating).
Inspect/Clean Pilot and Burner	Qualified Service Technician	Refer to <b>Figure 16 (Millivolt) or Figure 17 (Electronic) on Page 14</b> . Remove any surface build-up on pilot and burner assembly. Wipe the pilot nozzles, igniter/flame rod and hood. Ensure the pilot flame engulfs the flame sensor as shown.
Check Vent System	Qualified Service Technician	Inspect the vent system at the top and at the base (within the firebox) for signs of blockage or obstruction. Look for any signs of dislocation or deterioration of the vent components. <b>Note:</b> Excessive condensation can cause corrosion of caps, pipe & fittings (excessive condensation can be caused by long lateral runs, too many elbows and/or exterior portions of the system being exposed to cold weather). Also inspect wall straps or plumbers's tape to ensure it is secure and in place.
Appliance Checkout	Qualified Service Technician	Perform the appropriate appliance checkout procedure detailed in this manual.
Replace Glowing Embers	Homeowner/Qualified Service Technician	Remove old ember materials (rockwool) and vacuum the ember placement area. Place new embers per instructions on <b>Page 11</b> .

### Periodically (After the Burning Season)

MAINTENANCE TASK	ACCOMPLISHING PERSON	PROCEDURE
Clean Firebox Interior	Homeowner	Carefully remove logs, rockwool, volcanic stone and vermiculite. Vacuum out interior of the firebox. Clean firebox walls and log grate. Replace logs, rockwool, vermiculite and volcanic stone as detailed in this manual.
Check Flame Patterns and Flame Height	Homeowner	Refer to <b>Figures 13 and 14 on Page 13</b> and verify the flame pattern and height displayed by the appliance conforms to the picture. Flames must not impinge on the logs.
Check Vent System	Homeowner	Inspect the vent system at the top and at the base (within the firebox) for signs of blockage or obstruction. Look for any signs of dislocation of the vent components.
Clean Front Glass Enclosure Panel	Homeowner	Clean as necessary following the directions provided in this manual. <b>DO NOT TOUCH OR ATTEMPT TO CLEAN GLASS WHILE HOT.</b>

## TROUBLESHOOTING GUIDE - MILLIVOLT GAS CONTROL SYSTEM

**Note:** Before troubleshooting the gas control system, make sure the external gas shut off valve, located at gas supply inlet, (and wall switch, if applicable), is in the “ON” position.

**Important:** Valve system troubleshooting should only be accomplished by a qualified service technician.

SYMPTOM	POSSIBLE CAUSES	CORRECTIVE ACTION
<p>1. Spark igniter will not light pilot after repeated triggering of igniter button.</p> <p><b>WARNING: if the pilot will not light after 1 minute of attempting, wait for at least 5 minutes for gas to clear before attempting again.</b></p>	<p><b>A.</b> Defective igniter (no spark at electrode).</p>	<p>Check for spark at electrode and pilot; if no spark and electrode wire is properly connected, replace igniter.</p>
	<p><b>B.</b> Defective or misaligned electrode at pilot (spark at electrode).</p>	<p>Using a match, light pilot. If pilot lights, turn off pilot and trigger the igniter button again. If pilot lights, an improper gas mixture caused the bad lighting and a longer purge period is recommended. If pilot will not light – check gap at electrode and pilot – should be 1/8" to have a strong spark. If gap measures 1/8", replace pilot (see <b>Figures 16 or 17 on Page 14</b>).</p>
	<p><b>C.</b> Gas supply pressure errant.</p>	<p>Check inlet gas pressure. It should be within the limits as marked on the rating plate.</p>
	<p><b>D.</b> Pilot orifice plugged.</p>	<p>Clean or replace pilot orifice.</p>
<p>2. Pilot will not stay lit after carefully following the lighting instructions.</p>	<p><b>A.</b> Defective pilot generator (thermocouple)</p>	<p>Check pilot flame, it must impinge on thermocouple (see <b>Figures 16 or 17 on Page 14</b>). Clean and/or adjust pilot for maximum flame impingement on thermocouple. Ensure that the connection between the valve and thermocouple are tight and secure.</p>
<p>3. Pilot burning, no gas to burner, Valve knob “ON,” and the (standard) burner OFF/ON switch is “ON.” Read important note below.</p> <p><b>IMPORTANT NOTE: If an optional *remote switch is used for burner operation, if the standard burner OFF/ON switch is still installed on appliance it must be in the "OFF" position.</b></p> <p><b>* Optional remote switch kits - wall switch, wall thermostat or remote control.</b></p>	<p><b>A.</b> Wall switch or wires defective.</p>	<p>Check wall switch and wires for proper connections. Jumper wire across terminals at wall switch, if burner comes on, replace defective wall switch. If okay, jumper wires across wall switch wires at valve, if burner comes on, wires are faulty or connections are bad.</p>
	<p><b>B.</b> Thermopile may not be generating sufficient millivolts.</p>	<p>Check thermopile with millivolt meter. Take reading at thermopile terminals of gas valve. Should read 325 millivolts minimum with optional wall switch “OFF.” Replace faulty thermopile if reading is below specified minimum.</p>
	<p><b>C.</b> Plugged burner orifice.</p>	<p>Check burner orifice for blockage and remove.</p>
	<p><b>D.</b> OFF/ON Switch &amp; *Remote Switch are in the "ON" position resulting in excessive resistance.</p>	<p>When turning on the burner using a *remote switch, ensure that the standard OFF/ON switch is in the "OFF" position. If both switches are in the ON position, it may result in excessive resistance (&amp; millivolt drainage) and the burner may not come on.</p>
<p>4. Frequent pilot/burner outage problem.</p>	<p><b>A.</b> Pilot flame may be too low or blowing (high) causing the pilot/valve safety to drop out.</p>	<p>Clean and/or adjust pilot flame for maximum flame impingement on thermocouple (see <b>Figures 16 or 17 on Page 14</b>).</p>

## TROUBLESHOOTING GUIDE - ELECTRONIC GAS CONTROL SYSTEM

**Note:** Before troubleshooting the gas control system, make sure the external gas shut off valve, located at gas supply inlet, (and wall switch, if applicable), is in the “ON” position.

**Important:** Valve system troubleshooting should only be accomplished by a qualified service technician.

SYMPTOM	POSSIBLE CAUSES	CORRECTIVE ACTION
1. Nothing happens when ON/OFF switch is turned on (pilot does not spark).	A. Low voltage/or bad lead wires.	Check voltage on AC terminals of module. The value should be around 24 VAC. Confirm that wire connections are secure.
	B. Damaged igniter wire.	Check for visible cracked casing, cuts, etc.
	C. Damaged pilot assembly.	Check pilot assembly for visibly broken spark electrode, etc.
	D. Batteries Low	Check voltage on D.C. terminal of batteries in remote control. The value should be around 3.0V
2. The main burner does not light and the igniter is sparking.	A. No fuel supply.	Ensure that the gas supply is turned on.
	B. Loose sensor wire.	Ensure sensor wire connection is secure to purple wire of ignition control.
	C. Loose wires to valve.	Ensure blue and white (2) wires connection is secure to valve.
	D. Air in the gas line.	Purge gas line of air.
	E. Low voltage.	Test voltage at AC terminals of module for 24 VAC. If no voltage, replace module.  Check electrical connections between module and gas control. If okay, replace gas control (valve).
3. The main burner come "ON" but then go "OFF".	A. Gas supply is turned "OFF".	Turned gas supply to "ON".
	B. Loose wire connection on valve or ignition module.	Check wire connection.
	C. Flame does not engulf flame sensor.	Check location of sensor.
	D. Obstructed vent system.	Check vent system for obstructions.
4. The log and glass soot.	A. Flame impingement on the log.	Check for proper log placement.
	B. Improper air shutter opening.	Check for proper air shutter openings.



## REPLACEMENT PARTS LIST

Item No.	Description	LSM40-2		LSM45-2	
		Cat. No.	Qty.	Cat. No.	Qty.
1	Brick Liner Kit (a) - Buff Rustic	H2219	1	H2223	1
	Brick Liner Kit (b) - Red Rustic	H4801	1	H4802	1
	Brick Liner Kit (c) - Buff Herringbone	H2220	1	H2224	1
	Brick Liner Kit (d) - Red Herringbone	H4803	1	H4804	1
	Brick Liner Kit (e) - Red Old Cottage	H2221	1	H2225	1
	Brick Liner Kit (f) - Black	H2222	1	H2226	1
2	Door Modesty Shield	H4808	1	H4809	1
3	Log Set (Oak)	H4799	1	H4799	1
3	Log Set (Birch)	H4800	1	H4800	1
4	Enclosure, Glass Door	H2281	1	H2282	1
5	Spring Latch Assembly	H2274	2	H2274	2
6	Burner Assembly	H4817	1	H4817	1
7	Venturi	H1428	1	H1428	1
8	Gasket - Venturi	43K85	1	43K85	1
9	Access Plate	H2277	1	H2277	1
10	Screen Rod	H2278	1	H2279	1
11	Screen	H1427	2	H1169	2
12	Gasket, Access Plate	H1452	1	H1452	1
13	Gas Line Tubing	H2283	1	H2284	1
14	Connector, Male	H2285	1	H2285	1
15	Orifice, Natural Gas	H2286	1	H2288	1
15	Orifice, Propane Gas	H2287	1	H4816	1
16	Bag of Rockwool	88L53	1	88L53	1
17	Grate Assembly	H4907	1	H4907	1
18	On/Off Control Switch	80L41	1	80L41	1
19	Gas Line, Flexible Connection	93L32	1	93L32	1
20	Modesty Panel, Right Side	H3371	1	H3372	1
21	Modesty Panel, Left Side	H3373	1	H3374	1
22	Floor Panel	H3369	1	H3370	1
23	Bag of Volcanic Stone (lava rock)	80L42	1	80L42	2
24	Bag of Vermiculite	H3696	1	H3696	1
25	Barrier Screen Panel	H4805	1	H4806	1

Contact an Authorized Lennox Hearth Products dealer to obtain any of these parts. Never use substitute materials. Use of non-approved parts can result in poor performance and safety hazards.

Gas Controls - SIT Millivolt					
Item No.	Description	Natural		Propane	
		Cat. No.	Qty.	Cat. No.	Qty.
30	Gas Valve, SIT, Millivolt	43K07	1	88J53	1
31	Piezo Igniter	10K86	1	10K86	1
32	Pilot Assembly	H2291	1	H2292	1
33	Pilot Generator	H2294	1	H2294	1
34	Thermocouple	H2295	1	H2295	1
35	Pilot Tube	H2296	1	H2296	1
36	Electrode and Cable	H2297	1	H2297	1

Gas Controls - SIT Electronic					
Item No.	Description	Natural Gas		Propane Gas	
		Part No.	Qty.	Part No.	Qty.
**	Gas Train Assembly Electronic LSM40EN	H4190	1	See Note ①	1
**	Gas Train Assembly Electronic LSM45EN	H4193	1	See Note ①	1
40	Gas Valve, SIT	99K88	1	99K89	1
41	Pilot Assembly	H2298	1	See Note ②	1
42	Transformer	42J32	1	42J32	1
43	Ignition Module (with wire harness)	H1167	1	H1167	1

① If a propane gas train assembly is needed, order catalog number H4190 (for model LSM40-2) or H4193 (for model LSM45-2), NG gas train assembly as well as conversion kit, cat. no. H3238 (for model LSM40-2) or H4813 (for model LSM45-2)

② If a propane gas pilot assembly is needed, order H2298 (NG pilot assembly) as well as conversion kit, cat. no. H3238 (for model LSM40-2) or H4813 (for model LSM45-2)

### WARNING

Failure to position the parts in accordance with these diagrams or failure to use only parts specifically approved with this appliance may result in property damage or personal injury.

### AVERTISSEMENT

Risque de dommages ou de blessures si les pièces ne sont pas installées conformément à ces schémas et ou si des pièces autres que celles spécifiquement approuvées avec cet appareil sont utilisées.

## REPLACEMENT PARTS

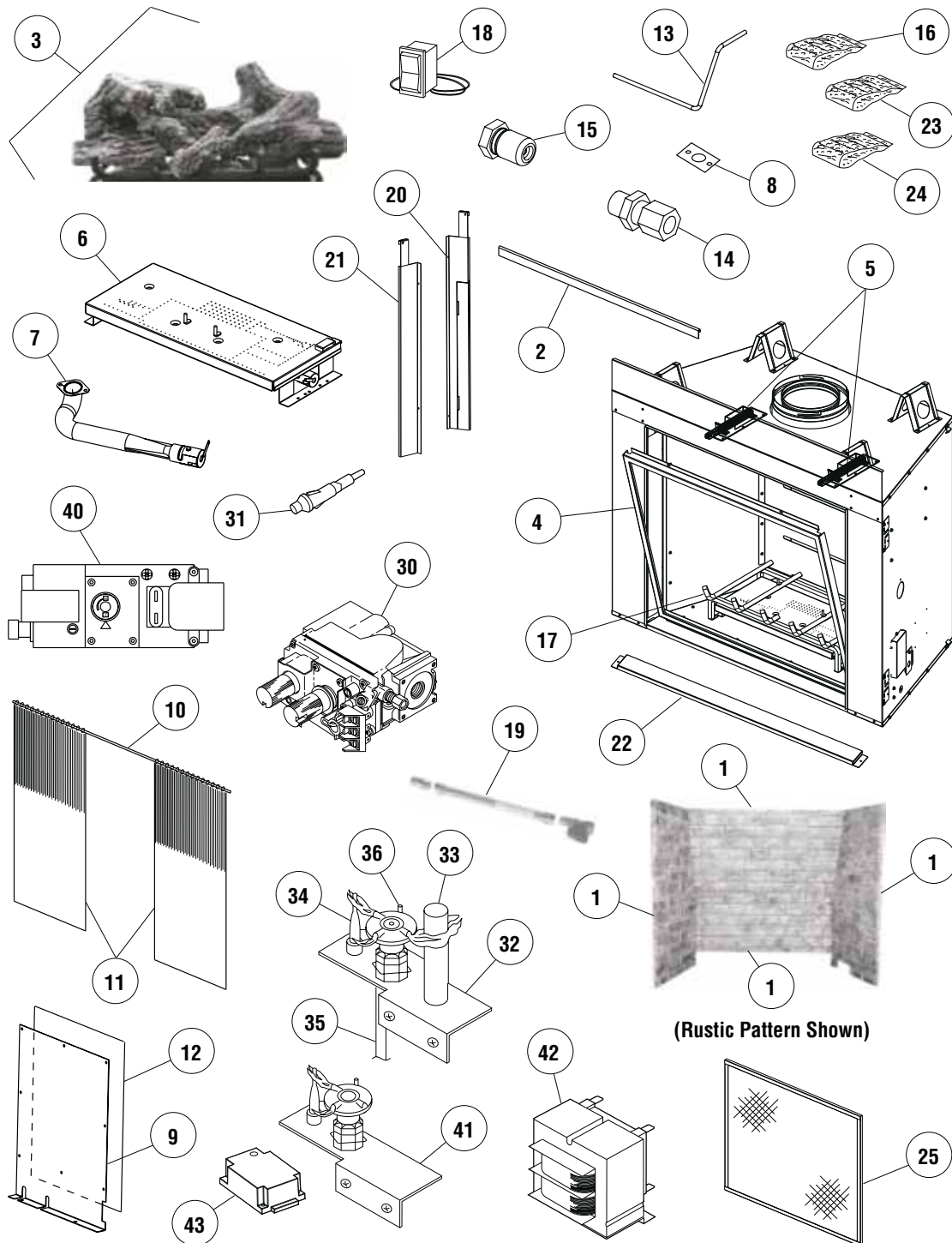

## NOTES

---

Lennox Hearth Products reserves the right to make changes at any time, without notice, in design, materials, specifications, prices and also to discontinue colors, styles and products. Consult your local distributor for fireplace code information.



Printed in U.S.A. © 2005/2011 Lennox Hearth Products

**P/N 875027M Rev. H 06/2011**

**1508 Elm Hill Pike, Suite 108 • Nashville, TN 37210**

## Free Manuals Download Website

<http://myh66.com>

<http://usermanuals.us>

<http://www.somanuals.com>

<http://www.4manuals.cc>

<http://www.manual-lib.com>

<http://www.404manual.com>

<http://www.luxmanual.com>

<http://aubethermostatmanual.com>

Golf course search by state

<http://golfingnear.com>

Email search by domain

<http://emailbydomain.com>

Auto manuals search

<http://auto.somanuals.com>

TV manuals search

<http://tv.somanuals.com>