

---

# KODAK EASYSHARE P76 Digital Frame



## Extended user guide

[www.kodak.com](http://www.kodak.com)

For help with your digital frame, [www.kodak.com/go/digitalframesupport](http://www.kodak.com/go/digitalframesupport)

---

# Kodak

Eastman Kodak Company  
Rochester, New York 14650  
© Kodak, 2011

All screen images are simulated.

Kodak and EasyShare are trademarks of Eastman Kodak Company.

SD logo is a trademark used under license by Kodak.

P/N 4H8542\_en

## Frame features

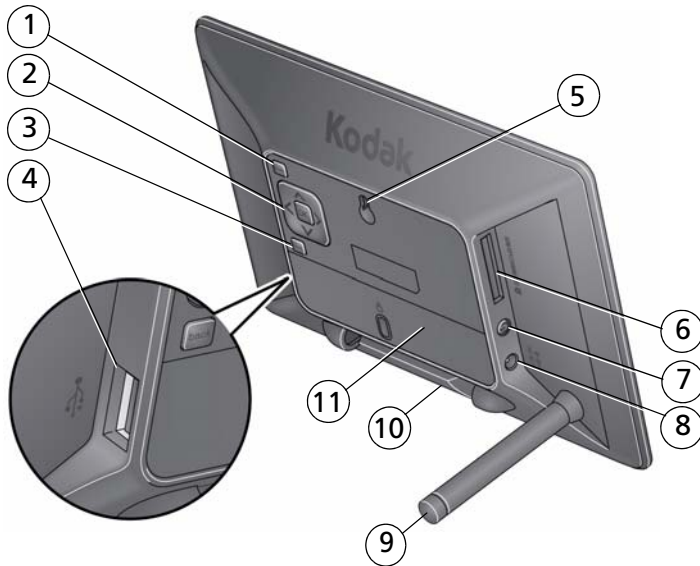

1 Mode button

2 OK/4-way navigation

3 Back button

4 USB high-speed host—connect to  
USB flash drive or card reader

5 Wall mount hole

6 Memory card slot - SD/MMC/xD/MS

7 Power button 

8 Power cable, DC-In 5V 

9 Stand

10 Stand storage

11 Data plate with serial number

## Main control panel—icons

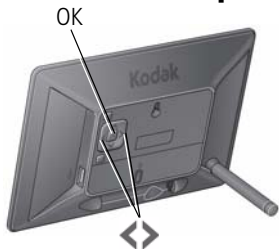

- Press **OK** (on back) to display the main control panel.
- Press **◀▶** to highlight an icon, then press **OK** to select it.



Main control panel.

Icon	Description
	<b>Play</b> —start playing a slide show.
	<b>Pause</b> —resume a paused slide show (see page 18).
	<b>Pictures</b> —find your pictures by: all, date, folders, keywords, people, favorites (see page 11). The Pictures icon changes to indicate your current picture source:  internal memory,  memory card,  USB flash drive or device.
	<b>Copy</b> —copy pictures to the frame, appears when a memory card or USB device is inserted (see page 8).
	<b>Delete</b> —delete pictures from the frame, appears when no memory card or USB device is inserted (see page 18).
	<b>Picture Finder</b> —play similar pictures, those taken on the same day as the picture on the screen (see page 17).
	<b>Transitions</b> —choose a transition style between pictures, and how long each picture is displayed (see page 24).
	<b>Set Modes</b> —choose your favorite style for collage, clock, and calendar modes. Then play pictures in these modes by pressing the <b>mode</b> button on the back of the frame (see page 25).
	<b>Settings</b> —change your frame settings (see page 19).

---

# Table of contents

<b>1 Getting started</b> .....	<b>1</b>
Attaching the stand.....	1
Storing the stand .....	1
Attaching the power cable .....	2
Navigation buttons .....	3
Setting your language .....	4
Setting the time, date, and on/off times.....	5
Turning your frame on and off .....	5
Inserting a memory card.....	6
Inserting a USB device.....	7
Copying pictures to your frame .....	8
<b>2 Viewing pictures</b> .....	<b>10</b>
Viewing from internal memory.....	10
Viewing from a memory card or USB device.....	10
Searching for and viewing your pictures.....	11
Changing viewing modes .....	16
Picture Finder—auto-play similar pictures.....	17
Pausing play on a single picture.....	18
Deleting pictures from your frame.....	18
<b>3 Changing settings and more</b> .....	<b>19</b>
Changing frame settings .....	19
Settings .....	20
Setting the time, date, and on/off times.....	22
Setting transitions between pictures .....	24
Setting viewing modes .....	25
Upgrading your firmware (recommended).....	26
Changing your frame orientation .....	27
Hanging your frame on the wall .....	27

Maintaining your frame .....	28
Learning more about your frame.....	28
<b>4 Troubleshooting and support .....</b>	<b>29</b>
Picture frame problems .....	29
Screen messages.....	30
Re-setting your frame after losing power .....	31
<b>5 Appendix .....</b>	<b>32</b>
Digital frame specifications.....	32
Important safety instructions .....	33
Additional care and maintenance .....	33
Limited warranty.....	34
Regulatory compliance and advisory .....	36

# 1

## Getting started

Welcome to your KODAK EASYSHARE Digital Frame. Viewing and sharing your pictures couldn't be simpler!

### Attaching the stand

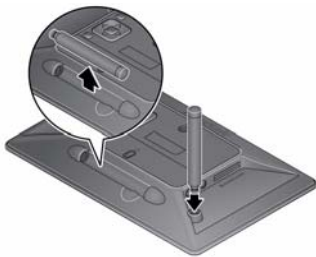

#### Attach the stand

Push the notched end of the stand into the back of the frame until it snaps into place.



When displayed with the stand extended, the frame rests at a 75° angle.

### Storing the stand

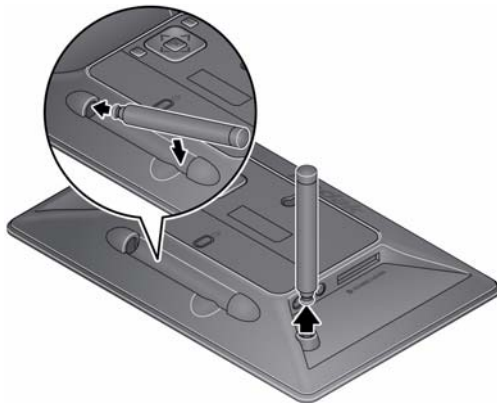

#### Remove the stand

Pull the stand to remove it from the back of the frame.

#### Store the stand

Snap the stand into the holder.

## Attaching the power cable



**CAUTION:**

**Do not use this power cable with other devices, including digital cameras.**



- The frame automatically turns on when you plug it in for the first time.
- If the frame loses power or you unplug it for more than a minute, you are prompted to reset the time and date when power is restored or when you plug it back in.



## Navigation buttons

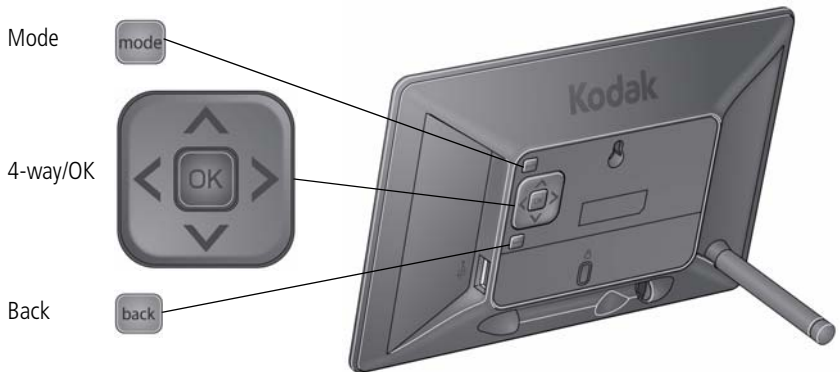

### Buttons Press to:



Navigate left or view the previous picture



Navigate right or view the next picture



Navigate up or highlight the previous screen item



Navigate down or highlight the next screen item



Select or accept the highlighted screen item



Cycle through the available viewing modes



Return to the previous screen





## Setting your language

The language screen appears the first time you turn on your frame.



- Press  to highlight your language, then press **OK**.

To change the language at a later time:



- 1 Press **OK** to pause a slideshow and display the control panel icons.
- 2 Press  to highlight  (Settings), then press **OK**.
- 3 Press  to highlight **Language**, then press **OK**.
- 4 Press  to highlight your language, then press **OK**.

## Setting the time, date, and on/off times

The first time you turn on your frame, the Time, Date, and On/Off screens appear automatically after you select your language.



To set the current date and time:

- Press  to change values.
- Press  to move to the next entry.
- When you've entered all the settings, press **OK**.

For details on setting the 12- or 24-hour clock, current time, date, and on/off times, see [page 22](#).

## Turning your frame on and off

The frame automatically turns on when it is plugged in for the first time.

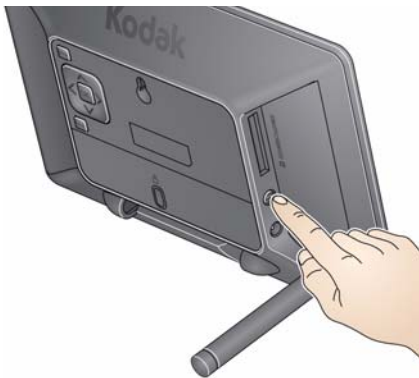

-  Power button—to turn the frame on or off, press and hold (for about 2 seconds), then release.

## Inserting a memory card

- To insert a card, push it firmly into the slot.
- To remove a card, pull it out of the slot.

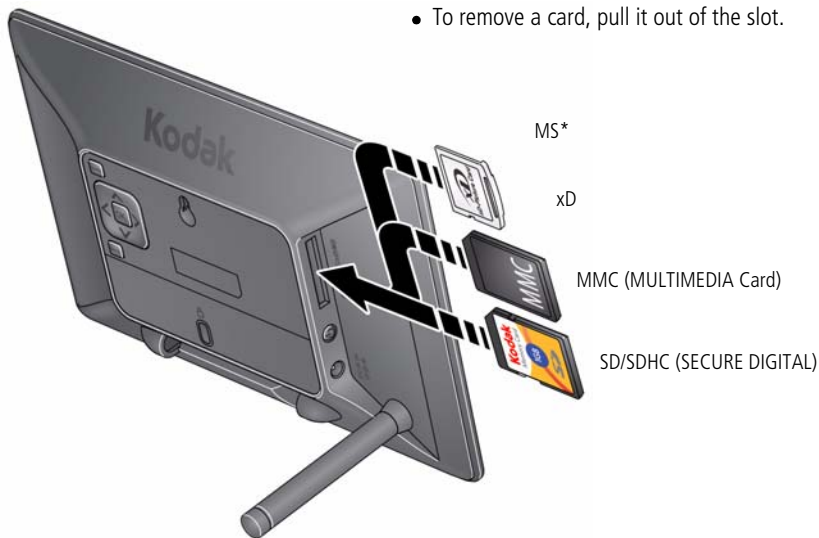

**IMPORTANT:** \*If you are using a micro or mini memory card (MS PRO or MS PRO Duo), insert it into an adapter first or it could get stuck in the display card slot. Memory cards and adapters are sold separately.

## Inserting a USB device

- Supported USB devices include flash drives and card readers.
- USB devices are sold separately.

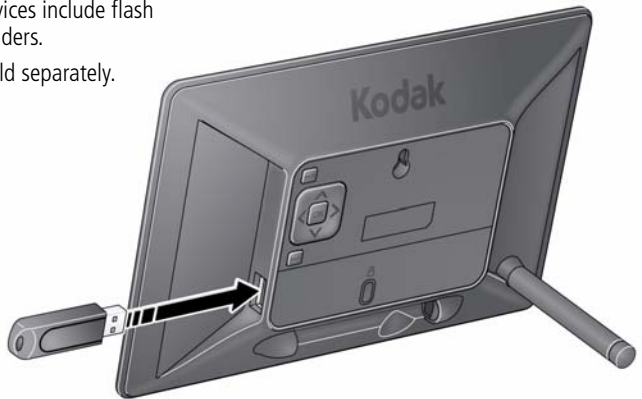

## Copying pictures to your frame

Copy pictures to your frame's internal memory from a memory card or USB device. Each time you insert a card or USB device, press **OK** and follow the copy directions.



### CAUTION:

**Do not remove a card or disconnect a device while copying. Your card, pictures, or device could be damaged.**



- 1 Insert a memory card or USB device (flash drive, card reader, hard drive).

*The pictures start playing. A copy message appears for 15 seconds, "To copy pictures from <inserted source> to the frame's internal memory, press OK."*

- 2 While the copy message is displayed, press **OK**.
- 3 Highlight your copy method:

**This picture**—copy the displayed picture.

**All pictures in folder**—copy all the pictures in a folder (*folder* represents the folder name, if there are any folders on the inserted card or device).

**All pictures in source**—copy all of the pictures on the card or USB device (*source* represents the type of card or device that's inserted in the frame).

- 4 Press **OK**.

*The slide show plays while pictures are being copied.*

**NOTE:** Copies are automatically resized to a lower resolution (smaller size). Full resolution is unnecessary for viewing and quickly fills up the frame's memory.

Copying from internal memory to a memory card or USB device is not supported.

To copy pictures anytime a slide show is playing, with a card or USB device inserted, press **OK**, highlight  (Copy), and continue with step 3 above.

## Copying pictures from a computer, using a memory card

The easiest way to copy a large number of pictures from your computer to your frame's internal memory:

- 1 Insert an empty memory card or USB device into your computer.
- 2 Copy some or all of the pictures from your computer onto the card or USB device.
- 3 Remove the card or USB device from your computer, and insert it into the frame.
- 4 Follow the copy directions on [page 8](#) (highlight All pictures, then press **OK**).

## Copying pictures from a digital camera

- 1 Remove the memory card (containing pictures) from your camera, and insert it into the frame.
- 2 Follow the copy directions on [page 8](#).

# 2

## Viewing pictures

View pictures from your frame's internal memory or any connected picture source (memory card, USB device).

- By default, pictures play in random order. For different ways of viewing your pictures, see [Searching for and viewing your pictures, page 11](#).
- You can change the duration (how long each picture stays on the screen) and transition style between pictures. See [Changing frame settings, page 19](#).

### Viewing from internal memory

Pictures play from the frame's internal memory when no card or USB device is inserted.

- Turn on the frame.

*All pictures in your frame's internal memory begin to play automatically.*

NOTE: Make sure no memory card or USB device is inserted in the frame.

To copy pictures into the frame's internal memory, [see page 8](#).

### Viewing from a memory card or USB device

Pictures play from a memory card or USB device whenever one is inserted in the frame.



- Turn on the frame. Insert a memory card, USB flash drive, or other USB device (see [page 6](#)).  
*Your pictures start playing automatically.*
- To copy pictures into the frame's internal memory, press **OK** and follow the screen instructions (see [page 8](#)).



## Searching for and viewing your pictures



NOTE: The buttons and controls you use to search for and view pictures are located on the back of the frame. See [Navigation buttons, page 3](#).



- 1 Press **OK** to pause a slide show and display the control panel icons.
- 2 Press **>** to highlight  (Pictures), then press **OK**.

NOTE: The Pictures icon changes to indicate your current picture source ([see page ii](#)).



- 3 Press **<>** to highlight the different ways to search for and play your pictures.



### All—searching and viewing all pictures

Select  and press **OK**. All of the pictures in the current picture source are displayed as thumbnails.



- 1 Press **▼** to highlight the first thumbnail.  
For details on moving through the thumbnails, see [Viewing thumbnails, page 15](#).
- 2 Press **OK** to display the highlighted thumbnail at full-screen.
- 3 Press **OK** again to start the slide show.







## Date—searching and viewing by date

Select  and press **OK**. A film strip of the pictures in the current picture source is displayed, organized by date.

NOTE: Make sure the time and date are set accurately on your camera or other capture device.

If you modify pictures on your computer, the frame uses the modify date, not the capture date.





- 1 Press  to highlight the current picture in the film strip.
- 2 Press  to navigate through the film strip. To move even faster, press and hold an arrow button.
- 3 To quickly move through many pictures in the film strip, press  to highlight the slider bar. Then press .
- 4 To search by specific month and year, press  to highlight the date bar. Then press .
- 5 Press **OK** to display thumbnails of the pictures taken on the date of the selected picture.

For details on moving through the thumbnails, see [Viewing thumbnails, page 15](#).

## Folders—searching and viewing by folders

Select  and press **OK**. Folders in the current picture source are listed here.



- 1 Press  to highlight the first folder in the list.
- 2 Press  to navigate through the folders. To move even faster, press and hold an arrow button.

*A preview slide show plays of the pictures in the highlighted folder.*

- 3 Press **OK** to display thumbnails of the pictures in the folder.



For details on moving through the thumbnails, see [Viewing thumbnails, page 15](#).

- 4 Press **OK** to display the highlighted thumbnail at full-screen.
- 5 Press **OK** again to start the slide show.

## Keywords—searching and viewing by keywords

KODAK Digital Cameras (and others) let you tag pictures with keywords. Select  and press **OK**. If there are any pictures tagged with keywords in the current picture source, they are listed here.



- 1 Press  to highlight the first keyword in the list.
- 2 Press  to navigate through the keywords. To move even faster, press and hold an arrow button.

*A preview slide show plays of the pictures with the highlighted keywords.*

- 3 Press **OK** to display thumbnails of the pictures with that keyword.



For details on moving through the thumbnails, see [Viewing thumbnails, page 15](#).

- 4 Press **OK** to display the highlighted thumbnail at full-screen.
- 5 Press **OK** again to start the slide show.

## People—searching and viewing by people

The latest KODAK Digital Cameras let you identify people in your pictures. Select  and press **OK**. If there are any identified people in the current picture source, they are listed here, grouped by person.



- 1 Press  to highlight the first person in the list.
- 2 Press  to navigate through the people. To move even faster, press and hold an arrow button.  
*A preview picture of the highlighted person is displayed.*

- 3 Press **OK** to display thumbnails of pictures of that person.

For details on moving through the thumbnails, see [Viewing thumbnails, page 15](#).

- 4 Press **OK** to display the highlighted thumbnail at full-screen.
- 5 Press **OK** again to start the slide show.

## Favorites—searching and viewing favorites

KODAK Digital Cameras let you tag pictures as favorites. Select  and press **OK**. If there are any favorites in the current picture source, they are displayed as thumbnails.





- 1 Press  to highlight the first thumbnail.  
For details on moving through the thumbnails, see [Viewing thumbnails, page 15](#).
- 2 Press **OK** to display the highlighted thumbnail at full-screen.
- 3 Press **OK** again to start the slide show.

## Viewing thumbnails

View the pictures on your frame as thumbnails when you're searching for pictures ([page 11](#)).



- 1 Press  to highlight the first thumbnail.
- 2 Press the arrows to navigate through the thumbnails. To move even faster, press and hold an arrow button.
- 3 To quickly page through the thumbnails, continue to press  to highlight the slider bar. Then press .
- 4 Press **OK** to display the highlighted thumbnail at full-screen.
- 5 Press **OK** again to start the slide show or press the **back** button to return to thumbnails view.

## Changing viewing modes

Press the **mode** button to change how you display pictures on your frame.

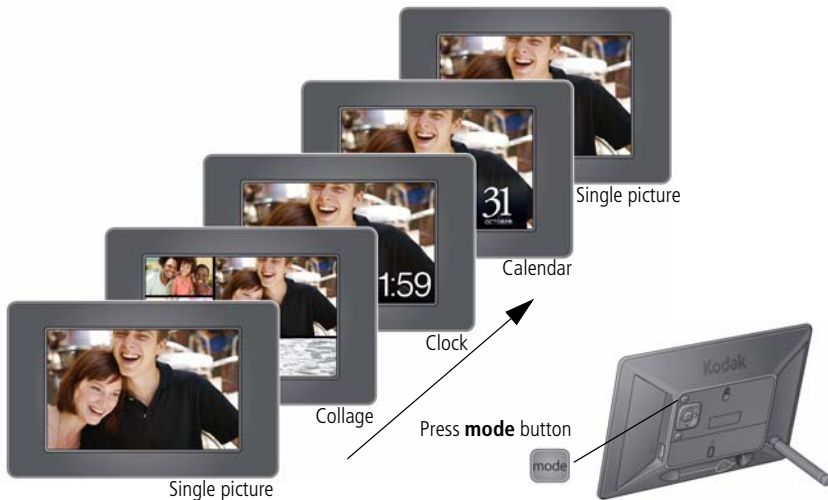

- Each time you press the **mode** button, the frame advances to the next viewing mode.
- Available viewing modes are: single picture, collage, clock, and calendar.
- There are several styles of collage, clock, and calendar modes available. To change the style, highlight the Set Modes icon  from the main control panel. See [Setting viewing modes, page 25](#).



## Picture Finder—auto-play similar pictures

Picture Finder  lets you automatically play the pictures that were taken on the same day as the picture on the screen.

NOTE: Make sure the time and date are set accurately on your camera or other capture device.



If you modify pictures on your computer, the frame uses the modify date, not the capture date.

### Play similar pictures



- 1 While a slide show is playing, press **OK** to pause play and display the main control panel icons.
- 2 Press  to highlight  (Picture Finder), then press **OK**.  
*Pictures that were taken on the same day as the selected picture begin playing.*

### Play similar pictures from collage mode

Play similar pictures while in collage mode.

- 1 Press the **mode** button to change to collage mode ([see page 16](#)).
- 2 Press **OK** to pause play and display the main control panel icons.  
*Picture Finder  is highlighted.*
- 3 Press **OK**, then press  to highlight a picture in the collage.
- 4 To highlight a different picture in the collage, press , then press **OK**.  
*Pictures begin playing that were taken on the same day as the highlighted picture.*

### Exit Picture Finder

- 1 Press **OK** to pause Picture Finder and display the main control panel icons.
- 2 Press  to highlight  (Picture Finder), then press **OK**.  
*Random pictures resume playing.*

## Pausing play on a single picture



- When a slide show is playing, press **OK**.  
*The slide show pauses with the current picture displayed. The main control panel appears with Play highlighted.*
- To resume the slide show, press **back** or **OK**.

## Deleting pictures from your frame

You can delete pictures from your frame's internal memory but not from an inserted memory card or USB device.



- 1 Make sure no memory card or USB device is inserted in the frame. When a slide show is playing from internal memory, press **OK**.  
*The main control panel appears.*

- 2 Press **➤** to highlight  (Delete), then press **OK**.

- 3 Highlight your delete method:

**This picture**—delete the displayed picture.

**Exit** (default)—exit the delete screen without deleting the picture.

**All pictures in folder**—delete all the pictures in a folder (*folder* represents the folder name, if there are any folders on the frame).

**All pictures on frame**—delete all of the pictures on the frame.

- 4 Press **OK**.







# 3

## Changing settings and more

### Changing frame settings

The options in the Settings menu let you customize and configure your frame.

**IMPORTANT:** *You may need to keep pressing the up/down arrows  to see the complete list of available options.*

- 1 While a slide show is playing, press **OK** to pause play and display the main control panel icons.
- 2 Press  to highlight  (Settings), then press **OK**.
- 3 Press  to highlight a Setting, then press **OK** to display the setting options.

Options selected from a list

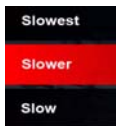

- 4 If the options are displayed in a list (no radio buttons), press  to highlight an option, then press **OK**.

Options selected with radio buttons

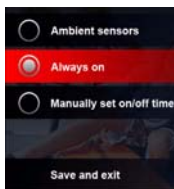

- 5 If the options are displayed with radio buttons, press  to highlight your choice, then highlight **Save and exit** and press **OK**.

## Settings

To return to the previous screen, press **back** .

Setting	Options
<b>Rotate</b>	<b>90° clockwise</b> (default)—rotate the current picture. <b>Exit</b> —return to slide show without rotating any pictures. <b>90° counter</b> —rotate the current picture counterclockwise. <b>180° flip</b> —rotate the current picture.
<b>Time</b>	Set the current time (see page 22).
<b>Date</b>	Set the current date (see page 22).
<b>Time On/Off</b> See <a href="#">Set on/off times, page 23</a> .	<b>Always on</b> —the frame is always on. To turn it off, press the Power button or unplug it. <b>Manually set on/off time</b> —set automatic on and off times. <b>Save and exit</b> —highlight, then press <b>OK</b> to save your selections and exit the screen.
<b>Picture Book background</b>	Select a background color or pattern that will be displayed behind your pictures when your frame is in Picture Book viewing mode (see page 25).
<b>Fit/Fill</b> Choose how to display pictures.	<b>Fit</b> —show the whole picture. Black borders may appear around the image. <b>Fill (default)</b> —the picture fills the entire screen; some of the picture may be cut off (cropped).
<b>Brightness</b> Adjust the screen brightness.	<b>1</b> (darkest) to <b>10</b> (lightest). Change the setting by pressing the arrow  buttons.
<b>Display picture order by</b> Specify the order in which to play your pictures.	<b>Random (default)</b> —play pictures in random order. <b>Oldest to newest</b> —start play with the oldest file date. <b>Newest to oldest</b> —start play with the most recent file date. <b>A - Z</b> —start play alphabetically from A to Z. <b>Z - A</b> —start play alphabetically from Z to A.

Setting	Options
<b>Language</b>	Choose your language (see page 4).
<p><b>Firmware upgrade</b></p> <p>This setting appears at the top of the Settings list if the upgrade file (.img) is present on the frame (on an inserted memory card or flash drive, or copied into internal memory).</p>	<p><b>Upgrade now</b>—load the latest version of firmware on your frame (see page 26).</p> <p><b>Exit without upgrading</b>—return to the main menu.</p>
<b>About</b>	Check your frame model, serial number, and firmware version.

## Setting the time, date, and on/off times

The first time you turn on your frame, the Time, Date, and On/Off screens each appear automatically after you select your language (see page 5).

### To change the settings after your frame is set up and running:

1 Press **OK** to pause a slide show and display the control panel icons.

2 Press **➤** to highlight  (Settings), then press **OK**.

NOTE: Press arrow buttons  to highlight options and change settings.

### Set the time



1 Highlight **Time**, then press **OK**.

2 Press **⬆** to change time format (12:00 or 24:00 hour clock), hour, minutes and AM/PM.

3 Press **⬅** to move to the next entry.

4 Press **OK**.

*The Date screen appears.*

### Set the date



1 Press **⬆** to change the date format, month, day, and year.

2 Press **⬅** to move to the next entry.

3 Press **OK**.

*The On/Off Times screen appears.*

NOTE: If the frame loses power or you unplug it for more than a minute, you are prompted to reset the time and date when power is restored or when you plug it back in.

## Set on/off times

Highlight the option you want, then press **OK** to activate it.





**Always on**—frame stays on until you press the power button or unplug it.

**Manually set on/off time (default)**—frame turns itself on and off at pre-set times. The default turns the frame on in the morning and off at night. To change the on/off times, see **Manually set auto on/off times**, below.

## Manually set auto on/off times

You specify the times you want your frame to automatically turn on and off.



- 1 Press  to change hour, minutes and AM/PM.
- 2 Press  to move to the next entry.
- 3 Press **OK** when finished.

**NOTE:** The on and off times you set go into effect in the future. For example, if it's currently 10:00 pm and you set the off time for 9:00 pm, the frame will stay on until the next evening at 10:00 pm.

## Setting transitions between pictures

Choose how long each picture is displayed and a transition style between pictures.



- 1 Press **OK** to pause a slide show and display the control panel icons.
- 2 Press **➤** to highlight  (Transitions), then press **OK**.

- 3 Press **⬅** to highlight a timing and transition option, then press **OK**.

<b>Slowest</b>	pictures change once a day, at midnight; transition effect is a gentle motion to the left.
<b>Slower</b>	pictures change once an hour, on the hour; transition effect is a slow fade.
<b>Slow</b>	pictures change once a minute; transition effect is a slow fade.
<b>Medium 1</b>	pictures change once every 10 seconds; transition effect is pan and zoom.
<b>Medium 2</b>	pictures change once every 10 seconds; transition effect is a slow fade.
<b>Fast</b>	pictures change once every 5 seconds; transition effect is a gentle motion to the left.

## Setting viewing modes

There are several styles of clock, calendar, and collage modes available. Preview the available modes and select your choices here.



1 While a slide show is playing, press **OK** to pause play and display the main control panel icons.

2 Press **>** to highlight  (Set Modes), then press **OK**.



3 Press **◊** to highlight a mode.

4 With Clock, Calendar, or Collage highlighted, press **<>** to highlight and preview each different style. Leave the highlight on the style you wish to select.

NOTE: Collage styles include Multi-Grid, Single Grid, and Picture Book. You can change the background that is displayed behind Picture Book ([see page 20](#)).

5 Press **OK** to exit and save your selections.

*Now when you press the mode button ([see page 16](#)), your pictures will be displayed in the style that you've selected.*

## Upgrading your firmware (recommended)

Firmware is the software that runs on your frame. Download and install the latest version from the Web to keep your frame up to date.

### Check your frame's current firmware version

Go to the About screen in the Settings menus (see [Changing frame settings, page 19](#) and [page 21](#)). Note the firmware version on the About screen.

### Download the latest firmware

- 1 On your computer, go to [www.kodak.com/go/digitalframedownloads](http://www.kodak.com/go/digitalframedownloads).
- 2 Enter your frame model and note the firmware version that's available for download. If it's newer than the version on your frame, follow the screen directions to download the frame firmware to your computer.
- 3 When the firmware is downloaded, copy the IMG file to the root directory (top level, not in a folder or subfolder) of a memory card or USB flash drive.

### Upgrade your frame

- 1 Remove the memory card or USB flash drive from your computer, then insert it into the frame.
- 2 Press **OK** to pause the slide show and display the main control panel icons.
- 3 Press **➤** to highlight  (Settings), then press **OK**.
- 4 Highlight **Firmware upgrade**, then press **OK**.

*The upgrade may take up to 5 minutes. When the upgrade is complete, your frame automatically restarts.*



#### **CAUTION:**

**Do not turn off the frame or remove the memory card or USB flash drive until the upgrade is complete and the frame has restarted.**



## Changing your frame orientation

Your frame is set up to display pictures in landscape orientation .

To change the orientation to portrait , rotate your pictures in the Settings menu ([see page 20](#)) and then turn the frame on its side.

### Turn the frame



## Hanging your frame on the wall

To hang your frame on the wall in landscape orientation, remove the stand, then use wall anchoring hardware (not included) to securely mount the frame to the wall.

See [Frame features, page i](#) for the location of the mounting hole on the back of the frame.

## Maintaining your frame

**IMPORTANT:** *Always disconnect the power before cleaning. Do not use water, cleaning solutions, or other adhesives on the frame or any of its parts.*

**Gently** wipe the frame and screen with a clean, dry, lint-free cloth. For fingerprints on the frame, apply light pressure.

## Learning more about your frame

[www.kodak.com/go/digitalframes](http://www.kodak.com/go/digitalframes) Learn more about your frame. Order accessories.

[www.kodak.com/go/digitalframesupport](http://www.kodak.com/go/digitalframesupport) Support for KODAK Digital Frames

[www.kodak.com/go/support](http://www.kodak.com/go/support) Support for all KODAK Products

## 4

# Troubleshooting and support

For product support, go to [www.kodak.com/go/digitalframesupport](http://www.kodak.com/go/digitalframesupport).

## Picture frame problems

If...	Try one or more of the following
Frame does not turn on.	<ul style="list-style-type: none"> <li>■ Make sure the power cable that was included with your frame is connected securely (see page 2).</li> <li>■ Unplug the power cable for 5 seconds, then reconnect the cable. Press and hold the <b>power</b> button (for about 2 seconds), then release.</li> </ul>
Nothing happens when a memory card or USB device is connected.	<ul style="list-style-type: none"> <li>■ Insert a certified memory card, with images, into the card slot, then push to seat it (see page 6).</li> <li>■ Make sure the USB device is connected securely (see page 7).</li> <li>■ Make sure the file format of your pictures and videos are supported (see page 32).</li> </ul>
Frame freezes up or doesn't work properly.	<ul style="list-style-type: none"> <li>■ Unplug the power cable for 5 seconds, then reconnect the cable. Press and hold the <b>power</b> button (for about 2 seconds), then release.</li> <li>■ Reset the frame. On the back of the frame, press the <b>mode</b> and <b>power</b> buttons (see page i) at the same time. Highlight a reset option, then press <b>OK</b>.               <ul style="list-style-type: none"> <li>■ <b>Just reset</b>—reset and save all pictures on the frame.</li> <li>■ <b>Reset and delete all pictures</b>—reformat the internal memory and delete all pictures on the frame.</li> <li>■ <b>Return to slide show without doing anything</b></li> </ul> </li> </ul>
You set automatic on/off but the frame doesn't turn on and off at the specified times.	If your frame loses power, the clock returns to the factory setting and auto on/off times are disabled. See <a href="#">Re-setting your frame after losing power, page 31</a> .

## Screen messages

Screen message	Try one or more of the following
File is bad. (usually preceded by the file name. For example: xxx_xxxx.JPG file is bad)	The frame cannot display the picture because the file is corrupted or it's an unsupported file format (see page 32). NOTE: Videos are not supported.
Write failed. Select another location.	The frame was unable to copy the picture. ■ Insert a different card or device (page 6).
Error attempting to open file or directory.	■ Turn off the frame, then turn it back on. Press and hold the power button (for about 2 seconds), then release. If the problem persists, contact customer support help, at <a href="http://www.kodak.com/go/digitalframesupport">www.kodak.com/go/digitalframesupport</a> .
Error occurred while closing a file.	
Error invalid filename.	
Error reading from file.	
Error writing from file.	
Error writing a file.	
Error writing to a file.	
File Copy Failed!	
Internal error.	
Parameter is invalid.	
Unknown error.	

## **Re-setting your frame after losing power**

If the frame loses power or you unplug it for more than a minute, the time and date setting is lost.

When the power is restored and the frame turns on, you are prompted to reset the time and date ([see page 5](#)).

## 5

## Appendix

## Digital frame specifications

For more specifications, go to [www.kodak.com/go/digitalframesupport](http://www.kodak.com/go/digitalframesupport).

<b>KODAK EASYSHARE P76 Digital Frame</b>	
<b>Color display</b>	
16.2 cm (6.4 in.) diagonal digital LCD, 714 x 480 pixels, 16:10 aspect ratio, 14.3 x 19.1 cm (5.6 x 3.6 in.) viewable area	
<b>Internal storage capacity (internal memory)</b>	
128 MB (store up to 1000 pictures. Actual storage capacity will vary based on picture content)	
<b>Power</b>	
AC adapter	110-240V AC 50/60 Hz AC adapter, 5V DC @ 1.5 Amp
<b>Communication with USB devices</b>	
USB High Speed Type B (for connecting a USB device, purchase separately)	
<b>Other features</b>	
Picture formats	JPEG, EXIF 2.2
Memory cards <a href="#">see page 6</a>	SD, SDHC (SECURE DIGITAL); MMC (MULTIMEDIA Card); xD. MS PRO/MS PRO Duo (MEMORY STICK), with adapter only. (Memory cards are not included, purchase separately)
Temperature	Operating: 0 to 40° C (32 to 104° F) Storage: -20 to 60° C (-4 to 140° F)
Size	12.8 x 19.6 x 2.2 cm (5.0 x 7.7 x .9 in.)
Weight	262 g (.58 lb.) - includes frame, stand

## Important safety instructions



### CAUTION:

**Do not disassemble this product; there are no user-serviceable parts inside. Refer servicing to qualified service personnel. Do not expose this product to liquid, moisture, or extreme temperatures. The use of controls, adjustments, or procedures other than those specified herein may result in exposure to shock and/or electrical or mechanical hazards. If the LCD breaks, do not touch the glass or liquid. Contact Kodak customer support.**

- The use of an accessory that is not recommended by Kodak may cause fire, electric shock, or injury. For approved accessories, go to [www.kodak.com/go/accessories](http://www.kodak.com/go/accessories).
- Use only the AC adapter that was packaged with your frame. Use of other AC adapters may damage the frame and void your warranties.
- When displayed with the stand extended, the frame rests at a 75° angle.
- Do not place frame near open flame sources such as lighted candles or heaters.

## Additional care and maintenance

- Always disconnect the power before cleaning. Do not use water, cleaning solutions, or other adhesives on the frame or any of its parts. Gently wipe the frame and screen with a clean, dry, lint-free cloth. For fingerprints on the frame, apply light pressure.
- Service agreements are available in some countries. Contact a dealer of KODAK Products for more information.
- For digital frame disposal or recycling information, contact your local authorities. In the US, visit the Electronics Industry Alliance at [www.eiae.org](http://www.eiae.org) or visit [www.kodak.com/go/digitalframesupport](http://www.kodak.com/go/digitalframesupport).

## Limited warranty

Kodak warrants KODAK Consumer Electronic Products and Accessories ("Products"), excluding batteries, to be free from malfunctions and defects in both materials and workmanship for one year from the date of purchase. Retain the original dated sales receipt. Proof of the date of purchase will be required with any request for warranty repair.

### Limited warranty coverage

Warranty service is only available from within the country where the Products were originally purchased. You may be required to ship Products, at your expense, to the authorized service facility for the country where the Products were purchased. Kodak will repair or replace Products if they fail to function properly during the warranty period, subject to any conditions and/or limitations stated herein. Warranty service will include all labor as well as any necessary adjustments and/or replacement parts. If Kodak is unable to repair or replace a Product, Kodak will, at its option, refund the purchase price paid for the Product provided the Product has been returned to Kodak along with proof of the purchase price paid. Repair, replacement, or refund of the purchase price are the sole remedies under the warranty. If replacement parts are used in making repairs, those parts may be remanufactured, or may contain remanufactured materials. If it is necessary to replace the entire Product, it may be replaced with a remanufactured Product. Remanufactured Products, parts and materials are warranted for the remaining warranty term of the original Product, or 90 days after the date of repair or replacement, whichever is longer.

### Limitations

This warranty does not cover circumstances beyond Kodak's control. This warranty does not apply when failure is due to shipping damage, accident, alteration, modification, unauthorized service, misuse, abuse, use with incompatible accessories or attachments (such as third party ink or ink tanks), failure to follow Kodak's operation, maintenance or repacking instructions, failure to use items supplied by Kodak (such as adapters and cables), or claims made after the duration of this warranty. Kodak makes no other express or implied warranty for this product, and



disclaims the implied warranties of merchantability and fitness for a particular purpose. In the event that the exclusion of any implied warranty is ineffective under the law, the duration of the implied warranty will be one year from the purchase date or such longer period as required by law. The option of repair, replacement, or refund is Kodak's only obligation. Kodak will not be responsible for any special, consequential or incidental damages resulting from the sale, purchase, or use of this product regardless of the cause. Liability for any special, consequential or incidental damages (including but not limited to loss of revenue or profit, downtime costs, loss of the use of the equipment, cost of substitute equipment, facilities or services, or claims of your customers for such damages resulting from the purchase, use, or failure of the Product), regardless of cause or for breach of any written or implied warranty is expressly disclaimed.

## Your rights

Some states or jurisdictions do not allow exclusion or limitation of incidental or consequential damages, so the above limitation or exclusion may not apply to you. Some states or jurisdictions do not allow limitations on how long an implied warranty lasts, so the above limitation may not apply to you. This warranty gives you specific rights, and you may have other rights which vary from state to state or by jurisdiction.

## Outside the United States and Canada

In countries other than the United States and Canada, the terms and conditions of this warranty may be different. Unless a specific Kodak warranty is communicated to the purchaser in writing by a Kodak company, no warranty or liability exists beyond any minimum requirements imposed by law, even though defect, damage, or loss may be by negligence or other act.

## Regulatory compliance and advisory

### FCC compliance and advisory



This equipment has been tested and found to comply with the limits for a Class B digital device, pursuant to Part 15 of the FCC Rules. These limits are designed to provide reasonable protection against harmful interference in a residential installation. This equipment generates, uses, and can radiate radio frequency energy and, if not installed or used in accordance with the instructions, may cause harmful interference to radio communications. However, there is no guarantee that interference will not occur in a particular installation. If this equipment does cause harmful interference to radio or television reception, which can be determined by turning the equipment off and on, the user is encouraged to try to correct the interference by one or more of the following measures: 1) reorient or relocate the receiving antenna; 2) increase the separation between the equipment and the receiver; 3) connect the equipment to an outlet on a circuit different from that to which the receiver is connected; 4) consult the dealer or an experienced radio/TV technician for additional suggestions. Any changes or modifications not expressly approved by the party responsible for compliance could void the user's authority to operate the equipment. Where shielded interface cables have been provided with the product or specified additional components or accessories elsewhere defined to be used with the installation of the product, they must be used in order to ensure compliance with FCC regulation.

### Canadian DOC statement

This Class B digital apparatus complies with Canadian ICES-003.

Cet appareil numérique de la classe B est conforme à la norme NMB-003 du Canada.

### CE

Hereby, Eastman Kodak Company declares that this KODAK Product is in compliance with the essential requirements and other relevant provisions of Directive 1999/5/EC.

## Waste Electrical and Electronic Equipment labeling



In Europe: For human/environmental protection, it is your responsibility to dispose of this equipment at a collection facility established for this purpose (separate from municipal waste). For more information, contact your retailer, collection facility, or appropriate local authorities; or visit [www.kodak.com/go/recycle](http://www.kodak.com/go/recycle). (Product weight: 262 g.)

## Australian C-Tick



## Russian GOST-R



Eastman Kodak Company  
Rochester, New York 14650

Цифровая фоторамка изготовлена в Китае; остальные элементы - в соответствии с маркировкой

## VCCI Class B

この装置は、クラスB情報技術装置です。この装置は、家庭環境で使用することを目的としていますが、この装置がラジオやテレビジョン受信機に近接して使用されると、受信障害を引き起こすことがあります。

取扱説明書に従って正しい取り扱いをして下さい。 VCCI-B

## China RoHS

**Product Disclosure Table**  
**Kodak Digital Picture Frames**  
**有毒有害物质或元素名称及含量标识表**  
 table of hazardous substances' name and concentration

部件名称 Component name	有毒有害物质或元素 hazardous substances' name					
	铅 (Pb)	汞 (Hg)	镉 (Cd)	六价铬 (Cr6+)	多溴联苯 (PBB)	多溴二苯醚 (PBDE)
交流变压器电路板元件 AC Adapter circuit board components	x	o	o	o	o	o
数码相框电路板元件 Digital Photo Frame circuit board components	x	o	o	o	o	o
数码相框外壳 Digital Photo Frame Enclosure	o	o	o	o	o	o

○：表示该有毒有害物质在该部件所有均质材料中的含量均在SJ/T 11363-2006规定的限量要求以下。  
 ×：表示该有毒有害物质至少在该部件的某一均质材料中的含量超出SJ/T 11363-2006规定的限量要求。  
 ○： indicates hazardous substance concentration lower than MCV  
 ×： indicates hazardous substance concentration higher than MCV



---

# Index

## A

- about, frame, 21
- AC adapter, 2, 33
- all pictures, searching, 11
- appendix, 32
- arrow buttons, 3
- attaching
  - power cable, 2
  - stand, 1
- auto enhancements, setting, 20
- automatic
  - on/off, setting, 23
  - picture finder, 17
- a-z, play alphabetically, 20

## B

- back button, 3
- brightness, 20
- button, mode, 16
- buttons, i

## C

- cable, power, connecting, 2
- calendar, viewing mode, 16
- camera, copying pictures from, 9
- card, memory
  - copying from, 9
  - inserting, 6
  - slot, i
  - supported types, 32
  - viewing pictures from, 10
- changing settings, 19—21

- cleaning frame, 28, 33
- clock and on/off times, setting, 5, 22
- clock, resetting after losing power, 31
- clock, viewing mode, 16
- collage mode
  - changing styles, 25
  - viewing, 16
- control panel icons, ii
- controls, i
- copy pictures, 8

## D

- date, searching by, 12
- date, setting, 5, 22
- deleting pictures from frame, 18
- display picture order by, 20
- disposal, recycling, 33
- download firmware, 26
- duration, setting, 24

## E

- energy saver, auto on/off, 23
- ENERGY STAR product, 38
- error messages, 30

## F

- favorites, searching by, 14
- file formats, picture, 32
- firmware, upgrading, 21, 26
- fit/fill, display, 20
- flash drive
  - inserting, 7

viewing pictures from, 10  
folders, searching by, 13  
frame, picture  
    hanging on wall, 27  
    specifications, 32  
    troubleshooting, 29  
    turn on/off, 5

## H

help  
    frame, 29  
    support URLs, 28  
    troubleshooting and support, 29

## I

icons, control panel, ii  
installing  
    flash drive, 7  
    memory cards, 6  
    USB device, 7  
internal memory  
    capacity, 32  
    copying to, 8  
    playing from, 10

## K

keywords, searching by, 13

## L

landscape, change orientation, 27  
language, setting, 4, 21

## M

main control panel, ii  
memory card. See card, memory

## mode

    button, i, 3  
    changing, 16  
    setting styles, 25

## N

newest to oldest, display, 20

## O

OK button, 3  
oldest to newest, display, 20  
on/off button, 5  
on/off, energy saver, 23  
order, display by, 20  
orientation, changing, 27

## P

pausing play, 18  
people, searching by, 14  
picture book backgrounds, 20  
picture finder, 17  
pictures  
    copying to frame, 8  
    deleting, 18  
    rotate, 20  
    searching, 11—14  
    viewing, 10—15  
portrait, change orientation, 27  
power  
    button, i, 5  
    connecting, 2  
    specifications, 32

## R

random display, 20

recycling, disposal, 33  
regulatory compliance, 36  
reset frame, 29  
reset time after losing power, 31  
rotate pictures, 20

## S

safety information, 33  
screen  
    cleaning, 28, 33  
    error messages, 30  
searching for pictures, 11—14  
set modes icon, 25  
settings, changing, 19—21  
    about  
    auto enhancements  
    brightness  
    date  
    display picture order by  
    firmware upgrade  
    language  
    picture book backgrounds  
    rotate  
    time  
    time on/off  
specifications, frame, 32  
stand, attaching, 1  
storage capacity, internal memory, 32  
support, 28

## T

tags, searching by, 13  
thumb drive, 7  
thumbnails, viewing, 15

time, date, and on/off times, 5, 22  
timer, auto on/off, 23  
transitions, setting, 24  
troubleshooting  
    error messages, 30  
    frame, 29  
turn on frame, 5

## U

upgrade firmware, 21, 26  
USB  
    devices, types, 32  
    inserting, 7

## V

viewing modes  
    changing, 16  
    setting styles, 25  
viewing pictures, 10—15

## W

wall mount, frame, 27  
warranty, 34  
Web sites, help, 28

## Z

z-a, play alphabetically, 20

## Free Manuals Download Website

<http://myh66.com>

<http://usermanuals.us>

<http://www.somanuals.com>

<http://www.4manuals.cc>

<http://www.manual-lib.com>

<http://www.404manual.com>

<http://www.luxmanual.com>

<http://aubethermostatmanual.com>

Golf course search by state

<http://golfingnear.com>

Email search by domain

<http://emailbydomain.com>

Auto manuals search

<http://auto.somanuals.com>

TV manuals search

<http://tv.somanuals.com>