Kodak EasyShare Z8612 IS digital camera



Extended user guide

www.kodak.com

For interactive tutorials, visit www.kodak.com/go/howto

For help with your camera, visit www.kodak.com/go/z8612support

Kodak

Eastman Kodak Company
Rochester, NY 14650

© Eastman Kodak Company, 2008

All screen images are simulated.

Kodak, EasyShare, and Perfect Touch are trademarks of Eastman Kodak Company.

P/N 4F8006_en

Front view

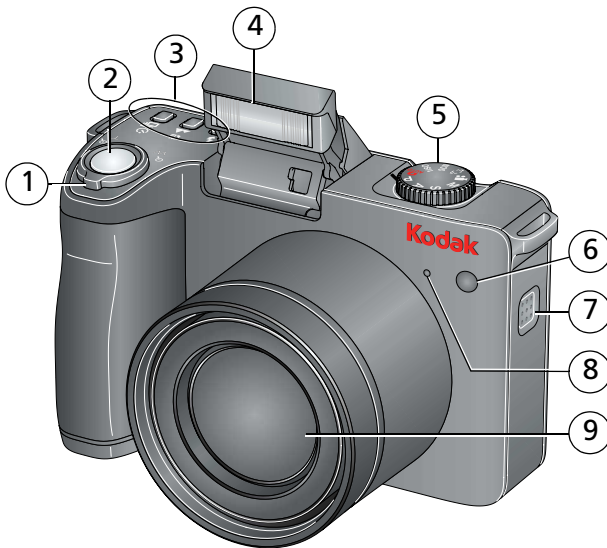

- | | | | |
|---|--|---|--|
| 1 | Zoom Telephoto/Wide Angle | 6 | Self-timer/Auto focus assist/Video light |
| 2 | Shutter button | 7 | Speaker |
| 3 | Flash, Focus, Self-timer/Burst buttons | 8 | Microphone |
| 4 | Flash | 9 | Lens |
| 5 | Mode dial | | |

Back view

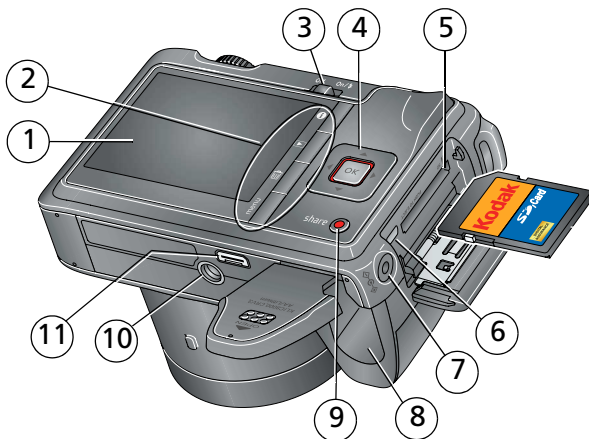

- | | | | |
|---|--|----|--|
| 1 | LCD | 7 | DC-In, for optional 3V AC adapter |
| 2 | Info, Review, Delete, Menu buttons | 8 | Battery compartment |
| 3 | Power button | 9 | Share button |
| 4 | ◀/▶ ▲/▼, OK | 10 | Tripod socket |
| 5 | Slot for optional SD or SDHC card | 11 | Dock connector |
| 6 | USB, A/V Out | | |

Table of contents

1	Setting up your camera	1
	Attaching the strap	1
	Loading the battery	1
	Turning on the camera	2
	Setting the language, date/time	2
	Storing pictures on an optional SD or SDHC card	3
2	Taking pictures/videos	4
	Taking a picture	4
	Capture modes	6
	Using optical zoom	8
	Taking flash pictures	9
	Using focus modes	10
	Taking self-timer pictures	11
	Taking burst pictures	12
	Taking panoramic pictures	13
	Understanding the picture-taking icons	14
3	Working with pictures/videos	15
	Reviewing pictures/videos	15
	Deleting pictures/videos	17
	Using the menu button in Review	18
	Adding sound tags	19
	Cropping pictures	20
	Using Kodak Perfect Touch technology	20
	Editing videos	21
	Running a slide show	23
	Viewing pictures/videos in different ways	26
	Selecting multiple pictures/videos	27
	Copying pictures/videos	27
	Understanding the review icons	28

4 Doing more with your camera	29
Using the Menu button to change settings	29
Using the framing grid to compose a picture.....	35
Using PASM modes.....	35
Using exposure compensation to adjust brightness	37
Using the histogram to view picture brightness.....	37
Sharing your pictures.....	38
5 Transferring and printing pictures	42
Installing the software.....	42
Transferring pictures with the USB cable.....	43
Printing pictures.....	44
Dock compatibility for your camera.....	46
6 Troubleshooting	47
7 Getting help	52
Helpful links.....	52
8 Appendix	54
Camera specifications	54
Storage capacities	57
Upgrading your software and firmware.....	57
Important safety instructions	57
Battery life	58
Care and maintenance	59
Limited warranty.....	59
Regulatory compliance	61

1

Setting up your camera

Attaching the strap

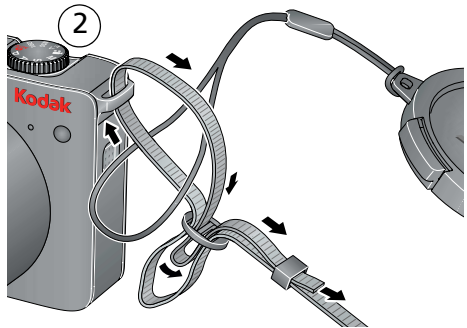
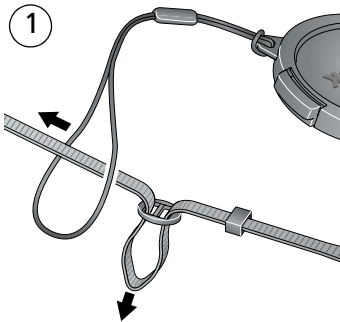

Loading the battery

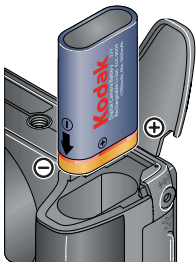

Kodak Li-Ion rechargeable digital camera battery KLIC-8000 (rechargeable)

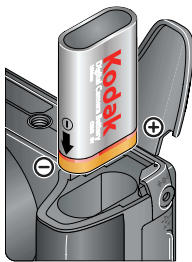

Kodak lithium digital camera battery CRV3 (non-rechargeable)

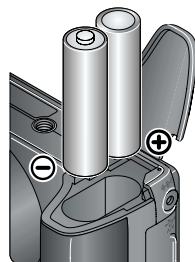

2 AA lithium (non-rechargeable)
Alkaline batteries are NOT compatible.

To extend battery life, see [page 58](#).

www.kodak.com/go/support

Turning on the camera



The flash opens automatically.



Note: After you turn off the camera, carefully push down the flash to close it.

Setting the language, date/time

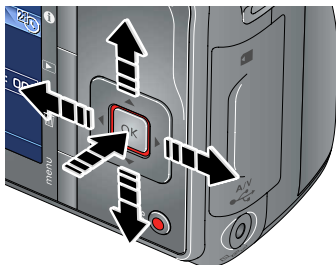

Language:
▲/▼ to change
OK to accept

Date/Time:
▲/▼ to change
◀/▶ for previous/next field
OK to accept

NOTE: To change the date/time and language in the future, use the Menu button (see page 33).

Storing pictures on an optional SD or SDHC card

Your camera has internal memory. You can purchase an SD or SDHC card to store more pictures and videos (www.kodak.com/go/z8612accessories).

NOTE: To choose a storage location for pictures and videos, [see page 32](#).

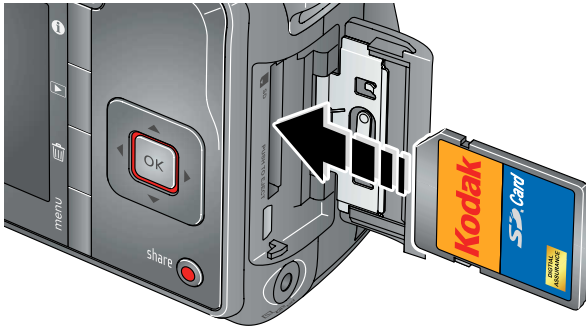

Turn off the camera before inserting or removing a card.



CAUTION:

A card can only be inserted one way; forcing it may cause damage. Inserting or removing a card when the Ready light is blinking may damage the pictures, the card, or the camera.

2

Taking pictures/videos

Taking a picture

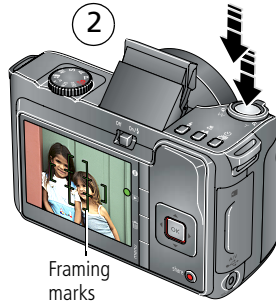
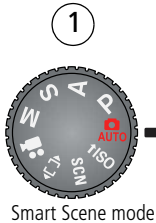

Press the Shutter button halfway to lock the focus.

When the framing marks turn green, press the Shutter button completely down.

NOTE: For more information on Smart Scene and other modes, [see page 6](#).

Press | **i** to turn on/off status icons ([see page 14](#)) and histogram ([see page 37](#)). For more information on framing marks, [see page 5](#).

Taking a video

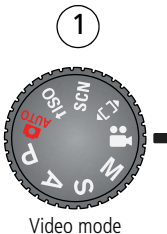

Press the Shutter button completely down and release.

To stop recording, press and release the Shutter button again.

Reviewing the picture/video just taken

After you take a picture/video, the LCD displays a quickview for several seconds. (To dismiss the quickview sooner, press the Shutter button halfway.)

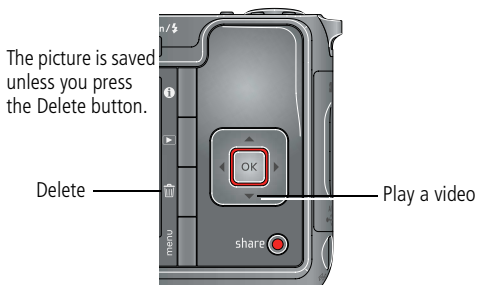

To review pictures/videos anytime, see [page 15](#).

Using the framing marks to take pictures

Framing marks indicate the camera focus area. The camera attempts to focus on foreground subjects, even if they're not centered in the scene.

1 Press the Shutter button **halfway**.

When the subject is in focus, the framing marks turn green. If the camera is not focusing on the desired subject (or if the framing marks disappear), release the Shutter button and recompose the scene.





2 Press the Shutter button **completely down** to take the picture.

NOTE: Framing marks do not appear in some SCN (scene) and Video modes. When you use AF Zone and set Center Zone, the framing marks are fixed at Center Wide.





Capture modes



Choose the mode that best suits your subjects and surroundings.

Capture mode	For
 Smart Scene AUTO	General picture taking —offers an excellent balance of image quality and ease of use. When the Shutter button is pressed halfway, faces are detected, the scene is analyzed, and the best settings are applied.
P Program A Aperture priority S Shutter priority M Manual	More creative control. (See page 35).
 ISO High ISO	People in low-light scenes.
SCN Scene	Point-and-shoot simplicity when taking pictures under special conditions. (See page 6 .)
 Panorama	“Stitching” 2 or 3 pictures into 1 panoramic scene. (See page 13 .)
 Video	Video with sound. (See page 4 .)

Scene modes

- 1 Turn the Mode dial to Scene **SCN**.
- 2 Press     to display Scene modes.
- 3 Press OK to choose a Scene mode.

SCN mode	For
Portrait	Full-frame portraits of people.

SCN mode	For
Sport	Subjects that are in motion. Shutter speed is fast. The camera pre-settings are Multi-Pattern Exposure Metering and Multi-Zone Focus.
Landscape	Far-away scenes. The camera uses infinity auto-focus. Auto-focus framing marks are not available in Landscape.
Night Portrait	Reducing red eye of people in night scenes or low-light conditions. Place the camera on a flat, steady surface or use a tripod.
Night Landscape	Distant scenery at night. Flash does not fire. Place the camera on a flat, steady surface or use a tripod.
Snow	Bright snow scenes.
Beach	Bright beach scenes.
Text	Documents. Focus is set to Macro Focus.
Fireworks	Bright, colorful light displays. Flash does not fire. Place the camera on a flat, steady surface or use a tripod.
Flower	Close-ups of flowers or other small subjects in bright light. Focus is set to Macro Focus.
Manner/ Museum	Quiet occasions, like a wedding or lecture. Flash and sound are disabled.
Self-Portrait	Close-ups of yourself. Assures proper focus and minimizes red eye.
Stage	People on a lit stage. Fast shutter speed, high ISO. Flash and sounds are off.
Backlight	Subjects that are in shadow or "backlit" (when light is behind the subject).
Candle light	Capturing the ambiance of candle light.
Sunset	Capturing the deep hues seen at sunset.

Using optical zoom

Use optical zoom to get up to 12X closer to your subject **before** taking pictures/videos.

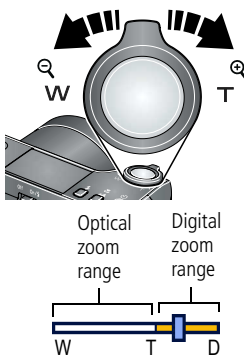

- 1 Use the LCD to frame your subject. For focus distances, see [Camera specifications, page 54](#).
- 2 Press Telephoto (T) to zoom in. Press Wide Angle (W) to zoom out.
- 3 Take the picture/video.

NOTE: To get a focused picture every time, remember:

- Use the auto focus framing marks, [page 4](#).
- As you zoom in, move away from your subject.

Focus distance

Auto	24 in. (60 cm)–infinity @ wide 3.9 ft (1.2m)–infinity @ telephoto
Macro	4.7–23.7 in. (12–60 cm) @ wide
NOTE: For Focus modes, see page 10 .	2–4.3 ft (0.6–1.3m) @ telephoto

Use digital zoom to get up to 5X beyond optical zoom while taking pictures.

NOTE: You may notice decreased image quality when using digital zoom. The slider on the zoom indicator turns red when the picture quality reaches the limit for an acceptable 4 x 6-in. (10 x 15 cm) print.

Taking flash pictures



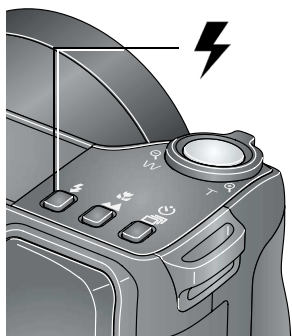

Use the flash when you take pictures at night, indoors, or outdoors in heavy shadows. The flash opens when you turn on the camera.



Press the Flash  button repeatedly to scroll through flash modes. (See flash modes below.)

Flash-to-subject distance in Smart Scene mode



Wide angle	1.6–25.6 ft (0.5–7.8m)
Telephoto	3.9–14.4 ft (1.2–4.4 m)

Flash modes	Flash fires	
 Auto	When the lighting conditions require it.	
 Off	Never.	
 Fill	Every time you take a picture, regardless of the lighting conditions. Use when the subject is in shadow or is “backlit” (when the light is behind the subject). In low light, hold the camera steady or use a tripod.	
 Red-eye	If Red-eye Pre-flash is turned off (in the Setup menu): the flash fires once and the camera automatically corrects red-eye in the picture.	If Red-eye Pre-flash is turned on (in the Setup menu): the flash fires once so the eyes become accustomed to the flash, then fires again when the picture is taken.
To turn the Red-eye Pre-flash feature on/off, see page 33 .		

Using focus modes



- 1 In most Still modes, press the Focus  button:
 - Once for Macro (close-up)
 - Again for Landscape (infinity)
 - Again to return to normal Auto Focus
- 2 Compose the scene. Press the Shutter button **halfway**, then completely down.

Focus mode	Description
AF Normal AF	Focus setting for general picture-taking.
 Macro	To gain sharpness and detail in pictures at close range. Use available light instead of flash, if possible.) Camera automatically sets the focus distance depending on the zoom position: Wide angle: 4.7–23.7 in. (12–60 cm) Telephoto: 2–4.3 ft (0.6–1.3m)
 Infinity	To gain sharpness of distant scenes. Camera uses infinity auto-focus. Auto-focus framing marks are not available in Landscape.

Taking self-timer pictures

Use the self-timer when you want to be included in a picture, or to ensure a steady Shutter button press.



- 1 Place the camera on a tripod or flat surface. In most Still modes, press the Self-timer/Burst button :
 - Once for a 10-second delay (so you have time to get into the scene)
 - Again for a 2-second delay (for a steady, auto-shutter release on a tripod)
 - Again for 2-shot (one picture taken after 10 seconds and another picture taken 8 seconds later)
- 2 Compose the scene. Press the Shutter button **halfway**, then completely down.

The picture is taken after the delay. To cancel the Self-timer before the picture is taken, press the Self-timer/Burst button, or press the Shutter button completely down.

Use the same procedure to use the self-timer in Video mode, but:

- Turn the Mode dial to Video .
- Press the Shutter button completely down.

NOTE: The video stops when no storage space remains. Only the 2- and 10-second options are available in video mode.

Taking burst pictures



- 1 In most Still modes, press the Self-timer/Burst button  until the desired Burst mode appears. (See table, below.)



NOTE: Burst is unavailable in Portrait, Night Portrait, Night Landscape, Backlight, Fireworks, and Panorama modes.

- 2 Press the Shutter button **halfway** to focus and set exposure.

- 3 Press the Shutter button **completely down and hold it** to take pictures.



The camera stops taking pictures when you release the Shutter button, when the pictures are taken, or when there is no more storage space.

NOTE: During quickview, you can delete all pictures in the burst series. To delete selectively, do so in Review (see [page 17](#)).

Mode	Icon	Description	Purpose
First Burst		Camera takes up to 4 pictures while the Shutter button is pressed.	Capture an expected event. Example: A person swinging a golf club.
Last Burst		Camera takes up to 30 pictures while the Shutter button is pressed. When the Shutter button is released, only the last 4 pictures are saved.	Capture an event when the precise timing is uncertain. Example: A child blowing out birthday candles.

Taking panoramic pictures

Use panorama to “stitch” up to 3 pictures into a panoramic scene.

- 1 Place the camera on a tripod or flat surface. Turn the Mode dial to Panorama .
- 2 Press  to highlight Panorama Left-Right or Panorama Right-Left (depending on the direction you want to pan), then press the OK button.
- 3 Take the first picture.
After a quickview, the LCD displays the liveview and an “overlay” from the first picture.
- 4 Compose the second picture. Make the overlay from the first picture cover the same portion in the new picture. (You can press the Delete button to delete all pictures and re-take them.)
- 5 If you are taking only 2 pictures, press the OK button to stitch them together.
After you take 3 pictures, the pictures are automatically stitched together.

Take 2 or 3 pictures.



Get 1 panoramic picture.



NOTE: Individual pictures are not saved, even if panorama capture is cancelled before stitching occurs. (Picture size is set to 4.8 MP for each picture. Exposure Compensation, White Balance, Exposure Metering, AF Zone, AF Control, Color Mode, and Sharpness are set with the first picture. The flash is set to Off.) You can use the self-timer (2- and 10-second delays) while taking panoramic pictures. [See page 11.](#)

Understanding the picture-taking icons

Status icons indicate mode, feature, and camera status.

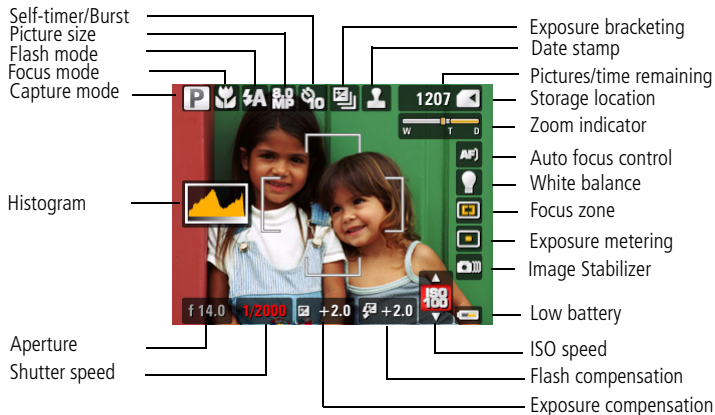

3

Working with pictures/videos

Reviewing pictures/videos

Press the Review button to view and work with your pictures/videos. Press Review again to exit.

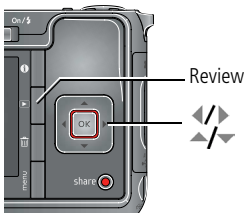

- 1 Press the Review button.
- 2 Press to view previous/next picture/video.

NOTE: Pictures taken at the 3:2 and 16:9 aspect ratios (see page 29) do not fill the LCD.

Magnifying a picture during review

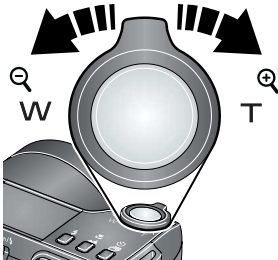



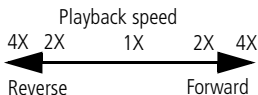

- magnify 2X - 8X
- view other parts of the picture
- OK return to 1X

NOTE: If you press the W button while at 1X, the view changes from single-picture to multi-up thumbnails. (See page 26.)

Playing a video



- 1 Press the Review button.
- 2 Press  to locate previous/next video.
- 3 Press  to play a video.
 - Press  to adjust the volume.
 - Press OK to pause/unpause.
 - Press  during playback to play at 2X speed; press again for 4X.
 - Press  during playback to reverse at 2X speed; press again for 4X.

Viewing picture/video information

- 1 Press the Review button.
- 2 Repeatedly press the Info  button to turn on/off status icons and picture/video info.

Deleting pictures/videos



- 1 Press the Review button.
- 2 Press  to find a picture/video.
- 3 Press the Delete button.
- 4 Follow the screen prompts.

Using the undo delete feature

If you accidentally delete a picture/video, use Undo Delete to retrieve it. This feature is available only immediately after you delete a picture/video in Review mode (when the Undo Delete option appears).

- 1 Press  to highlight Undo Delete.
- 2 Press OK.
The deleted picture/video appears.
- 3 Select Exit to exit the Delete menu.

Protecting pictures/videos from deletion







- 1 Press the Review button.
- 2 Press  to find a picture/video.
- 3 Press the Menu button.
- 4 Press  to highlight Protect, then press OK.
The Protect icon  appears with the protected picture/video.
 - Press the Menu button to exit the menu.



CAUTION:

Formatting internal memory or an SD or SDHC card deletes all (including protected) pictures/videos. (Formatting internal memory also deletes email addresses and tag names.)

Using the menu button in Review

- 1 Press the Review button, then the Menu button.
- 2 Press   to choose a tab:
 -  **Review** to view pictures/videos
 -  **Edit** to edit pictures/videos
 -  **Setup** for other camera settings
- 3 Press   to highlight a setting, then press the OK button.
- 4 Choose an option, then press the OK button.

Adding sound tags

You can record a voice or sound (up to 1 minute long) to a picture.

NOTE: Only one sound tag can be added to each picture (not to videos).

Recording a sound tag

- 1 Press the Review button, then ◀/▶ to find a picture.
- 2 Press the Menu button, then ◀/▶ to highlight the Edit tab.
- 3 Choose Sound Tag, then press OK.
- 4 Choose Record, then press OK. Follow the screen prompts.

The sound tag is applied to your picture.

- Press the Menu button to exit the menu.

Playing a sound tag

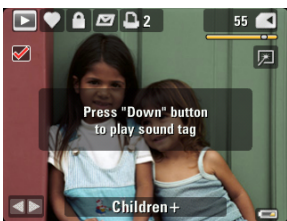

- 1 Press the Review button, then ◀/▶ to find a sound-tagged picture.
- 2 Press ▼ to play the sound tag.
- 3 Press ▲/▼ to adjust the volume.
- 4 Press OK to stop playback.

Cropping pictures

You can crop a picture so that only the desired portion of the picture remains. (You cannot crop these pictures: panoramic, video action prints, pictures from a video, or pictures that are already cropped.)

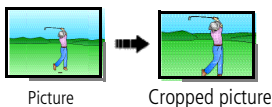

- 1 Press the Review button, then ◀/▶ to find a picture.
- 2 Press the Menu button, then ◀/▶ to highlight the Edit tab.
- 3 Press ▲/▼ to highlight Crop. Press the OK button.
- 4 Press Telephoto (T) to zoom in, or ◀/▶ ▲/▼ to move the crop box. Press OK.
- 5 Follow the screen prompts.

The picture is cropped. The original is saved. (Cropped pictures cannot be cropped again.)

- Press the Menu button to exit the menu.

Using Kodak Perfect Touch technology

Kodak Perfect Touch technology helps ensure better, brighter pictures.

- 1 Press the Review button, then ◀/▶ to find a picture.
- 2 Press the Menu button, then ◀/▶ to highlight the Edit tab.
- 3 Press ▲/▼ to highlight Perfect Touch tech. Press the OK button.

The enhancement is previewed in a split screen. Press ◀/▶ to view other parts of the picture.

- 4 Press OK. Follow the screen prompts to replace the original picture or to save the enhanced picture as a new one.

NOTE: You cannot enhance previously enhanced or panorama pictures, or videos.

- Press the Menu button to exit the menu.

Editing videos

Making a picture from a video

You can choose a single frame from a video, then make a picture suitable for printing.

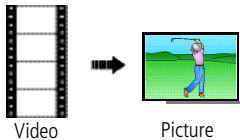

- 1 Press the Review button, then ◀/▶ to find a video.
- 2 Press the Menu button, then ◀/▶ to highlight the Edit tab.
- 3 Press ▲/▼ to highlight Make Picture, then press the OK button.
- 4 Press ▼ to play the video. (Press the OK button to pause). Press ◀/▶ to navigate through video frames.
- 5 Press OK to select a video frame, then press ▼.
- 6 Follow the screen prompts.

A picture is created. (The original video is saved.)

- Press the Menu button to exit the menu.

Trimming a video

You can delete an unwanted portion from the beginning or end of a video.

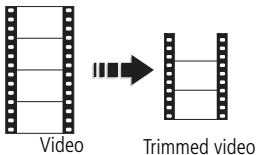

- 1 Press the Review button, then ◀/▶ to find a video.
- 2 Press the Menu button, then ◀/▶ to highlight the Edit tab.
- 3 Press ▲/▼ to highlight Trim. Press the OK button.
- 4 Follow the screen prompts.

The video is trimmed. (You can save it as a new video or replace the original.)

- Press the Menu button to exit the menu.

Using video bookmarks

You can set bookmarks at interesting places in your video, then jump from one bookmark to another.

Setting bookmarks

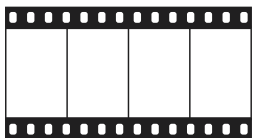

- 1 Press the Review button, then ◀/▶ to find a video.
- 2 Press the Menu button, then ◀/▶ to choose the Edit tab. Choose Bookmark, then press OK.
- 3 Press ▼ to add bookmarks. When finished adding up to 9 bookmarks, press ▲.
 - Press the Menu button to exit the menu.

Using bookmarks

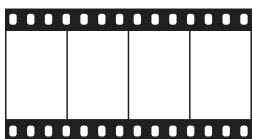

- 1 Press the Review button, then ◀/▶ to find a video.
- 2 Press ▼ to play the video. To jump to the first bookmark, press and hold ◀/▶ for 4 seconds while the video is playing.
 - After you jump to a bookmark, press ◀/▶ to jump to other bookmarks.
 - To view all bookmarked video frames, press the Zoom wide angle (W) button. To return to normal view, press the telephoto (T) button.

Making a video action print

From a video, you can make a 4-, 9-, or 16-up picture, suitable for a 4 x 6-inch (10 x 15 cm) print.

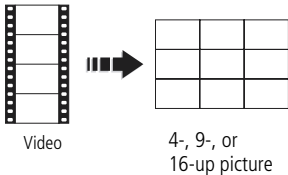

- 1 Press the Review button, then ◀/▶ to find a video.
- 2 Press the Menu button, then ◀/▶ to highlight the Edit tab.
- 3 Press ▲/▼ to highlight Action Print. Press the OK button. Choose an option, then press the OK button:

- Auto options: The camera includes the first and last frames, then 2, 7, or 14 equally spaced frames.
- Manual: You choose the first and last frames; the camera chooses 2, 7, or 14 equally spaced frames.
- Use Bookmarks: Bookmarked frames are used.
A 4-, 9-, or 16-up picture is created. If you have less than 4 or 9 bookmarks, equally-spaced video frames are used.
- Press the Menu button to exit the menu.

Running a slide show

Use Slide Show to display your pictures/videos on the LCD.

Starting the slide show

- 1 Press the Review button, then the Menu button.
- 2 Press ▲/▼ to highlight Slide Show, then press the OK button.
- 3 Press ▲/▼ to highlight Begin Show, then press the OK button.

The slide show begins.

To interrupt the Slide Show, press the OK button.

Changing the slide show display interval

You can set the display interval from 3–60 seconds.

- 1 On the Slide Show menu, press ▲/▼ to highlight Interval, then press the OK button.
- 2 Select a display interval. To scroll through the seconds quickly, press and hold ▲/▼.
- 3 Press the OK button.

The interval setting remains until you change it.

Running a continuous slide show loop

When you turn on Loop, the slide show is continuously repeated.

- 1 On the Slide Show menu, press ▲/▼ to highlight Loop, then press the OK button.
- 2 Press ▲/▼ to highlight On, then press the OK button.
- 3 Press ▲/▼ to highlight Begin Show, then press the OK button.

The slide show repeats until you press the OK button or battery power is exhausted.

Running a multimedia slide show

Multimedia Slide Show is similar to Slide Show, but also offers music and visual effects. First, select 2-20 pictures (see [page 27](#)). Then:

- 1 Press the Review button.
- 2 Press the Menu button, then ◀/▶ to highlight the Review ► tab. Highlight Multimedia Slide Show, then press the OK button.
- 3 Press ▲/▼ to highlight a choice (Begin Show, Music, Effect, Play Order), then press the OK button.

Each picture is displayed once. To interrupt the slide show, press the OK button. After the slide show plays, you may save or modify it.

Displaying pictures/videos on a television

You can display pictures/videos on a television, computer monitor, or any device equipped with a video input. To connect the camera to a television, use an A/V cable (may be sold separately).

For a true HDTV experience on your television, dock your camera on the Kodak EasyShare HDTV dock. Visit www.kodak.com/go/hdtvdock.

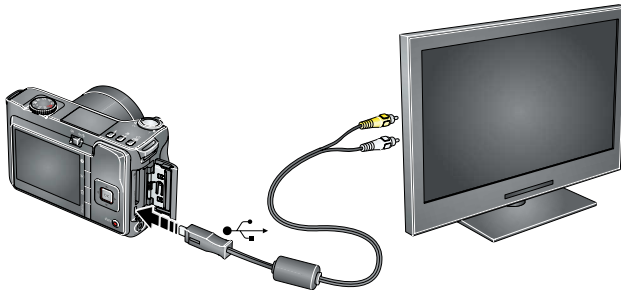

For more on high definition, visit www.kodak.com/go/hdsysreq.





Viewing pictures/videos in different ways

Viewing as thumbnails (multi-up)

- 1 Press the Review button.
- 2 Press the Zoom Wide Angle (W) button to change from single-picture view to multi-up thumbnails.
- 3 Press Telephoto (T) to return to single-picture view.
 - To select multiple pictures/videos, see [page 27](#).
 - Press the Review button to exit Review.

Searching pictures by date, favorites, or other tag

If you have many pictures on your camera or card, you can sort them so that only some are visible at a time. You can sort by the date a picture was taken or—if you've tagged pictures with a favorites tag or a tag that you created—you can sort by tag.

- 1 Press the Review button, then the Menu button.
- 2 Press  to highlight Search, then press OK.
- 3 Press  to highlight the Date, Favorite, or Tag tab, then  to select a folder.
- 4 Press  to highlight a folder, then press OK. (If you chose a Month/Year folder, press OK to see the Day folders.) When you are finished choosing tabs and folders, highlight Exit and press OK.
- 5 To see the results of your search, highlight Save, then press OK.

Pictures are displayed in multi-up view. Press  to view them. Press the Telephoto (T) button to view the picture full-screen. Press the Wide Angle (W) button to return to multi-up view.

- Press the Review button to exit Review. (The search is discarded.)
- For more about tags, see [page 38](#).
- To select multiple pictures/videos, see [page 27](#).

Selecting multiple pictures/videos

Use the multi-select feature when you have two or more pictures/videos to print, copy, or delete. (Multi-select can also be used in Multi-Up mode, [page 26](#).)

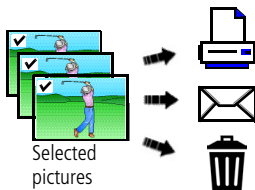

- 1 Press the Review button, then ◀/▶ to find a picture/video.
- 2 Press the OK button to select pictures/videos. Repeat Steps 1 and 2 until the desired pictures/videos are selected.

A check mark appears on the picture. You can now print, copy, or delete the selected pictures. You can press OK a second time to remove a check mark.

Copying pictures/videos

You can copy pictures/videos from a card to internal memory or from internal memory to a card.

NOTE: Before you copy, make sure that a card is inserted in the camera.

Copy pictures/videos:

- 1 Press the Review button, then the Menu button.
- 2 Press ▲/▼ to highlight Copy, then press the OK button.
- 3 Press ▲/▼ to highlight an option.
- 4 Press the OK button.

NOTE: Pictures/videos are copied, not moved. To remove pictures/videos from the original location after copying, delete them (see [page 17](#)).

Protection settings are not copied. To apply protection to a picture/video, see [page 17](#).

Understanding the review icons

Pictures

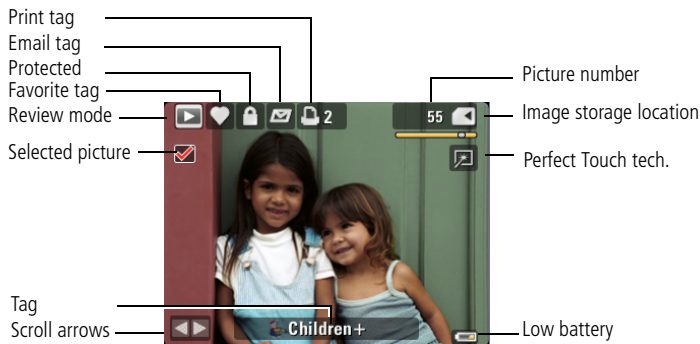

Videos



4

Doing more with your camera

Using the Menu button to change settings

NOTE: Some settings remain until you change them; others remain until you turn off the camera.





- 1 Press the Menu button.
- 2 Press **◀/▶** to highlight a menu tab:
 - **Capture** for the most common picture-taking settings.
 - **Capture +** for other picture-taking settings. Available only in PASM and Panorama modes.
 - **Setup** for other camera settings.
- 3 Press **▲/▼** to highlight a setting, then press the OK button.
- 4 Choose an option, then press the OK button.

NOTE: Press the Info button **i** for information about camera settings and options. Some capture modes offer limited settings.

Press Menu, ◀/▶ , ▲/▼ , and OK to access settings	Capture Options
Picture Size Choose a picture resolution.	8.0 MP (4:3) —Highest resolution, largest file size 7.1 MP (3:2) —For EasyShare printer docks, photo printers 6.0 MP (16:9) —HDTV format 5.0 MP (4:3) —Medium resolution and file size 3.1 MP (4:3) —Smaller resolution and file size 2.2 MP (3:2) —For EasyShare printer docks, photo printers 2.1 MP (16:9) —HDTV format 1.2 MP (4:3) —For emailing, Internet, or conserving space

Press Menu, $\blacktriangleleft/\blacktriangleright$, $\blacktriangle/\blacktriangledown$, and OK to access settings	Capture Options
Video Size Available only in Video mode.	VGA 640 x 480 —higher quality, larger file size (80-min. maximum video) QVGA 320 x 240 —lower quality, smaller file size (80-min. maximum video)
Color Mode Choose color tones.	High Color Natural Color Low Color Black & White Sepia NOTE: EasyShare software also lets you change a color picture to black-and-white or sepia. Unavailable in Video mode.
AF Control Choose an auto-focus setting. Available only in SCN, PASM, and Video modes.	Continuous AF —because the camera is always focusing, there is no need to press the Shutter button halfway down to focus. Single AF —uses TTL-AF (through-the-lens auto focus) when the Shutter button is pressed halfway down.

Using the Capture + menu

<p>Press Menu, , , , , and OK to access settings</p>	<p>Capture + Options (Available only in PASM and Panorama modes.)</p>
<p>White Balance Choose your lighting condition. Available only in PASM and Panorama modes.</p>	<p>Auto—automatically corrects white balance. Ideal for general picture taking. Daylight—for pictures in natural lighting. Tungsten—corrects the orange cast of household light bulbs. Ideal for indoor pictures under tungsten or halogen lighting without flash. Fluorescent—corrects the green cast of fluorescent lighting. Ideal for indoor pictures under fluorescent lighting without flash. Open Shade—for pictures in shade in natural lighting.</p>
<p>Exposure Metering Evaluate light levels at specific areas of a scene. Available only in PASM and Panorama modes.</p>	<p>Multi-pattern—evaluates lighting conditions throughout the image to give an optimum picture exposure. Ideal for general picture taking. Center-weighted—evaluates the lighting conditions of the subject centered in the LCD. Ideal for backlit subjects. Center-Spot—similar to Center-weighted, except the metering is concentrated on a smaller area of the subject centered in the LCD.</p>
<p>Sharpness Control picture sharpness. Available only in PASM and Panorama modes.</p>	<p>High Normal Low</p>

<p>Press Menu, $\blacktriangleleft/\blacktriangleright$, $\blacktriangleup/\blacktriangledown$, and OK to access settings</p>	<p>Capture + Options (Available only in PASM and Panorama modes.)</p>
<p>AF Zone Select a large or concentrated area of focus. Available only in PASM and Panorama modes.</p>	<p>Multi-zone—evaluates 5 zones to give an even picture focus. Ideal for general picture taking. Center-zone—evaluates the small area centered in the LCD. Ideal when precise focus of a specific area in the picture is needed.</p>
<p>Exposure Bracketing Interval Choose the difference in exposure compensation while using exposure bracketing. Available only in PASM mode.</p>	<p>Off +/- 0.3 EV +/- 0.7 EV +/- 1.0 EV See page 37.</p>

Using the Setup menu

<p>Press Menu, $\blacktriangleleft/\blacktriangleright$, $\blacktriangleup/\blacktriangledown$, and OK to access settings</p>	<p>Setup Options</p>
<p>LCD Brightness</p>	<p>1, 2, 3, 4, 5</p>
<p>Image Storage Choose a storage location for pictures/videos.</p>	<p>Auto—the camera uses the card if one is in the camera. If not, the camera uses internal memory. Internal Memory—the camera uses internal memory, even if a card is installed.</p>
<p>Quickview Show a picture/video as soon as it is taken.</p>	<p>On Off</p>
<p>Date Stamp Imprint the date on pictures.</p>	<p>Choose a date option, or turn off the feature.</p>

Press Menu, ◀/▶, ▲/▼, and OK to access settings	Setup Options
<p>Set Tag Assign tag names to pictures/videos. Select tag name(s) before you take pictures or videos. Then, new pictures/videos are assigned that tag name(s).</p>	<p>Clear All Add Tag Delete Tag Exit Tag Name 1 Tag Name 2 See page 41.</p>
<p>Capture Frame Grid Use the frame grid to divide the LCD screen into thirds, vertically and horizontally.</p>	<p>On Off</p>
<p>Red-eye Pre-flash Choose if the Red-eye flash fires automatically before a picture is taken. NOTE: The camera automatically corrects red-eye when the Red-eye Pre-flash is set to Off.</p>	<p>On Off</p>
<p>Image Stabilizer Choose how image stabilization occurs.</p>	<p>Continuous—Image stabilization occurs continuously. Single—Image stabilization occurs when the Shutter button is pressed halfway down. Off—Image stabilization is off.</p>
<p>Camera Sounds Choose sound effects.</p>	<p>Theme—applies the same sound effect set to all functions. Individual—choose a sound effect for each function.</p>
<p>Date & Time</p>	<p>Choose date/time format; set date/time.</p>
<p>Language</p>	<p>Choose a language.</p>

Press Menu, ◀/▶, ▲/▼, and OK to access settings	Setup Options
<p>Advanced Digital Zoom Zoom using optical, then digital zoom.</p>	<p>Continuous—Zooming is continuous between optical and digital zoom. Pause—Zooming pauses at the optical zoom maximum. To use digital zoom, release then press the Telephoto (T) zoom button. None—Digital zoom is off.</p>
<p>Orientation Sensor Orient pictures so that they are displayed with the correct side up.</p>	<p>For pictures—On, On Transfer, Off For video—On, off.</p>
<p>Sound Volume</p>	<p>Off, Low, Medium, High</p>
<p>Auto Power Off Choose inactivity time until camera turns off.</p>	<p>10 minutes 5 minutes 3 minutes 1 minute</p>
<p>Video Out Choose the regional setting for connecting to a television or other external device.</p>	<p>NTSC—used in North America and Japan. PAL—used in Europe and China.</p>
<p>Reset Camera</p>	<p>Reset settings to their defaults.</p>
<p>Format</p> <p> CAUTION: Formatting deletes all pictures/videos, including those that are protected.</p>	<p>Memory Card—deletes everything on the card; formats the card. Cancel—exits without making a change. Internal Memory—deletes everything in internal memory including email addresses, tag names, and favorites; formats the internal memory.</p>
<p>About View camera information.</p>	

Using the framing grid to compose a picture

The framing grid divides the LCD into thirds—vertically and horizontally. This is helpful if, for example, you want to balance a picture between water, earth, and sky. To turn on/off the framing grid, [see page 33](#).

Using PASM modes

Use PASM modes when you want more control over your camera and pictures.

Mode	When to use	Press to control
P Program	Program mode offers the ease of auto shooting with full access to all menu options. The camera automatically sets the shutter speed and aperture (f-stop) based on the scene lighting.	Exposure compensation (how much light enters the camera), flash compensation, and ISO speed
A Aperture Priority	Use Aperture Priority mode to control depth of field (the range of sharpness). The aperture setting may be affected by optical zoom.	Aperture, exposure compensation, flash compensation, and ISO speed
S Shutter Priority	Shutter Priority mode is primarily used to prevent blur when your subject is moving. The camera automatically sets the aperture for proper exposure. (To prevent blur, use a tripod for slow shutter speeds.)	Shutter speed, exposure compensation, flash compensation, and ISO speed
M Manual	Manual mode offers the highest level of creative control. (To prevent blur, use a tripod for slow shutter speeds.)	Aperture, shutter speed, flash compensation, and ISO speed

NOTE: Settings you change in P, A, S, or M modes apply only to pictures taken in those modes. The settings, including Flash, are maintained for P, A, S, and M modes—even when you change modes or turn off the camera. Use Reset Camera ([see page 34](#)) to reset P, A, S, or M mode to its default setting.

Changing P, A, S, or M mode settings

PASM modes control the aperture (f-number, also known as f-stop), shutter speed, exposure compensation, flash compensation, and ISO. Use the Menu button to control all other settings.

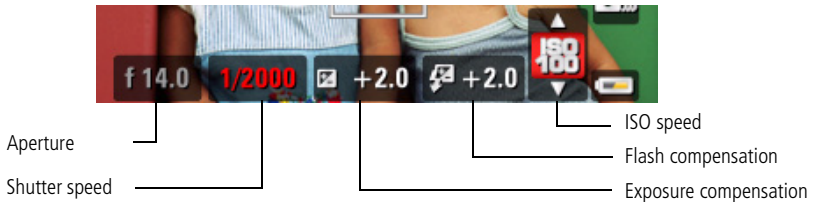

- 1 Turn the Mode dial to P, A, S, or M.
- 2 Press to access available settings:

Aperture—(also known as f-stop) control the size of the lens opening, which determines the depth of field.

- Smaller f-stop numbers indicate a larger lens opening; good for low-light.
- Larger f-stop numbers indicate a smaller lens opening; keeps the main subject sharp; good for landscapes and well-lit conditions.

Shutter speed—control how long the shutter stays open. A shaking hand icon warns of slow shutter speeds. (Use a tripod for slow shutter speeds.)

Exposure Compensation—adjust the exposure. If the picture is too light, decrease the setting; if it's too dark, increase the setting.

Flash Compensation—adjust flash brightness.

ISO—adjust the camera's sensitivity to light. Higher ISO indicates greater sensitivity.

NOTE: A higher ISO may produce unwanted "noise" in a picture. ISO 3200 available only in 2.2 and lower picture sizes.

Using exposure compensation to adjust brightness

In P and Panorama modes, you can adjust exposure compensation before you take a picture to make your pictures darker or lighter. Only the first picture in Panorama mode can be adjusted—that adjustment is applied to the remaining pictures.

- 1 Press ▼ to decrease exposure compensation.
- 2 Press ▲ to increase exposure compensation.

An exposure compensation level is shown on the LCD and the image gets darker or lighter.

- 3 Take the picture when you are satisfied with the exposure compensation level.

Using exposure compensation with exposure bracketing

In PASM modes, you can use exposure compensation in conjunction with exposure bracketing to get the best exposure.

If the exposure compensation is set to:	And if the exposure bracketing interval is set to 0.3 steps:	Then the exposures taken are:
0.0		-0.3, 0.0, +0.3
+1.0	Set the Exposure bracketing in the Setup menu.	+0.7, +1.0, +1.3
-1.0		-1.3, -1.0, -0.7

Using the histogram to view picture brightness

Use the histogram to evaluate the distribution of light before or after you take a picture. Optimal exposure is achieved when the peak is in the middle of the histogram. The flash may affect a picture's light and shadow. To turn on the histogram in Capture mode or in Review, press the Info ⓘ button until the histogram appears.

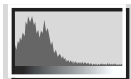

Dark picture



Balanced picture

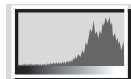













Bright picture

Sharing your pictures

Press the Share button to tag your pictures and videos. When they are transferred to your computer, you can share them. Use the Share button:

- Any time. (The most recent picture/video taken is then displayed.)
- After pressing the Review button.

Tagging pictures for printing

- 1 Press the Share button. Press   to locate a picture.
- 2 Press   to highlight Print , then press the OK button.*
- 3 Press   to select the number of copies (0-99).
Optional: You can apply a print quantity to other pictures with the print quantity screen displayed. Press   to locate a picture. Press   to change the print quantity. Repeat until the desired print quantity is applied to pictures.
- 4 Press the OK button.
The Print icon  appears in the status area.
- 5 Press the Share button to exit the menu.

* To remove print tagging for all pictures in the storage location, highlight Cancel Prints, then press the OK button.

Printing tagged pictures

When you transfer the tagged pictures to your computer, the Kodak EasyShare software print screen opens. For details, click the Help button in EasyShare software.

For more information on printing from your computer, printer dock, PictBridge enabled printer, or card, see [page 44](#).

NOTE: For the best 4 x 6 in. (10 x 15 cm) prints, set the camera to a 3:2 picture size. (See [page 29](#).)

Tagging pictures/videos for emailing

First—on your computer

Use the on-screen keyboard to create an email address.

Second—tag pictures/videos on your camera

- 1 Press the Share button. Press ◀/▶ to find a picture/video.
- 2 Press ▲/▼ to highlight Email, then press the OK button.
- 3 Press ▲/▼ to highlight an email address, then press the OK button.

To tag other pictures/videos with the same address, press ◀/▶ to scroll through them. When the picture you want is displayed, press the OK button.

To send the pictures/videos to more than one address, repeat step 3.

Selected addresses are checked.

To remove a selection, highlight a checked address and press the OK button. To remove all email selections, highlight Clear All.

- 4 Press ▲/▼ to highlight Exit, then press the OK button.

The Email icon  appears in the status area.

- 5 Press the Share button to exit the menu.

NOTE: To add an email address, use the Add Email menu choice. Then use the on-camera keyboard.

Third—transfer and email

When you transfer the tagged pictures/videos to your computer, EasyShare software prompts you to send the pictures/videos. For details, see Help in EasyShare software.

Tagging pictures as favorites

Want to keep copies of your favorite pictures on your camera?

-
- | | |
|-------------------------------------|---|
| 1. Tag pictures as favorites | 1 Press the Review button. Press ◀/▶ to find a picture. |
| | 2 Press the Menu button, highlight Favorite, then press the OK button. |
- The Favorite icon ♥ appears in the status area. To remove the tag, press the OK button again.*

-
- | | |
|---|---|
| 2. View favorites on your camera | 1 Press the Review button, then the Menu button. |
| | 2 Use the Search feature. |
-

Printing and emailing favorites

- 1 Press the Review button, then ◀/▶ to find a picture.
- 2 Press the Menu button.
- 3 Highlight Print or Email, then press the OK button.

Tagging pictures/videos

Use the Tag feature to create tag names and assign them to pictures/videos.

First—create tags names

- 1 Press the Review button. Press ◀/▶ to find a picture/video.
- 2 Press the Menu button. Press ▲/▼ to highlight Tag, then press the OK button.
- 3 Press ▲/▼ to highlight Add Tag, then press the OK button.
- 4 Use the on-screen keyboard to create a tag name.

Second—assign tags

- 1 Press the Review button, then find a picture/video.
- 2 Press the Menu button.
- 3 Press ▲/▼ to highlight Tag, then press the OK button.
- 4 Press ▲/▼ to highlight a Tag name, then press the OK button.

To tag other pictures, press ◀/▶ to scroll through the pictures. When the desired picture is displayed, press the OK button.

The tag name appears with the picture. A plus (+) means the picture has more than one tag.

Third—transfer to your computer

When you transfer the tagged pictures/videos to your computer, EasyShare software opens and categorizes your pictures/videos with the appropriate tags.

Pre-tagging

Use the Set Tag feature to pre-select tag names before you take pictures/videos. Then, all the pictures/videos you take are tagged with those tag names.

5

Transferring and printing pictures

Installing the software



CAUTION:

Install EasyShare software *before* connecting the camera to the computer. Failure to do so may cause the software to load incorrectly.

- 1 Close all software applications that are open on your computer (including anti-virus software).
- 2 Place the EasyShare software CD into the CD-ROM drive.
- 3 Load the software:

Windows OS—if the install window does not appear, choose Run from the Start menu and type **d:\setup.exe** where **d** is the drive letter that contains the CD.

Mac OS X—double-click the CD icon on the desktop, then click the Install icon.

- 4 Follow the on-screen instructions to install the software.

NOTE: When prompted, take few minutes to electronically register your camera and software. To register later, see www.kodak.com/go/register.

- 5 If prompted, restart the computer. If you turned off anti-virus software, turn it back on. See the anti-virus software manual for details.

For software help, click the Help button in EasyShare software.

Transferring pictures with the USB cable

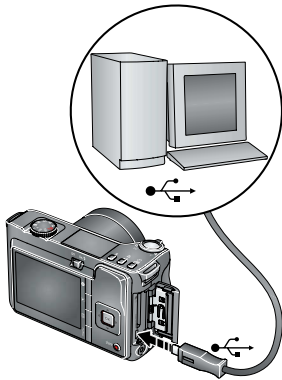

- 1 Turn off the camera.
- 2 Connect the USB cable (U-8).
- 3 Turn on the camera.

Kodak EasyShare software opens on your computer and prompts you through the transfer process.

NOTE: Visit www.kodak.com/go/howto for an online tutorial on connecting.

Also available for transferring

You can also use a Kodak EasyShare camera dock or printer dock (see [page 44](#)) to transfer your pictures and videos. Purchase these and other accessories at a dealer of Kodak products or www.kodak.com/go/z8612accessories.

Printing pictures

Printing with a Kodak EasyShare printer or printer dock

Kodak EasyShare all-in-one printer—Connect your camera to a Kodak EasyShare all-in-one printer and print directly—with or without a computer.

Kodak EasyShare printer dock—Dock your camera to the Kodak EasyShare printer dock and print directly—with or without a computer.

Purchase this and other accessories at a dealer of Kodak products or visit www.kodak.com/go/z8612accessories.

Direct printing with an EasyShare all-in-one printer

Your camera is compatible with PictBridge technology, so you can print directly to PictBridge enabled printers. You need:

- Camera with fully charged batteries
- PictBridge enabled printer
- USB cable (may be sold separately)

Connecting the camera to an EasyShare all-in-one printer

- 1 Turn off the camera and printer.
- 2 Connect the appropriate USB cable from the camera to the printer. (See your printer user guide or visit www.kodak.com/go/z8612accessories.)

Printing from an EasyShare all-in-one printer

- 1 Turn on the printer. Turn on the camera.

The PictBridge logo is displayed, followed by the current picture and menu. (If no pictures are found, a message is displayed.) If the menu interface turns off, press any button to redisplay it.

- 2 Press **▲/▼** to choose a printing option, then press the OK button.

Current Picture—Press **◀/▶** to choose a picture. Choose the number of copies.

Print Tagged—If your printer is capable, print pictures that you tagged for printing and choose a print size.

Index Print—Print thumbnails of all pictures. This option requires one or more sheets of paper. If the printer is capable, choose a print size.

All Pictures—Print all pictures in internal memory, on a card, or in Favorites. Choose the number of copies.

Image Storage—Access internal memory, a card, or Favorites.

NOTE: During direct printing, pictures are not permanently transferred or saved to the computer or printer.

Disconnecting the camera from an EasyShare all-in-one printer

- 1 Turn off the camera and printer.
- 2 Disconnect the USB cable from the camera and the printer.

Using a printer that is not PictBridge enabled

For details on printing pictures from your computer, click the Help button in EasyShare software.

Ordering prints online

Kodak Gallery (www.kodakgallery.com) is one of the many online print services offered in the Kodak EasyShare software. You can easily:

- Upload your pictures.
- Edit, enhance, and add borders to your pictures.
- Store pictures, and share them with family and friends.
- Order high-quality prints, photo greeting cards, frames, and albums—and have them delivered to your door.

Printing from an optional SD/SDHC card

- Automatically print tagged pictures when you insert your card into a printer with an SD/SDHC card slot. See your printer user's guide for details.
- Make prints at an SD/SDHC card-capable Kodak picture maker/picture kiosk. (Contact a location prior to visiting. See www.kodak.com/go/picturemaker.)
- Take the card to your local photo retailer for professional printing.

Dock compatibility for your camera

To see which EasyShare printer docks are compatible with your camera, visit www.kodak.com/go/dockcompatibility.

Purchase camera docks, printer docks, and other accessories at a dealer of Kodak products or www.kodak.com/go/z8612accessories.

6

Troubleshooting

For step-by-step product support, visit www.kodak.com/go/z8612support and select Interactive Troubleshooting & Repairs.

Camera problems

If	Try one or more of the following
Camera does not turn on.	<ul style="list-style-type: none">■ Install new batteries (see page 1).■ Charge rechargeable batteries.
Camera does not turn off.	<ul style="list-style-type: none">■ Remove the battery, then reinsert or replace it. If the camera still does not function, visit www.kodak.com/go/z8612support and select Interactive Troubleshooting & Repairs.
Flash is not open.	<ul style="list-style-type: none">■ If the camera is on but the flash is closed, move the On/Off button to On again. After you turn off the camera, close the flash.
Pictures remaining number does not decrease after taking a picture.	<ul style="list-style-type: none">■ The camera is operating normally. Continue taking pictures.
Stored pictures are corrupted.	<ul style="list-style-type: none">■ Retake pictures. Do not insert or remove card while the camera is on. Keep rechargeable batteries charged.■ Transfer the pictures to the computer (see page 43), then format the card or internal memory (see page 34).■ Caution: Formatting a card deletes all pictures and videos, including protected files.
In Review mode, you do not see a picture (or the expected picture) on the LCD screen.	<ul style="list-style-type: none">■ Check the image storage location setting (see page 32).■ When taking pictures, make sure that the Shutter button is pressed completely down.■ If problem persists, visit www.kodak.com/go/z8612support and select Interactive Troubleshooting and Repairs.

If	Try one or more of the following
In Review mode, a blue or black screen is displayed instead of a picture.	<ul style="list-style-type: none"> ■ Transfer the picture to the computer (see page 43), then format the card or internal memory (see page 34). <p>Caution: Formatting a card deletes all pictures and videos, including protected files.</p> <ul style="list-style-type: none"> ■ Take another picture. If screen is still blue or black, visit www.kodak.com/go/z8612support and select Interactive Troubleshooting and Repairs.
Shutter button does not work.	<ul style="list-style-type: none"> ■ Turn on the camera (see page 2). ■ Wait until the Image Storage icon stops blinking red before attempting to take another picture. ■ Transfer pictures to the computer (see page 43), delete pictures from the camera (page 17), switch image storage locations (see page 32), or insert a card with available memory (page 3). ■ If problem persists, visit www.kodak.com/go/z8612support and select Interactive Troubleshooting and Repairs.
Slide show does not run on external video device.	<ul style="list-style-type: none"> ■ Adjust the camera Video Out setting (NTSC or PAL, see page 34). ■ See the external device's user's guide.
Picture is too light.	<ul style="list-style-type: none"> ■ When using the flash, move so there is at least 2 ft (0.6 m) between the camera and the subject. ■ Decrease Exposure Compensation (see page 37).
Picture is not clear.	<ul style="list-style-type: none"> ■ Clean the lens (see page 59). ■ Make sure your camera is not in Close-up mode. ■ Move so there is at least 2 ft (0.6 m) between the camera and the subject. ■ Place the camera on a flat, steady surface or use a tripod.

If	Try one or more of the following
Picture is too dark.	<ul style="list-style-type: none"> ■ Turn on the flash (see page 9). ■ Move so there is no more than 25.6 ft (7.8 m) in wide angle and 14.4 ft (4.4 m) in telephoto between the camera and the subject. ■ Use Fill flash (see page 9) or change your position so light is not behind the subject. ■ Increase Exposure Compensation (see page 37).
Camera does not recognize SD/SDHC card.	<ul style="list-style-type: none"> ■ Purchase a certified SD/SDHC card. ■ Format the card in the camera (see page 34). <p>Caution: Formatting a card deletes all pictures and videos, including protected files.</p> <ul style="list-style-type: none"> ■ Insert a card into the slot, then push to seat (see page 3).
Camera freezes up when a card is inserted or removed.	<ul style="list-style-type: none"> ■ Turn the camera off, then back on. Make sure the camera is turned off before inserting or removing a card. ■ Try another SD/SDHC card.
Memory card full.	<ul style="list-style-type: none"> ■ Insert a new card (see page 3), transfer pictures to the computer (see page 43), or delete pictures (see page 17).
Memory card and internal memory full.	<ul style="list-style-type: none"> ■ Transfer pictures to the computer (see page 43), then format the card or internal memory (see page 34). <p>Caution: Formatting a card deletes all pictures and videos, including protected files.</p>

Camera/computer communications

If	Try one or more of the following
The computer does not communicate with the camera.	<ul style="list-style-type: none"> ■ Turn on the camera (see page 2). ■ Install new batteries (see page 1) or charge rechargeable batteries. ■ Connect cable to camera and computer port (see page 43). ■ Install the software (see page 42). ■ Disconnect the USB cable. Close all open applications. Re-install the software (see page 42). ■ Disconnect camera from the computer. Close all software applications, reconnect camera.
Cannot transfer pictures. (The Add New Hardware Wizard cannot locate drivers.)	<ul style="list-style-type: none"> ■ Disconnect USB cable. (If using camera dock or printer dock, disconnect cable and remove camera from dock). Close all open applications. Re-install the software (see page 42). ■ Disconnect the USB cable. Close all open applications. Re-install the software (see page 42). ■ Try another USB port, or another computer. ■ Try transferring pictures using a card reader.

LCD messages

If	Try one or more of the following
No images to display	<ul style="list-style-type: none"> ■ Change image storage location setting (see page 32).
Memory card requires formatting	<ul style="list-style-type: none"> ■ Insert a new card (see page 3) or format the card (see page 34). ■ Caution: Formatting a card deletes all pictures and videos, including protected files.
Memory card cannot be read (Please format memory card or insert another card)	
Only one USB connection allowed. Disconnect cable or rem. (remove) camera from dock.	<ul style="list-style-type: none"> ■ Unplug the USB cable from the camera.

If	Try one or more of the following
Internal memory requires formatting	<ul style="list-style-type: none"> ■ Format the internal memory (see page 34). <p>Caution: Formatting deletes all pictures and videos, including protected files. (Formatting internal memory also deletes email addresses, tag names, and Favorites. To restore them, see the Kodak EasyShare software Help.)</p>
Internal memory cannot be read (Please format internal memory)	
No memory card (Files not copied)	<ul style="list-style-type: none"> ■ Insert a card (see page 3).
Not enough space to copy files (Files not copied)	<ul style="list-style-type: none"> ■ Delete pictures from the image storage location you are copying to (see page 17), or insert a new card (see page 3).
Memory card is locked (Insert new memory card)	<ul style="list-style-type: none"> ■ Insert a new card (see page 3), move the switch on the card to unlock the card, or change the image storage location to internal memory (see page 32).
Memory card is unusable (Insert new memory card)	<ul style="list-style-type: none"> ■ Insert a new card (see page 3) or format the card (see page 34). <p>Caution: Formatting a card deletes all pictures and videos, including protected files.</p>
High camera temperature. (Camera will be turned off.)	<ul style="list-style-type: none"> ■ Leave the camera off for ten minutes, then turn it back on. If the message reappears, visit www.kodak.com/go/z8612support and select Interactive Troubleshooting & Repairs.
Can only mark image with 32 tag names. Only the first 32 tag names will be saved.	<ul style="list-style-type: none"> ■ Delete one or more tag names associated with the image (see page 41).
Unrecognized file format	<ul style="list-style-type: none"> ■ Transfer the picture to the computer (see page 43), or delete it (page 17).
Camera error #XXXX. See user's guide.	<ul style="list-style-type: none"> ■ Turn camera off, then back on. If the message reappears, visit www.kodak.com/go/z8612support and select Interactive Troubleshooting & Repairs.

7

Getting help

Helpful links

Camera

Email, write, or phone customer support	www.kodak.com/go/contact
Get support for your product (FAQs, arrange for repairs, troubleshooting information, etc.)	www.kodak.com/go/z8612support
Purchase camera accessories (camera docks, printer docks, lenses, cards, etc.)	www.kodak.com/go/z8612accessories
Download the latest camera firmware and software	www.kodak.com/go/z8612downloads
See online demonstrations of your camera	www.kodak.com/go/howto

Software

Get information on EasyShare software	www.kodak.com/go/easysharesw (or click the Help button in EasyShare software)
Get help with the Windows operating system and working with digital pictures	www.kodak.com/go/pcbasics

Other

Get support for other cameras, software, accessories	www.kodak.com/go/support
Get information on Kodak EasyShare printer docks	www.kodak.com/go/printerdocks
Get information on Kodak inkjet products	www.kodak.com/go/inkjet
Optimize your printer for truer, more vibrant colors	www.kodak.com/go/onetouch
Register your camera	www.kodak.com/go/register

NOTE: If you have questions concerning this product, you may speak with Kodak customer support.

Australia	1800 267 588	Netherlands	020 346 9372
Austria	0179 567 357	New Zealand	0800 880 120
Belgium	02 713 14 45	Norway	23 16 21 33
Brazil	0800 891 42 13	Philippines	1 800 1 888 9600
Canada	1 800 465 6325	Poland	00800 4411625
China	800 820 6027	Portugal	021 415 4125
Czech Republic	00 800 56325000	Russia	8 495 929 9166
Denmark	3 848 71 30	Singapore	800 6363 036
Ireland	01 407 3054	Slovakia	00 800 56325000
Finland	0800 1 17056	Spain	91 749 76 53
France	01 55 1740 77	Sweden	08 587 704 21
Germany	069 5007 0035	Switzerland	044 838 53 51
Greece	00800 44140775	Taiwan	0800 096 868
Hong Kong	800 901 514	Thailand	001 800 631 0017
Hungary	06 80 456 325	Turkey	00800 448827073
India	91 80 41374555 (toll free 000800 440 1227)	United Kingdom	0870 243 0270
Italy	02 696 33452	United States	1 800 235 6325
Japan	03 5540 9002	International Toll Line	+44 131 458 6714
Korea	080 708 5600	International Toll Fax	+44 131 458 6962

Camera specifications

For more specifications, visit www.kodak.com/go/z8612support.

CCD—1/2.5-type

Effective Pixels—3298 x 2472 (8.1 MP)

Lens—12X optical zoom lens, 36–432 mm (35 mm equivalent); f/2.8–f/4.8

Image stabilizer—Optical

Lens barrier—Lens cap

Digital zoom—5X continuous

Combined zoom—60X

Shutter speed—Mechanical shutter with CCD electronic; Smart Scene mode: 1/2–1/3200 sec.; P and M modes: 16-1/1000 sec.

Color display—6.4 cm (2.5 in) color hybrid LCD; 230 K (960 x 240) pixels

External storage—Optional SD/SDHC Card . (The SD logo is a trademark of the SD Card Association.)

Internal storage—32 MB (21 MB available for image storage. 1 MB equals one million bytes.)

Focus system—TTL-AF (through-the-lens auto focus); Multi-zone AF, Center-zone AF; working range:

Auto: 24 in. (60 cm)–infinity @ wide; 3.9 ft (1.2m)–infinity @ telephoto

Macro: 4.7–23.7 in. (12–60 cm) @ wide; 2–4.3 ft (0.6–1.3m) @ telephoto

AF Assist light—Yes

ISO speed—Auto: 64–1600

Selectable: 64, 100, 200, 400, 800, 1600, 3200 (ISO 3200 available only in 2.2 MP and lower picture size in PASM modes.)

Exposure metering—TTL-AE; Multi-pattern, Center-weighted, Center-spot

Exposure compensation—+/-2.0 EV with 1/3 EV steps

Flash compensation—Yes

Exposure bracketing—3 images with selectable +/- 1/3 EV steps

White balance—Auto, Daylight, Tungsten, Fluorescent, Open Shade

Electronic flash—Auto flash; Guide no. 11 @ ISO 100; working range: 1.6–25.6 ft (0.5–7.8m) @ wide; 3.9–14.4 ft (1.2–4.4 m) @ telephoto

Flash modes—Auto, Fill, Red-eye, Off

Capture modes—Smart Scene, PASM, High ISO, Panorama, SCN modes, Video

Drive modes—Single shot, first burst, last burst, self-timer (10-second, 2-shot, and 2-second)

File format—Still: JPEG/EXIF 2.21; Video: QuickTime, Motion JPEG

Output image size—8.0 MP (4:3): 3264 x 2448 pixels

7.1 MP (3:2): 3264 x 2176 pixels

6.0 MP (16:9): 3264 x 1840 pixels

5.0 MP (4:3): 2592 x 1944 pixels

3.1 MP (4:3): 2048 x 1536 pixels

2.2 MP (3:2): 1800 x 1200 pixels

2.1 MP (16:9): 1920 x 1080 pixels

1.2 MP (4:3): 1280 x 960 pixels

Color modes—High Color, Natural Color, Low Color, Black & White, Sepia

Sharpness—High, Normal, Low

Video size—VGA (640 x 480 @30 fps); QVGA (320 x 240 @30 fps)

Power—AA lithium (non-rechargeable; **not alkaline**); 1 Kodak lithium digital camera battery CRV3 (non-rechargeable); 1 Kodak Li-Ion rechargeable digital camera battery KLIC-8000; 3V AC adapter; Kodak EasyShare docks

Burst mode—Maximum 4 pictures @ 1.7 fps; Auto Exposure, Auto Focus, Auto White Balance executed for first shot only

Self-timer—2 seconds, 10 seconds, or 2-shot

Communication with computer—USB 2.0 full speed (PIMA 15740 protocol) via USB cable model U-8; USB 2.0 full speed (PIMA 15740 protocol) via compatible EasyShare dock

Video output—NTSC or PAL selectable

PictBridge compatibility—Yes

Auto power off—Selectable 1, 3, 5, 10 minutes

Microphone—Yes

Speaker—Yes

Sound tag—Yes

Date stamp—Yes

Tripod mount—1/4 inch

Size—104 x 65.6 x 70.5 mm (4.1 x 2.6 x 2.8 in.) @ power off

Weight—290 g (10.2 oz) without battery or card

Operating temperature—32-104°F (0-40°C)

Storage capacities

The LCD displays the number of pictures (or minutes/seconds of video) remaining. For average SD card capacities, visit www.kodak.com/go/SDcapacities. Actual storage capacity varies depending on subject composition, card size, and other factors. You may be able to store more or fewer pictures and videos. Favorites take up additional space in internal memory.

Upgrading your software and firmware

Download the latest versions of the software included on the Kodak EasyShare software CD and the camera firmware (the software that runs on the camera). See www.kodak.com/go/z8612downloads.

Important safety instructions



CAUTION:

Do not disassemble this product; there are no user-serviceable parts inside. Refer servicing to qualified service personnel. Kodak AC adapters and battery chargers are intended for indoor use only. The use of controls, adjustments, or procedures other than those specified herein may result in exposure to shock and/or electrical or mechanical hazards. If the LCD breaks, do not touch the glass or liquid. Contact Kodak customer support.

- The use of an accessory that is not recommended by Kodak may cause fire, electric shock, or injury. For approved accessories, visit www.kodak.com/go/accessories.
- Use only a USB-certified computer equipped with a current-limiting motherboard. Contact your computer manufacturer if you have questions.
- If using this product in an airplane, observe all instructions of the airline.
- When removing the battery, allow it to cool; it may be hot.
- Follow all warnings and instructions supplied by the battery manufacturer.

- Use only batteries approved for this product to avoid risk of explosion.
- Keep batteries out of the reach of children.
- Do not allow batteries to touch metal objects, including coins. Otherwise, a battery may short circuit, discharge energy, become hot, or leak.
- Do not disassemble, install backward, or expose batteries to liquid, moisture, fire, or extreme temperature.
- Remove the battery when the product is stored for an extended period of time. In the unlikely event that battery fluid leaks inside the product, contact Kodak customer support.
- In the unlikely event that battery fluid leaks onto your skin, wash immediately with water and contact your local health provider. For additional health-related information, contact your local Kodak customer support.
- Dispose of batteries according to local and national regulations. Visit www.kodak.com/go/kes.
- Do not charge non-rechargeable batteries.
- For more information on batteries, see www.kodak.com/go/batterytupes.

Battery life

- Kodak Li-Ion rechargeable digital camera battery KLIC-8000: 275 pictures
- Kodak lithium digital camera battery CRV3 (non-rechargeable): 300 pictures
- AA lithium batteries: 200 pictures

Battery life per CIPA testing method (Approx. number of pictures). Actual life may vary based on usage.

Extending battery life

- Use power-saving features ([see page 34](#)).
- Limit activities that quickly deplete battery power (reviewing pictures on the camera, excessive use of the flash).

- Dirt on the battery contacts can affect battery life. Wipe the contacts with a clean, dry cloth before loading batteries in the camera.
- Battery performance is reduced at temperatures below 41° F (5° C). When using your camera in cold weather, carry spare batteries and keep them warm. Do not discard cold batteries that do not work; when they return to room temperature, they may be usable.

Care and maintenance

- If you suspect water has gotten inside the camera, remove the battery and card. Allow all components to air-dry for at least 24 hours before using the camera.
- Blow gently on the lens or LCD to remove dust and dirt. Wipe gently with a soft, lint-free cloth or an untreated lens-cleaning tissue. Do not use cleaning solutions unless designed specifically for camera lenses. Do not allow chemicals, such as suntan lotion, to contact painted surfaces.
- Service agreements may be available in your country. Contact a dealer of Kodak products for more information.
- For digital camera disposal or recycling information, contact your local authorities. In the US, visit the Electronics Industry Alliance Web site at www.eiae.org or the Kodak Web site at www.kodak.com/go/z8612support.

Limited warranty

Kodak warrants Kodak consumer electronic products and accessories ("Products"), excluding batteries, to be free from malfunctions and defects in both materials and workmanship for one year from the date of purchase. Retain the original dated sales receipt. Proof of the date of purchase will be required with any request for warranty repair.

Limited warranty coverage

Warranty service is only available from within the country where the Products were originally purchased. You may be required to ship Products, at your expense, to the authorized service facility for the country where the Products were purchased. Kodak

www.kodak.com/go/support

will repair or replace Products if they fail to function properly during the warranty period, subject to any conditions and/or limitations stated herein. Warranty service will include all labor as well as any necessary adjustments and/or replacement parts. If Kodak is unable to repair or replace a Product, Kodak will, at its option, refund the purchase price paid for the Product provided the Product has been returned to Kodak along with proof of the purchase price paid. Repair, replacement, or refund of the purchase price are the sole remedies under the warranty. If replacement parts are used in making repairs, those parts may be remanufactured, or may contain remanufactured materials. If it is necessary to replace the entire Product, it may be replaced with a remanufactured Product. Remanufactured Products, parts and materials are warranted for the remaining warranty term of the original Product, or 90 days after the date of repair or replacement, whichever is longer.

Limitations

This warranty does not cover circumstances beyond Kodak's control. This warranty does not apply when failure is due to shipping damage, accident, alteration, modification, unauthorized service, misuse, abuse, use with incompatible accessories or attachments (such as third party ink or ink tanks), failure to follow Kodak's operation, maintenance or repacking instructions, failure to use items supplied by Kodak (such as adapters and cables), or claims made after the duration of this warranty.

Kodak makes no other express or implied warranty for this product, and disclaims the implied warranties of merchantability and fitness for a particular purpose. In the event that the exclusion of any implied warranty is ineffective under the law, the duration of the implied warranty will be one year from the purchase date or such longer period as required by law. The option of repair, replacement, or refund is Kodak's only obligation. Kodak will not be responsible for any special, consequential or incidental damages resulting from the sale, purchase, or use of this product regardless of the cause. Liability for any special, consequential or incidental damages (including but not limited to loss of revenue or profit, downtime costs, loss of the use of the equipment, cost of substitute equipment, facilities or services, or claims of your customers for such damages resulting from the purchase use or failure of the Product), regardless of cause or for breach of any written or implied warranty is expressly disclaimed.

Your rights

Some states or jurisdictions do not allow exclusion or limitation of incidental or consequential damages, so the above limitation or exclusion may not apply to you. Some states or jurisdictions do not allow limitations on how long an implied warranty lasts, so the above limitation may not apply to you. This warranty gives you specific rights, and you may have other rights which vary from state to state or by jurisdiction.

Outside the United States and Canada

In countries other than the United States and Canada, the terms and conditions of this warranty may be different. Unless a specific Kodak warranty is communicated to the purchaser in writing by a Kodak company, no warranty or liability exists beyond any minimum requirements imposed by law, even though defect, damage, or loss may be by negligence or other act.

Regulatory compliance

FCC compliance and advisory



Kodak EasyShare Z8612 IS digital camera

This equipment has been tested and found to comply with the limits for a Class B digital device, pursuant to Part 15 of the FCC Rules. These limits are designed to provide reasonable protection against harmful interference in a residential installation. This equipment generates, uses, and can radiate radio frequency energy and, if not installed or used in accordance with the instructions, may cause harmful interference to radio communications. However, there is no guarantee that interference will not occur in a particular installation. If this equipment does cause harmful interference to radio or television reception, which can be determined by turning the equipment off and on, the user is encouraged to try to correct the interference by one or more of the following measures: 1) reorient or relocate the receiving antenna; 2) increase the separation between the equipment and the receiver; 3) connect the equipment to an outlet on a circuit different from that of

which the receiver is connected; 4) consult the dealer or an experienced radio/TV technician for additional suggestions. Any changes or modifications not expressly approved by the party responsible for compliance could void the user's authority to operate the equipment. Where shielded interface cables have been provided with the product or specified additional components or accessories elsewhere defined to be used with the installation of the product, they must be used in order to ensure compliance with FCC regulation.

Australian C-Tick



Canadian DOC statement

DOC Class B Compliance

This Class B digital apparatus complies with Canadian ICES-003.

Observation des normes-Classe B

Cet appareil numérique de la classe B est conforme à la norme NMB-003 du Canada.

FCC and Industry Canada

This device complies with Industry Canada RSS-210 and FCC Rules. Operation is subject to the following two conditions: (1) this device may not cause harmful interference, and (2) this device must accept any interference received, including interference that may cause undesired operation.

FCC et Industrie Canada

Cet appareil est conforme à la norme RSS-210 d'Industrie Canada et aux réglementations de la FCC. Son utilisation est soumise aux deux conditions suivantes : (1) cet appareil ne doit pas provoquer d'interférences nuisibles, et (2) cet appareil doit supporter les interférences reçues, y compris celles susceptibles de nuire à son bon fonctionnement.

Waste Electrical and Electronic Equipment labeling



EU: It is the final user's responsibility to discard this equipment into an approved, segregated collection scheme to enable its suitable treatment/disposal and to improve human/environmental protection. For more information, see your retailer, local authority, or www.kodak.com/go/recycle. (Product weight: 290 g.)

Korean Class B ITE

이 기기는 가정용으로 전자파적합등록을 한 기기로서 주거지역에서는 물론 모든 지역에서 사용할 수 있습니다.

VCCI Class B ITE

この装置は、情報処理装置等電波障害自主規制協議会（VCCI）の基準に基づくクラスB情報技術装置です。この装置は、家庭環境で使用することを目的としていますが、この装置がラジオやテレビジョン受信機に近接して使用されると、受信障害を引き起こすことがあります。
取扱説明書に従って正しい取り扱いをして下さい。

China RoHS

环保使用期限 (EPUP)

在中国大陆, 该值表示产品中存在的任何危险物质不得释放, 以免危及人身健康、财产或环境的时间期限(以年计)。该值根据操作说明中所规定的产品正常使用而定。

有毒有害物质或元素名称及含量标识表

部件名称	有毒有害物质或元素					
	铅	汞	镉	六价铬	多溴联苯	多溴二苯醚
数码相机电路板元件	×	○	○	○	○	○

○: 表示该有毒有害物质在该部件所有均质材料中的含量均在SJ/T 11363-2006规定的限量要求以下。
 ×: 表示该有毒有害物质至少在该部件的某一均质材料中的含量超出SJ/T 11363-2006规定的限量要求。



USB 数据线

Russian GOST-R



Eastman Kodak Company
Rochester, NY 14650

А10-40 Фотокамера изготовлена в Китае; остальные элементы -
в соответствии с маркировкой.

Index

A

- A/V out, 25
- about picture, video, 16
- about this camera, 34
- accessories, 43
 - battery, 58
 - buying, 52
 - printer dock, 44
 - SD/SDHC card, 3
- advanced digital zoom, 34
- AF control, 30
- appendix, 54
- auto
 - enhancement, 20
 - flash, 9
 - focus framing marks, 5

B

- backlight, 7
- battery
 - extending life, 58
 - life, 58
 - loading, 1
- beach, 7
- bookmarks, 22
- burst, using, 12
- button
 - burst, 12
 - delete, 5
 - flash, 9

- OK, ii
- review, 15
- shutter, i
- zoom, 8

C

- cable
 - audio/video, 25
 - USB, 43
- camera screen
 - error messages, 50
- camera sounds, 33
- candle light, 7
- capture frame grid, 33
- caring for your camera, 59
- clock, setting, 2
- color mode, 30
- compatibility, dock, 46
- copy pictures
 - card to memory, 27
 - memory to card, 27
 - to computer, 42
- cropping pictures, 20, 21
- customer support, 52, 53

D

- date setting, 2
- date stamp, 32
- DC-in, ii
- deleting

- during quickview, 5
- pictures/video, 17
- protecting pictures, videos, 17
- digital zoom, using, 8
- displaying slide show, 23
- disposal, recycling, 59, 63
- dock compatibility, 46
- doing more with your camera, 29
- download pictures, 42

E

- EasyShare software, installing, 42
- emailing pictures, videos, 39
- error messages, 50
- exposure
 - bracketing interval, 32
 - compensation, 35, 37
 - metering, 31
- external video device
 - viewing pictures, videos, 25

F

- favorites
 - tagging, 40
- filter pictures, videos, 26
- fireworks, 7
- firmware, upgrading, 57
- flash
 - settings, 9
- flower, 7
- focus
 - framing marks, 5
 - zone, 32
- focus mode

- infinity, 10
- macro, 10
- normal AF, 10
- format, 34
- framing grid, 35

G

- grid, framing, 35
- guidelines, battery, 58

H

- HDTV dock, 25
- help, 47
 - camera, 47
 - web links, 52
- high ISO, 6
- histogram, 37

I

- icons, mode dial, 6
- image stabilizer, 33
- image storage, 32
- information
 - about pictures, videos, 16
- installing
 - batteries, 1
 - SD/SDHC card, 3
 - software, 42
- internal memory, storage capacity, 57

K

- Kodak EasyShare software
 - upgrading, 57
- Kodak Perfect Touch technology, 20
- Kodak web sites, 52

L

- landscape, 7
- LCD, ii
 - brightness, 32
 - reviewing pictures, 15
 - reviewing videos, 15
- lens, cleaning, 59
- loading
 - batteries, 1
 - SD/SDHC card, 3
 - software, 42

M

- Macintosh computers, installing
 - software on, 42
- magnify picture, 15
- maintenance, camera, 59
- manner/museum, 7
- manual, 35
- memory
 - inserting card, 3
 - storage capacity, 57
- mode dial, 6
- modes
 - manual, 35
- modes, capture
 - high ISO, 6
 - PASM, 6
 - SCN (scene), 6
 - smart scene, 6
 - video, 6
- multimedia slide show, 24
- multiple selections, 27
- multi-up, 26

N

- night landscape, 7
- night portrait, 7

O

- OK button, ii
- online prints, ordering, 46
- optical zoom, 8
- orientation sensor, 34

P

- panoramic pictures, 13
- PASM modes, 35
- Perfect Touch technology, 20
- PictBridge enabled printer, 44
- picture size, 29
- picture/video settings, 29
- pictures
 - checking settings, 28
 - copying, 27
 - cropping, 20, 21
 - deleting, 17
 - emailing tagged, 39
 - Kodak Perfect Touch, 20
 - magnifying, 15
 - printing, 45
 - protecting, 17
 - reviewing, 15
 - storage capacity, 57
 - taking, modes, 6
 - transfer, 42
- portrait, 6
- power, camera, 2
- printer dock, 44

printing

- from a card, 46
- from computer, 45
- optimizing printer, 52
- order online, 46
- PictBridge technology, 44
- tagged pictures, 46
- with EasyShare printer dock, 44

problem-solving, 47

program and manual, 6

protecting pictures, videos, 17

Q

quickview

- setting, 32
- using, 5

R

ready light, 4

recycling, disposal, 59, 63

red-eye, flash, 9

regulatory information, 61

repair, 52

review button, 15

reviewing pictures/videos

- after taking, 15
- as you take them, 5
- deleting, 17
- protecting, 17
- slide show, 23

running a slide show, 23

S

scene modes, 6

- backlight, 7

beach, 7

candle light, 7

fireworks, 7

flower, 7

landscape, 7

manner/museum, 7

night landscape, 7

night portrait, 7

panorama, 13

portrait, 6

self-portrait, 7

snow, 7

sport, 7

stage, 7

sunset, 7

text, 7

SCN (scene), 6

SD/SDHC card

- inserting, 3

printing from, 46

storage capacities, 57

search pictures, videos, 26

select multiple pictures/videos, 27

self-portrait, 7

self-timer

- with pictures, 11

service and support telephone

- numbers, 53

setting

- about this camera, 34

advanced digital zoom, 34

AF control, 30

camera sounds, 33

capture frame grid, 33

- color mode, 30
 - date and time, 2
 - date stamp, 32
 - exposure bracketing, 32
 - exposure metering, 31
 - flash, 9
 - focus zone, 32
 - image stabilizer, 33
 - image storage, 32
 - LCD brightness, 32
 - orientation sensor, 34
 - picture size, 29
 - picture taking modes, 6
 - picture/video, 29
 - quickview, 32
 - self-timer, 11
 - sharpness, 31
 - sound volume, 34
 - tag, 33
 - video out, 34
 - video size, 30
 - white balance, 31
 - sharing pictures, videos, 38
 - sharpness, 31
 - shutter
 - button, i
 - problems, 48
 - self-timer delay, 11
 - speed, 35
 - slide show
 - continuous loop, 24
 - problems, 48
 - running, 23
 - smart scene, 6
 - snow, 7
 - software
 - installing, 42
 - upgrading, 57
 - sort pictures, videos, 26
 - sound volume, 34
 - sounds, camera, 33
 - specifications, camera, 54
 - sport, 7
 - stage, 7
 - storage capacity, 57
 - strap, 1
 - strap post, ii
 - sunset, 7
 - support, technical, 52, 53
- T**
- tag
 - favorites, 40
 - for email, 39
 - for print, 38
 - set, 33
 - telephone support, 53
 - television, slide show, 25
 - text, 7
 - time, setting, 2
 - timer, shutter delay, 11
 - transferring pictures, videos, 42
 - trash can, deleting, 5
 - troubleshooting, 47
 - camera, 47
 - camera/computer
 - communications, 50
 - error messages, 50

turning camera on/off, 2

U

undelete, 17

upgrading software, firmware, 57

URLs, Kodak web sites, 52

USB cable, 43

USB, A/V out, ii

V

video, 6

 action print, 23

 bookmarks, 22

 checking settings, 28

 copying, 27

 emailing tagged, 39

 out, 34

 protecting, 17

 reviewing, 15

 size, 30

 storage capacities, 57

optical, x

transfer, 42

viewing, 15

viewing

 by date, tag, 26

 by multi-up, 26

viewing picture/video

 after taking, 5, 15

 information, 16

volume, adjusting, 34

W

warranty, 59

WEEE, 63

white balance, 31

Windows OS-based computers

 installing software, 42

Z

zoom

 digital, 8

 optical, 8

Free Manuals Download Website

<http://myh66.com>

<http://usermanuals.us>

<http://www.somanuals.com>

<http://www.4manuals.cc>

<http://www.manual-lib.com>

<http://www.404manual.com>

<http://www.luxmanual.com>

<http://aubethermostatmanual.com>

Golf course search by state

<http://golfingnear.com>

Email search by domain

<http://emailbydomain.com>

Auto manuals search

<http://auto.somanuals.com>

TV manuals search

<http://tv.somanuals.com>