Kodak EasyShare C913/CD913 digital camera



Extended user guide

www.kodak.com

For interactive tutorials, www.kodak.com/go/howto

For help with your camera, www.kodak.com/go/c913support,
www.kodak.com/go/cd913support

Kodak

Eastman Kodak Company
Rochester, NY 14650

© Eastman Kodak Company, 2008

All screen images are simulated.

Kodak, EasyShare, and Perfect Touch are trademarks of Eastman Kodak Company.

P/N 4F8269_en

Front view

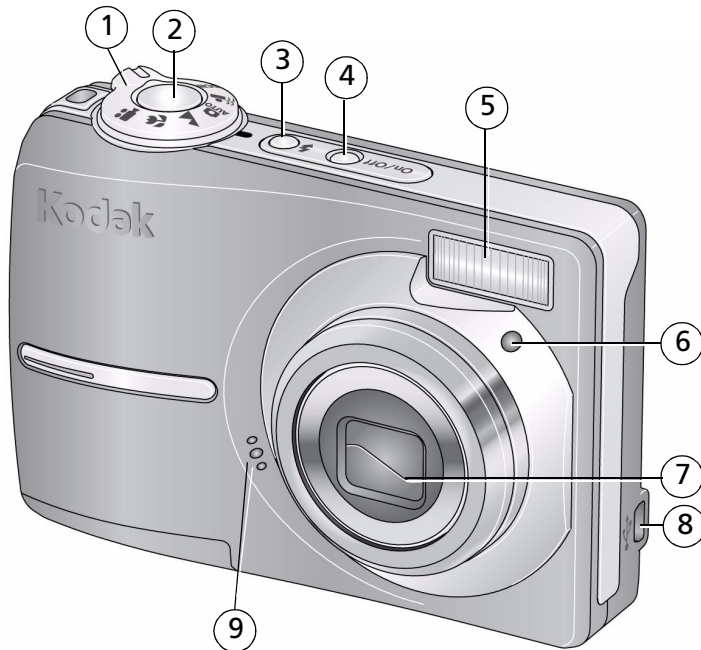

- | | | | |
|---|----------------|---|----------------------------------------------------------------------------------------|
| 1 | Mode dial | 4 | Self-timer light |
| 2 | Shutter button | 7 | Lens |
| 3 | Flash button | 8 | USB  |
| 4 | On/Off button | 9 | Microphone |
| 5 | Flash | | |

Back view

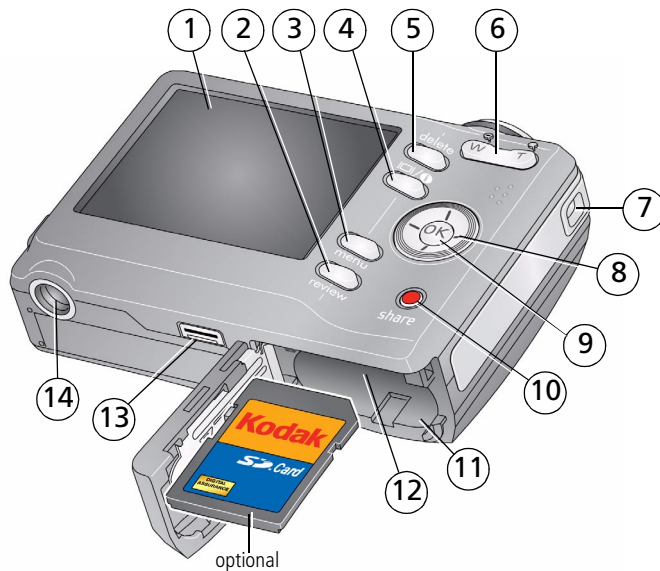



- | | | | |
|---|---------------------------------------------------------------------------------------------------------------------------------------------------------------------------------------|----|---------------------------|
| 1 | LCD | 8 | |
| 2 | Review button | 9 | OK button |
| 3 | Menu button | 10 | Share button |
| 4 | LCD/Info button   | 11 | Battery compartment |
| 5 | Delete button | 12 | Slot for optional SD card |
| 6 | Zoom button (Telephoto/Wide) | 13 | Dock connector |
| 7 | Strap post | 14 | Tripod socket |

Table of contents

1	Setting up your camera	1
	Attaching the strap	1
	Loading the battery	1
	Turning on the camera	2
	Setting the language, date/time	2
	Storing pictures on an SD card	3
2	Taking pictures/videos	4
	Taking a picture	4
	Taking a video	5
	Using optical zoom	6
	Using the flash	7
	Using different picture-taking modes	8
	Using camera Help	10
	Understanding the picture-taking icons	11
3	Working with pictures/videos	12
	Reviewing pictures/videos	12
	Deleting pictures/videos	14
	Using the menu button in review	15
	Using Kodak Perfect Touch technology	15
	Cropping pictures	16
	Rotating pictures	16
	Editing videos	17
	Running a slide show	18
	Copying pictures/videos	20
	Selecting multiple pictures/videos	20
	Searching pictures by date, Favorites, or other tag	21
	Understanding the review icons	22
4	Doing more with your camera	24
	Changing picture-taking settings	24

Customizing your camera	26
Using exposure compensation to adjust picture brightness	28
Using the framing grid to compose a picture	29
Sharing your pictures	29
5 Transferring and printing pictures	33
Installing the software	33
Transferring pictures with the USB cable	34
Printing pictures	35
Dock compatibility for your camera	37
6 Troubleshooting	38
Camera problems	38
Camera/computer communications	40
LCD screen messages	41
7 Getting help	44
Helpful links	44
8 Appendix	46
Camera specifications	46
Care and maintenance	48
Upgrading your software and firmware	49
Storage capacities	49
Important safety instructions	49
Battery life	50
Limited Warranty	51
Regulatory compliance	53

1

Setting up your camera

Attaching the strap

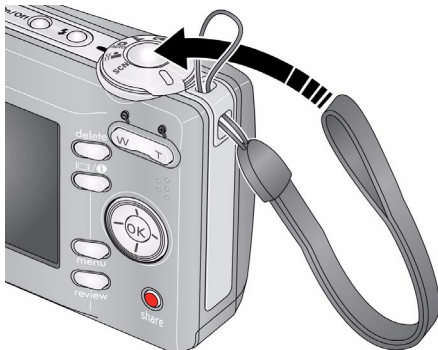

Loading the battery

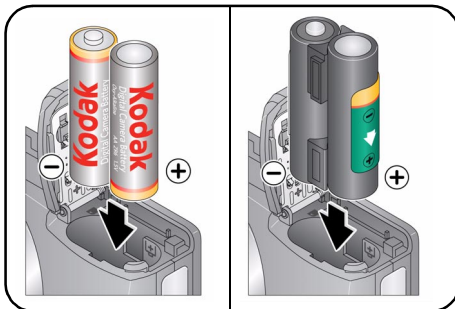

- Kodak oxy-alkaline digital camera batteries AA
- Kodak Ni-MH rechargeable digital camera batteries AA
- Kodak Ni-MH rechargeable digital camera battery KAA2HR
- alkaline batteries AA
- lithium batteries AA

To extend battery life, see [page 51](#).

www.kodak.com/go/support

Turning on the camera

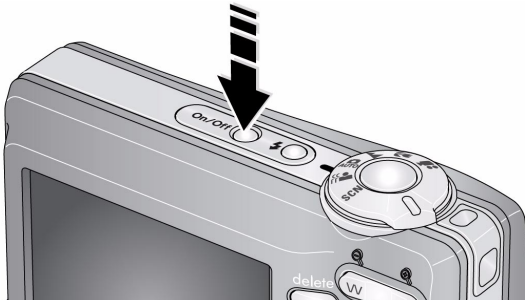

Setting the language, date/time

A diagram of the camera's control panel. The screen shows a menu with "00:00" and "20". Below the screen are buttons labeled "delete", "W", "T", "OK", "review", and "charge". A large black arrow with white diagonal stripes points up from the "OK" button to the "T" button. Another large black arrow with white diagonal stripes points right from the "OK" button to the "W" button. A third large black arrow with white diagonal stripes points down from the "OK" button to the "review" button. A fourth large black arrow with white diagonal stripes points left from the "OK" button to the "delete" button.

Language:

- 1 ▲/▼ to change.
- 2 OK to accept.

Date/Time:

- 1 At the prompt, press OK.
- 2 ▲/▼ to change.
◀/▶ for previous/next field.
OK to accept.

NOTE: To change the date/time and language in the future, use the Menu button (page 26).

Storing pictures on an SD card

Your camera has internal memory. You can purchase an SD card to conveniently store more pictures and videos (www.kodak.com/go/c913accessories, www.kodak.com/go/cd913accessories). We recommend Kodak SD cards.

NOTE: To choose a storage location for pictures and videos, [see page 27](#).

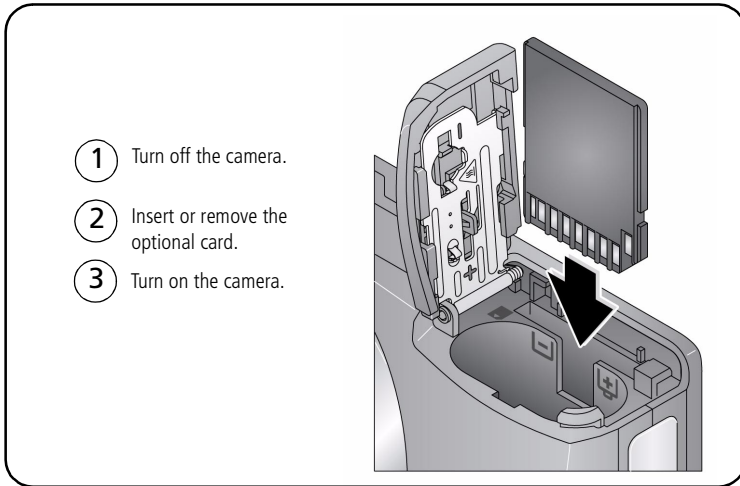

CAUTION:

A card can only be inserted one way; forcing it may cause damage. If you insert or remove a card while the camera is accessing it, the card, pictures, or camera may be damaged.

See [page 49](#) for storage capacities.

2

Taking pictures/videos

Taking a picture

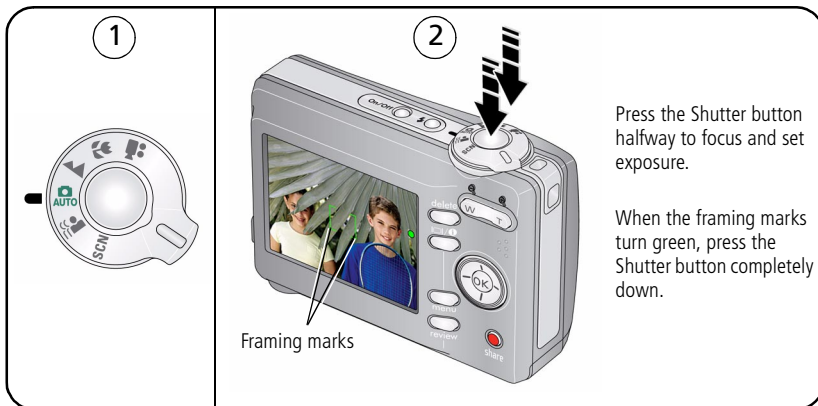

Reviewing the picture just taken

After you take a picture or video, the LCD displays a quickview for approximately 10 seconds. (To exit the quickview sooner, press the Shutter button halfway.)

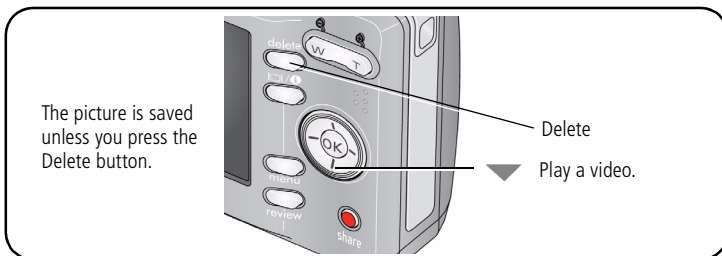

To review pictures/videos anytime, see [page 12](#).

Using the framing marks to take pictures

Framing marks indicate the camera focus area. The camera attempts to focus on foreground subjects, even if the subjects are not centered in the scene.

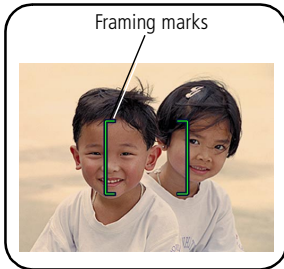

- 1 Press the Shutter button **halfway**.
When the framing marks turn green, focus is accomplished.
- 2 If the camera is not focusing on the desired subject (or if the framing marks disappear), release the Shutter button and recompose the scene.
- 3 Press the Shutter button **completely down** to take the picture.

NOTE: Framing marks do not appear in all modes. When you use AF Zone and set Center Zone, the framing marks are fixed at Center Wide.

Taking a video

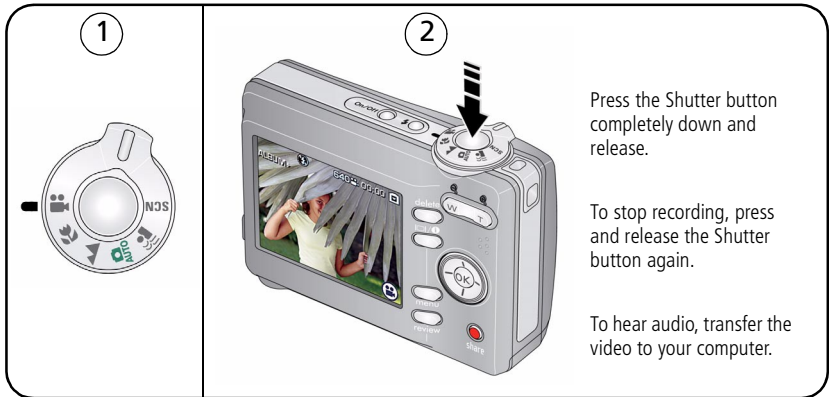

Using optical zoom

Use optical zoom to get up to 3X closer to your subject.

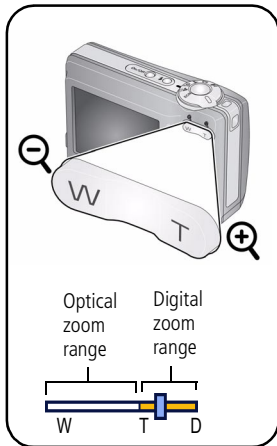

- 1 Use the LCD to frame your subject.
- 2 Press Telephoto (T) to zoom in. Press Wide Angle (W) to zoom out.

The zoom indicator shows zoom status.

- 3 Take the picture or video.

NOTE: For focus distances, see [Camera specifications, page 46](#).

- Always use the auto focus framing marks (see [page 5](#)).
- If you are using no zoom (1X, wide angle), you can be as close as 24 in. (60 cm) to your subject.
- As you zoom, you need to move further from your subject.

Using the digital zoom

Use digital zoom in any Still mode or during video recording to get up to 5X magnification beyond optical zoom.

- 1 Press Telephoto (T) to the maximum optical zoom limit. Release the button, then press it again.
- 2 Take the picture.

NOTE: You may notice decreased image quality when using digital zoom. The slider on the zoom indicator turns red when the picture quality reaches the limit for an acceptable 4 x 6-in. (10 x 15 cm) print.

Using the flash



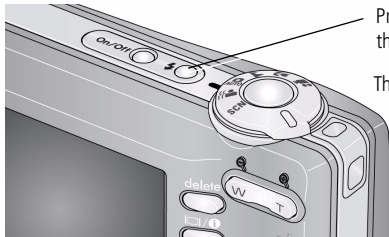

Use the flash when you take pictures at night, indoors, or outdoors in heavy shadows.



Press the ⚡ button repeatedly to scroll through flash modes (see Flash modes below).





The current flash mode appears in the LCD screen.

Flash-to-subject distance	
Zoom position	Flash distance
Wide angle	0.6–3.6 m (2–11.8 ft) @ ISO 200
Telephoto	0.6–2.1 m (2–6.9 ft) @ ISO 200

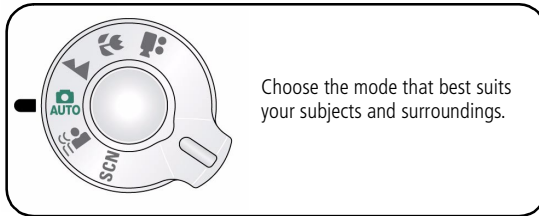
Flash modes	Flash fires
 Auto Flash	When the lighting conditions require it.
 Fill	Every time you take a picture, regardless of the lighting conditions. Use when the subject is in shadow or is “backlit” (when the light is behind the subject). In low light, hold the camera steady or use a tripod.
 Red-eye	The flash fires twice—once, then again when the picture is taken.
 Off	Never.

Using different picture-taking modes



Use this mode	For
SCN Scene	Point-and-shoot simplicity when taking pictures under special conditions. (See page 8 .)
 Blur Reduction	Minimizing the effects of camera shake and subject movement.
 Auto	General picture taking—offers an excellent balance of image quality and ease of use.
 Landscape	Far-away scenes. The camera uses infinity auto-focus. Auto-focus framing marks are not available in Landscape.
 Close-up	Close range. Use available light instead of flash if possible. The camera automatically sets the focus distance depending on the zoom position.
 Video	Capturing video with sound. (See page 5 .)

Scene modes

Choose a Scene mode—for great pictures in practically any situation!

- 1 Turn the Mode dial to Scene **SCN**.
- 2 Press     to display Scene mode descriptions.
If the mode description turns off before you finish reading it, press OK.

3 Press OK to choose a Scene mode.

Use this SCN mode	For
Portrait	Full-frame portraits of people.
Night Portrait	Reducing red eye of people in night scenes or low-light conditions. Place the camera on a flat, steady surface or use a tripod.
Night Landscape	Distant scenery at night. Flash does not fire. Place the camera on a flat, steady surface or use a tripod.
Sports	Subjects in motion.
Snow	Bright snow scenes.
Beach	Bright beach scenes.
Text/ Document	Documents. Focus is set to Auto Focus (see page 47).
Backlight	Subjects that are in shadow or "backlit" (when light is behind the subject).
Manner/ Museum	Quiet occasions, like a wedding or lecture. Flash and sound are disabled.
Fireworks	Bright, colorful light displays. Flash does not fire. Place the camera on a flat, steady surface or use a tripod.
High ISO	People indoors, in low-light scenes. Minimizes red eye.
Children	Action pictures of children in bright light.
Flower	Close-ups of flowers or other small subjects in bright light. Focus is set to Auto Focus (see page 47).
Self-Portrait	Close-ups of yourself. Assures proper focus and minimizes red eye.
Sunset	Capturing the deep hues seen at sunset.

Using camera Help

To better understand each menu option, use camera Help. Highlight a menu choice, then press the  button.

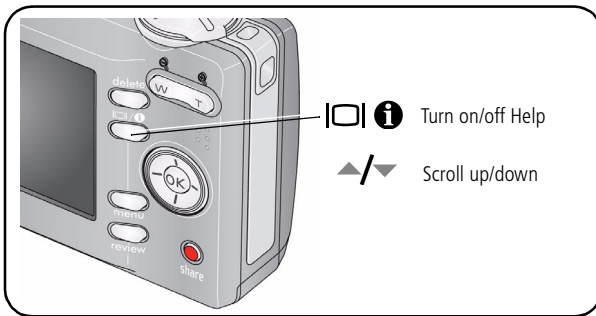

Understanding the picture-taking icons

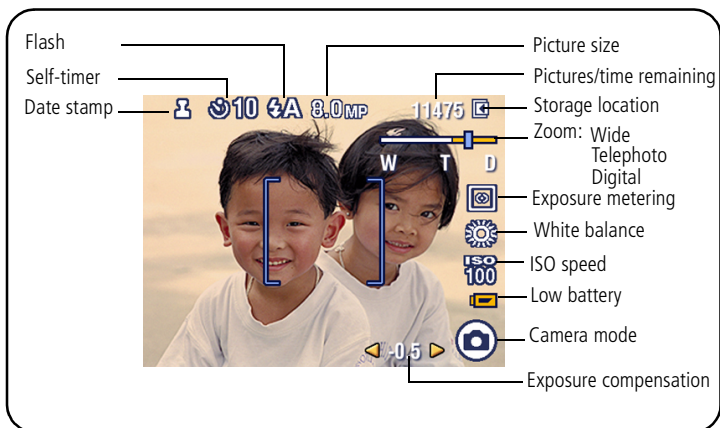

In capture mode—shutter pressed halfway



3

Working with pictures/videos

Reviewing pictures/videos

Press the Review button to view and work with your pictures/videos. Press Review again to exit.





- 1 Press the Review button.
- 2 Press  to view previous/next picture/video.
To save battery power, use an optional Kodak EasyShare dock or Kodak 3-volt AC adapter. (Visit www.kodak.com/go/c913accessories, www.kodak.com/go/cd913accessories.)

NOTE: Pictures taken at a 3:2 picture size have a black bar at the top and bottom. Pictures taken at 16:9 picture size have a black bar at the sides. A video's duration is displayed at the top of the LCD.

Magnifying pictures



- 1 Press the Review button.
- 2 Press W/T to magnify 2X–8X.
- 3 Press   to view other parts of the picture.
- 4 Press OK to return to 1X.

NOTE: If you press  while at 1X, the view changes from single-picture to multi-up thumbnails. (See [page 13](#).)

Playing videos

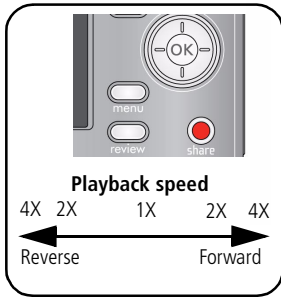

- 1 Press the Review button.
- 2 Press ◀/▶ to find previous/next video.
 - Press ▼ to play/pause.
 - Press ▶ during playback to play at 2X, 4X.
 - Press ◀ to reverse at 2X, 4X.

NOTE: To hear audio, transfer the video to your computer (see [page 34](#)).

Viewing thumbnails (multi-up)





- 1 Press the Review button.
- 2 Press ▼ to change from single-picture view to multi-up thumbnails.
- 3 Press OK to return to single-picture view.



NOTE: To select multiple pictures/videos, see [page 21](#).

Viewing picture/video information







- 1 Press the Review button.
- 2 Repeatedly press the LCD/Info   button to turn on/off status icons and picture/video info.

Deleting pictures/videos

- 1 Press the Review button.
- 2 Press / for previous/next picture/video.
- 3 Press the Delete button.
- 4 Follow the screen prompts.

Protecting pictures/videos from deletion

- 1 Press the Review button.
- 2 Press / for previous/next picture/video.
- 3 Press the Menu button.
- 4 Press / to highlight Protect, then press OK.

The picture/video is protected and cannot be deleted. The Protect icon  appears with the protected picture/video.

- Press the Menu button to exit the menu.



CAUTION:

Formatting internal memory or an SD or SDHC card deletes all (including protected) pictures/videos. (Formatting internal memory also deletes email addresses, tag names, and favorites.)

Using the menu button in review

- 1 Press the Review button, then the Menu button.
- 2 Press ◀/▶ to highlight a tab:
 - **Review** to view pictures/videos
 - **Edit Picture** to edit pictures/videos
 - **Setup** for other camera settings (page 26)
- 3 Press ▲/▼ to highlight a setting, then press the OK button.
- 4 Highlight an option, then press the OK button.

Using Kodak Perfect Touch technology

Kodak Perfect Touch technology helps ensure better, brighter pictures.

- 1 Press the Review button, then ◀/▶ for previous/next picture.
- 2 Press the Menu button. Press ▲/▼ to highlight Edit Picture, then press OK.
- 3 Press ▲/▼ to highlight Perfect Touch tech., then press OK.

The enhancement is previewed in a split screen. Press ◀/▶ to view other parts of the picture.

- 4 Press OK. Follow the screen prompts to replace the original picture or to save the enhanced picture as a new one.

NOTE: You cannot enhance previously enhanced pictures.

- Press the Menu button to exit the menu.

Cropping pictures

You can crop a picture so that only the desired portion of the picture remains.

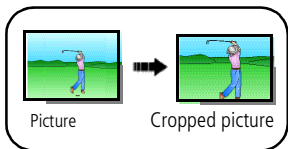

- 1 Press the Review button, then ◀/▶ to find a picture.
- 2 Press the Menu button. Press ▲/▼ to highlight Edit Picture, then press OK.
- 3 Press ▲/▼ to highlight Crop, then press OK.
- 4 Press Telephoto (T) to zoom in, or ◀/▶ ▲/▼ to move the crop box. Press OK.
- 5 Follow the screen prompts.

The picture is cropped and saved as a new one. The original is saved. (Cropped pictures cannot be cropped again.)

- Press the Menu button to exit the menu.

Rotating pictures

You can change a picture to display in portrait  or landscape  orientation.

- 1 Press the Review button, then ◀/▶ for previous/next picture.
- 2 Press the Menu button. Press ▲/▼ to highlight Edit Picture, then press OK.
- 3 Press ▲/▼ to highlight Rotate Picture, then press OK.
- 4 Press ▲/▼ to highlight an option:

Rotate Right—rotates the picture 90 degrees clockwise .

Rotate Left—rotates the picture 90 degrees counterclockwise .

- 5 Press OK. Follow the screen prompts to replace the original picture or to save the rotated picture as a new one.
- Press the Menu button to exit the menu.

Editing videos

Making a picture from a video

You can choose a single frame from a video, then make a picture suitable for printing.

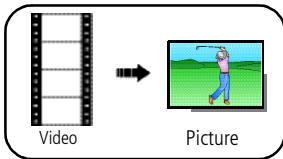

- 1 Press the Review button, then ◀/▶ to find a video.
- 2 Press the Menu button. Press ▲/▼ to highlight Edit Video, then press OK.
- 3 Press ▲/▼ to highlight Make Picture, then press OK.
- 4 Press OK to select a video frame.
- 5 Follow the screen prompts to save the picture.
A picture is created. (The original video is saved.)
 - Press the Menu button to exit the menu.

Trimming a video

You can delete an unwanted portion from the beginning or end of a video.

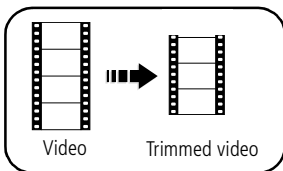

- 1 Press the Review button, then ◀/▶ to find a video.
- 2 Press the Menu button. Press ▲/▼ to highlight Edit Video, then press OK.
- 3 Press ▲/▼ to highlight Trim, then press OK.
- 4 Follow the screen prompts. (Use fast-forward and fast-reverse, if needed.)
The video is trimmed. (You can save it as a new video or replace the original.)
 - Press the Menu button to exit the menu.

Making a video action print

From a video, you can make a 4-, 9-, or 16-up picture, suitable for a 4 x 6-inch (10 x 15 cm) print.

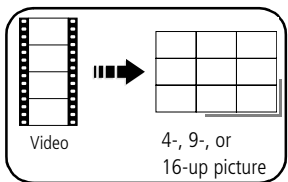

- 1 Press the Review button, then ◀/▶ to find a video.
- 2 Press the Menu button. Press ▲/▼ to highlight Edit Video, then press OK.
- 3 Press ▲/▼ to highlight Video Action Print, then press OK.
- 4 Choose an option, then press OK.
Auto options: The camera includes the first and last frames, then 2, 7, or 14 equally spaced frames.
Manual options: You choose the first and last frames; the camera chooses 2, 7, or 14 equally spaced frames.
■ Press the Menu button to exit the menu.

Running a slide show

Use Slide Show to display your pictures/videos on the LCD.

Starting the slide show

- 1 Press the Review button, then the Menu button.
- 2 Press ▲/▼ to highlight Slide Show, then press OK.
- 3 Press ▲/▼ to highlight Begin Show, then press OK.

Each picture/video is displayed once.

To interrupt the Slide Show, press OK.

Changing the slide show display interval

The default interval setting displays each picture for 5 seconds. You can set the display interval from 3–60 seconds.

- 1 On the Slide Show menu, press ▲/▼ to highlight Interval, then press OK.
- 2 Select a display interval.
To scroll through the seconds quickly, press and hold ▲/▼.
- 3 Press OK.

The interval setting remains until you change it.

Running a continuous slide show loop

When you turn on Loop, the slide show is continuously repeated.

- 1 On the Slide Show menu, press ▲/▼ to highlight Loop, then press OK.
- 2 Press ▲/▼ to highlight On, then press OK.
- 3 Press ▲/▼ to highlight Begin Show, then press OK.

The slide show repeats until you press OK or until battery power is exhausted. The loop feature remains until you change it.





Copying pictures/videos

You can copy pictures/videos from a card to internal memory or from internal memory to a card.

Before you copy, make sure that:

- A card is inserted in the camera.
- The camera's image storage location is set to the location **from** which you are copying (see [page 27](#)).

Copy pictures/videos:







- 1 Press the Review button, then the Menu button.
- 2 Press / to highlight Copy, then press OK.
- 3 Press / to highlight an option.
- 4 Press OK.

NOTE: Pictures/videos are copied, not moved. To remove pictures/videos from the original location after copying, delete them (see [page 14](#)).

Tags that you applied for print, email, and favorites are not copied. Protection settings are not copied. To apply protection to a picture/video, see [page 14](#).

Searching pictures by date, Favorites, or other tag

If you have many pictures on your camera or card, you can sort them so that only some are visible at a time. You can sort by the date a picture was taken or—if you've tagged pictures with a Favorites tag or a tag that you created—you can sort by tag.

- 1 Press the Review button, then the Menu button.
- 2 Press / to highlight Search, then press the OK button.
- 3 Press / to highlight Date, Favorite, or Tag, then  to select a folder.
- 4 Press / to select a folder.
- 5 To see the results of your search, highlight Exit then press the OK button. Press

Save, then press the OK button.

Pictures are displayed in multi-up view. Press ◀/▶▲/▼ to view them. Press the Telephoto (T) button to view the picture full-screen. Press the Wide Angle (W) button to return to multi-up view.

- For more about tags, see [page 29](#).
- To select multiple pictures/videos, see [page 21](#).

Selecting multiple pictures/videos

Use the multi-select feature when you have two or more pictures/videos to print, transfer, delete, etc. Multi-select is used most effectively in Multi-Up mode, [page 13](#).

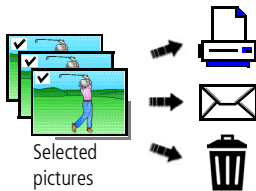

- 1 Press the Review button, then ◀/▶ to find a picture/video.
- 2 Press the OK button to select pictures/videos.

A check mark appears on the picture. You can now print, transfer, delete, etc. the selected pictures. You can press OK a second time to remove a check mark.

Understanding the review icons

Pictures

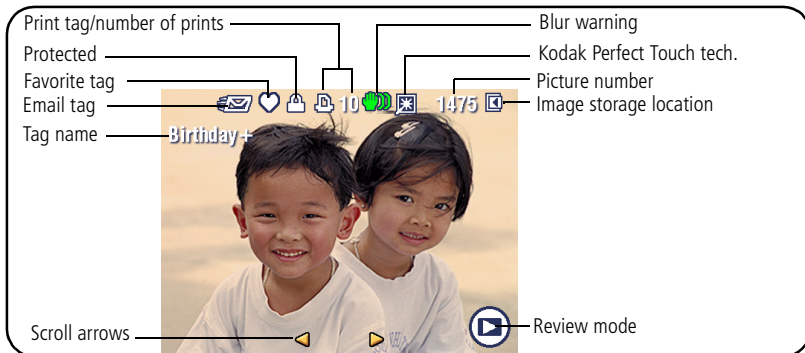

Videos

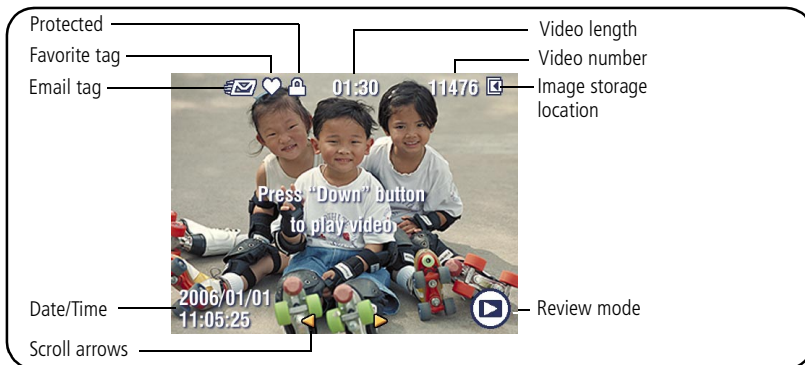

Understanding blur warning icons

A picture blur warning icon  is displayed during quickview and review.

Green—Picture is sharp enough for an acceptable 4 x 6-inch (10 x 15 cm) print.

Yellow—Picture may be sharp enough for an acceptable 4 x 6-inch (10 x 15 cm) print or sharpness is not determined.

Red—Picture is not sharp enough for an acceptable 4 x 6-inch (10 x 15 cm) print.

White—Printability is still being determined.

4

Doing more with your camera

Changing picture-taking settings

You can change settings to get the best results from your camera.

- 1 Press the Menu button.
- 2 Press / to highlight a setting, then press OK.
- 3 Choose an option, then press OK.
 - Press the Menu button to exit the menu.

NOTE: To better understand each menu option, use camera Help. Highlight a menu choice, then press the button.

Some settings remain until you change them; others, until you change modes or turn off the camera. Some modes offer limited settings.

Press Menu, /, and OK to access settings	Options
Self-timer	10 seconds —so you have time to get into the scene. 2 seconds —for a steady, auto-shutter release on a tripod. 2-shot —one picture is taken after a 10-second delay. A second picture is taken 8 seconds later.
Exposure Compensation Increase or decrease brightness before taking a picture. (Also see page 28 .)	0.0, -0.5, -1.0, -1.5, -2.0, +0.5, +1.0, +1.5, +2.0



Press Menu,  , and OK to access settings	Options	
<p>Picture Size</p> <p>Choose a picture resolution.</p> <p>For recommended print sizes, visit: www.kodak.com/go/printsizes</p>	9.0 MP (4:3)	Pictures at the highest resolution, largest file size
	8.0 MP (3:2)	Printing on EasyShare printer docks and photo printers
	6.8 MP (16:9)	HDTV format in high resolution
	5.0 MP (4:3)	Medium file size
	3.1 MP (4:3)	Medium file size
	2.2 MP (3:2)	Printing on EasyShare printer docks and photo printers (at a lower resolution than 8.0 MP)
	2.1 MP (16:9)	HDTV format
	1.2 MP (4:3)	Email, Internet, or to conserve space
<p>White Balance</p> <p>Choose your lighting condition.</p>	<p>Auto—automatically corrects white balance. Ideal for general picture taking.</p> <p>Daylight—for pictures in natural lighting.</p> <p>Tungsten—corrects the orange cast of household light bulbs. Ideal for indoor pictures under tungsten or halogen lighting without flash.</p> <p>Fluorescent—corrects the green cast of fluorescent lighting. Ideal for indoor pictures under fluorescent lighting without flash.</p> <p>Open Shade—for pictures in shade in natural lighting.</p>	
<p>ISO Speed</p> <p>Control the camera's sensitivity to light.</p>	<p>Choose a lower ISO setting in brightly lit scenes; use a higher ISO for low-light scenes. Choose Auto (default), 80, 100, 200, 400, 800, 1000.</p> <p>NOTE: ISO returns to Auto when the camera is set to SCN mode.</p> <p>Unavailable in Video mode.</p>	

Press Menu, ▲/▼, and OK to access settings	Options
AF Zone Select a large or concentrated area of focus.	Multi-zone —evaluates 3 zones to give an even picture focus. Ideal for general picture taking. Center-zone —evaluates the small area centered in the viewfinder. Ideal when precise focus of a specific area in the picture is needed. NOTE: For the best pictures, the camera is set to Multi-zone when in Landscape mode.
Color Mode Choose color tones. Unavailable in Video mode.	Color Black & White Sepia —pictures have a reddish-brown, antique look. NOTE: EasyShare software also lets you change a color picture to black-and-white or sepia.
Video Size Available only in Video mode.	640 x 480 320 x 240
Setup Menu Choose additional settings.	See Customizing your camera on page 26 .

Customizing your camera

Use Setup to customize your camera settings.

- 1 In any mode, press the Menu button.
- 2 Press ▲/▼ to highlight Setup, then press OK.
- 3 Press ▲/▼ to highlight a setting, then press OK.
- 4 Choose an option, then press OK.
- 5 Press the Menu button to exit.

NOTE: Press the LCD/Info button   for information about camera settings and options. These settings remain until you change them.

Press Menu, ▲/▼ to highlight Setup, then OK to access settings	Options
LCD Brightness	Power Save High Power
Image Storage Choose a storage location for pictures/videos.	Auto —the camera uses the card if one is in the camera. If not, the camera uses internal memory. Internal Memory —the camera uses internal memory, even if a card is installed. NOTE: If you fill up your card while taking pictures, your camera's memory plus feature prompts you to switch to internal memory, if space is available. Memory plus is unavailable in Video mode.
Set Tag Assign tag names to pictures/videos. Select tag name(s) before you take pictures or videos. Then, new pictures/ videos are assigned that tag name(s).	Clear All Add Tag Delete Tag Exit Tag Name 1 Tag Name 2 See page 31 .
Camera Sounds Choose sound effects.	All On Shutter Only All Off
Auto Power Off Choose inactivity time until camera turns off.	10 minutes 5 minutes 3 minutes 1 minute

Press Menu, ▲/▼ to highlight Setup, then OK to access settings	Options
Date & Time	See page 2 .
Date Stamp Imprint the date on pictures.	Choose a date option, or turn off the feature. (Default is off.)
Blur Warning See page 23 .	On Off
Language	See page 2 .
Format  CAUTION: Formatting deletes all pictures/videos, including those that are protected. Removing a card during formatting may damage the card.	Memory Card —deletes everything on the card; formats the card. Cancel —exits this setting. Internal Memory —deletes everything in internal memory including email addresses, tag names, and favorites; formats the internal memory.
About View camera information.	

Using exposure compensation to adjust picture brightness

Before you take a picture, you can adjust exposure compensation to make pictures darker or lighter.



- Press ◀ to decrease exposure compensation.
- Press ▶ to increase exposure compensation.

The exposure compensation level is shown on the LCD; the LCD gets brighter or dimmer.

Using the framing grid to compose a picture

The framing grid divides the LCD into thirds—vertically and horizontally. This is helpful if, for example, you want to balance a picture between water, earth, and sky.







To turn on the framing grid in Auto/SCN modes, press the LCD/Info button   until the grid appears.





Sharing your pictures

Press the Share button to tag your pictures and videos. When they are transferred to your computer, you can share them. Use the Share button:

- Any time. (The most recent picture/video taken is then displayed.)
- After pressing the Review button.

Tagging pictures for printing

- 1 Press the Share button. Press   to locate a picture.
- 2 Press   to highlight Print , then press OK.*
- 3 Press   to select the number of copies (0-99).

Optional: You can apply a print quantity to other pictures with the print quantity screen displayed. Press   to locate a picture. Press   to change the print quantity. Repeat until the desired print quantity is applied to pictures.

- 4 Press OK.

The Print icon  appears in the status area.

- Press the Share button to exit the menu.

Printing tagged pictures

When you transfer the tagged pictures to your computer, the Kodak EasyShare software print screen opens. For details, click the Help button in EasyShare software.

For more information on printing from your computer, printer dock, PictBridge enabled printer, or card, see [page 35](#).

NOTE: For the best 4 x 6 in. (10 x 15 cm) prints, set the camera to a 3:2 picture size.

Tagging pictures/videos for email

First—create email addresses

To create email addresses, use the Add Address option and the on-camera keyboard; or create them in EasyShare software and copy them to the camera's internal memory.

Second—tag pictures/videos on your camera

- 1 Press /▶ to find a picture/video, then press the Share button.
- 2 Press ▲/▼ to highlight Email, then press OK.
- 3 Press ▲/▼ to highlight an email address, then press OK.

To assign the same address to other pictures/videos, press /▶ to scroll through pictures/videos. When the picture/video you want is displayed, press OK.

To send the pictures/videos to more than one address, repeat step 3.

Selected addresses are checked.

- 4 To remove a selection, highlight a checked address and press OK. To remove all email selections, highlight Clear All.
- 5 Press ▲/▼ to highlight Exit, then press OK.

The Email icon appears in the status area.

- Press the Share button to exit the menu.

NOTE: To add an email address, use the Add Email menu choice. Then use the on-camera keyboard.

Third—transfer and email

When you transfer these pictures/videos to your computer, EasyShare software prompts you to send them. For details, see Help in EasyShare software.

Tagging pictures/videos with tags that you create

Use the Tag feature to create tag names and assign them to pictures/videos.

- 1 Press the Review button, then find a picture/video.
- 2 Press the Menu button.
- 3 Press $\blacktriangle/\blacktriangledown$ to highlight Tag, then press OK.

NOTE: To add a tag name, use the Add Tag option, then use the on-camera keyboard.

- 4 Press $\blacktriangle/\blacktriangledown$ to highlight a Tag name, then press OK.

To tag other pictures, press $\blacktriangleleft/\blacktriangleright$ to scroll through pictures. When the picture you want is displayed, press OK.

- 5 Press $\blacktriangle/\blacktriangledown$ to highlight Exit, then press OK.

The tag name appears with the picture. A plus (+) means the picture has more than one tag. When you transfer the tagged pictures/videos to your computer, EasyShare software opens and categorizes your pictures/videos with the appropriate tags.

Pre-tagging

Use the Set Tag feature to pre-select tag names before you take pictures/videos. Then, all the pictures/videos you take are tagged with those tag names. When Set Tag is in use, the tag appears while you are taking pictures/videos.

Tagging pictures/videos as favorites

Tag pictures as favorites

- 1 Press the Review button. Press ◀/▶ to find a picture.
- 2 Press the Menu button, highlight Favorite, then press OK.

The Favorite icon ♥ appears in the status area. To remove the tag, press OK again.

View favorites on your camera

- 1 Press the Review button, then the Menu button.
- 2 Choose Search, then Favorites.

5

Transferring and printing pictures

Installing the software



CAUTION:

Install EasyShare software *before* connecting the camera to the computer. Failure to do so may cause the software to load incorrectly.

- 1 Close all software applications that are open on your computer (including anti-virus software).
- 2 Place the EasyShare software CD into the CD-ROM drive.
- 3 Load the software:

Windows OS—if the install window does not appear, choose Run from the Start menu and type **d:\setup.exe** where **d** is the drive letter that contains the CD.

Mac OS X—double-click the CD icon on the desktop, then click the Install icon.

NOTE: You may need to download some Mac OS software versions. Visit www.kodak.com/go/easysharesw.

- 4 Follow the on-screen instructions to install the software.

NOTE: When prompted, take few minutes to electronically register your camera and software. To register later, visit www.kodak.com/go/register.

- 5 If prompted, restart the computer. If you turned off anti-virus software, turn it back on. See the anti-virus software manual for details.

For information on the software applications included on the EasyShare software CD, click the Help button in EasyShare software.

Transferring pictures with the USB cable

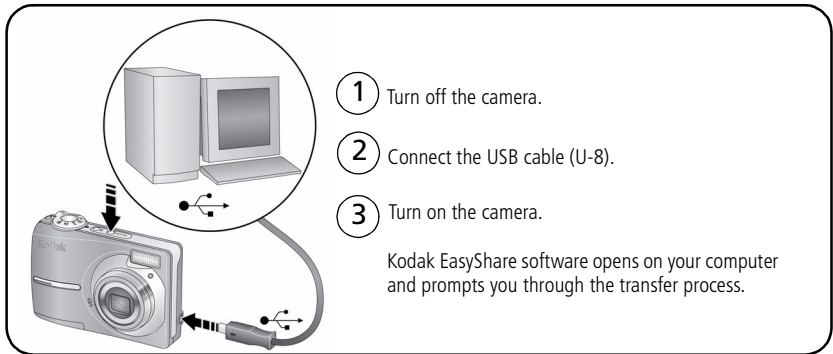

NOTE: Visit www.kodak.com/go/howto for an online tutorial on connecting.

Also available for transferring

You can also use these Kodak products to transfer your pictures and videos.

- Kodak EasyShare camera dock, Kodak EasyShare printer dock (see [page 35](#))
- Kodak multi-card reader, Kodak SD multimedia card reader-writer

Purchase these and other accessories at a dealer of Kodak products or visit www.kodak.com/go/c913accessories, www.kodak.com/go/cd913accessories.

Printing pictures

Printing with a Kodak EasyShare printer dock

Dock your camera to the Kodak EasyShare printer dock and print directly—with or without a computer. Purchase this and other accessories at a dealer of Kodak products or visit www.kodak.com/go/c913accessories, www.kodak.com/go/cd913accessories.

Direct printing with a PictBridge enabled printer

Your camera is compatible with PictBridge technology, so you can print directly to PictBridge enabled printers. You need:

- Camera with fully charged batteries
- PictBridge enabled printer
- USB cable (may be sold separately)

Connecting the camera to a PictBridge enabled printer

- 1 Turn off the camera and printer.
- 2 Connect the appropriate USB cable from the camera to the printer. (See your printer user guide or visit www.kodak.com/go/c913accessories, www.kodak.com/go/cd913accessories)

Printing from a PictBridge enabled printer

- 1 Turn on the printer. Turn on the camera.

The PictBridge logo is displayed, followed by the current picture and menu. (If no pictures are found, a message is displayed.) If the menu interface turns off, press any button to redisplay it.

- 2 Press ▲/▼ to choose a printing option, then press OK.

Current Picture—Press ◀/▶ to choose a picture. Choose the number of copies.

Tagged Pictures—If your printer is capable, print pictures that you tagged for printing and choose a print size.

Index Print—Print thumbnails of all pictures. This option requires one or more sheets of paper. If the printer is capable, choose a print size.

All Pictures—Print all pictures in internal memory, on a card. Choose the number of copies.

Image Storage—Access internal memory, a card.

NOTE: During direct printing, pictures are not permanently transferred or saved to the computer or printer.

Disconnecting the camera from a PictBridge enabled printer

- 1 Turn off the camera and printer.
- 2 Disconnect the USB cable from the camera and the printer.

Using a printer that is not PictBridge enabled

For details on printing pictures from your computer, click the Help button in EasyShare software.

Ordering prints online

Kodak Gallery (www.kodakgallery.com) is one of the many online print services offered in the Kodak EasyShare software. You can easily:

- Upload your pictures.
- Edit, enhance, and add borders to your pictures.
- Store pictures, and share them with family and friends.
- Order high-quality prints, photo greeting cards, frames, and albums—and have them delivered to your door.

Printing from an optional SD card

- Automatically print tagged pictures when you insert your card into a printer with an SD card slot. See your printer user's guide for details.
- Make prints at an SD-capable Kodak picture maker/picture kiosk. (Contact a location before visiting. Visit www.kodak.com/go/picturemaker.)

- Take the card to your local photo retailer for professional printing.

Dock compatibility for your camera

To see which Kodak EasyShare docks are compatible with your camera, visit www.kodak.com/go/dockcompatibility.

Purchase camera docks, printer docks, and other accessories at a dealer of Kodak products or visit www.kodak.com/go/c913accessories, www.kodak.com/go/cd913accessories.

6

Troubleshooting

For step-by-step product support, visit www.kodak.com/go/c913support, www.kodak.com/go/cd913support and select Interactive Troubleshooting & Repairs.

Camera problems

If...	Try one or more of the following
Camera does not turn on.	<ul style="list-style-type: none"> ■ Install new batteries (see page 1). ■ Charge rechargeable batteries.
Camera does not turn off.	<ul style="list-style-type: none"> ■ Remove the battery, then reinsert or replace it. If the camera still does not function, visit www.kodak.com/go/c913support, www.kodak.com/go/cd913support and select Interactive Troubleshooting & Repairs.
Pictures remaining number does not decrease after taking a picture.	<ul style="list-style-type: none"> ■ The camera is operating normally. Continue taking pictures.
Short battery life with Kodak Ni-MH rechargeable digital camera batteries.	<ul style="list-style-type: none"> ■ Wipe the contacts with a clean, dry cloth (see page 51) before loading batteries in the camera. ■ Limit the following activities that quickly deplete battery power: reviewing pictures/videos on the LCD; excessive use of the flash. ■ If you own an EasyShare camera dock series 3 or EasyShare printer dock series 3, use the Battery Refresh feature.
Stored pictures are corrupted.	<ul style="list-style-type: none"> ■ Retake pictures. Do not remove card while the camera is accessing it. Keep rechargeable batteries charged. ■ Transfer pictures to the computer (see page 34).

If...	Try one or more of the following
In Review mode, you do not see a picture (or the expected picture) on the LCD screen.	<ul style="list-style-type: none"> ■ Check the image storage location setting (see page 27).
In Review mode, a blue or black screen is displayed instead of a picture.	<ul style="list-style-type: none"> ■ Transfer the picture to the computer (see page 34). ■ Take another picture. If problem continues, try internal memory and/or another memory card.
Shutter button does not work.	<ul style="list-style-type: none"> ■ Turn on the camera (see page 2). ■ Transfer pictures to the computer (see page 34), delete pictures from the camera (see page 14), switch image storage locations (see page 27), or insert a card with available memory (see page 3).
Picture is too light.	<ul style="list-style-type: none"> ■ Move so there is at least 2 ft (0.6 m) between the camera and the subject. ■ Decrease Exposure Compensation (see page 28).
Picture is not clear.	<ul style="list-style-type: none"> ■ Clean the lens (see page 48). ■ Make sure your camera is not in Close-up mode. ■ Move so there is at least 2 ft (0.6 m) between the camera and the subject. ■ Place the camera on a flat, steady surface or use a tripod.
Picture is too dark.	<ul style="list-style-type: none"> ■ Turn on the flash (see page 7). ■ Move so there is no more than 11.8 ft (3.6 m) in wide angle and 6.9 ft (2.1 m) in telephoto between the camera and the subject. ■ Use Fill flash (see page 7) or change your position so light is not behind the subject. ■ Increase Exposure Compensation (see page 28).
Camera does not recognize SD card.	<ul style="list-style-type: none"> ■ Purchase a certified SD card. ■ Insert a card into the slot, then push to seat (see page 3).

If...	Try one or more of the following
Camera freezes up when a card is inserted or removed.	<ul style="list-style-type: none"> ■ Turn the camera off, then back on. Make sure the camera is turned off before inserting or removing a card.
Memory card full.	<ul style="list-style-type: none"> ■ Insert a new card (see page 3). ■ Transfer pictures to the computer (see page 34). ■ Delete pictures/videos (see page 14).
Memory card and internal memory full.	<ul style="list-style-type: none"> ■ Transfer pictures to the computer (see page 34). ■ Delete pictures/videos (see page 14), or insert a new card (see page 3).

Camera/computer communications

If...	Try one or more of the following
The computer does not communicate with the camera.	<ul style="list-style-type: none"> ■ Visit www.kodak.com/go/c913support, www.kodak.com/go/cd913support. ■ Turn on the camera (see page 2). ■ Install new batteries (see page 1) or charge rechargeable batteries. ■ Connect the USB cable to camera and computer port (see page 34). ■ Install the software (see page 33). ■ Disconnect the USB cable. Close all software applications. Re-install the software (see page 33). ■ Disconnect camera from the computer. Close all software applications, reconnect camera.
Cannot transfer pictures. (The Add New Hardware Wizard cannot locate drivers.)	<ul style="list-style-type: none"> ■ Disconnect the USB cable. (If using camera dock or printer dock, disconnect cable and remove camera from dock). Close all open applications. Re-install the software (see page 33). ■ Disconnect the USB cable. Close all software applications. Re-install the software (see page 33).

LCD screen messages

If...	Try one or more of the following
No images to display	<ul style="list-style-type: none"> Change image storage location setting (see page 27).
Memory card requires formatting	<ul style="list-style-type: none"> Insert a new card (see page 3) or format the card (see page 28). <p>Caution: Formatting a card deletes all pictures and videos, including protected files.</p>
Memory card cannot be read (Please format memory card or insert another card)	
Only one USB connection allowed. Disconnect cable or rem. (remove) camera from dock.	<ul style="list-style-type: none"> Unplug the USB cable from the camera.
Internal memory requires formatting	<ul style="list-style-type: none"> Format the internal memory (see page 28). <p>Caution: Formatting deletes all pictures and videos, including protected files. (Formatting internal memory also deletes email addresses, tag names, and Favorites. To restore them, see the Kodak EasyShare software Help.)</p>
Internal memory cannot be read (Please format internal memory)	
No memory card (Files not copied)	<ul style="list-style-type: none"> Insert a card (see page 3).
Not enough space to copy files (Files not copied)	<ul style="list-style-type: none"> Delete pictures from the image storage location you are copying to (see page 14), or insert a new card (see page 3).

If...	Try one or more of the following
Memory card is locked (Insert new memory card)	<ul style="list-style-type: none"> ■ Insert a new card (see page 3), move the switch on the card to unlock the card, or change the image storage location to internal memory (see page 27).
Read-only memory card. Remove write protection to capture or write to card.	
Memory card is unusable (Insert new memory card)	<ul style="list-style-type: none"> ■ Insert a new card (see page 3).
Date and time have been reset	<ul style="list-style-type: none"> ■ Reset the clock (see page 2).
No address book on camera (Connect with computer to import address book)	<ul style="list-style-type: none"> ■ Create and copy address book from computer. See the Kodak EasyShare software Help.
No album names on camera (Connect with computer to import album names)	<ul style="list-style-type: none"> ■ Create and copy album names from computer. See the Kodak EasyShare software Help.
High camera temperature. (Camera will be turned off.)	<ul style="list-style-type: none"> ■ Leave the camera off for 10 minutes, then turn it back on. If the message reappears, visit www.kodak.com/go/c913support, www.kodak.com/go/cd913support and select Interactive Troubleshooting & Repairs.
Unrecognized file format	<ul style="list-style-type: none"> ■ Transfer the picture to the computer (see page 34), or delete it (see page 14).

If...	Try one or more of the following
Camera error #XXXX. See user's guide.	<ul style="list-style-type: none"> <li data-bbox="282 185 950 260">■ Turn camera off, then back on. If the message reappears, visit www.kodak.com/go/c913support, www.kodak.com/go/cd913support and select Interactive Troubleshooting & Repairs.

7

Getting help

Helpful links

Camera

Email, write, or phone customer support	www.kodak.com/go/contact
Get support for your product (FAQs, troubleshooting information, arrange for repairs, etc.)	www.kodak.com/go/c913support , www.kodak.com/go/cd913support
Purchase camera accessories (camera docks, printer docks, lenses, cards, etc.)	www.kodak.com/go/c913accessories , www.kodak.com/go/cd913accessories
Download the latest camera firmware and software	www.kodak.com/go/c913downloads , www.kodak.com/go/cd913downloads
See online demonstrations of your camera	www.kodak.com/go/howto

Software

Get information on EasyShare software	www.kodak.com/go/easysharesw (or click the Help button in EasyShare software)
Get help with the Windows operating system and working with digital pictures	www.kodak.com/go/pcbasics

Other

Get support for other cameras, software, accessories	www.kodak.com/go/support
Get information on Kodak EasyShare printer docks	www.kodak.com/go/printerdocks
Get information on Kodak inkjet products	www.kodak.com/go/inkjet
Optimize your printer for truer, more vibrant colors	www.kodak.com/go/onetouch
Register your camera	www.kodak.com/go/register

NOTE: If you have questions concerning this product, you may speak with Kodak customer support.

Australia	1800 267 588	Netherlands	020 346 9372
Austria	0179 567 357	New Zealand	0800 880 120
Belgium	02 713 14 45	Norway	23 16 21 33
Brazil	0800 891 42 13	Philippines	1 800 1 888 9600
Canada	1 800 465 6325	Poland	00800 4411625
China	800 820 6027	Portugal	021 415 4125
Czech Republic	00 800 56325000	Russia	8 495 929 9166
Denmark	3 848 71 30	Singapore	800 6363 036
Finland	0800 1 17056	Slovakia	00 800 56325000
France	01 55 1740 77	Spain	91 749 76 53
Germany	069 5007 0035	Sweden	08 587 704 21
Greece	00800 44140775	Switzerland	01 838 53 51
Hong Kong	800 901 514	Taiwan	0800 096 868
Hungary	06 80 456 325	Thailand	001 800 631 0017
India	91 80 41374555 (toll free 000800 440 1227)	Turkey	00800 448827073
Ireland	01 407 3054	United Kingdom	0870 243 0270
Italy	02 696 33452	United States	1 800 235 6325
Japan	03 5540 9002	International Toll Line	+44 131 458 6714
Korea	080 708 5600	International Toll Fax	+44 131 458 6962

Camera specifications

For more specifications, visit www.kodak.com/go/c913support,
www.kodak.com/go/cd913support.

CCD—1/2.5 in. CCD, 4:3 aspect ratio; 9.5 MP (total), 9.2 MP (effective)

Picture sizes—

C913

9.0 MP (4:3): 3472 x 2604 pixels

8.0 MP (3:2): 3472 x 2315 pixels

6.8 MP (16:9): 3472 x 1953 pixels

5.0 MP (4:3): 2592 x 1944 pixels

3.1 MP (4:3): 2048 x 1536 pixels

2.2 MP (3:2): 1800 x 1200 pixels

2.1 MP (16:9): 1920 x 1080 pixels

1.2 MP (4:3): 1280 x 960 pixels

Color display—6.1 cm (2.4 in.); 115K (480 x 240) pixels; 30 fps;
field-of-view: 100%.

Taking lens—3X optical zoom lens f/2.7–f/4.8;
36 mm–108 mm (35 mm equivalent)

Lens barrier—Automatic built-in

Focus system—TTL-AF; selectable multi-zone AF, center-zone AF. Working range:

0.6 m (2 ft)–infinity @ normal

0.13–0.7 m (5–28 in.) @ close-up/macro, wide

0.22–0.7 m (8.7–28 in.) @ close-up/macro, tele

10 m (32.8 ft)–infinity @ Landscape

Digital zoom—5.0X continuous with 0.2X increments

Exposure metering—Multi-pattern, Center-weight, Center-spot

Exposure compensation—+/-2.0 EV with 0.5 EV steps

Shutter speed—Mechanical shutter with CCD; Auto: 1/2–1/1400 sec.

ISO speed—Auto: 80–160, (Blur Reduction, High ISO: 80–1000)

Manual: 80, 100, 200, 400, 800, 1000

Electronic flash—Guide no. 7.0 (@ ISO 100); auto flash working range at ISO 200:

Wide: 0.6–3.6 m (2–11.8 ft.); Tele: 0.6–2.1 m (2–6.9 ft.)

Flash modes—Auto, Fill, Red-eye, Off

Capture modes—SCN, Blur Reduction, Auto, Landscape, Close-up, Video

Video capture—VGA (640 x 480) @ 15 fps; QVGA (320 x 240) @ 30 fps

Image file format—Still: EXIF 2.21 (JPEG compression); file organization: DCF

Video: MOV; CODEC Motion JPEG; G.711 (audio)

Image storage—Optional SD Card . (The SD logo is a trademark of the SD Card Association.)

Internal storage capacity—16 MB internal memory/11 MB available for image storage (1 MB equals one million bytes)

Power—(2) Kodak oxy-alkaline digital camera batteries AA; (2) Kodak Ni-MH rechargeable digital camera batteries AA; (1) Kodak Ni-MH rechargeable digital camera battery KAA2HR; (2) alkaline batteries AA; (2) lithium batteries AA

Communication with computer—USB 2.0 Full Speed (PIMA 15740 protocol), via USB cable model U-8, EasyShare camera dock or printer dock

PictBridge support—Yes

Self Timer—2 seconds, 10 seconds, or 2-shot

White balance—Auto, Daylight, Tungsten, Fluorescent, Open Shade

Auto power off—Selectable 1, 3, 5, 10 minutes

Microphone—Yes (for audio recording at Video mode)

Color modes—Color, Black & White, Sepia

Tripod mount—1/4 inch

Operating temperature—32–104°F (0–40°C)

Size—91.1 mm (3.6 in.) x 62.2 mm (2.4 in.) x 25.3 mm (1.0 in.) @ power off

Weight—137 g (4.8 oz) without battery or card

Care and maintenance

- If you suspect water has gotten inside the camera, remove the battery and card. Allow all components to air-dry for at least 24 hours before using the camera.
- Blow gently on the lens or LCD to remove dust and dirt. Wipe gently with a soft, lint-free cloth or an untreated lens-cleaning tissue. Do not use cleaning solutions unless designed specifically for camera lenses. Do not allow chemicals, such as suntan lotion, to contact painted surfaces.
- Service agreements may be available in your country. Contact a dealer of Kodak products for more information.
- For digital camera disposal or recycling information, contact your local authorities. In the US, visit the Electronics Industry Alliance Web site at www.eiae.org or the Kodak Web site at www.kodak.com/go/c913support, www.kodak.com/go/cd913support.

Upgrading your software and firmware

Download the latest versions of the software included on the Kodak EasyShare software CD and the camera firmware (the software that runs on the camera). Visit www.kodak.com/go/c913downloads, www.kodak.com/go/cd913downloads.

Storage capacities

The LCD displays the approximate number of pictures (or minutes/seconds of video) remaining. For average SD card capacities, visit www.kodak.com/go/SDcapacities. Actual storage capacity varies depending on subject composition, card size, and other factors. You may be able to store more or fewer pictures and videos. Favorites take up additional space in internal memory.

Important safety instructions



CAUTION:

Do not disassemble this product; there are no user-serviceable parts inside. Refer servicing to qualified service personnel. Kodak AC adapters and battery chargers are intended for indoor use only. The use of controls, adjustments, or procedures other than those specified herein may result in exposure to shock and/or electrical or mechanical hazards. If the LCD breaks, do not touch the glass or liquid. Contact Kodak customer support.

- The use of an accessory that is not recommended by Kodak may cause fire, electric shock, or injury. For approved accessories, visit www.kodak.com/go/accessories.
- Use only a USB-certified computer equipped with a current-limiting motherboard. Contact your computer manufacturer if you have questions.
- If using this product in an airplane, observe all instructions of the airline.
- When removing the battery, allow it to cool; it may be hot.
- Read and follow all warnings and instructions supplied by the battery manufacturer.

- Use only batteries approved for this product to avoid risk of explosion.
- Keep batteries out of the reach of children.
- Do not allow batteries to touch metal objects, including coins. Otherwise, a battery may short circuit, discharge energy, become hot, or leak.
- Do not disassemble, install backward, or expose batteries to liquid, moisture, fire, or extreme temperature.
- Remove the battery when the product is stored for an extended period of time. In the unlikely event that battery fluid leaks inside the product, contact Kodak customer support.
- In the unlikely event that battery fluid leaks onto your skin, wash immediately with water and contact your local health provider. For additional health-related information, contact your local Kodak customer support.
- Dispose of batteries according to local and national regulations. Visit www.kodak.com/go/kes.
- Do not charge non-rechargeable batteries.

For more information on batteries, visit www.kodak.com/go/batterytupes.

Battery life

Battery	Pictures
(2) lithium batteries AA	700
(1) Kodak Ni-MH rechargeable digital camera battery KAA2HR	380-450
(2) Kodak Ni-MH rechargeable digital camera batteries AA	380-450
(2) Kodak oxy-alkaline digital camera batteries AA	250-300
(2) alkaline batteries AA	150-200

* Approximate number of pictures in Auto mode (CIPA testing method using internal memory.) For acceptable battery life, and to make sure your camera operates dependably, use the batteries listed. Actual battery life may vary based on usage.

Extending battery life

- See Auto Power Off (see page 27).
- Limit the following activities that quickly deplete battery power:
 - Reviewing your pictures on the LCD (see page 12)
 - Excessive use of the flash
- Dirt on the battery contacts can affect battery life. Wipe the contacts with a clean, dry cloth before loading batteries in the camera.
- Battery performance is reduced at temperatures below 41° F (5° C). When using your camera in cold weather, carry spare batteries and keep them warm. Do not discard cold batteries that do not work; when they return to room temperature, they may be usable.

Limited Warranty

Kodak warrants Kodak consumer electronic products and accessories ("Products"), excluding batteries, to be free from malfunctions and defects in both materials and workmanship for one year from the date of purchase. Retain the original dated sales receipt. Proof of the date of purchase will be required with any request for warranty repair.

Limited warranty coverage

Warranty service is only available from within the country where the Products were originally purchased. You may be required to ship Products, at your expense, to the authorized service facility for the country where the Products were purchased. Kodak will repair or replace Products if they fail to function properly during the warranty period, subject to any conditions and/or limitations stated herein. Warranty service will include all labor as well as any necessary adjustments and/or replacement parts. If Kodak is unable to repair or replace a Product, Kodak will, at its option, refund the purchase price paid for the Product provided the Product has been returned to Kodak along with proof of the purchase price paid. Repair, replacement, or refund of the purchase price are the sole remedies under the warranty. If replacement parts are

used in making repairs, those parts may be remanufactured, or may contain remanufactured materials. If it is necessary to replace the entire Product, it may be replaced with a remanufactured Product. Remanufactured Products, parts, and materials are warranted for the remaining warranty term of the original Product, or 90 days after the date of repair or replacement, whichever is longer.

Limitations

This warranty does not cover circumstances beyond Kodak's control. This warranty does not apply when failure is due to shipping damage, accident, alteration, modification, unauthorized service, misuse, abuse, use with incompatible accessories or attachments (such as third party ink or ink tanks), failure to follow Kodak's operation, maintenance, or repacking instructions, failure to use items supplied by Kodak (such as adapters and cables), or claims made after the duration of this warranty.

Kodak makes no other express or implied warranty for this product, and disclaims the implied warranties of merchantability and fitness for a particular purpose. In the event that the exclusion of any implied warranty is ineffective under the law, the duration of the implied warranty will be one year from the purchase date or such longer period as required by law.

The option of repair, replacement, or refund is Kodak's only obligation. Kodak will not be responsible for any special, consequential or incidental damages resulting from the sale, purchase, or use of this product regardless of the cause. Liability for any special, consequential or incidental damages (including but not limited to loss of revenue or profit, downtime costs, loss of the use of the equipment, cost of substitute equipment, facilities or services, or claims of your customers for such damages resulting from the purchase, use, or failure of the Product), regardless of cause or for breach of any written or implied warranty is expressly disclaimed.

Your rights

Some states or jurisdictions do not allow exclusion or limitation of incidental or consequential damages, so the above limitation or exclusion may not apply to you. Some states or jurisdictions do not allow limitations on how long an implied warranty lasts, so the above limitation may not apply to you.

This warranty gives you specific rights, and you may have other rights which vary from state to state or by jurisdiction.

Outside the United States and Canada

In countries other than the United States and Canada, the terms and conditions of this warranty may be different. Unless a specific Kodak warranty is communicated to the purchaser in writing by a Kodak company, no warranty or liability exists beyond any minimum requirements imposed by law, even though defect, damage, or loss may be by negligence or other act.

Regulatory compliance

FCC compliance and advisory



Kodak EasyShare C913/CD913 digital camera

This equipment has been tested and found to comply with the limits for a Class B digital device, pursuant to Part 15 of the FCC Rules. These limits are designed to provide reasonable protection against harmful interference in a residential installation.

This equipment generates, uses, and can radiate radio frequency energy and, if not installed or used in accordance with the instructions, may cause harmful interference to radio communications. However, there is no guarantee that interference will not occur in a particular installation.

If this equipment does cause harmful interference to radio or television reception, which can be determined by turning the equipment off and on, the user is encouraged to try to correct the interference by one or more of the following measures: 1) reorient

www.kodak.com/go/support

or relocate the receiving antenna; 2) increase the separation between the equipment and the receiver; 3) connect the equipment to an outlet on a circuit different from that to which the receiver is connected; 4) consult the dealer or an experienced radio/TV technician for additional suggestions.

Any changes or modifications not expressly approved by the party responsible for compliance could void the user's authority to operate the equipment. Where shielded interface cables have been provided with the product or specified additional components or accessories elsewhere defined to be used with the installation of the product, they must be used in order to ensure compliance with FCC regulation.

Australian C-Tick



Canadian DOC statement

DOC Class B Compliance—This Class B digital apparatus complies with Canadian ICES-003.

Observation des normes-Classe B—Cet appareil numérique de la classe B est conforme à la norme NMB-003 du Canada.

Waste Electrical and Electronic Equipment labeling



In Europe: For human/environmental protection, it is your responsibility to dispose of this equipment at a collection facility established for this purpose (separate from municipal waste). For more information, contact your retailer, collection facility, or appropriate local authorities; or visit www.kodak.com/go/recycle. (Product weight: 137g.)

Korean Class B ITE

이 기기는 가정용으로 전자파적합등록을 한 기기로서 주거지역에서는 물론 모든 지역에서 사용할 수 있습니다.

China RoHS

环保使用期限 (EPUP)

在中国大陆, 该值表示产品中存在的任何危险物质不得释放, 以免危及人身健康、财产或环境的时间期限(以年计)。该值根据操作说明中所规定的产品正常使用而定。

有毒有害物质或元素名称及含量标识表						
部件名称	有毒有害物质或元素					
	铅	汞	镉	六价铬	多溴联苯	多溴二苯醚
数码相机电路板元件	×	○	○	○	○	○
○: 表示该有毒有害物质在该部件所有均质材料中的含量均在SJ/T 11363-2006规定的限量要求以下。 ×: 表示该有毒有害物质至少在该部件的某一均质材料中的含量超出SJ/T 11363-2006规定的限量要求。						



USB 数据线

VCCI Class B ITE

この装置は、情報処理装置等電波障害自主規制協議会（VCCI）の基準に基づきクラスB情報技術装置です。この装置は、家庭環境で使用することを目的としていますが、この装置がラジオやテレビジョン受信機に近接して使用されると、受信障害を引き起こすことがあります。
取扱説明書に従って正しい取り扱いをして下さい。

Russian GOST-R



Eastman Kodak Company
Rochester, NY 14650

Фотокамера изготовлена в Китае, остальные элементы -
в соответствии с маркировкой.

Index

A

- about picture, video, 13
- about this camera, 28
- accessories, 34
 - battery, 51
 - buying, 44
 - printer dock, 35
 - SD card, 3
- appendix, 46
- auto, 8
 - flash, 7
 - focus framing marks, 5

B

- backlight, 9
- battery
 - compartment, ii
 - extending life, 51
 - loading, 1
 - types, 47
- beach, 9
- blur, 23
- blur warning, 28
- button
 - delete, ii, 4
 - flash/status, 7
 - LCD/info, ii
 - menu, ii
 - ok, ii
 - on/off, i
 - review, ii, 12
 - share, ii

- shutter, i
- zoom, ii, 6

C

- cable, USB, 34
- camera sounds, 27
- caring for your camera, 48
- children, 9
- clock, setting, 2
- color mode, 26
- compatibility, dock, 37
- copy pictures
 - card to memory, 20
 - memory to card, 20
 - to computer, 33
- cropping pictures, 16
- customer support, 44, 45
- customizing camera settings, 26

D

- date
 - setting, 2
 - stamp, 28
- delete button, ii
- deleting
 - during quickview, 4
 - from internal memory, 14
 - from SD card, 14
 - protecting pictures, videos, 14
- digital image stabilization, 8
- digital zoom, using, 6
- displaying slide show, 18

disposal, recycling, 48, 54
dock
 compatibility, 37
 connector, ii
 printer, 35
doing more with your camera, 24
download pictures, 33

E
EasyShare software
 installing, 33
emailing pictures, videos, 30
exposure
 compensation, 28

F
favorites
 tagging, 32
filter pictures, videos, 21
fireworks, 9
firmware, upgrading, 49
flash
 settings, 7
flower, 9
focus
 framing marks, 5
 zone, 26
format, 28
framing grid, 29

G
grid, framing, 29
guidelines, battery, 51

H
help, 38
 web links, 44
high ISO, 9

I
icon
 blur, 23
icons, mode dial, 8
image storage, 27
information
 about pictures, videos, 13
installing
 batteries, 1
 SD card, 3
 software, 33
internal memory
 storage capacity, 49
ISO speed, 25

K
Kodak
 EasyShare software, 33, 49
 Perfect Touch technology, 15
 web sites, 44

L
LCD, ii
 brightness, 27
 reviewing pictures, 12
 reviewing videos, 12
LCD/info button, ii
lens
 cleaning lens, 48
loading

batteries, 1
SD card, 3
software, 33

M

Macintosh computers, installing
 software on, 33
maintenance, camera, 48
manner/museum, 9
memory
 inserting card, 3
 storage capacities, 49
menu button, ii
microphone, i
mode dial, i, 8
modes
 auto, 8
 backlight, 9
 beach, 9
 children, 9
 fireworks, 9
 flower, 9
 high ISO, 9
 manner/museum, 9
 night landscape, 9
 night portrait, 9
 portrait, 9
 SCN, 8
 self-portrait, 9
 snow, 9
 sports, 9
 sunset, 9
 text/document, 9
multiple selections, 20

N

night landscape, 9
night portrait, 9

O

ok button, ii
on/off button, i
online prints, ordering, 36
optical zoom, 6

P

Perfect Touch technology, 15
PictBridge enabled printer, 35
pictures
 checking settings, 22
 copying, 20
 cropping, 16
 deleting, 14
 emailing tagged, 30
 printing, 36
 protecting, 14
 reviewing, 12
 rotating, 16
 storage capacity, 49
 taking, modes, 8
 transfer, 33
picture-taking settings, 24
portrait, 9
power, camera, 2
printer dock, 35
printing
 from a card, 36
 from computer, 36
 optimizing printer, 44

order online, 36
PictBridge technology, 35
tagged pictures, 36
with EasyShare printer dock, 35
problem-solving, 38
protecting pictures, videos, 14

Q

quickview, using, 4

R

recycling, disposal, 48, 54
red-eye, flash, 7
regulatory information, 53
repair, 44
review button, ii, 12
reviewing pictures
as you take them, 4
deleting, 14
LCD, 12
protecting, 14
slide show, 18
reviewing videos
deleting, 14
LCD, 12
protecting, 14
slide show, 18
rotating pictures, 16
running slide show, 18

S

scene modes, 8
SCN, 8
SD card
inserting, 3

printing from, 36
storage capacities, 49
search pictures, videos, 21
select multiple pictures/videos, 20
self-portrait, 9
self-timer light, i
service and support telephone
numbers, 45
setting
about, 28
blur warning, 28
camera sounds, 27
color mode, 26
date and time, 2
date stamp, 28
flash, 7
focus zone, 26
image storage, 27
ISO, 25
LCD brightness, 27
picture taking mode, 8
video size, 26
white balance, 25
setting, tags, 27
settings
picture taking, 24
setup mode, using, 26
shaking hand, 23
share button, ii
sharing pictures, videos, 29
shutter
button, i
problems, 39
slide show

- continuous loop, 19
 - running, 18
- snow, 9
- software
 - installing, 33
 - upgrading, 49
- sounds, 27
- specifications, camera, 46
- sports, 9
- status
 - blur, 23
- storage capacity, 49
- strap post, ii
- sunset, 9
- support, technical, 44, 45

T

- tag
 - favorites, 32
 - for email, 30
 - for print, 30
- tags
 - set, 27
- telephone support, 45
- text/document, 9
- time, setting, 2
- tips
 - care & maintenance, 48
 - transferring pictures, videos, 33
 - trash can, deleting, 4
 - tripod socket, ii
 - troubleshooting, 38
 - turning camera on and off, 2

U

- upgrading software, firmware, 49
- URLs, Kodak web sites, 44
- USB cable, 34

V

- VCCI compliance, 55
- video
 - action print, 18
 - checking settings, 22
 - copying, 20
 - deleting, 14
 - emailing tagged, 30
 - making a picture, 17
 - protecting, 14
 - reviewing, 12
 - size, 26
 - storage capacities, 49
 - viewing, 12
- videos
 - transfer, 33
- viewing
 - by date, tag, 21
 - viewing picture
 - after taking, 4, 12
 - viewing picture, video information, 13

W

- warranty, 51
- WEEE, 54
- white balance, 25
- Windows OS-based computers
 - installing software, 33
- wrist strap, 1

Z

zoom

digital, 6

optical, 6

zoom button, ii

Free Manuals Download Website

<http://myh66.com>

<http://usermanuals.us>

<http://www.somanuals.com>

<http://www.4manuals.cc>

<http://www.manual-lib.com>

<http://www.404manual.com>

<http://www.luxmanual.com>

<http://aubethermostatmanual.com>

Golf course search by state

<http://golfingnear.com>

Email search by domain

<http://emailbydomain.com>

Auto manuals search

<http://auto.somanuals.com>

TV manuals search

<http://tv.somanuals.com>