

DVD-Video Player / Video Cassette Recorder Owner's Manual

DVD755VR/05



Read this manual first!

Congratulations on purchasing this Philips product.

We've included everything you need to get started.

If you have any problems, Philips representatives can help you get the most from your new product by explaining:

- Hookups,
- First time setup, and
- Operation.

For fast help, call us first!

Tel: see back page of this manual

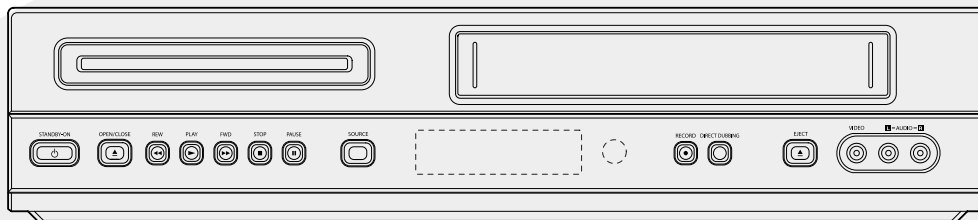

Let's make things better.



PHILIPS

Safety Precautions



CAUTION
RISK OF ELECTRIC SHOCK
DO NOT OPEN



CAUTION: TO REDUCE THE RISK OF ELECTRIC SHOCK DO NOT REMOVE COVER (OR BACK) NO USER-SERVICEABLE PARTS INSIDE REFER SERVICING TO QUALIFIED SERVICE PERSONNEL.



This lightning flash with arrowhead symbol within an equilateral triangle is intended to alert the user to the presence of uninsulated dangerous voltage within the product's enclosure that may be of sufficient magnitude to constitute a risk of electric shock to persons.



The exclamation mark within an equilateral triangle is intended to alert the user to the presence of important operating and maintenance (servicing) instructions in the literature accompanying the product.

WARNING: TO REDUCE THE RISK OF FIRE OR ELECTRIC SHOCK, DO NOT EXPOSE THIS PRODUCT TO RAIN OR MOISTURE.

WARNING: Do not install this equipment in a confined space such as a book case or similar unit.

CLASS 1 LASER PRODUCT
KLASSE 1 LASER PRODUKT
LUOKAN 1 LASER LAITE
KLASS 1 LASER APPARAT
CLASSE 1 PRODUIT LASER

CAUTION:

This Digital Video Disc Player employs a Laser System.

To ensure proper use of this product, please read this owner's manual carefully and retain for future reference, should the unit require maintenance, contact an authorized service location-see service procedure.

Use of controls, adjustments or the performance of procedures other than those specified herein may result in hazardous radiation exposure.

To prevent direct exposure to laser beam, do not try to open the enclosure. Visible laser radiation when open. **DO NOT STARE INTO BEAM.**

CAUTION: The apparatus shall not be exposed to water, dripping or splashing and that no objects filled with liquids, such as vases, shall be placed on the apparatus.



This product is manufactured to comply with the radio interference requirements of EEC DIRECTIVE 89/336/EEC, 93/68/EEC and 73/23/EEC.



Notes on copyrights:

It is forbidden by law to copy, broadcast, show, broadcast via cable, play in public, or rent copyright material without permission.

This product features the copy protection function developed by Macrovision. Copy protection signals are recorded on some discs.

This product incorporates copyright protection technology that is protected by method claims of certain U.S. patents and other intellectual property rights owned by Macrovision Corporation and other rights owners. Use of this copyright protection technology must be authorized by Macrovision Corporation, and is intended for home and other limited viewing uses only unless otherwise authorized by Macrovision Corporation. Reverse engineering or disassembly is prohibited.

SERIAL NUMBER: The serial number is found on the back of this unit. This number is unique to this unit and not available to others. You should record requested information here and retain this guide as a permanent record of your purchase.

Model No. _____

Serial No. _____

Features:

- Complete versatility to play DVD, VCDs, audio CDs or VHS Tapes.
- Watch a DVD while recording a TV show to the VCR.
- Remote controls DVD and VCR decks.
- Records from DVD to VHS (unless DVD is copy protected with Macrovision).
- Hi-Fi Stereo VCR.

Important Note

DK

Advarsel:

Laserrudstråling ved åbning når sikkerhesafbrydere er ude af funktion. Undgå u tsættelse for stråling.

Bemærk:

Netafbryderen POWER er sekundært indkoblet og afbryder ikke strømmen fra nettet. Den indbyggede netdel er derfor tilsluttet til lysnettet så længe netstikket sidder i stikkontakten.

N

Observer:

Nettbryteren POWER er sekundært innkoplet. Den innebygdenetdelen er derfor ikke frakoplet nettet så længe apparatet er tilsluttet nettkontakten.

S

Klass 1 laserapparat

Varning!

Om apparaten används på annat sätt än i denna bruksanvisning specificerats, kann användaren utsättas för laserstråling, som överskrider gränsen för läserklass 1.

Observera!

Strömbrytaren POWER är sekundärt kopplad och inte bryter strömmen från nätet. Den inbyggda nät delen är därför ansluten till elnätet så länge stickproppen sitter i v ägguttaget.

SF

Luokan 1 laserlaite + Klass 1 laserapparat

Varoitus!

Laitteen käyttäminen muulla kuin tässä käyttöohjeessa mainitulla tavalla saattaa altistaa käyttäjän turvallisuusluokan 1 ylittävälle lasersäteilille.

Huom.

Toiminnanvalitsin POWER on kytketty toisiopuolelle, eikä se kytke laitetta irti sähköverkosta. Sisäänrakennettu verkko-osa on kytkettyinä sähköverkkoon aina silloin, kun pistoke on pistorasiassa.

Important Note for Users in the UK

Mains plug

This apparatus is fitted with an approved 13 Amp plug. To change a fuse in this type of plug proceed as follows:

- 1 Remove fuse cover and fuse.
- 2 Fix new fuse which should be a BS1362 5 Amp, A.S.T.A. or BSI approved type.
- 3 Refit the fuse cover.

If the fitted plug is not suitable for your socket outlets, it should be cut off and an appropriate plug fitted in its place.

If the mains plug contains a fuse, this should have a value of 5 Amp. If a plug without a fuse is used, the fuse at the distribution board should not be greater than 5 Amp.

Note: The severed plug must be disposed of to avoid a possible shock hazard should it be inserted into a 13 Amp socket elsewhere.

How to connect a plug

The wires in the mains lead are coloured with the following code: blue = neutral (N), brown = live (L).

As these colours may not correspond with the colour markings identifying the terminals in your plug, proceed as follows:

- Connect the blue wire to the terminal marked N or coloured black.
- Connect the brown wire to the terminal marked L or coloured red.
- Do not connect either wire to the earth terminal in the plug, marked E (or e) or coloured green (or green and yellow).

Before replacing the plug cover, make certain that the cord grip is clamped over the sheath of the lead - not simply over the two wires.

Copyright in the U.K.

Recording and playback of material may require consent. See Copyright Act 1956 and The Performer's Protection Acts 1958 to 1972.

Contents

Introduction

Safety Precautions	2
General Information	3
Before Use	5-6
Playable Discs	5
Remote Control Operation Range	5
Precautions	6
Notes on Discs	6
About Symbols	6
Selecting the Viewing Source.....	6
Front Panel and Display Window	7
Remote Control	8
Rear Panel	9

Preparation

Connections	10-11
Connecting to a TV	10
Connecting to Optional Equipment	11
Before Operation - VCR part.....	12-16
Tuning in a video channel on your TV	12
Using your DVD+VCR for the very first time.....	12
Setting the clock Manually.....	13
To set the colour system.....	13
How to using the main menu.....	14
Tuning in TV stations Automatically	14
Tuning in TV stations Manually	15
Changing the other of TV stations	16
Deleting TV stations	16
Before Operation - DVD part	17-20
General Explanation	17
On-Screen Display.....	17
Initial Settings	18-20
● General Operation	18
● Language	18
● Picture	18
● Sound	19
● Others	19
● Parental Control	20

Operation



Operation with Tape	21-24
Playing a tape	21
● OPR (Optimum Picture Response)	21
Instant Timer Recording (ITR)	22
VIDEO Plus+ Programming	23
Timer recording using On Screen Display	24
Operation with DVD and Video CD	25-27
Playing a DVD and Video CD	25
General Features	25
● Moving to another TITLE	25
● Moving to another CHAPTER/TRACK	25
● Search.....	25
● Still Picture and Frame-by-Frame Playback.....	25
● Slow Motion	26
● Shuffle.....	26
● Repeat	26
● Repeat A-B	26
● Time Search	26
● 3D Surround.....	26
● Screen Saver	26
● Zoom	27
● Marker Search	27
Special DVD Features.....	27

● Title Menu	27
● Disc Menu	27
● Camera Angle.....	27
● Changing the Audio Language	27
● Changing the Audio Channel	27
● Subtitles	27
Operation with Audio and MP3 Disc	28-29
Playing an Audio CD and MP3 Disc	28-29
● Notes on MP3 Recordings	28
● Pause	29
● Moving to another Track.....	29
● Repeat Track/All/Off.....	29
● Search.....	29
● Shuffle.....	29
● Repeat A-B	29
● 3D Surround.....	29
● Changing the Audio Channel	29
Operation with JPEG Disc.....	30
Viewing a JPEG disc	30
● Moving to another File.....	30
● Still Picture	30
● To flip the picture	30
● To rotate Picture	30
● Notes on JPEG Recordings.....	30
Programmed Playback.....	31
Programmed Playback with Audio CD and MP3 Disc	31
Programmed Playback with Video CD	31
● Repeat Programmed Tracks	31
● Erasing a Track from Program list	31
● Erasing the Complete Program list.....	31
Additional Operation	32-33
On Screen Display.....	32
Tape Counter Memory Stop	32
Child Lock.....	32
Video Doctor (Self-Diagnosis)	32
Hi-Fi Stereo Sound System	33
Wide Screen Compatibility 16:9	33
Last Condition Memory.....	33
Special Recording	34
Copying from DVD to VCR	34
Recording from another video recorder.....	34



Reference

Troubleshooting	35
Language Code List	36
Country/Area Code list	37
Specification	38

About the symbols for instructions

-  Indicates hazards likely to cause harm to the unit itself or other material damage.
-  Indicates special operating features of this unit.
-  Indicates tips and hints for making the task easier.

Playable Discs

	DVD (8 cm / 12 cm disc)
	Video CD (VCD) (8 cm / 12 cm disc)
	Audio CD (8 cm / 12 cm disc)

In addition, this unit can play a DVD-R, DVD±RW, Kodak PICTURE CD, SVCD, and CD-R or CD-RW that contains audio titles, MP3 or JPEG files.

Notes

- Depending on the conditions of the recording equipment or the CD-R/RW (or DVD-R/±RW) disc itself, some CD-R/RW (or DVD-R/±RW) discs cannot be played on the unit.
- Do not attach any seal or label to either side (the labeled side or the recorded side) of a disc.
- Do not use irregular shaped CDs (e.g., heart-shaped or octagonal). It may result in malfunctions.

Notes on DVDs and Video CDs

Some playback operations of DVDs and Video CDs may be intentionally fixed by software manufacturers. As this unit plays DVDs and Video CDs according to disc content designed by the software manufacturer, some playback features of the unit may not be available, or other functions may be added.

Refer also to the instructions applied with the DVDs and Video CDs. Some DVDs made for business purposes may not be played on the unit.

Regional code of the DVD player and DVDs

This DVD player is designed and manufactured for playback of region “2” encoded DVD software.

The region code on the labels of some DVD discs indicates which type of player can play those discs. This unit can play only DVD discs labeled “2” or “ALL”. If you try to play any other discs, the message “Check Regional Code” will appear on the TV screen. Some DVD discs may not have a region code label even though their playback is prohibited by area limits.



Disc-related terms

Title (DVD only)

The main film content or accompanying feature content or additional feature content, or music album. Each title is assigned a title reference number enabling you to locate it easily.

Chapter (DVD only)

Sections of a picture or a musical piece that are smaller than titles.

A title is composed of one or several chapters. Each chapter is assigned a chapter number, enabling you to locate the chapter you want. Depending on the disc, no chapters may be recorded.

Track (Video CD and audio CD only)

Sections of a picture or a musical piece on a video CD or an audio CD. Each track is assigned a track number, enabling you to locate the track you want.

Scene

On a video CD with PBC (Playback control) functions, moving pictures and still pictures are divided into sections called “Scenes”. Each scene is displayed in the menu screen and assigned a scene number, enabling you to locate the scene you want.

A scene is composed of one or several tracks.

Types of video CDs

There are two types of video CDs:

Video CDs equipped with PBC (Version 2.0)

PBC (Playback control) functions allow you to interact with the system via menus, search functions, or other typical computer-like operations. Moreover, still pictures of high resolution can be played if they are included in the disc.

Video CDs not equipped with PBC (Version 1.1)

Operated in the same way as audio CDs, these discs allow playback of video pictures as well as sound, but they are not equipped with PBC.

Remote Control Operation Range

Point the remote control at the remote sensor and press the buttons.

- Distance: About 23 ft (7 m) from the front of the remote sensor
- Angle: About 30° in each direction of the front of the remote sensor

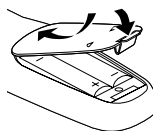

Remote control battery installation

Detach the battery cover on the rear of the remote control, and insert two (size AA) batteries with \oplus and \ominus aligned correctly.

Caution

Do not mix old and new batteries. Never mix different types of batteries (standard, alkaline, etc.).

Before Use (Cont'd)

Precautions

Handling the unit

When shipping the unit

The original shipping carton and packing materials come in handy. For maximum protection, re-pack the unit as it was originally packed at the factory.

When setting the unit

The picture and sound of a nearby TV or radio may be distorted during playback. In this case, position the unit away from the TV or radio, or turn off the unit after removing the disc.

To keep the surface clean

Do not use volatile liquids, such as insecticide spray, near the unit. Do not leave rubber or plastic products in contact with the unit for a long period of time. They will leave marks on the surface.

Cleaning the unit

To clean the cabinet

Use a soft, dry cloth. If the surfaces are extremely dirty, use a soft cloth lightly moistened with a mild detergent solution. Do not use strong solvents, such as alcohol, benzene, or thinner, as these might damage the surface of the unit.

To obtain a clear picture

The DVD player is a high-tech, precision device. If the optical pick-up lens and disc drive parts are dirty or worn down, the picture quality will be poor.

Regular inspection and maintenance are recommended after every 1,000 hours of use. (This depends on the operating environment.)

For details, please contact your nearest dealer.

Notes on Discs

Handling discs

Do not touch the playback side of the disc.

Hold the disc by the edges so that fingerprints will not get on the surface.

Do not stick paper or tape on the disc.

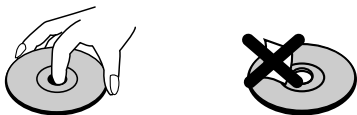

Storing discs

After playing, store the disc in its case.

Do not expose the disc to direct sunlight or sources of heat, or leave it in a parked car exposed to direct sunlight, as there may be a considerable temperature increase inside the car.

Cleaning discs

Fingerprints and dust on the disc can cause poor picture quality and sound distortion. Before playing, clean the disc with a clean cloth. Wipe the disc from the center out.

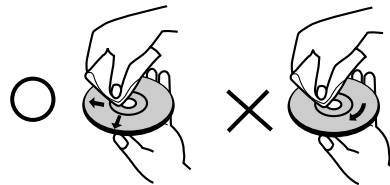

Do not use strong solvents such as alcohol, benzene, thinner, commercially available cleaners, or anti-static spray intended for older vinyl records.







About Symbols

About the symbol display

“  ” may appear on the TV screen during operation. This icon means the function explained in this owner's manual is not permitted by the DVD+VCR or is not available on that specific DVD video disc.

About the disc symbols for instructions

A section whose title has one of the following symbol is applicable only to the disc represented by the symbol.

-  DVD
-  Video CDs with the PBC (playback control) function.
-  Video CDs without the PBC (playback control) function.
-  Audio CDs.
-  MP3 disc.
-  JPEG disc.

Selecting the Viewing Source

You must select one of your output sources (DVD or VCR) to view on the TV screen.

- If you want to view DVD deck output source:
Press DVD on the remote or SOURCE on the front panel and output source of DVD deck is viewed on the TV screen.
- If you want to view VCR deck output source:
Press VCR on the remote or SOURCE on the front panel and output source of VCR deck is viewed on the TV screen.

Notes

- If you insert a disc while the DVD+VCR is in the VCR mode, the DVD+VCR will switch to DVD mode automatically.
- If you insert a cassette tape without prevention tab while the DVD+VCR is in the DVD mode, the DVD+VCR will switch to VCR mode automatically.

Front Panel and Display Window

English

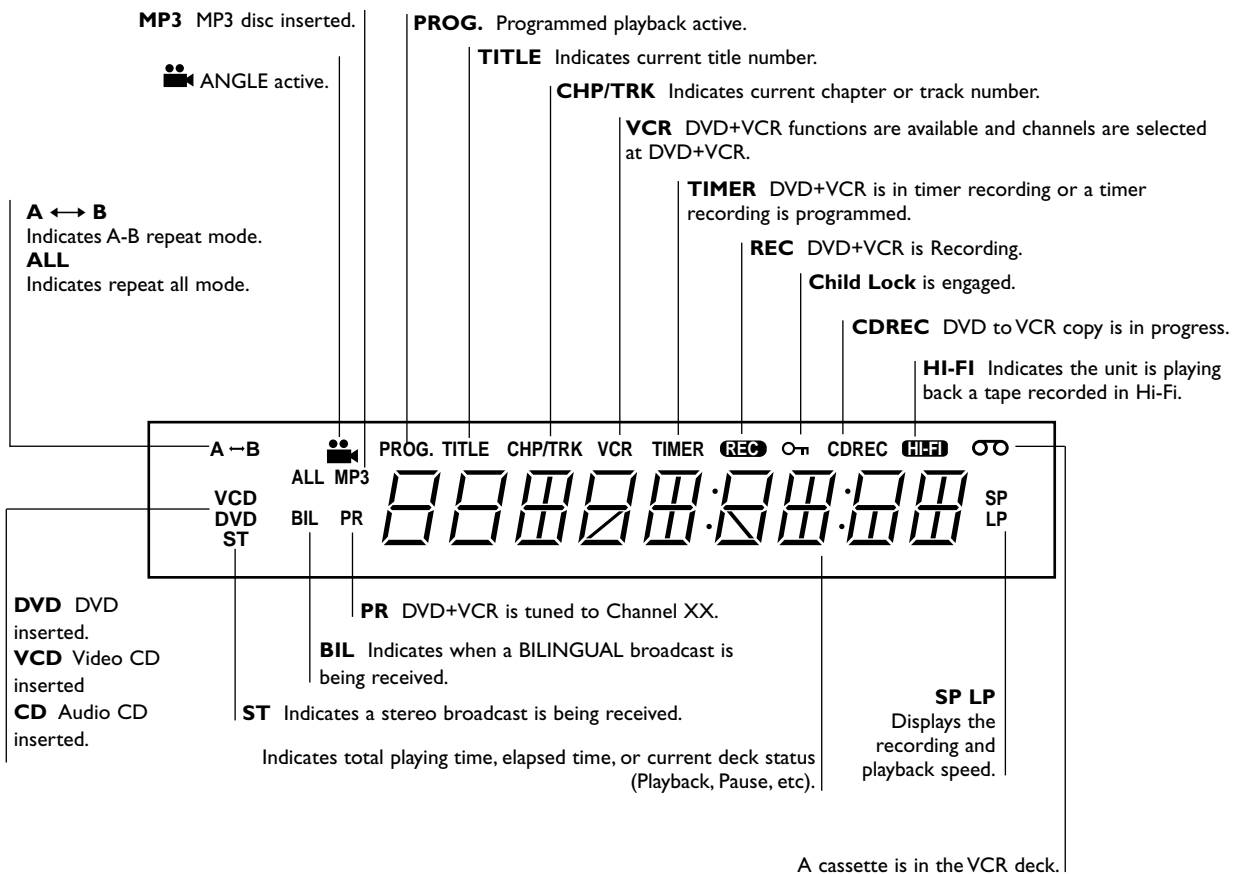
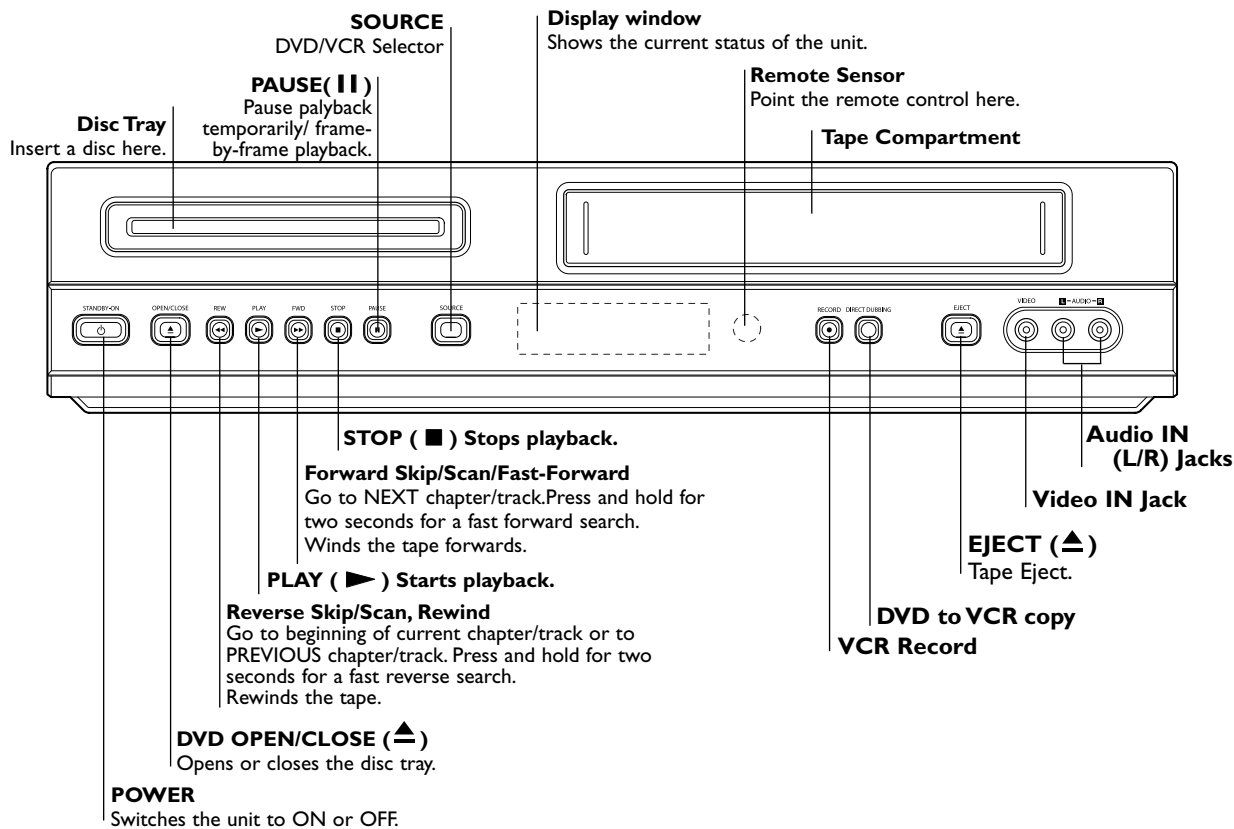

Remote Control

English

DVD/VCR select button
Select the output source (DVD or VCR) to view on the TV screen.

TV/VCR
To view channels selected by the VCR tuner or by the TV tuner.

0-9 numerical buttons
Selects numbered options in a menu.

DISC MENU
Accesses menu on a DVD disc.

SYSTEM MENU
Accesses or removes DVD setup menu and VCR menu.

SKIP ◀◀/REW
Skip to beginning of current chapter or track, press twice in quick successions to go to previous chapter or track.
Press and hold button for about two seconds to search backward. (For DVD only)
Rewinds the tape during the STOP mode or for fast reverse picture search.

SKIP ▶▶/FWD
Skip to next chapter or track.
Press and hold button for about two seconds to search forward. (For DVD only)
Advances the tape during the STOP mode or for fast forward picture search.

MARKER
Marks any point during playback.

SEARCH
Displays MARKER SEARCH menu.

INPUT
To select the VCR deck's source (Tuner, AV1, AV2 or AV3).

REC/ITR
Records normally or activates Instant Timer
Recording with repeated presses.

REPEAT
Repeat chapter, track, title, all.

REPEAT A-B
Repeats sequence.

PROGRAM
Accesses or removes Program menu.

CLEAR
- Resets tape counter to M 0:00:00
- Removes a track number on the program menu or a mark on the MARKER SEARCH menu.

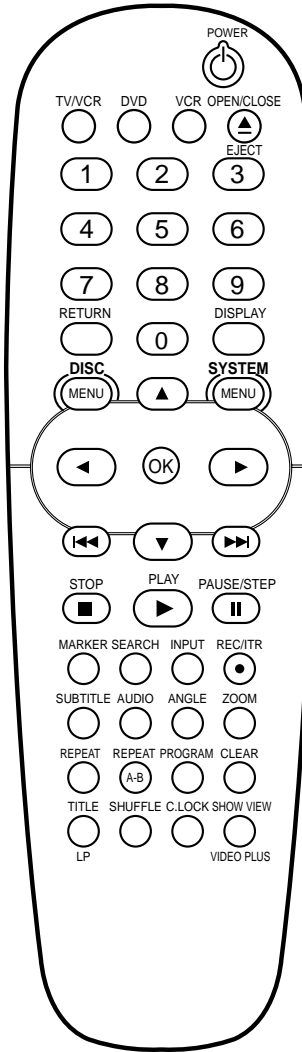

POWER
Switches DVD+VCR ON and OFF.

EJECT, OPEN/CLOSE
- Opens and closes the disc tray.
- Ejects the tape in the VCR deck.

RETURN
Removes the setup menu.

DISPLAY
Accesses On-Screen display.
Switches among the clock, tape counter and tape remaining modes.

◀/▶/▲/▼ (left/right/up/down)
- Selects an option in the menu
- ▲/▼: Selects channel of VCR. Adjusts manually the tape's picture onscreen.

OK
- Acknowledges menu selection.
- Displays functions on the TV screen.

STOP
Stops playback.

PLAY
Starts playback.

PAUSE/STEP
Pause playback or recording
Press repeatedly for frame-by-frame playback during pause.

SUBTITLE
Selects a subtitle language.

AUDIO
Selects an audio language (DVD) or an audio channel (CD).

ANGLE
Selects a DVD camera angle if available.

ZOOM
Enlarges DVD/VCD video image.

TITLE/LP
- Displays the disc's Title menu, if available.
- Selects recording speed

SHUFFLE
- Plays tracks in random order.

C.LOCK
Switch the Child Lock on and off.

VIDEO PLUS+
To display the programme menu for VIDEO Plus+ programming.

Note

This remote control use the same buttons for VCR and DVD functions (ex. PLAY).
When using a VCR, first press the VCR button.
When using a DVD, first press the DVD button.

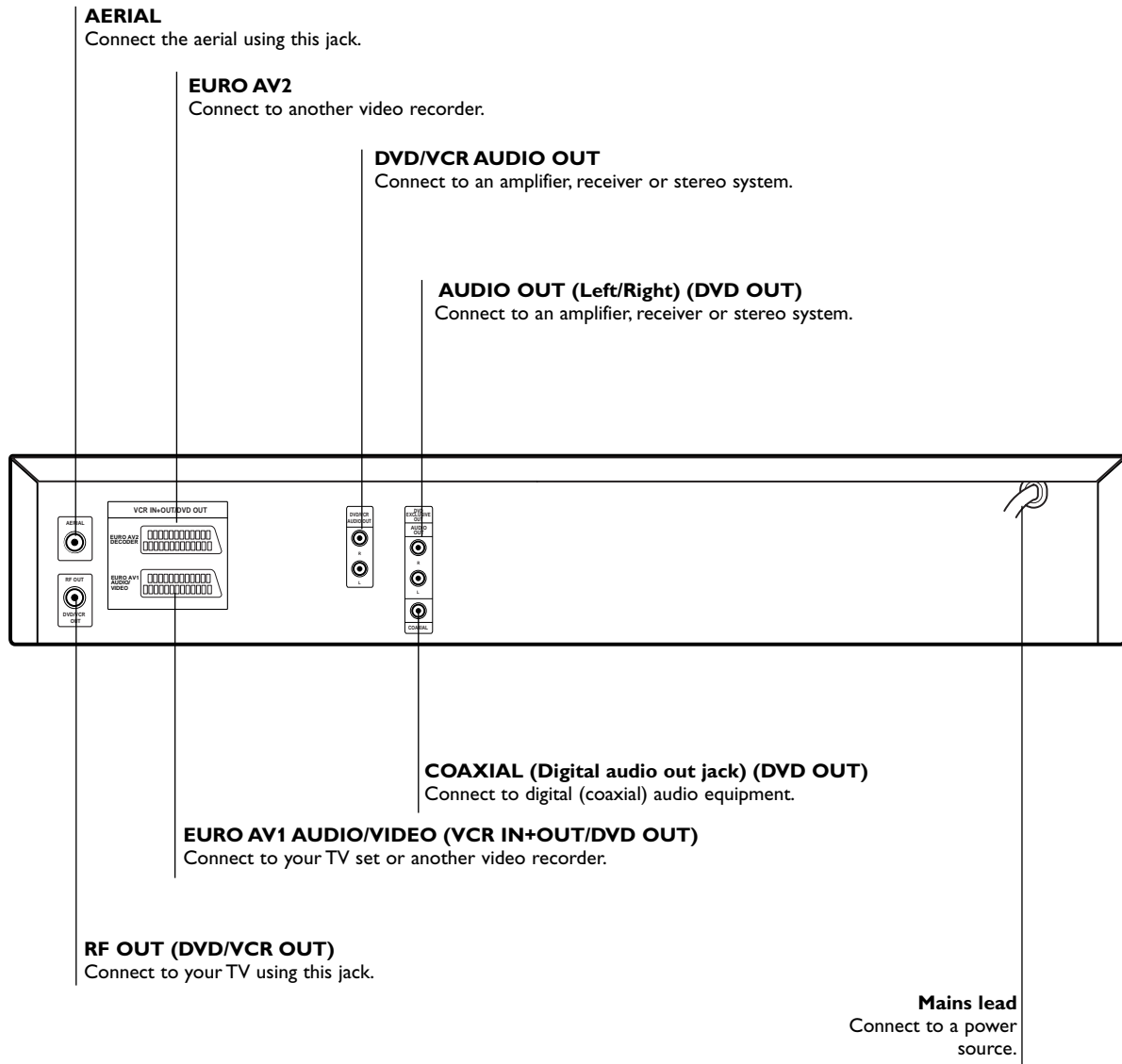

Do not touch the inner pins of the jacks on the rear panel. Electrostatic discharge may cause permanent damage to the unit.

Connections

Tips

- Depending on your TV and other equipment you wish to connect, there are various ways you could connect the unit.
- Please refer to the manuals of your TV, Stereo System or other devices as necessary to make the best connections.
- For better sound reproduction, connect this unit's AUDIO OUT jacks to the audio in jacks of your amplifier, receiver, stereo or audio/video equipment. See "Connecting to optional equipment" on page 11.

Caution

- Make sure this unit is connected directly to the TV. Set the TV to the correct video input channel.
- Do not connect this unit's AUDIO OUT jack to the phono in jack (record deck) of your audio system.

Connecting to a TV

- Make one of the following connections, depending on the capabilities of your existing equipment.

Basic connection (AV)

- 1 Connect the **EURO AV1 AUDIO/VIDEO** on the rear panel of this unit to the SCART input socket on the TV using a SCART lead.

Basic connection (RF)

- 1 Connect the RF antenna cable from your indoor/ outdoor antenna to **AERIAL** jack on the rear panel of this unit.
- 2 Connect the supplied RF antenna cable from the **RF OUT (DVD/VCR OUT)** jack on the rear panel of this unit to your television's Antenna Input.

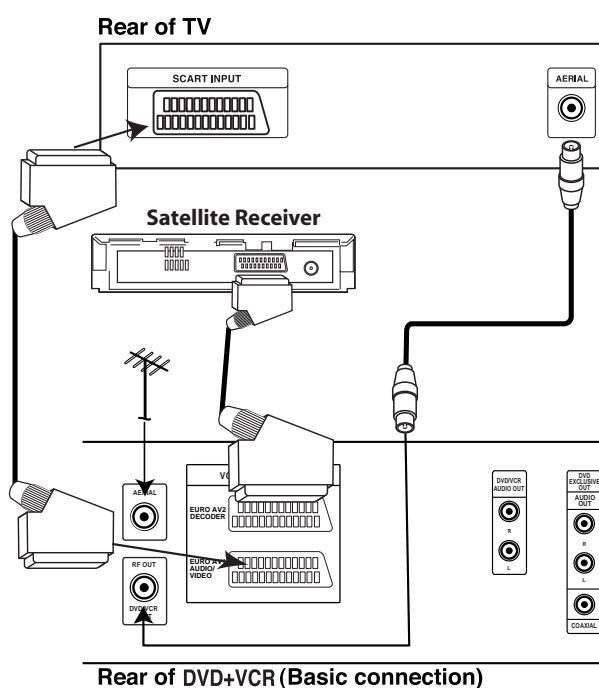

Connecting to Optional Equipment

Connecting to an amplifier equipped with two channel analog stereo or Dolby Pro Logic II/Pro Logic

Connect the Left and Right **DVD/VCR AUDIO OUT** or **AUDIO OUT (DVD EXCLUSIVE OUT)** jacks on this unit to the audio left and right in jacks on your amplifier, receiver or stereo system, using the audio cables.

Connecting to an amplifier equipped with two channel digital stereo (PCM) or to an Audio/Video receiver equipped with a multi-channel decoder (Dolby Digital™, MPEG 2 or DTS)

- 1 Connect one of this unit's DIGITAL AUDIO OUT jack (**COAXIAL**) to the corresponding in jack on your amplifier. Use an optional digital (coaxial) audio cable.
- 2 You will need to activate this unit's digital output. (See "Digital Audio Output" on page 19).

Digital Multi-channel sound

A digital multi-channel connection provides the best sound quality. For this you need a multi-channel Audio/Video receiver that supports one or more of the audio formats supported by your unit (MPEG 2, Dolby Digital and DTS). Check the receiver manual and the logos on the front of the receiver.

Warning:

Due to the DTS Licensing agreement, the digital output will be in DTS digital out when DTS audio stream is selected.

Notes

- If the audio format of the digital output does not match the capabilities of your receiver, the receiver will produce a strong, distorted sound or no sound at all.
- To see the audio format of the current DVD in the On-Screen Display, press AUDIO.

Rear of DVD+VCR

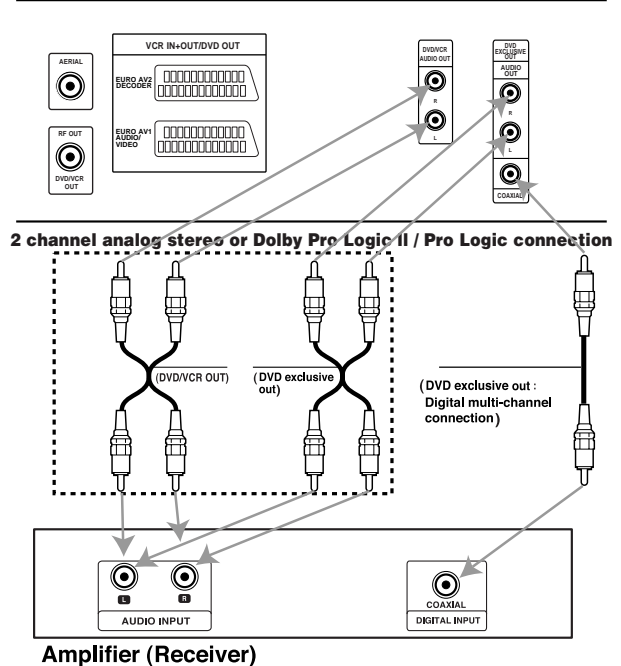

Before Operation - VCR part

Tuning in a video channel on your TV

Video channel (RF output channel) is the channel on which your TV receives picture and sound signals from the DVD+VCR through the RF cable.

If you have used a **SCART** lead you will not have to tune your TV, simply select the **AV** channel. The **AV** channel is already pre-tuned for optimum video playback on your TV.

Perform the following steps only if interference appears in the TV picture after you have moved to a different area or a new station has started broadcasting in your area, or if you change the connection from RF connection to AV connection, or vice versa.

- 1 Turn on DVD+VCR and TV.
- 2 Set the vacant position 22 on your TV.
- 3 Press **⏻** on the remote control to enter the standby mode (the clock indicator will be dimmed).
- 4 Press and hold **REW** or **FWD** on the DVD+VCR for more than 4 secs.

RF 36 will appear in the DVD+VCR display. The following picture will be displayed on the TV screen.

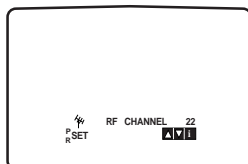

If the picture is snowy, move to step 5. If the picture is clean, press **⏻** on the DVD+VCR to finish.

- 5 Press **REW** or **FWD** on the DVD+VCR to set the video channel to a vacant position between 22 and 68 which is not occupied by any local station in your area.

Note

The RF channel will not change until step 6 has been executed.

- 6 Press **⏻** to store the new RF video channel into the DVD+VCR memory.

Now tune your TV set to the new DVD+VCR RF channel.

Note

If the TV picture was clear in step 4, do not retune your TV.

Using your DVD+VCR for the very first time

For the following steps we assume that you have just connected your DVD+VCR for the very first time. To make tuning TV stations an easy task your DVD+VCR incorporates the Automatic Channel Memory System (ACMS). This system will automatically tune and store TV channels in your DVD+VCR.

- 1 Make sure that you have correctly installed your DVD+VCR.

Press **⏻** to turn on your DVD+VCR.

If the initial Menu Screen doesn't appear on screen, make sure that you have tuned your TV to a video channel. Or if this is correct it may mean that your DVD+VCR is already tuned.

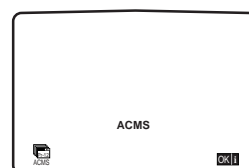

- 2 Press **OK** to start the automatic tuning process.

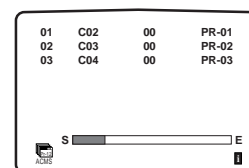

- 3 Press **SYSTEM MENU** to remove the menus from the TV screen.

Setting the clock Manually

The clock in your DVD+VCR controls time and date settings for your DVD+VCR.

- 1** Press **SYSTEM MENU**.
Press ◀ or ▶ to select **TIME DATE**.
Press **OK**.

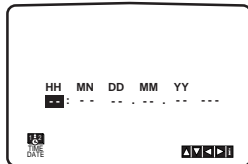

- 2** Use the **numbered buttons** on the remote control to alter the **HOURS, MINUTES, DAY, MONTH** and **YEAR**.
Please note your DVD+VCR uses a 24 hour clock. e.g. 1pm will be displayed as 13:00.
The day of the week will appear automatically when you enter the year.

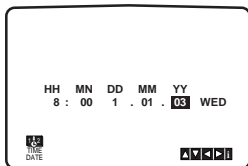

- 3** If you make a mistake press ◀ or ▶ and enter the correct details.
- 4** Press **SYSTEM MENU**.

To set the colour system

- 1** Press **SYSTEM MENU**.
- 2** The main menu will appear on the TV screen.
- 3** Press ◀ or ▶ to select the **SYSTEM** and press **OK**.
- 4** Press ▲ or ▼ to select according to the **COLOUR** system used.

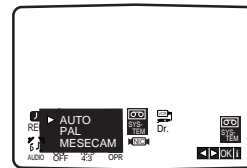

- 5** Press **SYSTEM MENU** to remove the menus from the TV screen.

Before Operation - VCR part

How to using the main menu

This VCR can easily be programmed by using the menus displayed on screen.

The menus are controlled from the Remote Control Handset.

- 1 Switch on your TV set and video recorder by pressing the  button.
- 2 Press **SYSTEM MENU** button.
The main menu will appear on the TV screen.

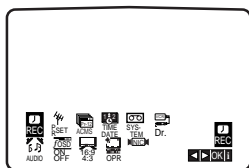

- **REC** - Timer recording setting (see p. 24).
- **PR SET** - Manual tuning setting (see p. 15).
- **ACMS** - ACMS (Automatic Channel Memory System) (see p. 14).
- **TIME DATE** - Date & clock setting (see p. 13).
- **SYSTEM** - To set the Colour TV System (see p. 13).
- **Dr.** - To check a problem with your VCR (see p. 32).
- **AUDIO** - To select the channel for audio output.
- **F.OSD ON/OFF** - To display the operational mode of your VCR (see p. 32).
- **16:9/4:3** - To select the aspect ratio of your TV (see p.33).
- **OPR** - To improve the playback picture (see p. 21).
- **NIC** - To activate or deactivate the NICAM digital sound (see p. 33).

- 3 Press **◀** and **▶** to select the desired menu.
Press **OK** and use **▲** or **▼** to select.
- 4 Press **SYSTEM MENU** to return to a TV picture.

Tuning in TV Stations Automatically

If the TV broadcast signal is weak your VCR may not detect the necessary information and will be and to store them correctly. To overcome this problem please turn to the **MANUAL TUNING** section on page 15.

- 1 Press  to turn on your VCR.
- 2 Press **SYSTEM MENU** button.
The main menu will appear on the TV screen.
Press **◀** or **▶** to select the **ACMS**.
Press **OK**.

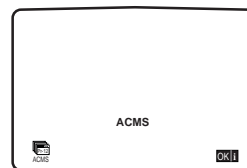
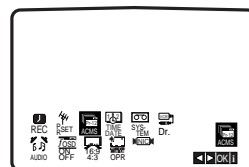

- 3 Press **OK** again to start the automatic tuning process.

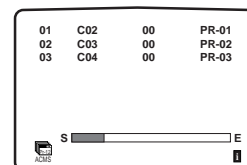

- 4 The **TV STATION TABLE** will appear when tuning is complete.
Press **SYSTEM MENU** to save your settings.

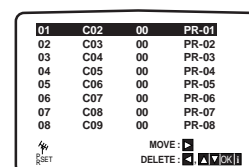

Tuning in TV Stations Manually

In certain areas of the country broadcast signals may be too weak for your VCR's automatic tuning process to find or assign TV stations correctly. You must tune in these weaker broadcast stations manually in order for your VCR to store them.

- 1 Press **SYSTEM MENU**.
The main menu will appear on the TV screen. Press **◀** or **▶** to select the **PR SET**.
Press **OK**.

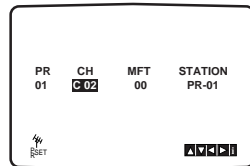
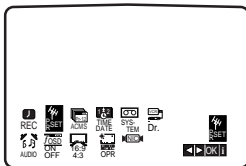

- 2 Press **SYSTEM MENU**.
The station table will appear.
Press **▲** or **▼** to select the programme number that you want to tune (for example, PR 09).

01	C02	00	PR-01
02	C03	00	PR-02
03	C04	00	PR-03
04	C05	00	PR-04
05	C06	00	PR-05
06	C07	00	PR-06
07	C08	00	PR-07
08	C09	00	PR-08

MOVE: **▶**
DELETE: **◀** **▶** **OK**

- 3 Press **OK**.
Enter the channel number of station that you want to tune with **the numbered buttons** or use **▲** or **▼** to find the required station.

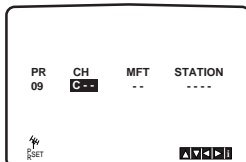

- 4 Searching will stop when it locates a stations.
Press **▶** to select **MFT**.
Control the fine tuning of the station by using **▲** or **▼**.

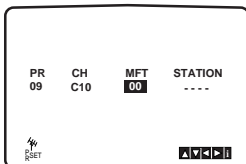

- 5 Press **▶** to select **STATION** so that you may name your TV station.
Press **OK**.
The TV station name list will appear.

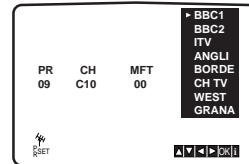

- 6 Use **▲** or **▼** to select a station name from the list.
Press **OK** to select it.

If your station name isn't on the list do not press OK, but go to stage 7.

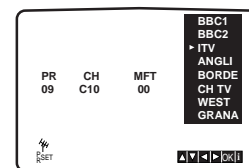

- 7 You can change a TV station name manually rather than using the "standard" names.
Press **▶**.

Use **▲** or **▼** to select **letters** and **numbers** for the new station name.

Use **◀** or **▶** to move back and forth between characters.
Press **OK**.

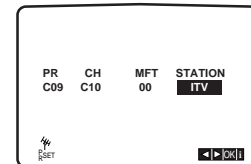

- 8 Press **SYSTEM MENU**, confirm the station placement.
Press **SYSTEM MENU** again.
Your new TV station has now been tuned into your VCR.
If you wish to manually tune other stations repeat stages **1 - 8**.

09	C10	00	ITV
10	--	--	----
11	--	--	----
12	--	--	----
13	--	--	----
14	--	--	----
15	--	--	----
16	--	--	----

MOVE: **▶**
DELETE: **◀** **▶** **OK**

Before Operation - VCR part

Changing the order of TV Stations

After tuning TV stations into your VCR you may wish to change the order in which they are stored without having to retune them again. The instructions given on this page will show you how you can simply move them into your desired order.

- 1 Press **SYSTEM MENU**.
The main menu will appear on the TV screen.
Press ◀ or ▶ to select the **PR SET**.
Press **OK**.

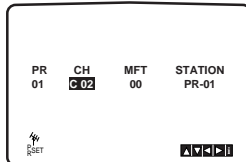
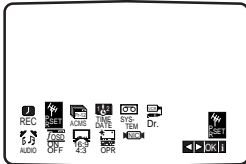

- 2 Press **SYSTEM MENU**.
Use ▲ or ▼ to select the **programme number** you want to move (for example, PR 03).
Press ▶.

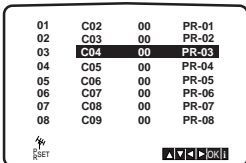
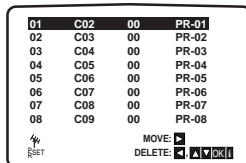

- 3 Use ▲ or ▼ to select the **programme number** you want to move to (for example, PR 05).

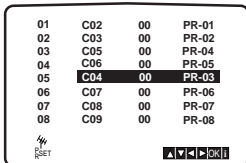

- 4 Press **OK**.
The selected **programme** will be moved to the **new programme number**.
If you wish to move other TV stations repeat stages 1 - 4.
Press **SYSTEM MENU** to remove the menus from the TV screen.

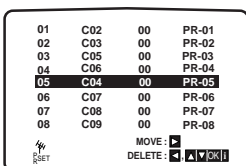

Deleting TV Stations

After tuning TV stations into your VCR you may wish to delete a station.
The instructions given on this page will show you how you can easily delete any unwanted TV stations.

- 1 Press **SYSTEM MENU**.
The main menu will appear on the TV screen.
Use ◀ or ▶ to select the **PR SET**.
Press **OK**.

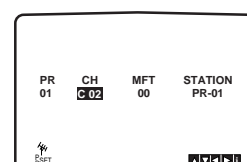
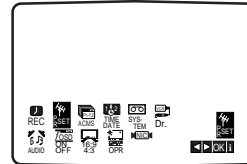

- 2 Press **SYSTEM MENU**.
Press ▲ or ▼ to select the **programme number** you want to delete. (for example, PR 03)

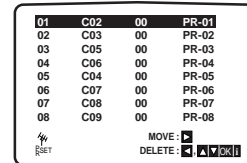

- 3 Press ◀.
After a short while, the selected station will be deleted.

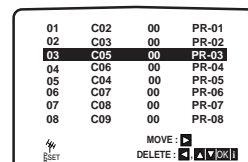

- 4 Press **SYSTEM MENU** to remove the menus from the TV screen.
If you wish to delete other TV stations repeat stages 1 - 3.

How to select Stored TV stations:

Stored TV stations can be selected in either of two ways.
Use ▲ or ▼ to select different stations that are tuned into your DVD+VCR.

You may also directly select stations using the **numbered buttons** on the remote control.

General Explanation

This manual gives the basic instructions for operating the DVD+VCR. Some DVDs require specific operation or allow only limited operation during playback. When this occurs, the symbol  appears on the TV screen, indicating that the operation is not permitted by the DVD+VCR or is not available on the disc.









On-Screen Display

The general playback status can be displayed on the TV screen. Some options can be changed on the menu.

On-screen display operation

- 1** Press **DISPLAY** during playback.
- 2** Use **▲/▼** to select an item.
The selected option will be highlighted.
- 3** Use **◀/▶** to change the setting of an item.
The number buttons can also be used for setting numbers (e.g., title number). For some functions, press **OK** to execute the setting.







Temporary Feedback Field Icons

-  **Repeat Title**
-  **Repeat Chapter**
-  **Repeat Track (non-PBC Video CDs and Audio CD only)**
-  **Repeat Disc (non-PBC Video CDs and Audio CD only)**
-  **Repeat A-B**
-  **Repeat Off**
-  **Resume play from this point**
-  **Action prohibited or not available**





Notes

- Some discs may not provide all of the features on the on-screen display example shown below.
- If no button is pressed for 10 seconds, the on-screen display disappears.

DVD

Options		Function (Use ▲/▼ to select desired option)	Selection Method
Title Number	 1 / 3	Shows the current title number and total number of titles, and skips to the desired title number.	◀/▶, or Numeric, OK
Chapter Number	 1 / 12	Shows the current chapter number and total number of chapters, and skips to the desired chapter number.	◀/▶, or Numeric, OK
Time search	 0:20:09	Shows the elapsed playing time, and searches the point by the elapsed time directly.	Numeric, OK
Audio language and Digital Audio Output mode	 1 ENG □□□ 5.1 CH	Shows the current audio soundtrack language, encoding method, and channel number, and changes the setting.	◀/▶, or AUDIO
Subtitle language	 OFF	Shows the current subtitles language, and changes the setting.	◀/▶, SUBTITLE
Angle	 1 / 1	Shows the current angle number and total number of angles, and changes the angle number.	◀/▶, ANGLE
Sound	 NORM.	Shows the current sound mode, and changes the setting.	◀/▶

VCD2.0 VCD1.1

Items		Function (Use ▲/▼ to select desired option)	Selection Method
Track Number	 1 / 4	Shows the current track number, total number of tracks and PBC On mode, and skips to the desired track number.	◀ / ▶, or Numbers, OK
Time	 0:20:09	Shows the elapsed playing time (Display only)	—
Audio Channel	 STER.	Shows the audio channel, and changes the audio channel.	◀ / ▶, or AUDIO
Sound	 NORM.	Shows the current sound mode, and any changes to the setting.	◀ / ▶

Before Operation (Continued) - DVD part

Initial Settings

You can set your own Personal Preferences on the player.

General Operation

- 1 Press **SYSTEM MENU**.
The setup menu appears.



- 2 Use **▲/▼** to select the desired item.
The screen will show the current setting for the selected option, as well as alternate setting(s).
- 3 While the desired option is selected, press **▶**, then **▲/▼** to select the desired setting.
- 4 Press **OK** to confirm your selection.
Some items require additional steps.
- 5 Press **SYSTEM MENU**, **RETURN**, or **PLAY ▶** to exit the setup menu.

Language

Disc Language **DVD**

Select a language for the disc's Menu, Audio, and Subtitle.

Original : The original language set for the disc is selected.

Other : To select another language, press number buttons to enter the corresponding 4-digit number according to the language code list on page 36. If you enter the wrong language code, press **CLEAR**.

N Notes

Disc Language selection may not work for some DVDs.



Menu Language

Select a language for the setup menu. This is the menu you see when you press **SYSTEM MENU**.



Picture

TV Aspect **DVD**

4:3 Letterbox: Select when a standard 4:3 TV is connected. Displays theatrical images with masking bars above and below the picture.

4:3 Panscan: Select when a conventional TV set is connected. The video material formatted in the Pan & Scan style is played back in that style (Both sides of the picture are cut off.)

16:9 Wide: Select when a 16:9 wide TV is connected.

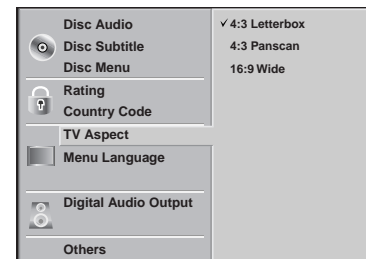

Before Operation (Continued) - DVD part

Sound

Digital Audio Output

Each DVD disc has a variety of audio output options. Set the DVD+VCR's Digital Audio Output according to the type of audio system you use.

DOLBY DIGITAL/PCM:

Select DOLBY DIGITAL/PCM if you connected the DVD+VCR's DIGITAL AUDIO OUT jack to a Dolby Digital decoder (or an amplifier or other equipment with a Dolby Digital decoder).

Stream/PCM:

Select Stream/PCM if you connected the DVD+VCR's DIGITAL AUDIO OUT jack to an amplifier or other equipment with a DTS decoder, Dolby Digital decoder or MPEG decoder.

PCM: Select when connected to a 2 channel digital stereo amplifier. The DVD+VCR output sounds in the PCM 2ch format when you play a DVD video disc recorded on the Dolby Digital, MPEG1, or MPEG2 recording system.

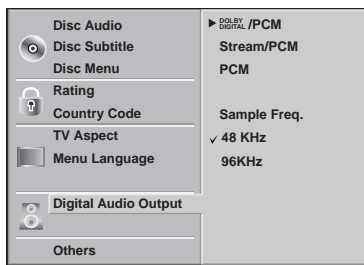

Sample Frequency

To change the Sample Frequency setting, first select the desired Digital Audio Output as indicated as above.

If your receiver or amplifier is NOT capable of handling 96KHz signals, select 48KHz. When this choice is made, this unit will automatically convert any 96KHz signals to 48KHz so your system can decode them.

If your receiver or amplifier is capable of handling 96KHz signals, select 96KHz. When this choice is made, this unit will pass each type of signal through without any further processing.

Others

The DRC, Vocal, PBC and Auto Play settings can be changed.

- Use ▲/▼ to select the desired item and press OK. The setting of the selected item alternates between On and Off.

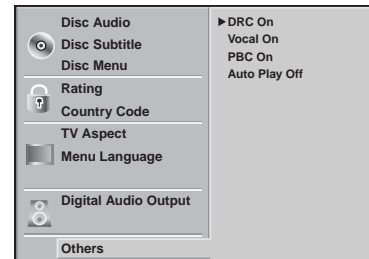

Dynamic Range Control (DRC)

With the DVD format, you can hear a program's soundtrack in the most accurate and realistic presentation possible, thanks to digital audio technology. However, you may wish to compress the dynamic range of the audio output (the difference between the loudest sounds and the quietest ones). Then, you may listen to a movie at a lower volume without losing clarity of sound. Set DRC to On for this effect.

Vocal

Set Vocal to On only when a multi-channel karaoke DVD is playing. The karaoke channels on the disc will mix into normal stereo sound.

PBC

Set Playback Control (PBC) to On or Off.

On: Video CDs with PBC are played according to the PBC.

Off: Video CDs with PBC are played the same way as Audio CDs.

Auto Play **DVD**

You can set up the DVD Player so a DVD disc automatically starts playing whenever the DVD is inserted. If Auto Play mode is set to On, this DVD player will search a title that playback time is long most and then play back the title automatically.

On: Auto Play function is activated.

Off: Auto Play function is not activated.

Note

The Auto Play function may not work for some DVDs.

Before Operation (Continued) - DVD part

Parental Control

Rating **DVD**

Movies on DVDs may contain scenes not suitable for children. Therefore, discs may contain Parental Control information that applies to the complete disc or to certain scenes on the disc. These scenes are rated from 1 to 8, and alternatively, more suitable scenes are available for selection on some discs. Ratings are country dependent. The Parental Control feature allows you to prevent discs from being played by your children or to have certain discs played with alternative scenes.

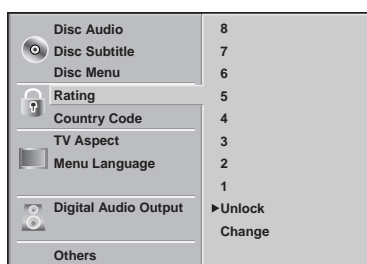

- 1 Select "Rating" on the Setup menu using the ▲/▼ buttons.
- 2 While "Rating" is selected, press ►.
- 3 When you have not entered a password yet. Enter a 4-digit password using the numbered buttons to create a personal 4-digit security password, then press OK. Enter the 4-digit password again and press OK to verify.
When you have already entered a password; Enter a 4-digit password using the numerical buttons to confirm the personal 4-digit security password, then press OK.

If you make a mistake before pressing OK, press CLEAR and enter 4-digit security password again.

- 4 Select a rating from 1 to 8 using ▲/▼ buttons.
Level 1 : DVD software for adults cannot be played back.
Level 8 : All DVD software can be played back.
The limitation will be more severe as the level number is lower.
Unlock: If you select Unlock, Parental Control is not active. The disc will play in full.
Ratings 1 to 8: Some discs contain scenes not suitable for children. If you set a rating for the DVD+VCR, all disc scenes with the same rating or lower will be played. Higher rated scenes will not be played unless an alternative scene is available on the disc. The alternative must have the same rating or a lower one. If no suitable alternative is found, playback will stop. You must enter the 4-digit password or change the rating level in order to play the disc.
- 5 Press OK to confirm your rating selection, then press SYSTEM MENU to exit the menu.

Area Code **DVD**

Enter the code of a country/area whose standards were used to rate the DVD video disc, referring to the list (See "Country/Area Code List", page 37).

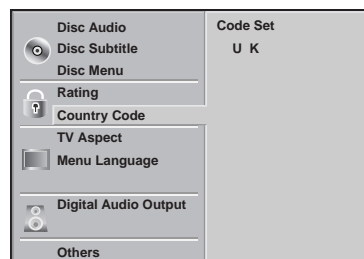

- 1 Select Country Code using the ▲/▼ buttons on the setup menu.
- 2 While Country Code is selected, press ►.
- 3 Follow step 3 of "Rating" on left.
- 4 Select the first character using the ▲/▼ buttons.
- 5 Shift the cursor using ► button and select the second character using ▲/▼ buttons.
- 6 Press OK to confirm your Area code selection, then press SYSTEM MENU to exit the menu.

Note

Confirmation of the 4-digit password is necessary when the password is changed (see "Changing the 4-digit Code" below).

Changing the 4-digit Code

- 1 Follow Steps 1-2 as shown above to the left (Rating).
- 2 Enter the old password, then press OK.
- 3 Select Change using ▲/▼ buttons then press OK.
- 4 Enter the new 4-digit password, then press OK.
- 5 Enter exactly the same password a second time and verify by pressing OK.
- 6 Press SYSTEM MENU to exit the menu.

If you forget your 4-digit Code

If you forget your password, clear the current password by following the procedure below.

- 1 Press SYSTEM MENU to display the setup menu.
- 2 Use the Number buttons to enter the 6-digit number "210499".
The 4-digit password is cleared.
- 3 Enter a new password as shown above to the left (Rating).

Playing a tape

You will only be able to load and eject video cassettes when your VCR is plugged into the mains.
Your VCR may also playback recordings from NTSC tapes (on PAL TV).

Getting a better picture

When a cassette is inserted and playback started, the automatic tracking function works to get the best possible picture automatically. If the quality of the recording is poor, repeatedly press ▲ or ▼ on the remote control to manually adjust the tracking until any distortions have been removed.



Press numbered 0 on the remote control to switch automatic tracking back on again.

- 1 Make sure that you have correctly connected your VCR as described earlier in this book.
Turn on your TV.
Press  to turn on your DVD+VCR.
Insert the video cassette into your DVD+VCR.
The video cassette should have the window side facing up and the arrow facing away from you.



- 2 Press **PLAY**  to start playing your tape.
If you load a video cassette which has had its record protection tab removed, playback of the cassette will start automatically.

AUTO TRACKING



Your DVD+VCR will automatically adjust the tracking to give the best picture quality.

- 3 Press **PAUSE/STEP II** to still a picture.
Press **PAUSE/STEP II** repeatedly to advance the tape frame by frame.
If you hold down , the picture will be slowed down at about 1/19 times the normal playback.
Tapes can be paused for up to 5 minutes. After 5 minutes your DVD+VCR will stop the tape to prevent damaging the tape or your DVD+VCR.
Still picture quality can be improved slightly by using ▲ or ▼.
- 4 Press **PLAY**  to continue playing your tape.



Picture search:

During playing back press either  or  to this will enable you to rapidly wind the tape (7 times normal playback) see where you are on the tape.

Logic search:

During fast forwarding or rewinding press and hold  or  the picture will be played back at 7 times normal playback speed.

5 Slow motion playback, Shuttle :

During playing back or still picture press  or .
You can reach the following playback speeds. (-7xplay, -3xplay, -play, still, 1/19 slow, play, 2xplay, 7xplay)
To switch off the slow motion and shuttle, press the desired function.

During slow motion and shuttle, the noise bars may appear on the picture according to the status of tape.
If distortions can be seen in the picture, reduce them with ▲ or ▼.

- 6 Press **STOP** to end playback.
Press **EJECT**.

If the end of the tape is reached, your DVD+VCR will stop playback automatically, rewind, stop, eject the tape.

OPR (Optimum Picture Response)

This feature automatically improves playback picture quality by adjusting your DVD+VCR to the condition of the tape.

- 1 Press **SYSTEM MENU**.

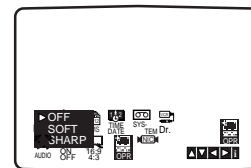

- 2 Press ▲ or ▼ to select **OPR**.
- 3 Press **OK**.
- 4 Press ▲ or ▼ repeatedly to select: **OFF, SOFT** or **SHARP**.
Please note you may only set OPR when playing a tape.
- 5 Press **SYSTEM MENU** return to screen.

Operation with tape (Continued)

Instant Timer Recording (ITR)

Your VCR allows you to make recordings using a variety of simple methods:

Instant Timer Recording (ITR) start recording immediately for a set period of time or until the video cassette runs out.

Your DVD+VCR incorporates Long Play (LP) which enables you to record up to twice the amount of time on a video cassette. For example an E-180 will record up to 180 minutes using Standard Play (SP); using LP you will be able to record up to 360 minutes. Please note there will be a slight loss in picture and sound quality when using LP.

- 1** Make sure that you have correctly connected your VCR as described earlier in this book.
Press  to turn on your VCR.
- 2** Insert a video cassette with protection tab into your VCR.
The video cassette should have the window side facing up and the arrow facing away from you.
- 3** Press **▲** or **▼** to select the **programme number** you wish to record.
You may also directly select programme number using the **numbered buttons** on the remote control.
- 4** If you wish to record directly from the SCART or RCA sockets repeatedly press **INPUT** until the socket you wish to record from is displayed.

AV 1 for recording from EURO AV1 SCART socket on the rear of your unit.

AV 2 for recording from EURO AV2 SCART socket on the rear of your unit.

AV 3 for recording from VIDEO IN and AUDIO IN (Left & Right) sockets on the front of your unit.

- 5** Press **LP** if you wish to record in Long Play or Standard Play.
SP will produce improved picture and sound quality, however LP will provide twice as much recording time as SP.
- 6** Press **REC/ITR** on the remote to start recording. RECORD will appear on the TV screen.
Press **RECORD** on your unit or press **REC/ITR** on the remote several times. Each successive press will increase the record time by 30 minutes until you reach a maximum of 9 hours.
- 7** Press **PAUSE/STEP II** to avoid recording unwanted scenes.
Press **PAUSE/STEP II** to continue recording.
If you press **PAUSE/STEP II** during ITR, the DVD/VCR will enter the record pause mode and ITR is cancelled. Tapes can be paused for up to 5 minutes; RECP will be displayed when a tape is paused. After 5 minutes your DVD+VCR will stop recording to prevent damaging the tape or your DVD+VCR.
- 8** Press **STOP** twice within 5 seconds to end recording.
EJECT will appear on the TV screen for a few seconds.

Notes

- If you do not wish to record on a tape (this can happen quite easily by accident!) remove the protection tab on the back edge of the video cassette.
- It is possible to record on a video cassette with the record protection tab removed by covering the hole with self adhesive tape.
- Remember you can record one programme while watching another by starting your instant recording, press **TV/VCR** to disappear **VCR** indicator in the display window and then selecting a different channel on your TV.

Operation with tape (Continued)

VIDEO Plus+ Programming

VIDEO Plus+ greatly simplifies entering the date, channel, start and end times of a Timer Recording by simply entering a PlusCode. PlusCodes are published in most TV guide magazines; they can vary one to nine numbers in length.

VIDEO Plus+ and PlusCode are registered trademarks of Gemstar Development Corporation. The VIDEO Plus+ system is manufactured under license from Gemstar Development Corporation.

- 1 Make sure that TV channels have been tuned and stored in correct VIDEO PLUS order. Insert a video cassette with protection tab into your VCR.
- 2 Press **VIDEO PLUS**.

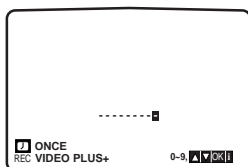

- 3 Press **▲** or **▼** to select the recording type.
 - ONCE:** To record once.
 - WEEKLY:** To record at the same time every week.
 - DAILY:** To record every day (except Saturday and Sunday) at the same time.
- 4 Press the **numbered buttons** to enter the **PlusCode** of the TV programme that you wish to record. If you make a mistake press **◀** then enter the revised number.

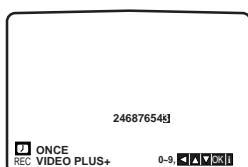

- 5 Press **OK**. If **PLEASE CHECK** is displayed it means that you have entered the wrong PlusCode, entered the PlusCode incorrectly. If **"-"** is displayed, you have to enter the programme number of the station, you want to record from.

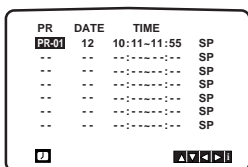

- 6 Press **◀** or **▶** to select the settings that you wish to revise. (PR, DATE, TIME and SP). Press **▲** or **▼** to enter the correct information.

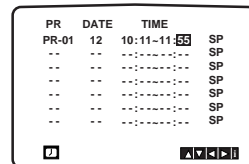

- 7 Press **▶** to select the recording speed. Press **▲** or **▼** to select the desired tape speed (SP, IP, or LP). IP mode determines how much tape is left and switches speed from SP to LP, if necessary, to complete recording the program. Check that the timer event details are correct. If you wish to record from AUDIO IN and VIDEO IN on the front or from either of the EURO SCART sockets on the back of VCR, press INPUT to select for correct display (AV1, AV2 or AV3).

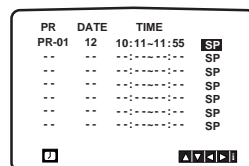

- 8 If you want to make another VIDEO Plus+ recording repeat stages 2 - 7. Press **SYSTEM MENU** twice. If **PLEASE CHECK** is displayed, you have entered incorrect information and will need to re-enter the data. Press **⏻** to switch your VCR power off mode. **TIMER** will appear in the video recorder's display while your VCR waits to make the recording. To watch a DVD during timer recording standby mode, press **POWER** and **DVD** to switch to DVD mode.

Operation with tape (Continued)

Timer recording using On Screen Display

You may set up to seven timer record events within one month of the current date.

Note

Before setting the timer make sure that you have set the DVD+VCR clock correctly and you know which stations you have tuned TV stations on your DVD+VCR.

- 1 Insert a video cassette with protection tab into your DVD+VCR.
The video cassette should have the window side facing up and the arrow facing away from you.
- 2 Press **SYSTEM MENU**.
Press **◀** or **▶** to select **REC**.
Press **OK**.
- 3 Press **OK** to start setting the timer record event.
If all timer record events are full press **▲** or **▼** to select the event that you wish to remove and replace.
Press **◀** to delete the event.

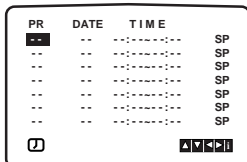

- 4 Press the **numbered buttons** to enter the station that you wish to record.
When selecting stations 1 - 9, press 0 first, then the channel number; for example Stations 3 - 03. You may also select Channels by pressing **▲** or **▼**. Once selected press **▶**.
If you wish to record from AUDIO IN (L/R) and VIDEO IN on the front or from the EURO SCART sockets on the back of your unit, press INPUT to select for correct display (AV1, AV2 or AV3).

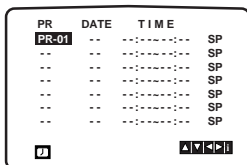

- 5 Press the **numbered buttons** to enter the date of the programme.
If you press **OK** before entering the date you may select one of the following automated recording features. Use **◀** or **▶** to select, then press **OK** to confirm.
DLY To record every day (except Saturday and Sunday) at the same time.
SU ~ SA To record at the same time every week.

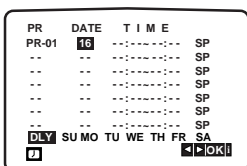

- 6 Press the **numbered buttons** to enter the recording start and end times of the programme that you wish to record.

Please note your DVD+VCR uses a 24 hour clock. e.g. 1pm will be displayed as 13:00.

You may also select the start and end times by using **▲** or **▼**.

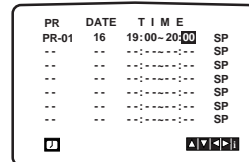

- 7 Press **▶** to select the recording speed.
Press **▲** or **▼** to select the desired tape speed (SP, IP, or LP).
IP mode determines how much tape is left and switches speed from SP to LP, if necessary, to complete recording the program.

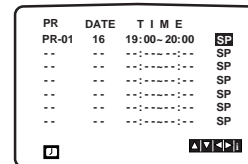

Press **SYSTEM MENU** to set another timer record event and follow steps 3 to 7.

- 8 Check that the timer event details are correct.
Press **SYSTEM MENU** twice.
If **PLEASE CHECK** is displayed, you have entered incorrect and will need to re-enter the data.
Press **⏻** to switch your DVD+VCR Standby.
TIMER will appear in the display window while your DVD+VCR waits to make the recording.
To watch a DVD during timer recording standby mode, press **POWER** and **DVD** to switch to DVD mode.

Notes

- If at a later date you wish to **delete** or **change** any of the settings in timer event memory you may do so without having to enter all the timer event information again. Simply display the timer event screen. Use **▲** or **▼** to select the event that you wish to **delete** or **change**.
Press **◀** to delete the event...or
Press **OK** to change; then press **◀** or **▶** to select; Station, Date, Start and End times and LP. Press **▲** or **▼** to enter the correct information.
- **If Timer record events Overlap...**
Make sure that the preset times of the timer recording events do not overlap. If they do, the earlier programme will always be given priority.

Example:

Programme 1 is programmed to start at 16:00 and end at 17:00.

Programme 2 is programmed to start at 16:30 and end at 17:30.

(In this case, Programme 1 will be recorded in its entirety, but only the last 30 minutes of Programme 2 will be recorded.)

Playing a DVD and Video CD

Playback Setup **DVD** **VCD2.0** **VCD1.1**

- Turn on the TV and select the video input source connected to the DVD player.
- Audio system: Turn on the audio system and select the input source connected to the DVD player.

1 Press **OPEN/CLOSE** to open the disc tray.

2 Load your chosen disc in the tray, with the playback side down.

When a double-sided DVD is inserted, make sure the side you want to play is facing down.

3 Press **OPEN/CLOSE** to close the tray. **READING** appears on the TV screen, and playback starts automatically. If playback does not start, press **PLAY** . In some cases, the disc menu might appear instead.

If a menu screen is displayed

The menu screen may be displayed first after loading a DVD or Video CD which offer a menu.

DVD

Use the buttons to select the title/chapter you want to view, then press **OK** to start playback. Press **TITLE** or **DISC MENU** to return to the menu screen.

VCD2.0

- Use the number buttons to select the track you want to view. Press **RETURN** to return to the menu screen.
- Menu setting and the exact operating procedures for using the menu may differ depending on the disc. Follow the instructions on the each menu screen. You also may set **PBC** to **Off** under setup. See page 19.

Notes

- If Parental Control is set and the disc is not within the Rating settings (not authorized), the 4-digit code must be entered and/or the disc must be authorized (see “Parental Control”, on page 20).
- DVDs may have a region code. Your player will not play discs that have a region code different from your player. The region code for this player is 2 (two).
- To watch a DVD during timer recording standby mode, press **POWER** and **DVD** to switch to DVD mode.

General Features

Note

Unless stated otherwise, all operations described use the remote control. Some features may also be available on the Setup menu.

Moving to another **TITLE** **DVD** 1/3

When a disc has more than one title, you can move to another title as follows:

- Press **DISPLAY**, then press the appropriate numbered button (0-9) to select a title number.

Moving to another **CHAPTER/TRACK**

DVD **VCD1.1** 1/12 1/3

When a title on a disc has more than one chapter or a disc has more than one track, you can move to another chapter/track as follows:

- Press or briefly during playback to select the next chapter/track or to return to the beginning of the current chapter/track.
- Press twice briefly to step back to the previous chapter/track.
- To go directly to any chapter during DVD playback, press **DISPLAY**. Then, press / to select chapter/track icon. Then, enter the chapter/track number using the numbered buttons (0-9).

Note

For two-digit numbers, press the numbered buttons (0-9) in rapid succession.

Search **DVD** **VCD2.0** **VCD1.1**

- 1 Press or for about two seconds during playback. The player will now go into **SEARCH** mode.
- 2 Press or repeatedly to select the required speed:
 - ◀◀X2, ◀◀X4, ◀◀X16, ◀◀X100 (backward) or ▶▶X2, ▶▶X4, ▶▶X16, ▶▶X100 (forward).
 - With a Video CD, the Search speed changes:
 - ◀◀X2, ◀◀X4, ◀◀X8 (backward) or ▶▶X2, ▶▶X4, ▶▶X8 (forward).
- 3 To return to playback, press **PLAY** .

Still Picture and Frame-by-frame playback

DVD **VCD2.0** **VCD1.1**

- 1 Press **PAUSE/STEP** during playback. The player will now go into **PAUSE** mode.
- 2 You can advance the picture frame-by-frame by pressing **PAUSE/STEP** repeatedly on the remote control.

Operation with DVD and Video CD

General Features (continued)

Slow Motion **DVD VCD2.0 VCD1.1**

- 1 Press **◀◀** or **▶▶** during still mode.
The player will enter SLOW mode.
- 2 Press **◀◀** or **▶▶** repeatedly to select the required speed : **◀◀ 1/16**, **◀◀ 1/8**, **◀◀ 1/4** or **◀◀ 1/2** (backward) or **▶▶ 1/16**, **▶▶ 1/8**, **▶▶ 1/4** or **▶▶ 1/2** (forward).
- 3 To exit slow motion mode, press **PLAY ▶**.

N Note

- Slow motion playback in reverse is not applicable for Video CD.

Shuffle **Karaoke DVD VCD2.0 VCD1.1**

- 1 Press **SHUFFLE** during playback or in stop mode.
The unit automatically begins Random Playback and "RANDOM" appears on the TV screen.
- 2 To return to normal playback, press **SHUFFLE** again until "NORMAL" appears on the TV screen.

T Tips

By pressing **▶▶** during Random playback, the unit selects another title (track) and resumes Random playback.

N Note

- This function only works with DVD karaoke discs and video CD without PBC.
- On a Video CD with PBC, you must set PBC to Off on the setup menu to use the Random function. See page 19.

Repeat **DVD VCD2.0 VCD1.1**



DVD Video Discs - Repeat Chapter/Title/Off

- 1 To repeat the currently playing chapter, press **REPEAT**.
The Repeat Chapter icon appears on the TV screen.
- 2 To repeat the title currently playing, press **REPEAT** a second time.
The Repeat Title icon appears on the TV screen.
- 3 To exit Repeat mode, press **REPEAT** a third time.
The Repeat Off icon appears on the TV screen.

Video CDs - Repeat Track/All/Off

- 1 To repeat the track currently playing, press **REPEAT**.
The Repeat Track icon appears on the TV screen.
- 2 To repeat the disc currently playing, press **REPEAT** a second time.
The Repeat All icon appears on the TV screen.
- 3 To exit Repeat mode, press **REPEAT** a third time.
The Repeat Off icon appears on the TV screen.

N Note

On a Video CD with PBC, you must set PBC to Off on the setup menu to use the Repeat function. See page 19.

Repeat A-B **DVD VCD2.0 VCD1.1**



To repeat a sequence in a title:

- 1 Press **REPEAT A-B** at your chosen starting point.
A * appears briefly on the TV screen.
- 2 Press **REPEAT A-B** again at your chosen end point.
A B appears briefly on the TV screen, and the repeat sequence begins ("A ↔B" appears the display window).
- 3 To cancel the sequence, press **REPEAT A-B**.

Time Search **DVD**



The Time Search function allows you to start playing at any chosen time on the disc.

- 1 Press **DISPLAY** during playback. The on-screen display appears on the screen.
The Time Search box shows the elapsed playing time of the current disc.
- 2 Within 10 seconds, press **▲/▼** to select the Time Search icon in the on-screen display.
The "-:-:-" appears in the Time Search box.
- 3 Within 10 seconds, use the number buttons to enter the required start time. Enter hours, minutes, and seconds from left to right in the box.
If you enter the wrong numbers, press **CLEAR** to remove the numbers you entered. Then enter the correct numbers.
- 4 Within 10 seconds, press **OK** to confirm the start time.
Playback starts from the selected time on the disc. If you enter an invalid time, playback will continue from the current point.

3D Surround **DVD VCD2.0 VCD1.1**



This unit can produce a 3D Surround effect, which simulates multi-channel audio playback from two conventional stereo speakers, instead of the five or more speakers normally required to listen to multi-channel audio from a home theater system.

- 1 Press **DISPLAY** during playback.
- 2 Use **▲/▼** to select the sound icon.
The sound option will be highlighted.
- 3 Use **◀/▶** to select "NORM.", or "3D SUR".

Screen Saver

A screen saver image appears when you leave the DVD Player in stop mode for about fifteen minutes.

General Features (continued)

Zoom **DVD** **VCD2.0** **VCD1.1**

The Zoom function allows you to enlarge the video image and to move through the enlarged image.

- 1 Press ZOOM during playback or still playback to activate the Zoom function.
If you press ZOOM repeatedly, the magnification level increase up to six steps
- 2 Use the ◀▶▲▼ buttons to move through the zoomed picture.
- 3 Press CLEAR to resume normal playback or return to the paused image.

N Note

- The zoom function may not work for some DVDs.

Marker Search **DVD** **VCD2.0** **VCD1.1**



You can start playback from a memorized point. Up to nine points can be memorized.

To enter a mark, follow these steps.

- 1 During disc playback, press MARKER when playback reaches the spot that you want to memorize.
The Marker icon will appear on the TV screen briefly.
- 2 Repeat step 1 to enter up to nine Marker points on a disc.

To Recall a Marked Scene

- 1 During disc playback, press SEARCH.
The MARKER SEARCH menu will appear on the screen.
- 2 Within 10 seconds, press ◀▶ to select a Marker number that you want to recall.
- 3 Press OK.
Playback will start from the Marked scene.
- 4 To remove the MARKER SEARCH menu, press SEARCH.

To clear a Marked Scene

- 1 During disc playback, press SEARCH.
The MARKER SEARCH menu will appear on the screen.
- 2 Within 10 seconds, press ◀▶ to select a Marker number that you want to erase.
- 3 Press CLEAR.
The Marker number will be erased from the list.
- 4 Repeat steps 2 and 3 to erase additional Marker numbers.
- 5 To remove the MARKER SEARCH menu, press SEARCH.

Special DVD Features **DVD**

Checking the contents of DVD Video discs: Menus

DVDs may offer menus that allow you to access special features. To use the disc menu, press DISC MENU. Then, press the appropriate number button to select an option. Or, use the ◀▶/▲/▼ buttons to highlight your selection, then press OK.

Title Menu **DVD**

- 1 Press TITLE.
If the current title has a menu, the menu will appear on the screen. Otherwise, the disc menu may appear.
- 2 The menu can list camera angles, spoken language and subtitle options, and chapters for the title.
- 3 To remove the title menu, press TITLE again.

Disc Menu **DVD**

- 1 Press DISC MENU.
The disc menu is displayed.
- 2 To remove the disc menu, press DISC MENU again.

Camera Angle **DVD**

If the disc contains sequences recorded from different camera angles, the angle icon blinks on the TV screen. You can then change the camera angle if you wish.

- Press ANGLE repeatedly during playback to select a desired angle.
The number of the current angle appears on the display.

Changing the Audio Language **DVD**

Press AUDIO repeatedly during playback to hear a different audio language or audio track.

Changing the Audio Channel **VCD2.0** **VCD1.1**

Press AUDIO repeatedly during playback to hear a different audio channel (STER., LEFT or RIGHT).

Subtitles **DVD**

Press SUBTITLE repeatedly during playback to see the different subtitle languages.

N Note

If  appears, the feature is not available on the disc.

Operation with Audio and MP3 Disc

Playing an Audio CD and MP3 Disc

CD MP3

The DVD Player can play MP3 formatted recordings on CD-ROM, CD-R or CD-RW discs.

Before playing MP3 recordings, read the notes on MP3 Recordings on right.

- 1 Insert a disc and close the tray.**
Audio CD; Audio CD menu appears on the TV screen go to step 4.
MP3 disc; The MP3-JPEG choice menu appears on the TV screen. Go to step 2



- 2 Use ▲/▼ to select the MP3 then press OK.**
The MP3 menu appears on the TV screen.
Press RETURN to move to the MP3 -JPEG choice menu.

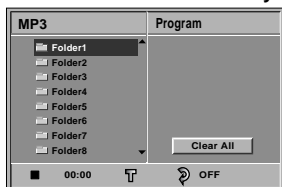

- 3 Use ▲/▼ to select a folder then press OK.**
A list of files in the folder appears.
- 4 Use ▲/▼ to select a track then press PLAY ► or OK.**
Playback starts.
During playback, the current track's elapsed playing time will appear on the display window and menu.
Playback will stop at the end of the disc.
Press TITLE to move to the next page.
Press DISC MENU to move to the previous page.

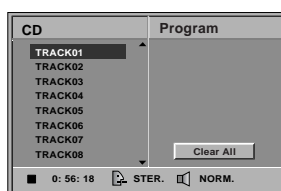

Audio CD menu

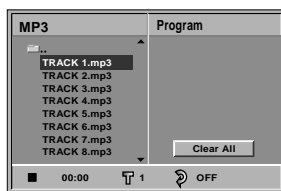

MP3 menu

Tip

If you are in a file list and want to return to the Folder list, use the ▲/▼ to highlight and press OK to return to the previous menu screen.

- 5 To stop playback at any other time, press STOP ■.**

Notes on MP3 Recordings

About MP3

- An MP3 file is audio data compressed by using the MPEG1 audio layer-3 file-coding scheme. We call files that have the ".mp3" file extension "MP3 files".
- The player cannot read an MP3 file that has a file extension other than ".mp3".

MP3 Disc compatibility with this player is limited as follows:

- 1 Sampling Frequency / only at 44.1kHz
- 2 Bit rate / within 32 - 320kbps
- 3 CD-R physical format should be "ISO 9660"
- 4 If you record MP3 files using the software which cannot create a FILE SYSTEM, for example "Direct-CD" etc., it is impossible to playback MP3 files. We recommend that you use "Easy-CD Creator", which creates an ISO9660 file system.
- 5 A single session disc requires MP3 files in the first track. If there is no MP3 file in the 1st track, it cannot playback MP3 files. If you wish to playback MP3 files, format all the data in the disc or use a new one.
- 6 File names should be named using 8 letters or less and must incorporate ".mp3" extension e.g. "*****.MP3".
- 7 Do not use special letters such as "/ : * ? < >" etc.
- 8 Total number of files on the disc should be less than 650.

This DVD player requires discs/recordings to meet certain technical standards in order to achieve optimal playback quality. Pre-recorded DVDs are automatically set to these standards. There are many different types of recordable disc formats (including CD-R containing MP3 files). That require certain pre-existing conditions (see above) to insure compatible playback.

Customers should also note that permission is required in order to download MP3 files and music from the Internet. Our company has no right to grant such permission. Permission should always be sought from the copyright owner.

Operation with Audio and MP3 Disc (Continued)

Pause **CD** **MP3**

- 1 Press PAUSE/STEP during playback.
- 2 To return to playback, press PLAY ► or press PAUSE/STEP again.

Moving to another Track **CD** **MP3**

- Press ◀◀ or ▶▶ briefly during playback to go to the next track or to return to the beginning of the current track.
- Press ◀◀ twice briefly to step back to the previous track.
- In case of audio CD, to go directly to any track, enter the track number using the numbered buttons (0-9) during playback.

Repeat Track/All/Off **CD** **MP3**

- 1 To repeat the track currently playing, press REPEAT. The Repeat icon and "TRACK" appears on the menu screen.
- 2 To repeat all tracks on a disc, press REPEAT a second time. The Repeat icon and "ALL" appears on the menu screen.
- 3 To cancel Repeat mode, press REPEAT a third time. The Repeat icon and "OFF" appears on the menu screen.

Search **CD** **MP3**

- 1 Press ◀◀ or ▶▶ during playback. The player will now go into SEARCH mode.
- 2 Press ◀◀ or ▶▶ repeatedly to select the required speed: ◀◀X2, ◀◀X4, ◀◀X8 (backward) or ▶▶X2, ▶▶X4, ▶▶X8 (forward). Search speed and direction are indicated on the menu screen.
- 3 To exit SEARCH mode, press PLAY ►.

Shuffle **CD** **MP3**

- 1 Press SHUFFLE during playback or when playback is stopped. The unit automatically begins Random Playback and "RAND." appears on the menu screen.
- 2 To return to normal playback, press SHUFFLE. "RAND." disappears on the menu screen.

Repeat A-B **CD**

To repeat a sequence.

- 1 During disc playback, press REPEAT A-B at your chosen starting point. The Repeat icon and "A * " appears on the menu screen.
- 2 Press REPEAT A-B again at your chosen end point. The Repeat icon and "A B" appears on the menu screen, and the sequence begins to play repeatedly.
- 3 To exit the sequence and return to normal play, press REPEAT A-B again. The Repeat icon and "OFF" appears on the menu screen.

3D Surround **CD**

This unit can produce a 3D Surround effect, which simulates multi-channel audio playback from two conventional stereo speakers, instead of the five or more speakers normally required to listen to multi-channel audio from a home theater system.

- 1 Press DISPLAY or AUDIO during playback.
- 2 Use ◀/▶ to select the sound icon. The sound option will be highlighted.
- 3 Use ▲/▼ to select "NORM.", or "3D SUR".

Changing the Audio Channel **CD**

Press AUDIO repeatedly during playback to hear a different audio channel (STER., LEFT, or RIGHT).

Operation with JPEG Disc

Viewing a JPEG disc

This DVD+VCR can play discs with JPEG files and Kodak picture CD. Before playing JPEG recordings, read the notes on JPEG Recordings on right.

- 1 Insert a disc and close the tray.**
The MP3-JPEG choice menu appears on the TV screen.



- 2 Use ▲/▼ to select the JPEG then press OK.**
The JPEG menu appears on the TV screen.



- 3 Use ▲/▼ to select a folder then press OK.**
A list of files in the folder appears.
Press RETURN to move to the MP3-JPEG choice menu.

Tip

If you are in a file list and want to return to the Folder list, use the ▲/▼ buttons on the remote to highlight “” and press OK to return to the previous menu screen.

- 4 If you want to view a particular file, press ▲/▼ to highlight a file and press OK or PLAY ►.**

Viewing the file proceeding starts.

During viewing a file, press RETURN to move to the previous menu (JPEG menu).

Press TITLE to move to the next page.

Press DISC MENU to move to the previous page.

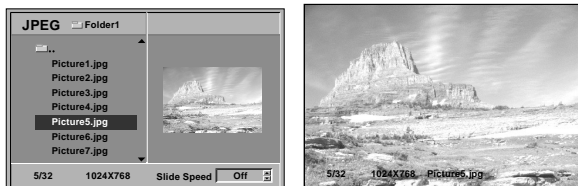

Tip

There are three viewing Slide Speed options: Fast, Normal, Slow, and Off. Press ◀▶ to highlight the Slide Speed then press ▲/▼ to select the option you want to use, and press OK.

- 5 To stop viewing at any other time, press STOP.**
The JPEG menu appears.

Moving to another File

Press ◀◀ or ▶▶ once during viewing a picture to advance to the next file or to the previous file.

Still Picture

- 1 Press PAUSE/STEP during slide show.**

The player will now go into PAUSE mode.

- 2 To return to the slide show, press PLAY ► or press PAUSE/STEP again.**

To flip the picture

Press ▲/▼ during showing a picture to flip the picture horizontally or a vertically.

To rotate picture

Press ◀/▶ during showing a picture to rotate the picture clockwise or counter clockwise.

Notes on JPEG Recordings

- Depending upon the size and number of the JPEG files, it could take a long time for the DVD+VCR to read the disc's contents. If you don't see an on-screen display after several minutes, some of the files are too big — reduce the resolution of the JPEG files to less than 2 mega pixels and burn another disc.
- Total number of files and folders on the disc should be less than 650.
- Some disc may be incompatible due to different recording format or condition of disc.
- When you are using software such as “Easy CD Creator” to burn the jpeg files into the CD-R, ensure that all the selected files have the “.jpg” extensions when copying into the CD layout.
- If the files have “.jpe” or “.jpeg” extensions, please rename them as “.jpg” files.
- File names without “.jpg” extension will not be able to be read by this DVD+VCR. Even though the files are shown as JPEG image files in windows explorer.

Programmed Playback with Audio CD and MP3 Disc

The Program function enables you to store your favorite tracks from any disc in the player memory. Program can contain 30 tracks.

- 1 Press **PROGRAM** during playback or in the stop mode to enter the Program Edit mode.

The  mark will appear to the right of the word Program on the right side of the menu screen.

Note

Press **PROGRAM** to exit the Program Edit mode; the  mark will disappear.

- 2 Select a track, then press **OK** to place the selected track on the Program list.
- 3 Repeat step 2 to place additional tracks on the Program list.

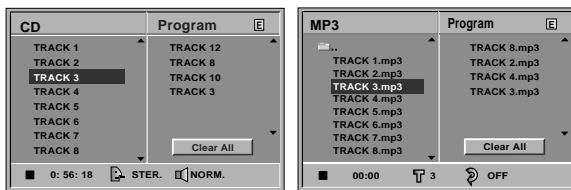

Audio CD menu

MP3 menu

- 4 Press **▶**.
The programmed track you selected last is highlighted on the program list.
- 5 Use **▲/▼** to select the track you want to start playing.
Press **TITLE** to move to the next page.
Press **DISC MENU** to move to the previous page.
- 6 Press **PLAY ▶** to start.
Playback begins in the order in which you programmed the tracks and "PROG." appears on the menu screen.
Playback stops after all of the tracks on the Program list have played once.
- 7 To resume normal playback from programmed playback, press program to disappear the  mark and then select a track of CD (or MP3) list and then press **OK**.
"PROG." disappears on the menu screen.

Programmed Playback with Video CD

Note

On a Video CD with PBC, you must set PBC to Off on the setup menu to use the Program function. See page 19.

- 1 Insert Video CD and close the tray.
- 2 Press **PROGRAM** while playback is stopped.
The VCD Program menu will appear.

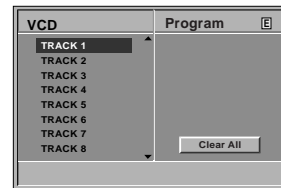

Note

Press **RETURN** or **PROGRAM** to exit the Program menu.

- 3 Follow steps 2-6 of "Programmed Playback with Audio CD and MP3 disc" on left.
- 4 To resume normal playback from programmed playback, press **PROGRAM**.
"NORMAL" appears on the TV screen.

Repeat Programmed Tracks

- To repeat the track currently playing, press **REPEAT**.
The Repeat icon and "TRACK" appears on the menu screen.
- To repeat all tracks on the program list, press **REPEAT** a second time.
The Repeat icon and "ALL" appears on the menu screen.
- To cancel Repeat mode, press **REPEAT** a third time.
The Repeat icon and "OFF" appears on the menu screen.

Erasing a Track from Program List

- 1 Press **PROGRAM** during playback (Audio CD and MP3 disc only) or in the stop mode to enter the Program Edit mode.
The  mark will appear.
- 2 Press **▶** to move to the Program list.
- 3 Use **▲/▼** to select the track that you wish to erase from the Program list.
- 4 Press **CLEAR**.
The track will be erased from the Program list.

Erasing the Complete Program List

- 1 Follow steps 1-2 of "Erasing a Track from Program List" as above.
- 2 Use **▲/▼** to select "Clear All", then press **OK**.
The complete Program for the disc will be erased.
The programs are also cleared when the disc is removed.

Additional Operation

On Screen Display

You may easily display the current time or tape counter, amount of tape left, day, month, year, day of week, programme channel, tape speed and operational mode of your VCR on the TV screen. If a recording is taking place these On Screen Displays will not be recorded onto the tape.

- 1 Press **DISPLAY** to display.
Press **DISPLAY** repeatedly to cycle through the display options. The tape counter and amount of tape left will appear if there is a tape loaded.
- 2 After 3 seconds the majority of the On Screen Displays will clear leaving only the clock or tape counter and the amount of tape left on the screen.
Press **DISPLAY** again to remove all displays from the TV screen.

Tape Counter Memory Stop

The **Digital Tape Counter** can be displayed on the display window instead of the time by pressing **DISPLAY** on the remote control. The Digital Tape Counter indicates the relative positions of recordings on the tape.

- 1 Press **DISPLAY**.
Press **CLEAR** to set the counter to 0:00:00.
Press **PLAY** ► or start recording.
The tape counter will display the actual play time in hours, minutes and seconds.
- 2 Press **STOP** ■ when playback or recording is complete.
Press **REWIND** ◀◀.
The tape will rewind and automatically stop when the counter returns to 0:00:00.

Child Lock

The control buttons on the front of the VCR can be switched off so that your VCR can only be operated using the remote control.

- 1 Press **C.LOCK**.
◻ will appear in the display window.
None of the buttons on the front of your VCR will work (except **EJECT**).
If any buttons on the front of your unit are pressed ◻ will flicker in the display window for a few seconds.
- 2 Press **C.LOCK** again to switch off the child lock.
◻ will disappear in the display window.

Note

- C.LOCK is not available on the DVD mode.

Video Doctor (Self-Diagnosis)

This feature informs you that there is a problem with your VCR. These error messages will appear on the TV screen.

- 1 Press **SYSTEM MENU**.
Press ◀ or ▶ to select **Dr.**
Press **OK**.

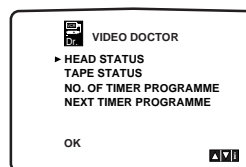
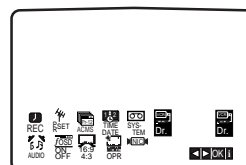

- 2 Press ▲ or ▼ to check a problem.
HEAD STATUS
 - **PLEASE CLEAN:**
Clean your video heads.**TAPE STATUS**
 - **NOT RECORDABLE:**
Insert a tape with its protection tab in place**NO. OF TIMER PROGRAMME**
 - **2**
Shows the number of timer recording.**NEXT TIMER PROGRAMME**
 - **PR-01 26 10:00~11:00 SP**
Shows the current status of timer recording.Press **SYSTEM MENU**.

Hi-Fi Stereo Sound System

Your VCR will record and playback Hi-Fi stereo sound. In addition it has a stereo NICAM digital stereo sound decoder. This allows you to record and playback the sound in several different ways. Video cassettes recorded on your VCR will have a normal mono audio track and two VHS Hi-Fi stereo audio tracks. These stereo tracks allow you to make audio recordings in Hi-Fi stereo or bilingual mode from a TV broadcast, stereo audio system, video disc or another Hi-Fi VCR.

- 1 Your VCR's NICAM digital sound decoder allows you to enjoy broadcasts with NICAM sound, as well as standard stereo, bilingual and mono sound. The particular type of sound received or that recorded will be briefly displayed on the TV screen for a couple of seconds:

STEREO NICAM

Sound is automatically recorded on the Hi-Fi stereo and mono tracks of the video tape.

BIL NICAM

Both audio channels will be recorded on the Hi-Fi stereo tracks. The primary language channel (left) will be recorded on the mono track of the video tape.

MONO

The sound is recorded on the Hi-Fi tracks and the mono track of the video tape without any separation.

- 2 Press **SYSTEM MENU**. Press ◀ or ▶ to select **AUDIO**.
- 3 Press ▲ or ▼ to select **STEREO, LEFT, RIGHT** and **MONO**.
In **BIL NICAM** playback the primary language is output on the left channel and the secondary channel is output simultaneously from the right channel when audio output is set to **STEREO**. The primary language will be output from both channels when the audio setting is **MONO**.
Please note that when adjusting the tracking control Hi-Fi stereo sound may revert to **MONO**.

- 2 Press ▲ or ▼ repeatedly to select: **AUTO, 4:3** or **16:9**.

AUTO:

Automatically plays back Wide-Screen programmes as Wide-Screen and Normal programmes as normal.

4:3

Only for playing back and recording Normal format recordings (4:3).

16:9:

Only for playing back and recording Wide-Screen format recordings (16:9).

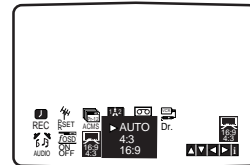

- 3 Press **SYSTEM MENU** to remove the menus from the TV screen.

To enjoy Wide-Screen playback you must connect your VCR to the TV using a SCART cable.

Last Condition Memory **DVD** **CD** **VCD1.1**

This player memorizes the last condition for the last disc you have watched. Settings remain in memory even if you remove the disc from the player or switch off the player. If you load a disc that has its settings memorized, the latest stop position is automatically recalled.

N Notes

- Settings are stored in memory for use any time.
- This player does not memorize settings of a disc if you switch off the player before commencing to play it.

Wide Screen Compatibility 16:9

Your VCR can record and play back wide screen aspect ratio programmes (16:9). To record a wide screen format programme successfully the correct type of wide screen signal must be broadcast by the TV station.

- 1 Switch on your VCR.
Press **SYSTEM MENU**.
Press ◀ or ▶ to select **16:9/4:3**.
Press **OK**.

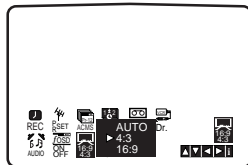
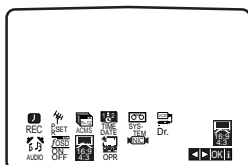

Special Recording

Copying from DVD To VCR

This unit allows you to copy the contents of a DVD to a VHS tape with a press of the DIRECT DUBBING button.

Note

- If the DVD you are attempting to copy is copy protected, you may not be able to copy the disc.

1 Insert Disc

Insert the disc you wish to copy in the DVD deck and close the disc tray.

2 Insert VHS Tape

Insert a blank VHS videotape into the VCR deck.

3 Copy the DVD to VHS Tape

Press the DIRECT DUBBING button on the unit front panel.

- The DVD will go into Play mode and the VCR will go into Record mode.
- If the DVD disc menu appears, you may need to press the Play button manually to begin copying.

4 Stop the Copy Process.

When the DVD is finished playing, press the STOP button **twice** within 5 seconds to end the copy.

- You must stop the Copy process manually when the DVD movie ends, or the unit may replay and record over and over again.

Recording from another video recorder

With this video recorder you can make recordings from an external source, such as copying from another video recorder or a camcorder.

Note

In the following description, this video recorder will be one used for recording and will be referred to as VCR B. The other appliance will be used for playback and will be referred to as VCR A.

- 1** VCR A should be connected to the SCART socket on the rear panel of your unit or the AV sockets on the front panel of your unit.

- 2** Insert the recorded tape into VCR A and a blank tape into VCR B.

- 3** To start recording, press the **RECORD** on VCR B and **PLAY** ► on VCR A.

- 4** When you want to finish copying, press the **STOP** ■ on both video recorders. Press **STOP** twice within 5 seconds.

Check the following guide for the possible cause of a problem before contacting service.

Symptom	Cause	Correction
DVD or VCR do not work properly.	● DVD or VCR button is not switched properly.	● Refer to page 6.
No power.	● The power cord is disconnected.	● Plug the power cord into the wall outlet securely.
The power is on, but the DVD player does not work.	● No disc is inserted.	● Insert a disc. (Check that the DVD or, audio CD indicator in the display window is lit.)
No picture.	● The TV is not set to receive DVD signal output.	● Select the appropriate video input mode on the TV so the picture from the DVD player appears on the TV screen.
	● The video cable is not connected securely.	● Connect the video cable into the jacks securely.
No sound.	● The equipment connected with the audio cable is not set to receive DVD signal output.	● Select the correct input mode of the audio receiver so you can listen to the sound from the DVD player.
	● The audio cables are not connected securely.	● Connect the audio cable into the jacks securely.
	● The power of the equipment connected with the audio cable is turned off.	● Turn on the equipment connected with the audio cable.
	● The Digital Audio Output is set to the wrong position.	● Set the Digital Audio Output to the correct position, then turn on the DVD player again by pressing POWER.
The picture is poor.	● The disc is dirty.	● Clean the disc.
	● The TV channels are not tuned in properly.	● Check tuning, carry out tuning again.
The DVD player does not start playback.	● An unplayable disc is inserted.	● Insert a playable disc. (Check the disc type and Regional code.)
	● The disc is placed upside down.	● Place the disc with the playback side down.
	● The disc is not placed within the guide.	● Place the disc on the disc tray correctly inside the guide.
	● The disc is dirty.	● Clean the disc.
	● The Rating level is set.	● Cancel the Rating function or change the rating level.
The remote control does not work properly.	● There is an obstacle in the path of the remote control and this unit.	● Remove the obstacle.
	● The batteries in the remote control are exhausted.	● Replace the batteries with new ones.
Video tape cannot be inserted.	● Is the cassette compartment empty?	● Eject the tape in.
No Hi-Fi sound	● Audio mode is not set properly.	● Switch 'AUDIO' in the main menu to 'STEREO'.

Video Head Cleaning

Dirt accumulating on the head after a long period of time can cause the playback picture to become blurred or broken up. High quality video cassette tapes will not normally deposit dirt onto the video head, but old or damaged tapes might. Clean the video heads with a commercially available video heads cleaning tape.

Language Code List

Enter the appropriate code number for the initial settings “Disc Audio”, “Disc Subtitle” and/or “Disc Menu” (See page 18).

Code	Language	Code	Language	Code	Language	Code	Language
6566	Abkhazian	7074	Fiji	7678	Lingala	8373	Singhalese
6565	Afar	7073	Finnish	7684	Lithuanian	8375	Slovak
6570	Afrikaans	7082	French	7775	Macedonian	8376	Slovenian
8381	Albanian	7089	Frisian	7771	Malagasy	8379	Somali
6577	Ameharic	7176	Galician	7783	Malay	6983	Spanish
6582	Arabic	7565	Georgian	7776	Malayalam	8385	Sudanese
7289	Armenian	6869	German	7784	Maltese	8387	Swahili
6583	Assamese	6976	Greek	7773	Maori	8386	Swedish
6588	Aymara	7576	Greenlandic	7782	Marathi	8476	Tagalog
6590	Azerbaijani	7178	Guarani	7779	Moldavian	8471	Tajik
6665	Bashkir	7185	Gujarati	7778	Mongolian	8465	Tamil
6985	Basque	7265	Hausa	7865	Nauru	8484	Tatar
6678	Bengali; Bangla	7387	Hebrew	7869	Nepali	8469	Telugu
6890	Bhutani	7273	Hindi	7879	Norwegian	8472	Thai
6672	Bihari	7285	Hungarian	7982	Oriya	6679	Tibetan
6682	Breton	7383	Icelandic	8065	Panjabi	8473	Tigrinya
6671	Bulgarian	7378	Indonesian	8083	Pashto, Pushto	8479	Tonga
7789	Burmese	7365	Interlingua	7065	Persian	8482	Turkish
6669	Byelorussian	7165	Irish	8076	Polish	8475	Turkmen
7577	Cambodian	7384	Italian	8084	Portuguese	8487	Twi
6765	Catalan	7465	Japanese	8185	Quechua	8575	Ukrainian
9072	Chinese	7487	Javanese	8277	Rhaeto-Romance	8582	Urdu
6779	Corsican	7578	Kannada	8279	Rumanian	8590	Uzbek
7282	Croatian	7583	Kashmiri	8285	Russian	8673	Vietnamese
6783	Czech	7575	Kazakh	8377	Samoan	8679	Volapük
6865	Danish	7589	Kirghiz	8365	Sanskrit	6789	Welsh
7876	Dutch	7579	Korean	7168	Scots Gaelic	8779	Wolof
6978	English	7585	Kurdish	8382	Serbian	8872	Xhosa
6979	Esperanto	7679	Laothian	8372	Serbo-Croatian	7473	Yiddish
6984	Estonian	7665	Latin	8378	Shona	8979	Yoruba
7079	Faroese	7686	Latvian, Lettish	8368	Sindhi	9085	Zulu

Country/Area Code List

Enter the appropriate code number for the initial setting "Area Code" (See page 20).

Code	Country/Area	Code	Country/Area	Code	Country/Area	Code	Country/Area
AD	Andorra	ER	Eritrea	LC	Saint Lucia	SC	Seychelles
AE	United Arab Emirates	ES	Spain	LI	Liechtenstein	SD	Sudan
AF	Afghanistan	ET	Ethiopia	LK	Sri Lanka	SE	Sweden
AG	Antigua and Barbuda	FI	Finland	LR	Liberia	SG	Singapore
AI	Anguilla	FJ	Fiji	LS	Lesotho	SH	Saint Helena
AL	Albania	FK	Falkland Islands	LT	Lithuania	SI	Slovenia
AM	Armenia	FM	Micronesia	LU	Luxembourg	SJ	Svalbard and Jan Mayen Islands
AN	Netherlands Antilles	FO	Faroe Islands	LV	Latvia	SK	Slovak Republic
AO	Angola	FR	France	LY	Libya	SL	Sierra Leone
AQ	Antarctica	FX	France (European Territory)	MA	Morocco	SM	San Marino
AR	Argentina	GA	Gabon	MC	Monaco	SN	Senegal
AS	American Samoa	GB	Great Britain	MD	Moldavia	SO	Somalia
AT	Austria	GD	Grenada	MG	Madagascar	SR	Suriname
AU	Australia	GE	Georgia	MH	Marshall Islands	ST	Saint Tome and Principe
AW	Aruba	GF	French Guyana	MK	Macedonia	SU	Former USSR
AZ	Azerbaijan	GH	Ghana	ML	Mali	SV	El Salvador
BA	Bosnia-Herzegovina	GI	Gibraltar	MM	Myanmar	SY	Syria
BB	Barbados	GL	Greenland	MN	Mongolia	SZ	Swaziland
BD	Bangladesh	GM	Gambia	MO	Macau	TC	Turks and Caicos Islands
BE	Belgium	GN	Guinea	MP	Northern Mariana Islands	TD	Chad
BF	Burkina Faso	GP	Guadeloupe (French)	MQ	Martinique (French)	TF	French Southern Territories
BG	Bulgaria	GQ	Equatorial Guinea	MS	Montserrat	TG	Togo
BH	Bahrain	GR	Greece	MT	Malta	TH	Thailand
BI	Burundi	GS	S. Georgia & S. Sandwich Isls.	MU	Mauritius	TJ	Tadjikistan
BJ	Benin	GT	Guatemala	MV	Maldives	TK	Tokelau
BM	Bermuda	GU	Guam (USA)	MW	Malawi	TM	Turkmenistan
BN	Brunei Darussalam	GW	Guinea Bissau	MX	Mexico	TN	Tunisia
BO	Bolivia	GY	Guyana	MY	Malaysia	TO	Tonga
BR	Brazil	HK	Hong Kong	MZ	Mozambique	TP	East Timor
BS	Bahamas	HM	Heard and McDonald Islands	NA	Namibia	TR	Turkey
BT	Bhutan	HN	Honduras	NC	New Caledonia (French)	TT	Trinidad and Tobago
BV	Bouvet Island	HR	Croatia	NE	Niger	TV	Tuvalu
BW	Botswana	HT	Haiti	NF	Norfolk Island	TW	Taiwan
BY	Belarus	HU	Hungary	NG	Nigeria	TZ	Tanzania
BZ	Belize	ID	Indonesia	NI	Nicaragua	UA	Ukraine
CA	Canada	IE	Ireland	NL	Netherlands	UG	Uganda
CC	Cocos (Keeling) Islands	IL	Israel	NO	Norway	UK	United Kingdom
CF	Central African Republic	IN	India	NP	Nepal	UM	USA Minor Outlying Islands
CG	Congo	IO	British Indian Ocean Territory	NR	Nauru	US	United States
CH	Switzerland	IQ	Iraq	NU	Niue	UY	Uruguay
CI	Ivory Coast	IR	Iran	NZ	New Zealand	UZ	Uzbekistan
CK	Cook Islands	IS	Iceland	OM	Oman	VA	Vatican City State
CL	Chile	IT	Italy	PA	Panama	VC	Saint Vincent & Grenadines
CM	Cameroon	JM	Jamaica	PE	Peru	VE	Venezuela
CN	China	JO	Jordan	PF	Polynesia (French)	VG	Virgin Islands (British)
CO	Colombia	JP	Japan	PG	Papua New Guinea	VI	Virgin Islands (USA)
CR	Costa Rica	KE	Kenya	PH	Philippines	VN	Vietnam
CS	Former Czechoslovakia	KG	Kyrgyzstan	PK	Pakistan	VU	Vanuatu
CU	Cuba	KH	Cambodia	PL	Poland	WF	Wallis and Futuna Islands
CV	Cape Verde	KI	Kiribati	PM	Saint Pierre and Miquelon	WS	Samoa
CX	Christmas Island	KM	Comoros	PN	Pitcairn Island	YE	Yemen
CY	Cyprus	KN	Saint Kitts & Nevis Anguilla	PR	Puerto Rico	YT	Mayotte
CZ	Czech Republic	KP	North Korea	PT	Portugal	YU	Yugoslavia
DE	Germany	KR	South Korea	PW	Palau	ZA	South Africa
DJ	Djibouti	KW	Kuwait	PY	Paraguay	ZM	Zambia
DK	Denmark	KY	Cayman Islands	QA	Qatar	ZR	Zaire
DM	Dominica	KZ	Kazakhstan	RE	Reunion (French)	ZW	Zimbabwe
DO	Dominican Republic	LA	Laos	RO	Romania		
DZ	Algeria	LB	Lebanon	RU	Russian Federation		
EC	Ecuador			RW	Rwanda		
EE	Estonia			SA	Saudi Arabia		
EG	Egypt			SB	Solomon Islands		
EH	Western Sahara						

Specification

English

General

Power requirements	AC 230-240V, 50Hz
Power consumption	23W
Dimensions (approx.)	430 X 97.5 X 293 mm (w/h/d)
Mass (approx.)	4.8 kg
Operating temperature	5°C to 35°C (41°F to 95°F)
Operating humidity	5 % to 90 %
Timer	24 hours display type

System

Laser	Semiconductor laser, wavelength 650 nm
Video Head system	Double azimuth 6 heads, helical scanning.
Signal system	PAL
Frequency response	DVD (PCM 96 kHz): 8 Hz to 44 kHz DVD (PCM 48 kHz): 8 Hz to 22 kHz CD: 8 Hz to 20 kHz
Signal-to-noise ratio	More than 100dB (ANALOG OUT connectors only)
Harmonic distortion	Less than 0.008%
Dynamic range	More than 100 dB (DVD) More than 95 dB (CD)

Inputs (VCR)

Audio	-6.0dBm, more than 10 kohms (SCART) -6.0dBm, more than 47 kohms (RCA)
Video	1.0Vp-p, 75 ohms, unbalanced (SCART/RCA)

Outputs (DVD)

Audio output (digital audio)	0.5 V (p-p), 75 Ω, RCA jack x 1
Audio output (analog audio)	2.0Vrms (1 kHz, 0 dB), 600 Ω, RCA jack (L, R) x 2

Outputs (VCR)

Audio	-6.0dBm, less than 1 kohms (SCART)
Video	1.0Vp-p, 75 ohms, unbalanced (SCART)

Design and specifications are subject to change without notice.

Manufactured under license from Dolby Laboratories. "Dolby" and the double-D symbol are trademarks of Dolby Laboratories. Confidential unpublished works. Copyright 1992-1997 Dolby Laboratories. All rights reserved.

"DTS" and "DTS Digital Out" are trademarks of Digital Theater Systems, Inc.

PHILIPS NORGE AS

Sandstuveien 70,
PO Box 1, Manglerud
N-0612 Oslo
NORWAY
Phone: 2274 8250

OY PHILIPS AB

Sinikalliontie 3,
02630 Espo
Helsinki
FINLAND
puh. 09 615 80 250

PHILIPS KUNDTJÄNST

Kollbygatan 7,
Akalla,
16485 Stockholm
SWEDEN
Phone: 08-598 52 250

PHILIPS POLSKA

AL. Jerozolimskie 195B
02-222 Warszawa
POLSKA
Tel.: (022)-571-0-571

PHILIPS SERVICE

V Mezihori 2
180 00 Prague
CZECH REPUBLIC
Phone: (02)-3309 9240

PHILIPS Iberia, S.A.

C/Martinez Villergas, 49
28027 MADRID
SPAIN
Phone: 902-11 33 84

ΦΙΛΙΠΣ ΕΛΛΑΣ ΑΕΒΕ

25ΗΣ ΜΑΡΤΙΟΥ 15
177 78 ΤΑΥΡΟΣ
ΑΘΗΝΑ
Τηλ. 00800 3122 1280

PHILIPS

Österreichische Philips Industrie GmbH
Triesterstrasse 64
1101 Wien
AUSTRIA
Tel: 0810 001 203

PHILIPS INFO CENTER

Alexanderstrasse 1
20099 Hamburg
GERMANY
Tel: 0180-53 56 767

SERVICE CONSOMMATEURS

PHILIPS
BP 0101
75622 Paris Cédex 13
FRANCE
Phone: 0825-889 789

PHILIPS ELECTRONICS IRELAND LIMITED

Consumer Information Center
Newstead, Clonskeagh
DUBLIN 14
Phone: 01-7640292

PHILIPS CONSUMER ELECTRONICS

Servizio Consumatori
Via Casati 23
20052 Monza - Milano
ITALY
Phone: 800 820026

PHILIPS MÁRKASZERVIZ

Kinizsi U 30 - 36
Budapest 1092
HUNGARY
Phone: (01)-2164428

PHILIPS PORTUGUESA, S.A.

Consumer Information Center
Rua Dr. António Loureiro Borge, nr.5
Arquiparque, Miraflores
P-2795 L-A-VEHLA
PORTUGAL
Phone: 021-4163063

PHILIPS CE, The Philips Centre,

420 - 430 London Road,
Croydon, Surrey
CR9 3QR
UNITED KINGDOM
Phone: 0208-665-6350

CONSUMER SERVICES

Prags Boulevard 80. PO Box 1919,
DK-2300 Copenhagen S
DANMARK
Tlf: 32 88 32 00

PHILIPS REPRESENTATION OFFICE

Ul. Usacheva 35a
119048 MOSCOW
RUSSIA
Phone: 095-937 9300

PHILIPS INFO CENTER

Fegistrasse 5
8957 Spreitenbach
SUISSE
Tel.: 0844-800 544

PHILIPS CUSTOMER CARE CENTER

Twee Stationsstraat 80/
80 Rue des Deux Gares
1070 BURSEL/BRUXELLES
BELGIUM (for BENELUX)
Tel: 070-222303

Meet Philips at the Internet
<http://www.philips.com>

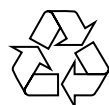

The products and services described herein
are not necessarily available in all countries
Due to continuous product improvements
this document is subject to change without
notice.

Free Manuals Download Website

<http://myh66.com>

<http://usermanuals.us>

<http://www.somanuals.com>

<http://www.4manuals.cc>

<http://www.manual-lib.com>

<http://www.404manual.com>

<http://www.luxmanual.com>

<http://aubethermostatmanual.com>

Golf course search by state

<http://golfingnear.com>

Email search by domain

<http://emailbydomain.com>

Auto manuals search

<http://auto.somanuals.com>

TV manuals search

<http://tv.somanuals.com>