

# INSPIRON™

## SETUP GUIDE



YOURS IS HERE



# INSPIRON™

## SETUP GUIDE

Regulatory model: DCSLF

# Notes, Cautions, and Warnings



**NOTE:** A NOTE indicates important information that helps you make better use of your computer.



**CAUTION:** A CAUTION indicates either potential damage to hardware or loss of data and tells you how to avoid the problem.



**WARNING:** A WARNING indicates a potential for property damage, personal injury, or death.

---

Information in this document is subject to change without notice.

© 2009 Dell Inc. All rights reserved.

Reproduction of these materials in any manner whatsoever without the written permission of Dell Inc. is strictly forbidden.

Trademarks used in this text: *Dell*, the *DELL* logo, *YOURS IS HERE*, *Inspiron*, *Dell On Call*, and *DellConnect* are trademarks of Dell Inc.; *Intel* and *Pentium* are registered trademarks and *Core* is a trademark of Intel Corporation in the U.S. and other countries; *Microsoft*, *Windows*, *Windows Vista*, and *Windows Vista* start button logo are either trademarks or registered trademarks of Microsoft Corporation in the United States and/or other countries; *Blu-ray Disc* is a trademark of the Blu-ray Disc Association; *Bluetooth* is a registered trademark owned by Bluetooth SIG, Inc. and is used by Dell under license.

Other trademarks and trade names may be used in this document to refer to either the entities claiming the marks and names or their products. Dell Inc. disclaims any proprietary interest in trademarks and trade names other than its own.

# Contents

<b>Setting Up Your Inspiron Desktop</b> . . . . .	<b>5</b>	Software Features . . . . .	22
Before Setting Up Your Computer . . . . .	5	Dell DataSafe Online Backup . . . . .	25
Extend the Rear Stabilizing Feet . . . . .	6	Dell Dock . . . . .	26
Connect the Keyboard and Mouse . . . . .	7	<b>Solving Problems</b> . . . . .	<b>27</b>
Connect the Display . . . . .	8	Beep Codes . . . . .	27
Connect the Network Cable (Optional) . . . . .	10	Network Problems . . . . .	28
Connect the Power Cable . . . . .	11	Power Problems . . . . .	29
Press the Power Button . . . . .	12	Memory Problems . . . . .	31
Set Up Microsoft Windows . . . . .	13	Lockups and Software Problems . . . . .	32
Connect to the Internet (Optional) . . . . .	13	<b>Using Support Tools</b> . . . . .	<b>34</b>
<b>Using Your Inspiron Desktop</b> . . . . .	<b>16</b>	Dell Support Center . . . . .	34
Front View Features . . . . .	16	System Messages . . . . .	35
Back View Features . . . . .	18	Hardware Troubleshooter . . . . .	37
Back Panel Connectors . . . . .	20	Dell Diagnostics . . . . .	37

## Contents

<b>Restoring Your Operating System</b> .....	<b>41</b>	<b>Finding More Information and Resources</b> .....	<b>56</b>
System Restore .....	42	<b>Basic Specifications</b> .....	<b>58</b>
Dell DataSafe Local Backup .....	43	<b>Appendix</b> .....	<b>62</b>
Dell Factory Image Restore .....	45	Macrovision Product Notice .....	62
Operating System Reinstallation .....	47	Information for NOM, or Official Mexican Standard (Only for Mexico) .....	63
<b>Getting Help</b> .....	<b>49</b>	<b>Index</b> .....	<b>64</b>
Technical Support and Customer Service .....	50		
DellConnect .....	50		
Online Services .....	51		
Automated Order-Status Service .....	52		
Product Information .....	52		
Returning Items for Repair Under Warranty or for Credit .....	53		
Before You Call .....	54		
Contacting Dell .....	55		

# Setting Up Your Inspiron Desktop

This section provides information about setting up your Inspiron™ desktop.



**WARNING: Before you begin any of the procedures in this section, read the safety information that shipped with your computer. For additional safety best practices information, see the Regulatory Compliance Homepage at [www.dell.com/regulatory\\_compliance](http://www.dell.com/regulatory_compliance).**

## Before Setting Up Your Computer

When positioning your computer, ensure that you allow easy access to a power source, adequate ventilation, and a level surface to place your computer.

Restricting airflow around your computer may cause it to overheat. To prevent overheating ensure that you leave at least 10.2 cm (4 inches) at the back of the computer and a minimum of 5.1 cm (2 inches) on all other sides. You should never place your computer in an enclosed space, such as a cabinet or drawer when it is powered on.

## Extend the Rear Stabilizing Feet

With the computer sitting in an upright position, carefully lift the rear of the computer, and rotate the stabilizing feet outwards. The extended feet ensure maximum system stability.

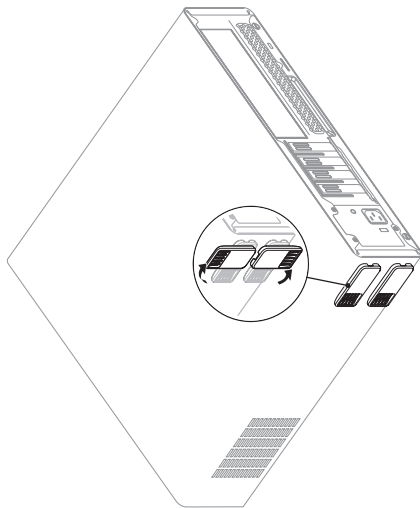



## Connect the Keyboard and Mouse

Connect the USB keyboard and mouse to the USB connectors on the back panel of your computer.

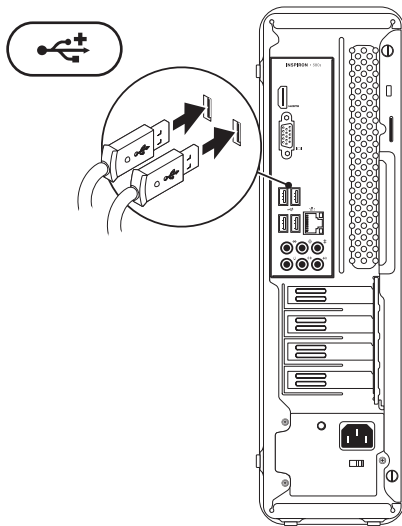

# Connect the Display









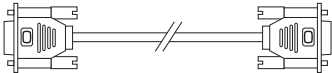
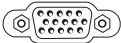

Your computer has integrated VGA and HDMI video connectors.

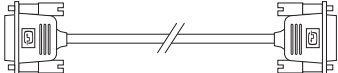
 **NOTE:** A DVI connector may be available if you purchased a discrete graphics card.

You can purchase the HDMI-to-DVI adapter and additional HDMI or DVI cables at [www.dell.com](http://www.dell.com).

Use the appropriate cable based on the connectors available on your computer and display. Refer to the following table to identify the connectors on your computer and display.

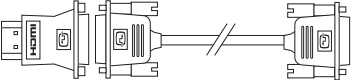
 **NOTE:** When connecting to a single display, connect the display to **ONLY ONE** of the connectors on your computer.

Connection Type	Computer	Cable	Display
VGA-to-VGA (VGA cable)			
DVI-to-DVI (DVI cable)			
HDMI-to-HDMI (HDMI cable)			
HDMI-to-DVI (HDMI-to-DVI adapter + DVI cable)			

## Connect the Network Cable (Optional)

A network connection is not required to complete your computer setup, but if you have an existing network or Internet connection that uses a cable connection (such as a broadband device or Ethernet jack), you can connect it now.

 **NOTE:** Use only an Ethernet cable to connect to the network connector (RJ45 connector). Connect the telephone cable only to the modem connector (RJ11 connector) and not to the network connector (RJ45 connector).

To connect your computer to a network or a broadband device, connect one end of the network cable to the network port or the broadband device. Connect the other end of the network cable to the network connector (RJ45 connector) on the back panel of your computer. A click indicates that the network cable has been securely attached.

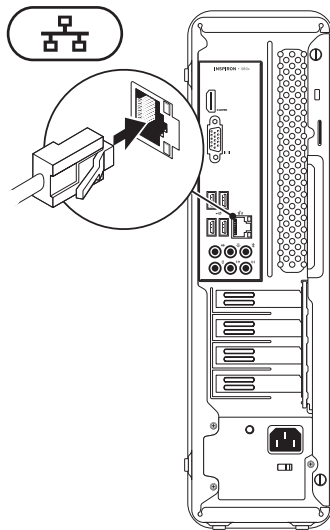

## Connect the Power Cable

**⚠ CAUTION:** To help avoid damaging your computer, ensure that the voltage selector switch is set for the voltage that most closely matches the AC power available in your location.

To locate the voltage selector switch, see “Back View Features” on page 18.

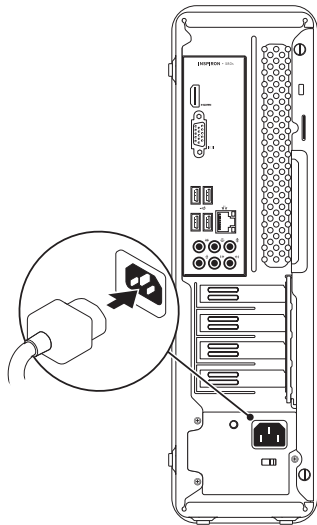

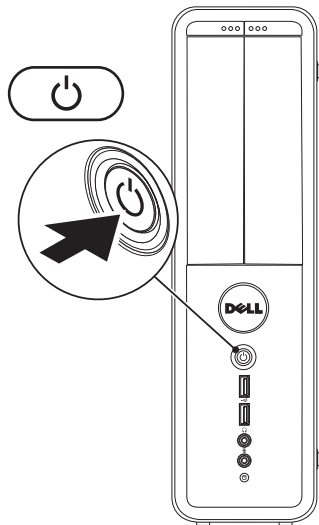

## Press the Power Button



## Set Up Microsoft Windows

Your Dell computer is preconfigured with Microsoft® Windows® operating system. To set up Windows for the first time, follow the instructions on the screen. These steps are mandatory and may take some time to complete. The Windows setup screens will take you through several procedures including accepting license agreements, setting preferences, and setting up an Internet connection.

 **CAUTION: Do not interrupt the operating system's setup process. Doing so may render your computer unusable and you will need to reinstall the operating system.**

 **NOTE:** For optimal performance of your computer, it is recommended that you download and install the latest BIOS and drivers for your computer available at [support.dell.com](http://support.dell.com).

## Connect to the Internet (Optional)

To connect to the Internet, you need an external modem or network connection and an Internet service provider (ISP).

If an external USB modem or WLAN adapter is not part of your original order, you can purchase one at [www.dell.com](http://www.dell.com).

### Setting Up a Wired Connection

- If you are using a dial-up connection, connect the telephone cable to the optional modem and to the telephone wall jack before you set up your Internet connection.
- If you are using a DSL or cable/satellite modem connection, contact your ISP or cellular telephone service for setup instructions.

To complete setting up your wired Internet connection, follow the instructions in “Setting Up Your Internet Connection” on page 14.

### Setting Up a Wireless Connection

 **NOTE:** To set up your wireless router, see the documentation that shipped with your router.

Before you can use your wireless Internet connection, you need to connect to your wireless router.

To set up your connection to a wireless router:

*Windows Vista®*

1. Save and close any open files, and exit any open programs.
2. Click **Start**  → **Connect To**.
3. Follow the instructions on the screen to complete the setup.

*Windows® 7*

1. Save and close any open files, and exit any open programs.
2. Click **Start**  → **Control Panel** → **Network and Internet** → **Network and Sharing Center** → **Connect to a network**.
3. Follow the instructions on the screen to complete the setup.

### Setting Up Your Internet Connection

ISPs and ISP offerings vary by country. Contact your ISP for offerings available in your country.

If you cannot connect to the Internet but have successfully connected in the past, the ISP might have a service outage. Contact your ISP to check the service status, or try connecting again later.

Have your ISP information ready. If you do not have an ISP, the **Connect to the Internet** wizard can help you get one.



To set up your Internet connection:

### *Windows Vista*

 **NOTE:** The following instructions are applicable for the Windows default view, so they may not apply if you set your Dell™ computer to the Windows classic view.

1. Save and close any open files, and exit any open programs.
2. Click **Start**  → **Control Panel**.
3. Click **Network and Internet** → **Network and Sharing Center** → **Set up a connection or network** → **Connect to the Internet**.

The **Connect to the Internet** window appears.

 **NOTE:** If you do not know which type of connection to select, click **Help me choose** or contact your ISP.

4. Follow the instructions on the screen and use the setup information provided by your ISP to complete the setup.

### *Windows 7*

1. Save and close any open files, and exit any open programs.
2. Click **Start**  → **Control Panel**.
3. Click **Network and Internet** → **Network and Sharing Center** → **Set up a new connection or network** → **Connect to the Internet**.

The **Connect to the Internet** window appears.

 **NOTE:** If you do not know which type of connection to select, click **Help me choose** or contact your ISP.

4. Follow the instructions on the screen and use the setup information provided by your ISP to complete the setup.

# Using Your Inspiron Desktop

This section provides information about the features available on your Inspiron™ desktop.

## Front View Features

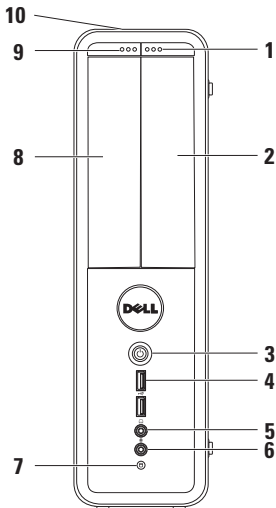

- 1 FlexBay drive eject button** — Opens the Flexbay cover when pressed.
- 2 FlexBay slot** — Can support an optional Media Card Reader or an additional hard drive.

-  **Power button** — Turns the computer on or off when pressed. The light in the center of this button indicates the power state.

**NOTE:** For information on power problems, see “Power Problems” on page 29.

-  **USB 2.0 connectors (2)** — Connects to USB devices that are connected occasionally such as memory keys, digital cameras, and MP3 players.

- 5  **Headphone connector** — Connects to headphones.

**NOTE:** To connect to a powered speaker or sound system, use the audio connectors on the back of your computer.

- 6  **Line-in or microphone connector** — Connects to a microphone for voice or to an audio cable for audio input.

- 7  **Hard-drive activity light** — Turns on when the computer reads or writes data. A blinking white light indicates hard-drive activity.

 **CAUTION: To avoid loss of data, never turn off the computer while the hard-drive activity light is blinking.**

- 8 **Optical drive** — Plays or records CDs, DVDs, and Blu-ray Discs (optional). Ensure that the side with print or writing is facing upward when placing the disc on the optical drive tray.

- 9 **Optical drive eject button** — Ejects the optical drive tray when pressed.

- 10 **Service Tag and Express Service Code (located on top of the chassis towards the back)** — Helps to identify your computer when you access the Dell Support website or call technical support.



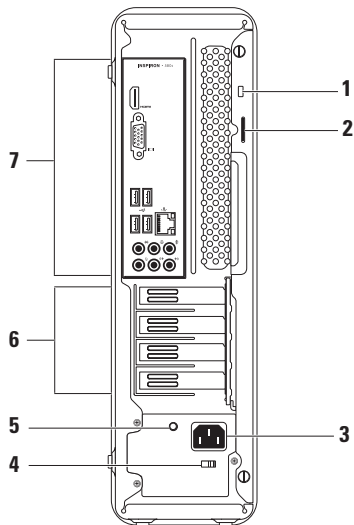





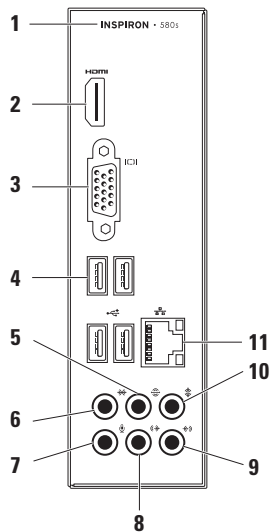

## Back View Features



- 1 Security cable slot** — Attaches a commercially available antitheft device to the computer.
- 2 Padlock rings** — Attaches to a standard padlock to prevent unauthorized access to the interior of your computer,
- 3 Power connector** — Connects to the power cable. Appearance of this connector may vary.
- 4 Voltage selector switch** — Allows to select the voltage rating appropriate for your region.
- 5 Power supply light** — Indicates power availability of the power supply.  
**NOTE:** The power supply light may not be available on all computers.
- 6 Expansion card slots** — Provides access to connectors on any installed PCI and PCI express cards.
- 7 Back panel connectors** — Connects USB, audio, and other devices into the appropriate connectors.

## Back Panel Connectors



- 1 Your computer's model number.
- 2  **HDMI connector** — Connects to a TV for both 5.1 audio and video signals.  
**NOTE:** When used with a monitor, only the video signal will be read.
- 3  **VGA connector** — Connects to the display.
- 4  **USB 2.0 connectors (4)** — Connects to USB devices, such as a mouse, printer, keyboard, external drive, or MP3 player.
- 5  **Rear L/R surround connector** — Connects to rear L/R surround speakers.
- 6  **Side L/R surround connector** — Connects to side L/R surround speakers.
- 7  **Microphone connector** — Connects to a microphone for voice or audio input into a sound or telephony program.
- 8  **Front L/R line-out connector** — Connects to front L/R speakers.
- 9  **Line-in connector** — Connects to recording or playback devices such as a microphone, cassette player, CD player, or VCR.
- 10  **Center/subwoofer connector** — Connects to a center speaker or subwoofer.
- 11  **Network connector and light** — Connects your computer to a network or broadband device if you are using a wired network. The two lights next to the connector indicate status and activity for wired network connection.

## Software Features

 **NOTE:** For more information about the features described in this section, see the *Dell Technology Guide* available on your hard drive or at [support.dell.com/manuals](http://support.dell.com/manuals).

### Productivity and Communication

You can use your computer to create presentations, brochures, greeting cards, fliers, and spreadsheets. You can also edit and view digital photographs and images. Check your purchase order for software installed on your computer.

After connecting to the Internet, you can access websites, setup an e-mail account, and upload or download files.

### Entertainment and Multimedia

You can use your computer to watch videos, play games, create your own CDs, listen to music and radio stations.

You can download or copy pictures and video files from portable devices, such as digital cameras and cell phones. Optional software applications enable you to organize and create music and video files that can be recorded to a disc, saved on portable products such as MP3 players and handheld entertainment devices, or played and viewed directly on connected TVs, projectors, and home theater equipment.



## Customizing the Desktop

You can customize your desktop to change the appearance, resolution, wallpaper, screensaver, or other features of your desktop.

To customize your desktop:

### *Windows Vista*

1. Right-click an open area of the desktop.
2. Click **Personalize**, to open the **Personalize appearance and sounds** window and learn more about your customization options.

### *Windows 7*

1. Right-click an open area of the desktop.
2. Click **Personalize**, to open the **Change the visuals and sounds on your computer** window and learn more about your customization options.

## Customizing Your Energy Settings

You can use the power options in your operating system to configure the power settings on your computer. The Microsoft® Windows® operating system installed on your Dell computer provides the following options:

- **Balanced/Dell Recommended** — Offers full performance when you need it and saves power during periods of inactivity.
- **Power saver** — Saves power on your computer by reducing system performance to maximize the life of the computer and by reducing the amount of energy consumed by your computer over its lifetime.
- **High performance** — Provides the highest level of system performance on your computer by adapting processor speed to your activity and by maximizing system performance.

### Transferring Information to a New Computer

To transfer information to a new computer:

#### *Windows Vista*

 **NOTE:** The following instructions are applicable for the Windows default view, so they may not apply if you set your Dell™ computer to the Windows Classic view.

1. Click **Start**  → **Control Panel** → **System and Maintenance** → **Welcome Center** → **Transfer files and settings**.  
If the **User Account Control** window appears, click **Continue**.
2. Follow the instructions on the **Windows Easy Transfer** wizard.

#### *Windows 7*

1. Click **Start**  → **Control Panel**.
2. In the search box type `Transfer` and then click **Transfer files from another computer**.
3. Follow the instructions on the **Windows Easy Transfer** wizard.

### Backing Up Your Data

It is recommended that you periodically back up files and folders on your computer. To back up files:

#### *Windows Vista*

1. Click **Start**  → **Control Panel** → **System and Maintenance** → **Back Up and Restore Center** → **Back up files**.



If the **User Account Control** window appears, click **Continue**.

-  **NOTE:** Certain editions of Windows Vista provide an option to back up your computer.
2. Follow the instructions on the **Back Up Files** wizard.

#### *Windows 7*

1. Click **Start**  → **Control Panel** → **System and Security** → **Back Up and Restore**.
2. Click **Set up backup...**
3. Follow the instructions on the **Configure Backup** wizard.

## Dell DataSafe Online Backup

-  **NOTE:** Dell DataSafe Online may not be available in all regions.
-  **NOTE:** A broadband connection is recommended for fast upload or download speeds.

Dell DataSafe Online is an automated backup and recovery service that helps protect your data and other important files from catastrophic incidents like theft, fire, or natural disasters. You can access the service on your computer using a password-protected account.

For more information, go to [delldatasafe.com](http://delldatasafe.com).

To schedule backups:

1. Double-click the Dell DataSafe Online icon  on the taskbar.
2. Follow the instructions that appear on the screen.

# Dell Dock

The Dell Dock is a group of icons that provides easy access to frequently-used applications, files, and folders. You can personalize the Dock by:

- Adding or removing icons
- Changing the color and location of the Dock
- Grouping related icons into categories
- Changing the behavior of the icons



## Add a Category

1. Right-click the Dock, click **Add**→ **Category**. The **Add/Edit Category** window is displayed.
2. Enter a title for the category in the **Title** field.
3. Select an icon for the category from the **Select an image:** box.
4. Click **Save**.

## Add an Icon

Drag and drop the icon to the Dock or a category.

## Remove a Category or Icon

1. Right-click the category or icon on the Dock and click **Delete shortcut** or **Delete category**.
2. Follow the instructions on the screen.

## Personalize the Dock

1. Right-click the Dock and click **Advanced Setting...**
2. Choose the desired option to personalize the Dock.

# Solving Problems

This section provides troubleshooting information for your computer. If you cannot solve your problem using the following guidelines, see “Using Support Tools” on page 34 or “Contacting Dell” on page 55.

## Beep Codes

Your computer might emit a series of beeps during start-up if there are errors or problems. This series of beeps, called a beep code, identifies a problem. Write down the beep code and contact Dell (see “Contacting Dell” on page 55).

Beep Code	Possible Problem
One	Possible motherboard failure - BIOS ROM checksum failure
Two	No RAM detected <b>NOTE:</b> If you installed or replaced the memory module, ensure that the memory module is seated properly.
Three	Possible motherboard failure - Chipset error
Four	RAM read/write failure
Five	Real Time Clock failure
Six	Video card or chip failure
Seven	Processor failure

# Network Problems

## Wireless Connections

**If the network connection is lost** — The wireless router is offline or wireless has been disabled on the computer.

- Check your wireless router to ensure it is powered on and connected to your data source (cable modem or network hub).
- Re-establish your connection to the wireless router (see “Setting Up a Wireless Connection” on page 14).

## Wired Connections

**If the network connection is lost** —

- Check the cable to ensure it is plugged in and not damaged.
- Check the status of the link integrity light.

The link integrity light on the integrated network connector lets you verify that your connection is working and provides information on the status:

- Off — The computer is not detecting a physical connection to the network.
- Solid green — A good connection exists between a 10/100-Mbps network and the computer.
- Solid orange — A good connection exists between a 1000-Mbps network and the computer.



**NOTE:** The link integrity light on the network connector is only for the wired cable connection. The link integrity light does not provide status for wireless connections.

If the problem persists, contact your network administrator.

## Power Problems

**If the power light is off** — The computer is in hibernate mode, turned off, or is not receiving power.

- Press the power button to resume normal operation.
- Reseat the power cable into both the power connector on the computer and the electrical outlet.
- If the computer is plugged into a power strip, ensure that the power strip is plugged into an electrical outlet and that the power strip is turned on. Also bypass power protection devices, power strips, and power extension cables to verify that the computer turns on properly.

- Ensure that the electrical outlet is working by testing it with another device, such as a lamp.
- Ensure that the power supply light on the back of the computer is on. If the light is off there may be a possible problem with the power supply or the power cable.
- If the problem persists, contact Dell (see “Contacting Dell” on page 55).

**If the power light is solid white and the computer is not responding** — The display may not be connected or powered on.

- Ensure that the display is properly connected and then turn it off, then back on.
- If the problem persists, contact Dell (see “Contacting Dell” on page 55).

## Solving Problems

### **If the power light is solid amber** —

- The computer is in sleep or standby state. Press a key on the keyboard, move the connected mouse, or press the power button to resume normal operation.
- There may be a problem with either the system board or the power supply. For assistance, contact Dell (see “Contacting Dell” on page 55).

**If the power light is blinking amber** — There may be a problem with the system board.

For assistance, contact Dell (see “Contacting Dell” on page 55).

**If you encounter interference that hinders reception on your computer** — An unwanted signal is creating interference by interrupting or blocking other signals. Some possible causes of interference are:

- Power, keyboard, and mouse extension cables.
- Too many devices connected to a power strip.
- Multiple power strips connected to the same electrical outlet.



## Memory Problems

### If you receive an insufficient memory message —

- Save and close any open files and exit any open programs you are not using to see if that resolves the problem.
- See the software documentation for minimum memory requirements. If necessary, install additional memory (see the *Service Manual* at [support.dell.com/manuals](http://support.dell.com/manuals)).
- Reseat the memory module(s) into the connector(s) (see the *Service Manual* at [support.dell.com/manuals](http://support.dell.com/manuals)).
- If the problem persists, contact Dell (see “Contacting Dell” on page 55).

### If you experience other memory problems —

- Ensure that you are following the memory installation guidelines (see the *Service Manual* at [support.dell.com/manuals](http://support.dell.com/manuals)).
- Check if the memory module is compatible with your computer. Your computer supports DDR3 memory. For more information about the type of memory supported by your computer, see “Basic Specifications” on page 58.
- Run the Dell Diagnostics (see “Dell Diagnostics” on page 37).
- If the problem persists, contact Dell (see “Contacting Dell” on page 55).

## Lockups and Software Problems

**If the computer does not start up** — Ensure that the power cable is firmly connected to the computer and to the electrical outlet.

**If a program stops responding** — End the program:

1. Press <Ctrl><Shift><Esc> simultaneously.
2. Click **Applications**.
3. Select the program that is no longer responding
4. Click **End Task**.

**If a program crashes repeatedly** — Check the software documentation. If necessary, uninstall and then reinstall the program.

 **NOTE:** Software usually includes installation instructions in its documentation or on CD.

**If the computer stops responding or a solid blue screen appears** —

 **CAUTION:** You might lose data if you are unable to perform an operating system shutdown.

If you are unable to get a response by pressing a key on your keyboard or moving your mouse, press and hold the power button for at least 8 to 10 seconds until the computer turns off. Then restart your computer.

**If a program is designed for an earlier Microsoft® Windows® operating system** — Run the Program Compatibility Wizard. The Program Compatibility Wizard configures a program so that it runs in an environment similar to an earlier version of Microsoft® Windows® operating system environments.

*Windows Vista*

1. Click **Start**  → **Control Panel** → **Programs** → **Use an older program with this version of Windows**.
2. In the welcome screen, click **Next**.
3. Follow the instructions on the screen.

*Windows 7*

1. Click **Start** .
2. In the search box, type `Use an older program with this version of Windows` and press <Enter>.
3. Follow the instructions on the **Program Compatibility** wizard.

**If you have other software problems —**

- Back up your files immediately.
  - Use a virus-scanning program to check the hard drive or CDs.
  - Save and close any open files or programs and shut down your computer through the **Start**  menu.
- Check the software documentation or contact the software manufacturer for troubleshooting information:
    - Ensure that the program is compatible with the operating system installed on your computer.
    - Ensure that your computer meets the minimum hardware requirements needed to run the software. See the software documentation for information.
    - Ensure that the program is installed and configured properly.
    - Verify that the device drivers do not conflict with the program.
    - If necessary, uninstall and then reinstall the program.

# Using Support Tools

## Dell Support Center

The Dell Support Center helps you find the service, support, and system-specific information you need.

To launch the application, click the  icon in the taskbar.

The **Dell Support Center** home page displays your computer's model number, service tag, express service code, and service contact information.

The home page also provides links to access:

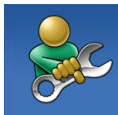

**Self Help** (Troubleshooting, Security, System Performance, Network/Internet, Backup/Recovery, and Windows operating system)



**Alerts** (technical support alerts relevant to your computer)



**Assistance from Dell** (Technical Support with DellConnect™, Customer Service, Training and Tutorials, How-To Help with Dell on Call™, and Online Scan with PC CheckUp)



**About Your System** (System Documentation, Warranty Information, System Information, Upgrades & Accessories)

For more information about **Dell Support Center** and available support tools, click the **Services** tab on [support.dell.com](http://support.dell.com).

## System Messages

If your computer has an issue or error, it may display a system message that will help you identify the cause and action needed to resolve the issue.

 **NOTE:** If the message you received is not listed in the following examples, see the documentation for either the operating system or the program that was running when the message appeared.

**Alert! Previous attempts at booting this system have failed at checkpoint [nnnn]. For help in resolving this problem, please note this checkpoint and contact Dell Technical Support** — The computer failed to complete the boot routine three consecutive times for the same error. Contact Dell for assistance (see “Contacting Dell” on page 55).

**Alert! Previous attempts at booting this system have failed at checkpoint [nnnn]. For help in resolving this problem, please note this checkpoint and contact Dell Technical Support** — The computer failed to complete the boot routine three consecutive times for the same error. Contact Dell for assistance (see “Contacting Dell” on page 55).

**CMOS checksum error** — Possible motherboard failure or coin-cell battery low. Battery needs replacement. See the *Service Manual* at [support.dell.com/manuals](http://support.dell.com/manuals) or contact Dell for assistance (see “Contacting Dell” on page 55).

**CPU fan failure** — CPU fan has failed. CPU fan needs replacement. See the *Service Manual* at [support.dell.com/manuals](http://support.dell.com/manuals).

**System fan failure** — System fan has failed. System fan needs replacement. See the *Service Manual* at [support.dell.com/manuals](http://support.dell.com/manuals).

**Hard-disk drive failure** — Possible hard-disk drive failure during HDD POST. Contact Dell for assistance (see “Contacting Dell” on page 55).

**Hard-disk drive read failure** — Possible hard-disk drive failure during HDD boot test. Contact Dell for assistance (see “Contacting Dell” on page 55).

**Keyboard failure** — Replace keyboard or check the cable for loose connection.

## Using Support Tools

**No boot device available** — No bootable partition on hard drive, the hard drive cable is loose, or no bootable device exists.

- If the hard drive is your boot device, ensure that the cables are connected and that the drive is installed properly and partitioned as a boot device.
- Enter system setup and ensure that the boot sequence information is correct. See the *Service Manual* at [support.dell.com/manuals](http://support.dell.com/manuals).

**No timer tick interrupt** — A chip on the system board might be malfunctioning or there might be a system board failure. See the *Service Manual* at [support.dell.com/manuals](http://support.dell.com/manuals) or contact Dell for assistance (see “Contacting Dell” on page 55).

**USB over current error** — Disconnect the USB device. Your USB device needs more power for it to function properly. Use an external power source to connect the USB device, or if your device has two USB cables, connect both of them.

**NOTICE - Hard Drive SELF MONITORING SYSTEM has reported that a parameter has exceeded its normal operating range. Dell recommends that you back up your data regularly. A parameter out of range may or may not indicate a potential hard drive problem** — S.M.A.R.T error, possible hard disk drive failure. Contact Dell for assistance (see “Contacting Dell” on page 55).

## Hardware Troubleshooter

If a device is either not detected during the operating system setup or is detected but incorrectly configured, you can use the **Hardware Troubleshooter** to resolve the incompatibility.

To start the Hardware Troubleshooter:

1. Click **Start**  → **Help and Support**.
2. Type `hardware troubleshooter` in the search field and press <Enter> to start the search.
3. In the search results, select the option that best describes the problem and follow the remaining troubleshooting steps.

## Dell Diagnostics

If you experience a problem with your computer, perform the checks in “Lockups and Software Problems” on page 32 and run the Dell Diagnostics before you contact Dell for technical assistance.

It is recommended that you print these procedures before you begin.

 **NOTE:** Dell Diagnostics works only on Dell computers.

 **NOTE:** The *Drivers and Utilities* disc is optional and may not ship with your computer.

Ensure that the device that you want to test displays in the system setup program and is active. Press <F2> during POST (Power On Self Test) to enter the System Setup (BIOS) utility.

Start the Dell Diagnostics from your hard drive or from the *Drivers and Utilities* disc.

### Starting Dell Diagnostics From Your Hard Drive

The Dell Diagnostics is located on a hidden diagnostic utility partition on your hard drive.

 **NOTE:** If your computer cannot display a screen image, contact Dell (see “Contacting Dell” on page 55).

1. Ensure that the computer is connected to an electrical outlet that is known to be working properly.
2. Turn on (or restart) your computer.
3. When the DELL™ logo appears, press <F12> immediately. Select **Diagnostics** from the boot menu and press <Enter>. This may invoke the Pre-Boot System Assessment (PSA) on your computer.

 **NOTE:** If you wait too long and the operating system logo appears, continue to wait until you see the Microsoft® Windows® desktop; then, shut down your computer and try again.

 **NOTE:** If you see a message stating that no diagnostic utility partition has been found, run the Dell Diagnostics from the *Drivers and Utilities* disc.

*If PSA is invoked:*

- a. The PSA will start running the tests.
- b. If the PSA completes successfully, the following message is displayed: `“No problems have been found with this system so far. Do you want to run the remaining memory tests? This will take about 30 minutes or more. Do you want to continue? (Recommended).”`



- c. If you are experiencing memory issues press <y>, otherwise press <n>. The following message is displayed:  
"Booting Dell Diagnostic Utility Partition. Press any key to continue."
- d. Press any key to go to the **Choose An Option** window.

*If PSA is not invoked:*

Press any key to start the Dell Diagnostics from the diagnostics utility partition on your hard drive and go to the **Choose An Option** window.

4. Select the test you want to run.
5. If you encounter a problem during a test, a message with the error code and a description of the problem will appear on your screen. Write down the error code and problem description and contact Dell (see "Contacting Dell" on page 55).

 **NOTE:** The Service Tag for your computer is displayed at the top of each test screen. The Service Tag helps you identify your computer when you contact Dell.



6. When the tests complete, close the test screen to return to the **Choose An Option** window.
7. To exit the Dell Diagnostics and restart the computer, click **Exit**.

## Starting Dell Diagnostics From the Drivers and Utilities Disc

1. Insert the *Drivers and Utilities* disc.
2. Shut down and restart the computer. When the DELL logo appears, press <F12> immediately.

 **NOTE:** If you wait too long and the operating system logo appears, continue to wait until you see the Microsoft® Windows® desktop; then, shut down your computer and try again.

## Using Support Tools

-  **NOTE:** The next steps change the boot sequence for one time only. On the next start-up, the computer boots according to the devices specified in the system setup program.
- When the boot device list appears, highlight **CD/DVD/CD-RW** and press <Enter>.
  - Select the **Boot from CD-ROM** option from the menu that appears and press <Enter>.
  - Type **1** to start the CD menu and press <Enter> to proceed.
  - Select **Run the 32 Bit Dell Diagnostics** from the numbered list. If multiple versions are listed, select the version appropriate for your computer.
  - Select the test you want to run.
- If you encounter a problem during a test, a message with the error code and a description of the problem will appear on your screen. Write down the error code and problem description and contact Dell (see “Contacting Dell” on page 55).
-  **NOTE:** The Service Tag for your computer is displayed at the top of each test screen. The Service Tag helps you identify your computer when you contact Dell.
- When the tests complete, close the test screen to return to the **Choose An Option** window. To exit the Dell Diagnostics and restart the computer, click **Exit**.
  - To exit the Dell Diagnostics and to restart the computer, click **Exit**.
  - Remove the *Drivers and Utilities* disc.

# Restoring Your Operating System

You can restore your operating system in the following ways:

- System Restore returns your computer to an earlier operating state without affecting data files. Use System Restore as the first solution for restoring your operating system and preserving data files.
- Dell DataSafe Local Backup restores your hard drive to the operating state it was in when you purchased your computer, without erasing the data files. Use this option if System Restore did not resolve your problem.
- Dell Factory Image Restore returns your hard drive to the operating state it was in when you purchased the computer. This procedure permanently deletes all data on the hard drive and removes any programs installed after you received the computer. Use Dell Factory Image Restore only if System Restore did not resolve your operating system problem.
- If you received an Operating System disc with your computer, you can use it to restore your operating system. However, using the Operating System disc also deletes all data on the hard drive. Use the disc only if System Restore did not resolve your operating system problem.

# System Restore

The Microsoft® Windows® operating systems provide a System Restore option which allows you to restore your computer to an earlier operating state (without affecting data files) if changes to the hardware, software, or other system settings have left the computer in an undesirable operating state. Any changes that System Restore makes to your computer are completely reversible.

 **CAUTION: Make regular backups of your data files. System Restore does not monitor your data files or recover them.**

 **NOTE:** The procedures in this document are applicable for the Windows default view, so they may not apply if you set your Dell™ computer to the Windows Classic view.

## Starting System Restore

1. Click **Start** .
2. In the **Start Search** box, type `System Restore` and press <Enter>.

 **NOTE:** The **User Account Control** window may appear. If you are an administrator on the computer, click **Continue**; otherwise, contact your administrator to continue the desired action.

3. Click **Next** and follow the instructions on the screen.

In the event that System Restore did not resolve the issue, you may undo the last system restore.

## Undoing the Last System Restore

 **NOTE:** Before you undo the last system restore, save and close all open files, and exit any open programs. Do not alter, open, or delete any files or programs until the system restoration is complete.

1. Click **Start** .
2. In the **Start Search** box, type `System Restore` and press <Enter>.
3. Click **Undo my last restoration** and click **Next**.
4. Follow the instructions on the remaining screens.

## Dell DataSafe Local Backup

 **NOTE:** Dell DataSafe Local Backup may not be available in all regions.

Dell DataSafe Local Backup is a backup and recovery application that can restore your computer if you lose data due to a virus attack, accidentally delete critical files or folders, or if the hard drive crashes.

This application allows you to:

- Restore files and folders
- Restore your hard drive to the operating state it was in when you purchased your computer, without erasing the existing personal files and data

## Restoring Your Operating System

To schedule backups:

1. Double-click the Dell DataSafe Local icon  on the taskbar.
2. Choose **Full System Backup** to create and schedule automatic backup of all the data in your computer.

To restore data:

1. Turn off your computer.
  2. Remove any recently added internal hardware and disconnect devices such as a USB drive, printer, and so on.
-  **NOTE:** Do not disconnect the display, keyboard, mouse, and the power cable.
3. Turn on your computer.
  4. When the Dell logo appears, press <F8> several times to access the **Advanced Boot Options** window.

 **NOTE:** If you wait too long and the operating system logo appears, continue to wait until you see the Microsoft® Windows® desktop; then, shut down your computer and try again.

5. Select **Repair Your Computer**.

6. Select **Dell Factory Image Recovery and DataSafe Options** and follow the instructions on the screen.

 **NOTE:** The duration of the restoration process depends on the amount of data to be restored.

 **NOTE:** For more information, see the knowledge base article 353560 at [support.dell.com](http://support.dell.com).

## Dell Factory Image Restore

 **CAUTION:** Using Dell Factory Image Restore permanently deletes all data on the hard drive and removes any programs or drivers installed after you received your computer. If possible, back up the data before using this option. Use Dell Factory Image Restore only if System Restore did not resolve your operating system problem.

 **NOTE:** Dell Factory Image Restore may not be available in certain countries or on certain computers.

Use Dell Factory Image Restore only as the last method to restore your operating system. These options restore your hard drive to the operating state it was in when you purchased the computer. Any programs or files added since you received your computer—including data files—are permanently deleted from the hard drive. Data files include documents, spreadsheets, e-mail messages, digital photos, music files, and so on. If possible, back up all data before using Factory Image Restore.

### Performing Dell Factory Image Restore

1. Turn on the computer. When the Dell logo appears, press <F8> several times to access the **Advanced Boot Options** Window.

 **NOTE:** If you wait too long and the operating system logo appears, continue to wait until you see the Microsoft® Windows® desktop; then, shut down your computer and try again.

2. Select **Repair Your Computer**.

The **System Recovery Options** window appears.

3. Select a keyboard layout and click **Next**.

4. To access the recovery options, log on as a local user. To access the command prompt, type `administrator` in the **User name** field, then click **OK**.

5. Click **Dell Factory Image Restore**. The **Dell Factory Image Restore** welcome screen appears.

 **NOTE:** Depending upon your configuration, you may need to select **Dell Factory Tools**, then **Dell Factory Image Restore**.

6. Click **Next**. The **Confirm Data Deletion** screen appears.

 **NOTE:** If you do not want to proceed with Factory Image Restore, click **Cancel**.

7. Click the check box to confirm that you want to continue reformatting the hard drive and restoring the system software to the factory condition, then click **Next**.

The restore process begins and may take five or more minutes to complete. A message appears when the operating system and factory-installed applications have been restored to factory condition.

8. Click **Finish** to restart the computer.



# Operating System Reinstallation

## Before You Begin

If you are considering reinstalling the Microsoft® Windows® operating system to correct a problem with a newly installed driver, first try using Windows Device Driver Rollback.

To roll back a device driver:

1. Click **Start** .
2. Right-click **Computer**.
3. Click **Properties**→ **Device Manager**.
4. Right-click the device for which the new driver was installed, and click **Properties**.
5. Click the **Drivers** tab→ **Roll Back Driver**.

If Device Driver Rollback does not resolve the problem, then use System Restore to return your operating system to the operating state it was in before you installed the new device driver. See “System Restore” on page 42.

 **CAUTION:** Before performing the installation, back up all data files on your primary hard drive. For conventional hard drive configurations, the primary hard drive is the first drive detected by the computer.

To reinstall Windows, you need the following items:

- Dell *Operating System* disc
- Dell *Drivers and Utilities* disc

 **NOTE:** The Dell *Drivers and Utilities* disc contains drivers that were installed during the assembly of the computer. Use the Dell *Drivers and Utilities* disc to load any required drivers. Depending on the region from which you ordered your computer, or whether you requested the disc, the Dell *Drivers and Utilities* disc and *Operating System* disc may not ship with your computer.

### Reinstalling Microsoft® Windows®

The reinstallation process can take 1 to 2 hours to complete. After you reinstall the operating system, you must also reinstall the device drivers, virus protection program, and other software.

1. Save and close any open files and exit any open programs.
2. Insert the *Operating System* disc.
3. Click **Exit** if the **Install Windows** message appears.
4. Restart the computer.
5. When the DELL logo appears, press <F12> immediately.

 **NOTE:** If you wait too long and the operating system logo appears, continue to wait until you see the Microsoft® Windows® desktop; then, shut down your computer and try again.

 **NOTE:** The next steps change the boot sequence for one time only. On the next start-up, the computer boots according to the devices specified in the system setup program.

6. When the boot device list appears, highlight **CD/DVD/CD-RW Drive** and press <Enter>.
7. Press any key to **Boot from CD-ROM**. Follow the instructions on the screen to complete the installation.
8. Reinstall the device drivers, virus protection program, and other softwares, as needed

# Getting Help

If you experience a problem with your computer, you can complete the following steps to diagnose and troubleshoot the problem:

1. See “Solving Problems” on page 27 for information and procedures that pertain to the problem your computer is experiencing.
2. See “Dell Diagnostics” on page 37 for procedures on how to run Dell Diagnostics.
3. Fill out the “Diagnostic Checklist” on page 54.
4. Use Dell’s extensive suite of online services available at **support.dell.com** for help with installation and troubleshooting procedures. See “Online Services” on page 51 for a more extensive list of Dell Support online.
5. If the preceding steps have not resolved the problem, see “Contacting Dell” on page 55.

 **NOTE:** Call Dell Support from a telephone near or at the computer so that the support staff can assist you with any necessary procedures.

 **NOTE:** Dell’s Express Service Code system may not be available in all countries.

When prompted by Dell’s automated telephone system, enter your Express Service Code to route the call directly to the proper support personnel. If you do not have an Express Service Code, open the **Dell Accessories** folder, double-click the **Express Service Code** icon, and follow the directions.

 **NOTE:** Some of the following services are not always available in all locations outside the continental U.S. Call your local Dell representative for information on availability.

## Technical Support and Customer Service

Dell's support service is available to answer your questions about Dell hardware. Our support staff uses computer-based diagnostics to provide fast, accurate answers.

To contact Dell's support service, see "Before You Call" on page 54 and then see the contact information for your region or go to **[support.dell.com](http://support.dell.com)**.

## DellConnect

DellConnect™ is a simple online access tool that allows a Dell service and support associate to access your computer through a broadband connection, diagnose your problem, and repair it all under your supervision. For more information, go to **[support.dell.com/dellconnect](http://support.dell.com/dellconnect)**.

## Online Services

You can learn about Dell products and services on the following websites:

- [www.dell.com](http://www.dell.com)
- [www.dell.com/ap](http://www.dell.com/ap) (Asian/Pacific countries only)
- [www.dell.com/jp](http://www.dell.com/jp) (Japan only)
- [www.euro.dell.com](http://www.euro.dell.com) (Europe only)
- [www.dell.com/la](http://www.dell.com/la) (Latin American and Caribbean countries)
- [www.dell.ca](http://www.dell.ca) (Canada only)

You can access Dell Support through the following websites and e-mail addresses:

### Dell Support websites

- [support.dell.com](mailto:support.dell.com)
- [support.jp.dell.com](mailto:support.jp.dell.com) (Japan only)
- [support.euro.dell.com](mailto:support.euro.dell.com) (Europe only)

### Dell Support e-mail addresses

- [mobile\\_support@us.dell.com](mailto:mobile_support@us.dell.com)
- [support@us.dell.com](mailto:support@us.dell.com)
- [la-techsupport@dell.com](mailto:la-techsupport@dell.com) (Latin America and Caribbean countries only)
- [apsupport@dell.com](mailto:apsupport@dell.com) (Asian/Pacific countries only)

### Dell Marketing and Sales e-mail addresses

- [apmarketing@dell.com](mailto:apmarketing@dell.com) (Asian/Pacific countries only)
- [sales\\_canada@dell.com](mailto:sales_canada@dell.com) (Canada only)

### Anonymous file transfer protocol (FTP)

- [ftp.dell.com](ftp://ftp.dell.com)

Log in as user: `anonymous`, and use your e-mail address as your password.

### Automated Order-Status Service

To check on the status of any Dell products that you have ordered, you can go to **support.dell.com**, or you can call the automated order-status service. A recording prompts you for the information needed to locate and report on your order. For the telephone number to call your region, see “Contacting Dell” on page 55.

If you have a problem with your order, such as missing parts, wrong parts, or incorrect billing, contact Dell for customer assistance. Have your invoice or packing slip handy when you call. For the telephone number to call for your region, see “Contacting Dell” on page 55.

### Product Information

If you need information about additional products available from Dell, or if you would like to place an order, visit **www.dell.com**. For the telephone number to call for your region or to speak to a sales specialist, see “Contacting Dell” on page 55.

## Returning Items for Repair Under Warranty or for Credit

Prepare all items being returned, whether for repair or credit, as follows:

-  **NOTE:** Before you return the product to Dell, make sure to back up any data on the hard drive and on any other storage device in the product. Remove any and all confidential, proprietary and personal information, as well as removable media, such as CDs and PC Cards. Dell is not responsible for any of your confidential, proprietary or personal information; lost or corrupted data; or damaged or lost removable media that may be included with your return.
1. Call Dell to obtain a Return Material Authorization Number, and write it clearly and prominently on the outside of the box. For the telephone number to call your region, see “Contacting Dell” on page 55.

2. Include a copy of the invoice and a letter describing the reason for the return.
3. Include a copy of the Diagnostics Checklist (see “Diagnostic Checklist” on page 54), indicating the tests that you have run and any error messages reported by the Dell Diagnostics (see “Dell Diagnostics” on page 37).
4. Include any accessories that belong with the item(s) being returned (power cables, software, guides, and so on) if the return is for credit.
5. Pack the equipment to be returned in the original (or equivalent) packing materials.

 **NOTE:** You are responsible for paying shipping expenses. You are also responsible for insuring any product returned, and you assume the risk of loss during shipment to Dell. Collect On Delivery (C.O.D.) packages are not accepted.

 **NOTE:** Returns that are missing any of the preceding requirements will be refused at Dell’s receiving dock and returned to you.

## Before You Call

 **NOTE:** Have your Express Service Code ready when you call. The code helps Dell's automated-support telephone system direct your call more efficiently. You may also be asked for your Service Tag.

Remember to fill out the following Diagnostic Checklist. If possible, turn on your computer before you call Dell for assistance and call from a telephone at or near the computer. You may be asked to type some commands at the keyboard, relay detailed information during operations, or try other troubleshooting steps possible only at the computer itself. Ensure that the computer documentation is available.

### Diagnostic Checklist

- Name:
- Date:
- Address:
- Phone number:
- Service Tag and Express Service Code (located on a label on the top of the computer):
- Return Material Authorization Number (if provided by Dell support technician):
- Operating system and version:
- Devices:
- Expansion cards:
- Are you connected to a network? Yes /No
- Network, version, and network adapter:
- Programs and versions:



See your operating system documentation to determine the contents of the computer's start-up files. If the computer is connected to a printer, print each file. Otherwise, record the contents of each file before calling Dell.

- Error message, beep code, or diagnostic code:
- Description of problem and troubleshooting procedures you performed:

## Contacting Dell

For customers in the United States, call 800-WWW-DELL (800-999-3355).

 **NOTE:** If you do not have an active Internet connection, you can find contact information on your purchase invoice, packing slip, bill, or Dell product catalog.

Dell provides several online and telephone-based support and service options. Availability varies by country and product, and some services may not be available in your area.

To contact Dell for sales, technical support, or customer service issues:

1. Visit **[www.dell.com/contactdell](http://www.dell.com/contactdell)**.
2. Select your country or region.
3. Select the appropriate service or support link based on your need.
4. Choose the method of contacting Dell that is convenient for you.

# Finding More Information and Resources

## If you need to:

reinstall your operating system

find your system model number

run a diagnostic program for your computer, reinstall desktop system software, or update drivers for your computer, and readme files

learn more about your operating system, maintaining peripherals, RAID, Internet, Bluetooth<sup>®</sup>, networking, and e-mail

upgrade your computer with new or additional components, like a new hard drive

reinstall or replace a worn or defective part

## See:

the *Operating System* disc

the back of your computer

the *Drivers and Utilities* disc



**NOTE:** Drivers and documentation updates can be found at **support.dell.com**.

the *Dell Technology Guide* available on your hard drive or at **support.dell.com/manuals**

the *Service Manual* at **support.dell.com/manuals**



**NOTE:** In some countries, opening and replacing parts of your computer may void your warranty. Check your warranty and return policies before working inside your computer.

### If you need to:

find safety best practices information for your computer, review Warranty information, Terms and Conditions (U.S. only), Safety instructions, Regulatory information, Ergonomics information, and End User License Agreement

find your Service Tag/Express Service Code — You must use the Service Tag to identify your computer on **support.dell.com** or to contact technical support

find drivers and downloads

access technical support and product help

check on your order status for new purchases

find solutions and answers to common questions

locate information for last-minute updates about technical changes to your computer or advanced technical-reference material for technicians or experienced users

### See:

the safety information that is shipped with your computer, before working inside your computer. For additional safety best practices information, see the Regulatory Compliance Homepage at **www.dell.com/regulatory\_compliance**.



the top of the computer

the **Dell Support Center**. To launch the **Dell Support Center**, click the  icon in the taskbar.

**support.dell.com**

# Basic Specifications

This section provides information that you may need when setting up, updating drivers for, and upgrading your computer. For more detailed specifications, see the *Comprehensive Specifications* at [support.dell.com/manuals](http://support.dell.com/manuals).

 **NOTE:** Offerings may vary by region. For more information regarding the configuration of your computer, click **Start**  → **Help and Support** and select the option to view information about your computer.

## Computer Model

---

Dell™ Inspiron™ 580s

## Processor Types

---

Intel® Pentium®

Intel® Core™ i3

Intel Core i5

## Drives

---

Externally  
accessible

one 5.25-inch bay for SATA  
DVD-ROM, SATA DVD+/-  
RW Super Multi Drive, or  
Blu-ray Disc™ combo drive

one 3.5-inch FlexBay

Internally  
accessible

two 3.5-inch bays for SATA  
hard drives

## Computer Information

---

System chipset Intel H57

## Memory

---

Connectors four internally-accessible DIMM sockets

Capacities 1 GB, 2 GB, and 4 GB

Memory type DDR3 DIMM; non-ECC memory only

Minimum 1 GB

Maximum 8 GB

 **NOTE:** For instructions on upgrading memory, see the *Service Manual* at [support.dell.com/manuals](http://support.dell.com/manuals).

## Video

---

Integrated Intel GMA HD

Discrete PCI Express x16 card (optional)

## Audio

---

Type integrated 7.1 channel, High Definition Audio

## Physical

---

Height 377.9 mm (14.88 inches)

Width 106 mm (4.16 inches)

Depth 431.3 mm (16.98 inches)

Weight (starting at) 7.3 kg (16.1 lb)

## Basic Specifications

### External Connectors

---

Network adapter	one RJ45 connector
USB	two front-panel and four back-panel USB 2.0-compliant connectors
Audio	front panel — headphone and microphone connectors back panel — six connectors for 7.1 channel support
Video	one 15-hole VGA connector and one 19-pin HDMI connector

### Communication

---

Wireless (optional)	PCI Express WiFi card supporting 802.11a/b/g/n
Modem (optional)	PCI modem

### Power

---

Wattage	250 W
Voltage	115/230 VAC
Coin-cell battery	CR2032 lithium

## Computer Environment

---

Temperature ranges:

Operating 10°C to 35°C (50°F to 95°F)

Storage -40°C to 65°C (-40°F to 149°F)

Relative humidity (maximum): 20% to 80% (non-condensing)

Maximum vibration (using a random-vibration spectrum that simulates user environment):

Operating 0.25 GRMS

Non-Operating 2.2 GRMS

Operating

## Computer Environment

---

Maximum shock (measured with hard drive in head-parked position and a 2-ms half-sine pulse):

Operating 40G for 2 ms with a change in velocity of 20 in/s (51 cm/s)

Non-Operating 50G for 26 ms with a change in velocity of 320 in/s (813 cm/s)

Altitude (maximum):

Operating -15.2 to 3048 m (-50 to 10,000 ft)

Storage -15.2 to 10,668 m (-50 to 35,000 ft)

Airborne contaminant level G2 or lower as defined by ISA-S71.04-1985

# Appendix

## Macrovision Product Notice

This product incorporates copyright protection technology that is protected by method claims of certain U.S. patents and other intellectual property rights owned by Macrovision Corporation and other rights owners. Use of this copyright protection technology must be authorized by Macrovision Corporation, and is intended for home and other limited viewing uses only unless otherwise authorized by Macrovision Corporation. Reverse engineering or disassembly is prohibited.



## Information for NOM, or Official Mexican Standard (Only for Mexico)

The following information is provided in the device(s) described in this document in accordance with the requirements of the Official Mexican Standard (NOM):

**Importer:**

Dell México S.A. de C.V.

Paseo de la Reforma 2620 - 11°

Col. Lomas Altas

11950 México, D.F.

<b>Regulatory Model Number</b>	<b>Voltage</b>	<b>Frequency</b>	<b>Electricity Consumption</b>
DCSLF	115/230 VAC	50/60 Hz	6.0/3.0 A

For details, read the safety information that shipped with your computer.

For additional safety best practices information, see the Regulatory Compliance Homepage at [www.dell.com/regulatory\\_compliance](http://www.dell.com/regulatory_compliance).

# Index

## B

- backups
  - creating **24**

## C

- calling Dell **54**
- CDs, playing and creating **22**
- chipset **59**
- computer capabilities **22**
- connect(ing)
  - optional network cable **10**
- conserving energy **23**
- Contacting Dell online **55**
- customer service **50**

- customizing
  - your desktop **23**
  - your energy settings **23**

## D

- data, backing up **24**
- DataSafe Local Backup **43**
- DellConnect **50**
- Dell DataSafe Online Backup **25**
- Dell Diagnostics **37**
- Dell Dock **26**
- Dell Factory Image Restore **41**
- Dell Technology Guide
  - for further information **56**

Diagnostic Checklist **54**  
drivers and downloads **57**  
DVDs, playing and creating **22**

## E

eject button **16, 17**  
email addresses  
    for technical support **51**  
energy  
    conserving **23**  
Express Service Code **57**

## F

front-view connectors **16**  
FTP login, anonymous **51**

## H

hard drive  
    type **58**

hard drive activity light **17**  
hardware problems  
    diagnosing **37**  
Hardware Troubleshooter **37**  
headphone  
    front connector **17**

## I

Internet connection **13**  
ISP  
    Internet Service Provider **13**

## M

memory problems  
    solving **31**  
memory support **59**

## N

network connection

fixing **28**

network connector

location **21**

## O

order status **52**

## P

power button **16**

power problems, solving **29**

problems, solving **27**

processor **58**

products

information and purchasing **52**

## R

reinstalling Windows **47**

restoring data **44**

restoring factory image **45**

## S

Service Tag **57**

shipping products

for return or repair **53**

software features **22**

software problems **32**

solving problems **27**

specifications **58**

support e-mail addresses **51**

support sites

worldwide **51**

System Messages **35**

System Restore **41**

**T**

technical support **50**

temperature

operating and storage ranges **61**

**U**

USB 2.0

back connectors **21**

front connectors **17**

**W**

warranty returns **53**

Windows

Program Compatibility Wizard **32**

reinstalling **48**

wireless network connection **28**







Printed in the U.S.A.

[www.dell.com](http://www.dell.com) | [support.dell.com](http://support.dell.com)



048WNFA01



## Free Manuals Download Website

<http://myh66.com>

<http://usermanuals.us>

<http://www.somanuals.com>

<http://www.4manuals.cc>

<http://www.manual-lib.com>

<http://www.404manual.com>

<http://www.luxmanual.com>

<http://aubethermostatmanual.com>

Golf course search by state

<http://golfingnear.com>

Email search by domain

<http://emailbydomain.com>

Auto manuals search

<http://auto.somanuals.com>

TV manuals search

<http://tv.somanuals.com>