

ELECTRONIC CASH REGISTER

PCR-T2000

THANK YOU
YOUR RECEIPT
CALL AGAIN !

GROCERY
DAIRY
H. B. A.
FROZEN
FOOD
DELICATESSEN



CI Canada

USER'S MANUAL

CASIO®

Safety Precautions

- To use this product safely and correctly, read this manual thoroughly and operate as instructed.
After reading this guide, keep it close at hand for easy reference.
Please keep all informations for future reference.
- Always observe the warnings and cautions indicated on the product.

About the icons

In this guide various icons are used to highlight safe operation of this product and to prevent injury to the operator and other personnel and also to prevent damage to property and this product. The icons and definitions are given below.



Indicates that there is a risk of severe injury or death if used incorrectly.



Indicates that injury or damage may result if used incorrectly.

Icon examples

To bring attention to risks and possible damage, the following types of icons are used.



The \triangle symbol indicates that it includes some symbol for attracting attention (including warning). In this triangle the actual type of precautions to be taken (electric shock, in this case) is indicated.



The \otimes symbol indicates a prohibited action. In this symbol the actual type of prohibited actions (disassembly, in this case) will be indicated.



The \bullet symbol indicates a restriction. In this symbol the type of actual restriction (removal of the power plug from an outlet, in this case) is indicated.

Warning!

Handling the register



Should the register malfunction, start to emit smoke or a strange odor, or otherwise behave abnormally, immediately shut down the power and unplug the AC plug from the power outlet. Continued use creates the danger of fire and electric shock.

- Contact CASIO service representative.



Do not place containers of liquids near the register and do not allow any foreign matter to get into it. Should water or other foreign matter get into the register, immediately shut down the power and unplug the AC plug from the power outlet. Continued use creates the danger of shorting, fire and electric shock.

- Contact CASIO service representative.



Should you drop the register and damage it, immediately shut down the power and unplug the AC plug from the power outlet. Continued use creates the danger of shorting, fire and electric shock.

- Attempting to repair the register yourself is extremely dangerous. Contact CASIO service representative.
-

Warning!



Never try to take the register apart or modify it in any way. High-voltage components inside the register create the danger of fire and electric shock.

- Contact CASIO service representative for all repair and maintenance.
-

Power plug and AC outlet



Use only a proper AC electric outlet (100V~240V) . Use of an outlet with a different voltage from the rating creates the danger of malfunction, fire, and electric shock. Overloading an electric outlet creates the danger of overheating and fire.



Make sure the power plug is inserted as far as it will go. Loose plugs create the danger of electric shock, overheating, and fire.

- Do not use the register if the plug is damaged. Never connect to a power outlet that is loose.
-



Use a dry cloth to periodically wipe off any dust built up on the prongs of the plug. Humidity can cause poor insulation and create the danger of electric shock and fire if dust stays on the prongs.



Do not allow the power cord or plug to become damaged, and never try to modify them in any way. Continued use of a damaged power cord can cause deterioration of the insulation, exposure of internal wiring, and shorting, which creates the danger of electric shock and fire.

- Contact CASIO service representative whenever the power cord or plug requires repair or maintenance.
-

Caution!



Do not place the register on an unstable or uneven surface. Doing so can cause the register — especially when the drawer is open — to fall, creating the danger of malfunction, fire, and electric shock.

Do not place the register in the following areas.



- Areas where the register will be subject to large amounts of humidity or dust, or directly exposed to hot or cold air.
- Areas exposed to direct sunlight, in a close motor vehicle, or any other area subject to very high temperatures.

The above conditions can cause malfunction, which creates the danger of fire.



Do not overlay bend the power cord, do not allow it to be caught between desks or other furniture, and never place heavy objects on top of the power cord. Doing so can cause shorting or breaking of the power cord, creating the danger of fire and electric shock.



Be sure to grasp the plug when unplugging the power cord from the wall outlet. Pulling on the cord can damage it, break the wiring, or cause short, creating the danger of fire and electric shock.



Never touch the plug while your hands are wet. Doing so creates the danger of electric shock. Pulling on the cord can damage it, break the wiring, or cause short, creating the danger of fire and electric shock.

Never touch the printer head and the platen.

Introduction & Contents

Introduction & Contents	4
Getting Started	7
Remove the cash register from its box.	7
Remove the tape holding parts of the cash register in place.	7
Install the three memory backup batteries.	7
Install receipt/journal paper.	9
Plug the cash register into a wall outlet.	11
Insert the mode key marked "PGM" into the mode switch.	11
Turn the mode key to the "REG" position.	11
Set the date.	12
Set the time.	12
Tax table programming	13
Programming for the U.S. tax tables procedure	13
Programming for Canadian tax tables procedure	14
Introducing PCR-T2000	16
General guide	16
Roll paper, Receipt On/Off key, Mode key, Drawer, Drawer lock	16
Mode switch	17
Lock/unlock the multipurpose tray	18
Displays	19
Keyboard	20
Basic Operations and Setups	22
How to read the printouts	22
How to use your cash register	23
Displaying the time and date	24
Preparing coins for change	24
Preparing and using department keys	25
Registering department keys	25
Programming department keys	27
Registering department keys by programming data	28
Preparing and using PLUs	29
Programming PLUs	29
Registering PLUs	30
Preparing and using discounts/premiums	31
Programming discounts/premiums	31
Registering discounts/premiums	32
Preparing and using reductions	33
Programming for reductions	33
Registering reductions	34
Calculating the merchandise subtotal	35
Registering charge and check payments	36
Registering returned goods in the REG mode	37
Registering returned goods in the RF mode	38
Registering money received on account	39
Registering money paid out	39
Making corrections in a registration	40
No sale registration	42
Printing the daily sales reset report	43
Convenient Operations and Setups	44
Clerk control function	44
Clerk sign on and sign off	44

Post-finalization receipt format, General printing control, Compulsory, Machine features ..	45
About post-finalization receipt	45
Programming general printing control	46
Programming compulsory and clerk control function	47
Programming read/reset report printing control	48
Setting a store/machine number	48
Programming to clerk	49
Programming clerk number	49
Programming trainee status of clerk	49
Programming descriptors and messages	50
Programming report descriptor, grand total, special character, report title, receipt message and clerk name	50
Report descriptor	50
Clerk name, Grand total, special character, Report title	51
Receipt message	52
Programming department key descriptor	52
Programming PLU descriptor	53
Programming function key descriptor	54
Programming receipt message/logo stamp control function	54
Entering characters	55
Using character keyboard	55
Entering characters by code	56
Department key feature programming	57
Batch feature programming	57
Individual feature programming	58
PLU feature programming	59
Batch feature programming	59
Individual feature programming	60
Percent key feature programming	63
Registering manual tax	64
Currency exchange programming	65
Currency exchange rate programming	65
Currency exchange feature programming	65
Other function key feature programming	68
Cash, Charge, Check key	68
Minus key, Received on account, Payout key, #/No sale key, No sale key	69
Calculator functions	70
About the daylight saving time	71
Printing read/reset reports	72
Reading the cash register's program	78
Troubleshooting	81
When an error occurs	81
When the register does not operate at all	82
In case of power failure	83
When the L sign appears on the display	83
User Maintenance and Options	84
To replace journal paper	84
To replace receipt paper	85
Options	85
Specifications	86
Index	87

Unpacking the register

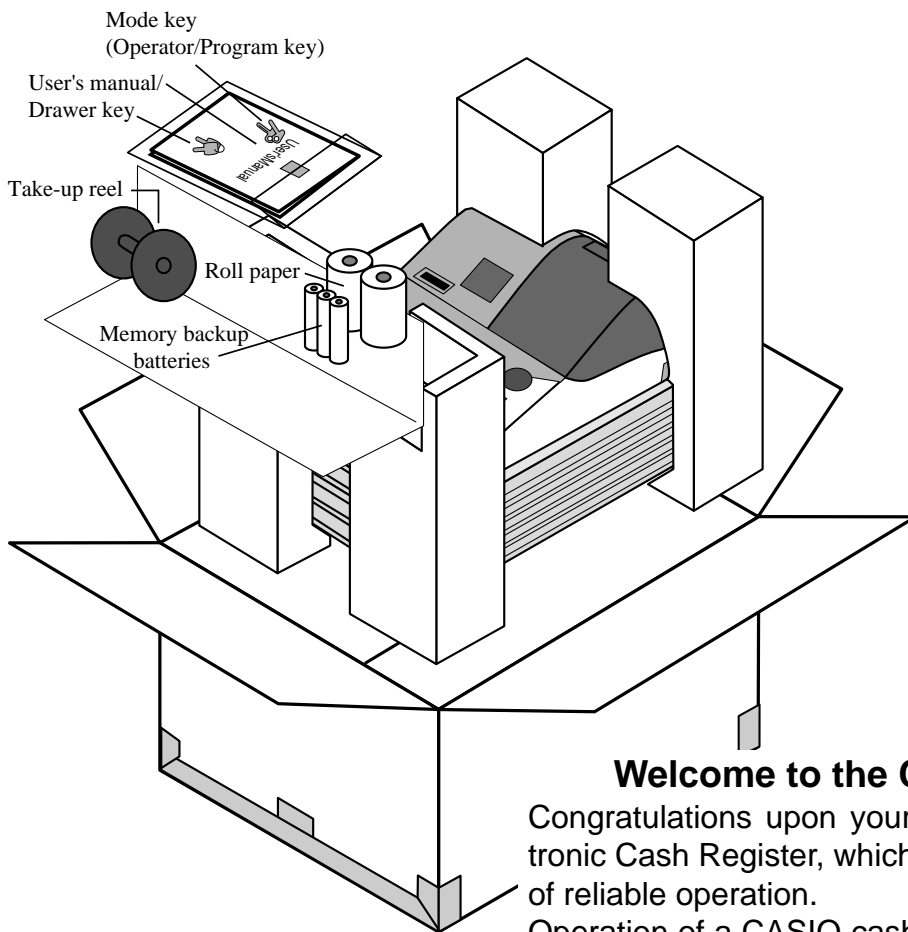

Welcome to the CASIO PCR-T2000!

Congratulations upon your selection of a CASIO Electronic Cash Register, which is designed to provide years of reliable operation.

Operation of a CASIO cash register is simple enough to be mastered without special training. Everything you need to know is included in this manual, so keep it on hand for reference.

Consult your CASIO dealer if you have any questions about points not specifically covered in this manual.

GUIDELINES LAID DOWN BY FCC RULES FOR USE OF THE UNIT IN THE U.S.A. (Not applicable to other areas)

FCC WARNING: This equipment has been tested and found to comply with the limits for a Class A digital device, pursuant to Part 15 of the FCC Rules. These limits are designed to provide reasonable protection against harmful interference when the equipment is operated in a commercial environment. This equipment generates, uses, and can radiate radio frequency energy and, if not installed and used in accordance with the instruction manual, may cause harmful interference to radio communications. Operation of this equipment in a residential area is likely to cause harmful interference in which case the user will be required to correct the interference at his own expense.

WARNING: Changes or modifications not expressly approved by the party responsible for compliance could void the user's authority to operate the equipment.

The main plug on this equipment must be used to disconnect main power.
Please ensure that the socket outlet is installed near the equipment and shall be easily accessible.

Please keep all information for future reference.

Getting Started

This section outlines how to unpack the cash register and get it ready to operate. You should read this part of the manual even if you have used a cash register before. The following is the basic set up procedure, along with page references where you should look for more details.

1. Remove the cash register from its box.

Make sure that all of the parts and accessories are included.

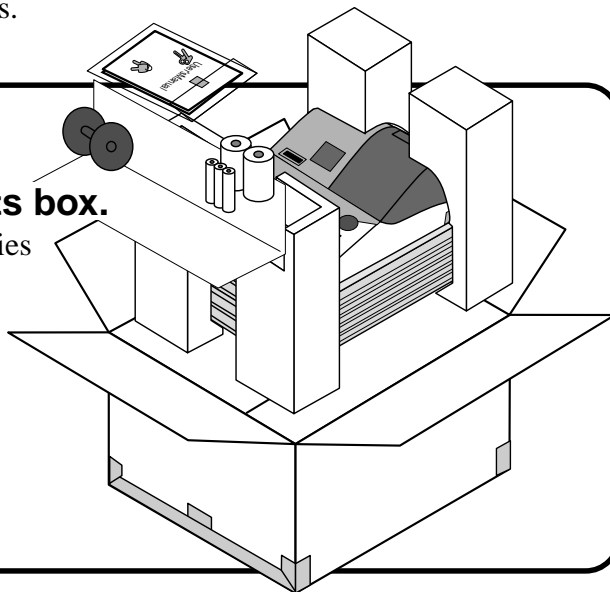

Getting Started

2. Remove the tape holding parts of the cash register in place.

Also remove the small plastic bag taped to the printer cover. Inside you will find the mode keys.

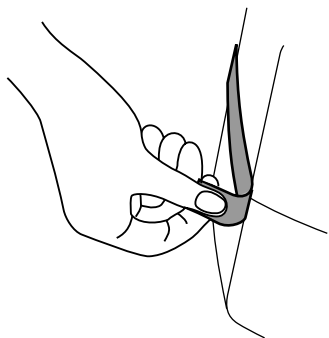

3. Install the three memory backup batteries.



printer cover

1. Remove the printer cover and open the platen arm.



platen arm



battery compartment cover

2. Remove the battery compartment cover. Slide the cover and pull it up.

3. Install the three memory backup batteries. (continued...)



3. Note the (+) and (-) markings in the battery compartment. Load a set of three new SUM-3 (UM-3) batteries so that their positive (+) and negative (-) ends are facing as indicated by the markings.



4. Replace the battery compartment cover.

5. Close the platen arm and replace the printer cover.

Important!

These batteries protect information stored in your cash register's memory when there is a power failure or when you unplug the cash register. Be sure to install these batteries.

Precaution!

Incorrectly using batteries can cause them to burst or leak, possibly damaging the interior of the cash register. Note the following.

- Be sure that the positive (+) and negative (-) ends of the batteries are facing as marked in the battery compartment when you load them into the unit.
- Never mix batteries of different types.
- Never mix old batteries with new ones.
- Never leave dead batteries in the battery compartment.
- Remove the batteries if you do not plan to use the cash register for long periods.
- Replace the batteries at least once every two years, no matter how much the cash register is used during the period.

WARNING!

- Never try to recharge the batteries supplied with the unit.
- Do not expose batteries to direct heat, let them become shorted or try to take them apart.

Keep batteries out of the reach of small children. If your child should swallow a battery, consult a physician immediately.

4. Install receipt/journal paper.

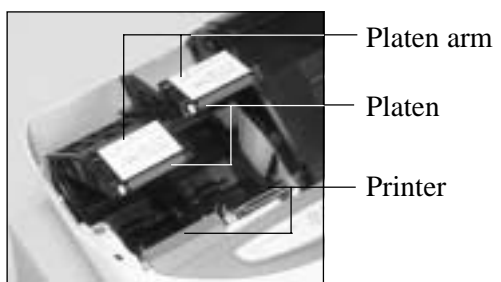

Important!

Take away the head protection sheet from the printer and close the platen arm.

Caution! (in handling the thermal paper)

- Never touch the printer head and the platen.
- Unpack the thermal paper just before your use.
- Avoid heat/direct sunlight.
- Avoid dusty and humid places for storage.
- Do not scratch the paper.
- Do not keep the printed paper under the following circumstances:
High humidity and temperature/direct sunlight/contact with glue, thinner or a rubber eraser.

To install receipt paper



Step 1
Remove the printer cover.



Step 4
Put the leading end of the paper over the printer.



Step 2
Open the platen arm.



Step 5
Close the platen arm slowly until it locks steadily.



Step 3
Ensuring the paper is being fed from the bottom of the roll, lower the roll into the space behind the printer.



Complete
Replace the printer cover, passing the leading end of the paper through the cutter slot. Tear off the excess paper.

To install journal paper



Step 1

Remove the printer cover.



Step 2

Open the platen arm.



Step 7

Slide the leading end of the paper into the groove on the spindle of the take-up reel and wind it onto the reel two or three turns.



Step 3

Ensuring the paper is being fed from the bottom of the roll, lower the roll into the space behind the printer.



Step 8

Replace the paper guide of the take-up reel.



Step 4

Put the leading end of the paper over the printer.



Step 9

Place the take-up reel into place behind the printer, above the roll paper.



Step 5

Close the platen arm slowly until it locks steadily.



Step 10

Press the **JOURNAL FEED** key to take up any slack in the paper.

During machine installation, press the **JOURNAL FEED** key after power on.



Step 6

Remove the paper guide of the take-up reel.



Complete

Replace the printer cover.

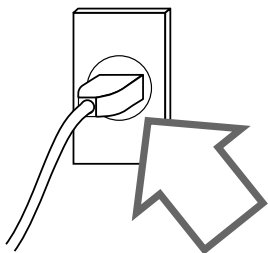

5. Plug the cash register into a wall outlet.

Be sure to check the sticker (rating plate) on the side of the cash register to make sure that its voltage matches that of the power supply in your area.

6. Insert the mode key marked “PGM” into the mode switch.

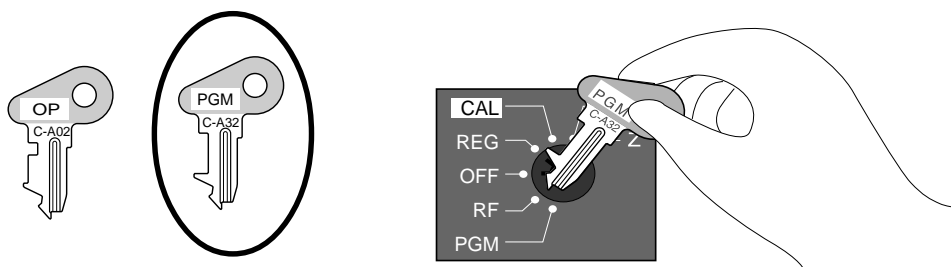

7. Turn the mode key to the “REG” position.

The display should change to the following.

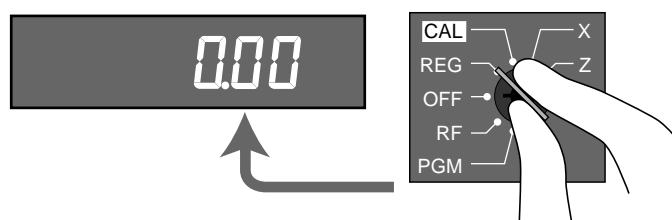

8. Set the date.

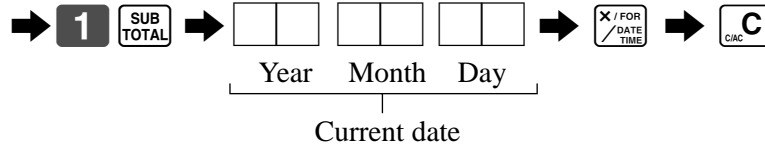
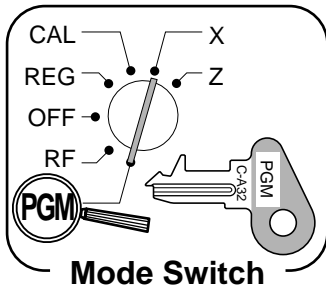

Example:

June 15, 2002 ⇨ 0 2 0 6 1 5

9. Set the time.

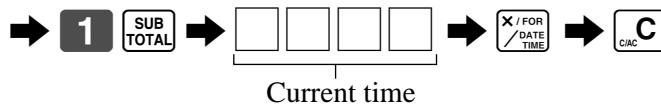
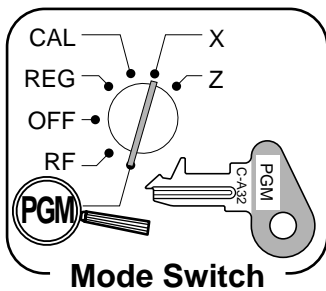

Example:

08:20 AM ⇨ 0 8 2 0

09:45 PM ⇨ 2 1 4 5

10. Tax table programming

Programming automatic tax calculation

Important!

After you program the tax calculations, you also have to individually specify which departments (page 27) and PLUs (page 29) are to be taxed.

For this cash register to be able to automatically register state sales tax, you must program its tax tables with tax calculation data from the tax table for your state. There are three tax tables (U. S.) and four tax tables (Canada) that you can program for automatic calculation of three/four separate sales taxes.

Programming for the U.S. tax tables procedure

The procedure to setup the tax table is printed on the guidance receipt. First issue the guidance receipt by the **HELP** key and follow it to set the tax table.

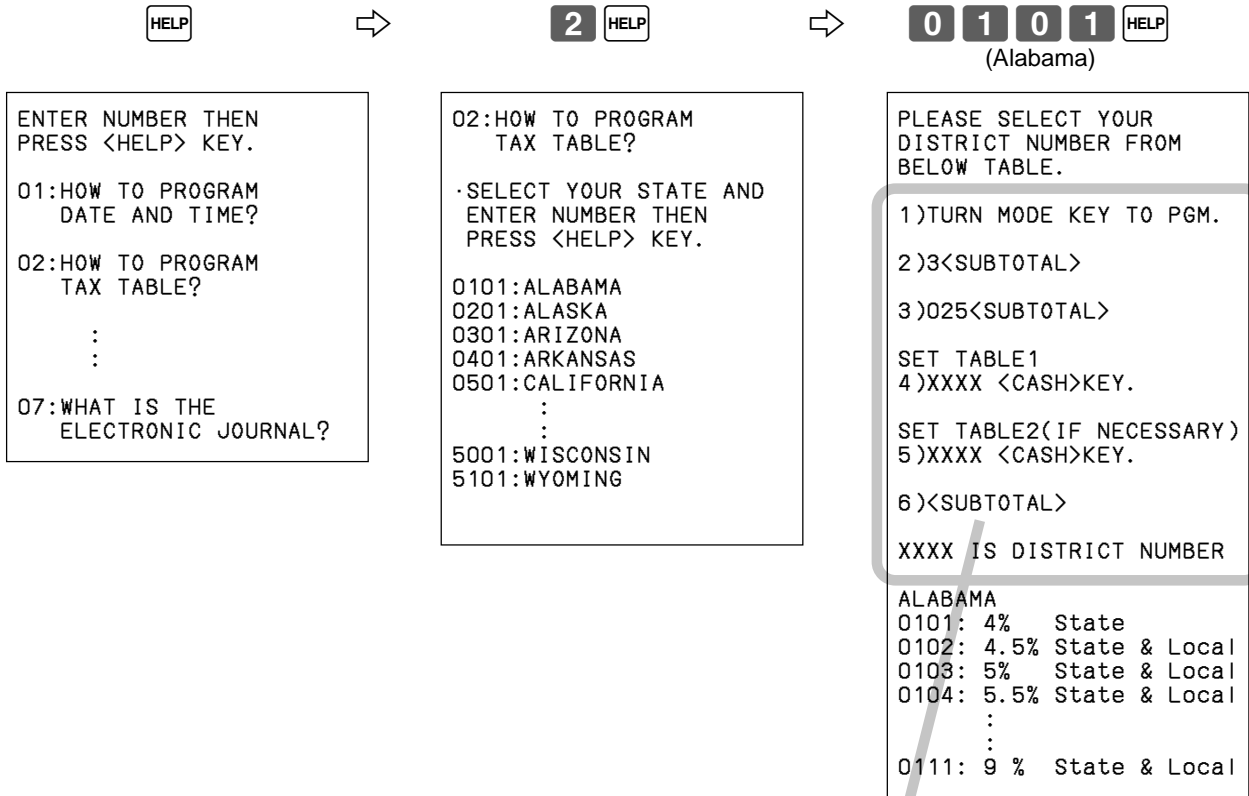

Follow these steps.

10.

Tax table programming (continued)

Programming for Canadian tax tables procedure

State sales tax calculation data tables for all of the states that make up all Canadian provinces are included on this page. This data is current as of October 30, 1994. Simply find your province in the tax tables and input the data shown in its table.

Programming tax table

Example 1: Federal tax 7% (Add-on/round-off)

Example 2: Ontario 10% (Tax-on-tax/Round-off)

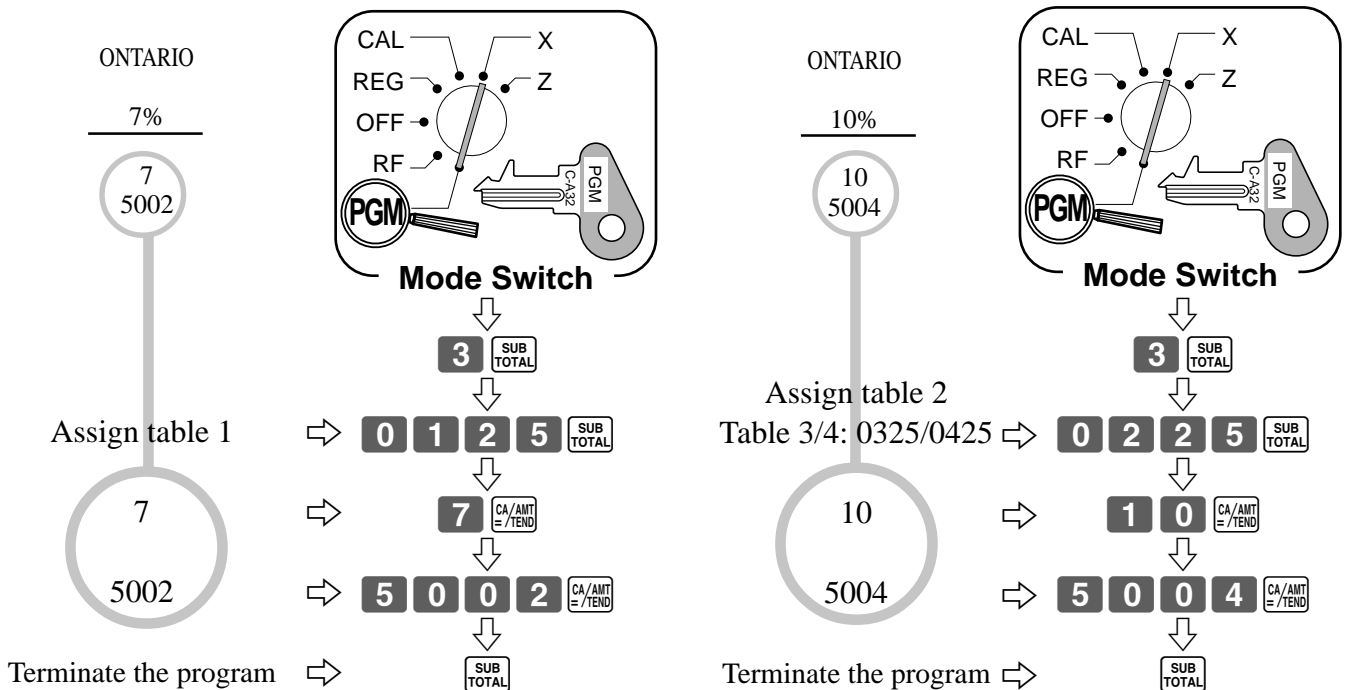

• **4 tax tables are used for the following purpose**

Table 1: Used for the federal taxable items.

Table 2: Used for the provincial taxable items.

Table 3/4: Used for the provincial taxable items for different tax table.

CANADIAN TAX TABLES

* Must be programmed into Tax table 2 ~ 4.

	* NOVA SCOTIA 10%	* ONTARIO 10%	* QUEBEC 10%	* NEW FOUNDLAND 12%	* ONTARIO 12%	* BRITISH COLUMBIA 6%	* MANITOBA/ SASKATCHEWAN 6%	* ONTARIO 7%	* N.B. & P.E.I 8%	* QUEBEC 9%
	10	10	10	12	0	0	6	7	0	9
	5004	5004	5004	5004	1	1	5002	5002	1	9002
					4	2			3	
					25	14			25	
					25	24			25	
					25	41			31	
					29	58			43	
					37	74			56	
					45					
					54					

Important!

Be sure you use the federal sales tax data with your provincial sales tax data. Even if your province use the same tax rate as another province, inputting the wrong data will result incorrect tax calculations.

Introducing PCR-T2000

General guide

This part of the manual introduces you to the cash register and provides a general explanation of its various parts.

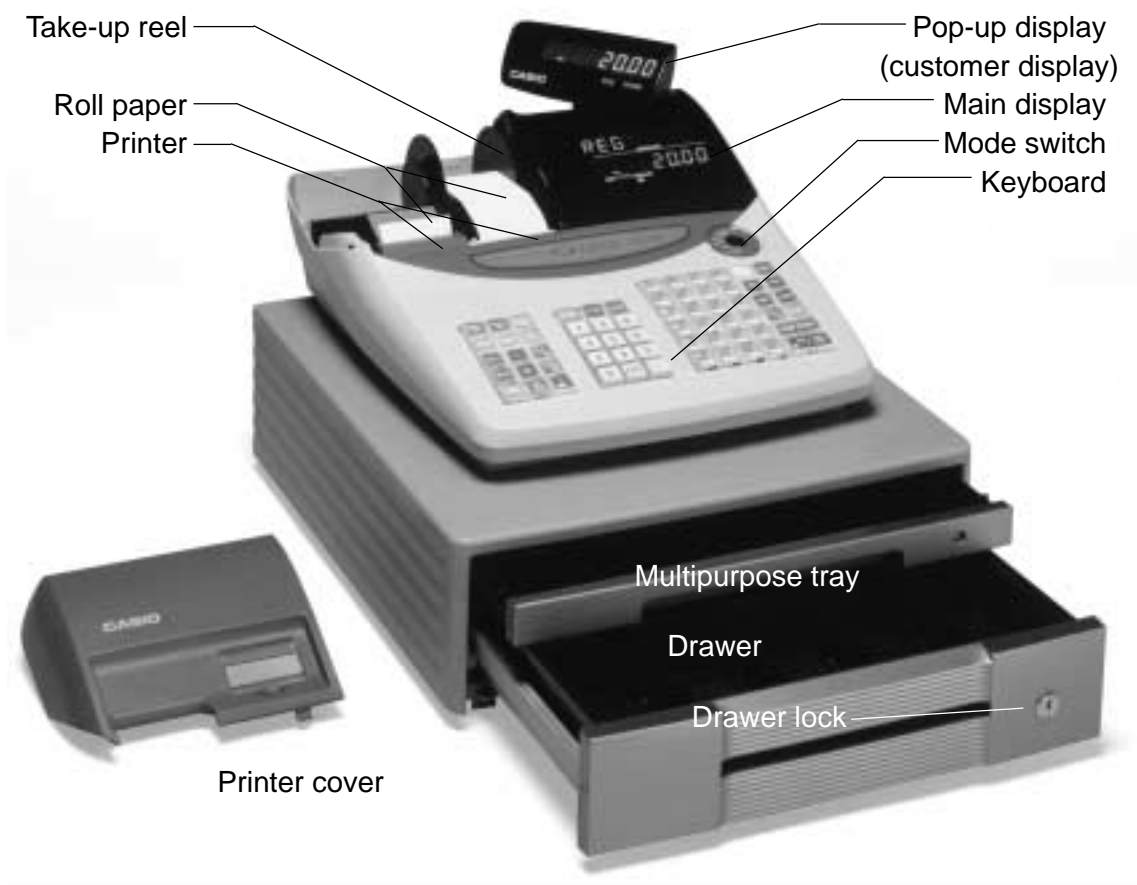

Roll paper

You can use the roll paper to print receipts and a journal (page 9 ~ 10).

Receipt On/Off key

When you are using the printer for receipt printer, you can use this key (in the REG and RF modes only) to turn the printer on and off.

If a customer asks for a receipt while receipt printing is turned off by this key, you can issue a post-finalization receipt (page 45).

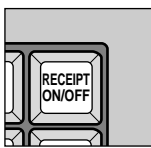

Mode key

There are two types of mode keys: the program key (marked "PGM") and the operator key (marked "OP"). The program key can be used to set the mode switch to any position, while the operator key can select the REG, CAL and OFF position.

Drawer

The drawer opens automatically whenever you finalize a registration and whenever you issue a read or reset report. The drawer will not open if it is locked with the drawer key.

Drawer lock

Use the drawer key to lock and unlock the drawer.

Multipurpose tray

This tray can always be opened if the locking knob is in the unlock position.

Use the locking knob to lock and unlock this tray.

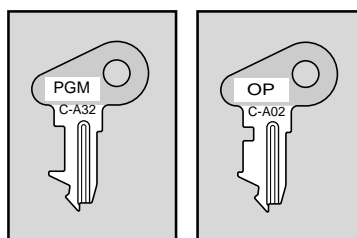

Program key

Operator key

Mode switch

Use the mode keys to change the position of the mode switch and select the mode you want to use.

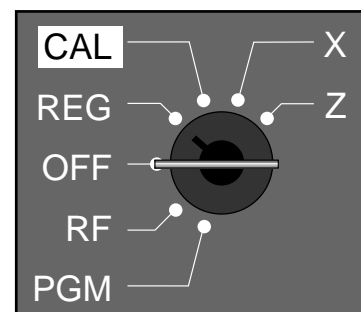

Mode Switch	Mode Name	Description
Z	RESET	Reads sales data in memory and clears the data.
X	READ	Reads sales data in memory without clearing the data.
CAL	CALCULATOR	Use this mode for calculator.
REG	REGISTER	Use this mode for normal registration.
OFF	STAND-BY	Cash register standing by.
RF	REFUND	Use this mode to register refund transaction.
PGM	PROGRAM	Use this mode for cash register programming.

Lock/unlock the multipurpose tray

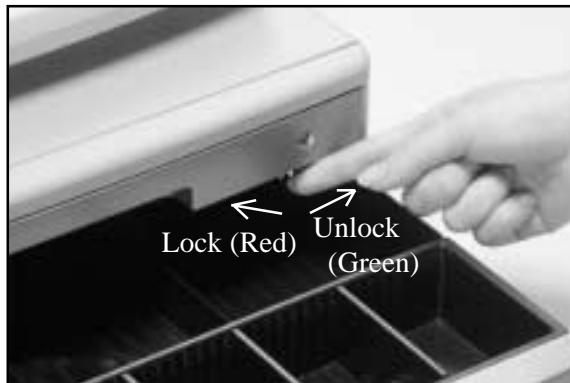

When the cash drawer does not open!

In case of power failure or the machine is in malfunction, the cash drawer does not open automatically. Even in these cases, you can open the cash drawer by pulling drawer release lever (see below).

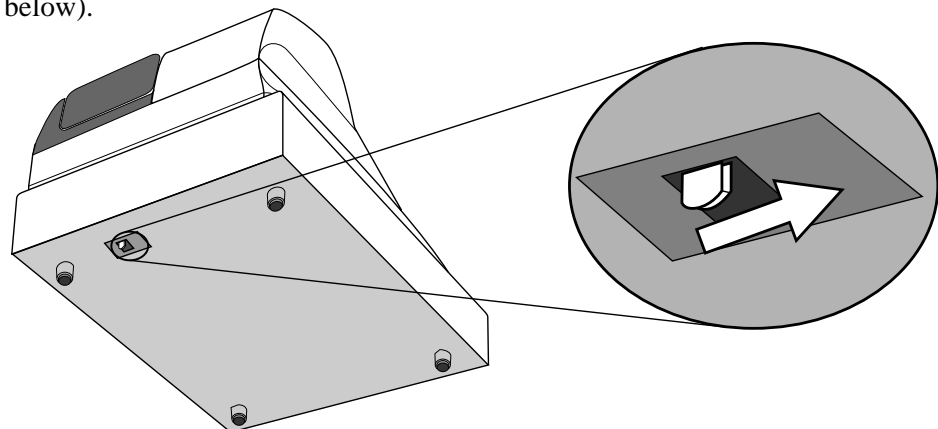

Important!

The drawer will not open, if it is locked with a drawer lock key.

Displays

Main Display

(alphanumeric + numeric display)

Pop-up (customer) display

(numeric display)

Item registration (by department/PLU)

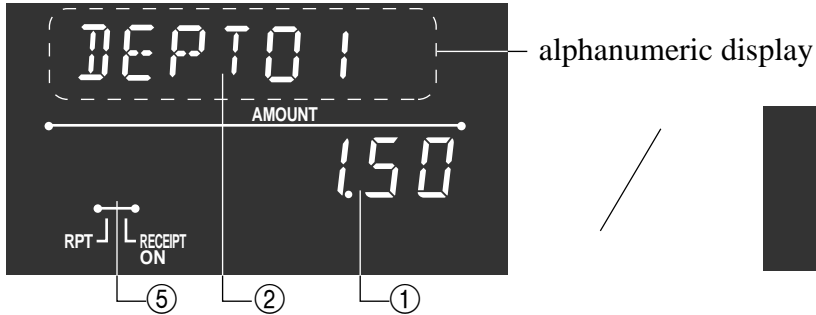

Repeat registration

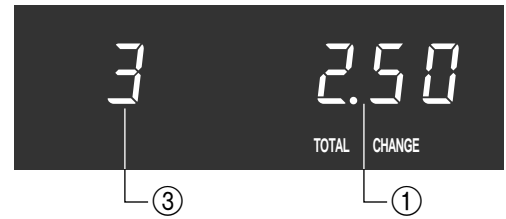
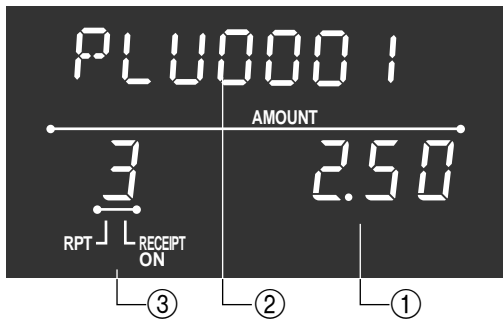

Totalize operation

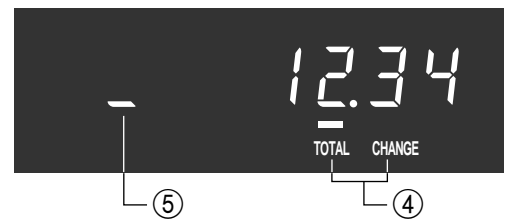
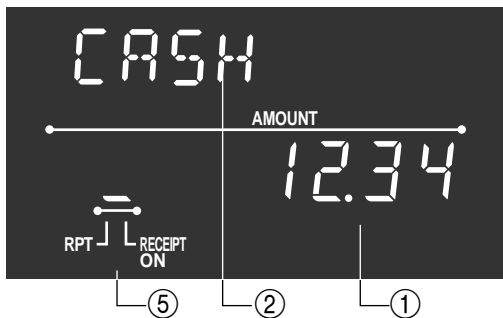

① Amount/Quantity

This part of the display shows monetary amounts. It also can be used to show the current time. (The current date is shown in the alphanumeric display.)

② Item/Key descriptor

When you register an item or key, the item/key descriptor appears here. Mode descriptor is also displayed here.

③ Number of repeats

Anytime you perform a repeat registration (page 26, 30), the number of repeats appears here.

Note that only one digit is displayed for the number of repeats. This means that a “5” could mean 5, 15 or even 25 repeats.

④ Total/Change indicators

When the TOTAL indicator is lit, the displayed value is monetary total or subtotal amount. When the CHANGE indicator is lit, the displayed value is the change due.

⑤ Receipt on/off indicators





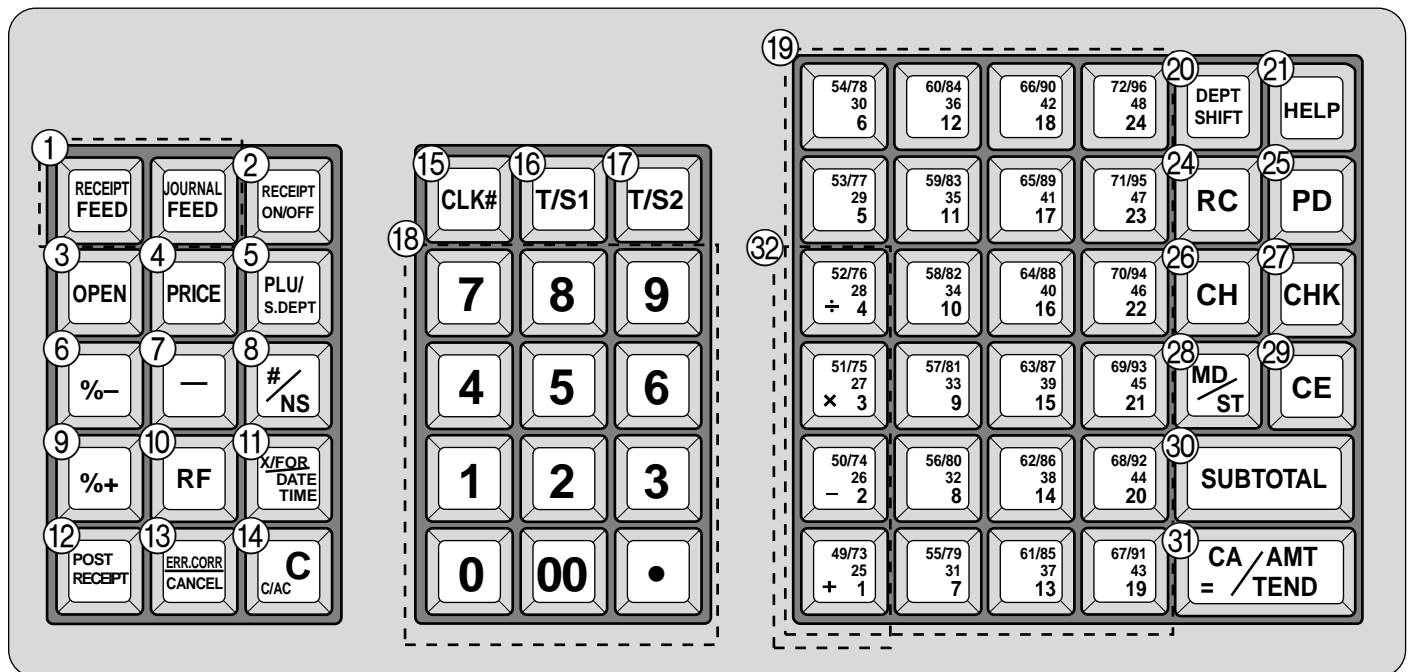















When the register is in “issuing receipt” mode, under-bar sign is lit on this digit. (REG/RF mode, during standing-by only)

Keyboard



for the U.S.

• Register Mode

- ① **Paper feed key** , 
Hold this key down to feed paper from the printer.
- ② **Receipt on/off key** 
Use this key twice to change the status “receipt issue” or “no receipt.” In case of “receipt issue”, the “RECEIPT ON” indicator is lit.
- ③ **Open key** 
Use this key to temporarily release a limitation on the number of digits that can be input for a unit price.
- ④ **Price key** 
Use this key to register unit prices for subdepartment.
- ⑤ **PLU/Subdepartment key** 
Use this key to input PLU (subdepartment) numbers.
- ⑥ **Discount key** 
Use this key to register discounts.
- ⑦ **Minus key** 
Use this key to input values for subtraction.
- ⑧ **Non-add/No sale key** 
Non-add key: Use this key to print reference number (to identify a personal check, credit card, etc.) during a transaction, use this key after some numerical entries.
No sale key: Use this key to open the drawer without registering anything.
- ⑨ **Premium key** 
Use this key to register premiums.
- ⑩ **Refund key** 
Use this key to input refund amounts and void certain entries.
- ⑪ **Multiplication/For/Date/Time key** 
Use this key to input a quantity for a multiplication and registration of split sales of packaged items. Between transactions, this key displays the current time and date.
- ⑫ **Post receipt key** 
Use this key to produce a post-finalization receipt (page 45).
- ⑬ **Error correct/Cancel key** 
Use this key to correct registration errors and to cancel registration of entire transactions.
- ⑭ **Clear key** 
Use this key to clear an entry that has not yet been registered.
- ⑮ **Clerk number key** 
Use this key to sign clerk on and off the register.
- ⑯ **Tax shift 1 key** 
Use this key without a numeric entry to change the Taxable 1 status of the next item.
- ⑰ **Tax shift 2 key** 
Use this key without a numeric entry to change the Taxable 2 status of the next item.
- ⑱ **Ten key pad** **0**, **1**, ~ **9**, **00**, **.**
Use these keys to input numbers.
- ⑲ **Department keys** , ~  (**+ 1**, ~ **24**)
Use these keys to register items to departments.

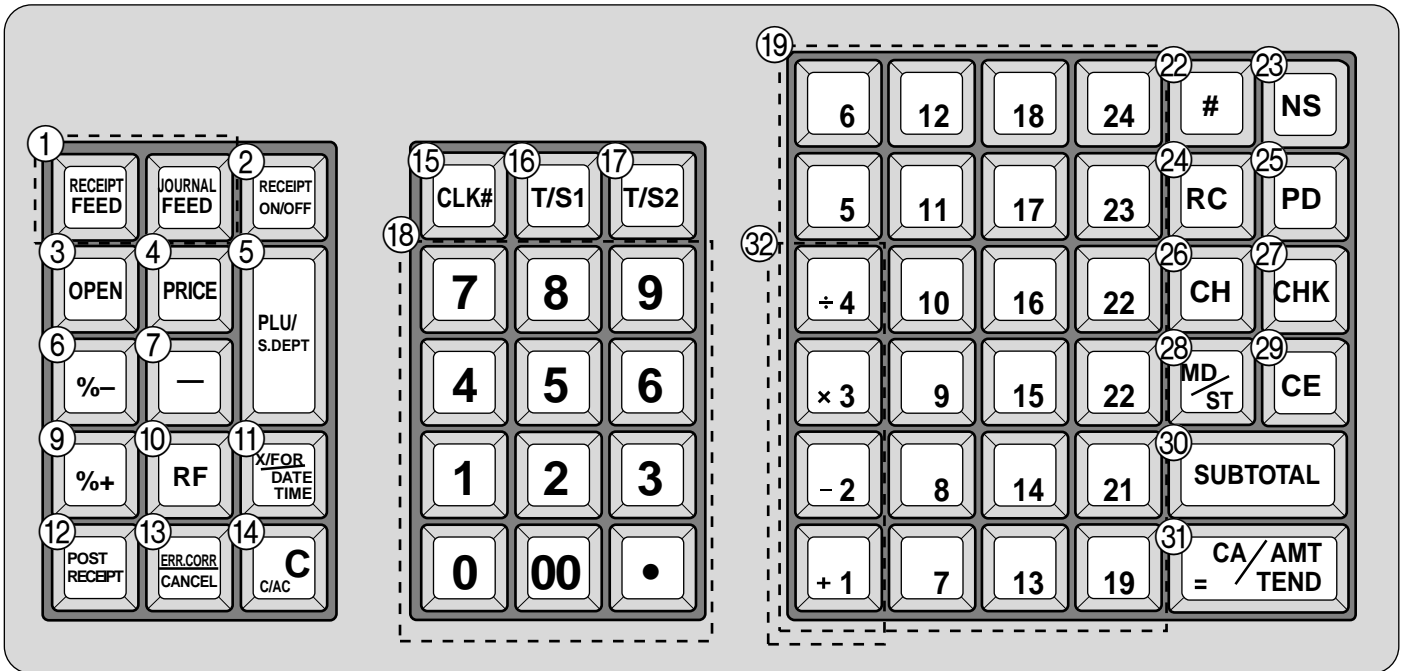

for Canada

20 Department shift key DEPT SHIFT

Use this key to shift the department key number from 1 through 24 to 25 through 48, 49 to 72, 73 to 96.

49/73 + 25 ⇨ Dept 01	DEPT SHIFT DEPT SHIFT 49/73 + 25 ⇨ Dept 49
50/74 - 26 ⇨ Dept 02	DEPT SHIFT DEPT SHIFT 50/74 - 26 ⇨ Dept 50
⋮	⋮
72/96 38 ⇨ Dept 24	DEPT SHIFT DEPT SHIFT 72/96 38 ⇨ Dept 72
DEPT SHIFT 49/73 + 25 ⇨ Dept 25	DEPT SHIFT DEPT SHIFT 49/73 + 25 ⇨ Dept 73
⋮	⋮
DEPT SHIFT 72/96 38 ⇨ Dept 48	DEPT SHIFT DEPT SHIFT 72/96 38 ⇨ Dept 96

21 Help key HELP

Use this key to look up the procedures to set date/time, tax table etc.

22 Non-add key #

Use this key to print reference number (to identify a personal check, credit card, etc.) during a transaction, use this key after some numerical entries.

23 No sale key NS

Use this key to open the drawer without registering anything.

24 Received on account key RC

Use this key following a numeric entry to register money received for non-sale transactions.

25 Paid out key PD

Use this key following a numeric entry to register money paid out from the drawer.

26 Charge key CH

Use this key to register a charge sale.

27 Check key CHK

Use this key to register a check tender.

28 Merchandise subtotal key MD/ST

Use this key to display and print the current subtotal (excludes add-on tax) amount.

29 Currency exchange key CE

Use this key for calculating subtotal amounts or paying amount due in foreign currency (page 65).

30 Subtotal key SUB TOTAL

Use this key to display and print the current subtotal (includes add-on tax) amount.

31 Cash amount tendered key CA/AMT =/TEND

Use this key to register a cash sale.

• Calculator Mode

6 Percent key %-

14 Clear/All clear key C

18 Ten key pad 0, 1, ~ 9, 00, .

8, 23 Drawer open key #/NS, NS

24 Memory recall key RC

31 Equal key CA/AMT =/TEND

32 Arithmetic operation key 49/73
+
25, 50/74
-
26, 51/75
x
3 and 52/76
+
28

+ 1, - 2, x 3 and + 4

How to read the printouts

- The journal and receipts are records of all transactions and operations.
- The contents printed on receipts and journal are identical, except the date printing line. (The date line is printed on receipts and reports.)
- You can choose the journal skip function (page 46).
If the journal skip function is selected, the cash register will print the total amount of each transaction, and the details of premium, discount and reduction operations only, without printing department and PLU item registrations on the journal.
- The following items can be skipped on receipts and journal.
 - Time
 - Consecutive number
 - Taxable status
 - Taxable amount

Receipt Sample

* * THANK YOU *				Logo message or graphic logo
** CALL AGAIN **				

* COMMERCIAL MESSAGE *				Commercial message
* COMMERCIAL MESSAGE *				
* COMMERCIAL MESSAGE *				
* COMMERCIAL MESSAGE *				
REG 06-15-2002 12:34				Mode/Date/Time
CLERK 01 0001-000123				Clerk/Machine No. -Consecutive No.
DEPT01 T1 \$1.00				
DEPT02 T1 \$2.00				
5 X @1.00				
DEPT03 T2 \$5.00				
TAX-AMT 1 \$3.00				Taxable amount with tax rate
TAX 1 5% \$0.15				
TAX-AMT 2 \$5.00				
TAX 2 4% \$0.20				
TAX \$0.35				Tax total
TOTAL \$8.35				
CASH \$10.00				
CHANGE \$1.65				
7 No				Item counter
*** BOTTOM MESSAGE ***				Bottom message
*** BOTTOM MESSAGE ***				
*** BOTTOM MESSAGE ***				
*** BOTTOM MESSAGE ***				
*** BOTTOM MESSAGE ***				

Journal Sample (Item lines Included) (normal height)

REG 12:33			
CLERK 01 0001-000122			
DEPT01 T1 \$1.00			
DEPT02 T1 \$2.00			
TAX-AMT 1 \$3.00			
TAX 1 \$0.15			
TAX \$0.15			
CASH \$3.15			
2 No			
REG 12:34			
CLERK 01 0001-000123			
DEPT01 T1 \$1.00			
DEPT02 T1 \$2.00			
5 X @1.00			
DEPT03 T2 \$5.00			
TAX-AMT 1 \$3.00			
TAX 1 5% \$0.15			
TAX-AMT 2 \$5.00			
TAX 2 4% \$0.20			
TAX \$0.35			
TOTAL \$8.35			
CASH \$10.00			
CHANGE \$1.65			
7 No			
REG 12:35			
CLERK 01 0001-000124			
DEPT01 T1 \$1.00			
DEPT02 T1 \$2.00			
5 X @1.00			
DEPT03 T2 \$5.00			

Journal Sample (Item lines Skipped) (half height)

REG 06-15-2002 12:32			
CLERK 01 0001-000121			
TAX 5% \$0.15			
TAX \$0.15			
CASH \$3.15			
2 No			
REG 06-15-2002 12:33			
CLERK 01 0001-000122			
TAX-AMT 1 \$3.00			
TAX 1 5% \$0.15			
TAX \$0.15			
TAX 2 4% \$0.20			
TAX \$0.35			
CASH \$8.35			
CASH \$10.00			
CHANGE \$1.65			
7 No			
REG 06-15-2002 12:35			
CLERK 01 0001-000124			
TAX 5% \$0.15			
TAX \$0.15			
TAX-AMT 2 \$5.00			
TAX 2 4% \$0.20			

In the operation examples contained in this manual, the print samples are what would be produced if the roll paper is being used for receipts. They are not actual size. Actual receipts are 58 mm wide. Also, all sample receipts and journals are printout images.

How to use your cash register

The following describes the general procedure you should use in order to get the most out of your cash register.

BEFORE business hours...

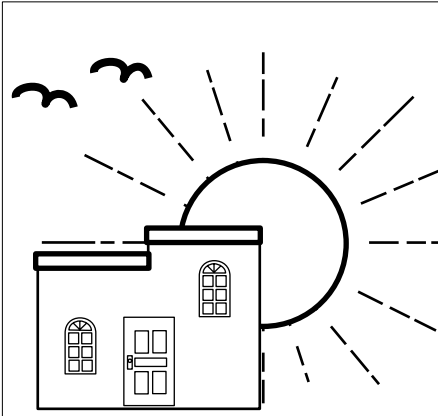

- Check to make sure that the cash register is plugged in securely. Page 11
- Check to make sure there is enough paper left on the roll. Page 9, 10
- Read the financial totals to confirm that they are all zero. Page 73
- Check the date and time. Page 24

DURING business hours...

- Register transactions. Page 25
- Periodically read totals. Page 72



AFTER business hours...

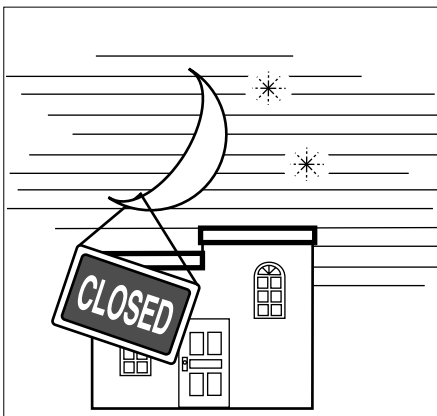

- Reset the daily totals. Page 43
- Remove the journal. Page 84
- Empty the cash drawer and leave it open. Page 18
- Take the cash and journal to the office.

Basic Operations and Setups

Displaying the time and date

You can show the time and date on the display of the cash register whenever there is no registration being made.

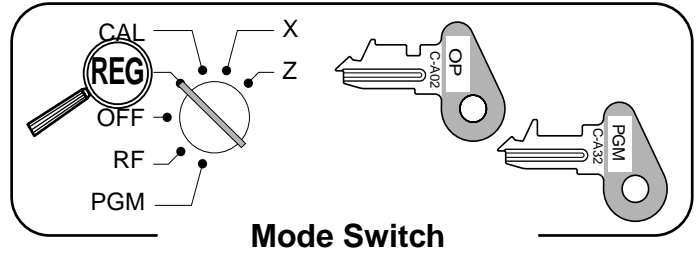

To display and clear the time and date

OPERATION

DISPLAY



Month Day Year

Hour Minutes.
(24-hour system)



Preparing coins for change

You can use the following procedure to open the drawer without registering an item. This operation must be performed out of a sale.

(You can use the **RC** key instead of the **#/NS** key. See page 39.)

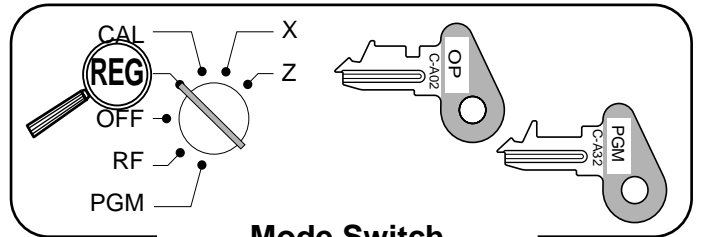

Opening the drawer without a sale

OPERATION

RECEIPT

#/NS
(**NS**): Canada)

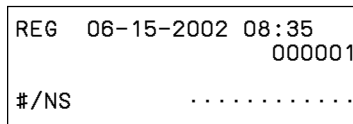

Preparing and using department keys

Registering department keys

The following examples show how you can use the department keys in various types of registrations.

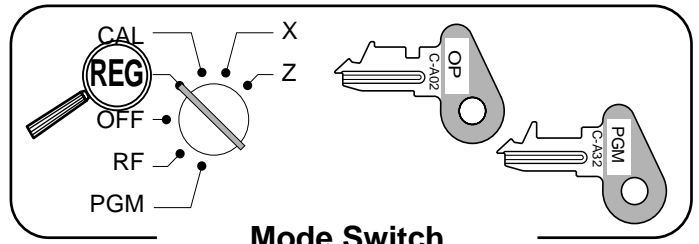

Mode Switch

Single item sale

Example 1

OPERATION

Item	Unit price	\$1.00
	Quantity	1
	Dept.	1
	Taxable	(1)
Payment	Cash	\$1.05

1 00
Unit price

+ 1
Department

CA/AMT = /TEND

RECEIPT

REG	06-15-2002	08:40	Mode/date/time
		000002	Consecutive No.
DEPT01	T1	\$1.00	Department descriptor/unit price
TAX-AMT 1		\$1.00	Taxable amount 1
TAX 1		\$0.05	Tax amount 1
CASH		\$1.05	Cash total amount

Example 2

OPERATION

Item 1	Unit price	\$1.00
	Quantity	1
	Dept.	25
Item 2	Unit price	\$2.00
	Quantity	1
	Dept.	49
Item 3	Unit price	\$3.00
	Quantity	1
	Dept.	73
Payment	Cash	\$10.00

1 00 **DEPT SHIFT** **49/73 + 25 1**
Designating from department
25 to 48, press **DEPT SHIFT** once
(- 2 - shows),
49 to 72, press **DEPT SHIFT** twice,
(- 3 - shows),
73 to 96, press **DEPT SHIFT** three times
(- 4 - shows).

2 00

DEPT SHIFT **DEPT SHIFT** **49/73 + 25 1**

3 00

DEPT SHIFT **DEPT SHIFT** **DEPT SHIFT** **49/73 + 25 1**

1 0 00 **CA/AMT = /TEND**

RECEIPT

REG	06-15-2002	08:40	
		000003	
DEPT25		\$1.00	
DEPT49		\$2.00	
DEPT73		\$3.00	
TOTAL		\$6.00	
CASH		\$10.00	
CHANGE		\$4.00	

Example 3

OPERATION

Item	Unit price	\$1.00
	Quantity	1
	Dept.	3
	Tax status	(1/2)→2
Payment	Cash	\$1.00

T/S1 **3 00** **x 3**

Shifting taxable dept. to nontaxable by depressing **T/S1**, **T/S2** before numeric.

CA/AMT = /TEND

RECEIPT

REG	06-15-2002	08:40	
		000004	
DEPT03	T2	\$3.00	Tax status symbol
TAX-AMT 2		\$3.00	Taxable amount 2
TAX 2		\$0.30	Tax amount 2
CASH		\$3.30	

Basic Operations and Setups

Repeat

Item	Unit price	\$1.50
	Quantity	3
	Dept.	3
	Taxable	(1/2)
Payment	Cash	\$10.00

1 5 0

1 0 00

REG	06-15-2002	08:45	
		000003	
DEPT03	T1T2	\$1.50	
DEPT03	T1T2	\$1.50	Repeat
DEPT03	T1T2	\$1.50	Repeat
TAX-AMT 1		\$4.50	
TAX 1		\$0.23	
TAX-AMT 2		\$4.50	
TAX 2		\$0.45	
TOTAL		\$5.18	
CASH		\$10.00	
CHANGE		\$4.82	

Multiplication

Item	Unit price	\$1.00
	Quantity	12.5
	Dept.	3
	Taxable	(1/2)
Payment	Cash	\$20.00

1 2 . 5

Quantity
(4-digit integer/2-digit decimal)

1 00

2 0 00

REG	06-15-2002	08:50	
		000004	
12.5	X	@1.00	Quantity/unit price
DEPT03	T1T2	\$12.50	
TAX-AMT 1		\$12.50	
TAX 1		\$0.63	
TAX-AMT 2		\$12.50	
TAX 2		\$1.25	
TOTAL		\$14.38	
CASH		\$20.00	
CHANGE		\$5.62	

Split sales of packaged items

Item	Unit price	\$10.00
	Quantity	3 / 4
	Dept.	3
	Taxable	(1/2)
Payment	Cash	\$20.00

3

Quantity being purchased
(4-digit integer/2-digit decimal)

4

Quantity being purchased
(4-digit integer/2-digit decimal)

1 0 00

Package price

1 0 00

REG	06-15-2002	08:55	
		000007	
3	X	@4 /	10.00
DEPT03	T1T2	\$7.50	Quantity Package quantity/ unit price
TAX-AMT 1		\$7.50	
TAX 1		\$0.38	
TAX-AMT 2		\$7.50	
TAX 2		\$0.75	
TOTAL		\$8.63	
CASH		\$10.00	
CHANGE		\$1.37	

Programming department keys

To program a unit price for each department

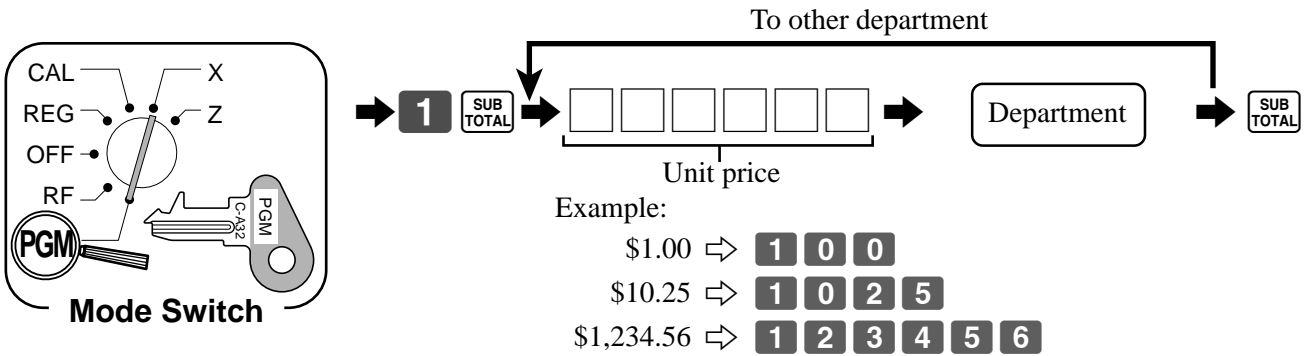

To program the tax calculation status for each department

Tax calculation status

This specification defines which tax table should be used for automatic tax calculation. See page 13 for information on setting up the tax tables.

Programming procedure

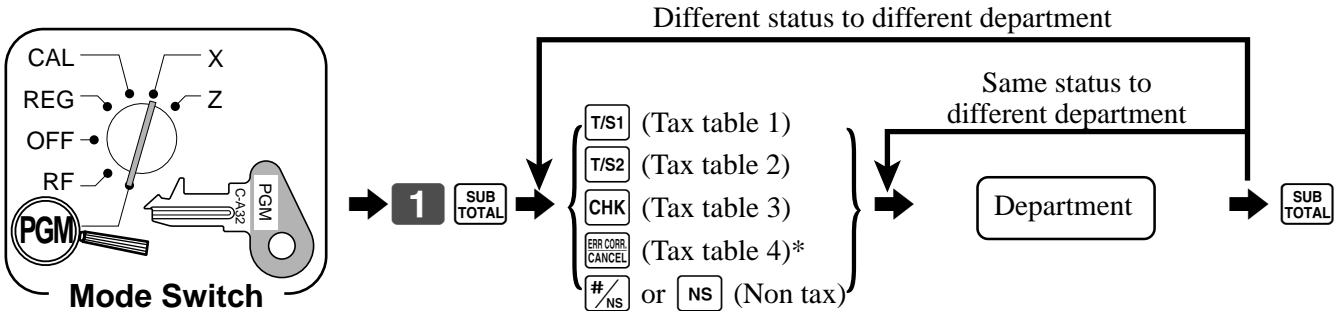

Note: Tax symbols

T1: Tax table 1

T2: Tax table 2

T3: Tax table 3

T4: Tax table 4 *(only for the Canadian model)

Department 1 ~ 12 are initialized as Taxable 1 and 2, others are initialized as non-tax.

Department designation

Department

for the U.S.

$\frac{49}{73} + \frac{25}{1}$ (Dept.1)	DEPT SHIFT DEPT SHIFT $\frac{49}{73} + \frac{25}{1}$ (Dept.49)
$\frac{50}{74} - \frac{26}{2}$ (Dept.2)	DEPT SHIFT DEPT SHIFT $\frac{50}{74} - \frac{26}{2}$ (Dept.50)
:	:
$\frac{72}{96} \frac{48}{24}$ (Dept.24)	DEPT SHIFT DEPT SHIFT $\frac{72}{96} \frac{48}{24}$ (Dept.72)
DEPT SHIFT $\frac{49}{73} + \frac{25}{1}$ (Dept.25)	DEPT SHIFT DEPT SHIFT $\frac{49}{73} + \frac{25}{1}$ (Dept.73)
:	:
DEPT SHIFT $\frac{72}{96} \frac{48}{24}$ (Dept.48)	DEPT SHIFT DEPT SHIFT $\frac{72}{96} \frac{48}{24}$ (Dept.96)

for Canada

+ 1 (Dept.1)
- 2 (Dept.2)
:
24 (Dept.24)

Basic Operations and Setups

Registering department keys by programming data

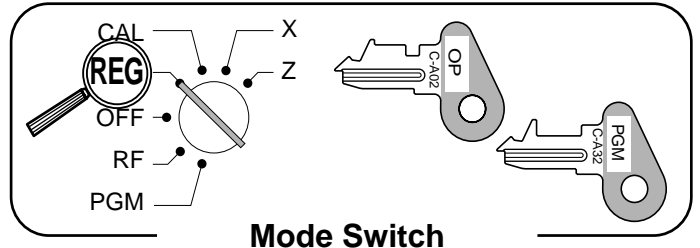

Preset price

OPERATION

Item	Unit price	(\$1.00)
	Quantity	1
	Dept.	1
	Taxable	(No)
Payment	Cash	\$1.00

(): Preset value

49/73
+
25
1
CA/AMT
=/TEND

RECEIPT

```
REG 06-15-2002 08:55
                        000005
DEPT01                $ 1.00 Department
CASH                   $ 1.00 descriptor/unit price
```

Preset tax status (Add-on tax)

OPERATION

Item 1	Unit price	(\$2.00)
	Quantity	5
	Dept.	2
	Taxable	(1)
Item 2	Unit price	(\$2.00)
	Quantity	1
	Dept.	4
	Taxable	(2)
Payment	Cash	\$20.00

(): Preset value

5 X / FOR
DATE
TIME
50/74
- 25
2
52/76
÷ 28
4
SUB
TOTAL
2 0 00 CA/AMT
=/TEND

RECEIPT

```
REG 06-15-2002 09:00
                        000006
5 X @2.00 Tax status symbols
DEPT02                $10.00
DEPT04                $ 2.00
TAX-AMT 1              $10.00 Taxable Amount 1
TAX 1                  $0.50 Tax 1
TAX-AMT 2              $ 2.00 Taxable Amount 2
TAX 2                  $0.12 Tax 2
TOTAL                  $12.62
CASH                   $20.00
CHANGE                 $ 7.38
```

Preparing and using PLUs

This section describes how to prepare and use PLUs.

CAUTION:

Before you use PLUs, you should first tell the cash register how it should handle the registration.

Programming PLUs

To program a unit price for each PLU

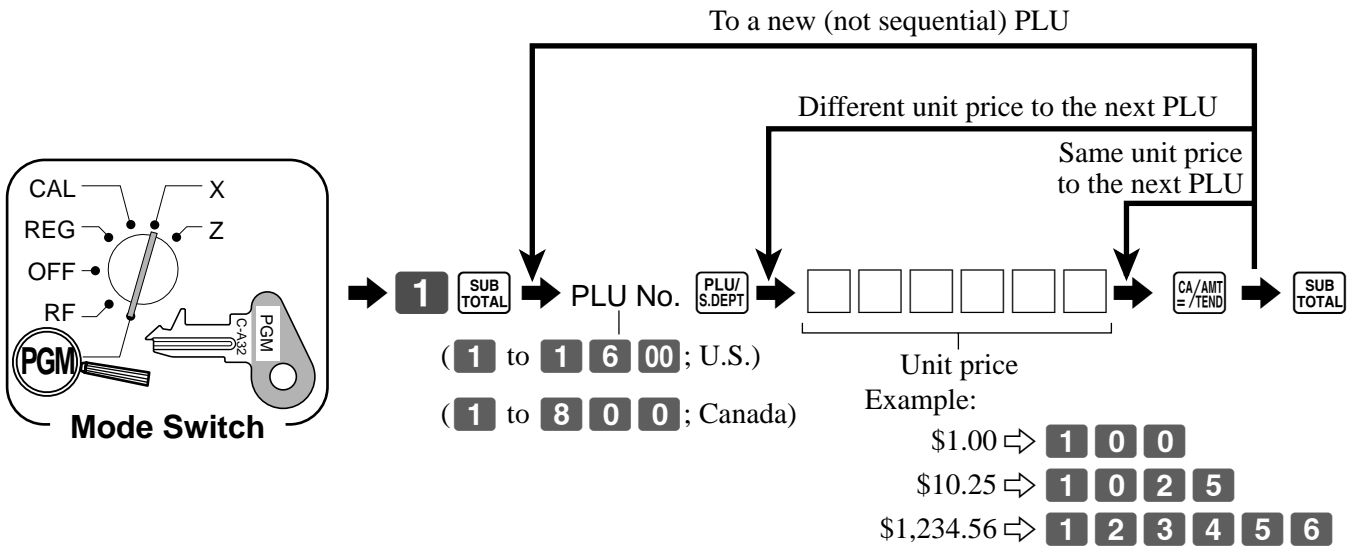

To program tax calculation status for each PLU

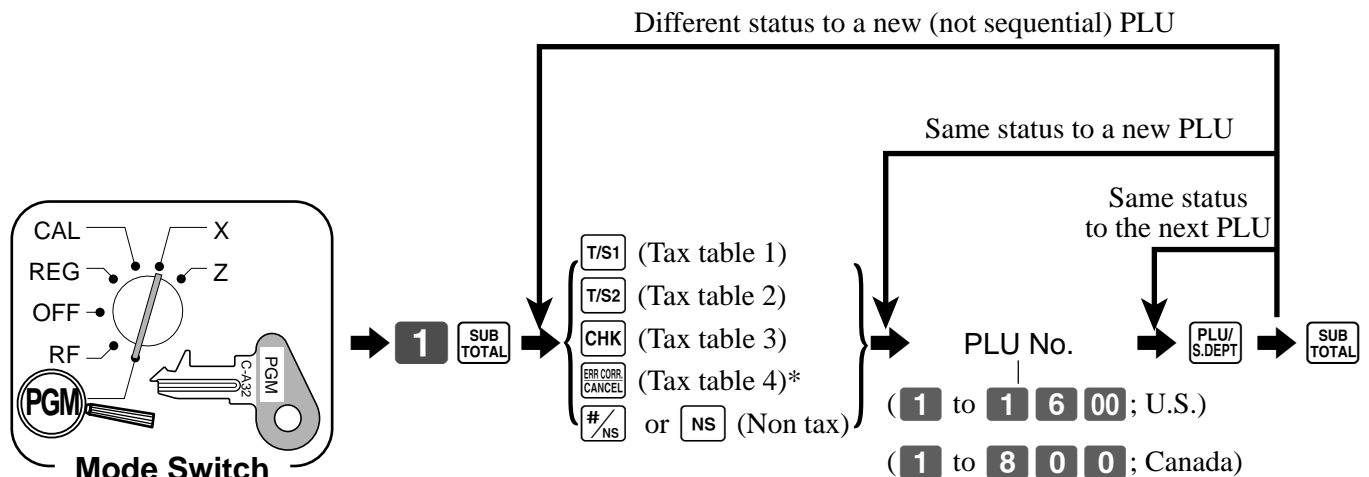

Note: Tax symbols

T1: Tax table 1

T2: Tax table 2

T3: Tax table 3

T4: Tax table 4 *(only for the Canadian model)

All PLUs are initialized as non-tax.

Basic Operations and Setups

Registering PLUs

The following examples show how you can use PLUs in various types of registrations.

Registering by subdepartment, see the "Convenient Operations and Setups" on page 62.

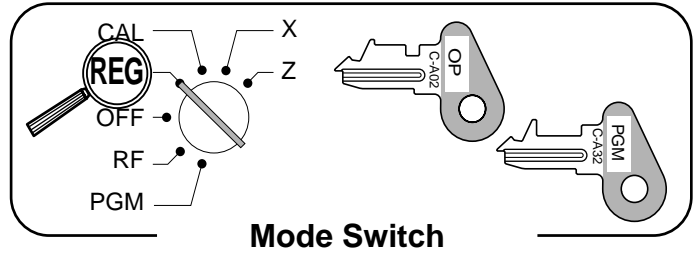

Mode Switch

PLU single item sale

OPERATION

Item	Unit price	(\$2.50)
	Quantity	1
	PLU	14
	Taxable	(2)
Payment	Cash	\$3.00

(): Preset value

1 4
PLU code

PLU/
S.DEPT

SUB
TOTAL

3 00 CA/AMT
= /TEND

RECEIPT

REG	06-15-2002	09:10	
			000008
PLU0014	T2	\$2.50	PLU descriptor/ unit price
TAX-AMT 2		\$2.50	
TAX 2		\$0.25	
TOTAL		\$2.75	
CASH		\$3.00	
CHANGE		\$0.25	

PLU repeat

OPERATION

Item	Unit price	(\$2.50)
	Quantity	3
	PLU	14
	Taxable	(2)
Payment	Cash	\$10.00

(): Preset value

1 4 PLU/
S.DEPT

PLU/
S.DEPT

PLU/
S.DEPT

SUB
TOTAL

1 0 00 CA/AMT
= /TEND

RECEIPT

REG	06-15-2002	09:15	
			000009
PLU0014	T2	\$2.50	
PLU0014	T2	\$2.50	
PLU0014	T2	\$2.50	
TAX-AMT 2		\$7.50	
TAX 2		\$0.75	
TOTAL		\$8.25	
CASH		\$10.00	
CHANGE		\$1.75	

PLU multiplication

OPERATION

Item	Unit price	(\$1.20)
	Quantity	15
	PLU	2
	Taxable	(2)
Payment	Cash	\$20.00

(): Preset value

1 5 X / FOR
/ DATE
/ TIME

Quantity
(4-digit integer/2-digit decimal)

2 PLU/
S.DEPT

SUB
TOTAL

2 0 00 CA/AMT
= /TEND

RECEIPT

REG	06-15-2002	09:20	
			000010
15	X	@1.20	
PLU0002	T2	\$18.00	
TAX-AMT 2		\$18.00	
TAX 2		\$1.80	
TOTAL		\$19.80	
CASH		\$20.00	
CHANGE		\$0.20	

PLU split sales of packaged item

Item	Unit price	(\$20.00)
	Quantity	3 / 5
	PLU	28
	Taxable	(2)
Payment	Cash	\$15.00

(): Preset value

3 / FOR
DATE TIME

5 / FOR
DATE TIME

2 **8** PLU/
S.DEPT

1 **5** **00** CA/AMT
= /TEND

Quantity
(4-digit integer/2-digit decimal)

REG 06-15-2002 09:35
000013

3 X
@5 / 20.00

PLU0028 T2 \$12.00

TAX-AMT 2 \$12.00

TAX 2 \$1.20

TOTAL \$13.20

CASH \$15.00

CHANGE \$1.80

Preparing and using discounts/premiums

This section describes how to prepare and register discount and premium.

Programming discounts/premiums

You can use the %**-** key to register discounts (percentage decreases) and the %**+** key to register premiums (percentage increases).

To program a rate to the %**-**/%**+** key

CAL — X

REG — Z

OFF —

RF —

PGM

Mode Switch

1 SUB TOTAL

Preset rate

%**-**

%**+**

SUB TOTAL

Example:

10% ⇒ **1 0**

5.5% ⇒ **5 . 5**

12.34% ⇒ **1 2 . 3 4**

To program tax status to the %**-**/%**+** key

CAL — X

REG — Z

OFF —

RF —

PGM

Mode Switch

1 SUB TOTAL

T/S1 (Tax table 1) T/S2 (Tax table 2)

CHK (Tax table 3) ERR CORR (Tax table 4)†

T/S1 T/S2 (Tax table 1, 2, 3 and 4†)

CHK ERR CORR (Tax table 1, 2, 3 and 4†)

#/NS or NS (Non tax)

%**-**

%**+**

SUB TOTAL

Note: Tax symbols %**-**/%**+** are initialized as all taxable.

T1: Tax table 1
T2: Tax table 2
T3: Tax table 3
T4: Tax table 4 †(only for the Canadian model)
*: All taxable

Basic Operations and Setups

Registering discounts/premiums

The following example shows how you can use the **%- / %+** key in various types of registration.

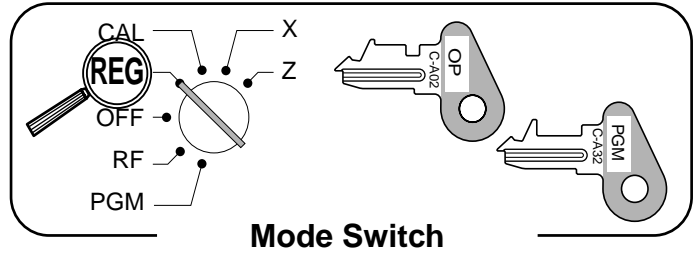

Discount for items and subtotals

OPERATION

Item 1	Unit price	\$5.00
	Quantity	1
	Dept.	2
	Taxable	(1)
Item 2	Unit price	(\$10.00)
	Quantity	1
	PLU	16
	Taxable	(2)
Discount	Rate	(5%)
Subtotal	Rate	3.5%
Discount	Taxable	(All)
Payment	Cash	\$16.00

(): Preset value

5 00 - 2

1 6 PLU/S.DEPT

%-

Applies the preset discount rate to the last item registered.

MD/ST

3 . 5 %-

The input value takes priority of the preset value.

SUB TOTAL

1 6 00 CA/AMT =/TEND

RECEIPT

```

REG 06-15-2002 10:30
                                000013
DEPT02      T1      $5.00
PLU0016     T2     $10.00
    5%
%-          T2      -0.50
ST
    3.5%
%-          *      -0.51
TAX-AMT 1   $4.82
TAX 1      $0.24
TAX-AMT 2   $9.17
TAX 2      $0.92
TOTAL                $15.15
CASH                $16.00
CHANGE              $0.85
    
```

Premium for items and subtotals

OPERATION

Item 1	Unit price	(\$10.00)
	Quantity	1
	Dept.	4
	Taxable	(2)
Premium	Rate	7%
Item 2	Unit price	(\$5.00)
	Quantity	1
	PLU	32
	Taxable	(2)
Subtotal	Rate	(5%)
Premium	Taxable	(1/2)
Payment	Cash	\$20.00

(): Preset value

+ 4

7 %+

Applies the input value as a premium rate (7%).

3 2 PLU/S.DEPT

MD/ST

%+

Applies the preset premium rate (5%) to the subtotal.

SUB TOTAL

2 0 00 CA/AMT =/TEND

RECEIPT

```

REG 06-15-2002 13:15
                                000037
DEPT04      T2      $10.00
    7%
%+          T2      $0.70
PLU0032     T2      $5.00
ST
    5%
%+          T1T2   $0.79
TAX-AMT 2   $16.49
TAX 2      $1.65
TOTAL                $18.14
CASH                $20.00
CHANGE              $1.86
    
```

- You can manually input rates up to 4 digits long (0.01% to 99.99%).

Taxable status of the **%- / %+** key

- Whenever you perform a discount operation on the last item registered, the tax calculation for discount amount is performed in accordance with the tax status programmed for that item.
- Whenever you perform a discount operation on a subtotal amount, the tax calculation for the subtotal amount is performed in accordance with the tax status programmed for the **%- / %+** key.

Preparing and using reductions

This section describes how to prepare and register reductions.

Programming for reductions

You can use the key to reduce single item or subtotal amounts. The following procedure lets you program the tax calculation method for the key.

To program tax calculation status

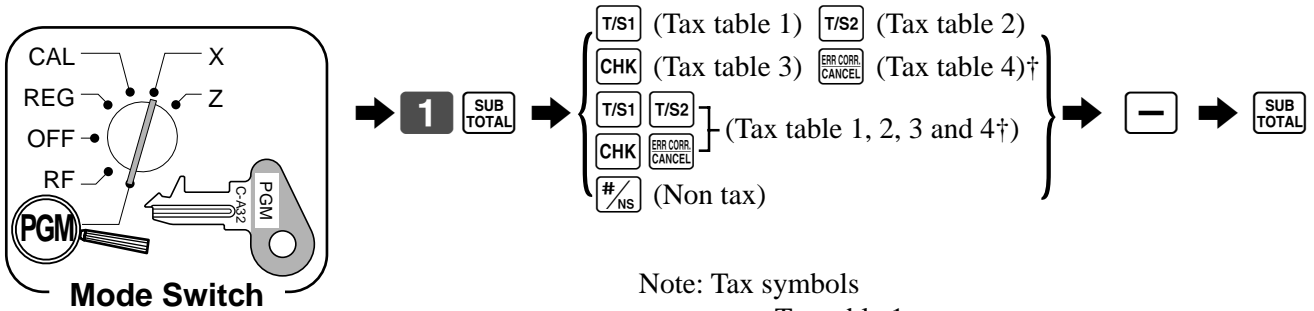

Note: Tax symbols

T1: Tax table 1

T2: Tax table 2

T3: Tax table 3

T4: Tax table 4 †(only for the Canadian model)

*: All taxable

is initialized as non-tax.

Taxable status of the key

The tax calculation for the reduction amount is performed in accordance with the tax status programmed for the key, regardless of whether the reduction is performed on the last item registered or a subtotal amount.

To program preset reduction amount

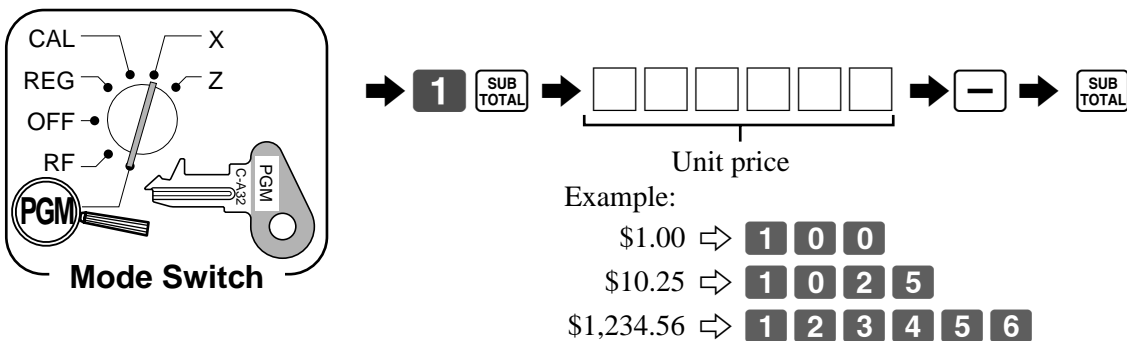

Basic Operations and Setups

Registering reductions

The following examples show how you can use the  key in various types of registration.

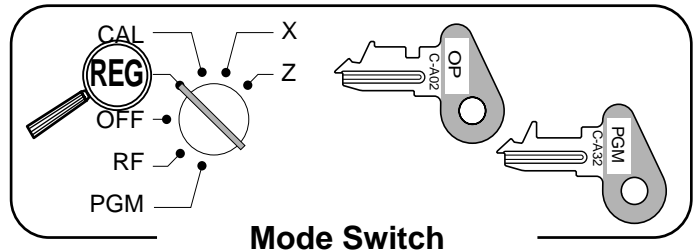

Reduction for items

OPERATION

RECEIPT

Item 1	Unit price	\$5.00
	Quantity	1
	Dept.	2
	Taxable	(1)
Reduction	Amount	\$0.25
Item 2	Unit price	(\$6.00)
	Quantity	1
	PLU	45
	Taxable	(1)
Reduction	Amount	(\$0.50)
Payment	Cash	\$15.00

5 00 - 2
2 5 -
Reduces the last amount registered by the value input.
4 5 PLU/S.DEPT
-
SUB TOTAL
1 5 00 CA/AMT =/TEND

REG	06-15-2002	10:35	
			000014
DEPT02	T1	\$5.00	
-		-0.25	
PLU0045	T1	\$6.00	
-		-0.50	
TAX-AMT 1		\$11.00	
TAX 1		\$0.55	
TOTAL		\$ 10.80	
CASH		\$15.00	
CHANGE		\$4.20	

(): Preset value

- You can manually input reduction values up to 7 digits long.
- The amount you input for the reduction is neither subtracted from the department nor PLU totalizer.

Reduction for subtotal

OPERATION

RECEIPT

Item 1	Unit price	\$3.00
	Quantity	1
	Dept.	2
	Taxable	(1)
Item 2	Unit price	\$4.00
	Quantity	1
	Dept.	4
	Taxable	(2)
Subtotal	Amount	\$0.75
Reduction	Taxable	(No)
Payment	Cash	\$7.00

3 00 - 2
4 00 ± 4
SUB TOTAL
7 5 -
Reduces the subtotal by the value input here.
SUB TOTAL
7 00 CA/AMT =/TEND

REG	06-15-2002	10:40	
			000015
DEPT02	T1	\$3.00	
DEPT04	T2	\$4.00	
-		-0.75	
TAX-AMT 1		\$3.00	
TAX 1		\$0.15	
TAX-AMT 2		\$3.00	
TAX 2		\$0.30	
TOTAL		\$6.80	
CASH		\$7.00	
CHANGE		\$0.20	

(): Preset value

Calculating the merchandise subtotal

Use the operation shown below to calculate the merchandise subtotal, which includes the actual cost of the merchandise only without the add-on tax.

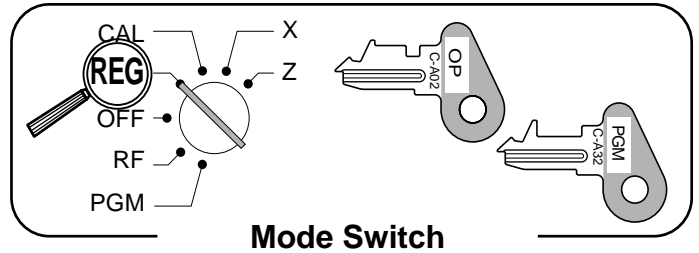

Calculation merchandise subtotal

			OPERATION	DISPLAY
Item 1	Unit price	\$1.00	1 00 $\frac{49}{73} + \frac{25}{1}$	1.00
	Quantity	1		
	Dept.	1		
	Taxable	(No)	2 00 $\frac{50}{74} - \frac{26}{2}$	2.00
Item 2	Unit price	\$2.00	3 00 $\frac{51}{75} \times \frac{27}{3}$	3.00
	Quantity	1		
	Dept.	2		
	Taxable	(1)	MD / ST	6.00
Item 3	Unit price	\$3.00		
	Quantity	1		
	Dept.	3		
	Taxable	(1/2)	SUB / TOTAL	6.55
Payment	Cash	\$10.00		
(): Preset value			1 0 00 $\frac{CA}{AMT} = \frac{7}{TEND}$	3.45

RECEIPT

REG	06-15-2002	10:45	
			000016
DEPT01			\$1.00
DEPT02	T1		\$2.00
DEPT03	T1T2		\$3.00
TAX-AMT 1			\$5.00
TAX 1			\$0.25
TAX-AMT 2			\$3.00
TAX 2			\$0.30
TOTAL			\$6.55
CASH			\$10.00
CHANGE			\$3.45

- For a partial tender operation, you should press the **SUB/TOTAL** key instead of the **MD/ST** key.

Basic Operations and Setups

Registering charge and check payments

The following examples show how to register charges and payments by check.

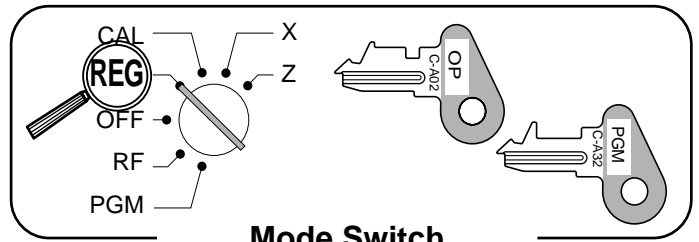

Check

OPERATION

RECEIPT

Item	Unit price	\$10.00
	Quantity	1
	Dept.	2
	Taxable	(1)
Payment	Check	\$20.00

(): Preset value

1 0 00 - 2
SUB TOTAL
2 0 00 CHK

```
REG 06-15-2002 10:50
000018
DEPT02 T1 $10.00
TAX-AMT 1 $10.00
TAX 1 $0.50
TOTAL $10.50
CHECK $20.00
CHANGE $9.50
```

Charge

OPERATION

RECEIPT

Item	Unit price	\$15.00
	Quantity	1
	Dept.	4
	Taxable	(2)
Reference	Number	0123
Payment	Charge	\$16.50

(): Preset value

1 5 00 ÷ 4
SUB TOTAL
* 0 1 2 3 #/NS
CH

* In Canada, you can use # instead of #/NS.

```
REG 06-15-2002 10:55
000019
DEPT04 T2 $15.00
#/NS 0123 Reference No.
TAX-AMT 2 $15.00
TAX 2 $1.50
CHARGE $16.50
```

Mixed tender (cash, charge and check)

OPERATION

RECEIPT

Item	Unit price	\$55.00
	Quantity	1
	Dept.	4
	Taxable	(2)
Payment	Check	\$30.00
	Cash	\$5.00
	Charge	\$25.50

(): Preset value

5 5 00 ÷ 4
SUB TOTAL
3 0 00 CHK
5 00 CA/AMT = /TEND
CH

```
REG 06-15-2002 11:00
000020
DEPT04 T2 $55.00
TAX-AMT 2 $55.00
TAX 2 $5.50
TOTAL $60.50
CHECK $30.00
CASH $5.00
CHARGE $25.50
```

Registering returned goods in the REG mode

The following example shows how to use the **RF** key in the REG mode to register goods returned by customers.

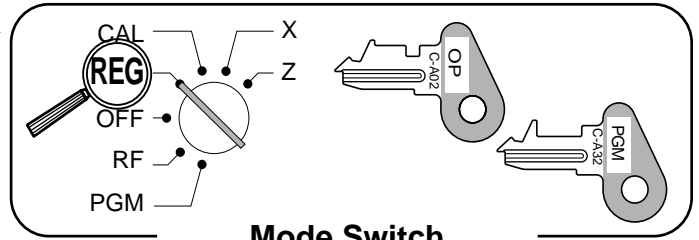

Mode Switch

OPERATION

RECEIPT

Item 1	Unit price	\$2.35
	Quantity	1
	Dept.	2
	Taxable	(1)
Item 2	Unit price	\$2.00
	Quantity	1
	Dept.	4
	Taxable	(2)
Item 3	Unit price	(\$1.20)
	Quantity	1
	PLU	1
	Taxable	(2)
Item 1 Returned	Unit price	\$2.35
	Quantity	1
	Dept.	2
	Taxable	(1)
Item 3 Returned	Unit price	(\$1.20)
	Quantity	1
	PLU	1
	Taxable	(2)
Payment	Cash	\$2.20

(): Preset value

2 3 5 **- 2**

2 00 **÷ 4**

1 **PLU/S.DEPT**

RF

2 3 5 **- 2**

Pressing **RF** specifies that the next item registered is a return.

RF

1 **PLU/S.DEPT**

You have to press **RF** before registering each returned item.

SUB TOTAL

CA/AMT =/TEND

REG	06-15-2002	11:05
		000021
DEPT02	T1	\$2.35
DEPT04	T2	\$2.00
PLU0001	T2	\$1.20
REFUND	
DEPT02	T1	-2.35
REFUND	
PLU0001	T2	-1.20
TAX-AMT 2		\$2.00
TAX 2		\$0.20
CASH		\$2.20

Registering returned goods in the RF mode

The following examples show how to use the RF mode to register goods returned by customers.

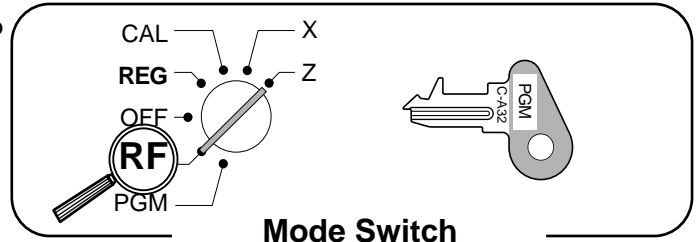

Normal refund transaction

OPERATION

Item 1 Returned	Unit price	\$1.50
	Quantity	2
	Dept.	2
	Taxable	(1)
Item 2 Returned	Unit price	(\$1.20)
	Quantity	6
	PLU	2
	Taxable	(2)
Payment	Cash	\$11.07

(): Preset value

1 5 0 - 2

- 2

6 X / FOR DATE TIME

2 PLU / S.DEPT

SUB TOTAL

CA / AMT = / TEND

RECEIPT

RF 06-15-2002 11:10
000022

DEPT02	T1	\$1.50
DEPT02	T1	\$1.50
	6 X @1.20	
PLU0002	T2	\$7.20
TAX-AMT 1		\$3.00
TAX 1		\$0.15
TAX-AMT 2		\$7.20
TAX 2		\$0.72
CASH		\$11.07

RF mode symbol

Reduction of amounts paid on refund

OPERATION

Item 1 Returned	Unit price	\$1.50
	Quantity	2
	Dept.	2
	Taxable	(1)
Reduction	Amount	\$0.15
Item 2 Returned	Unit price	(\$1.20)
	Quantity	1
	PLU	2
	Taxable	(2)
Discount	Rate	(5%)
Payment	Cash	\$5.30

(): Preset value

4 00 - 2

1 5 -

2 PLU / S.DEPT

%-

SUB TOTAL

CA / AMT = / TEND

RECEIPT

RF 06-15-2002 11:15
000023

DEPT02	T1	\$4.00
-		-0.15
PLU0002	T2	\$1.20
	5%	
%-	T2	-0.06
TAX-AMT 1		\$4.00
TAX 1		\$0.20
TAX-AMT 2		\$1.14
TAX 2		\$0.11
CASH		\$5.30

RF mode symbol

Important!

To avoid miss registrations in the RF mode, return the mode switch to the former position immediately.

Registering money received on account

The following example shows how to register money received on account. This registration must be performed out of a sale.

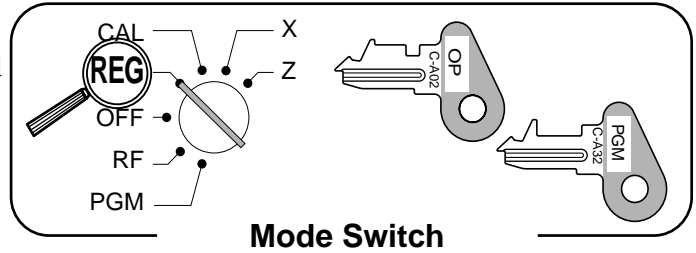

OPERATION

Received amount	\$700.00
-----------------	----------

7 00 00 RC

Amount can be up to 8 digits.

RECEIPT

REG	06-15-2002	11:20
		000024
RC		\$700.00

Registering money paid out

The following example shows how to register money paid out from the register. This registration must be performed out of a sale.

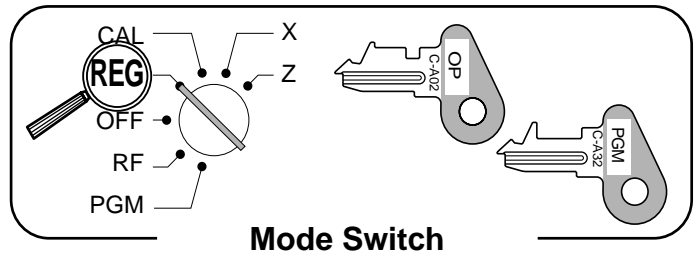

OPERATION

Paid out amount	\$1.50
-----------------	--------

1 5 0 PD

Amount can be up to 8 digits.

RECEIPT

REG	06-15-2002	11:30
		000025
PD		\$1.50

Making corrections in a registration

There are three techniques you can use to make corrections in a registration.

- To correct an item that you input but not yet registered.
- To correct the last item you input and registered.
- To cancel all items in a transaction.

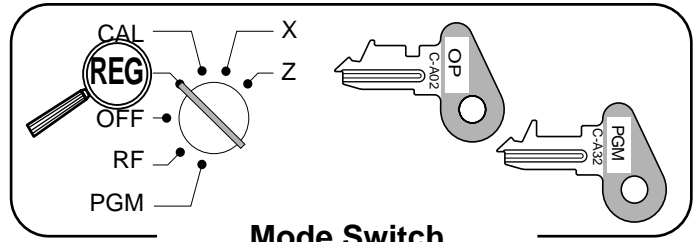

Mode Switch

To correct an item you input but not yet registered

OPERATION

RECEIPT

<p>2 00</p> <p>1 00 C <small>C/CAC</small></p> <p>1 2 - 2</p> <p>1 1 X / FOR <small>DATE TIME</small></p> <p>2 00 C <small>C/CAC</small></p> <p>2 X / FOR <small>DATE TIME</small></p> <p>2 ÷ 4</p> <p>3 C <small>C/CAC</small></p> <p>1 5 PLU/ <small>S.DEPT</small></p> <p>6 00</p> <p>1 5 C <small>C/CAC</small></p> <p>1 5 PLU/ <small>S.DEPT</small></p> <p>Enter subdepartment No. again.</p> <p>1 0 00 PRICE</p> <p>SUB TOTAL</p> <p>1 0 00</p> <p>1 5 00 C <small>C/CAC</small></p> <p>1 5 00 CA/AMT <small>= / TEND</small></p> <p>CH</p>	<p>Correction of unit price</p> <p>Correction of quantity</p> <p>Correction of PLU No.</p> <p>Correction of subdepartment unit price (See page 62 for registering.)</p> <p>Correction of partial tender amount</p>
--	--

REG	06-15-2002	11:35	
			000026
DEPT02	T1	\$1.00	
11	X	@2.00	
DEPT04	T2	\$22.00	
PLU0003	T1	\$1.30	
PLU0015	T1	\$10.00	
TAX-AMT 1		\$12.30	
TAX 1		\$0.62	
TAX-AMT 2		\$22.00	
TAX 2		\$2.20	
TOTAL		\$37.12	
CASH		\$15.00	
CHARGE		\$22.12	

To correct the last item you input and registered

OPERATION

RECEIPT

1	00	- 2	
2	00	÷ 4	
		÷ 4	Clearance
		ERR CORR CANCEL	
2		PLU/ S.DEPT	Correction of PLU No.
		ERR CORR CANCEL	
5		PLU/ S.DEPT	
1	5	PLU/ S.DEPT	Correction of sub- department unit price
6	00	PRICE	
		ERR CORR CANCEL	
1	5	PLU/ S.DEPT	
1	0	00	PRICE
		ERR CORR CANCEL	Correction of quantity
8		X / FOR DATE TIME	
4	00	÷ 4	
		ERR CORR CANCEL	
6		X / FOR DATE TIME	Correction of discount
4	00	÷ 4	
		ERR CORR CANCEL	
5	0	%-	
		ERR CORR CANCEL	Correction of refund item
		MD / ST	
		5	%-
RF	2	00	÷ 4
		ERR CORR CANCEL	
RF	2	2	0
		ERR CORR CANCEL	Correction of partial tender
		ERR CORR CANCEL	
		SUB TOTAL	
3	0	00	CA / AMT = / TEND
		ERR CORR CANCEL	
1	5	00	CA / AMT = / TEND
		ERR CORR CANCEL	
		CH	

REG	06-15-2002	11:40	
		000027	
DEPT02	T1	\$1.00	
DEPT04	T2	\$2.00	
DEPT04	T2	\$2.00	
ERR CORR		-2.00	
PLU0002	T2	\$1.20	
ERR CORR		-1.20	
PLU0005	T1	\$1.50	
PLU0015	T1	\$6.00	
ERR CORR		-6.00	
PLU0015	T1	\$10.00	
8	X	@4.00	
DEPT04	T2	\$32.00	
ERR CORR		-32.00	
6	X	@4.00	
DEPT04	T2	\$24.00	
ST		\$38.50	
50%			
%-		-19.25	
ERR CORR	*	\$19.25	
ST		\$38.50	
5%			
%-	*	-1.93	
REFUND		
DEPT04	T2	-2.00	
ERR CORR		\$2.00	
REFUND		
DEPT04	T2	-2.20	
TAX-AMT 1		\$11.87	
TAX 1		\$0.59	
TAX-AMT 2		\$22.50	
TAX 2		\$2.25	
TOTAL		\$37.21	
CASH		\$30.00	
ERR CORR		-30.00	
CASH		\$15.00	
CHARGE		\$22.21	

Basic Operations and Setups

To cancel all items in a transaction

OPERATION	RECEIPT
<p> 1 00 + 1 2 00 - 2 3 00 × 3 4 00 ÷ 4 MD/ST </p> <p>Pressing MD/ST key is necessary to cancel the transaction.</p> <p>ERR CORR. CANCEL</p>	<pre> REG 06-15-2002 11:45 000028 DEPT01 \$1.00 DEPT02 T1 \$2.00 DEPT03 T1T2 \$3.00 DEPT04 T2 \$4.00 CANCEL TTL </pre>

Important!

- Note that the number of items included in the transaction to be cancelled is limited (24 ~ 40 items), depending on the complexity of the transaction. If you try to cancel a transaction that exceeds the limit, an error occurs.
In case of occurrence of this error, register these items in the RF mode.
- You can program the cash register that this cancel operation is not allowed.

No sale registration

You can use the following procedure to open the drawer without registering a sale. This operation must be performed out of a sale.

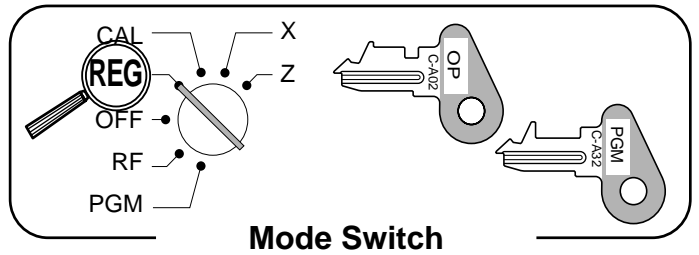

OPERATION	RECEIPT
<p> #/NS (NS) : Canada </p>	<pre> REG 06-15-2002 11:50 000029 #/NS </pre>

Printing the daily sales reset report

This report shows daily sales totals.

OPERATION

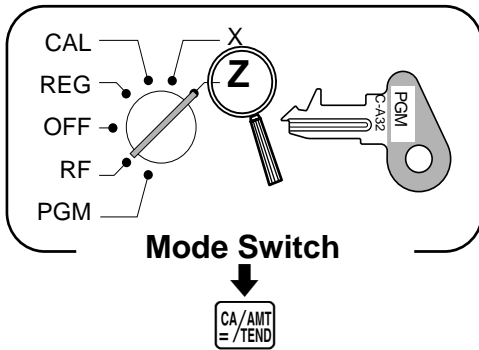

REPORT

Z	06-15-2002	12:00		Reset mode/date/time
			000030	Consecutive No.
0000	DAILY	Z	0001	Report code/report title/reset symbol/ reset counter
DEPT01	QT	15		Department descriptor/No. of items ^{*1}
		\$339.50		Department amount ^{*1}
DEPT02	QT	19		
		\$62.70		
DEPT03	QT	31		
		\$139.10		
DEPT04	QT	23		
		\$220.00		
NON-LINK DPT	QT	10		Non-link department No. of items
		\$94.90		Non-link department amount

GROSS TOTAL	QT	253		Gross No. of items
		\$1146.90		Gross sales amount
NET TOTAL	No	100		No. of customers
		\$1217.63		Net sales amount
CASH-INDW		\$903.06		Cash in drawer amount
CHARGE-INDW		\$197.17		Charge in drawer amount
CHECK-INDW		\$183.60		Check in drawer amount
TAX-AMT 1		\$732.56		Taxable amount 1 ^{*2}
TAX 1		\$43.96		Tax amount 1 ^{*2}
TAX-AMT 2		\$409.72		Taxable amount 2 ^{*2}
TAX 2		\$21.55		Tax amount 2 ^{*2}
TAX-AMT 3		\$272.50		Taxable amount 3 ^{*2}
TAX 3		\$8.18		Tax amount 3 ^{*2}
CANCEL TTL	No	2		Cancellation count
		\$108.52		Cancellation amount
RF-MODE TTL	No	2		Refund mode operation count ^{*3}
		\$3.74		Refund mode operation amount ^{*3}

CASH	No	81		Cash sales count
		\$836.86		Cash sales amount
CHARGE	No	10		Charge sales count
		\$197.17		Charge sales amount
CHECK	No	9		Check sales count
		\$183.60		Check sales amount
RC	No	2		Received on Account count
		\$78.00		Received on Account amount
PD	No	1		Paid out count
		\$6.80		Paid out amount
-	No	8		Subtraction count
		\$3.00		Subtraction amount
%-	No	10		Discount count
		\$4.62		Discount amount
%+	No	1		Premium count
		\$1.00		Premium amount
REFUND	No	7		Refund key count ^{*3}
		\$27.79		Refund key amount ^{*3}
ERR CORR	No	10		Error correction count
		\$12.76		Error correction amount
#/NS	No	5		No sale count

GRND TTL		\$0000001217.63		Non-resettable grand-sales total ^{*3}

*1 Zero totalled departments (the amount and item numbers are both zero) are not printed.

*2 Taxable amount and tax amount are printed only if the corresponding tax table is programmed.

*3 These items can be skipped by programming.

Convenient Operations and Setups

This section describes more sophisticated setups and operations that you can use to suit the needs of your retail environment.

Clerk control function

Clerk name printing on receipt/journal, and sales amounts summing by clerk.
To use clerk function, refer to page 47.

Clerk sign on and sign off

Any time you begin any registration, clerk sign on operation is necessary.

**REG/RF/
CAL/X/Z**
Mode Switch

Clerk sign on

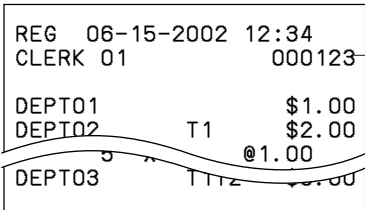
	OPERATION	RECEIPT
Signing clerk 1 on:	1 → <input type="text" value="CLK-#"/>	
Signing clerk 2 on:	2 → <input type="text" value="CLK-#"/>	
...	...	
Signing clerk 10 on:	1 0 → <input type="text" value="CLK-#"/>	

Clerk sign off

	OPERATION
Signing clerk off:	0 → <input type="text" value="CLK-#"/>

- The current clerk is also signed off whenever you set the mode switch to OFF position.

Important!

- The error code “E08” appears on the display whenever you try to perform a registration, a read/reset operation without signing on.
- The signed on clerk is also identified on the receipt/journal.

Post-finalization receipt format, General printing control, Compulsory, Machine features

About post-finalization receipt

The post-finalization receipt lets you issue a receipt after finalization of the transaction. Note that all of the following conditions must be satisfied.

- The receipt issuance status must be OFF.
- The transaction must be finalized in the REG or RF mode using the CA/AMT =/TEND, CH or CHK key.

Post-finalization receipt example

You can program the cash register to print the transaction total only (below Total format) or full details (below Detailed format) on the post-finalization receipt. Note that if the transaction contains more than 45 lines (including receipt header), the cash register prints in a Total format regardless of your programming.

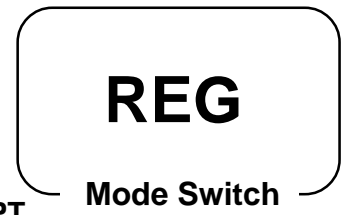

OPERATION

RECEIPT

Item 1	Unit price	\$10.00
	Quantity	1
	Dept.	2
	Taxable	(1)
Item 2	Unit price	\$20.00
	Quantity	1
	Dept.	4
	Taxable	(2)
Payment	Cash	\$32.50

(): Preset value

Receipt is not issued.

Post-finalization receipt is issued.

If "Automatic issue" is selected, no need to press key.

Total format

REG	06-15-2002	12:35
CLERK	01	000123
CASH		\$32.50

Detailed format

REG	06-15-2002	12:35
CLERK	01	000123
DEPT02	T1	\$10.00
DEPT04	T2	\$20.00
TAX-AMT 1		\$10.00
TAX 1		\$0.50
TAX-AMT 2		\$20.00
TAX 2		\$2.00
TOTAL		\$32.50
CASH		\$32.50
CHANGE		\$0.00

Important!

- You can issue only one post-finalization receipt per transaction.

Convenient Operations and Setups

Programming general printing control

Suppress printing of the subtotal line during tender operation.		No = 0 Yes = 1	<input type="checkbox"/> D ₈
Print the current time.	a	Yes = 0 No = 1	a+b+c = <input type="checkbox"/> D ₇
Skip the date on journal.	b	Yes = 0 No = 2	
Skip the consecutive number.	c	No = 0 Yes = 4	
Issue post receipt by Finalize key (automatic issue)/ Post receipt key (manual issue)	a	Manual = 0 Automatic = 2	a+b = <input type="checkbox"/> D ₆
Detail format/Total format in the post receipt	b	Detail = 0 Total = 4	
Print taxable amount.	a	Yes = 0 No = 1	a+b+c = <input type="checkbox"/> D ₅
Print tax symbols.	b	Yes = 0 No = 2	
Print number of item sold.	c	No = 0 Yes = 4	
Skip item lines on journal. (journal skip)	a	No = 0 Yes = 1	a+b+c = <input type="checkbox"/> D ₄
Print subtotal when the key is pressed.	b	No = 0 Yes = 2	
Time system: ① 24 hour system, ② 12 hour system	c	① = 0 ② = 4	
Digit separator symbol.	a	Comma = 0 Period = 1	a+b+c = <input type="checkbox"/> D ₃
Decimal symbol.	b	Period = 0 Comma = 2	
Journal compressed print (print by half height characters)	c	Yes = 0 No = 4	
Print hyphens before finalizing a transaction.	a	No = 0 Yes = 1	a+b = <input type="checkbox"/> D ₂
Print tax total on receipt and report.	b	No = 0 Yes = 2	
Print receipt by double height characters.		No = 0 Yes = 2	<input type="checkbox"/> D ₁

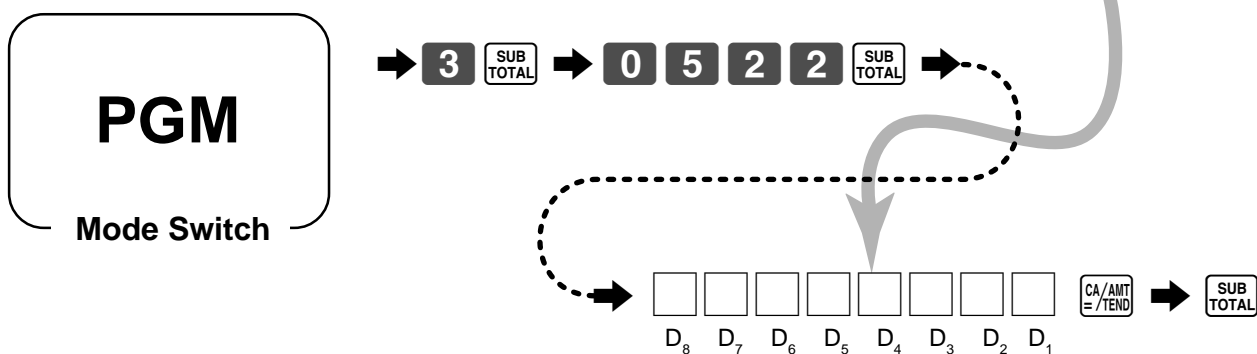

Programming compulsory and clerk control function

Force <input type="checkbox"/> SUB TOTAL operation before finalization.	a	No = 0 Yes = 2	a+b = <input type="checkbox"/> D ₈
Force a money declaration before allowing a daily read/reset and financial read operation.	b	No = 0 Yes = 4	
Always "000"			<input type="checkbox"/> 0 ~ <input type="checkbox"/> 0 D ₇ ~D ₅
Clear the key buffer when a receipt is issued.	a	No = 0 Yes = 1	a+b = <input type="checkbox"/> D ₄
Perform auto sign-off when a receipt/report is issued.	b	No = 0 Yes = 2	
Display "seconds" during time display.		No = 0 Yes = 2	<input type="checkbox"/> D ₃
Reset the consecutive number when the daily reset report is issued.	a	Yes = 0 No = 1	a+b = <input type="checkbox"/> D ₂
Prohibit cancel operation.	b	No = 0 Yes = 2	
Assign <input type="checkbox"/> 00 as "00" or "000".	a	"00" = 0 "000" = 1	a+b = <input type="checkbox"/> D ₁
Use "clerk" function: (If you select "Yes", sign on operation is necessary before registration.)	b	No = 0 Yes = 4	

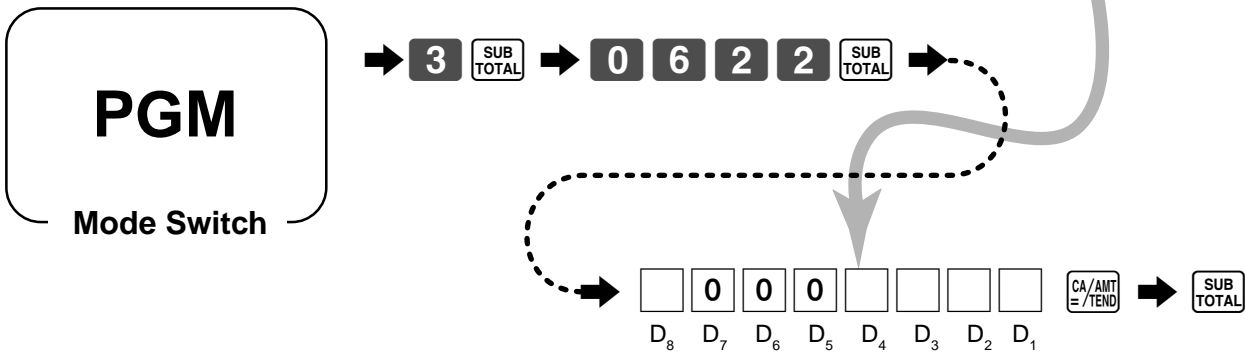

Convenient Operations and Setups

Programming read/reset report printing control

Print the first and the last consecutive number of the day (consecutive No. range) on the daily sales reset report.		No = 0 Yes = 4	<input type="checkbox"/> D ₆
Skip zero total lines on department and transaction read/reset report.	a	Yes = 0 No = 1	a+b+c = <input type="checkbox"/> D ₅
Skip zero total lines on PLU read/reset report.	b	Yes = 0 No = 2	
Skip zero total lines on hourly sales report.	c	Yes = 0 No = 4	
Print the sales ratio on read/reset report.	a	No = 0 Yes = 1	a+b = <input type="checkbox"/> D ₄
Suppress printing of the non-resettable grand total on the daily reset report.	b	No = 0 Yes = 2	a+b = <input type="checkbox"/> D ₃
Suppress printing of RF total and count (both RF mode and RF key) on the read/reset report.	a	No = 0 Yes = 1	
Print tax rate with tax totalizer.	b	No = 0 Yes = 2	
Always "00"			<input type="checkbox"/> 0 <input type="checkbox"/> 0 D ₂ D ₁

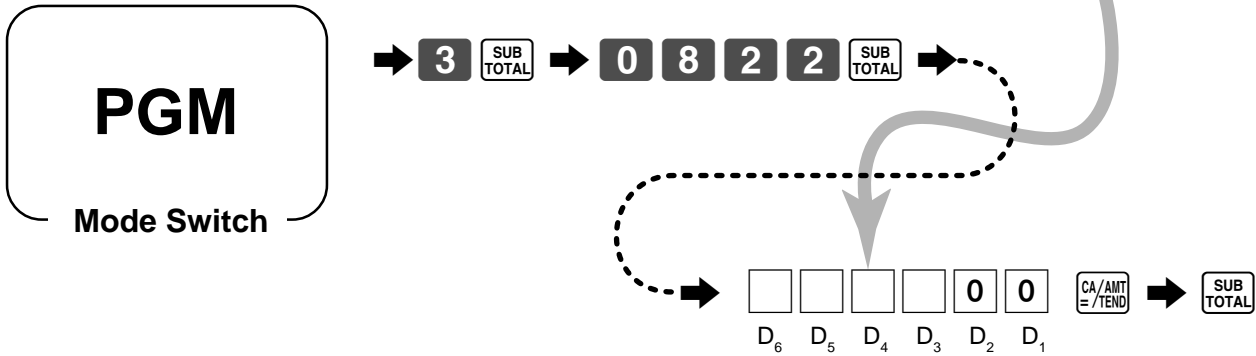

Setting a store/machine number

You can set a 4-digit machine number to identify your machine. The machine number is printed on receipts/journal for each transaction.

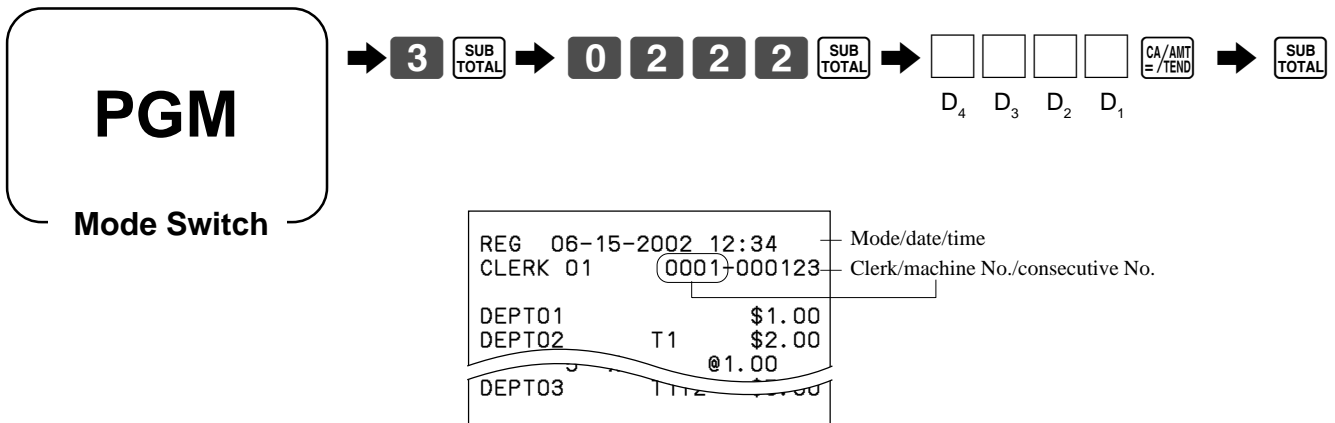

Programming to clerk

You can program up to 4-digit assigning number (clerk number) and trainee status of clerk (i.e. training cashier) for each clerk.

Programming clerk number

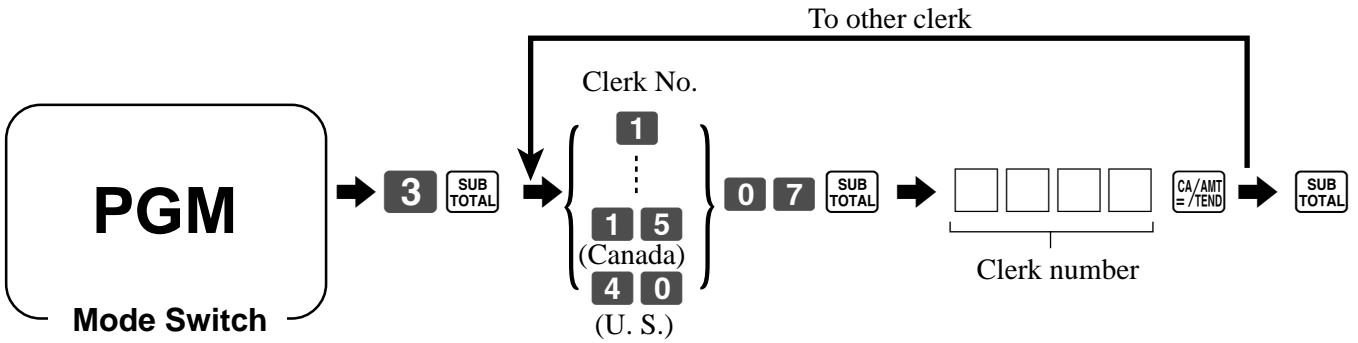

Programming trainee status of clerk

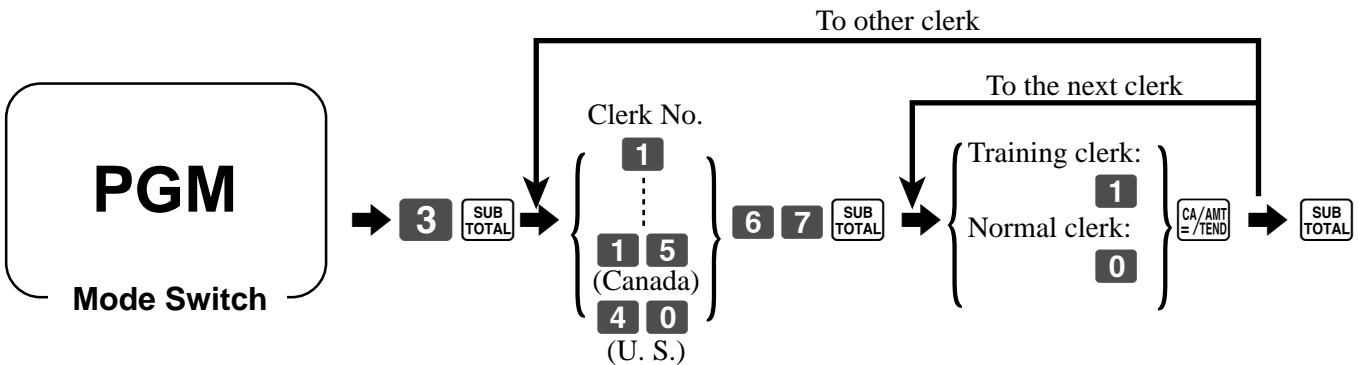

When a training clerk signs on, the cash register automatically enters the training mode. In the training mode, no operations are affected on any totalizers nor counters. The training mode symbols are printed in the columns of receipt entries produced in the training mode. The cash register exits the training mode when the training clerk signs off.

Programming descriptors and messages

The following descriptors and messages can be programmed;

- Report descriptor (such as gross total, net total, cash in drawer...)
- Grand total
- Special character (such as mode symbol, taxable symbol...)
- Read/reset report title
- Clerk name
- PLU item descriptor
- Messages (Logo, commercial and bottom message)
- Function key descriptor
- Department key descriptor

Programming report descriptor, grand total, special character, report title, receipt message and clerk name

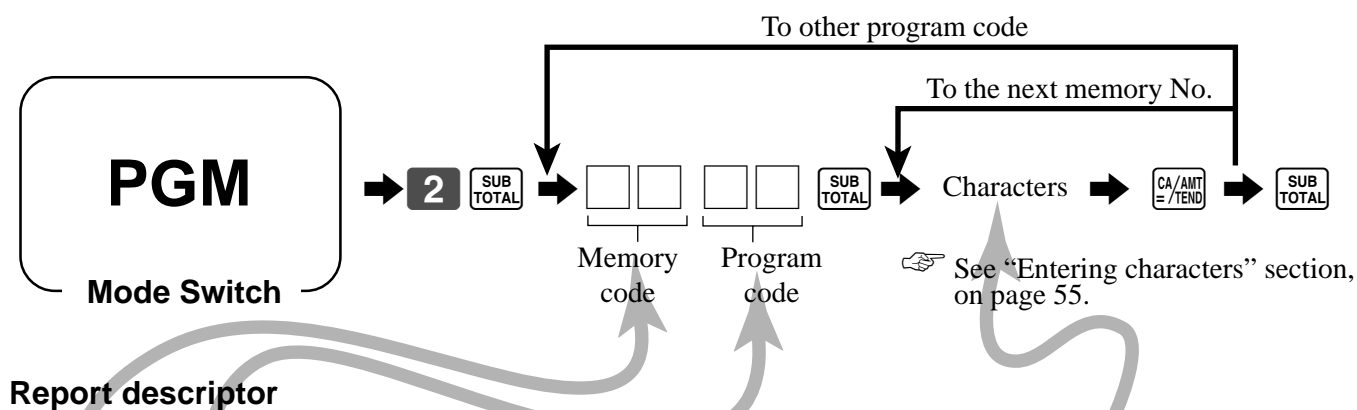

Report descriptor

Memory No.	Program code	Contents	Initial character	Yours
01	01	Gross total	GROSS TOTAL	
02		Net total	NET TOTAL	
03		Cash in drawer	CASH-INDW	
04		Charge in drawer	CHARGE-INDW	
05		Check in drawer	CHECK-INDW	
06		not used		
07		Foreign currency cash in drawer	CE-CASH 1	
08		Foreign currency check in drawer	CE-CHECK 1	
09		not used		
10		not used		
11		Taxable amount 1	TAX-AMT 1	
12		Tax 1	TAX 1	
13		Taxable amount 2	TAX-AMT 2	
14		Tax 2	TAX 2	
15		Taxable amount 3	TAX-AMT 3	
16		Tax 3	TAX 3	
17		Taxable amount 4	TAX-AMT 4	
18		Tax 4	TAX 4	
19		not used		
20		not used		
21		not used		
22		Cancellation total	CANCEL TTL	
23		Refund mode total	RF-MODE TTL	
24		not used		
25		not used		
26		Calculator mode count	CALCULATOR	
27		Non-link department total	NON-LINK DPT	

Grand total, special character

Memory No.	Program code	Contents	Initial character	Yours					
01	20	Grand total	GRND TTL						
01	23	Amount/@/No./Quantity (2 each)	\$ @NoQT						
02		Item count/Customer (2 each)	NoCT						
03		Multiplication/Split pricing (2 each)	X /						
04		Taxable status 1 ~ 4 (2 each)	T1T2T3T4						
05		All taxable status	*						
06		Foreign currency symbol (2)	*						
07		REG mode/Refund mode (4 each)	REG RF						
08		not used (4)/Program mode (3)	PGM n (n=1~6)						
09		X/Z mode (4 each)	X Z						
10		CAL mode (4)	CAL						
11		Training mode	****						
12		Training symbol	*****						
13		Total symbol (Tendering)	TOTAL						
14		Change symbol	CHANGE						
15		not used							
16		Total symbol (Post receipt)	TOTAL						
17		Total symbol (% registration)	ST						
18		AM, PM (3 each)	AM PM						
19		Tax total	TAX						
20		not used							
21		not used							
22		not used							
23		not used							
24		not used							
25		not used							
26			Total message on report	TOTAL					

Report title

Memory No.	Program code	Contents	Initial character	Yours					
01	24	Daily report title	DAILY						
02		PLU report title	PLU						
03		Hourly sales report title	HOURLY						
04		Group report title	GROUP						
05		Not used	CLERK						
06		Financial report title	FLASH						
07		Monthly report title	MONTHLY						
08		Periodic-1 report title	PERIODIC-1						
09		Periodic-2 report title	PERIODIC-2						
10		Individual report title							
11		Not used							
12		Not used							

Clerk name

Memory No.	Program code	Contents	Initial character	Yours					
01	07	Clerk 01	CLERK 01						
02		Clerk 02	CLERK 02						
03		Clerk 03	CLERK 03						
04		Clerk 04	CLERK 04						
		Clerk 05	CLERK 05						

Convenient Operations and Setups

Receipt message

Refer to “Programming receipt message/logo stamp control function” on page 54.

Memory No.	Program code	Contents	Initial character	Yours
01	32	1st line of logo message		
02		2nd line of logo message	YOUR RECEIPT	
03		3rd line of logo message	THANK YOU	
04		4th line of logo message	CALL AGAIN	
05		5th line of logo message		
06		6th line of logo message		
07		1st line of commercial message		
08		2nd line of commercial message		
09		3rd line of commercial message		
10		4th line of commercial message		
11		5th line of commercial message		
12		1st line of bottom message		
13		2nd line of bottom message		
14		3rd line of bottom message		
15		4th line of bottom message		
16		5th line of bottom message		

Programming department key descriptor

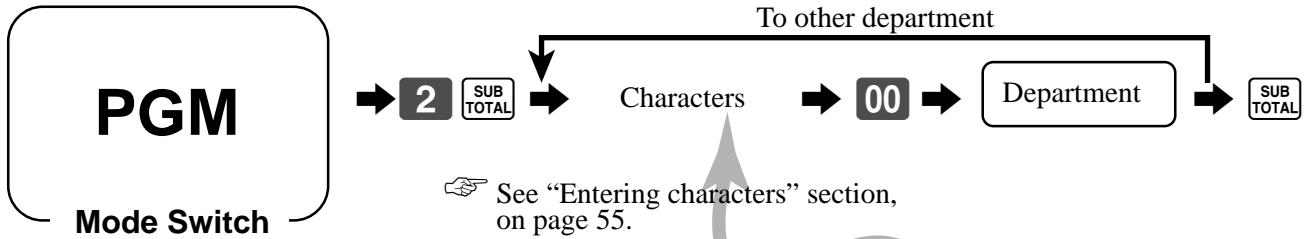

Contents	Initial character	Yours
Department 01	DEPT01	
Department 02	DEPT02	
Department 03	DEPT03	
Department 04	DEPT04	
Department 05	DEPT05	
Department 06	DEPT06	
Department 07	DEPT07	
Department 08	DEPT08	
Department 09	DEPT09	
Department 10	DEPT10	

Department designation

Department

for the U.S.

- $\begin{matrix} 49/73 \\ + \\ 25 \\ 1 \end{matrix}$ (Dept.1) $\begin{matrix} \text{DEPT} \\ \text{SHIFT} \end{matrix}$ $\begin{matrix} \text{DEPT} \\ \text{SHIFT} \end{matrix}$ $\begin{matrix} 49/73 \\ + \\ 25 \\ 1 \end{matrix}$ (Dept.49)
- $\begin{matrix} 50/74 \\ - \\ 26 \\ 2 \end{matrix}$ (Dept.2) $\begin{matrix} \text{DEPT} \\ \text{SHIFT} \end{matrix}$ $\begin{matrix} \text{DEPT} \\ \text{SHIFT} \end{matrix}$ $\begin{matrix} 50/74 \\ - \\ 26 \\ 2 \end{matrix}$ (Dept.50)
- ...
- $\begin{matrix} 72/96 \\ 48 \\ 24 \end{matrix}$ (Dept.24) $\begin{matrix} \text{DEPT} \\ \text{SHIFT} \end{matrix}$ $\begin{matrix} \text{DEPT} \\ \text{SHIFT} \end{matrix}$ $\begin{matrix} 72/96 \\ 48 \\ 24 \end{matrix}$ (Dept.72)
- $\begin{matrix} \text{DEPT} \\ \text{SHIFT} \end{matrix}$ $\begin{matrix} 49/73 \\ + \\ 25 \\ 1 \end{matrix}$ (Dept.25) $\begin{matrix} \text{DEPT} \\ \text{SHIFT} \end{matrix}$ $\begin{matrix} \text{DEPT} \\ \text{SHIFT} \end{matrix}$ $\begin{matrix} \text{DEPT} \\ \text{SHIFT} \end{matrix}$ $\begin{matrix} 49/73 \\ + \\ 25 \\ 1 \end{matrix}$ (Dept.73)
- ...
- $\begin{matrix} \text{DEPT} \\ \text{SHIFT} \end{matrix}$ $\begin{matrix} 72/96 \\ 48 \\ 24 \end{matrix}$ (Dept.48) $\begin{matrix} \text{DEPT} \\ \text{SHIFT} \end{matrix}$ $\begin{matrix} \text{DEPT} \\ \text{SHIFT} \end{matrix}$ $\begin{matrix} \text{DEPT} \\ \text{SHIFT} \end{matrix}$ $\begin{matrix} 72/96 \\ 48 \\ 24 \end{matrix}$ (Dept.96)

for Canada

- $\begin{matrix} + \\ 1 \end{matrix}$ (Dept.1)
- $\begin{matrix} - \\ 2 \end{matrix}$ (Dept.2)
- ...
- $\begin{matrix} 24 \end{matrix}$ (Dept.24)

Programming PLU descriptor

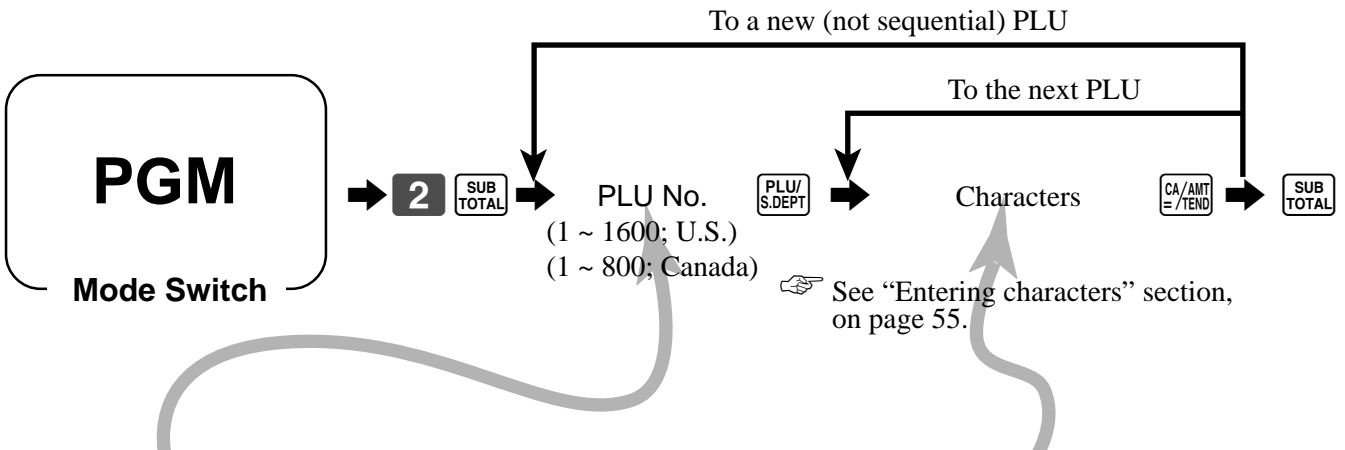

PLU No.	Contents	Initial character	Yours																				
001	PLU001	PLU0001																					
002	PLU002	PLU0002																					
003	PLU003	PLU0003																					
004	PLU004	PLU0004																					
005	PLU005	PLU0005																					
006	PLU006	PLU0006																					
007	PLU007	PLU0007																					
008	PLU008	PLU0008																					
009	PLU009	PLU0009																					
010	PLU010	PLU0010																					
011	PLU011	PLU0011																					
012	PLU012	PLU0012																					
013	PLU013	PLU0013																					
014	PLU014	PLU0014																					
015	PLU015	PLU0015																					
016	PLU016	PLU0016																					
017	PLU017	PLU0017																					
018	PLU018	PLU0018																					
019	PLU019	PLU0019																					
020	PLU020	PLU0020																					
021	PLU021	PLU0021																					
022	PLU022	PLU0022																					
023	PLU023	PLU0023																					
024	PLU024	PLU0024																					
025	PLU025	PLU0025																					
026	PLU026	PLU0026																					
027	PLU027	PLU0027																					
028	PLU028	PLU0028																					
029	PLU029	PLU0029																					
030	PLU030	PLU0030																					
031	PLU031	PLU0031																					
032	PLU032	PLU0032																					
033	PLU033	PLU0033																					
034	PLU034	PLU0034																					
035	PLU035	PLU0035																					
036	PLU036	PLU0036																					
037	PLU037	PLU0037																					
038	PLU038	PLU0038																					
039	PLU039	PLU0039																					

Convenient Operations and Setups

Programming function key descriptor

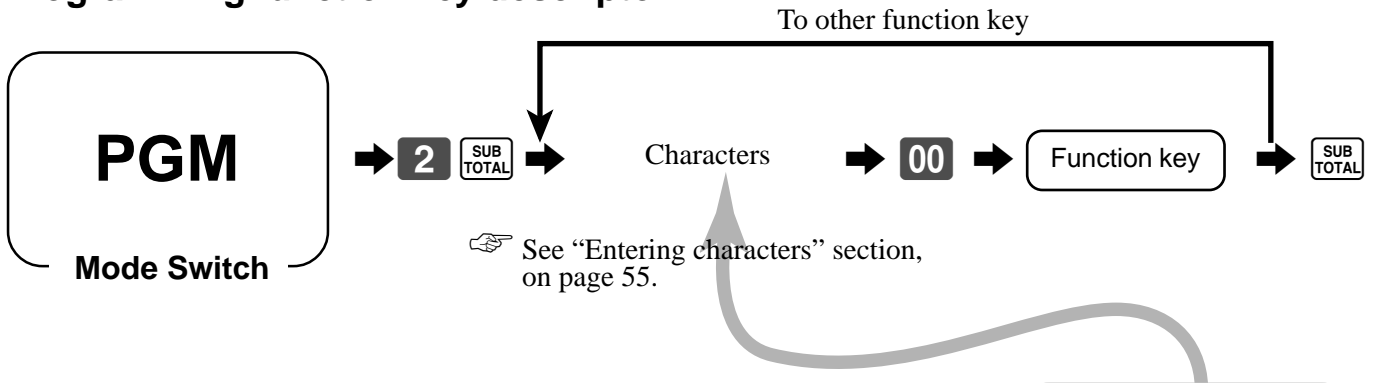

Contents	Initial character	Yours
Cash/amount tendered	CASH	
Charge	CHARGE	
Check	CHECK	
Received on account	RC	
Paid out	PD	
Minus	-	
Discount	%-	
Premium	%+	
Refund	REFUND	
Error correct/Cancel	ERR CORR	
Non-add/No sale	#/NS	
Non-add	#	
No sale	NS	
Post receipt	P/G RCT	
Currency exchange	CURR EXG	
MD/ST	MDST	
Price	PRICE	
Open	OPEN	
Clerk No.	SIGN ON	
Subtotal	TL	
Receipt on/off	R ON/OFF	
Multiplication/For/Date time	QTY/FOR	

Programming receipt message/logo stamp control function

① Print graphic logo (electronic logo stamp), ② Logo message	a	① = 0 ② = 1	a+b+c = <input type="text"/> D ₈
Print commercial message.	b	No = 0 Yes = 2	
Print bottom message.	c	No = 0 Yes = 4	
Always "0000000"			<input type="text"/> 0 ~ <input type="text"/> 0 D ₇ ~D ₁

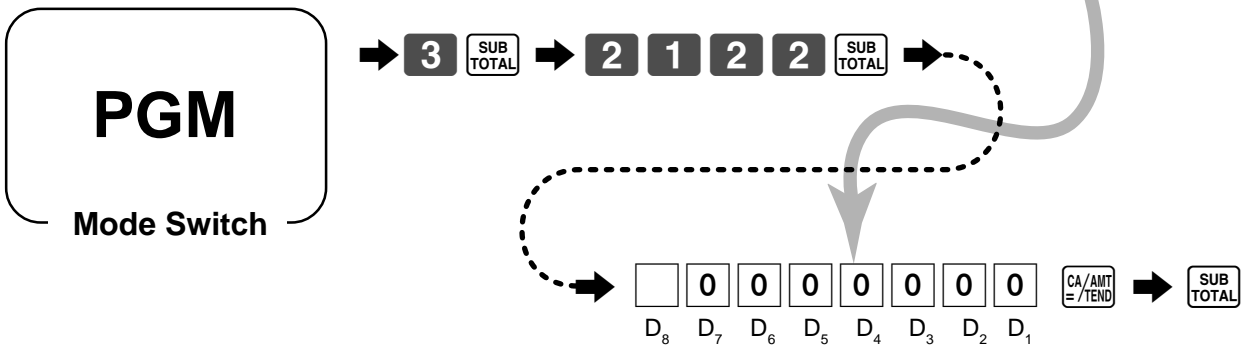

Convenient Operations and Setups

Entering characters by code

Every time you enter a character, choose character codes by the character code list (below) and press the  key to settle it.

Example:

Input “  p p l e  u i c e ”,
 enter “ 255  65  112  112  108  101  32  74  117  105  99  101  ”.

Character code list

Chara	Code	Chara	Code	Chara	Code	Chara	Code	Chara	Code	Chara	Code	Chara	Code
Space	32	0	48	@	64	P	80	'	96	p	112	Ç	128
!	33	1	49	A	65	Q	81	a	97	q	113	ü	129
"	34	2	50	B	66	R	82	b	98	r	114	é	130
#	35	3	51	C	67	S	83	c	99	s	115	â	131
\$	36	4	52	D	68	T	84	d	100	t	116	ä	132
%	37	5	53	E	69	U	85	e	101	u	117	à	133
&	38	6	54	F	70	V	86	f	102	v	118	å	134
'	39	7	55	G	71	W	87	g	103	w	119	ç	135
(40	8	56	H	72	X	88	h	104	x	120	ê	136
)	41	9	57	I	73	Y	89	i	105	y	121	ë	137
*	42	:	58	J	74	Z	90	j	106	z	122	è	138
+	43	;	59	K	75	[91	k	107	{	123	ï	139
,	44	<	60	L	76	\	92	l	108		124	î	140
-	45	=	61	M	77]	93	m	109	}	125	ì	141
.	46	>	62	N	78	^	94	n	110	~	126	Ä	142
/	47	?	63	O	79	_	95	o	111		127	Å	143
É	144	á	160	■	176	ℓ	192	ø	208	Ó	224	-	240
æ	145	í	161	■	177	⊥	193	ð	209	ß	225	±	241
Æ	146	ó	162	■	178	⊥	194	Ê	210	Ô	226	_	242
ô	147	ú	163		179	†	195	Ë	211	Ò	227	3/4	243
ö	148	ñ	164	†	180	—	196	È	212	ö	228	¶	244
ò	149	Ñ	165	À	181	†	197	€	213	Õ	229	§	245
û	150	ª	166	Â	182	ã	198	Í	214	μ	230	÷	246
ù	151	º	167	À	183	Ã	199	Î	215	þ	231	,	247
ÿ	152	¿	168	©	184	ℓ	200	Ï	216	Þ	232	°	248
Ö	153	®	169	†	185	⌈	201	⋈	217	Ú	233	¨	249
Ü	154	¬	170		186	⊥	202	⌈	218	Û	234	•	250
ø	155	1/2	171	⌈	187	⊥	203	■	219	Ù	235	¹	251
£	156	1/4	172	⋈	188	†	204	■	220	ý	236	³	252
Ø	157	¡	173	¢	189	—	205		221	Ý	237	²	253
×	158	«	174	¥	190	†	206	ì	222	—	238	■	254
f	159	»	175	ı	191	¤	207	■	223	'	239	Double size	255

 : for R/J printer only.

The “Ä”, “Ö”, “Ü” characters are displayed as “A”, “O”, “U”.

Department key feature programming

There are two different methods you can use to assign features to department keys. With “Batch feature programming”, you can use a single operation to assign multiple features. “Individual feature programming”, on the other hand, let you assign features one-by-one. This method is recommended for programming of special features to individual department keys.

Batch feature programming

When using this procedure to assign multiple features to departments, use 9-digit codes that you create using the following procedure

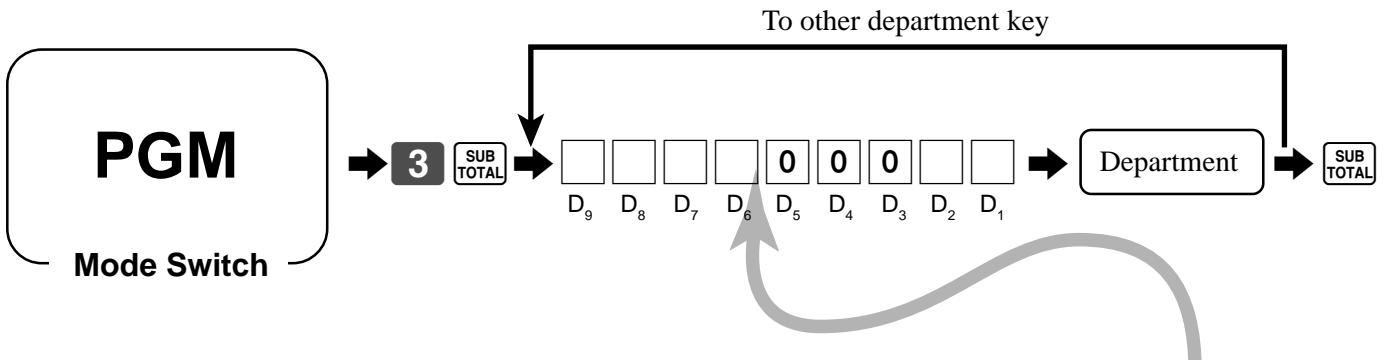

Negative department	a	No = 0 Yes = 2	a+b = <input type="text"/> D ₉
Hash department	b	No = 0 Yes = 4	
Single item sale		No = 0 Yes = 1	<input type="text"/> D ₈
High digit limit specification		Significant number	<input type="text"/> D ₇
Taxable status 1 (for the U.S. model)	a	No = 0 Yes = 1	a+b+c = <input type="text"/> D ₆
Taxable status 2 (for the U.S. model)	b	No = 0 Yes = 2	
Taxable status 3 (for the U.S. model)	c	No = 0 Yes = 4	
Taxable status (for the Canadian model) Non tax = 0, Taxable 1 = 1, Taxable 2 = 2, Taxable 3 = 3, Taxable 4 = 4, Taxable 1 & 2 = 5, Taxable 1 & 3 = 6, Taxable 1 & 4 = 7		Significant number	<input type="text"/> D ₆
Always “000”			<input type="text"/> 0 ~ <input type="text"/> 0 D ₅ ~ D ₃
Group link (00 ~ 50)		Significant numbers	<input type="text"/> <input type="text"/> D ₂ D ₁

Department designation

Department

for the U.S.

$\frac{49}{23} + \frac{73}{23}$ (Dept.1)	DEPT SHIFT $\frac{49}{23} + \frac{73}{23}$ (Dept.49)
$\frac{50}{26} - \frac{74}{26}$ (Dept.2)	DEPT SHIFT $\frac{50}{26} - \frac{74}{26}$ (Dept.50)
:	:
$\frac{72}{48} \frac{96}{24}$ (Dept.24)	DEPT SHIFT $\frac{72}{48} \frac{96}{24}$ (Dept.72)
DEPT SHIFT $\frac{49}{25} + \frac{73}{25}$ (Dept.25)	DEPT SHIFT $\frac{49}{25} + \frac{73}{25}$ (Dept.73)
:	:
DEPT SHIFT $\frac{72}{48} \frac{96}{24}$ (Dept.48)	DEPT SHIFT $\frac{72}{48} \frac{96}{24}$ (Dept.96)

for Canada

<input type="text"/> + 1 (Dept.1)
<input type="text"/> - 2 (Dept.2)
:
<input type="text"/> 24 (Dept.24)

Convenient Operations and Setups

Individual feature programming

With this procedure, you can assign individual features to specific departments. Please select the command code of the contents you want to program, and follow the procedure below.

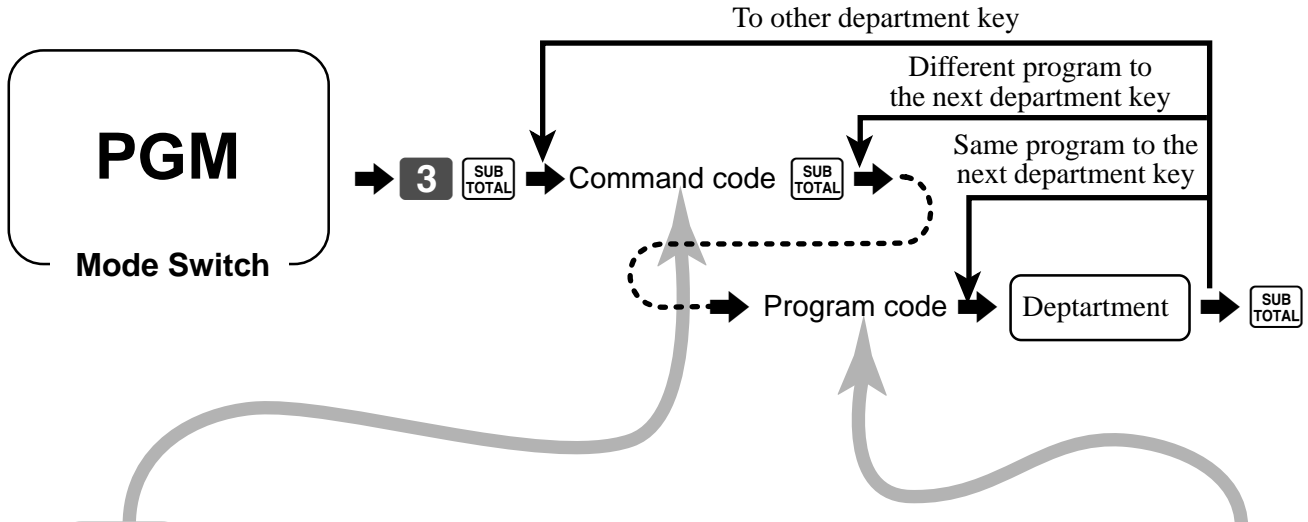

Command code	Contents/selection			Program code
0166	Negative department	a	No = 0 Yes = 2	a+b = <input type="text"/>
	Hash department	b	No = 0 Yes = 4	
1866	Single item sale		No = 0 Yes = 1	<input type="text"/>
1566	High digit limit specification		Significant number	<input type="text"/>
0366	Taxable status 1 (for the U.S. model)	a	No = 0 Yes = 1	a+b+c = <input type="text"/>
	Taxable status 2 (for the U.S. model)	b	No = 0 Yes = 2	
	Taxable status 3 (for the U.S. model)	c	No = 0 Yes = 4	
	Taxable status (for the Canadian model) Non tax = 0, Taxable 1 = 1, Taxable 2 = 2, Taxable 3 = 3, Taxable 4 = 4, Taxable 1 & 2 = 5, Taxable 1 & 3 = 6, Taxable 1 & 4 = 7			Significant number
1166	Group link (00 ~ 50)		Significant numbers	<input type="text"/> <input type="text"/>

To program a unit price to a department key, please refer the page 27.

Department designation

Department

for the U.S.

- $\frac{49}{73} \frac{25}{1} +$ (Dept.1)
- $\frac{50}{74} \frac{26}{2} -$ (Dept.2)
- ⋮
- $\frac{72}{96} \frac{48}{24}$ (Dept.24)
- DEPT SHIFT $\frac{49}{73} \frac{25}{1} +$ (Dept.25)
- ⋮
- DEPT SHIFT $\frac{72}{96} \frac{48}{24}$ (Dept.48)
- DEPT SHIFT DEPT SHIFT $\frac{49}{73} \frac{25}{1} +$ (Dept.49)
- DEPT SHIFT DEPT SHIFT $\frac{50}{74} \frac{26}{2} -$ (Dept.50)
- ⋮
- DEPT SHIFT DEPT SHIFT $\frac{72}{96} \frac{48}{24}$ (Dept.72)
- DEPT SHIFT DEPT SHIFT DEPT SHIFT $\frac{49}{73} \frac{25}{1} +$ (Dept.73)
- ⋮
- DEPT SHIFT DEPT SHIFT DEPT SHIFT $\frac{72}{96} \frac{48}{24}$ (Dept.96)

for Canada

- $\frac{+ 1}{- 2}$ (Dept.1)
- $\frac{- 2}{+ 1}$ (Dept.2)
- ⋮
- $\frac{24}{- 24}$ (Dept.24)

PLU feature programming

There are two different methods you can use to assign features to PLUs. With “Batch feature programming”, you can use a single operation to assign multiple features. “Individual feature programming”, on the other hand, let you assign features one-by-one. This method is recommended for programming of special features to individual PLUs.

Batch feature programming

When using this procedure to assign multiple features to PLUs, use 9-digit codes that you create using the following procedure.

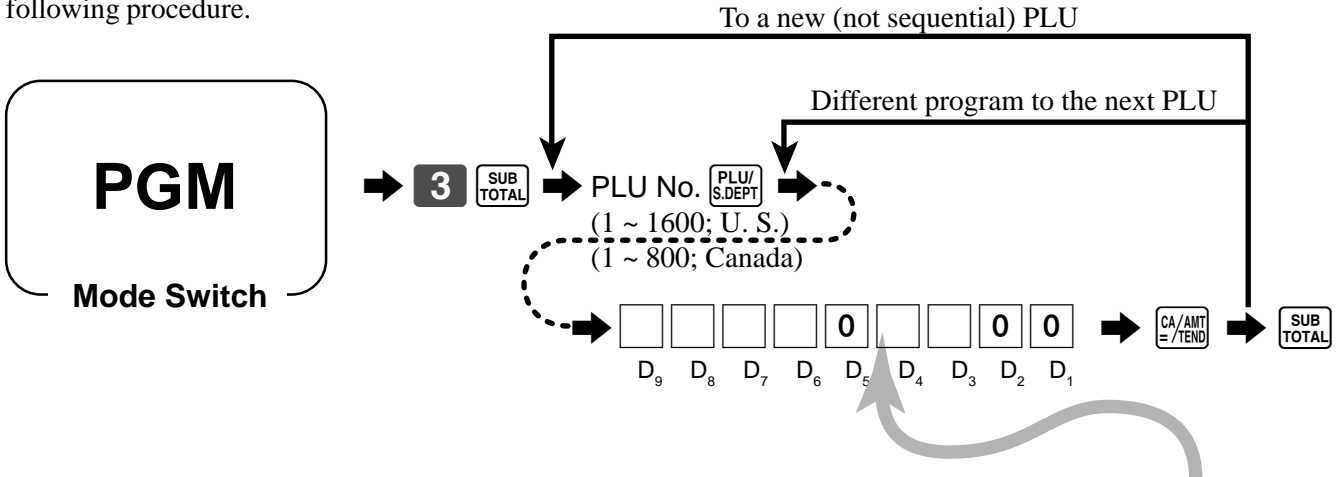

Negative PLU	a	No = 0 Yes = 2	a+b = <input type="text"/> D ₉
Hash PLU	b	No = 0 Yes = 4	
Single item sale	a	No = 0 Yes = 1	a+b = <input type="text"/> D ₈
Treat as subdepartment/PLU.	b	PLU = 0 Subdept. = 4	
High digit limit specification (for subdepartment)		Significant number	<input type="text"/> D ₇
Taxable status 1 (for the U.S. model)	a	No = 0 Yes = 1	a+b+c = <input type="text"/> D ₆
Taxable status 2 (for the U.S. model)	b	No = 0 Yes = 2	
Taxable status 3 (for the U.S. model)	c	No = 0 Yes = 4	
Taxable status (for the Canadian model) Non tax = 0, Taxable 1 = 1, Taxable 2 = 2, Taxable 3 = 3, Taxable 4 = 4, Taxable 1 & 2 = 5, Taxable 1 & 3 = 6, Taxable 1 & 4 = 7		Significant number	<input type="text"/> D ₆
Always “0”			<input type="text"/> 0 D ₅
Department link (00 ~ 96; U.S., 00 ~ 24; Canada)		Significant numbers	<input type="text"/> <input type="text"/> D ₄ D ₃
Always “00”			<input type="text"/> 0 <input type="text"/> 0 D ₂ D ₁

Convenient Operations and Setups

Individual feature programming

With this procedure, you can assign individual features to specific PLUs. Please select the command code of the contents you want to program, and follow the procedure below.

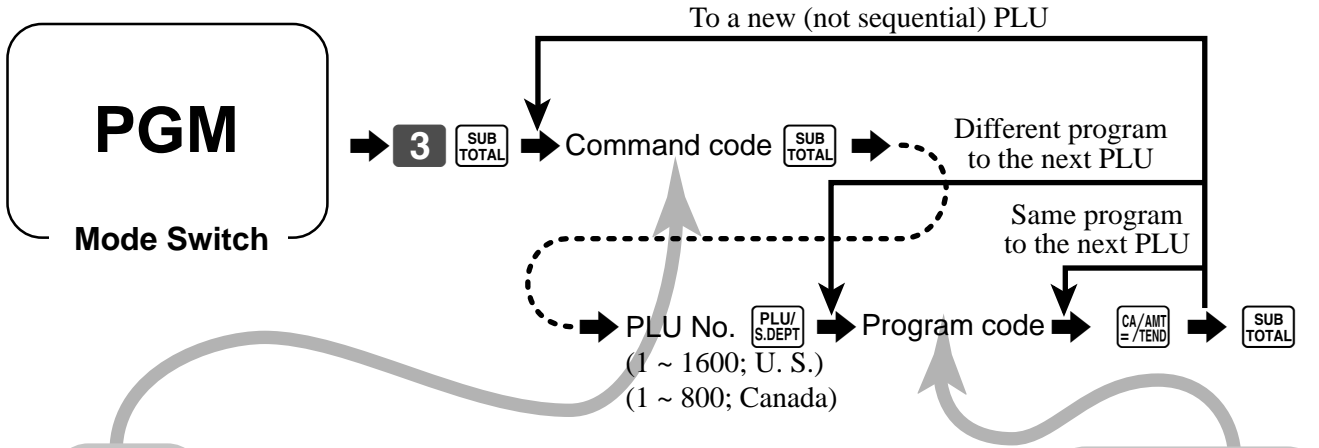

Command code	Contents/selection			Program code
0166	Negative PLU	a	No = 0 Yes = 2	a+b = <input type="text"/>
	Hash PLU	b	No = 0 Yes = 4	
1866	Single item sale	a	No = 0 Yes = 1	a+b = <input type="text"/>
	Treat as subdepartment (If "No", treat as PLU.)	b	No = 0 Yes = 4	
1566	High digit limit specification		Significant number	<input type="text"/>
0366	Taxable status 1 (for the U.S. model)	a	No = 0 Yes = 1	a+b+c = <input type="text"/>
	Taxable status 2 (for the U.S. model)	b	No = 0 Yes = 2	
	Taxable status 3 (for the U.S. model)	c	No = 0 Yes = 4	
	Taxable status (for the Canadian model) Non tax = 0, Taxable 1 = 1, Taxable 2 = 2, Taxable 3 = 3, Taxable 4 = 4, Taxable 1 & 2 = 5, Taxable 1 & 3 = 6, Taxable 1 & 4 = 7			Significant number
1166	Department link (00 ~ 96; U.S., 00 ~ 24; Canada)		Significant numbers	<input type="text"/> <input type="text"/> <input type="text"/> <input type="text"/>

To program a unit price to a PLU or a subdepartment, please refer to the page 29.

Registering example

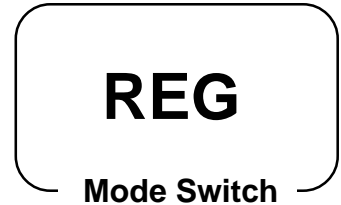

Locking out and releasing high digit limitation

	OPERATION	RECEIPT														
<table border="1" style="width: 100%; border-collapse: collapse;"> <tr> <td rowspan="5" style="text-align: center;">Item</td> <td>Unit price</td> <td style="text-align: right;">\$10.50</td> </tr> <tr> <td>Quantity</td> <td style="text-align: center;">1</td> </tr> <tr> <td>Dept.</td> <td style="text-align: center;">2</td> </tr> <tr> <td>Taxable</td> <td style="text-align: center;">(1)</td> </tr> <tr> <td>Max. digit</td> <td style="text-align: center;">(3)</td> </tr> <tr> <td>Payment</td> <td>Cash</td> <td style="text-align: right;">\$20.00</td> </tr> </table> <p>(): Preset value</p>	Item	Unit price	\$10.50	Quantity	1	Dept.	2	Taxable	(1)	Max. digit	(3)	Payment	Cash	\$20.00	<div style="margin-bottom: 10px;"> 1 0 5 0 - 2 </div> <p>ERROR ALARM (Exceeding max. digits)</p> <div style="margin-bottom: 10px;"> C <small>CAC</small> </div> <div style="margin-bottom: 10px;"> OPEN </div> <p> Cancels limitations for next entry</p> <div style="margin-bottom: 10px;"> 1 0 5 0 - 2 </div> <div style="margin-bottom: 10px;"> SUB <small>TOTAL</small> </div> <div style="margin-bottom: 10px;"> 2 0 00 CA/AMT <small>=/TEND</small> </div>	<pre> REG 06-15-2002 12:40 000030 DEPT02 T1 \$10.50 TAX-AMT 1 \$10.50 TAX 1 \$0.53 TOTAL \$ 11.03 CASH \$20.00 CHANGE \$8.97 </pre>
Item		Unit price	\$10.50													
		Quantity	1													
		Dept.	2													
		Taxable	(1)													
	Max. digit	(3)														
Payment	Cash	\$20.00														

Single item sales items

You can issue a receipt by simply touching the single item sales department or PLU. The following examples show how you register single-item-sale departments. Registration of single item sale PLUs is identical.

Single item

	OPERATION	RECEIPT											
<table border="1" style="width: 100%; border-collapse: collapse;"> <tr> <td rowspan="5" style="text-align: center;">Item</td> <td>Unit price</td> <td style="text-align: right;">\$2.00</td> </tr> <tr> <td>Quantity</td> <td style="text-align: center;">1</td> </tr> <tr> <td>Dept.</td> <td style="text-align: center;">4</td> </tr> <tr> <td>Taxable</td> <td style="text-align: center;">(2)</td> </tr> <tr> <td>Sales status</td> <td style="text-align: center;">(Single item)</td> </tr> </table> <p>(): Preset value</p>	Item	Unit price	\$2.00	Quantity	1	Dept.	4	Taxable	(2)	Sales status	(Single item)	<div style="margin-bottom: 10px;"> 2 00 ÷ 4 </div>	<pre> REG 06-15-2002 12:45 CLERK 01 000031 DEPT04 T2 \$2.00 TAX-AMT 2 \$2.00 TAX 2 \$0.20 CASH \$2.20 </pre>
Item		Unit price	\$2.00										
		Quantity	1										
		Dept.	4										
		Taxable	(2)										
	Sales status	(Single item)											

Multiple item sale

	OPERATION	RECEIPT																									
<table border="1" style="width: 100%; border-collapse: collapse;"> <tr> <td rowspan="5" style="text-align: center;">Item 1</td> <td>Unit price</td> <td style="text-align: right;">\$2.00</td> </tr> <tr> <td>Quantity</td> <td style="text-align: center;">1</td> </tr> <tr> <td>Dept.</td> <td style="text-align: center;">2</td> </tr> <tr> <td>Taxable</td> <td style="text-align: center;">(2)</td> </tr> <tr> <td>Sales status</td> <td style="text-align: center;">(Normal)</td> </tr> <tr> <td rowspan="5" style="text-align: center;">Item 2</td> <td>Unit price</td> <td style="text-align: right;">\$2.00</td> </tr> <tr> <td>Quantity</td> <td style="text-align: center;">1</td> </tr> <tr> <td>Dept.</td> <td style="text-align: center;">4</td> </tr> <tr> <td>Taxable</td> <td style="text-align: center;">(2)</td> </tr> <tr> <td>Sales status</td> <td style="text-align: center;">(Single item)</td> </tr> <tr> <td>Payment</td> <td>Cash</td> <td style="text-align: right;">\$7.70</td> </tr> </table> <p>(): Preset value</p>	Item 1	Unit price	\$2.00	Quantity	1	Dept.	2	Taxable	(2)	Sales status	(Normal)	Item 2	Unit price	\$2.00	Quantity	1	Dept.	4	Taxable	(2)	Sales status	(Single item)	Payment	Cash	\$7.70	<div style="margin-bottom: 10px;"> 2 00 - 2 </div> <div style="margin-bottom: 10px;"> 5 00 ÷ 4 </div> <p>Single item status is not effective during transaction.</p> <div style="margin-bottom: 10px;"> CA/AMT <small>=/TEND</small> </div> <p>It is necessary to press the finalize key.</p>	<pre> REG 06-15-2002 12:50 CLERK 01 000032 DEPT02 T2 \$2.00 DEPT04 T2 \$5.00 TAX-AMT 2 \$7.00 TAX 2 \$0.70 CASH \$7.70 </pre>
Item 1		Unit price	\$2.00																								
		Quantity	1																								
		Dept.	2																								
		Taxable	(2)																								
	Sales status	(Normal)																									
Item 2	Unit price	\$2.00																									
	Quantity	1																									
	Dept.	4																									
	Taxable	(2)																									
	Sales status	(Single item)																									
Payment	Cash	\$7.70																									

Note: The single item sales department or PLU should be registered at the top of the transaction, otherwise the transaction is not finalized. It is necessary to press CA/AMT, CH or CHK key.

Convenient Operations and Setups

Examples of registering subdepartments

Single item sale

Item	Unit price	\$6.00
	Quantity	1
	Subdept.	15
	Taxable	(1)
Payment	Cash	\$10.00

(): Preset value

OPERATION

1 5
 PLU (subdepartment) code

6 00
 Unit price

1 0 00

RECEIPT

```
REG 06-15-2002 12:55
CLERK 01 000033

PLU0015 T1 $6.00
TAX-AMT 1 $6.00
TAX 1 $0.30
TOTAL $6.30
CASH $10.00
CHANGE $3.70
```

Repeat

Item 1	Unit price	(\$3.00)
	Quantity	3
	Subdept.	15
	Taxable	(1)
Item 2	Unit price	\$2.00
	Quantity	2
	Subdept.	15
	Taxable	(1)
Payment	Cash	\$20.00

(): Preset value

OPERATION

1 5

 Hit without a unit price
 recalls preset price.

1 5

2 00

2 0 00

RECEIPT

```
REG 06-15-2002 13:00
CLERK 01 000034

PLU0015 T1 $3.00
PLU0015 T1 $3.00
PLU0015 T1 $3.00
PLU0015 T1 $2.00
PLU0015 T1 $2.00
TAX-AMT 1 $13.00
TAX 1 $0.65
TOTAL $13.65
CASH $20.00
CHANGE $6.35
```

Multiplication

Item	Unit price	\$6.00
	Quantity	1.25
	Subdept.	15
	Taxable	(1)
Payment	Cash	\$10.00

(): Preset value

OPERATION

1 . 2 5
 Quantity
 (4-digit integer/2-digit decimal)

1 5

6 00

1 0 00

RECEIPT

```
REG 06-15-2002 13:05
CLERK 01 000035

1.25 X @6.00
PLU0015 T1 $7.50
TAX-AMT 1 $7.50
TAX 1 $0.38
TOTAL $7.88
CASH $10.00
CHANGE $2.12
```

Split sales of packaged item

OPERATION

RECEIPT

Item	Unit price	\$30.00
	Quantity	7 / 12
	Subdept.	37
	Taxable	(1)
Payment	Cash	\$20.00

(): Preset value

7 FOR DATE TIME
Quantity being purchased
(4-digit integer/2-digit decimal)

1 2 FOR DATE TIME
Quantity being purchased
(4-digit integer/2-digit decimal)

3 7 PLU/S.DEPT

3 0 00 PRICE

Package price

SUB TOTAL

2 0 00 CA/AMT =/TEND

```
REG 06-15-2002 08:55
000007
7 X
@12 / 30.00
PLU0037 T1 $17.50
TAX-AMT 1 $17.50
TAX 1 $0.88
TOTAL $18.38
CASH $20.00
CHANGE $1.62
```

Quantity
Package quantity/
unit price

Percent key feature programming

In this section, detail information of -/+ is described.

Programming to the percent key

To program a percent rate, please refer to the page 31.

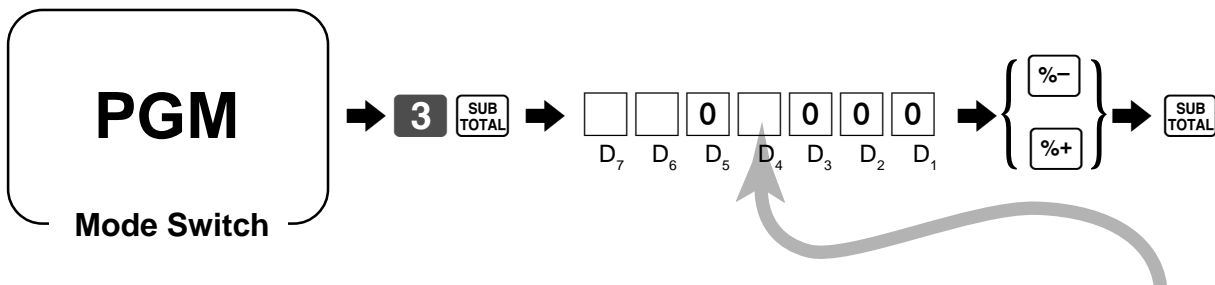

Fraction control, round off = 0, cut off = 1, round up = 2		Significant number	<input type="checkbox"/> D ₇
Key attribution	a	Original = 0 M-Tax = 4	a+b = <input type="checkbox"/> D ₆
Prohibit manual entry to override programmed percentage.	b	No = 0 Yes = 2	
Always "0"			<input type="checkbox"/> 0 D ₅
Taxable status 1 (for the U.S. model)	a	No = 0 Yes = 1	a+b+c = <input type="checkbox"/> D ₄
Taxable status 2 (for the U.S. model)	b	No = 0 Yes = 2	
Taxable status 3 (for the U.S. model)	c	No = 0 Yes = 4	
Taxable status (for the Canadian model) Non tax = 0, Taxable 1 = 1, Taxable 2 = 2, Taxable 3 = 3, Taxable 4 = 4, Taxable 1 & 2 = 5, Taxable 1 & 3 = 6, Taxable 1 & 4 = 7, All taxable = 9		Significant number	<input type="checkbox"/> D ₄
Always "000"			<input type="checkbox"/> 0 ~ <input type="checkbox"/> 0 D ₃ ~D ₁

Convenient Operations and Setups

Registering manual tax

You can program the cash register to change the function of the $\boxed{\% -}$ / $\boxed{\% +}$ key to that of a $\boxed{M-TAX}$ (manual tax) key. The $\boxed{M-TAX}$ key is used to register manually entered tax amounts.



Example

	OPERATION	RECEIPT																												
<table border="1" style="width: 100%; border-collapse: collapse;"> <tr><td rowspan="4" style="text-align: center;">Item 1</td><td>Unit price</td><td style="text-align: right;">\$10.00</td></tr> <tr><td>Quantity</td><td style="text-align: center;">1</td></tr> <tr><td>Dept.</td><td style="text-align: center;">2</td></tr> <tr><td>Taxable</td><td style="text-align: center;">(No)</td></tr> <tr><td colspan="2">M-Tax</td><td style="text-align: center;">50</td></tr> <tr><td colspan="3"> </td></tr> <tr><td rowspan="3" style="text-align: center;">Item 2</td><td>Unit price</td><td style="text-align: right;">\$20.00</td></tr> <tr><td>Quantity</td><td style="text-align: center;">1</td></tr> <tr><td>Dept.</td><td style="text-align: center;">4</td></tr> <tr><td colspan="2">Taxable</td><td style="text-align: center;">(2)</td></tr> <tr><td>Payment</td><td>Cash</td><td style="text-align: right;">\$33.00</td></tr> </table> <p>(): Preset value</p>	Item 1	Unit price	\$10.00	Quantity	1	Dept.	2	Taxable	(No)	M-Tax		50				Item 2	Unit price	\$20.00	Quantity	1	Dept.	4	Taxable		(2)	Payment	Cash	\$33.00	<p>1 0 00 $\boxed{50/74}$ $\boxed{-}$ $\boxed{26}$ $\boxed{2}$</p> <p>5 0 $\boxed{M-TAX}$</p> <p>$\boxed{\% -}$/$\boxed{\% +}$ key is assigned to $\boxed{M-TAX}$ key.</p> <p>2 0 00 $\boxed{52/76}$ $\boxed{+}$ $\boxed{28}$ $\boxed{4}$</p> <p>\boxed{SUB} TOTAL</p> <p>3 3 00 $\boxed{CA/AMT}$ $\boxed{=}$ \boxed{TEND}</p>	<pre> REG 06-15-2002 13:20 CLERK 01 000038 DEPT02 \$10.00 M-TAX \$0.50 DEPT04 T2 \$20.00 TAX-AMT 2 \$20.00 TAX 2 \$2.00 TOTAL \$32.50 CASH \$33.00 CHANGE \$0.50 </pre>
Item 1		Unit price	\$10.00																											
		Quantity	1																											
		Dept.	2																											
	Taxable	(No)																												
M-Tax		50																												
Item 2	Unit price	\$20.00																												
	Quantity	1																												
	Dept.	4																												
Taxable		(2)																												
Payment	Cash	\$33.00																												

Important!

If you program the cash register to perform registrations with manually entered tax amounts, the $\boxed{M-TAX}$ key replaces the $\boxed{\% -}$ / $\boxed{\% +}$ key, so discount/premium registration will be impossible. Also, please set the appropriate key descriptor to the key.

Currency exchange programming

When the **CE** key is pressed, a current subtotal including tax is converted directly into foreign currency and the result is displayed, and the subsequent finalization is handled using the foreign currency. The currency exchange function is released by finalizing a transaction, partial tender operation, receipt issuance, or by pressing the **SUB TOTAL** key.

Currency exchange rate programming

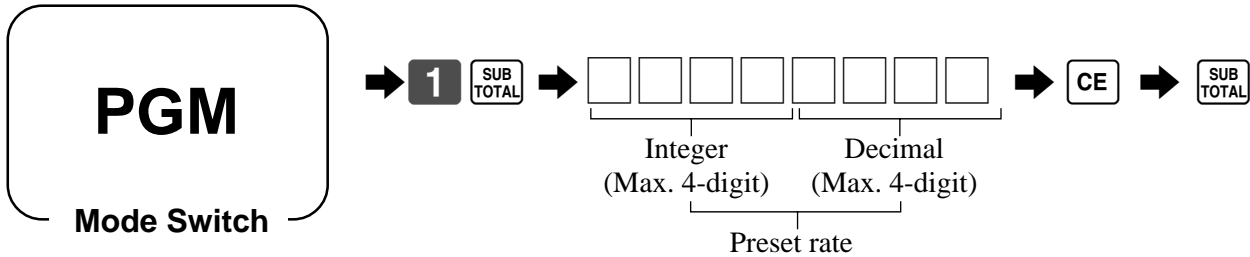

Example:

\$1.00 = ¥110.50 ⇨ **1 · 1 0 5**
 ¥100 = \$0.9050 ⇨ **0 · 9 0 5**

Currency exchange feature programming

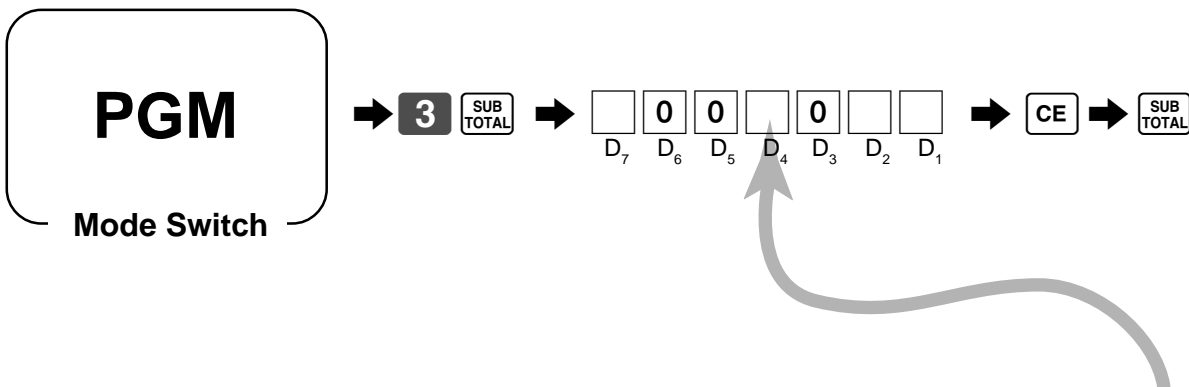

Fraction control, round off = 0, cut off = 1, round up = 2	Significant number	<input type="text"/> D ₇
Always "00"		<input type="text"/> 0 <input type="text"/> 0 D ₆ D ₅
Monetary symbol for foreign currency; Local currency symbol = 0 Foreign currency symbol (in the special character program) = 1	Significant number	<input type="text"/> D ₄
Always "0"		<input type="text"/> 0 D ₃
Digit separator for foreign currency; Period = 0, Comma = 2	Significant number	<input type="text"/> D ₂
Monetary system code (decimal places) following currency exchange operation; Same as local currency = 0, <input type="text"/> <input type="text"/> = 1, <input type="text"/> <input type="text"/> <input type="text"/> = 2, <input type="text"/> = 3	Significant number	<input type="text"/> D ₁

Convenient Operations and Setups

Registering foreign currency



1) Full amount tender in foreign currency

* Preprogrammed exchange rate: ¥ 1 = \$0.0090

Important!

Tenders in a foreign currency can be registered using the **CA/AMT =/TEND** and **CHK** keys only. Other finalize keys cannot be used.

OPERATION	DISPLAY	RECEIPT																											
1 0 00 + 1 ← Enter the unit price and press the applicable department key.	 (Displays in \$)	<table border="1"> <tr><td>REG</td><td>06-15-2002</td><td>13:20</td></tr> <tr><td>CLERK</td><td>01</td><td>000038</td></tr> <tr><td>DEPT01</td><td></td><td>\$10.00</td></tr> <tr><td>DEPT01</td><td></td><td>\$20.00</td></tr> <tr><td>TOTAL</td><td></td><td>\$30.00</td></tr> <tr><td>CURR EXG</td><td></td><td></td></tr> <tr><td>CASH</td><td></td><td>¥5,000</td></tr> <tr><td>CASH</td><td></td><td>\$45.00</td></tr> <tr><td>CHANGE</td><td></td><td>\$15.00</td></tr> </table>	REG	06-15-2002	13:20	CLERK	01	000038	DEPT01		\$10.00	DEPT01		\$20.00	TOTAL		\$30.00	CURR EXG			CASH		¥5,000	CASH		\$45.00	CHANGE		\$15.00
REG	06-15-2002		13:20																										
CLERK	01		000038																										
DEPT01			\$10.00																										
DEPT01			\$20.00																										
TOTAL		\$30.00																											
CURR EXG																													
CASH		¥5,000																											
CASH		\$45.00																											
CHANGE		\$15.00																											
2 0 00 + 1 ← Enter the next unit price and press the applicable department key.	 (Displays in \$)																												
CE ← Press the CE key without entering a numeric value. This operation converts the subtotal (including tax) dollar value into yen by applying a preprogrammed exchange rate. The result is shown on the display but not printed on the receipt or journal.	 (Displays in ¥: 3,333)																												
5 0 00 CE ← Enter the amount tendered in yen and press the CE key. This operation converts the entered yen amount into dollars by applying a preprogrammed exchange rate. The result is shown on the display.	 (Displays in \$: 45.00)																												
CA/AMT =/TEND ← Press to finalize the transaction. Note that you do not need to reenter the dollar amount. The register automatically calculates the change amount due in dollars and shows it on the display, receipts and journal.	 (Displays in \$)																												

2) Partial tender in a foreign currency

* Preprogrammed exchange rate: ¥ 1 = \$0.0090

Important!

Partial tender in a foreign currency can be registered using the **CA/AMT = /TEND** key and **CHK** keys only. Other finalization keys cannot be used, but the remaining tender can be finalized using any finalize key.

OPERATION

DISPLAY

RECEIPT

1 0 00 **+ 1**

← Enter the unit price and press the applicable department key.

10.00
(Displays in \$)

2 0 00 **+ 1**

← Enter the next unit price and press the applicable department key.

20.00
(Displays in \$)

CE

← Press the **CE** key without entering a numeric value. This operation converts the subtotal (including tax) dollar value into yen by applying a preprogrammed exchange rate. The result is shown on the display but not printed on the receipt or journal.

3333
(Displays in ¥: 3,333)

2 0 00 **CE**

← Enter the partial amount tendered in yen and press the **CE** key. This operation converts the entered yen amount into dollars by applying a preprogrammed exchange rate. The result is shown on the display.

18.00
(Displays in \$: 18.00)

CA/AMT = /TEND

← Press the **CA/AMT = /TEND** key to specify cash tender for the yen partial tender. Note that you do not need to reenter the dollar amount. The register automatically deducts the dollar equivalent of the yen amount tendered from the total amount due and shows the amount on the display.

12.00
(Displays in \$)

CHK

← Press to finalize the transaction.

12.00
(Displays in \$)

REG	06-15-2002	13:25
CLERK	01	000039
DEPT01		\$10.00
DEPT01		\$20.00
TOTAL		\$30.00
CURR EXG		
CASH		¥2,000
CASH		\$18.00
CHECK		\$12.00

Other function key feature programming

You can define a selection of features for the function keys by specifying an 8-digit program code for each key.

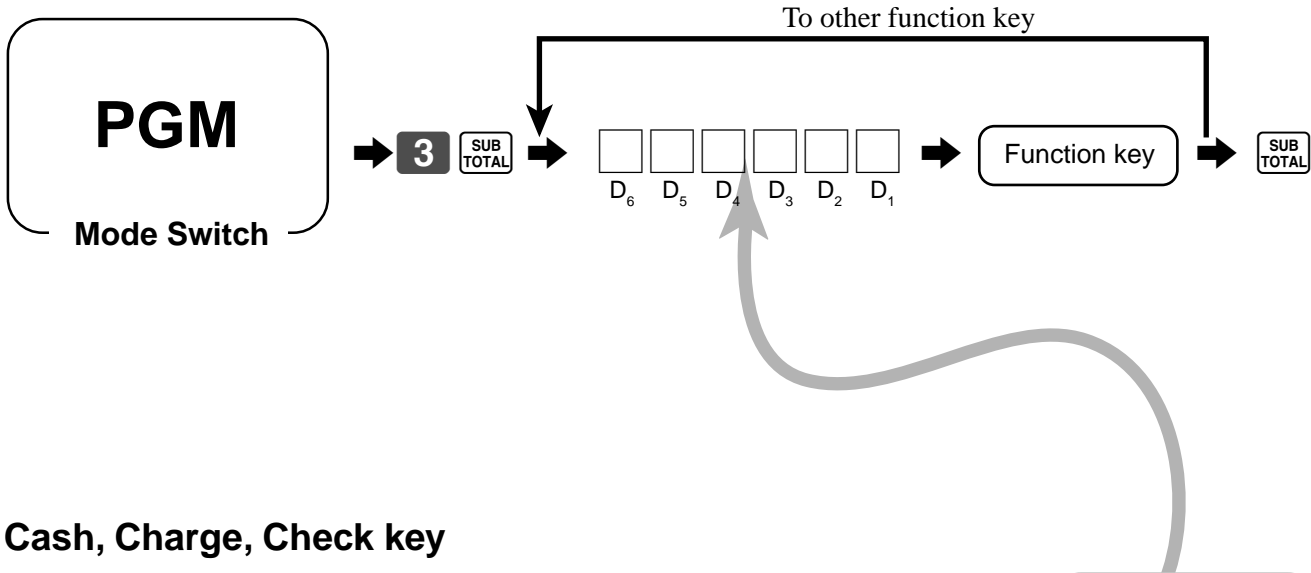

Cash, Charge, Check key

High amount limit specification for subtotal and tendering amounts *1		Maximum value (0 ~ 9)	□ □ D ₆ D ₅
		Number of zeros (0 ~ 9)	
Prohibit entry of a partial payment	a	No = 0 Yes = 1	a+b+c = □ D ₄
Prohibit the entry of the amount tendered.	b	No = 0 Yes = 2	
Force entry of the amount tendered.	c	No = 0 Yes = 4	
Always "0"			0 D ₃
High amount limit specification for change amount due. *1		Maximum value (0 ~ 9)	□ □ D ₂ D ₁
		Number of zeros (0 ~ 9)	

*1 High amounts limits:

High amount limitations are specified as 2-digits. The first digit you specify limits the maximum value of the leftmost digit of the value within the range of 0 through 9. The second digit you specify indicates the number of zeros in the limit value, again within the range of 0 through 9.

Example: \$600.00 maximum ⇨ Enter 64.

Entering "00" clears the limitation.

Received on account, Payout key

High amount limit specification for change amount due. (refer to *1 on the previous page.)	Maximum value (0 ~ 9)	<input type="text"/> <input type="text"/> D ₆ D ₅
	Number of zeros (0 ~ 9)	
Always "0000"		<input type="text"/> 0 ~ <input type="text"/> 0 D ₄ ~ D ₁

Minus key

Allow credit balance.	No = 0 Yes = 1	<input type="text"/> D ₆
High digit limit specification	Significant number	<input type="text"/> D ₅
Taxable status 1 (for the U.S. model)	a No = 0 Yes = 1	a+b+c = <input type="text"/> D ₄
Taxable status 2 (for the U.S. model)	b No = 0 Yes = 2	
Taxable status 3 (for the U.S. model)	c No = 0 Yes = 4	
Taxable status (for the Canadian model) Non tax = 0, Taxable 1 = 1, Taxable 2 = 2, Taxable 3 = 3, Taxable 4 = 4, Taxable 1 & 2 = 5, Taxable 1 & 3 = 6, Taxable 1 & 4 = 7, All taxable = 9	Significant number	<input type="text"/> D ₄
Always "000"		<input type="text"/> 0 ~ <input type="text"/> 0 D ₃ ~ D ₁

#/No sale key, No sale key

Treat as the first transaction.	No = 0 Yes = 1	<input type="text"/> D ₆
Always "00000"		<input type="text"/> 0 ~ <input type="text"/> 0 D ₅ ~ D ₁

Convenient Operations and Setups

Calculator functions

While registering at the REG mode, you can switch to CAL mode and then return to REG mode to resume the registration.

CAL

Mode Switch

Example 1 (Calculation examples)

	OPERATION	DISPLAY
Clear		0
5+3-2=		6
(23-56)×78=		-2574
12 % on 1500		180

Example 2 (Memory recall)

Item 1	Unit price	\$10.00
	Quantity	1
	Dept.	1
Item 2	Unit price	\$20.00
	Quantity	1
	Dept.	1
Payment	Cash	\$10.00
	by 3 persons each,	

OPERATION	DISPLAY/RECEIPT
<p>Turn to REG</p>	
<p>Turn to CAL</p>	
<p>Memory recall: Recalls subtotal amount</p> <p>Divides the subtotal by 3 persons</p>	
<p>Turn to REG</p> <p>Memory recall: Recalls the result amount</p>	

Programming calculator mode control

Open drawer when $\boxed{\text{CA/AMT}} \boxed{= / \text{TEND}}$ (equal) is pressed in CAL mode.	a	No = 0 Yes = 1	$a+b+c = \boxed{} D_5$
Open drawer when $\boxed{\# / \text{NS}}$ (or $\boxed{\text{NS}}$) is pressed in CAL mode.	b	No = 0 Yes = 2	
Print calculator total on the daily report.	c	Yes = 0 No = 4	
Always "0000"			$\boxed{0} \sim \boxed{0} D_4 \sim D_1$

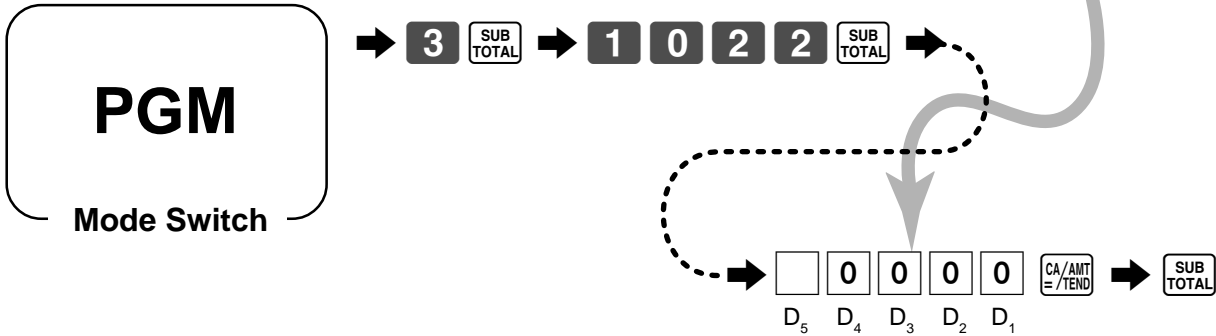

About the daylight saving time

It is possible to set the internal clock forward/backward by 1 ~ 9 hour(s) for the daylight saving time.

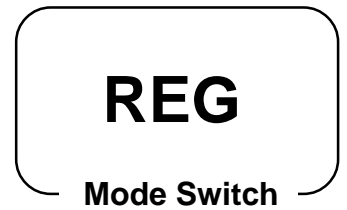

OPERATION

DISPLAY

• Forward by 1 hour

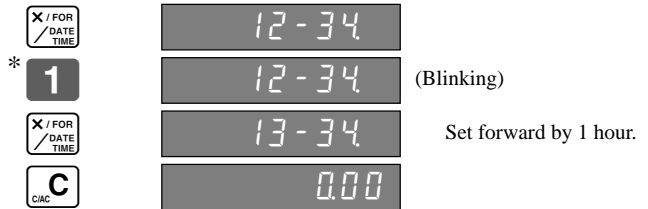

• Backward by 1 hour

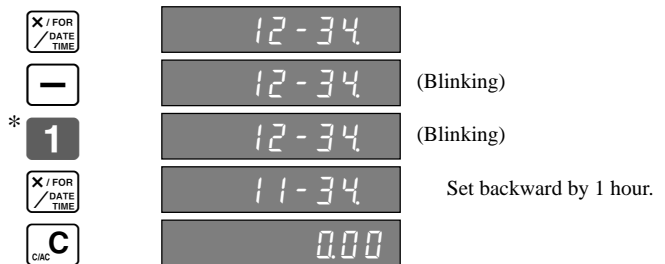

* Put 2 ~ 9, in case of set the clock by 2 ~ 9 hours.

Printing read/reset reports

• Read report

You can print read reports at any time during the business day without affecting the data stored in the cash register's memory.

• Reset report

You should print reset reports at the end of the business day.

Important!

- The reset operation issues a report and also clears all sales data from the cash register's memory.
- Be sure to perform the reset operations at the end of each business day. Otherwise, you will not be able to distinguish between the sales data for different dates.

To print the individual department, PLU/subdepartment read report

This report shows sales for specific departments or PLU/subdepartments.

OPERATION	REPORT																																																																						
<div style="border: 1px solid black; border-radius: 15px; padding: 10px; text-align: center; margin-bottom: 10px;"> <h2 style="margin: 0;">X mode</h2> <p style="margin: 0;">Mode Switch</p> </div> <p>• Specifying a department</p> <div style="border: 1px solid black; border-radius: 5px; padding: 5px; text-align: center; margin-bottom: 10px;">Department</div> <p>• Specifying a PLU</p> <div style="display: flex; justify-content: center; gap: 10px; margin-bottom: 10px;"> 1 ~ 1 6 00 <small>PLU/S.DEPT</small> (U. S.) 1 ~ 8 0 0 <small>PLU/S.DEPT</small> (Canada) </div> <div style="text-align: center; margin-bottom: 10px;"> <div style="border: 1px solid black; padding: 2px 5px; display: inline-block;">SUB TOTAL</div> </div>	<table border="0" style="width: 100%; border-collapse: collapse;"> <tr> <td style="width: 15%;">X</td> <td style="width: 25%;">06-15-2002</td> <td style="width: 15%;">17:05</td> <td style="width: 15%;"></td> <td style="width: 30%; border-left: 1px solid black;">Read mode/date/time</td> </tr> <tr> <td>CLERK</td> <td>01</td> <td></td> <td>000250</td> <td style="border-left: 1px solid black;">Clerk/consecutive No.</td> </tr> <tr> <td></td> <td></td> <td></td> <td style="text-align: center;">X</td> <td style="border-left: 1px solid black;">Read symbol</td> </tr> <tr> <td>DEPT01</td> <td></td> <td>QT</td> <td>15</td> <td style="border-left: 1px solid black;">Department descriptor/No. of items</td> </tr> <tr> <td></td> <td>29.6%</td> <td></td> <td>\$339.50</td> <td style="border-left: 1px solid black;">Sales ratio/department amount</td> </tr> <tr> <td>DEPT02</td> <td></td> <td>QT</td> <td>19</td> <td style="border-left: 1px solid black;"></td> </tr> <tr> <td></td> <td>5.46%</td> <td></td> <td>\$62.70</td> <td style="border-left: 1px solid black;"></td> </tr> <tr> <td>PLU0001</td> <td></td> <td>QT</td> <td>31</td> <td style="border-left: 1px solid black;">PLU descriptor/No. of items</td> </tr> <tr> <td></td> <td>12.12%</td> <td></td> <td>\$139.10</td> <td style="border-left: 1px solid black;">Sales ratio/PLU amount</td> </tr> <tr> <td>PLU0002</td> <td></td> <td>QT</td> <td>23</td> <td style="border-left: 1px solid black;"></td> </tr> <tr> <td></td> <td>29%</td> <td></td> <td>\$332.67</td> <td style="border-left: 1px solid black;"></td> </tr> <tr> <td colspan="4" style="border-top: 1px dashed black;"></td> <td style="border-left: 1px solid black;"></td> </tr> <tr> <td>TOTAL</td> <td></td> <td>QT</td> <td>88</td> <td style="border-left: 1px solid black;">Total No. of items</td> </tr> <tr> <td></td> <td>76.1%</td> <td></td> <td>\$873.97</td> <td style="border-left: 1px solid black;">Total amount</td> </tr> </table>	X	06-15-2002	17:05		Read mode/date/time	CLERK	01		000250	Clerk/consecutive No.				X	Read symbol	DEPT01		QT	15	Department descriptor/No. of items		29.6%		\$339.50	Sales ratio/department amount	DEPT02		QT	19			5.46%		\$62.70		PLU0001		QT	31	PLU descriptor/No. of items		12.12%		\$139.10	Sales ratio/PLU amount	PLU0002		QT	23			29%		\$332.67							TOTAL		QT	88	Total No. of items		76.1%		\$873.97	Total amount
X	06-15-2002	17:05		Read mode/date/time																																																																			
CLERK	01		000250	Clerk/consecutive No.																																																																			
			X	Read symbol																																																																			
DEPT01		QT	15	Department descriptor/No. of items																																																																			
	29.6%		\$339.50	Sales ratio/department amount																																																																			
DEPT02		QT	19																																																																				
	5.46%		\$62.70																																																																				
PLU0001		QT	31	PLU descriptor/No. of items																																																																			
	12.12%		\$139.10	Sales ratio/PLU amount																																																																			
PLU0002		QT	23																																																																				
	29%		\$332.67																																																																				
TOTAL		QT	88	Total No. of items																																																																			
	76.1%		\$873.97	Total amount																																																																			

After you finish to select departments, PLU/subdepartments, press SUB TOTAL to terminate.

Department designation

<div style="border: 1px solid black; border-radius: 5px; padding: 5px; text-align: center; margin-bottom: 10px;">Department</div>	<p>for the U.S.</p> <table border="0" style="width: 100%;"> <tr> <td style="text-align: center;">49/73 + 25 1 (Dept.1)</td> <td style="text-align: center;">DEPT SHIFT DEPT SHIFT 49/73 + 25 1 (Dept.49)</td> </tr> <tr> <td style="text-align: center;">50/74 - 26 2 (Dept.2)</td> <td style="text-align: center;">DEPT SHIFT DEPT SHIFT 50/74 - 26 2 (Dept.50)</td> </tr> <tr> <td style="text-align: center;">:</td> <td style="text-align: center;">:</td> </tr> <tr> <td style="text-align: center;">72/96 48 24 (Dept.24)</td> <td style="text-align: center;">DEPT SHIFT DEPT SHIFT 72/96 48 24 (Dept.72)</td> </tr> <tr> <td style="text-align: center;">DEPT SHIFT 49/73 + 25 1 (Dept.25)</td> <td style="text-align: center;">DEPT SHIFT DEPT SHIFT 49/73 + 25 1 (Dept.73)</td> </tr> <tr> <td style="text-align: center;">:</td> <td style="text-align: center;">:</td> </tr> <tr> <td style="text-align: center;">DEPT SHIFT 72/96 48 24 (Dept.48)</td> <td style="text-align: center;">DEPT SHIFT DEPT SHIFT 72/96 48 24 (Dept.96)</td> </tr> </table>	49/73 + 25 1 (Dept.1)	DEPT SHIFT DEPT SHIFT 49/73 + 25 1 (Dept.49)	50/74 - 26 2 (Dept.2)	DEPT SHIFT DEPT SHIFT 50/74 - 26 2 (Dept.50)	:	:	72/96 48 24 (Dept.24)	DEPT SHIFT DEPT SHIFT 72/96 48 24 (Dept.72)	DEPT SHIFT 49/73 + 25 1 (Dept.25)	DEPT SHIFT DEPT SHIFT 49/73 + 25 1 (Dept.73)	:	:	DEPT SHIFT 72/96 48 24 (Dept.48)	DEPT SHIFT DEPT SHIFT 72/96 48 24 (Dept.96)	<p>for Canada</p> <table border="0" style="width: 100%;"> <tr> <td style="text-align: center;">+ 1 (Dept.1)</td> </tr> <tr> <td style="text-align: center;">- 2 (Dept.2)</td> </tr> <tr> <td style="text-align: center;">:</td> </tr> <tr> <td style="text-align: center;">24 (Dept.24)</td> </tr> </table>	+ 1 (Dept.1)	- 2 (Dept.2)	:	24 (Dept.24)
49/73 + 25 1 (Dept.1)	DEPT SHIFT DEPT SHIFT 49/73 + 25 1 (Dept.49)																			
50/74 - 26 2 (Dept.2)	DEPT SHIFT DEPT SHIFT 50/74 - 26 2 (Dept.50)																			
:	:																			
72/96 48 24 (Dept.24)	DEPT SHIFT DEPT SHIFT 72/96 48 24 (Dept.72)																			
DEPT SHIFT 49/73 + 25 1 (Dept.25)	DEPT SHIFT DEPT SHIFT 49/73 + 25 1 (Dept.73)																			
:	:																			
DEPT SHIFT 72/96 48 24 (Dept.48)	DEPT SHIFT DEPT SHIFT 72/96 48 24 (Dept.96)																			
+ 1 (Dept.1)																				
- 2 (Dept.2)																				
:																				
24 (Dept.24)																				

To print the financial read report

This report shows gross sales, net sales, cash in drawer and check in drawer.

OPERATION	REPORT																																																				
<div style="border: 1px solid black; border-radius: 15px; padding: 10px; width: fit-content; margin: 0 auto;"> <p>X mode</p> </div> <p>Mode Switch</p> <p style="text-align: center;">↓</p> <p>Money declaration *1</p> <p>(Cash in drawer amount # / NS or #)</p> <p style="text-align: center;">↓</p> <div style="border: 1px solid black; padding: 2px; width: fit-content; margin: 0 auto;"> <p>X / FOR DATE TIME</p> </div>	<table border="1" style="width: 100%; border-collapse: collapse;"> <tr> <td>X</td> <td>06-15-2002</td> <td>17:10</td> <td>Read mode/date/time</td> </tr> <tr> <td>CLERK</td> <td>01</td> <td>000251</td> <td>Clerk/consecutive No.</td> </tr> <tr> <td colspan="3" style="text-align: center;">FLASH</td> <td>Report title/read symbol</td> </tr> <tr> <td></td> <td></td> <td>X</td> <td></td> </tr> <tr> <td>GROSS TOTAL</td> <td>QT</td> <td>1216</td> <td>Gross No. of items</td> </tr> <tr> <td></td> <td></td> <td>\$21954.50</td> <td>Gross amount</td> </tr> <tr> <td>NET TOTAL</td> <td>No</td> <td>523</td> <td>Net No. of customers</td> </tr> <tr> <td></td> <td></td> <td>\$27733.12</td> <td>Net amount</td> </tr> <tr> <td>CASH-INDW</td> <td></td> <td>\$27289.10</td> <td>Cash in drawer (b)</td> </tr> <tr> <td>#</td> <td></td> <td>\$27270.00</td> <td>Declared amount (a)</td> </tr> <tr> <td></td> <td></td> <td>\$19.10</td> <td>Difference (b) - (a)</td> </tr> <tr> <td>CHARGE-INDW</td> <td></td> <td>\$398.00</td> <td>Charge in drawer</td> </tr> <tr> <td>CHECK-INDW</td> <td></td> <td>\$332.67</td> <td>Check in drawer</td> </tr> </table>	X	06-15-2002	17:10	Read mode/date/time	CLERK	01	000251	Clerk/consecutive No.	FLASH			Report title/read symbol			X		GROSS TOTAL	QT	1216	Gross No. of items			\$21954.50	Gross amount	NET TOTAL	No	523	Net No. of customers			\$27733.12	Net amount	CASH-INDW		\$27289.10	Cash in drawer (b)	#		\$27270.00	Declared amount (a)			\$19.10	Difference (b) - (a)	CHARGE-INDW		\$398.00	Charge in drawer	CHECK-INDW		\$332.67	Check in drawer
X	06-15-2002	17:10	Read mode/date/time																																																		
CLERK	01	000251	Clerk/consecutive No.																																																		
FLASH			Report title/read symbol																																																		
		X																																																			
GROSS TOTAL	QT	1216	Gross No. of items																																																		
		\$21954.50	Gross amount																																																		
NET TOTAL	No	523	Net No. of customers																																																		
		\$27733.12	Net amount																																																		
CASH-INDW		\$27289.10	Cash in drawer (b)																																																		
#		\$27270.00	Declared amount (a)																																																		
		\$19.10	Difference (b) - (a)																																																		
CHARGE-INDW		\$398.00	Charge in drawer																																																		
CHECK-INDW		\$332.67	Check in drawer																																																		

*1 Money declaration:

Count how much cash is in the drawer and input this amount (up to 8-digits).

The cash register will automatically compare the input with the cash in drawer in the memory and print the difference between these two amounts.

Note that if money declaration is required by programming (page 47), you cannot skip this procedure.

To print the group read report

This report shows group totals.

OPERATION	REPORT																																																																			
<div style="border: 1px solid black; border-radius: 15px; padding: 10px; width: fit-content; margin: 0 auto;"> <p>X mode</p> </div> <p>Mode Switch</p> <p style="text-align: center;">↓</p> <div style="display: flex; align-items: center; justify-content: center;"> <div style="border: 1px solid black; padding: 2px; margin-right: 5px;">6</div> <div style="border: 1px solid black; padding: 2px; margin-right: 5px;">CA/AMT</div> <div style="border: 1px solid black; padding: 2px; margin-right: 5px;">=/TEND</div> </div>	<table border="1" style="width: 100%; border-collapse: collapse;"> <tr> <td>X</td> <td>06-15-2002</td> <td>17:15</td> <td>Read mode/date/time</td> </tr> <tr> <td>CLERK</td> <td>01</td> <td>000252</td> <td>Clerk/consecutive No.</td> </tr> <tr> <td>0006</td> <td>GROUP</td> <td>X</td> <td>Report code/report title/read symbol</td> </tr> <tr> <td>01</td> <td>.....</td> <td>QT</td> <td>16</td> <td>Group 01/No. of items</td> </tr> <tr> <td></td> <td></td> <td>0.24%</td> <td>\$54.50</td> <td>Sales ratio/group 01 amount</td> </tr> <tr> <td>02</td> <td>.....</td> <td>QT</td> <td>25</td> <td></td> </tr> <tr> <td></td> <td></td> <td>0.09%</td> <td>\$21.33</td> <td></td> </tr> <tr> <td>03</td> <td>.....</td> <td>QT</td> <td>132</td> <td></td> </tr> <tr> <td></td> <td></td> <td>0.12%</td> <td>\$90.78</td> <td></td> </tr> <tr> <td>.....</td> <td>.....</td> <td>QT</td> <td>6</td> <td>Total of non-group link PLUs</td> </tr> <tr> <td></td> <td></td> <td>0.02%</td> <td>\$4.50</td> <td></td> </tr> <tr> <td colspan="4" style="border-top: 1px dashed black;"></td> <td></td> </tr> <tr> <td>TOTAL</td> <td></td> <td>QT</td> <td>156</td> <td>Total No. of items</td> </tr> <tr> <td></td> <td></td> <td>0.47%</td> <td>\$332.67</td> <td>Total amount</td> </tr> </table>	X	06-15-2002	17:15	Read mode/date/time	CLERK	01	000252	Clerk/consecutive No.	0006	GROUP	X	Report code/report title/read symbol	01	QT	16	Group 01/No. of items			0.24%	\$54.50	Sales ratio/group 01 amount	02	QT	25				0.09%	\$21.33		03	QT	132				0.12%	\$90.78		QT	6	Total of non-group link PLUs			0.02%	\$4.50							TOTAL		QT	156	Total No. of items			0.47%	\$332.67	Total amount
X	06-15-2002	17:15	Read mode/date/time																																																																	
CLERK	01	000252	Clerk/consecutive No.																																																																	
0006	GROUP	X	Report code/report title/read symbol																																																																	
01	QT	16	Group 01/No. of items																																																																
		0.24%	\$54.50	Sales ratio/group 01 amount																																																																
02	QT	25																																																																	
		0.09%	\$21.33																																																																	
03	QT	132																																																																	
		0.12%	\$90.78																																																																	
.....	QT	6	Total of non-group link PLUs																																																																
		0.02%	\$4.50																																																																	
TOTAL		QT	156	Total No. of items																																																																
		0.47%	\$332.67	Total amount																																																																

Issue this report before the daily sales reset report, otherwise the group totals are all reset.

Convenient Operations and Setups

To print the PLU/subdepartment read/reset report

This report shows sales for PLUs/subdepartments.

OPERATION	REPORT																																																																						
<div style="border: 1px solid black; border-radius: 15px; padding: 10px; width: fit-content;"> <p>Read: X mode Reset: Z mode</p> <p style="text-align: center;">Mode Switch</p> <p style="text-align: center;">↓</p> <div style="display: flex; align-items: center; justify-content: center;"> <div style="border: 1px solid black; padding: 2px 5px; margin-right: 5px;">1</div> <div style="border: 1px solid black; padding: 2px 5px; font-size: 8px;">CA/AMT =/TEND</div> </div> </div>	<table border="1" style="width: 100%; border-collapse: collapse;"> <tr> <td>Z</td> <td>06-15-2002</td> <td>17:25</td> <td>—</td> <td>Reset mode/date/time</td> </tr> <tr> <td>CLERK</td> <td>01</td> <td>000254</td> <td>—</td> <td>Clerk/consecutive No.</td> </tr> <tr> <td>0001</td> <td>PLU</td> <td>Z</td> <td>0001</td> <td>Report code/report title/reset symbol/reset counter</td> </tr> <tr> <td>PLU0001</td> <td>QT</td> <td>16</td> <td>—</td> <td>PLU0001/No. of items</td> </tr> <tr> <td>0.24%</td> <td></td> <td>\$54.50</td> <td>—</td> <td>Sales ratio/PLU0001 amount</td> </tr> <tr> <td>PLU0002</td> <td>QT</td> <td>25</td> <td>—</td> <td></td> </tr> <tr> <td>0.09%</td> <td></td> <td>\$21.33</td> <td>—</td> <td></td> </tr> <tr> <td>PLU0003</td> <td>QT</td> <td>132</td> <td>—</td> <td></td> </tr> <tr> <td>0.12%</td> <td></td> <td>\$90.78</td> <td>—</td> <td></td> </tr> <tr> <td>PLU0400</td> <td>QT</td> <td>0</td> <td>—</td> <td></td> </tr> <tr> <td>0.02%</td> <td></td> <td>\$4.50</td> <td>—</td> <td></td> </tr> <tr> <td colspan="5" style="text-align: center;">-----</td> </tr> <tr> <td>TOTAL</td> <td>QT</td> <td>156</td> <td>—</td> <td>Total No. of items</td> </tr> <tr> <td>100%</td> <td></td> <td>\$21960.90</td> <td>—</td> <td>Total amount</td> </tr> </table>	Z	06-15-2002	17:25	—	Reset mode/date/time	CLERK	01	000254	—	Clerk/consecutive No.	0001	PLU	Z	0001	Report code/report title/reset symbol/reset counter	PLU0001	QT	16	—	PLU0001/No. of items	0.24%		\$54.50	—	Sales ratio/PLU0001 amount	PLU0002	QT	25	—		0.09%		\$21.33	—		PLU0003	QT	132	—		0.12%		\$90.78	—		PLU0400	QT	0	—		0.02%		\$4.50	—		-----					TOTAL	QT	156	—	Total No. of items	100%		\$21960.90	—	Total amount
Z	06-15-2002	17:25	—	Reset mode/date/time																																																																			
CLERK	01	000254	—	Clerk/consecutive No.																																																																			
0001	PLU	Z	0001	Report code/report title/reset symbol/reset counter																																																																			
PLU0001	QT	16	—	PLU0001/No. of items																																																																			
0.24%		\$54.50	—	Sales ratio/PLU0001 amount																																																																			
PLU0002	QT	25	—																																																																				
0.09%		\$21.33	—																																																																				
PLU0003	QT	132	—																																																																				
0.12%		\$90.78	—																																																																				
PLU0400	QT	0	—																																																																				
0.02%		\$4.50	—																																																																				

TOTAL	QT	156	—	Total No. of items																																																																			
100%		\$21960.90	—	Total amount																																																																			

To print the hourly sales read/reset report

This report shows hourly breakdowns of sales.

OPERATION	REPORT																																																																						
<div style="border: 1px solid black; border-radius: 15px; padding: 10px; width: fit-content;"> <p>Read: X mode Reset: Z mode</p> <p style="text-align: center;">Mode Switch</p> <p style="text-align: center;">↓</p> <div style="display: flex; align-items: center; justify-content: center;"> <div style="border: 1px solid black; padding: 2px 5px; margin-right: 5px;">2</div> <div style="border: 1px solid black; padding: 2px 5px; font-size: 8px;">CA/AMT =/TEND</div> </div> </div>	<table border="1" style="width: 100%; border-collapse: collapse;"> <tr> <td>Z</td> <td>06-15-2002</td> <td>17:30</td> <td>—</td> <td>Reset mode/date/time</td> </tr> <tr> <td>CLERK</td> <td>01</td> <td>000255</td> <td>—</td> <td>Clerk/consecutive No.</td> </tr> <tr> <td>0002</td> <td>HOURLY</td> <td>Z</td> <td>0001</td> <td>Report code/report title/reset symbol/reset counter</td> </tr> <tr> <td>00:00-01:00</td> <td>No</td> <td>6</td> <td>—</td> <td>Time range/No. of customers</td> </tr> <tr> <td></td> <td></td> <td>\$4.50</td> <td>—</td> <td>Sales amount</td> </tr> <tr> <td>01:00-02:00</td> <td>No</td> <td>25</td> <td>—</td> <td></td> </tr> <tr> <td></td> <td></td> <td>\$21.33</td> <td>—</td> <td></td> </tr> <tr> <td>02:00-03:00</td> <td>No</td> <td>132</td> <td>—</td> <td></td> </tr> <tr> <td></td> <td></td> <td>\$90.78</td> <td>—</td> <td></td> </tr> <tr> <td>23:00-24:00</td> <td>No</td> <td>1</td> <td>—</td> <td></td> </tr> <tr> <td></td> <td></td> <td>\$1.50</td> <td>—</td> <td></td> </tr> <tr> <td colspan="5" style="text-align: center;">-----</td> </tr> <tr> <td>TOTAL</td> <td>No</td> <td>56</td> <td>—</td> <td>Total No. of customers</td> </tr> <tr> <td></td> <td></td> <td>\$1338.40</td> <td>—</td> <td>Total amount</td> </tr> </table>	Z	06-15-2002	17:30	—	Reset mode/date/time	CLERK	01	000255	—	Clerk/consecutive No.	0002	HOURLY	Z	0001	Report code/report title/reset symbol/reset counter	00:00-01:00	No	6	—	Time range/No. of customers			\$4.50	—	Sales amount	01:00-02:00	No	25	—				\$21.33	—		02:00-03:00	No	132	—				\$90.78	—		23:00-24:00	No	1	—				\$1.50	—		-----					TOTAL	No	56	—	Total No. of customers			\$1338.40	—	Total amount
Z	06-15-2002	17:30	—	Reset mode/date/time																																																																			
CLERK	01	000255	—	Clerk/consecutive No.																																																																			
0002	HOURLY	Z	0001	Report code/report title/reset symbol/reset counter																																																																			
00:00-01:00	No	6	—	Time range/No. of customers																																																																			
		\$4.50	—	Sales amount																																																																			
01:00-02:00	No	25	—																																																																				
		\$21.33	—																																																																				
02:00-03:00	No	132	—																																																																				
		\$90.78	—																																																																				
23:00-24:00	No	1	—																																																																				
		\$1.50	—																																																																				

TOTAL	No	56	—	Total No. of customers																																																																			
		\$1338.40	—	Total amount																																																																			

To print the monthly sales read/reset report

This report shows monthly breakdowns of sales.

OPERATION

Read: X mode
Reset: Z mode

Mode Switch



REPORT

Z	06-15-2002	17:35		Reset mode/date/time
CLERK	01		000256	Clerk/consecutive No.
0003	MONTHLY	Z	0001	Report code/report title/reset symbol/reset counter
1	No	6	Date of a month/No. of customers
			\$4.50	Sales amount
2	No	25	
			\$21.33	
3	No	132	
			\$90.78	
31	No	1	
			\$1.50	

TOTAL		No	56	Total No. of customers
			\$1338.40	Total amount

Convenient Operations and Setups

To print the daily sales read/reset report

This report shows sales except for PLUs.

OPERATION	REPORT																																																																																																																																										
<p>Read: X mode</p> <p>Reset: Z mode</p> <p>Mode Switch</p> <p>↓</p> <p>Money declaration *1</p> <p>(Cash in drawer amount #/NS or #)</p> <p>↓</p> <p>CA/AMT =/TEND</p>	<table border="0" style="width: 100%; border-collapse: collapse;"> <tr> <td style="width: 30%;">TAX 1</td> <td style="width: 10%; text-align: right;">\$43.96</td> <td style="width: 60%;">Tax amount 1 *3</td> </tr> <tr> <td>TAX-AMT 2</td> <td style="text-align: right;">\$409.72</td> <td>Taxable amount 2 *3</td> </tr> <tr> <td>TAX 2</td> <td style="text-align: right;">\$21.55</td> <td>Tax amount 2 *3</td> </tr> <tr> <td>TAX-AMT 3</td> <td style="text-align: right;">\$272.50</td> <td>Taxable amount 3 *3</td> </tr> <tr> <td>TAX 3</td> <td style="text-align: right;">\$8.18</td> <td>Tax amount 3 *3</td> </tr> <tr> <td>TAX-AMT 4</td> <td style="text-align: right;">\$5.50</td> <td>Taxable amount 4 (Canada only) *3</td> </tr> <tr> <td>TAX 4</td> <td style="text-align: right;">\$0.06</td> <td>Tax amount 4 (Canada only) *3</td> </tr> <tr> <td>TAX</td> <td style="text-align: right;">\$73.75</td> <td>Tax total *4</td> </tr> <tr> <td>CANCEL TTL</td> <td style="text-align: right;">No 2</td> <td>Cancellation count</td> </tr> <tr> <td></td> <td style="text-align: right;">\$108.52</td> <td>Cancellation amount</td> </tr> <tr> <td>RF-MODE TTL</td> <td style="text-align: right;">No 2</td> <td>Refund mode operation count *4</td> </tr> <tr> <td></td> <td style="text-align: right;">\$3.74</td> <td>Refund mode operation amount *4</td> </tr> <tr> <td>CALCULATOR</td> <td style="text-align: right;">No 10</td> <td>CAL mode operation count</td> </tr> <tr> <td colspan="3" style="border-top: 1px dashed black;"></td> </tr> <tr> <td>CASH</td> <td style="text-align: right;">No 81</td> <td>Cash sales count</td> </tr> <tr> <td></td> <td style="text-align: right;">\$836.86</td> <td>Cash sales amount</td> </tr> <tr> <td>CHARGE</td> <td style="text-align: right;">No 10</td> <td>Charge sales count</td> </tr> <tr> <td></td> <td style="text-align: right;">\$197.17</td> <td>Charge sales amount</td> </tr> <tr> <td>CHECK</td> <td style="text-align: right;">No 9</td> <td>Check sales count</td> </tr> <tr> <td></td> <td style="text-align: right;">\$183.60</td> <td>Check sales amount</td> </tr> <tr> <td>RC</td> <td style="text-align: right;">No 2</td> <td>Received on Account count</td> </tr> <tr> <td></td> <td style="text-align: right;">\$78.00</td> <td>Received on Account amount</td> </tr> <tr> <td>PD</td> <td style="text-align: right;">No 1</td> <td>Paid out count</td> </tr> <tr> <td></td> <td style="text-align: right;">\$6.80</td> <td>Paid out amount</td> </tr> <tr> <td>-</td> <td style="text-align: right;">No 8</td> <td>Subtraction count</td> </tr> <tr> <td></td> <td style="text-align: right;">\$3.00</td> <td>Subtraction amount</td> </tr> <tr> <td>%-</td> <td style="text-align: right;">No 10</td> <td>Discount count</td> </tr> <tr> <td></td> <td style="text-align: right;">\$4.62</td> <td>Discount amount</td> </tr> <tr> <td>%+</td> <td style="text-align: right;">No 1</td> <td>Premium count</td> </tr> <tr> <td></td> <td style="text-align: right;">\$1.00</td> <td>Premium amount</td> </tr> <tr> <td>REFUND</td> <td style="text-align: right;">No 7</td> <td>Refund key count *4</td> </tr> <tr> <td></td> <td style="text-align: right;">\$27.79</td> <td>Refund key amount *4</td> </tr> <tr> <td>ERR CORR</td> <td style="text-align: right;">No 10</td> <td>Error correction count</td> </tr> <tr> <td></td> <td style="text-align: right;">\$12.76</td> <td>Error correction amount</td> </tr> <tr> <td>#/NS</td> <td style="text-align: right;">No 5</td> <td>No sale count</td> </tr> <tr> <td colspan="3" style="border-top: 1px dashed black;"></td> </tr> <tr> <td>CLERK 01</td> <td style="text-align: right;">No 12</td> <td>Clerk 1/clerk 1 sales count</td> </tr> <tr> <td></td> <td style="text-align: right;">\$127.63</td> <td>Clerk 1 sales amount</td> </tr> <tr> <td>*****</td> <td></td> <td></td> </tr> <tr> <td>CLERK 02</td> <td style="text-align: right;">No 6</td> <td>Training clerk</td> </tr> <tr> <td></td> <td style="text-align: right;">\$27.63</td> <td></td> </tr> <tr> <td>*****</td> <td></td> <td></td> </tr> <tr> <td>CLERK 02</td> <td style="text-align: right;">No 24</td> <td></td> </tr> <tr> <td colspan="3" style="border-top: 1px dashed black;"></td> </tr> <tr> <td>GRND TTL</td> <td style="text-align: right;">\$0000351217.63</td> <td>Non-resettable grand-sales total *4</td> </tr> <tr> <td></td> <td style="text-align: right;">000001---}000253</td> <td>Consecutive No. range of the day *4</td> </tr> </table>	TAX 1	\$43.96	Tax amount 1 *3	TAX-AMT 2	\$409.72	Taxable amount 2 *3	TAX 2	\$21.55	Tax amount 2 *3	TAX-AMT 3	\$272.50	Taxable amount 3 *3	TAX 3	\$8.18	Tax amount 3 *3	TAX-AMT 4	\$5.50	Taxable amount 4 (Canada only) *3	TAX 4	\$0.06	Tax amount 4 (Canada only) *3	TAX	\$73.75	Tax total *4	CANCEL TTL	No 2	Cancellation count		\$108.52	Cancellation amount	RF-MODE TTL	No 2	Refund mode operation count *4		\$3.74	Refund mode operation amount *4	CALCULATOR	No 10	CAL mode operation count				CASH	No 81	Cash sales count		\$836.86	Cash sales amount	CHARGE	No 10	Charge sales count		\$197.17	Charge sales amount	CHECK	No 9	Check sales count		\$183.60	Check sales amount	RC	No 2	Received on Account count		\$78.00	Received on Account amount	PD	No 1	Paid out count		\$6.80	Paid out amount	-	No 8	Subtraction count		\$3.00	Subtraction amount	%-	No 10	Discount count		\$4.62	Discount amount	%+	No 1	Premium count		\$1.00	Premium amount	REFUND	No 7	Refund key count *4		\$27.79	Refund key amount *4	ERR CORR	No 10	Error correction count		\$12.76	Error correction amount	#/NS	No 5	No sale count				CLERK 01	No 12	Clerk 1/clerk 1 sales count		\$127.63	Clerk 1 sales amount	*****			CLERK 02	No 6	Training clerk		\$27.63		*****			CLERK 02	No 24					GRND TTL	\$0000351217.63	Non-resettable grand-sales total *4		000001---}000253	Consecutive No. range of the day *4
TAX 1	\$43.96	Tax amount 1 *3																																																																																																																																									
TAX-AMT 2	\$409.72	Taxable amount 2 *3																																																																																																																																									
TAX 2	\$21.55	Tax amount 2 *3																																																																																																																																									
TAX-AMT 3	\$272.50	Taxable amount 3 *3																																																																																																																																									
TAX 3	\$8.18	Tax amount 3 *3																																																																																																																																									
TAX-AMT 4	\$5.50	Taxable amount 4 (Canada only) *3																																																																																																																																									
TAX 4	\$0.06	Tax amount 4 (Canada only) *3																																																																																																																																									
TAX	\$73.75	Tax total *4																																																																																																																																									
CANCEL TTL	No 2	Cancellation count																																																																																																																																									
	\$108.52	Cancellation amount																																																																																																																																									
RF-MODE TTL	No 2	Refund mode operation count *4																																																																																																																																									
	\$3.74	Refund mode operation amount *4																																																																																																																																									
CALCULATOR	No 10	CAL mode operation count																																																																																																																																									
CASH	No 81	Cash sales count																																																																																																																																									
	\$836.86	Cash sales amount																																																																																																																																									
CHARGE	No 10	Charge sales count																																																																																																																																									
	\$197.17	Charge sales amount																																																																																																																																									
CHECK	No 9	Check sales count																																																																																																																																									
	\$183.60	Check sales amount																																																																																																																																									
RC	No 2	Received on Account count																																																																																																																																									
	\$78.00	Received on Account amount																																																																																																																																									
PD	No 1	Paid out count																																																																																																																																									
	\$6.80	Paid out amount																																																																																																																																									
-	No 8	Subtraction count																																																																																																																																									
	\$3.00	Subtraction amount																																																																																																																																									
%-	No 10	Discount count																																																																																																																																									
	\$4.62	Discount amount																																																																																																																																									
%+	No 1	Premium count																																																																																																																																									
	\$1.00	Premium amount																																																																																																																																									
REFUND	No 7	Refund key count *4																																																																																																																																									
	\$27.79	Refund key amount *4																																																																																																																																									
ERR CORR	No 10	Error correction count																																																																																																																																									
	\$12.76	Error correction amount																																																																																																																																									
#/NS	No 5	No sale count																																																																																																																																									
CLERK 01	No 12	Clerk 1/clerk 1 sales count																																																																																																																																									
	\$127.63	Clerk 1 sales amount																																																																																																																																									

CLERK 02	No 6	Training clerk																																																																																																																																									
	\$27.63																																																																																																																																										

CLERK 02	No 24																																																																																																																																										
GRND TTL	\$0000351217.63	Non-resettable grand-sales total *4																																																																																																																																									
	000001---}000253	Consecutive No. range of the day *4																																																																																																																																									
<table border="0" style="width: 100%; border-collapse: collapse;"> <tr> <td style="width: 30%;">Z 06-15-2002 17:20</td> <td style="width: 10%;"></td> <td style="width: 60%;">Reset mode/date/time</td> </tr> <tr> <td>CLERK 01 000258</td> <td></td> <td>Clerk/consecutive No.</td> </tr> <tr> <td>0000 DAILY Z 0001</td> <td></td> <td>Report code/report title/reset symbol/ reset counter *5</td> </tr> <tr> <td>DEPT01 QT 1015</td> <td></td> <td>Department descriptor/No. of items *2</td> </tr> <tr> <td>47.07% \$10339.50</td> <td></td> <td>Sales ratio/department amount *2</td> </tr> <tr> <td>DEPT02 QT 19</td> <td></td> <td></td> </tr> <tr> <td>31.87% \$7000.70</td> <td></td> <td></td> </tr> <tr> <td>DEPT03 QT 31</td> <td></td> <td></td> </tr> <tr> <td>18.84% \$4139.10</td> <td></td> <td></td> </tr> <tr> <td>DEPT04 QT 23</td> <td></td> <td></td> </tr> <tr> <td>1.51% \$332.67</td> <td></td> <td></td> </tr> <tr> <td>NON-LINK DPT QT 10</td> <td></td> <td>Non-link department No. of items</td> </tr> <tr> <td>0.43% \$94.90</td> <td></td> <td>Non-link department amount</td> </tr> <tr> <td colspan="3" style="border-top: 1px dashed black;"></td> </tr> <tr> <td>GROSS TOTAL QT 1253</td> <td></td> <td>Gross No. of items</td> </tr> <tr> <td></td> <td style="text-align: right;">\$21960.90</td> <td>Gross sales amount</td> </tr> <tr> <td>NET TOTAL No 545</td> <td></td> <td>No. of customers</td> </tr> <tr> <td></td> <td style="text-align: right;">\$30217.63</td> <td>Net sales amount</td> </tr> <tr> <td>CASH-INDW \$29903.06</td> <td></td> <td>Cash in drawer amount (b)</td> </tr> <tr> <td># \$29903.06</td> <td></td> <td>Declared amount (a)</td> </tr> <tr> <td></td> <td style="text-align: right;">\$0.00</td> <td>Difference (b) - (a)</td> </tr> <tr> <td>CHARGE-INDW \$183.60</td> <td></td> <td>Charge in drawer amount</td> </tr> <tr> <td>CHECK-INDW \$197.17</td> <td></td> <td>Check in drawer amount</td> </tr> <tr> <td>CE-CASH 1 ¥7,000</td> <td></td> <td>Currency exchange cash in drawer</td> </tr> <tr> <td>CE-CHECK 1 ¥4,000</td> <td></td> <td>Currency exchange check in drawer</td> </tr> <tr> <td>TAX-AMT 1 \$732.56</td> <td></td> <td>Taxable amount 1 *3</td> </tr> </table>	Z 06-15-2002 17:20		Reset mode/date/time	CLERK 01 000258		Clerk/consecutive No.	0000 DAILY Z 0001		Report code/report title/reset symbol/ reset counter *5	DEPT01 QT 1015		Department descriptor/No. of items *2	47.07% \$10339.50		Sales ratio/department amount *2	DEPT02 QT 19			31.87% \$7000.70			DEPT03 QT 31			18.84% \$4139.10			DEPT04 QT 23			1.51% \$332.67			NON-LINK DPT QT 10		Non-link department No. of items	0.43% \$94.90		Non-link department amount				GROSS TOTAL QT 1253		Gross No. of items		\$21960.90	Gross sales amount	NET TOTAL No 545		No. of customers		\$30217.63	Net sales amount	CASH-INDW \$29903.06		Cash in drawer amount (b)	# \$29903.06		Declared amount (a)		\$0.00	Difference (b) - (a)	CHARGE-INDW \$183.60		Charge in drawer amount	CHECK-INDW \$197.17		Check in drawer amount	CE-CASH 1 ¥7,000		Currency exchange cash in drawer	CE-CHECK 1 ¥4,000		Currency exchange check in drawer	TAX-AMT 1 \$732.56		Taxable amount 1 *3																																																													
Z 06-15-2002 17:20		Reset mode/date/time																																																																																																																																									
CLERK 01 000258		Clerk/consecutive No.																																																																																																																																									
0000 DAILY Z 0001		Report code/report title/reset symbol/ reset counter *5																																																																																																																																									
DEPT01 QT 1015		Department descriptor/No. of items *2																																																																																																																																									
47.07% \$10339.50		Sales ratio/department amount *2																																																																																																																																									
DEPT02 QT 19																																																																																																																																											
31.87% \$7000.70																																																																																																																																											
DEPT03 QT 31																																																																																																																																											
18.84% \$4139.10																																																																																																																																											
DEPT04 QT 23																																																																																																																																											
1.51% \$332.67																																																																																																																																											
NON-LINK DPT QT 10		Non-link department No. of items																																																																																																																																									
0.43% \$94.90		Non-link department amount																																																																																																																																									
GROSS TOTAL QT 1253		Gross No. of items																																																																																																																																									
	\$21960.90	Gross sales amount																																																																																																																																									
NET TOTAL No 545		No. of customers																																																																																																																																									
	\$30217.63	Net sales amount																																																																																																																																									
CASH-INDW \$29903.06		Cash in drawer amount (b)																																																																																																																																									
# \$29903.06		Declared amount (a)																																																																																																																																									
	\$0.00	Difference (b) - (a)																																																																																																																																									
CHARGE-INDW \$183.60		Charge in drawer amount																																																																																																																																									
CHECK-INDW \$197.17		Check in drawer amount																																																																																																																																									
CE-CASH 1 ¥7,000		Currency exchange cash in drawer																																																																																																																																									
CE-CHECK 1 ¥4,000		Currency exchange check in drawer																																																																																																																																									
TAX-AMT 1 \$732.56		Taxable amount 1 *3																																																																																																																																									

*1 Money declaration:

Count how much cash is in the drawer and input this amount (up to 8-digits).

The cash register will automatically compare the input with the cash in drawer in the memory and print the difference between these two amounts.

Note that if money declaration is required by programming (page 47), you cannot skip this procedure.

*2 Zero totalled departments (the amount and item numbers are both zero) are not printed.

*3 Taxable amount and tax amount are printed only if the corresponding tax table is programmed.

*4 These items can be skipped by programming.

5 The "" symbol is printed on the reset report, if memory overflow occurred in the totalizer.

To print the periodic-1/-2 sales read/reset reports

These reports show sales breakdowns of sales by any two kinds of period you want.

OPERATION

REPORT

Read: X mode
Reset: Z mode
Mode Switch



1 0 0 (Periodic-1 Read)

3 0 0 (Periodic-2 Read)

2 0 0 (Periodic-1 Reset)

4 0 0 (Periodic-2 Reset)



CA/AMT
=/TEND

Z	06-15-2002	17:40		Reset mode/date/time
CLERK	01		000257	Clerk/consecutive No.
0200	PERIODIC-1		ZZ0001	Report code/report title/reset symbol/ reset counter
DEPT01		QT	1015	Department descriptor/No. of items *1
	47.07%		\$10339.50	Sales ratio/department amount *1
DEPT02		QT	19	
	31.87%		\$7000.70	
DEPT03		QT	31	
	18.84%		\$4139.10	
DEPT04		QT	23	
	1.51%		\$332.87	
NON-LINK DPT		QT	10	Non-link department No. of items
	0.43%		\$94.90	Non-link department amount

GROSS TOTAL		QT	1253	Gross No. of items
			\$21960.90	Gross sales amount
NET TOTAL		No	545	No. of customers
			\$30217.63	Net sales amount
CASH-INDW			\$29903.06	Cash in drawer amount
CHARGE-INDW			\$183.60	Charge in drawer amount
CHECK-INDW			\$197.17	Check in drawer amount
TAX-AMT 1			\$732.56	Taxable amount 1 *2
TAX 1			\$43.96	Tax amount 1 *2
TAX-AMT 2			\$409.72	Taxable amount 2 *2
TAX 2			\$21.55	Tax amount 2 *2
TAX-AMT 3			\$272.50	Taxable amount 3 *2
TAX 3			\$8.18	Tax amount 3 *2
TAX-AMT 4			\$5.50	Taxable amount 4 (Canada only) *2
TAX 4			\$0.06	Tax amount 4 (Canada only) *2
TAX			\$73.75	Tax total *3
CANCEL TTL	No		2	Cancellation count
			\$108.52	Cancellation amount

RF-MODE TTL	No	2	Refund mode operation count *3
		\$3.74	Refund mode operation amount *3
CALCULATOR	No	10	CAL mode operation count

CASH	No	81	Cash sales count
		\$836.86	Cash sales amount
CHARGE	No	10	Charge sales count
		\$197.17	Charge sales amount
CHECK	No	9	Check sales count
		\$183.60	Check sales amount
RC	No	2	Received on Account count
		\$78.00	Received on Account amount
PD	No	1	Paid out count
		\$6.80	Paid out amount
-	No	8	Subtraction count
		\$3.00	Subtraction amount
%-	No	10	Discount count
		\$4.62	Discount amount
%+	No	1	Premium count
		\$1.00	Premium amount
REFUND	No	7	Refund key count *3
		\$27.79	Refund key amount *3
ERR CORR	No	10	Error correction count
		\$12.76	Error correction amount
#/NS	No	5	No sale count

CLERK 01	No	12	Clerk 1/clerk 1 sales count
		\$127.63	Clerk 1 sales amount

CLERK 02	No	6	Training clerk
		\$27.63	

CLERK 03	No	24	

			\$217.63

*1 Zero totalled departments (the amount and item numbers are both zero) are not printed.

*2 Taxable amount and tax amount are printed only if the corresponding tax table is programmed.

*3 These items can be skipped by programming.

Reading the cash register's program

To print unit price/rate program (except PLU)

OPERATION	REPORT																						
<div style="border: 1px solid black; border-radius: 15px; padding: 10px; width: fit-content; margin: 0 auto;"> <p>PGM mode</p> </div> <p style="text-align: center;">Mode Switch</p> <p style="text-align: center;">↓</p> <div style="display: flex; justify-content: center; align-items: center; gap: 5px;"> <div style="border: 1px solid black; padding: 2px 5px; font-weight: bold; font-size: 1.2em;">1</div> <div style="border: 1px solid black; padding: 2px 5px; font-size: 0.8em;">SUB TOTAL</div> </div> <p style="text-align: center;">↓</p> <div style="display: flex; justify-content: center; align-items: center; gap: 5px;"> <div style="border: 1px solid black; padding: 2px 5px; font-size: 0.8em;">SUB TOTAL</div> </div>	<table style="width: 100%; border-collapse: collapse;"> <tr> <td style="width: 70%;">PGM1 06-10-2002 09:30</td> <td style="width: 30%;">Mode/date/time</td> </tr> <tr> <td>CLERK 01 000010</td> <td>Clerk/consecutive No.</td> </tr> <tr> <td>PGM1.....</td> <td>Program read symbol</td> </tr> <tr> <td>DEPT01 T1 @1.00</td> <td>Dept. descriptor/tax status/unit price *1</td> </tr> <tr> <td>DEPT02 @2.00</td> <td></td> </tr> <tr> <td>DEPT23 @0.00</td> <td></td> </tr> <tr> <td>DEPT24 @0.00</td> <td></td> </tr> <tr> <td>- @0.00</td> <td>Reduction preset amount</td> </tr> <tr> <td>%- 12.34%</td> <td>Discount rate</td> </tr> <tr> <td>%+ 10%</td> <td>Premium rate</td> </tr> <tr> <td>CURR EXG 105.05</td> <td>Currency exchange rate</td> </tr> </table>	PGM1 06-10-2002 09:30	Mode/date/time	CLERK 01 000010	Clerk/consecutive No.	PGM1.....	Program read symbol	DEPT01 T1 @1.00	Dept. descriptor/tax status/unit price *1	DEPT02 @2.00		DEPT23 @0.00		DEPT24 @0.00		- @0.00	Reduction preset amount	%- 12.34%	Discount rate	%+ 10%	Premium rate	CURR EXG 105.05	Currency exchange rate
PGM1 06-10-2002 09:30	Mode/date/time																						
CLERK 01 000010	Clerk/consecutive No.																						
PGM1.....	Program read symbol																						
DEPT01 T1 @1.00	Dept. descriptor/tax status/unit price *1																						
DEPT02 @2.00																							
DEPT23 @0.00																							
DEPT24 @0.00																							
- @0.00	Reduction preset amount																						
%- 12.34%	Discount rate																						
%+ 10%	Premium rate																						
CURR EXG 105.05	Currency exchange rate																						

*1 Departments without being programmed are not printed on this report.

To print the PLU program

OPERATION	REPORT																																																						
<div style="border: 1px solid black; border-radius: 15px; padding: 10px; width: fit-content; margin: 0 auto;"> <p>PGM mode</p> </div> <p style="text-align: center;">Mode Switch</p> <p style="text-align: center;">↓</p> <div style="display: flex; justify-content: center; align-items: center; gap: 5px;"> <div style="border: 1px solid black; padding: 2px 5px; font-weight: bold; font-size: 1.2em;">6</div> <div style="border: 1px solid black; padding: 2px 5px; font-size: 0.8em;">SUB TOTAL</div> </div> <p style="text-align: center;">↓</p> <div style="display: flex; justify-content: center; align-items: center; gap: 5px;"> <div style="border: 1px solid black; padding: 2px 5px; font-size: 0.8em;">SUB TOTAL</div> </div>	<table style="width: 100%; border-collapse: collapse;"> <tr> <td style="width: 70%;">PGM6 06-10-2002 09:45</td> <td style="width: 30%;">Mode/date/time</td> </tr> <tr> <td>CLERK 01 000013</td> <td>Clerk/consecutive No.</td> </tr> <tr> <td>PGM6.....</td> <td>Program read symbol</td> </tr> <tr> <td>PLU0001 T1 0001</td> <td>Item character/tax symbol/PLU No.</td> </tr> <tr> <td>0000100000 @1.00</td> <td>Status program/unit price *1</td> </tr> <tr> <td>PLU0002 0002</td> <td></td> </tr> <tr> <td>0000000000 @2.00</td> <td></td> </tr> <tr> <td>PLU0003 0003</td> <td></td> </tr> <tr> <td>0000000000 @3.00</td> <td></td> </tr> <tr> <td>PLU0004 0004</td> <td></td> </tr> <tr> <td>0000000000 @4.00</td> <td></td> </tr> <tr> <td>PLU0005 0005</td> <td></td> </tr> <tr> <td>0000000000 @5.00</td> <td></td> </tr> <tr> <td>PLU0006 0006</td> <td></td> </tr> <tr> <td>0000000000 @6.00</td> <td></td> </tr> <tr> <td>PLU0007 T2 0007</td> <td></td> </tr> <tr> <td>0000200000 @7.00</td> <td></td> </tr> <tr> <td>PLU0008 0008</td> <td></td> </tr> <tr> <td>0000000000 @8.00</td> <td></td> </tr> <tr> <td>PLU0009 0009</td> <td></td> </tr> <tr> <td>0000000000 @9.00</td> <td></td> </tr> <tr> <td>PLU0010 0010</td> <td></td> </tr> <tr> <td>0000000000 @10.00</td> <td></td> </tr> <tr> <td>PLU0499 T2 0000</td> <td></td> </tr> <tr> <td>0000200000 @499.00</td> <td></td> </tr> <tr> <td>PLU0500 0500</td> <td></td> </tr> <tr> <td>0000000000 @500.00</td> <td></td> </tr> </table>	PGM6 06-10-2002 09:45	Mode/date/time	CLERK 01 000013	Clerk/consecutive No.	PGM6.....	Program read symbol	PLU0001 T1 0001	Item character/tax symbol/PLU No.	0000100000 @1.00	Status program/unit price *1	PLU0002 0002		0000000000 @2.00		PLU0003 0003		0000000000 @3.00		PLU0004 0004		0000000000 @4.00		PLU0005 0005		0000000000 @5.00		PLU0006 0006		0000000000 @6.00		PLU0007 T2 0007		0000200000 @7.00		PLU0008 0008		0000000000 @8.00		PLU0009 0009		0000000000 @9.00		PLU0010 0010		0000000000 @10.00		PLU0499 T2 0000		0000200000 @499.00		PLU0500 0500		0000000000 @500.00	
PGM6 06-10-2002 09:45	Mode/date/time																																																						
CLERK 01 000013	Clerk/consecutive No.																																																						
PGM6.....	Program read symbol																																																						
PLU0001 T1 0001	Item character/tax symbol/PLU No.																																																						
0000100000 @1.00	Status program/unit price *1																																																						
PLU0002 0002																																																							
0000000000 @2.00																																																							
PLU0003 0003																																																							
0000000000 @3.00																																																							
PLU0004 0004																																																							
0000000000 @4.00																																																							
PLU0005 0005																																																							
0000000000 @5.00																																																							
PLU0006 0006																																																							
0000000000 @6.00																																																							
PLU0007 T2 0007																																																							
0000200000 @7.00																																																							
PLU0008 0008																																																							
0000000000 @8.00																																																							
PLU0009 0009																																																							
0000000000 @9.00																																																							
PLU0010 0010																																																							
0000000000 @10.00																																																							
PLU0499 T2 0000																																																							
0000200000 @499.00																																																							
PLU0500 0500																																																							
0000000000 @500.00																																																							

*1 PLU without being programmed are not printed on this report.

To print key descriptor, name, message program (except PLU)

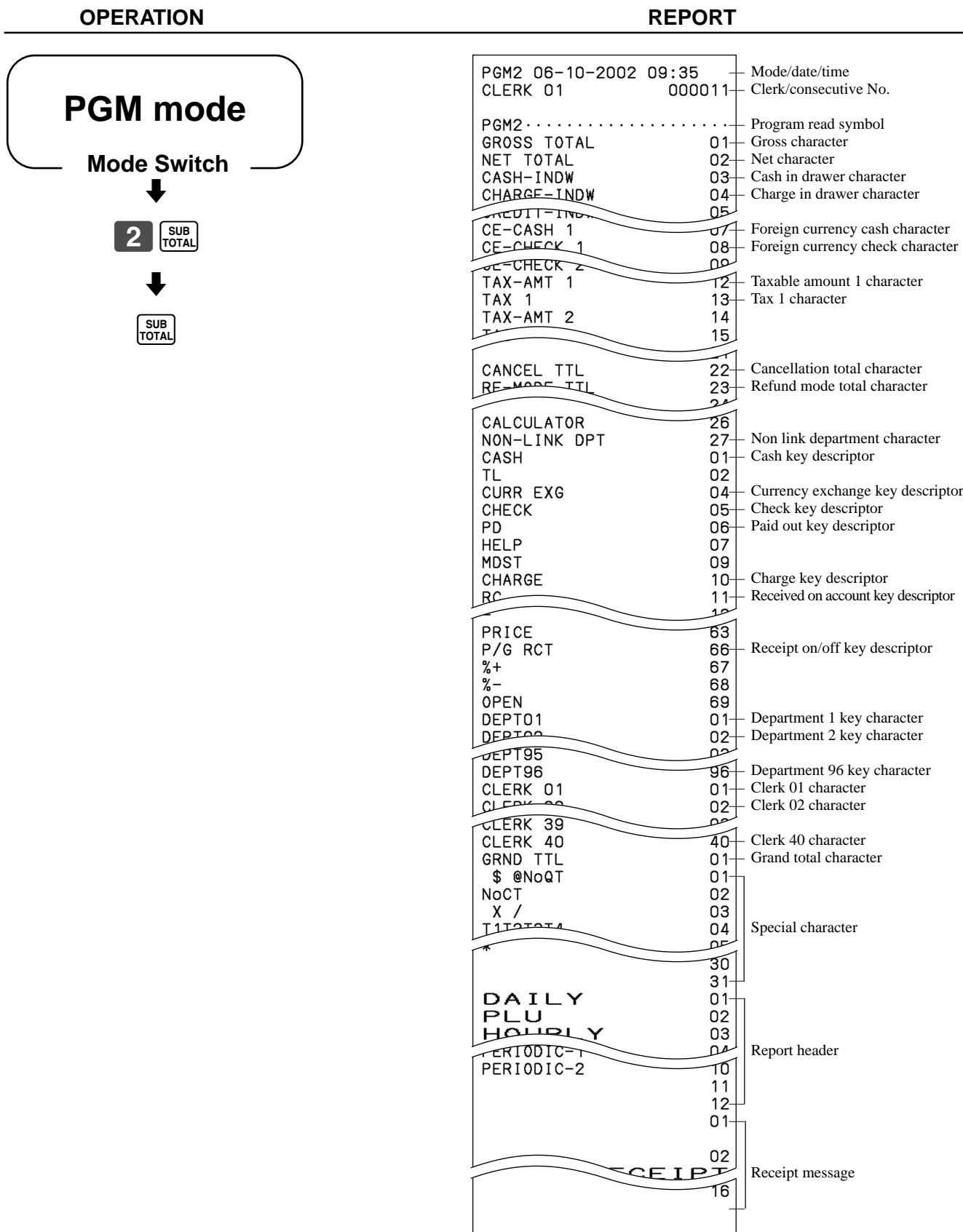

Convenient Operations and Setups

Convenient Operations and Setups

To print the print control, compulsory clerk program (except PLU)

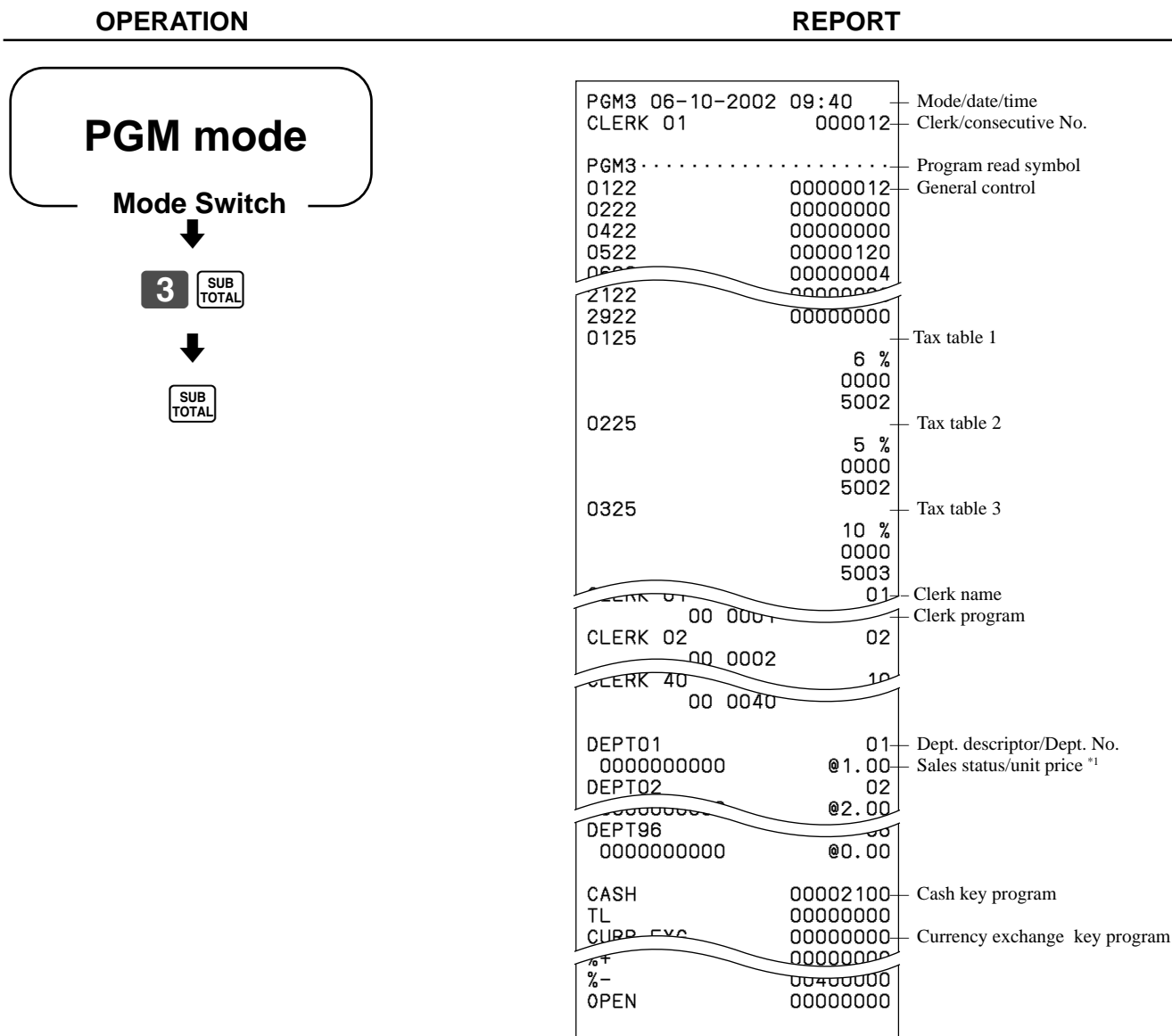

*1 Departments without being programmed are not printed on this report.

Troubleshooting

This section describes what to do when you have problems with operation.

When an error occurs

Errors are indicated by an error tone. When this happens, you can usually find out what the problem is as shown below.

Does the display show an error code?

No	Yes			
↓	↓	Error code (Message)	Meaning	Action
↓		E01 (ERR-MODE)	Mode switch position changed before finalization.	Return the mode switch to its original setting and finalize the operation.
↓		E08 (SIGN-ON)	Registration without entering a clerk number.	Enter a clerk number.
↓		E10 (PRNT-LID)	Platen arm of the printer is opened.	Close the platen arm.
↓		E11 (DRW-OPEN)	Registration is made while the cash drawer is opened.	Close the cash drawer.
↓		E12 (JPAP-END)	Journal paper end	Replace the new paper roll.
↓		E14 (RPAP-END)	Receipt paper end	Replace the new paper roll.
↓		E27 (BUF-FULL)	Transaction cancel buffer full.	Finalize the transaction.
↓		E31 (PRESS-ST)	Finalization of a transaction attempted without confirming the subtotal.	Press the  key.
↓		E33 (TEND-AMT)	Finalize operation attempted without entering amount tender.	Enter the amount tendered.
↓		E35 (CNG-OVER)	Change amount exceeds preset limit.	Input amount tendered again.
↓		E38 (DECL-AMT)	Read/reset operation without declaring cash in drawer. This error appears only when this function is activated.	Perform money declaration.
↓				

Press  key and check the appropriate section of this manual for the operation you want to perform.

When the register does not operate at all

Perform the following check whenever the cash register enters an error condition as soon as you switch it on. The results of this check are required by service personnel, so be sure to perform this check before you contact a CASIO representative for servicing.

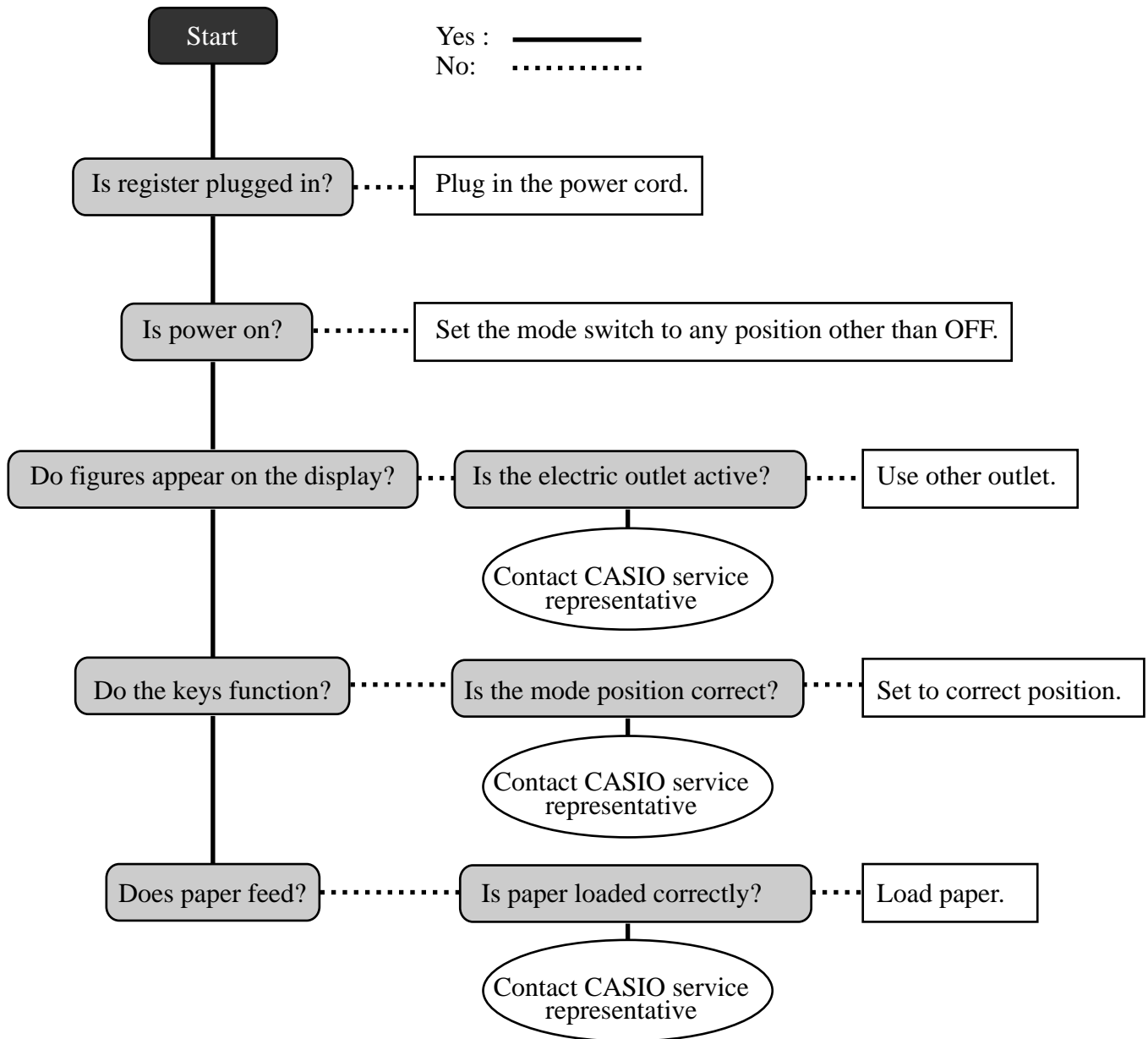

In case of power failure

If the power supply to the cash register is cut by a power failure or any other reason, simply wait for power to be restored. The details of any ongoing transaction as well as all sales data in memory are protected by the memory backup batteries.

- Power failure during a registration
The subtotal for items registered up to the power failure is retained in memory. You will be able to continue with the registration when power is restored.
- Power failure during printing a read/reset report
The data already printed before the power failure is retained in memory. You will be able to issue a report when power is restored.
- Power failure during printing of a receipt and the journal
Printing will resume after power is restored. A line that was being printed when the power failure occurred is printed in full.
- Other
The power failure symbol is printed and any item that was being printed when the power failure occurred is reprinted in full.

Important!

Once receipt/journal printing or printing of a report starts, it can be stopped only by interruption of power to the cash register.

When the L sign appears on the display

About the low battery indicator...

The following shows the low battery indicator.



If this indicator appears when you switch the cash register on, it can mean one of three things:

- No memory backup batteries are loaded in the cash register.
- The power of the batteries loaded in the unit is below a certain level.
- The batteries loaded in the unit are dead.

To clear this sign, press  key.

Important!

Whenever the low battery indicator appears on the display, load a set of three new batteries as soon as possible. If there is a power failure or you unplug the cash register when this indicator appears, you will lose all of your sales data and settings.

**BE SURE TO KEEP THE POWER CORD OF THE CASH REGISTER
PLUGGED IN WHENEVER YOU REPLACE THE BATTERIES.**

To replace journal paper



Step 1

Set the mode switch to the REG position and remove the printer cover.

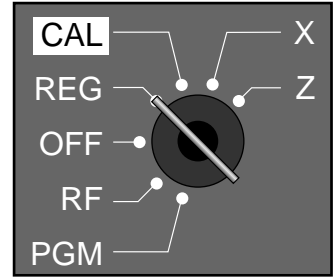

Step 2

Press **FEED** to feed about 20 cm of paper.



Step 6

Slide the printed journal from the take-up reel.



Step 3

Cut the journal paper at the point where nothing is printed.



Step 7

Open the platen arm.



Step 4

Remove the journal take-up reel from its holder.



Step 8

Remove the old paper roll from the cash register.



Step 5

Remove the paper guide from the take-up reel.

Step 9

Load new paper.

Go to the step 3 described on page 10 of this manual.

To replace receipt paper



Step 1

Set the mode switch to the REG position and remove the printer cover.

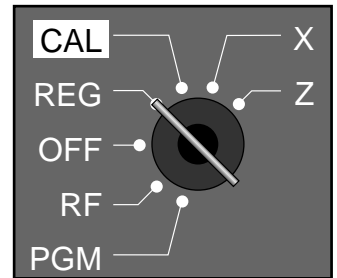

Step 2

Open the platen arm.



Step 3

Remove the old paper roll from the cash register.

Step 4

Load new paper.

Go to the step 3 described on page 9 of this manual.

NOTE:

After completion of register programming, enter **6 2 0 0** and **SUB TOTAL** in the PGM 3 mode (PGM mode ⇒ **3** **SUB TOTAL**) to backup the program data into the internal non-volatile memory. (This operation takes about 10 seconds.)

Options

WT-82 wetproof cover

The optional wetproof cover protects the keyboard from moisture damage.

Consult your CASIO dealer for details.

Specifications

Input method

Entry: 10-key system; Buffer memory 8 keys (2-key roll over)
 Department: Full key system

Display

Amount 8 digits (Zero suppression) ; No. of repeats, Receipt On/Off
 Character 8 digits; Item descriptor, Key descriptor, Mode

Printer

Printer: Dot matrix thermal printer (Receipt and journal printing)
 24 digits (Amount 10 digits/descriptor 8, 12 or 24 digits)
 Journal: Automatic take up roll winding
 Print speed: Max. 14 lines/sec.
 Feed speed: Max. 14 lines/sec.
 Paper roll: 58 mm × 80 mm Ø (Max.)
 CASIO P-5880T

Calculations

Entry 8 digits; Registration 7 digits; Total 8 digits

Chronological data

Date print: Automatic date printout on receipt or journal
 Automatic calendar
 Time print: Automatic time printout on receipt or journal
 Time display: 24-hour system

Alarm

Entry confirmation signal; Error alarm

Totalizers

Category	No. of Totalizers	Contents				Periodic Totalizer
		Amount (10 digits)	No. of items (4 digits)	Count (4 digits)	No. of customers (4 digits)	
Department	96 ^{*3} /24 ^{*4}	✓	✓ ^{*1}			✓
PLU	1600 ^{*3} /800 ^{*4}	✓	✓ ^{*1}			
Hourly sales	24	✓			✓	
Monthly	31	✓			✓	
Clerk	40 ^{*3} /15 ^{*4}	✓			✓	
Transaction	30	✓	or ✓	or ✓	or ✓	✓
Non resettable grand sales total	1	✓ ^{*2}				
Reset counter	6			✓		✓
Consecutive No.	1			✓		

*1: 4 digit integer + 2 digit decimal, *2: 12 digits, *3: for the U.S., *4: for Canada

Memory protection batteries

The effective service life of the memory protection batteries (three new SUM-3 or UM-3 type batteries) is approximately one year from installation into the machine.

Power supply/ Power consumption

As noted on the plate affixed to right side of register.

Operating temperature

0°C ~ 40°C

Humidity

10 ~ 90%

Dimensions and Weight

291mm (H) × 410mm (W) × 474mm (D) / 11.2kg with medium size drawer

* Specifications and design are subject to change without notice.

A

alphabet keys 55
arithmetic operation key 21

B

backspace/character code fixed key 55
bottom message 22

C

CAL mode 17
calculator mode 17, 21, 70
cancel 20, 42
CAPS key 55
cash amount tendered 21
change preparation 24
character code list 56
character enter key 55
character entering 55
character fixed key 55
character keyboard 55
charge 21, 36
check 21, 36
clear 20, 40
clear/all clear key 21
clerk name 50, 51
clerk number 20, 49
commercial message 22
consecutive No. range 48
consecutive number 22
correction 40
credit balance 69
currency exchange 21, 65
customer display 16, 19

D

daily sales report 43, 76
date setting 12
daylight saving time 71
decimal symbol 46
department 19, 20, 25, 27, 50, 57, 72, 76, 78
department link 59
department shift 21, 25
digit separator symbol 46
discount (percent) 20, 31, 63
display 16, 19
displaying the time 24
displaying the time and date 24
double size letter key 55
drawer 16, 18
drawer key 16
drawer lock 16
drawer open key 21
drawer release lever 18

E

equal key 21
error code 81
error correct 20, 41
error correct/cancel key 20

F

feed key 20
financial report 73
force entry of the amount tendered 69

G

grand-sales total 43, 76
group link 58, 60

H

hash department 57, 59, 60
help key 21
high amount limit 69
high digit limit 57, 59, 60, 69

I

item counter 22

J

journal 22
journal compressed print 46
journal skip 22, 46

K

key descriptor 50, 54
keyboard 16, 20

L

L sign 83
logo message 22
low battery indicator 83

M

machine number 48
main display 16, 19
memory recall 21, 70
merchandise subtotal 35
merchandise subtotal key 21
message 22
minus (reduction) 20, 33
mode key 16
mode switch 16, 17
money declaration 47, 73, 76
multiplication 20, 26
multiplication/for/date/time key 20
multipurpose tray 16, 18

- N**
- negative department 57, 59, 60
 - no sale 20, 21, 42
 - non-add 21, 36
 - non-add/no sale key 20
 - non-resettable grand total 43, 76
- O**
- open 20, 61
 - open/clerk number key 20
 - operator display 16, 19
 - operator key 16
- P**
- paid out 39
 - paid out key 21
 - paid out/tax shift 2 key 21
 - paper feed key 20
 - paper installation 9
 - paper loading 9
 - paper replacement 84, 85
 - percent 21, 31, 63
 - periodic report 77
 - PGM mode 17
 - PLU 29, 30, 53, 59, 72, 74, 78
 - PLU/subdepartment key 20
 - pop-up display 16, 19
 - post receipt 20, 45
 - post receipt/currency exchange key 20
 - power failure 83
 - preset price 27, 28, 29
 - price 20, 62
 - print subtotal 46
 - print tax rate with tax totalizer 48
 - print the sales ratio 48
 - printer 16
 - printer cover 16
 - program end key 55
 - program key 16
 - program mode 17
 - program read 78, 79, 80
 - prohibit cancel operation 47
- R**
- read mode 17
 - read report 72, 73, 74, 75, 76, 77
 - receipt message 52
 - receipt on/off 20
 - receipt on/off indicator 19
 - received on account 21, 39
 - reduction (minus) 20, 33
 - refund (return) 37, 38
 - refund key 20
 - refund mode 17
 - REG mode 17
 - register mode 17
 - repeat 19, 26, 30
 - report descriptor 50
 - report title 50, 51
 - reset mode 17
 - reset report 43, 72, 74, 75, 76, 77
 - reset the consecutive number 47
 - return 37, 38
 - RF mode 17
 - roll paper installation 9
 - roll paper specification 86
- S**
- shift key 55
 - single item sale 25, 57, 58, 60, 61, 62
 - skip zero total lines 48
 - space key 55
 - stand-by mode 17
 - store number (machine number) 48
 - subdepartment 59, 60, 62
 - subtotal 21, 26
- T**
- take-up reel 16
 - tax shift 1 20
 - tax shift 2 20
 - tax status 27, 29, 31, 33
 - ten key pad 20
 - time setting 12
 - time system (12/24Hr) 46
 - training clerk 49, 76, 77
- X**
- X mode 17
 - X report (read report) 72, 73, 74, 75, 76, 77
- Z**
- Z mode 17
 - Z report (reset report) 43, 72, 74, 75, 76, 77

LIMITED WARRANTY: ELECTRONIC CASH REGISTERS

This product, except the battery, is warranted by Casio to the original purchaser to be free from defects in material and workmanship under normal use for a period, from the date of purchase, of one year for parts and 90 days for labor. For one year, upon proof of purchase, the product will be repaired or replaced (with the same or a similar model) at Casio's option, at a Casio Authorized Service Center without charge for parts. Labor will be provided without charge for 90 days. The terminal resident software and programmable software, if any, included with this product or any programmable software which may be licensed by Casio or one of its authorized dealers, is warranted by Casio to the original licensee for a period of ninety (90) days from the date of license to conform substantially to published specifications and documentation provided it is used with the Casio hardware and software for which it is designed.

For a period of ninety (90) days, upon proof of license, Casio will, at its option, replace defective terminal resident software or programmable software, correct significant program errors, or refund the license fee for such software. Significant program errors will be significant deviations from written documentation or specifications. These are your sole remedies for any breach of warranty. In no event will Casio's liability exceed the license fee, if any, for such software. This warranty will not apply if the product has been misused, abused, or altered.

Without limiting the foregoing, battery leakage, bending of the unit, a broken display tube, and any cracks or breaks in the display will be presumed to have resulted from misuse or abuse. To obtain warranty service you must take or ship the product, freight prepaid, with a copy of the sales receipt or other proof of purchase and the date of purchase, to a Casio Authorized Service Center. Due to the possibility of damage or loss, it is recommended when shipping the product to a Casio Authorized Service Center that you package the product securely and ship it insured. CASIO HEREBY EXPRESSLY DISCLAIMS ALL OTHER WARRANTIES, EXPRESS OR IMPLIED, INCLUDING ANY IMPLIED WARRANTY OF MERCHANTABILITY OR OF FITNESS FOR A PARTICULAR PURPOSE. NO RESPONSIBILITY IS ASSUMED FOR ANY INCIDENTAL OR CONSEQUENTIAL DAMAGES, INCLUDING WITHOUT LIMITATION DAMAGES RESULTING FROM MATHEMATICAL INACCURACY OF THE PRODUCT OR LOSS OF STORED DATA. SOME STATES DO NOT ALLOW THE EXCLUSION OR LIMITATION OF INCIDENTAL OR CONSEQUENTIAL DAMAGES, SO THE ABOVE LIMITATIONS OR EXCLUSIONS MAY NOT APPLY TO YOU. This warranty gives you specific rights, and you may also have other rights which vary from state to state.

CASIO, INC.
570 MOUNT PLEASANT AVENUE,
P. O. BOX 7000, DOVER, NEW JERSEY 07801 U.S.A.

Model:..... Serial Number:..... Date of Purchase:.....

Your Name:.....

Address:.....

Dealer's Name:.....

Address:.....

CASIO®

CASIO COMPUTER CO., LTD.
6-2, Hon-machi 1-chome
Shibuya-ku, Tokyo 151-8543, Japan

MO0304-D Printed in Indonesia
PCR-T2000*E

Free Manuals Download Website

<http://myh66.com>

<http://usermanuals.us>

<http://www.somanuals.com>

<http://www.4manuals.cc>

<http://www.manual-lib.com>

<http://www.404manual.com>

<http://www.luxmanual.com>

<http://aubethermostatmanual.com>

Golf course search by state

<http://golfingnear.com>

Email search by domain

<http://emailbydomain.com>

Auto manuals search

<http://auto.somanuals.com>

TV manuals search

<http://tv.somanuals.com>