

PondMAX

WATERGARDENING TO THE MAX

PRESSURE FILTER/ UV CLARIFIERS

INSTRUCTION MANUAL



AQUATEC
EQUIPMENT

HOTLINE 1300 AQUATEC

VERSION
MARCH 2016

www.aquatecequipment.com

MODEL
03PE277 - PF2500
03PE278 - PF2500UV
03PE280 - PF4500UV
03PE281 - PF9000UV
03PE282 - PF14000UV
03PE284 - PF20000UV
03PE285 - PF30000UV
03PE286 - PF50000UV



WELCOME TO THE WORLD OF PONDMAX™.
YOU MADE THE **RIGHT** CHOICE INVESTING IN THIS
QUALITY PRODUCT. THANK YOU AND **ENJOY.**

BEFORE USING THIS PRODUCT, PLEASE READ THESE INSTRUCTIONS OF USE CAREFULLY AND MAKE YOURSELF FULLY FAMILIAR WITH THE UNIT. PLEASE KEEP THESE INSTRUCTIONS IN A SAFE PLACE FOR FUTURE REFERENCE.

TECHNICAL SPECIFICATIONS

DESCRIPTION	PF2500 (NO UVC)	PF2500UV	PF4500UV	PF9000UV	PF14000UV	PF20000UV	PF30000UV	PF50000UV
PRODUCT CODE	03PE277	03PE278	03PE280	03PE281	03PE282	03PE284	03PE285	03PE286
MAXIMUM POND SIZE WITHOUT FISH SHADED (L)	1,500	2,500	4,500	9,000	14,000	20,000	30,000	50,000
MAXIMUM POND SIZE WITH FISH FULL SUN (L)	1,000	1,000	3,000	4,500	8,000	11,000	15,000	25,000
MAXIMUM FLOW RATE (L/H)	1,500	1,500	3,600	4,500	8,000	11,000	15,000	25,000
VOLTS	N/A	240	240	240	240	240	240	240
ULTRAVIOLET CLARIFIER (UVC)	N/A	9	11	11	18	36	55	55
FILTER VOLUME (L)	16	16	20	25	35	50	75	170
RECOMMENDED TUBING SIZE	25	25	32	40	40	50	50	50
DIMENSIONS (L&W X H IN MM)	310 x 405	310 x 405	380 x 410	380 x 520	380 x 730	450 x 550	450 x 715	600 x 815
CABLE LENGTH (M)	N/A	5	5	5	5	5	5	5

PF2500 - PF50000UV PRESSURE FILTER / UV CLARIFIER



IMPORTANT SAFEGUARDS

Please read the operating instructions and familiarise yourself with the equipment before placing it in service. Correct and safe use of the system requires strict compliance with the safety instructions. For safety reasons, persons less than 16 years of age or infirm persons that are not familiar with these instructions should not use this equipment.

- For your own safety, disconnect from the power supply before any maintenance of any equipment is attempted on the tank or water body.
- Do not operate the filter if any components of the system, such as the power cable, have been damaged.
- If required, have a qualified electrician install a weather proof power point near to the pond or water feature (within the cable length of the filter).
- Always use a properly grounded power supply that is connected to an RCD with a rated residual operating current not exceeding 30mA. As per AS/NZS 3350.2.41:1997
- The drip loop method should be used to prevent water from traveling down the cable and onto the plug or power supply. If the plug does get wet, do not unplug the cable. Disconnect the circuit breaker that supplies power to the power supply point. Then unplug and examine the plug and power supply point for presence of water. If the power point has become wet, you should consult an electrician before using the power point again.
- Always unplug the pump from the power supply when not in use or before performing any maintenance on the pump or on the aquarium. Never pull the power cord to disconnect the plug from the power supply. Grasp the plug and pull to disconnect. Care should be taken to arrange the power cable so that it cannot be accidentally tripped over or pulled.
- Do not install or store the appliance where it will be exposed to extreme hot or cold temperatures. Do not use with water above 35 ° C.
- Do not cut the cable as this will result in voiding your warranty. The power cord cannot be replaced. If the cord is damaged, the filter must be discarded.
- Do not attempt to repair the electrical appliance yourself. Return to an authorized service centre or place of purchase if a fault occurs, (regular maintenance is not considered repair and is required by user).

PRODUCT SPECIFIC SAFEGUARDS

- Do not submerge this filter in water!
- Do not operate the filter without water at any time, permanent damage may occur.
- Do not look at an unshielded UV-C globe. Ultra Violet light is harmful to your eyes and may cause blindness.
- Do not over pressurise. Max head pressure is 3m.
- The filter is designed to be used in pond environment. It is not to be used in any other manner or purpose. The filter should only be used with water. Do not use the filter with any harsh chemicals such as a solvent or petrol.
- All pumps and filters are water cooled. If the flow becomes restricted it could cause permanent damage. The filter needs to be cleaned regularly to prevent the filter becoming blocked, thus causing damage. This is not a warrantable event.



BENEFITS

Your PondMAX pond filter has been manufactured with advanced technology to provide you with the best quality filter for your pond water.

- The easy-clean backwash function, back flushes the filter, and compresses the foam sponge media aiding easy cleaning. The back-flush function completely reverses the flow, to aid with removing sludge build-up in the bottom of the filter.
- In normal operation the water enters the filter and is forced around the perimeter creating a vortex where larger particles are precipitated through gravity and the smaller particles get caught as they flow through the sponge filters horizontally.
- The yellow and blue filter sponges differ in density. The higher density foam allows the water to pass through at a slower flow rate promoting colonization of Nitrosomonas bacteria and the lower density sponge allows the water to pass through faster promoting colonization of Nitrobacta bacteria. The large surface area of the Bio-spheres aid biological filtration and ensures maximum biological purifying action. The water is then cleaned by the Ultraviolet ray which inhibits algae growth and the clean water exits the filter back into the pond

- 1 Hose Inlet from Pump
- 2 Perimeter direction of water flow creating vortex for particle precipitation
- 3 Sponge Bio-media for Mechanical Filtration
- 4 Biological Spheres
- 5 UVC Chamber
- 6 Hose Outlet for return back to pond
- 7 Waste Water Outlet
- 8 Back Flush Handle
- 9 Easy Clean Handle



IMPORTANT

These accessories and attachments are recommended for use with your PondMAX product specified in this manual. The use of any other accessories or attachments might present a risk of injury to persons. Only use the accessory or attachment for its stated purpose.

NOTE: Parts may differ slightly from shown

PF2500 - PF50000UV

PRESSURE FILTER / UV CLARIFIER

INSTALLATION

Identify a suitable location for your new pressure filter.

- Do not submerge this product in water. The pressure filter should be used inline, between a pump and a water feature or waterfall. The filter can also be partially buried to help disguise it in your garden.
- Place the filter on a firm and level base, e.g. on a slab. Please make sure that there is unhindered access to the lid in order to be able to carry out maintenance on the filter, e.g. cleaning the filter sponges.
- It is good practise to design the plumbing beforehand. Ensure the pipes are laid out such that the clean filtered water return is to the opposite end of your pond to where the pump suction is located. This aids circulation and is to avoid stagnant spots.
- Select the hose tail, locking nut, and flat rubber washer. Assemble as per diagram. Insert into the end of tubing.
- Connect anti-kink hose or poly tubing from your pump outlet to the inlet of the filter.
- If your filter has a three step hose tail to suit smaller tubing, then be sure to cut off the hose tails that are smaller than the hose size you are using. For example, If using 40mm hose, cut off the 25 & 32mm sections. Please use the largest size tubing possible. We recommend using PondMAX hose clamps for a leak free connection.
- Connect the tubing from the outlet of the filter back into your pond at the opposite end to where you are pumping from. It's possible to have the outlet of the filter running into a waterfall. You only need to connect tubing to the back-flush outlet if you require the dirty water from the backwash to be diverted to a specific location.
- If the flow from your pump is greater than the recommended max flow, you must reduce the flow, or bypass some of the water with a Y junction piece between the pump and the filter. The flow of water through branch of the Y junction can be varied by use of an optional valve. The pressure must not exceed 3M head pressure.
- The filter must be operational 24 hours every day for it to function effectively.
- Turn your pump on and then plug in the UV-C unit on the filter. The UV-C unit should not be turned on if there is no water flowing post the UV-C unit.
- It is recommended to boost the biological function of your filter with PondMAX Bacteria. This will greatly increase the efficiency of the unit.
- Now sit back, relax and enjoy a clean and healthy pond.

CLEANING INSTRUCTIONS

Begin by ensuring that the mains power supply is disconnected before attempting any maintenance or adjustment of the unit or the water body. Remove the unit from the water.

The filters and sponges in this unit will clog over time. Please clean regularly (at least once a month) to ensure strong water flow. Failure to maintain the unit will result in a burnt out motor and other damage.

- Disconnect power cord from the power supply before performing maintenance. Never lift the filter by the power cord.
- Check the UV-C globe regularly and replace every 11 months – 8 000 operating hours. Failure to replace the globe before the end of its life span may cause electrical damage. Also, the globe UV intensity diminishes over time. To visually check the globe, look through the clear UV-C indicator on the top of the filter and if the light is working you will see a faint purple glow. This may have to be done at night to see distinctly.

USING THE BACKWASH

Whilst the filter is still functioning, connect tubing to the backflush outlet of the filter. You can divert the dirty water into a garden bed or into a drain. Turn the valve on the backwash outlet to open.

- Now turn the backwash arrow shaped dial on the top of the filter to "clean" mode. (The arrow will face towards the ball valve backwash outlet). The water from the normal outlet will now be diverted through the backwash outlet.
- Turn the cleaning handle anti-clockwise on the filter several times (24-36 times) or until the water exiting the backflush outlet runs clean. This squeezes the filter sponges and cleans them mechanically.
- Maintain the filter sponge regularly according to how quickly the sponge gets clogged. When the flow starts to be reduced, check and clean if necessary. This depends on your water volume and how many fish you are keeping. Some may have to do this weekly.

The best time to physically remove and clean your filter is when completing a 20% water change, as you can use the pond water you are discarding to clean all of the parts of your spongers. Using tap water will kill the good beneficial bacteria, found in filter sponges, with the chlorine that is found in tap water.

- You can help boost the biological function of your filter sponge with a bacterial additive. This is available from your local stockist.

FULLY DISASSEMBLE & RINSE

Turn off your pump and disconnect the power cord from any electrical source. Undo the threaded inlet and outlets hoses from the filter, unclip the lid clamp and carefully remove the lid.

- Take care not to lose or damage the O'ring seal. Unscrew the clear locking screw at the bottom of the filter sponge layers (or the black base plate on the bigger models). Undo the screw that holds the S/Steel shaft in place and remove the base plate. Now remove the foam sponge rings from off the centre cores and rinse them in dechlorinated water or pond water.
- Be sure to thoroughly squeeze the sponges to remove sludge.
- Remove the high efficiency bio media cassette (in the larger models) from the bottom of the filter canister. Only remove any excess brown sludge from the biospheres. You should not remove all of this brown matter as this is the beneficial bacteria, which is essential in the breakdown of toxic waste from your pond.
- Now clean out the canister of your filter and any debris from the lid of the filter and then reassemble. First reassemble the partially cleaned bio media cassette into the canister and then insert lid with the foam rings installed onto the centre core. The Foam rings should alternate from Blue to Yellow.
- Now put the lid back in place, taking care to locate the O'ring in the correct position. See diagram. To lubricate the O'ring use a food safe grease. Aquatec Equipment recommends the use of Inox MX6.



Firmly push the lid back onto the canister. Fasten the lid clamp in place and reconnect the inlet and outlet hoses.

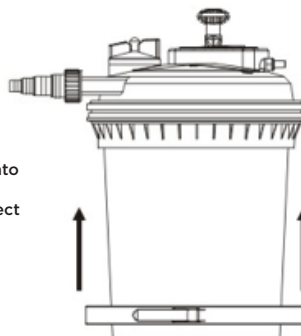

Now plug the pump and filter UV light back in, turn on, and sit back and enjoy your watergarden.

PF2500 - PF50000UV PRESSURE FILTER / UV CLARIFIER

REPLACING THE UV GLOBE

Replacement UV Globes can be purchased from your local stockist or ordered from Aquatec Equipment.

- Turn off power supply to the filter and remove plug from power outlet. Turn off your water pump.
- Undo the 4 screws on the top of the filter holding the UV-C Assembly in place.
- Carefully lift up the UV•C Assembly out of the filter lid. Take care not to impact the quartz sleeve on anything - it will break.
- Undo the quartz sleeve locking nut at the top of the quartz sleeve. Take care not to lose the quartz sleeve O' ring and collar.
- Carefully remove the quartz sleeve from the UV•C assembly. Clean the Quartz sleeve to remove any algae or lime scale build-up. Place in a secure position.
- You can now access the globe to replace it. Pull out the old globe and discard responsibly. Insert a new globe ensuring it is connected securely.
- Replace the quartz sleeve onto the UV•C assembly ensuring the O-rings and collar is located properly. Replace and tighten the quartz sleeve locking nut.
- Replace the UV-C assembly into the top of the filter ensuring it fits securely. Tighten the 4 screws fixing the assembly into the filler lid.
- Turn your water pump back on, and then reconnect power supply, and turn on your filter. You have successfully replaced your UV-C globe .



SPARE PARTS: PF2500 / PF2500UV

PART NO.	DESCRIPTION	PF2500	PF2500UV
1	Electrical Ballast and Lamp Holder Assembly Complete	-	13PF012
	Blank Lamp Holder with No UV or Electrical parts	13PF013	-
2 & 3	Ballast 72mm x 2.65mm O'ring and Plastic O'ring Holder Set	13PF005	
4	Two pin UV Globe - 240V - 9W - PondMax	-	11AU178
	Two pin UV Globe - 240V - 9W - Osram - long life	-	11PS165
	Two pin UV Globe - 240V - 7W - PondMax	-	11AU271
	Two pin UV Globe - 240V - 7W - Osram - long life	-	11PS299
5	48mm x 3.1mm O'ring (Clear Silicone x2) or (Twin-Red x1)	11PR868	
6	Quartz Glass Sleeve - Ø44.5 x 1.5 x 205mm	-	13PF014
7	Quartz Sleeve locking Nut	13PF016	
8	Filter Lid	AVAILABLE ON REQUEST	
9	Sponge - Yellow - Fine - (without Spool) Ø230x50	(2x) 13PF017	
	Sponge - Blue - Coarse - (without Spool) Ø230x50	(2x) 13PF018	
10	Black Plastic Base Plate	AVAILABLE ON REQUEST	
11	Clear Base Anchor Screw	13PF006	
12	Lid Clamp - Plastic - Ø312mm	13PF019	
13	Lid O'ring - Ø265mm x 6mm	13PF020	
14	Filter Base Bucket 16L	13PF021	
15	Stainless Steel Machine Screw	AVAILABLE ON REQUEST	
16	Stainless Steel Washer	AVAILABLE ON REQUEST	
17	Bush Bearing	AVAILABLE ON REQUEST	
18	Stainless Steel Shaft with Rotating Cleaning Flapper Assembly	13PF022	
19	Middle Bush Bearing Seal	AVAILABLE ON REQUEST	
20	O'rings 13mm x 3.1mm x 2	AVAILABLE ON REQUEST	
21 & 22	Hose tails and Locking Nuts - 19mm, 25mm, 32mm (x 3)	13PF023 Kit	
	Hose tail O'rings Set x 3		
23	Shaft and Lid Bearing Bush	AVAILABLE ON REQUEST	
24	Square Shaft Connector	AVAILABLE ON REQUEST	
25	Easy Clean Handle	11MC930	

NOT SHOWN - Clear Lamp Holder Assembly Blanking Plug (PF2500) - 13PF015

SERVICE KITS

2, 5, 9,(2x Y, 2x B), 13, 21(x3), 22(x3)	Service Kit for Pressure filter PF2500 - "No UVC"	11PR868	-
2, 4, 5, 9,(2x Y, 2x B), 13, 21(x3), 22(x3)	Service Kit for Pressure Filter PF2500UV	-	13PF014

PF2500 - PF50000UV PRESSURE FILTER / UV CLARIFIER

MODEL SHOWN
PF2500UV

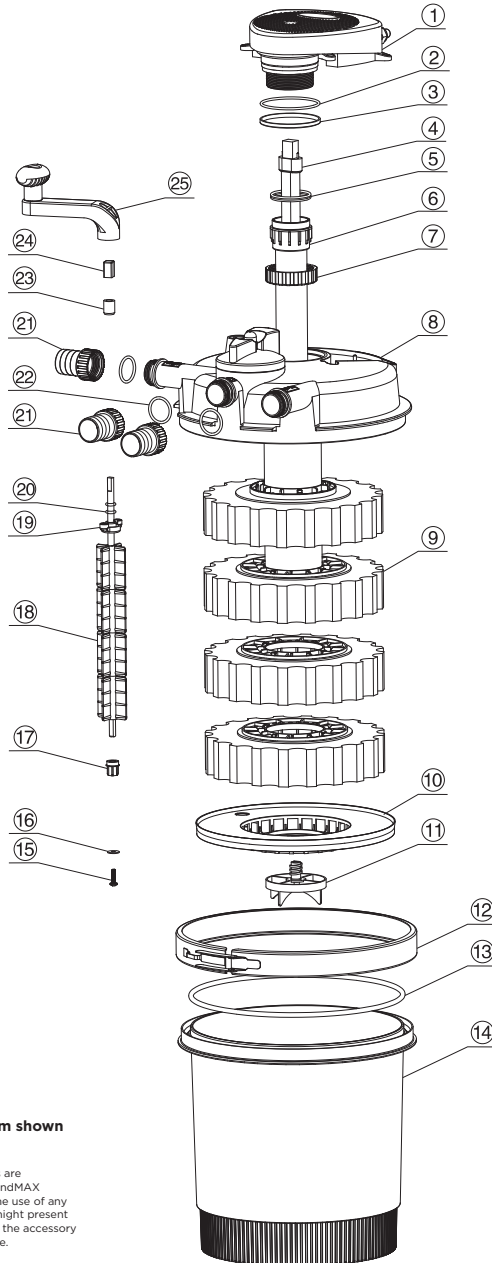

NOTE: Parts may differ slightly from shown



IMPORTANT

These accessories and attachments are recommended for use with your PondMAX product specified in this manual. The use of any other accessories or attachments might present a risk of injury to persons. Only use the accessory or attachment for its stated purpose.

SPARE PARTS: PF4500UV (11W)

PART NO.	DESCRIPTION	PF4500UV
1	UV Inspection Glass	11MC940
	UV Ballast Cover	
	Ballast	
	Earth Plate	
	Switch Bracket	
	Safety Toggle Switch	
	Plastic UV Ballast Mount	
2 & 3	Ballast 72mm x 2,65mm O'ring and Plastic O'ring Holder Set	13PF005
4	Two pin UV Globe - 240V - 11W - PondMax	11AU179
	Two pin UV Globe - 240V - 11W - Osram - long life	11PS265
5	48mm x 3,1mm O'ring (Clear Silicone x2) or (Twin-Red x1)	11PR868
6	Quartz Glass Sleeve - 11W - Ø44,5 x 1,5 x 205mm	11PR867
7	Quartz Sleeve locking Nut	13PF010
8	Filter Lid	AVAILABLE ON REQUEST
9	Sponge - Yellow - Fine - (without Spool) Ø260 x 50	(2 x) 11MC922
	Sponge - Blue - Yellow - (without Spool) Ø260 x 50	(2 x) 11MC921
10	Base Plate	AVAILABLE ON REQUEST
11	Base Anchor Screw - Clear	13PF006
12	Lid Clamp - Plastic - Ø375mm	11MC923
13	Lid O'ring 346mm x 8,0mm	11MC925
14	Filter Base Bucket	AVAILABLE ON REQUEST
15	Easy Clean Handle	11MC930
16	Square Shaft connector	AVAILABLE ON REQUEST
17	Shaft and Lid Bearing Bush	AVAILABLE ON REQUEST
18	Inlet and Outlet Gasket Washer x 3	KIT CODE 11MC924 *
19	Stepped Hose Tail x2	
20	Inlet/Outlet Locking Nut x2	
21	Rotating Cleaning Flapper	AVAILABLE ON REQUEST
22	Lower Bush Bearing	AVAILABLE ON REQUEST
23	Stainless Steel Washer	AVAILABLE ON REQUEST
24	Stainless Steel Machine Screw	AVAILABLE ON REQUEST

NOT SHOWN - Back Flush Outlet Valve - *Kit Code 11MC924

SERVICE KITS

2, 4, 5, 9, (2x Y, 2x B), 13, 18.(x3), 19.(x3), 20.(x3)	Service Kit for Pressure filter PF4500UV	13PF043
---	--	---------

PF2500 - PF5000UV PRESSURE FILTER / UV CLARIFIER

MODEL SHOWN
PF4500UV

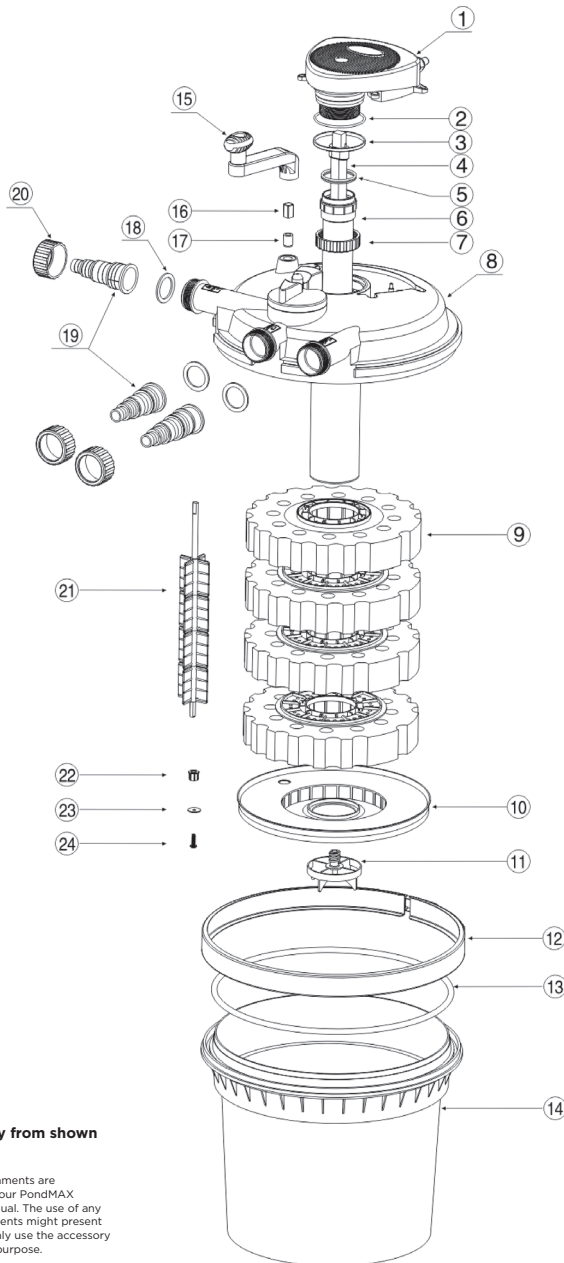

NOTE: Parts may differ slightly from shown



IMPORTANT

These accessories and attachments are recommended for use with your PondMAX product specified in this manual. The use of any other accessories or attachments might present a risk of injury to persons. Only use the accessory or attachment for its stated purpose.

SPARE PARTS: PF9000UV(11W) / PF14000UV (18W)

PART NO.	DESCRIPTION	PF9000UV	PF14000UV
1	UV Inspection Glass	11MC940	11PR889
	UV Ballast Cover		
	Ballast		
	Earth Plate		
	Switch Bracket		
	Safety Toggle Switch		
	Plastic UV Ballast Mount		
2 & 3	Ballast 72mm x 2.65mm O'ring and Plastic O'ring Holder Set	11MC926	
4	Two pin UV Globe - 240V - 11W - PondMax	11AU179	-
	Four pin UV Globe - 240V - 18W - PondMax	-	11AU180
	Two pin UV Globe - 240V - 11W - Osram - long life	11PS265	-
	Four pin UV Globe - 240V - 18W - Osram - long life	-	11PS166
5	48mm x 3.1mm O'ring (Clear Silicone x2) or (Twin-Red x1)	11PR868	
6	Quartz Glass Sleeve - 11W & 18W - Ø44.5x1.5x205	11MC927	
7	Quartz Sleeve locking Nut	13PF011	
8	Filter Lid	AVAILABLE ON REQUEST	
9	Sponge - Yellow - Fine - (with out Spool) Ø260x50	(3x) 11MC922	(4x) 11MC922
	Sponge - Blue - Course - (with out Spool) Ø260x50	(2x) 11MC921	(3x) 11MC921
10	Base Plate	AVAILABLE ON REQUEST	
11	Pointed Plastic Flow Diverter Grate - Black	13PF007	13PF008
12	Biological Media Cassette - Top Cover	13PF038	(2x) 13PF038
13	Biological Spheres - 45mm	(24x) 13PF039	(48x) 13PF039
14	Biological Media Cassette - Slotted Basket	13PF040	(2x) 13PF040
15	Lid Clamp - Plastic - 375mm	11MC925	
16	Lid O'ring 346mm x 8.0mm	11MC923	
17	Filter Base Bucket	AVAILABLE ON REQUEST	
18	Easy Clean Handle	11MC930	
19	Square Shaft connector	AVAILABLE ON REQUEST	
20	Shaft and Lid Bearing Bush	AVAILABLE ON REQUEST	
21	Inlet and Outlet Gasket Washer x 3	Kit Code 11MC924 *	
22	Stepped Hose Tail x2		
23	Inlet/Outlet Locking Nut x2		
24	Rotating Cleaning Flapper	AVAILABLE ON REQUEST	
25	Back Flush S/Steel Shaft Lower Bush	AVAILABLE ON REQUEST	
26	Stainless Steel Washer	AVAILABLE ON REQUEST	
27	Stainless Steel Machine Screw	AVAILABLE ON REQUEST	

NOT SHOWN - Back Flush Outlet Valve - *Kit Code 11MC924

PF2500 - PF50000UV PRESSURE FILTER / UV CLARIFIER

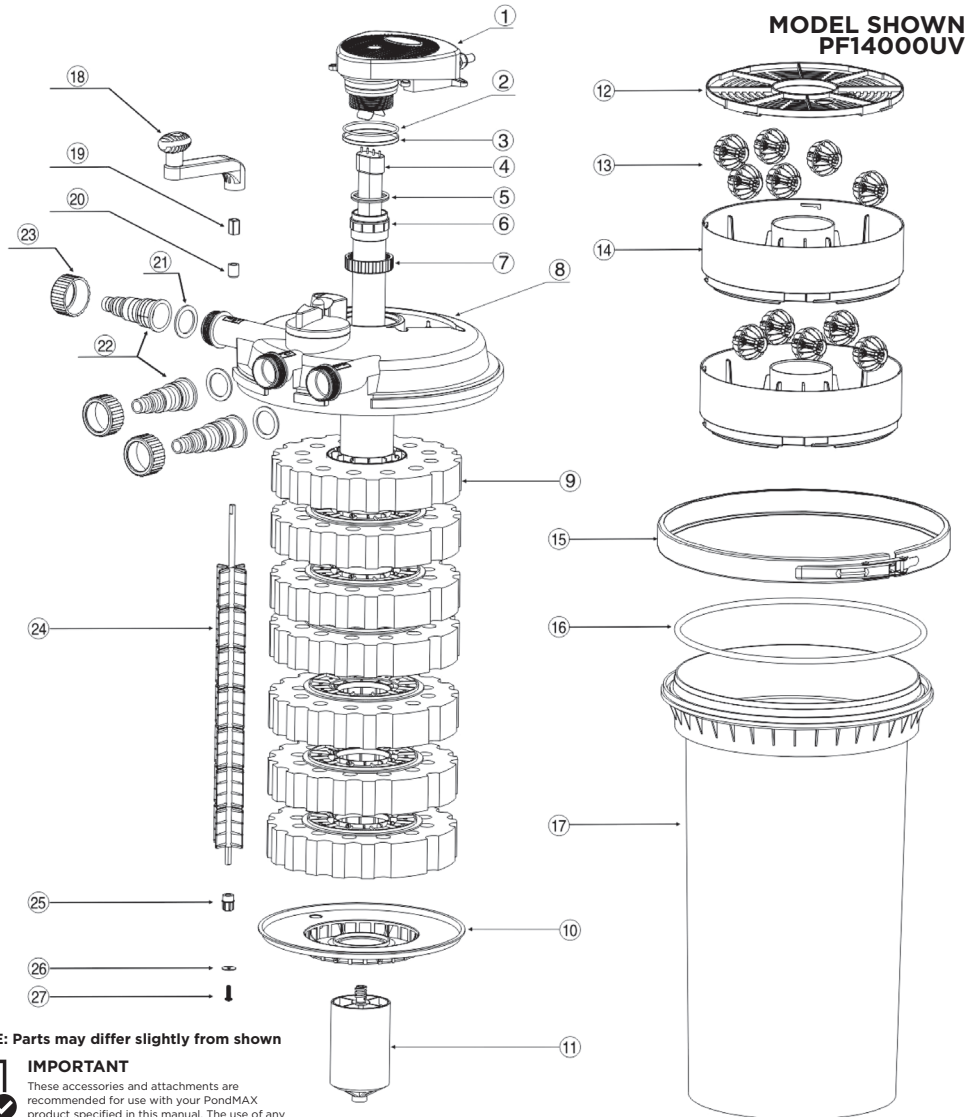

NOTE: Parts may differ slightly from shown



IMPORTANT

These accessories and attachments are recommended for use with your PondMAX product specified in this manual. The use of any other accessories or attachments might present a risk of injury to persons. Only use the accessory or attachment for its stated purpose.

SERVICE KITS

		PF9000UV	PF14000UV
2, 4, 5, 9,(3x Y, 2x B), 16, 21.(x3), 22.(x3), 23.(x3)	Service Kit for Pressure filter PF9000UV	13PF044	-
2, 4, 5, 9,(4x Y, 3x B), 11, 16, 21. (x3), 22.(x3), 23. (x3)	Service Kit for Pressure filter PF14000UV	-	13PF045

SPARE PARTS: PF20000UV (36W) / PF30000UV (55W)

PART NO.	DESCRIPTION	PF20000UV	PF30000UV
1	Electrical Ballast and Lamp Holder Assembly Complete - 36W	13PF024	-
	Electrical Ballast and Lamp Holder Assembly Complete - 55W	-	13PF025
2 & 3	Ballast 72mm x 2.65mm O'ring and Plastic O'ring Holder Set	13PF005	
4	Two pin UV Globe - 240V - 36W - PondMax	11AU181	-
	Two pin UV Globe - 240V - 36W - Osram - long life	11PS167	-
	Two pin UV Globe - 240V - 55W - PondMax	-	11PS396
	Two pin UV Globe - 240V - 55W - Philips - long life	-	11PS168
5	48mm x 3.1mm O'ring (Clear Silicone x2) or (Twin-Red x1)	11PR868	
6	Quartz Glass Sleeve - 36W - Ø44.5 x 1.5 x 389.5mm	13PF026	-
	Quartz Glass Sleeve - 55W - Ø44.5 x 1.5 x 510mm	-	13PF027
7	Quartz Sleeve locking Nut	13PF010	
8	Filter Lid	AVAILABLE ON REQUEST	
9	Sponge - Yellow - Fine - (without Spool) Ø360 x 50mm	(3x) 13PF028	(4x) 13PF028
	Sponge - Blue - Coarse - (without Spool) Ø360 x 50mm	(2x) 13PF029	(3x) 13PF029
10	Black Plastic Base Plate	AVAILABLE ON REQUEST	
11	Diversion Tube - Base Anchor Screw	13PF020	
12	Large Filter Basket - with removable slotted cover - No bio media	13PF031	(2x) 13PF031
13	Lid Clamp - Steel - Ø458mm	13PF032	
14	Lid O'ring - Ø421 x 7.5mm	13PF033	
15	Filter Base Bucket 50L or 75L	AVAILABLE ON REQUEST	
16	Stainless Steel Machine Screw	13PF034	
17	Stainless Steel Washer	13PF035	
18	Lower Bush Bearing	AVAILABLE ON REQUEST	
19	Stainless Steel Shaft with Rotating Cleaning Flapper Assembly	AVAILABLE ON REQUEST	
20	Hose tails Locking Nut x2	13PF036	
21	Hose tails (2x), and Ball Valve (1x) - Size 40mm & 50mm		
22	Hose tail O'rings - Flat Washer - Set of 3		
23	Shaft and Lid Bearing Bush	AVAILABLE ON REQUEST	
24	Square Shaft connector	AVAILABLE ON REQUEST	
25	Easy Clean Handle - Large	13PF037	

SERVICE KITS

2, 4, 5, 9, (3x Y; 2x B), 14, 20 (x3), 21 (x3), 22 (x3)	Service Kit for Pressure filter PF20000UV	13PF046	-
2, 4, 5, 9, (4x Y; 3x B), 14, 20 (x3), 21 (x3), 22 (x3)	Service Kit for Pressure filter PF30000UV	-	13PF047

PF2500 - PF50000UV PRESSURE FILTER / UV CLARIFIER

MODEL SHOWN
PF30000UV

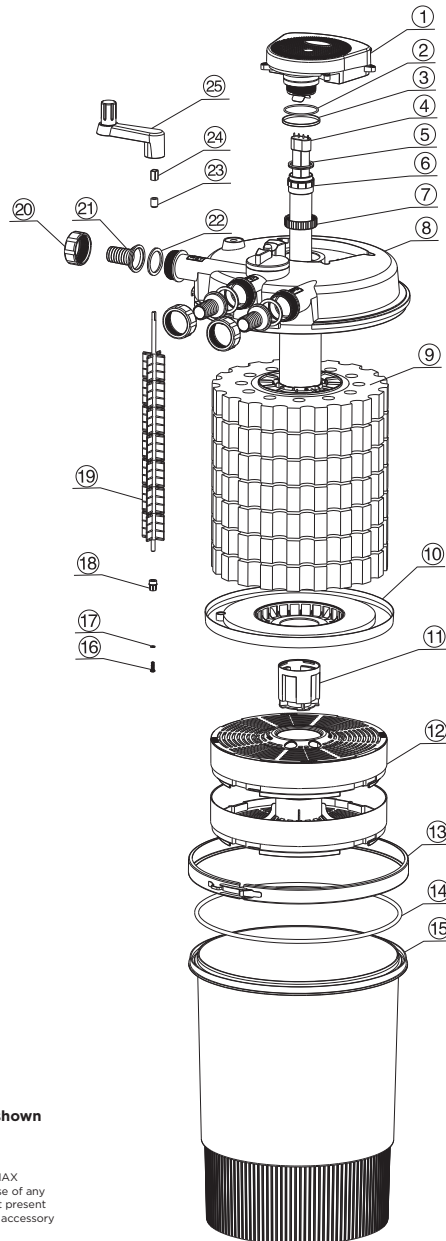

NOTE: Parts may differ slightly from shown



IMPORTANT

These accessories and attachments are recommended for use with your PondMAX product specified in this manual. The use of any other accessories or attachments might present a risk of injury to persons. Only use the accessory or attachment for its stated purpose.

WATERGARDENING TO THE MAX

SPARE PARTS: PF50000UV (55W)

PART NO.	DESCRIPTION	PF50000UV
1	Electrical Ballast and Lamp Holder Assembly Complete - 55W	13PF025
2 & 13	Ballast 72mm × 2.65mm O'ring and Plastic O'ring Holder Set	13PF005
3	Easy Clean Handle - Large	13PF037
11	Shaft and Lid Bearing Bush	AVAILABLE ON REQUEST
4	Square Shaft connector	AVAILABLE ON REQUEST
5	Hose tails Locking Nut x2	13PF005
6	Hose tails (2x), and Ball Valve (1x) - Size 40mm & 50mm	
12	Hose tail O'rings - Flat Washer - Set of 3	
7	Stainless Steel Shaft with Rotating Cleaning Flapper Assembly	AVAILABLE ON REQUEST
8	Lower Bush Bearing	AVAILABLE ON REQUEST
9	Stainless Steel Washer	13PF035
10	Stainless Steel Machine Screw	13PF034
14	Two pin UV Globe - 240V - 55W - PondMax	11PS396
	Two pin UV Globe - 240V - 55W - Philips - long life	11PS168
15	48mm × 3.1mm O'ring (Clear Silicone x2) or (Twin-Red x1)	11PR868
16	Quartz Glass Sleeve - 55W - Ø44.5 × 1.5 × 510mm	13PF027
17	Quartz Sleeve locking Nut	13PF010
18	Filter Lid	AVAILABLE ON REQUEST
19	Sponge - Yellow - Fine - (without Spool) Ø360 × 50mm	(4x) 13PF028
	Sponge - Blue - Coarse - (without Spool) Ø360 × 50mm	(3x) 13PF029
20	Black Plastic Base Plate	AVAILABLE ON REQUEST
21	Diversion Tube - Base Anchor Screw	13PF030
22	Lid Clamp - Steel - Ø458mm	13PF032
23	Lid O'ring - Ø421 x 7.5mm	13PF033
24 & 26	Large Filter Basket - with removable slotted cover - No bio media	(2x) 13PF031
25	Biological Spheres - 45mm	(48x) 13PF039
27	Stainless Steel Self Tapping Screw	AVAILABLE ON REQUEST
28	Tank Diversion Plate	13PF049
29	Inner Filter Container	13PF050
30	Filter Base Tank - 175L	AVAILABLE ON REQUEST
31	Biological Media Pack	13PF051

SERVICE KITS

2, 14, 15, 19, (4x Y; 3x B), 23, 5, (x3), 6, (x3), 12, (x3)	Service Kit for Pressure filter PF50000UV	13PF048
---	---	---------

PF2500 - PF50000UV PRESSURE FILTER / UV CLARIFIER

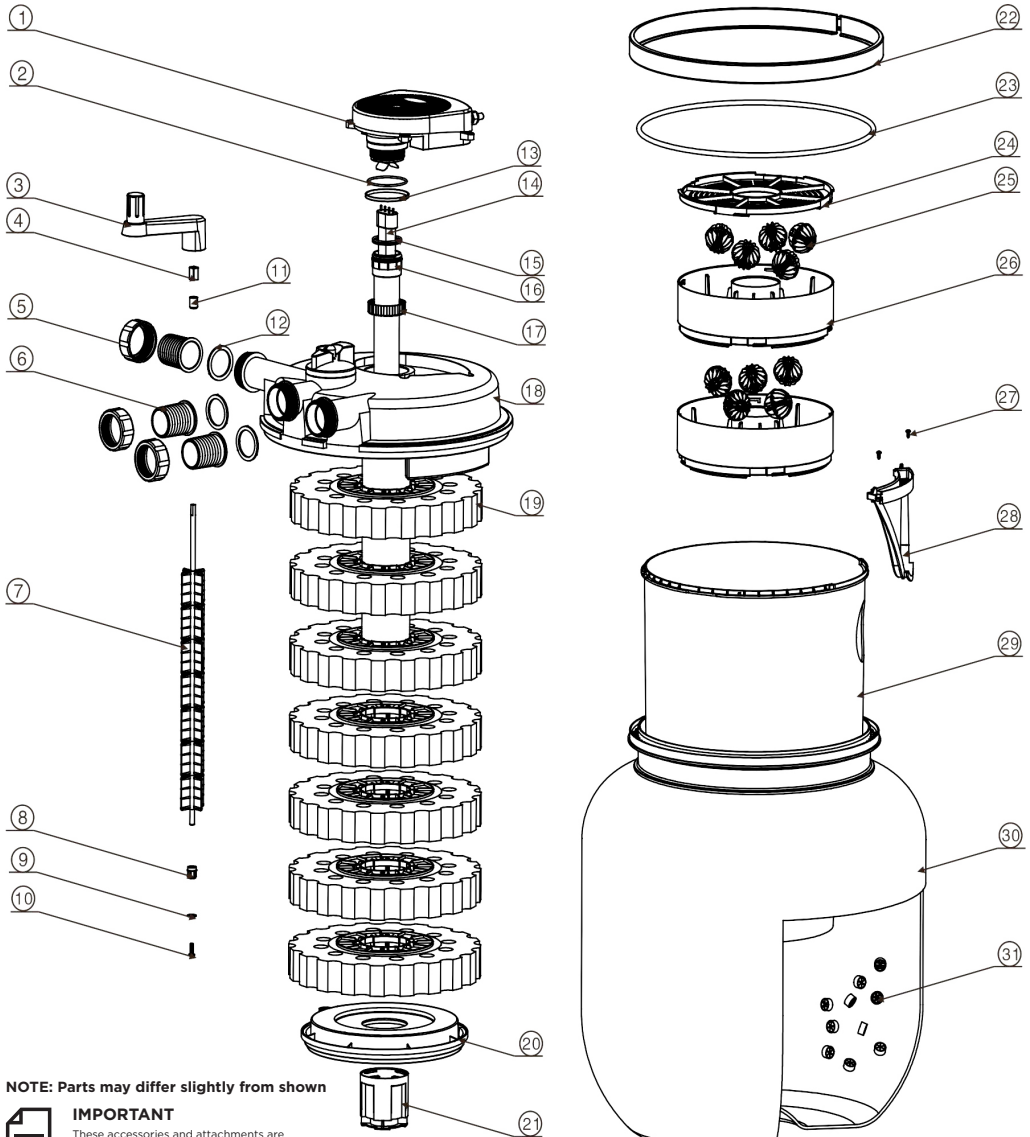

NOTE: Parts may differ slightly from shown



IMPORTANT

These accessories and attachments are recommended for use with your PondMAX product specified in this manual. The use of any other accessories or attachments might present a risk of injury to persons. Only use the accessory or attachment for its stated purpose.

**MODEL SHOWN
PF50000UV**

TROUBLESHOOTING

Problem	Reason	Solution
Water Not Clearing up	Units has not been allowed to run long enough	Full effect of the biological cycle has not been allowed to mature. This can take up to 8 weeks.
	Inappropriate pump size	Water flow is too fast for the Biological cycle settle mature, or the total water flow is not enough for the for the pond volume.
	The Pond as a whole is extremely dirty	Remove debits from the pond, for example stringy algae, leaves, long standing sludge build-up from the bottom of the pond
	Fish stocks are too high for system	Increase filter and pump size
	Filter sponges are dirty	Increase the frequency of filters back flush and easy cleaning function till water becomes clearer over time. Some Extreme situations may require weekly back flushes
	UV Quartz sleeve is dirty	Remove and clean as per cleaning instructions
UV Lamp indicator is not lit	The faint blue glow from the UV globe may not be visible during bright sunlight hours	Wait till evening to check the illumination.
	Check that the UV Unit has power and the power point is turned on	Turn on power
	The UV globe may be defective	Replace the UV Bulb.
No water discharge out of the filter outlet	Back flush Knob is pointing towards the back flush outlet	Turn Knob towards the outlet direction
	The pump may not be connected to power	Turn on power
	Pond plumbing is blocked	Find blockage & remove
No water discharge out of the waste water outlet	The Inlet and outlet hoses may be on the wrong way round	Switch the positions for hoses, such that the inlet is connected to the correct port
	The back flush knob has jumped the cogs in the lid unit	Open up the filter lid and re-alien the cogs so that the teeth match up correctly

PF2500 - PF50000UV PRESSURE FILTER / UV CLARIFIER

LIMITED WARRANTY

- This product comes with a warranty against defects and motor failure (Warranty). The benefits provided in this Warranty are in addition to other rights and remedies available to you under the Australia Consumer Law. The Warranty is provided to the original purchaser of the product on the following terms:
- The Warranty is given by Chemkay Pty Ltd trading as Aquatec Equipment: PO Box 2087, Seville Grove, WA 6112. Tel 1300 552 202 or email sales@aquatecequipment.com.
- To make a claim under the Warranty you must return the faulty product to the place of purchase with a valid receipt or proof of purchase.
- **A Warranty claim must be made within 2 years of the date of purchase.**
- If your claim complies with the above terms and the product is not an Exhaustible Item and no Voiding Events have occurred, we will (at our sole discretion):
 - repair the product, if possible; or
 - provide a replacement product; or
 - if a replacement product is not available, provide a refund for the purchase price paid.
- You will bear the cost associated with claiming under the Warranty such as the cost of transportation and delivery of the product to and from the place of purchase.
- The product contains a complete Impellor Set, O Ring, UV Globe & Sponge Filters. These items are exhaustible (wear & tear) and are not covered under the Warranty.
- The Warranty will be void if any of the following events occur, as determined by us, at our sole discretion (Voiding Events):
 - any tampering/removal of warranty/identification labels or electrical components is evident;
 - the defect has arisen due to: an accident, incorrect or inadequate installation, misuse or abuse of the product (including improper maintenance and service), excessive wear and tear, not following manufacturer's guidelines/ instructions, or the product has been used in a manner contrary to the purpose or suitability of the product;
 - the product has been modified without our authority;
 - the defect is caused by power surges/spikes brownouts.
- Loss of livestock, damage to property or personal injury caused by the improper use or abuse of the product will not be covered and the manufacturer excludes all liability for such events, to the extent permitted by law.
- In addition to the Warranty set out above, our goods come with guarantees that cannot be excluded under the Australian Consumer Law. You are entitled to a replacement or refund for a major failure and for compensation for any other reasonably foreseeable loss or damage. You are also entitled to have the goods repaired or replaced if the goods fail to be of acceptable quality and the failure does not amount to a major failure.

Please consult your retailer for quality original PondMAX replacement parts.

Visit www.aquatecequipment.com for your nearest stockists.

E.&O.E.



PondMAX

WATERGARDENING TO THE MAX



AQUATEC
EQUIPMENT

HOTLINE 1300 AQUATEC

www.aquatecequipment.com

Free Manuals Download Website

<http://myh66.com>

<http://usermanuals.us>

<http://www.somanuals.com>

<http://www.4manuals.cc>

<http://www.manual-lib.com>

<http://www.404manual.com>

<http://www.luxmanual.com>

<http://aubethermostatmanual.com>

Golf course search by state

<http://golfingnear.com>

Email search by domain

<http://emailbydomain.com>

Auto manuals search

<http://auto.somanuals.com>

TV manuals search

<http://tv.somanuals.com>