

User's Guide

Designer I

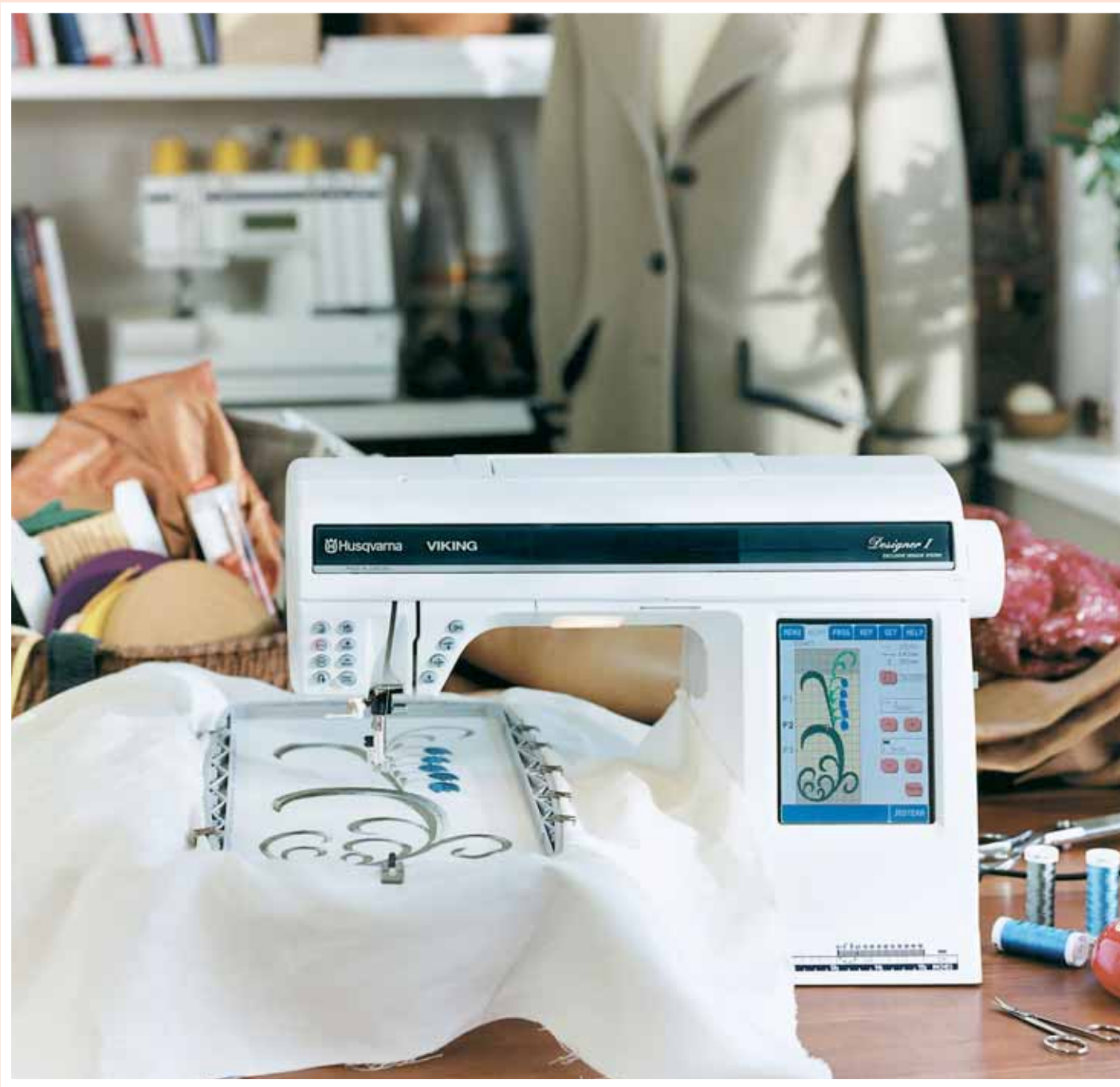

This household sewing machine is designed to comply with IEC/EN 60335-2-28 and ULI594

IMPORTANT SAFETY INSTRUCTIONS

When using an electrical appliance, basic safety precautions should always be followed, including the following:

Read all instructions before using this household Sewing machine.

DANGER – To reduce the risk of electric shock:

- A sewing machine should never be left unattended when plugged in. Always unplug this sewing machine from the electric outlet immediately after using and before cleaning.
- Always unplug before relamping. Replace bulb with same type rated 5 Watt.

WARNING – To reduce the risk of burns, fire, electric shock, or injury to person:

- Do not allow to be used as a toy. Close attention is necessary when this sewing machine is used by or near children or infirm persons.
- Use this sewing machine only for its intended use as described in this manual. Use only attachments recommended by the manufacturer as contained in this manual.
- Never operate this sewing machine if it has a damaged cord or plug, if it is not working properly, if it has been dropped or damaged, or dropped into water. Return the sewing machine to the nearest authorised dealer or service center for examination, repair, electrical or mechanical adjustment.
- Never operate the sewing machine with any air openings blocked. Keep ventilation openings of the Sewing machine and foot controller free from the accumulation of lint, dust, and loose cloth.
- Keep fingers away from all moving parts. Special care is required around the Sewing machine needle.
- Always use the proper needle plate. The wrong plate can cause the needle to break.
- Do not use bent needles.
- Do not pull or push fabric while stitching. It may deflect the needle causing it to break.
- Switch the Sewing machine off (“0”) when making any adjustment in the needle area, such as threading needle, changing needle, threading bobbin, or changing presser foot, etc.
- Always unplug Sewing machine from the electrical outlet when removing covers, lubricating, or when making any other user servicing adjustments mentioned in the instruction manual.
- Never drop or insert any object into any opening.
- Do not use outdoors.
- Do not operate where aerosol (spray) products are being used or where oxygen is being administered.
- To disconnect, turn all controls to the off (“0”) position, then remove plug from outlet.
- Do not unplug by pulling on cord. To unplug, grasp the plug, not the cord.
- Hold plug when rewinding into cord reel. Do not allow plug to whip when rewinding.
- This sewing machine is provided with double insulation. Use only identical replacement parts. See instructions for Servicing of Double-Insulated Appliances.

SAVE THESE INSTRUCTIONS

SERVICING OF DOUBLE INSULATED PRODUCTS

In a double-insulated product, two systems of insulation are provided instead of grounding. No ground means is provided on a double-insulated product, nor should a means for grounding be added to the product. Servicing of a double-insulated product requires extreme care and knowledge of the system, and should be done only by qualified service personnel. Replacement parts for a double-insulated product must be identical to those parts in the product. A double-insulated product is marked with the words ‘DOUBLE INSULATION’ or ‘DOUBLE INSULATED’.

Table of contents

Learn your Designer I	4-38	Embroidery	63-82
Overview	4-5	Embroidery Unit, Connect, Remove	64-65
Unpack, Connect, Pack away	6	Built-in Disk Drive	65
Accessory Tray/Sewing surface	7	Vertical spoolpin, felt spool pad	65
Spool pin	8	Embroidery Booklet	65
Threading	8-10	Hoop, Template	66-67
Bobbin winding	10-11	Getting started	69
Function buttons	12	Embroidery Screen Menus	70-71
Sensor Foot	13	SET in embroidery	71
Changing the presser foot	13	ADJUST in Embroidery	72
Presser feet	14-15	Embroidery colors, features	73
Feed teeth	15	Pop-up menus in Embroidery	74
Changing the needle, Needles	16	Start embroidering, thread cut	75
Color Touch Screen	17-38	Customizing Design	76-81
Main Menu	18	Built-in Stitches in the hoop	82
Sewing Advisor – The easy way to sew	19	Decorative/Crafting	83-94
Speciality Stitch Menus	20-26	Decorative/Crafting	84-88
Starting to sew	27	Appliqué	84-85
Thread tension	27	Taper Satin Stitch	86
Finish the sewing	27	“Handlook” Heirloom Appliqué	87
ADJUST Menu	28	Appliqué Embroidery	88
SET Menu	29-32	Decorative Stitches	89-91
Pop Up Menus	33	Cross Stitches	92
HELP Menu	34	Lettering	93-94
Programming	35-38	Quilting	95-100
Utility/Garment Sewing	39-62	Quilting	96
Sewing Advisor	40-50	Quilting and Piecing Quilts	96
Fabric Selection, Thread	40-41	Decorative stitch tie Quilting	96
Seam	42-43	Crazy Quilting	97
Overcast, Three-step zigzag	44	Handlook Quilting	97
Seam and Overcast	45	Stipple Quilting	98
Baste	46	Channel Quilting	98
Blind Hem, Hem	47-48	Edge/Quilting Guide	99
Buttonhole	49-50	Quilt Embroidery	99
Button	50	Heirloom Sewing	101-108
Menu B – Buttonhole	51-53	Heirloom Sewing	102
Corded Buttonhole	52	Entredeux	102
Step by Step buttonhole	52	Lace Insertion	102
Buttonhole Balance	52	Bridging Stitch	103
Buttonhole Density	53	Hemstitching/Wing needle	103
Cutting Buttonholes	53	Scallop Stitching	104
Bound Buttonhole	53	Smocking	105
Menu A – Utility Stitches	54-61	Cutwork Embroidery	106
Straight Stitch	54	Pictogram	107
Lightning Stitch	54	Care of your Designer I	109-113
Gathering	54	Care of your Designer I	110-111
Twenty-five Needle positions	55	Trouble Shooting	112-113
Zipper	56	How to update Designer I	113
Reinforced Straight Stitch	57	Index	114-115
Multiple Zigzag Stitches	58		
Darning and Mending	59		
Bartacks, Belt loops	60		
Stitch Table – Menu A	61		
Menu S – 4-Way Stitches	62		

Learn your Designer I
Page 4-38

Utility/Garment Sewing
Page 39-62

Embroidery
Page 63-82

Decorative/Crafting
Page 83-94

Quilting
Page 95-100

Heirloom Sewing
Page 101-108

Care of your Designer I
Page 109-113

Learn your Designer I

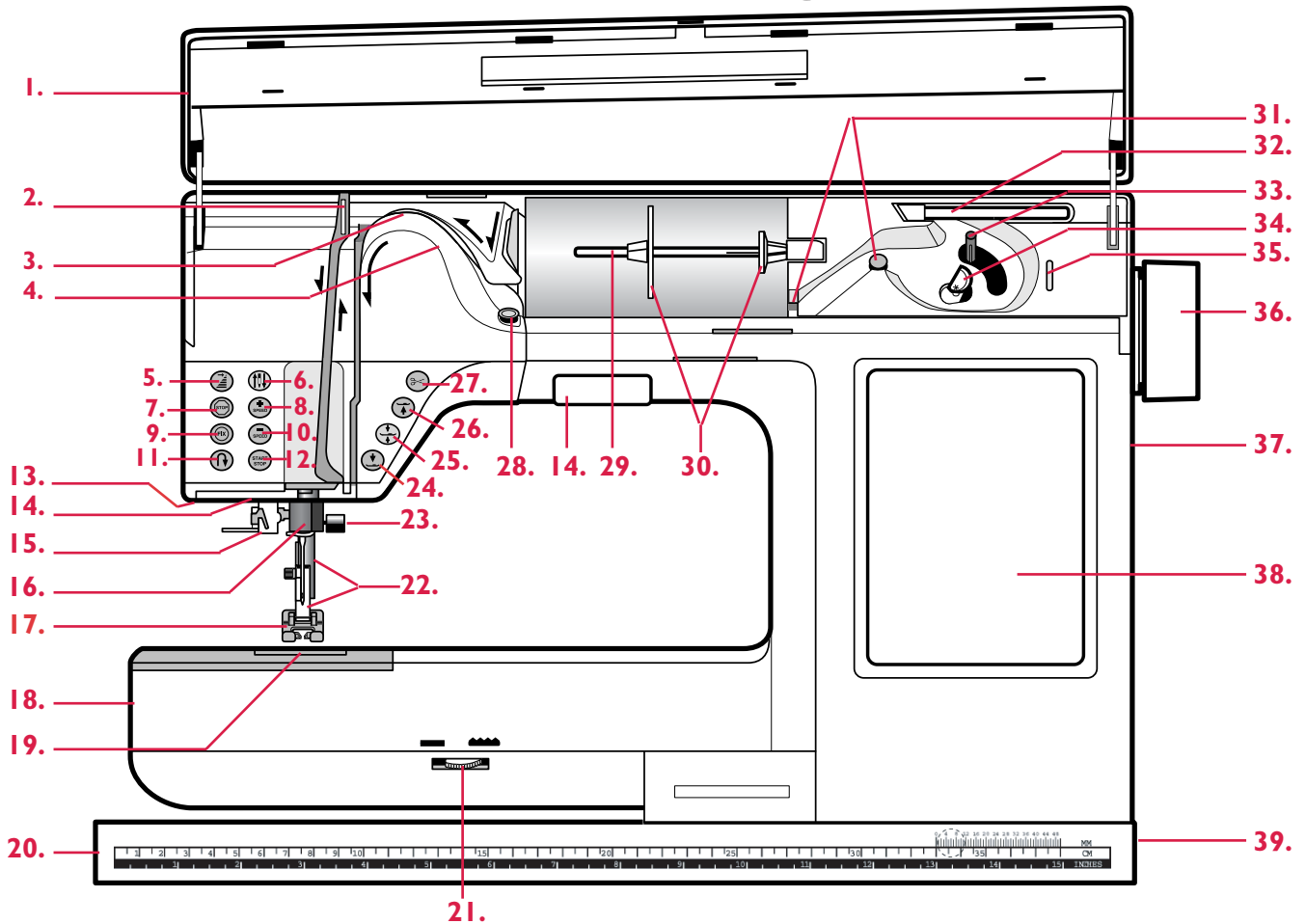

Overview – Front side

1. Door/Lid
2. Thread take-up lever
3. Thread tension
4. Pre-tension disc
5. Stitch Re-Start button
6. Needle stop up/down button
7. Finishing Stop button
8. Sewing speed button – faster
9. FIX button
10. Sewing speed button – slower
11. Reverse button
12. Start/Stop button
13. Sensor Buttonhole Foot socket
14. Light
15. Needle threader
16. Needle bar
17. Presser foot
18. Free arm
19. Bobbin cover
20. Baseplate
21. Drop feed dial
22. Presser foot bar and Presser foot ankle
23. Needle clamp screw
24. Sensor foot lift down button
25. Sensor foot lift pivot button
26. Sensor foot lift up/extra lift button
27. Thread cutter button
28. Thread tension for bobbin winding – vertical spool pin
29. Horizontal spool pin
30. Spool holders
31. Bobbin winding guides
32. Vertical spool pin
33. Bobbin winder spindle
34. Bobbin stop
35. Thread cutter for bobbin winding
36. Handwheel
37. Built-in disk drive
38. Color Touch Screen
39. Main power switch, Connection to power supply



Some fabrics have a lot of excess dye which can cause discoloration on other fabric but also on your sewing machine. This discoloring may be very difficult or impossible to remove.

Fleece and denim fabric in especially red and blue often contain a lot of excess dye.

If you suspect that your fabric/ready-to-wear garment contains a lot of excess dye, always pre-wash it before sewing/embroidering to avoid the discoloring.

Rear side

- 40. Handle
- 41. Thread cutter
- 42. Needle threader
- 43. Embroidery unit connection socket

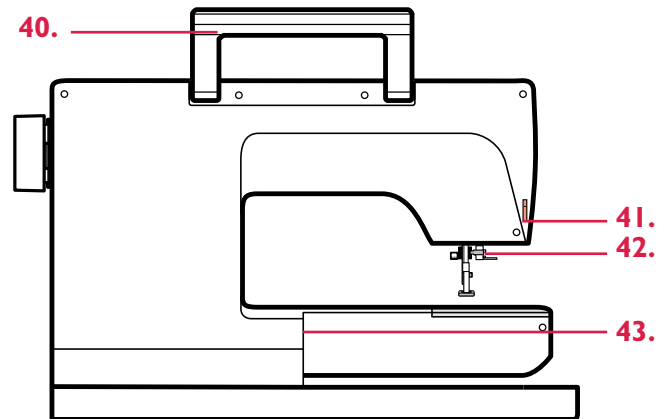

Accessory Tray

- 44. Flat bed extension
- 45. Space for other accessories
- 46. Space for presser feet
- 47. Space for bobbins
- 48. Space for needles

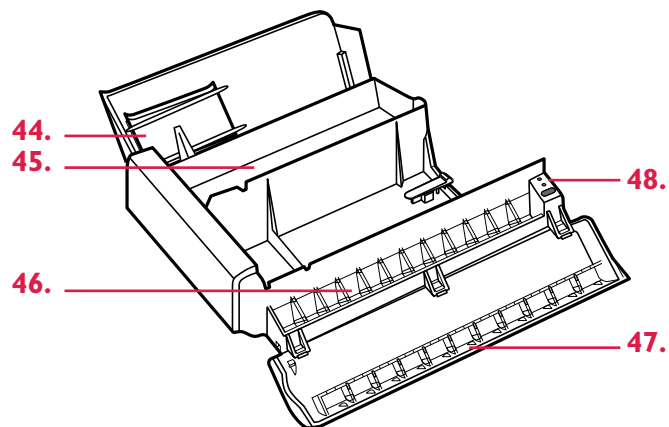

Embroidery unit

- 49. Embroidery arm
- 50. Embroidery Hoop attachment
- 51. Embroidery unit socket
- 52. Release button

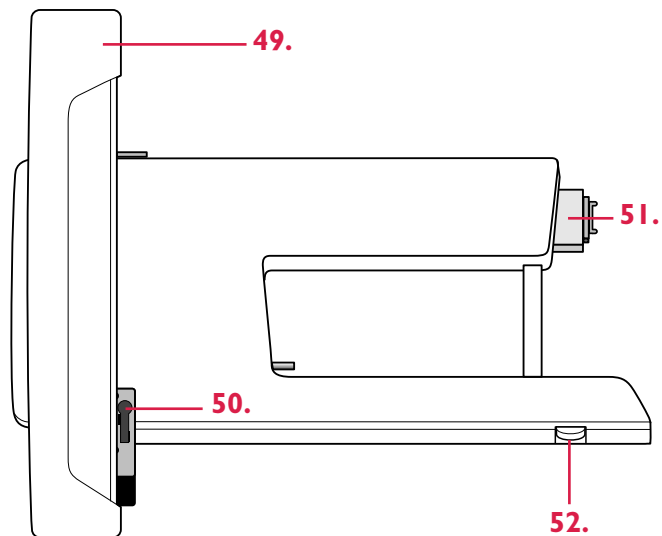

Unpacking

1. Place the machine on the table or cabinet, remove the packaging and lift off the cover.
2. Remove the packing material, the foot control and finally the protection cover.
3. The machine is delivered with an accessory bag and a main cord. The foot control is equipped with a cord reel.
4. Wipe the machine, particularly around the needle and needle plate to remove any soil before sewing.

Connecting to the power supply

Among the accessories you will find the main cord. On the underside of the machine you will find information about the power supply (V) and the frequency (Hz).

For USA and Canada

This sewing machine has a polarized plug (one blade wider than the other). To reduce the risk of electric shock, this plug is intended to fit in a polarized outlet only one way. If the plug does not fit fully in the outlet, reverse the plug. If it still does not fit, contact a qualified electrician to install the proper outlet. Do not modify the plug in any way.

Before plugging in, check to ensure that the foot control is of “type FR3”.

1. Pull out the cord from the foot control. Connect the foot control cord to the front socket (1) on the bottom right side of the machine.
2. Connect the main cord to the back socket (2) on the bottom right side of the machine.
3. When you press the power switch to ON (3), both the machine and the lights are switched on.

Packing away after sewing

1. Press the main switch to turn off the machine.
2. Unplug the cord from the wall socket and the machine.
3. Wind the main cord around your hand and place the cord in the pocket of the cover. There is also space for the User's Guide.
4. Unplug the foot control cord from the machine. Pull the cord gently and release - the cord will be wound into the foot control.
5. Check to ensure that all accessories are in the accessory tray. Slide the tray on to the machine around the free arm.
6. Place the foot control, underside towards you, fitting into the recess of the accessory tray at the rear side of the machine.

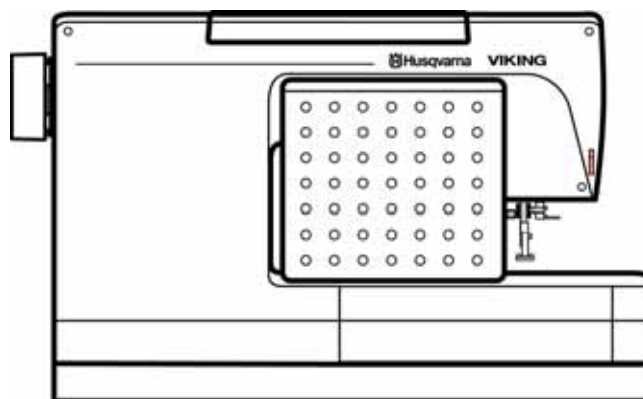
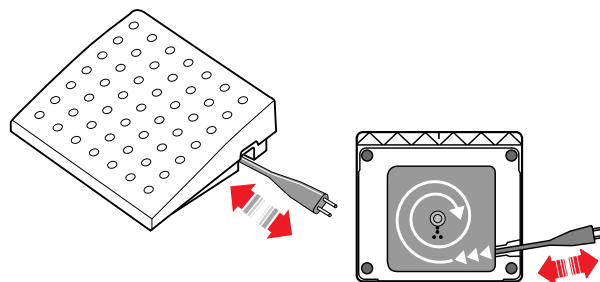
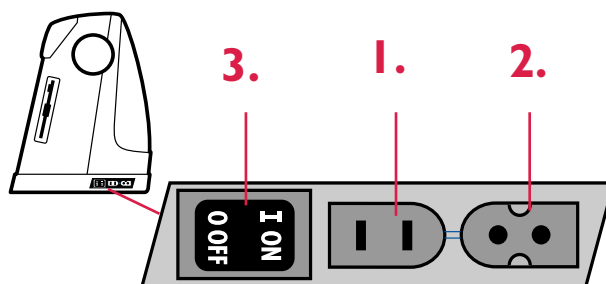
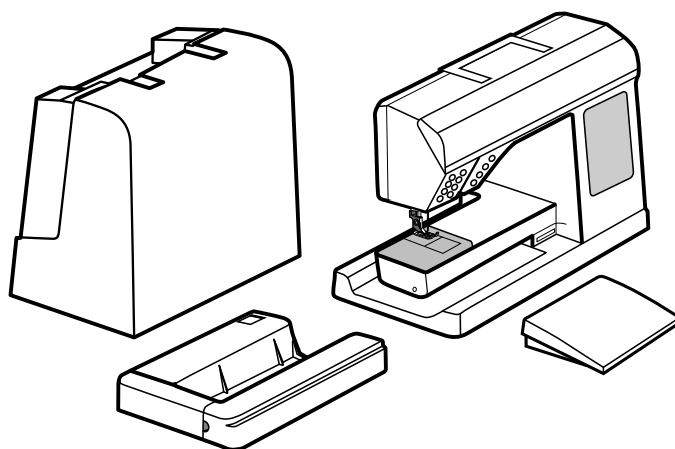

Accessory Tray/Sewing surface

In the Accessory Tray there are special pockets for presser feet, bobbins and needles plus space for other accessories. Store the accessories in the tray so they are easily accessible.

Slide the Accessory Tray on to the machine to provide a larger work surface. Slide the Accessory Tray to the left, passing the stop position and remove it if you wish to use the free arm.

A work surface extension is stored inside the rear cover of the tray.

1. Slide the Accessory Tray to the left until you have just passed the stop position.

2. Place the work surface extension into the space that appears between the tray and the machine and push the tray back.

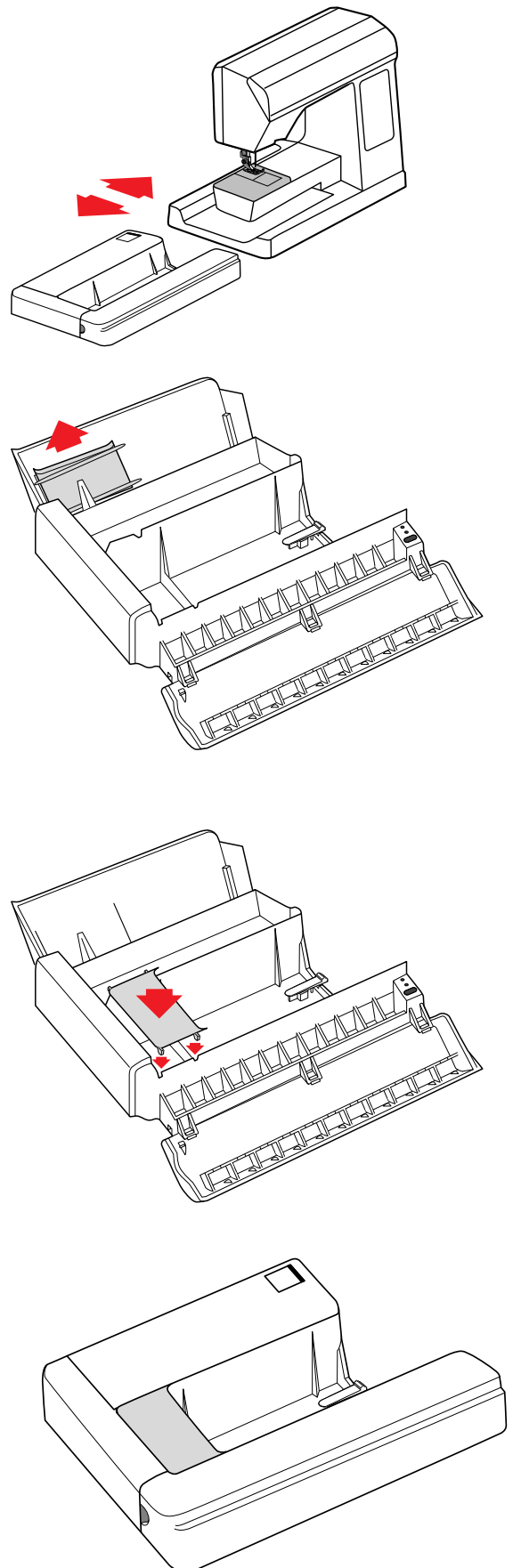

Spool pins

Your Designer I has spool pins suitable for all types of thread. The main spool pin (a) is adjustable and can be used in horizontal position for normal threads or in vertical position for extra large spools or threads with special characteristics.

Horizontal position

Place the spool so that the thread reels counter-clockwise. There are two spool holders on the spool pin. For narrow thread spools, the small holder (b) is placed in front of the thread. If you use large thread spools, the large holder (c) is placed in front of the thread.

Slide the correct size spool holder in place so the flat side is pressed firmly against the spool, with no space between spool holder and spool.

Vertical position

To use the spool pin in its vertical position, pull the spool pin out towards you. Slide on the large spool holder and place a felt pad under the thread spool. This is to prevent the thread from reeling off too fast.

Fold up Spool pin

There is also an additional, fold up/down spool pin (d).

The large spool holder (c) is placed under the thread. This spool pin is used when winding a bobbin from a second spool of thread or for a second spool when sewing with a twin needle.

Threading the upper thread

Make sure the presser foot is raised and the needle is in the up position.

Horizontal spool pin

1. Pull the spool pin out. Place the spool on the spool pin. The thread shall reel counter-clockwise. Push the spool pin back in. Hold the thread near the spool using your right hand. Use your left hand to bring the end of the thread in the direction of the arrow.
2. Bring the thread over the pre-tension thread guide (a) and under the thread guide (b). Bring the thread over the thread tension discs (c).

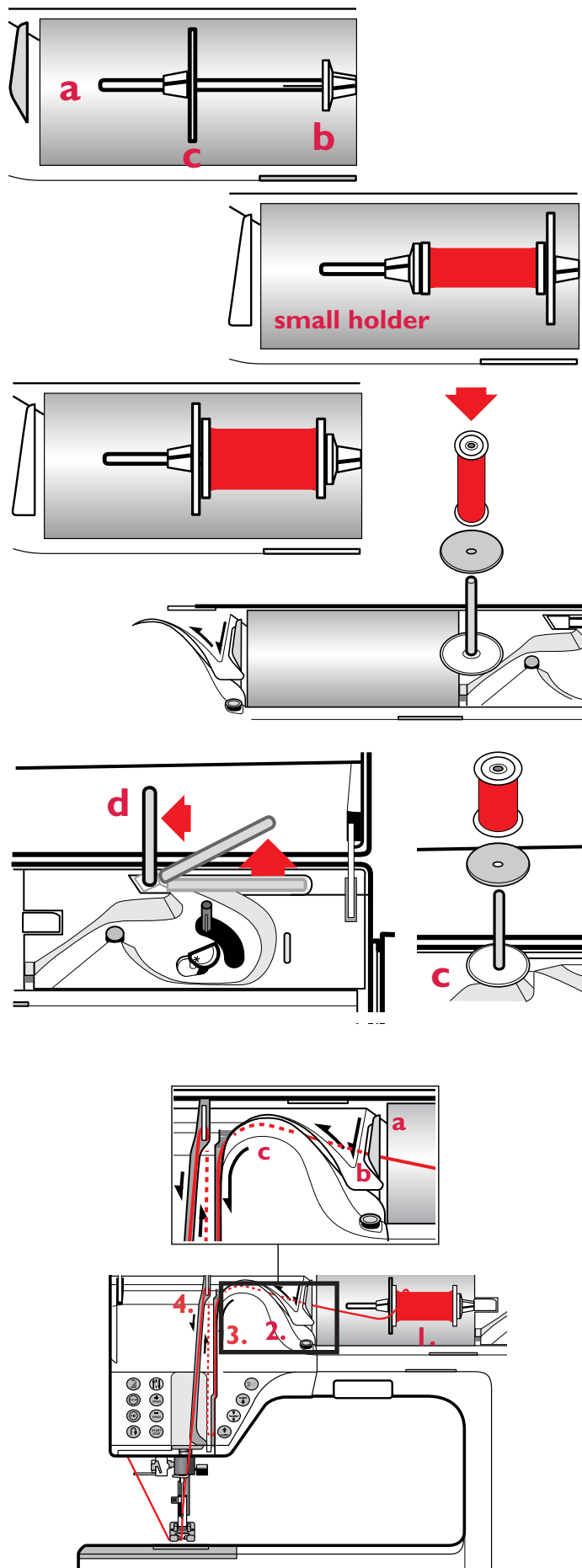

3. Continue threading in the direction indicated by the arrows. Bring the thread from the right when threading into the slot on the take-up lever.
4. Take the thread down to the last guide just above the needle.

Vertical spool pin

1. Pull the spool pin out. Place the spool on the spool pin (follow the instructions on previous page).
2. Thread the machine according to the instructions with one exception. Instead of bringing the thread into the pre-tension guide, bring it directly under the thread guide (b).

Needle threader

The needle must be in the up position to use the needle threader. We also recommend that you lower the presser foot.

1. Pull the needle threader all the way down, behind the needle.
2. Bring it forward until the metal flanges cover the needle. A small hook will pass through the eye.
3. Place the thread around guide (a) and under the flanges in front of the needle, so it catches into the small hook.
4. Let the needle threader gently swing back, the hook pulls the thread through the needle eye and forms a loop behind the needle. Pull the thread loop out behind the needle.
5. Place thread under the presser foot and cut the thread.

Note: You can not use the Needle threader for the wing needle, twin needle, triple needle, a needle smaller than size 70 or when the Buttonhole Sensor Foot is on. The needle is threaded from front to back. The white on the presser foot ankle makes it easy to see the eye of the needle.

Thread warning

If the upper thread breaks or bobbin thread runs out, the machine stops. Upper thread or bobbin symbol appears on a Pop-up Menu on the Color Touch Screen. If upper thread breaks: Re-thread the machine and touch OK on the Pop-Up Menu. The Pop-up disappears. If bobbin thread runs out: Remove your work and the bobbin. Fill the bobbin. Replace the bobbin and sew.

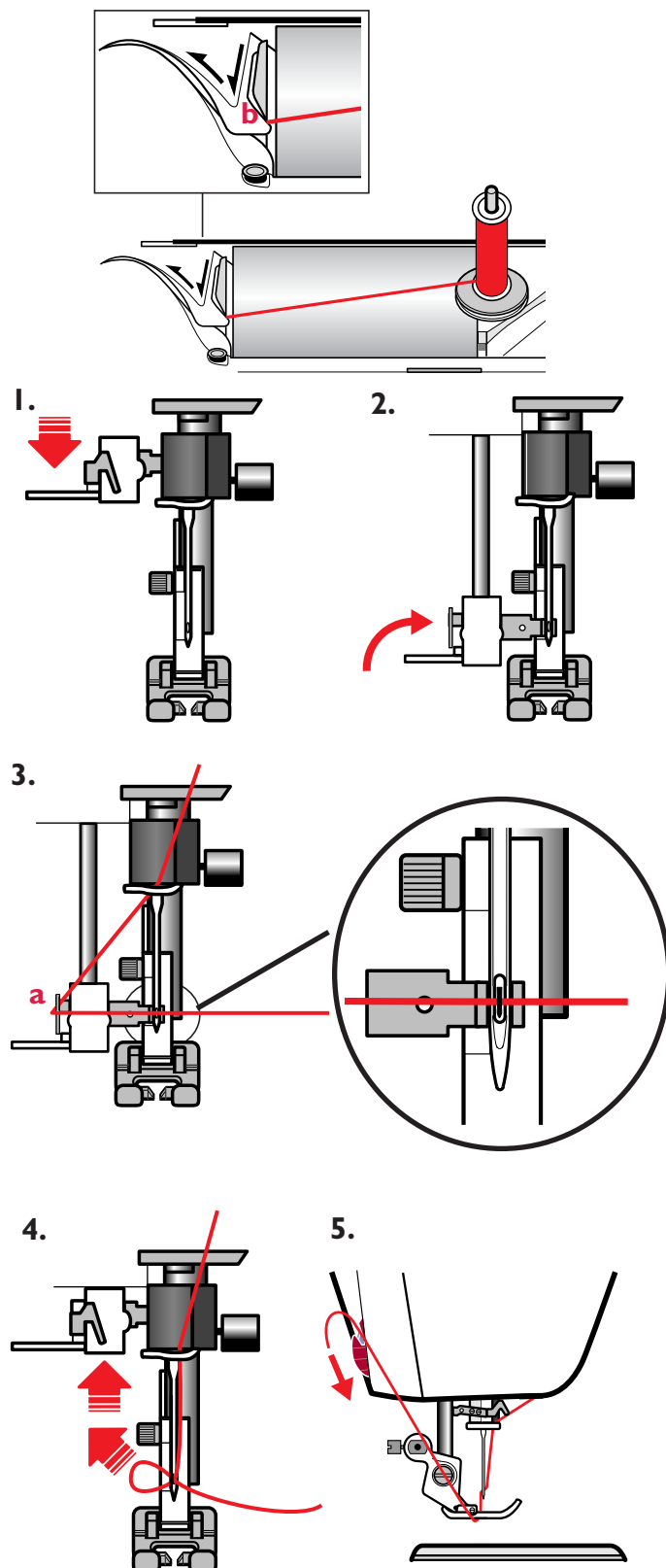

Threading for twin needle

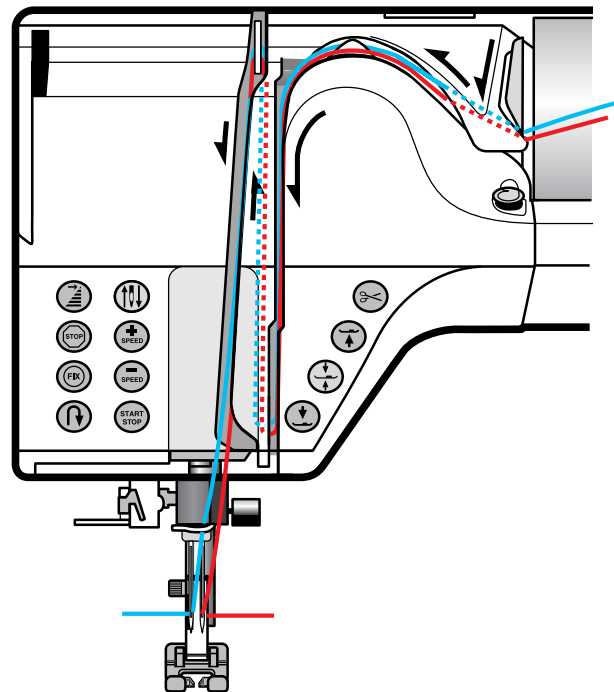

1. Insert a twin needle. See page 16 “Changing the needle”.
2. Use a second thread spool or wind a bobbin with the thread you are going to use as the second upper thread.
3. Left needle (blue). Thread the machine as explained on page 9 (Vertical spool pin) and check to ensure that thread lies between the **inner** thread tension discs, **inside** the last thread guide. Thread left needle.
4. Right needle (red). Pull up the extra spool pin. Place a spool holder and a felt pad under the bobbin with the second thread on the spool pin.
5. Place a spool holder and a felt pad under the bobbin with the second thread on the spool pin.
6. Thread the machine as before but this thread should lie between the **outer** thread tension discs, **outside** the last thread guide. Thread right needle.



Bobbin winding with the machine threaded

Make sure that the presser foot and the needle are in the up position. Use only the original Husqvarna Viking green bobbins with your Designer I.



Only use a metal presser foot when bobbin winding from the needle.

1. Place your empty bobbin with the small mark  out on the bobbin spindle on the front of the machine. Bring the bobbin spindle down. A Pop-up menu on the Color Touch Screen reminds you that bobbin winding is engaged.
2. Pull the thread from the needle under the presser foot and to the right under the thread guide (c) and over (d).
3. Start from above and wind a few turns of thread clockwise around the bobbin. Cut off the thread on the thread cutter (e).
4. Press the foot control or touch . When the bobbin is filled, the winding will stop automatically. Remove the bobbin, cut off the thread (e) and bring the bobbin spindle up.

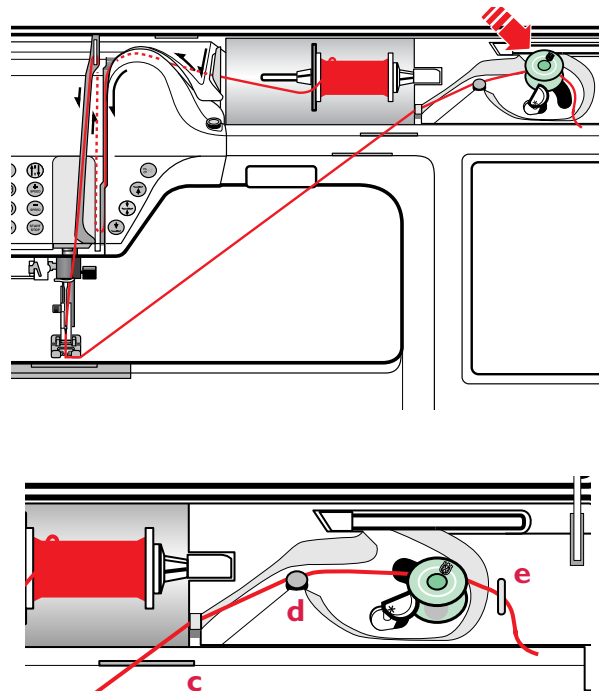
Note: We do not recommend winding specialty threads such as invisible or other stretchy threads through the needle. Instead see “Bobbin winding – vertical spool pin”.



Bobbin winding – vertical spool pin

1. Place an empty bobbin with the mark  out on the bobbin spindle on the front of the machine. Bring the bobbin spindle down. A Pop-up menu on the Color Touch Screen reminds you that bobbin winding is engaged.
2. Place the large spool holder under the thread on the spool pin.
3. Bring the thread around thread guide (b), then under thread guide (c) and over (d) as illustrated.
4. From above wind a few turns of thread clockwise around the bobbin and into the thread cutter (e).
5. Press the foot control or touch . When the bobbin is filled, the winding will stop automatically. Remove the bobbin, cut off the thread (e) and bring the bobbin spindle up.

Note: Depending on the quality of the thread you can wind the thread one or two times around the threadguide (b) in order to get the right thread tension.

Placing the bobbin in the machine



Turn off the main switch.

1. Open the cover by sliding it towards you and remove it.
2. Place the bobbin in the bobbin case with the mark  facing up and the thread to the left of the bobbin. The bobbin will then rotate counter clockwise while pulling out the thread.
3. Place your finger on the bobbin to keep it from turning as you pull the thread firmly to the right and then to the left into the tension spring (a) until it “clicks” into place.
4. Continue threading around (b) and to the right of the thread cutter (c). Replace the cover with the lines to the front and slide it into

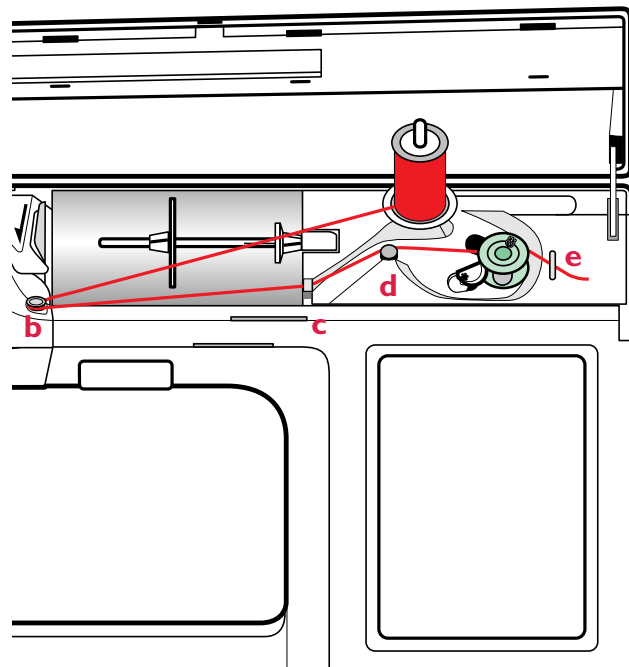

1.

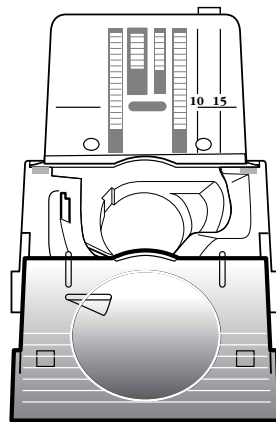

2.

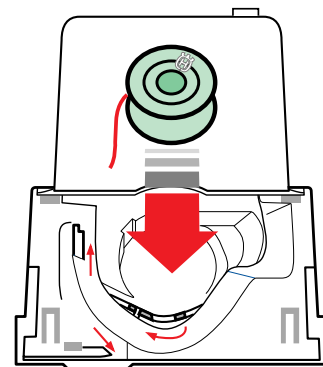



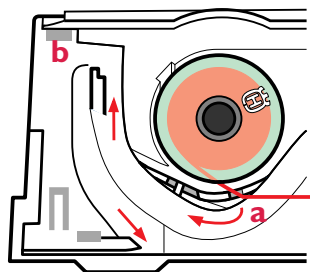

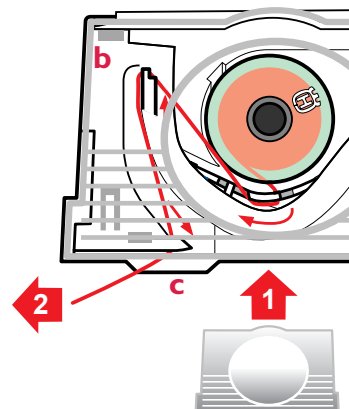

3.



4.





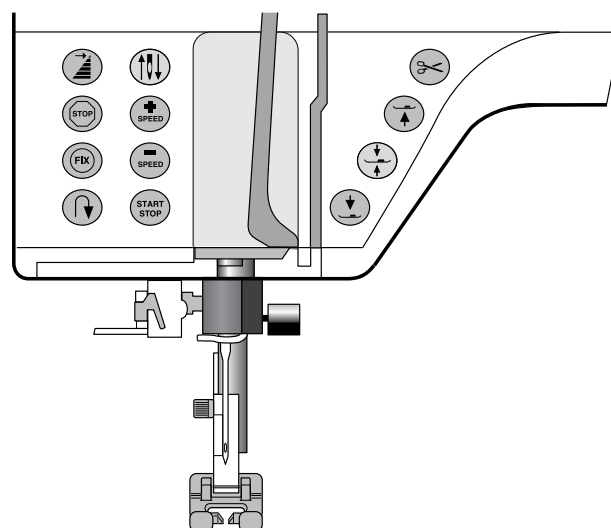

Function buttons

-  **Stitch Re-start.** To start sewing your selected stitch at the beginning of the stitch without having to re-set any special settings you have made.
-  **STOP** is used to conclude a stitch. Your Designer I fastens the thread and stops automatically when one stitch sequence has been completed. The button lights up when you touch it. STOP is cancelled when you touch the button again or by selecting a new stitch. The button light will go out. The STOP function can be programmed. It can also be used for one color embroidery.
-  **FIX** is automatically activated when a stitch is selected or when Thread Cutter has been used. The button lights up while FIX function is active. By touching the lighted button the function can be turned off. At the beginning – Designer I sews a few tie off stitches and goes on with the selected stitch. Touch FIX while sewing – Designer I sews a few tie off stitches and stops automatically. The FIX function can be programmed.
-  **Reverse** – your Designer I sews in reverse when this button is touched. The button lights up. Designer I sews forwards when the button is released and the light goes out. The longest reverse stitch length is 3mm. For permanent reverse, touch the button twice in quick succession before starting to sew. The button will be lit up and the Designer I sews in reverse until you touch the button again to cancel.
-  **Needle stop up/down.** Touch this button to move the needle down or up. The setting of the needle stop position is changed at the same time. You can also tap the foot control to raise or lower needle.
-  Touch **+ SPEED** or **- SPEED** to increase or decrease the sewing speed. Touch when not sewing and a Pop-up menu on the Color Touch Screen indicates the speed setting. Touch OK or start sewing and the pop up goes out. You can change the speed setting while sewing but no Pop-up will appear. All stitches in Designer I have



a pre-set, recommended sewing speed. When you select a stitch, Designer I automatically sets the correct sewing speed.

-  **START/STOP.** Touch this button to run and stop the machine without the foot control. Touch START/STOP to begin and touch again to stop sewing.
-  **Selective Thread Cutter.** Touch the button and Designer I cuts the top and bobbin threads, raises the presser foot and the needle to the up position and activates the FIX function. To cut before the needle moves to the start position of next stitch, touch Thread Cutter while the machine is running. A flashing STOP will indicate that a cut is requested. The Thread cutter function can be programmed.
-  **Sensor Foot Lift up and extra lift.** Touch this button and the presser foot and the needle will be lifted to up position. Touch the button once more and the presser and foot will raise to extra lift to make it easy to get thick fabric under the presser foot.
-  **Sensor Foot Lift pivot.** To simplify placing the fabric, touch this button. The presser foot will be lowered to pivot position.
-  **Sensor Foot Lift down.** Touch this button and the presser foot will be completely lowered and Designer I is firmly holding your work.

Sensor Foot Pressure

When selecting different fabric weights on the Sewing Advisor, the pressure will be adjusted automatically. Thanks to the Sensor Foot Pressure, the presser foot actually senses the thickness of fabric or embroidery or stitching to sew over it smoothly and evenly.

Touch **SET** on the Color Touch Screen and you will see the actual setting of the presser foot pressure for the selected fabric.

You can adjust the presser foot pressure by pressing the buttons (+) or (-) on the **SET** menu. The higher the number the more pressure on the fabric.

Sensor Foot Lift

The presser foot is automatically lowered when you start your sewing.

When you stop with the needle in the down position, the presser foot is automatically lifted to pivot position.

If you have selected **Needle stop up:**

⬆️ UP – Raises the presser foot and the needle to up position. Touch twice for extra lift. Makes it easier to get thick garments under the presser foot.

If you have selected **Needle stop down:**

⬆️ UP – Raises the presser foot to up position but the needle stays down in the fabric. Touch twice – the needle raises to up position and the presser foot to the extra lift for easy removal of fabric.

⬆️ PIVOT – Sets foot to pivot position.

⬇️ DOWN – Lowers the presser foot.

Changing the presser foot

⚠️ Turn off the main switch.

1. Make sure that the needle is in the highest position. Pull the presser foot towards you.
2. Line up the cross pin on the foot between the spring and the presser foot ankle. Press back until the foot snaps into place.

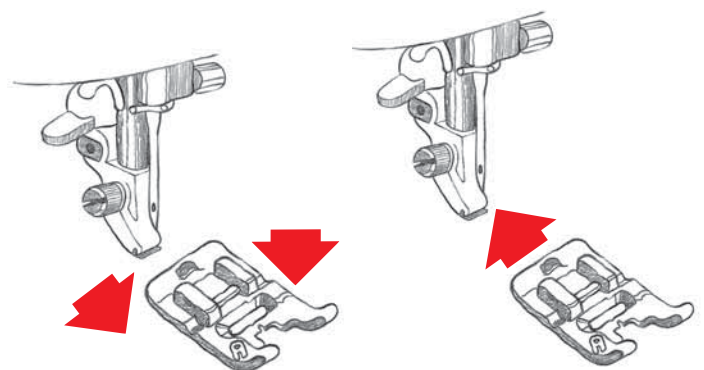
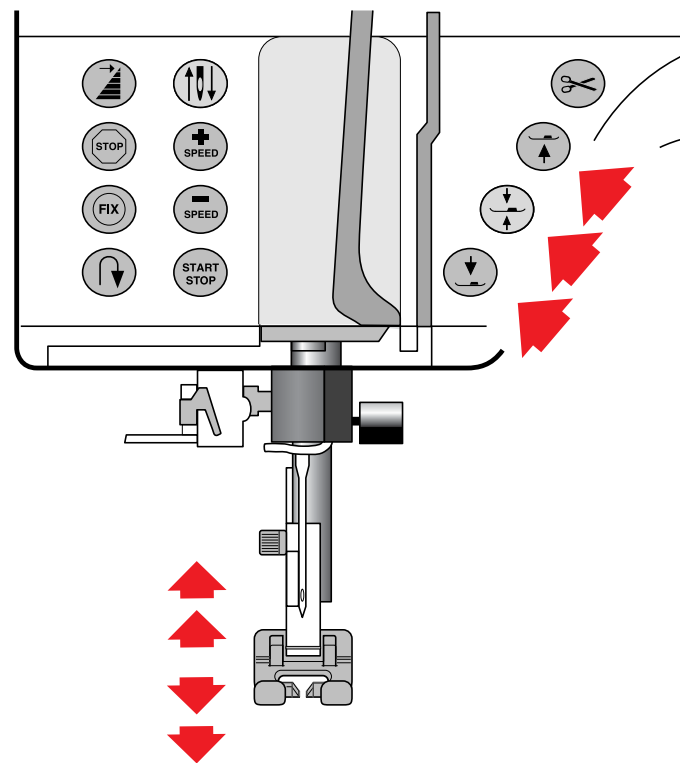

Presser feet

Among the accessories there are a number of presser feet for different purposes.

Presser foot A

Fitted on the machine upon delivery. This foot is used mainly for straight stitching and zigzag stitching with a stitch length longer than 1.0.

Presser foot B

When sewing close zigzag stitches with less than 1.0 stitch length; other utility stitches or decorative stitches use this foot. The tunnel on the bottom of the foot is designed to feed smoothly over the stitches.

Presser foot C

This buttonhole foot has guide lines to determine buttonhole length. The end of the short toe is $\frac{3}{8}$ " from needle and end of long toe is $\frac{3}{4}$ " from needle. The two tunnels on the bottom of the foot feed smoothly and straight over the buttonhole columns.

Presser foot D

This foot is used for blind hem stitches. The inner edge of this foot guides the fabric. The bottom of the foot is designed to ride along the hem edge.

Presser foot E

This is the zipper foot and can be snapped on either to the right or to the left of the needle, making it easy to sew both sides of the zipper.

Presser foot H

This foot is made of plastic with exception of a glide plate underneath. The foot is used when sewing foam, plastic, or leather, minimizing the risk of these materials sticking to the foot. Same as Presser foot A.

Presser foot J

This foot is used for overcasting, seam and overcasting, i.e. stitches which have a stitch width of 5.0 and 5.5 mm. The pin prevents puckering at the edge of the fabric.

Presser foot P

This foot is used when piecing quilt blocks. The foot has distance marks $\frac{1}{4}$ " (6 mm) and $\frac{1}{8}$ " (3 mm).

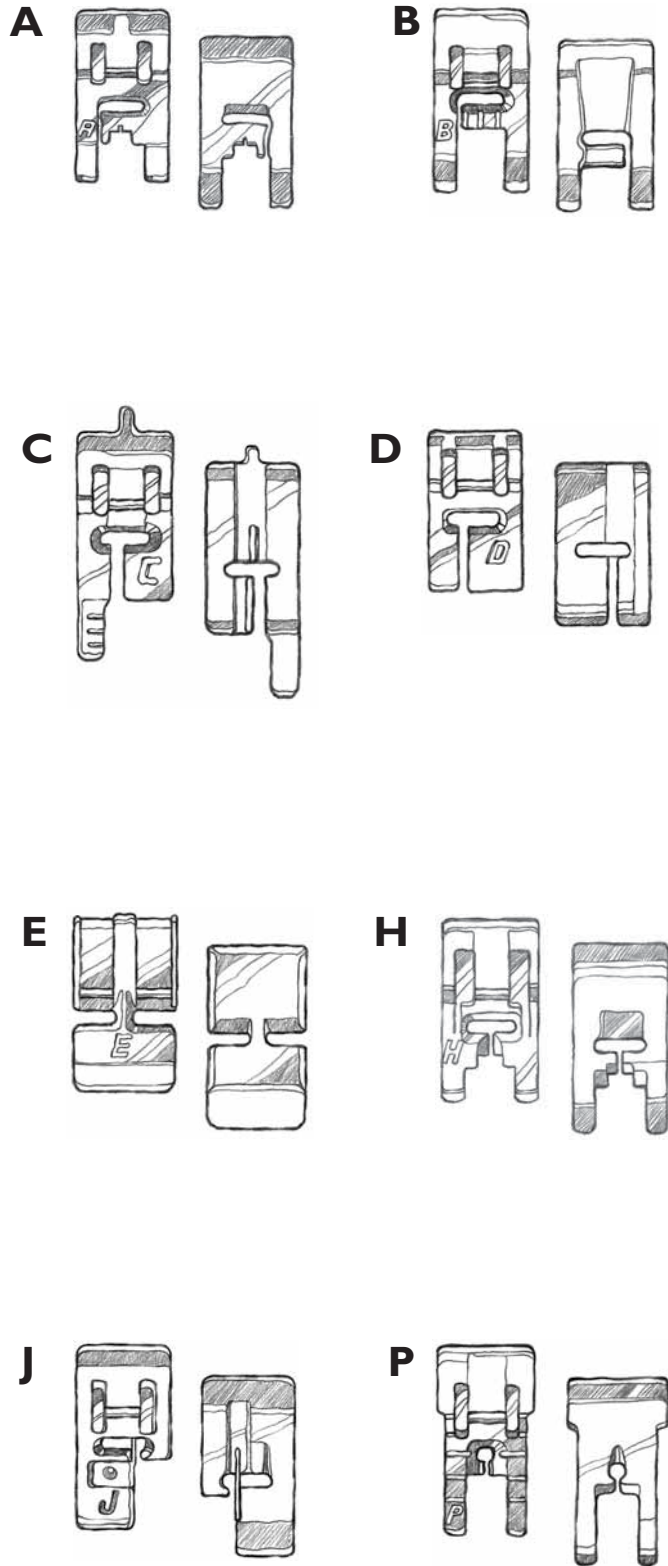

Presser foot S

This foot is used for side-motion stitches.

Transparent presser foot

For decorative sewing. Makes it easy to match patterns. Same as Presser foot B.



Sensor Buttonhole Foot

When connected to the machine it measures buttonhole length and sews the buttonhole size that has been entered into the machine. The end of the short toe is 3/8" from needle and end of long toe is 3/4" from needle

Self-adhesive glide plates

Used for the presser foot C/Sensor Buttonhole Foot when sewing plastic-coated fabrics, leather etc.

Lowering the feed teeth

The feed teeth are lowered when you turn the dial to the left . Turn the dial to the right  if you wish to raise the feed teeth. The feed teeth will raise as you begin to sew.

The feed teeth should be lowered for sewing on buttons and for free-motion work.

Tip: By lowering the feed teeth it is easier to get thick fabrics like terry cloth under the presser foot. Raise the feed teeth before starting to sew.

Note: The feed teeth are lowered automatically when the embroidery unit is put in place. When removing the embroidery unit, the feed teeth will raise as you start to sew.

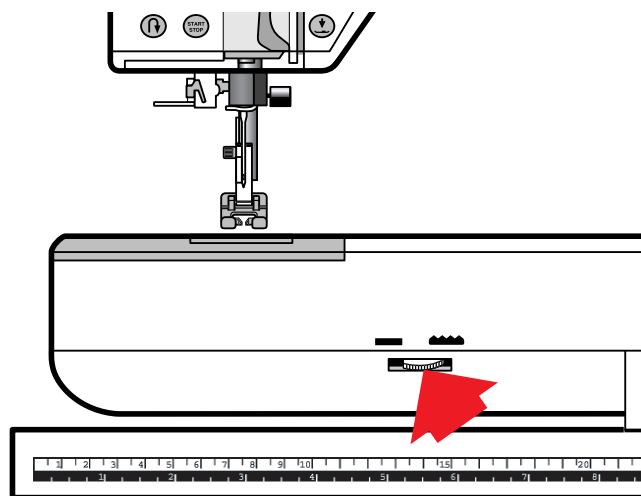
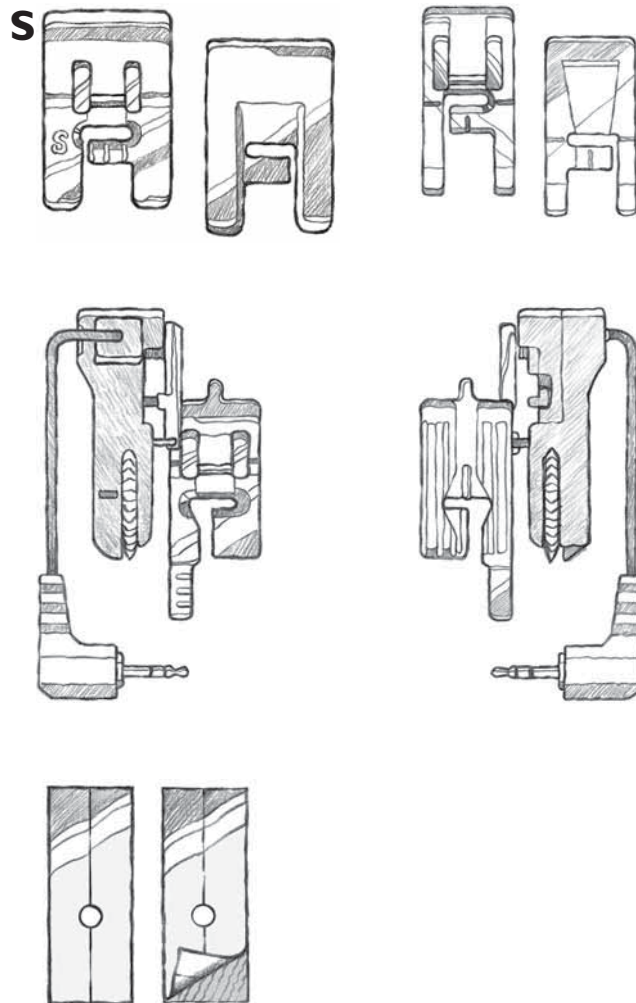

Changing the needle

1. Loosen the screw in the needle clamp by using a screw driver or screw grip.
2. Remove the needle.
3. Push up the new needle with the flat side away from you until it will go no further.
4. Use the screwdriver or screw grip to tighten the screw properly.

Needles

The sewing machine needle plays an important role in successful sewing. To ensure you will get a quality needle, we recommend Schmetz brand needles of system 130/705H.

The needle case contains needles of the most used size for sewing woven and stretch fabrics.

A Standard needles 70, 80, 90

These needles are used for sewing all woven fabrics. The needle point is designed to penetrate between the threads of the fabric so the fabric will not be damaged.

B Stretch needles 75, 90

These needles are used for sewing knitted and stretch fabrics. The stretch needle is marked yellow and has a rounded point.

C Jeans needles 90, 100

These needles are used for sewing woven heavy fabrics, for example denim, canvas fabric. The jeans needle is marked blue and has an extremely sharp point to facilitate the penetrating of the fabric.

D Wing needle 100

The wing needle is used for hemstitching in natural fiber woven fabrics with special stitches on the Heirloom Stitches Menu. The needle has “wings” to push the threads of the fabric aside forming holes where the needle penetrates the fabric.

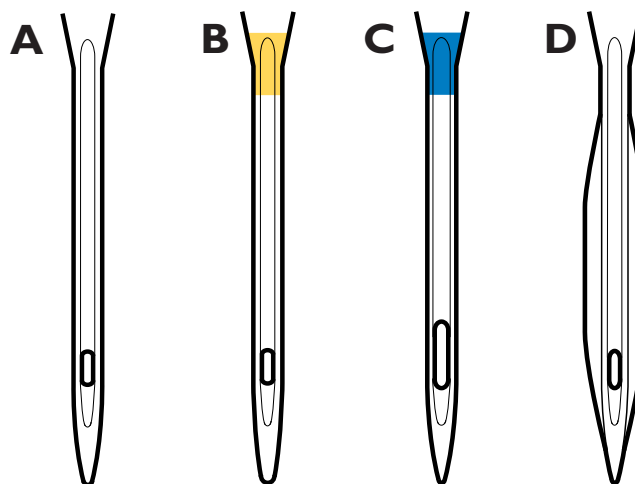
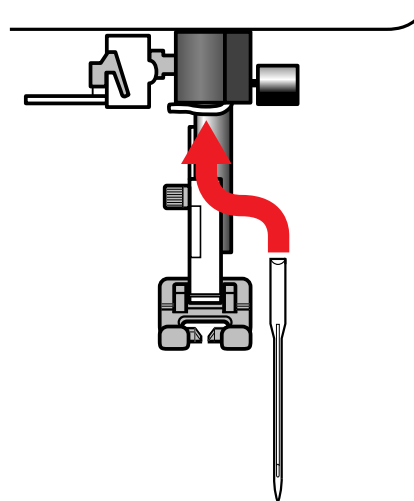

Color Touch Screen

Designer I features an LCD Color Touch Screen at the front right of the machine.

The Color Touch Screen is very easy to work with. Just touch it with your finger tip to select a stitch menu or function tab.

On/Off

When Designer I is off the screen will be dark grey.

When it is turned on you will first see a Welcome Screen, then the Main Menu will appear.

Screen Saver

Your Color Touch Screen can be left on all the time. If you prefer you can set a screen saver to come on after 9 minutes. See Screen Saver, page 30.

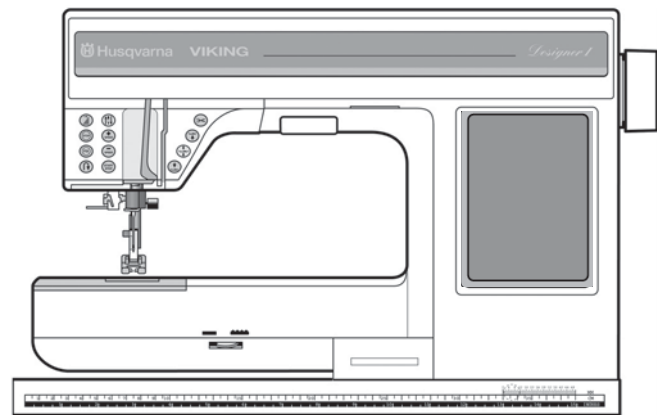
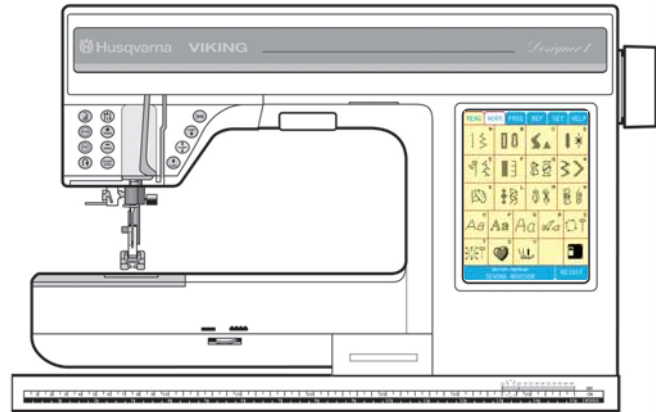

Main Menu

The Main Menu displays 21 Specialty Stitch menus and functions. There are 8 function tabs, SEWING ADVISOR, ADJUST, MENU, NORM, PROG, REP, SET and HELP. When you touch a function tab it becomes active. The MENU tab is yellow when active, other tabs turn white.

Woven medium
SEWING ADVISOR

The easy way to get started, see page 27. Simply select fabric and sewing technique, then Designer I selects the best stitch, length, width, tension, presser foot, presser foot pressure and sewing speed. Your fabric choice in the Sewing Advisor is shown in the touch area. The Sewing Advisor is active when sewing all techniques except embroidery.

ADJUST

ADJUST stitch length and stitch width, elongation and mirror image.

MENU

Touch MENU to select from 21 menus. Touch the disk icon to view or load the embroideries.

NORM

NORM is used for all sewing and embroidery except programming and sewing programs.

PROG

PROG is used to program stitches such as Pictograms, letters and decorative combinations. When the Embroidery Unit is connected touch PROG to customize embroideries and/or lettering.

REP

REP is used to sew out the stitch combinations and embroideries programmed in PROG.

SET

Touch SET to change current settings and functions. See page 29.

HELP

Recommends needle size and type, when to lower feed teeth, stabilize fabric, cord buttonholes etc. When the embroidery unit is connected, you can access the embroidery color menu.

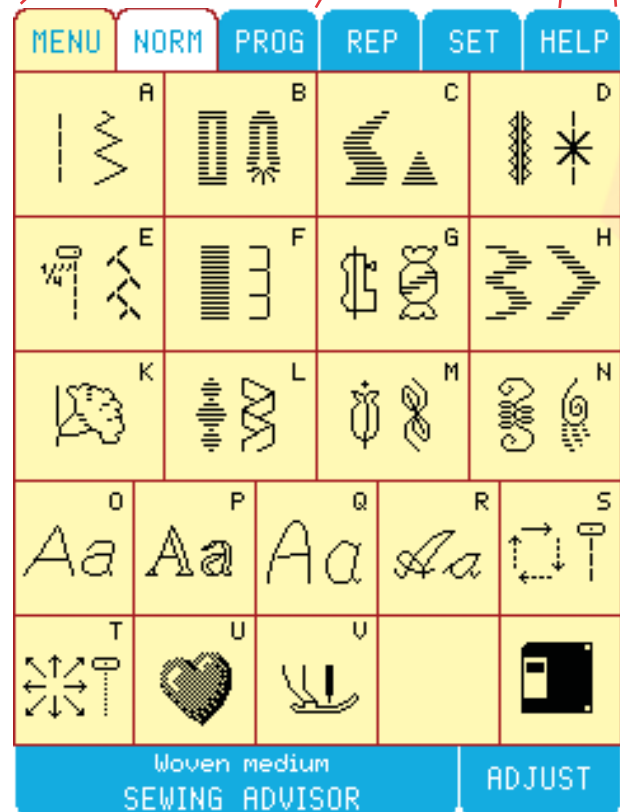
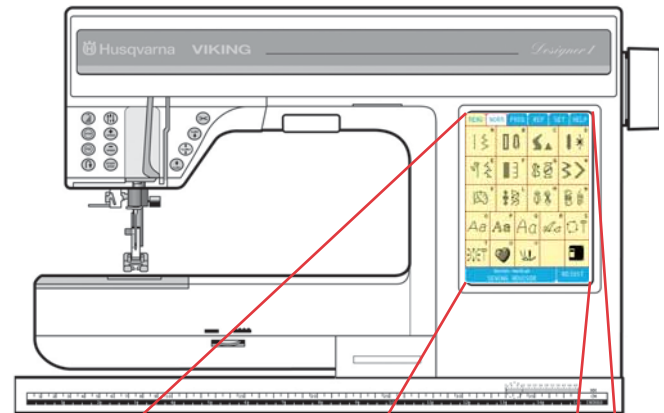

Sewing Advisor – The easy way to sew

The Sewing Advisor is always active, until the Embroidery Unit is connected or when you start to program.

To bring up Sewing Advisor touch

Woven medium
SEWING ADVISOR

The Sewing Advisor has two different menus, Fabric and Sewing Technique.

Fabric

In the Fabric menu you select from 8 different fabric types and weights. Select fabric, the fabric button turns red and immediately the Sewing Technique menu appears.

Sewing Technique

Select from 8 different sewing techniques. Your Designer I immediately selects the best stitch, thread tension, stitch length, stitch width, sewing speed, presser foot and presser foot pressure for your project. The button turns red to indicate the technique you have chosen. If you want to select a new Sewing Technique just touch another technique button.

Move between the Fabric and Sewing Technique menus by using the following buttons at the bottom of the screen.



To close the Sewing Advisor touch Close

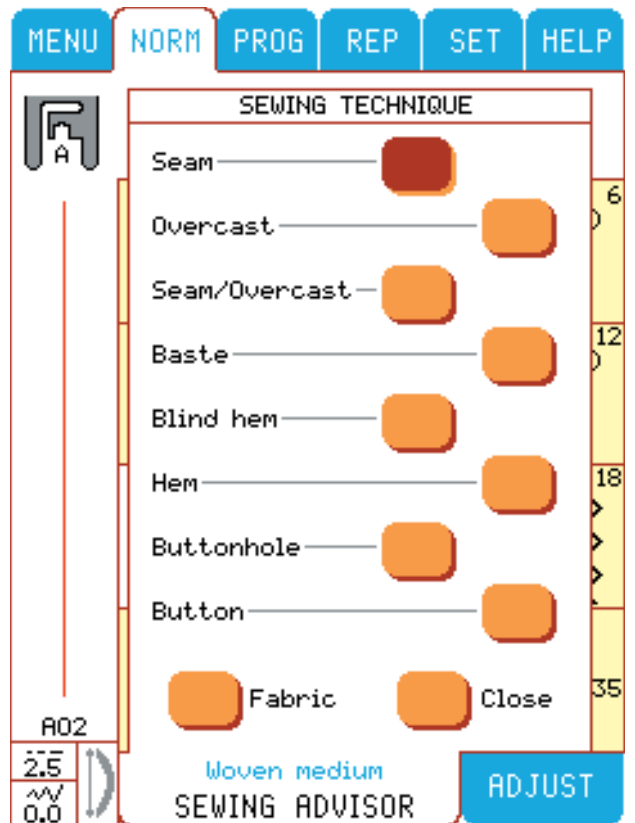
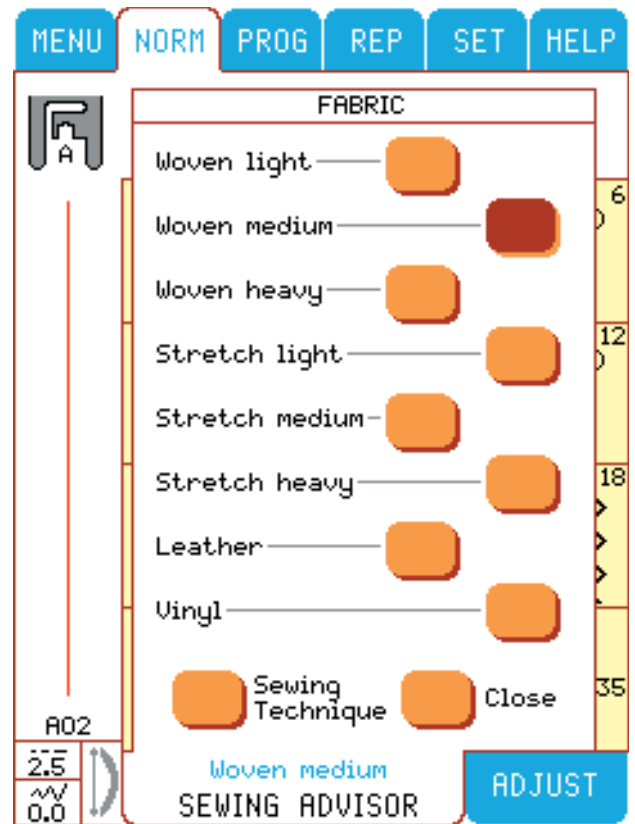

Specialty Stitch Menus

In the Main Menu there are 21 choices, 20 stitch menus and one disk icon.

Utility Stitches

Menu A features stitches for your garment sewing, mending and darning.

Buttonholes

Menu B features different styles of buttonholes, eyelets and button sewing. For best result use the Sensor Buttonhole Foot.

Decorative Menus

Beautiful stitches for your creative sewing on stitch menus C-N.

Letters and Numbers

Choose from 4 different types of letters and numbers. Block, Menu O, Outline block, Menu P, Brush line, Menu Q (9 mm) and Menu R Script. Each lettering menu has 3 menus for upper case and lower case letters and numbers.

4-Way Stitches

Menu S is used to sew stitches in 4 different directions. Stitches are fixed in length and width. The arrow indicates sewing direction of stitches.

8-Way Stitches

Menu T is used to sew in 8 different directions. There are 2 different types of stitches, straight and reinforced straight.

My Stitches

Use Menu U (My Stitches) to save favorite stitches or special settings to a stitch. Adjustments made in the ADJUST menu and settings as tension, balance and presser foot pressure in the SET menu will be saved together with the stitch.

Special Stitches

Menu V includes 4 different types of “free motion technique” stitches. When you are using this menu the feed teeth should be lowered.

Embroidery Disk Icon

View and load embroideries with your Designer I by sliding an embroidery disk into your Built-in disk drive. Touch the disk icon. This allows you to view the embroideries. To load an embroidery, your embroidery unit must be attached to your Designer I.

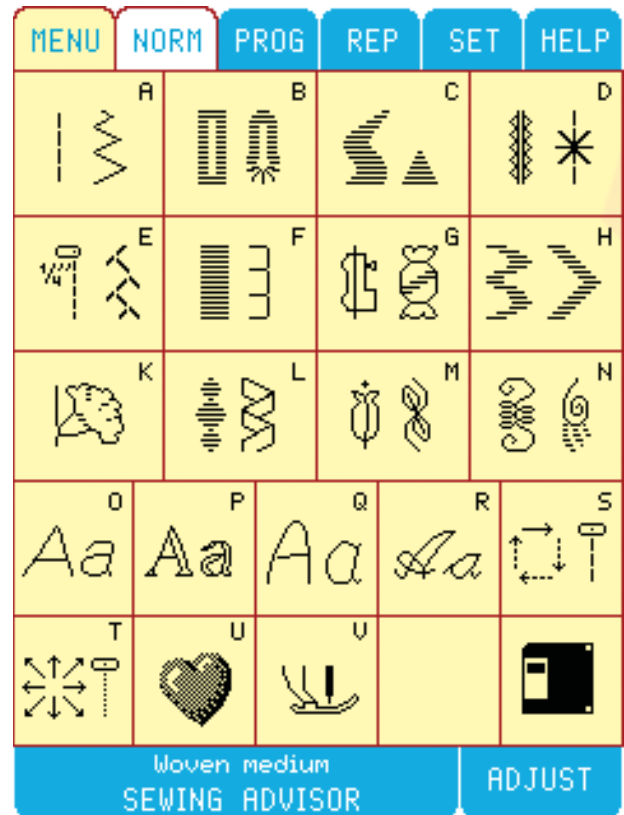

Stitch Menus

Touch Menu A in the Main Menu. Menu “A Utility Stitches” appears on the Color Touch Screen. To the left on the screen, your Designer I displays a selected stitch and a recommended presser foot, in this case presser foot A. The number of the stitch (A02) is shown below the stitch. This is the Designer I default stitch. To select another stitch, touch the picture of the stitch. Designer I will always confirm your choice by highlighting the selected stitch in white, otherwise it has yellow background.

If there is a submenu, you will find a picture with a number combination on, in the lower right corner.

Select stitches number 24-36, submenu.

Touch . To go back touch .

Return to Main Menu by touching .

Utility Stitches

For Utility Stitches touch Menu A in the Main Menu. On Menu A you can find several stitches used for utility sewing. For example you can find different kinds of straight stitch and zig-zag (stitch number 15 is a 4 step zigzag with maximum width of 9 mm). There are also overlock (A16-17) and flatlock (A20) stitches. Stitches A33-36 are perfect for darning and mending.

Buttonhole Stitches

For Buttonhole stitches touch Menu B.

Stitch number 16 is used to sew buttons and 17-19 are used to sew eyelets. The red wheel to the left of the presser foot indicates the Sensor Buttonhole Foot. For buttonhole B6 and B7, Designer I recommends presser foot C. When sewing buttonhole B14 to B15, Designer I recommends presser foot A. When using the A or C presser foot, the symbol of the reverse button is visible on the screen. This indicates that you have to press the reverse button when the buttonhole has reached the desired length. The red arrow next to the buttonhole indicates the sewing direction.

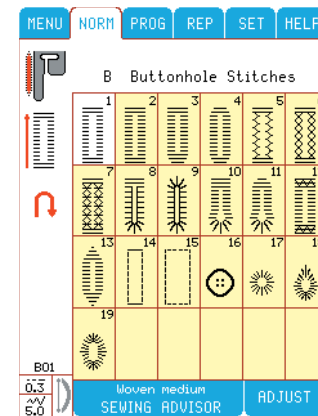
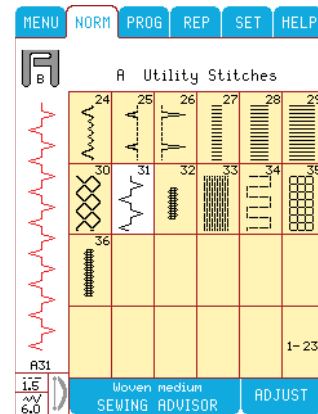
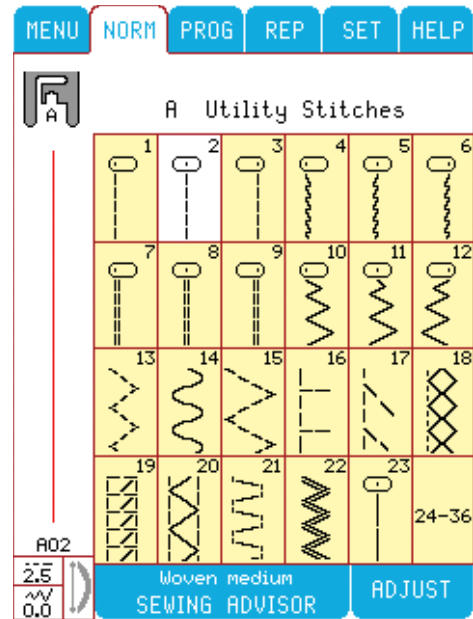

Pictogram Stitches

For Pictogram Stitches, touch Menu C in the Main Menu. Pictogram elements are generally programmed to create original satin stitch designs.

Heirloom Stitches

For Heirloom Stitches, touch Menu D in the Main Menu.

If you are using a wing needle together with the stitches D4-10 and D12, you can attain beautiful hemstitches. The stitches D30-35 are used for smocking and stitch D46 is a pin stitch.

Quilt Stitches

For Quilt Stitches, touch Menu E.

Stitch E1 sews the stitch 1/4" from the right edge of the presser foot. If you want a handlook quilting stitch, you can use stitch E2. Use stitch E24-26 for stippling sewing. There are also stitches that can be used for Crazy Quilting. The feather stitches (E7-12) are very typical for quilting. Stitches E3-6 are 6-9 mm wide and can be used when channel quilting.

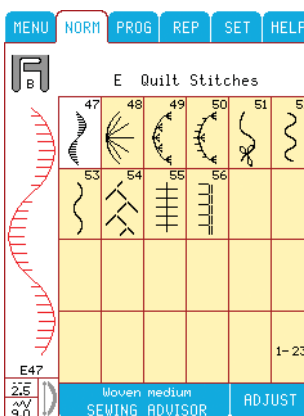
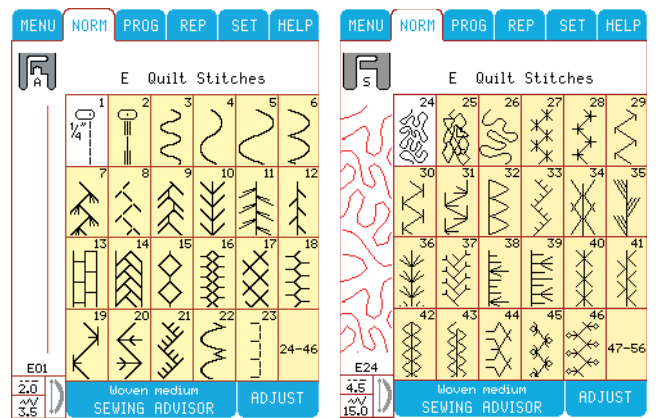
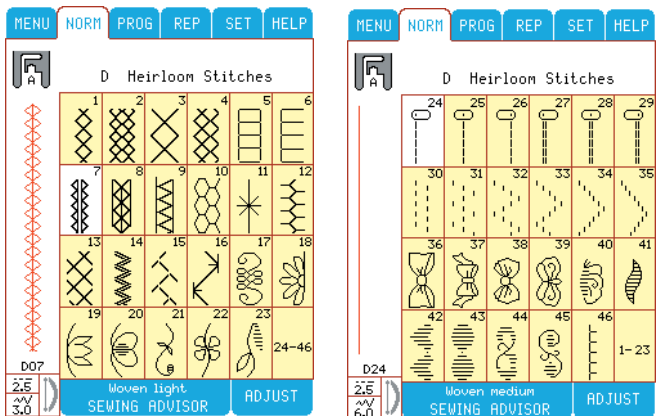
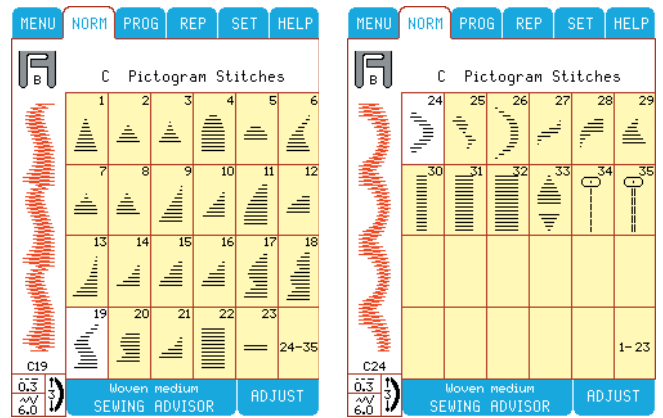

Applique Stitches

Applique Stitches are in Menu F in the Main Menu.

Stitch F11 can be used when you want to imitate the look of appliqué stitched by hand. When sewing with stitch F13 and F14 you will get a beautiful shadow effect. Stitch F15 is used for precision applique and F16 is a mitered frame stitch.

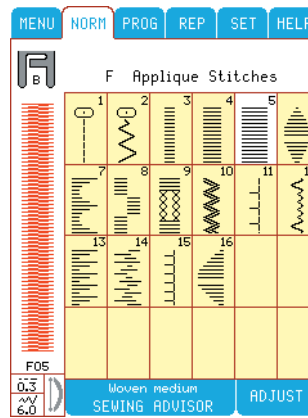

Children Stitches

For Children Stitches touch Menu G in the Main Menu.

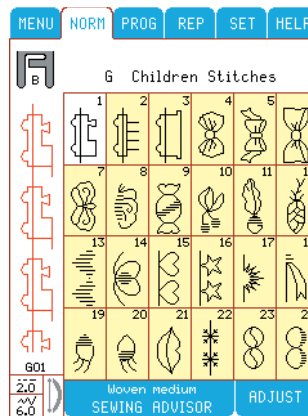

Scallop Stitches

For Scallop Stitches touch Menu H in the Main Menu.

The scallops 1-13 are Omnimation scallops and sew up to 25 mm wide. Scallops 16-34 are up to 9mm wide.

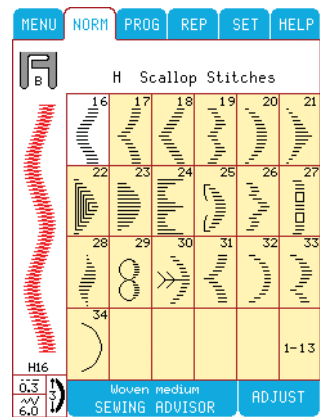
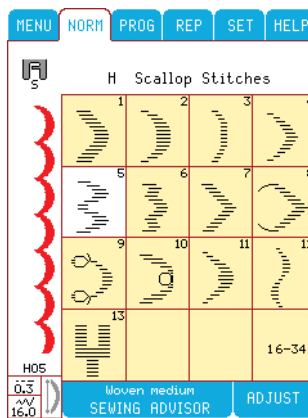

Omnigram Stitches

For Omnigram Stitches touch the Menu K in the Main Menu.

These stitches are possible to combine with each other into an unlimited number of sequences.

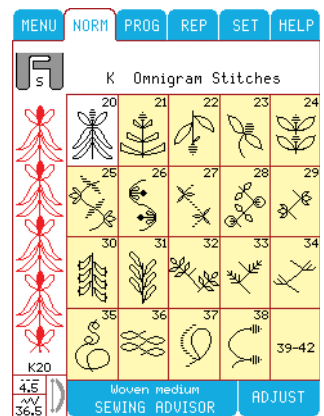
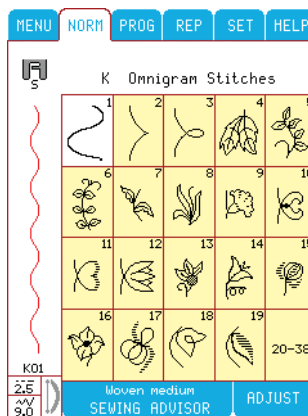

Stitches 39-42 are sewn as a single pattern. After sewing one pattern your Designer I will fix the stitch and then stop.

Decorative Stitches

For Decorative Stitches touch Menu L in the Main Menu.

Crafting Stitches

For Crafting Stitches touch Menu M in the Main Menu.

The width of the stitches varies from 6-9 mm.

Fashion Stitches

For Fashion Stitches touch Menu N in the Main Menu.

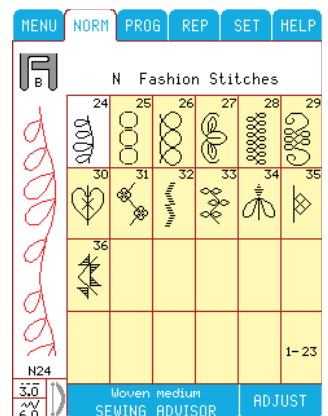
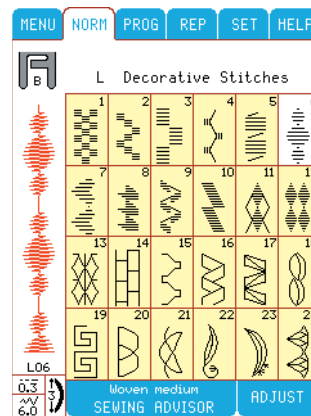
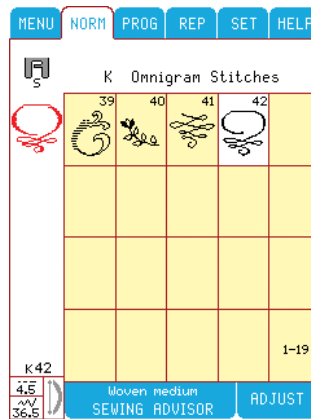

Block, Outline block, Brush line and Script alphabet

Touch Menu O, P, Q or R for letters and numbers. There are 3 different menus. Touch

A.. for upper case.

a.. for lower case.

1.. for numbers and special letters.

To change the style menu, simply touch the desired style button above.

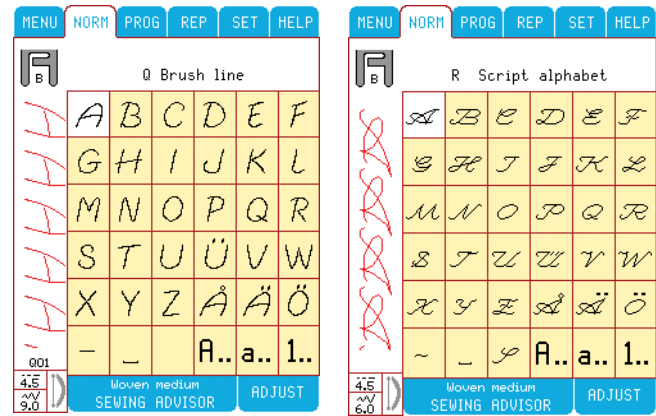
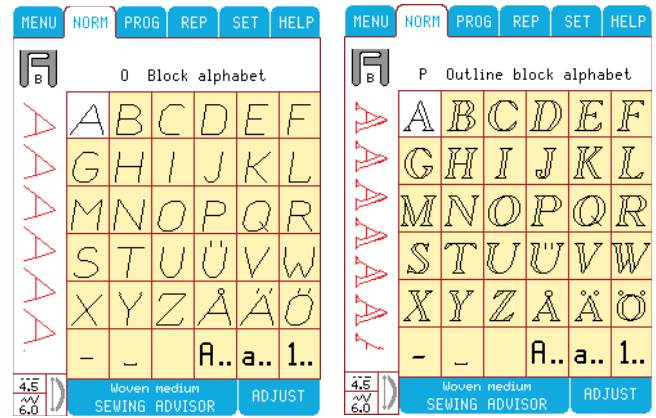

4-Way stitches

Find 4-Way stitches in Menu S in the Main Menu.

4-Way stitches is mainly used to sew one fabric to another using the free arm. The stitches are programmed at a fixed width and length.

The selected stitch direction is visible in the screen beside the presser foot.

If you look at the 4-Way stitch direction icon,  you see 4 different arrows. Each time you touch the button, the sewing direction changes. You can also use the reverse button to change sewing direction. Your Designer I always starts sewing in direction from left to right.

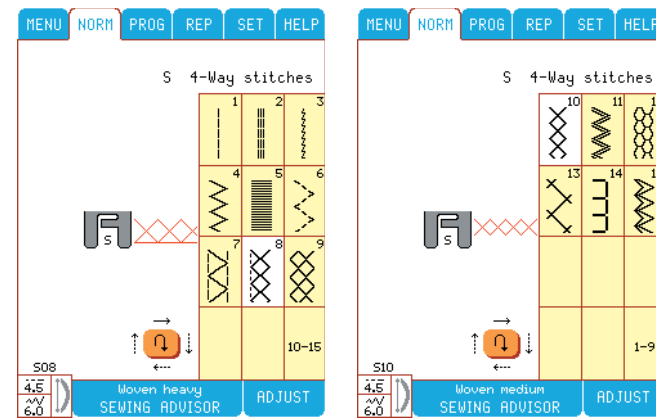

8-Way stitches

Find 8-Way stitches in Menu T in the Main Menu. There are 2 different stitches, straight and re-inforced straight stitch.

The 8-Way stitch touch buttons display 8 different directional arrows. The selected sewing direction arrow is highlighted in white. Touch another direction arrow button to change the sewing direction.

Note: By changing the stitch length, and/or stitch width for a selected stitch, you also changes the sewing angle. Thereby you have the possibility to sew in whatever direction you want.

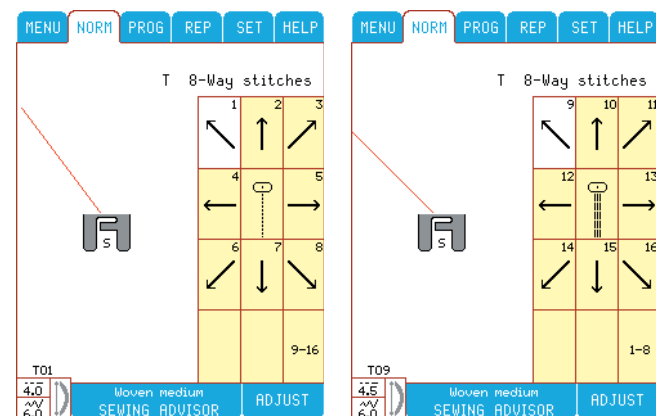

My Stitches

On Menu U, you can customize a favorite stitch menu, saving your own personal settings for a stitch. This menu is called “My Stitches” (Menu U) and is shown on the Main Menu with a heart symbol. On “My Stitches” you can save 30 stitches with adjustments made in **ADJUST** (length, width, elongation and mirroring) and with settings made in **SET** (tension, balance and presser foot pressure). To save your favorite stitch/setting, go to **SET** and select **Save**. Menu U will pop-up. Touch the desired position for your stitch. The original stitch number is shown in brackets after the U stitch number.

Note: Stitches from Menu S and Menu T cannot be saved on Menu U.

When there are no free positions available or if you want to replace a stitch, touch an occupied position and its stitch will be replaced by the new one. To delete a stitch from Menu U, select the stitch then access **SET**. Press **Del** and the active stitch will be deleted. The next stitch will be selected instead (You can see the selected stitch to the left on the screen). You can repeat the procedure until all stitches are deleted. When Menu U is empty, straight stitch (A02) will be selected automatically.

Special Stitches

For free motion sewing, darning, quilting, basting and free hand embroidery touch Menu V. There are four stitch types available, V01, straight stitch, V02, zigzag and V03 and V04, basting stitches. Lower the feed teeth and for V01 and V02 snap on the R foot or one of the optional free motion feet. When free motion (free hand) sewing at slow speed (less than 200 rpm) the presser foot moves up and down. The foot is down when the needle is down to hold the fabric in place while the stitch is formed. The foot is raised with the needle so the fabric can be moved without the risk of bending the needle. At faster sewing speeds (over 200 rpm) the foot stays in the glide (pivot) position so the fabric can be moved easily for free motion sewing. Use stitch V03 and V04 together with the foot control. If STOP button is canceled you will have automatic timing. Step on foot control and feed the fabric manually while the presser foot is up. V03 is a straight stitch and stitch V04 moves sideways.

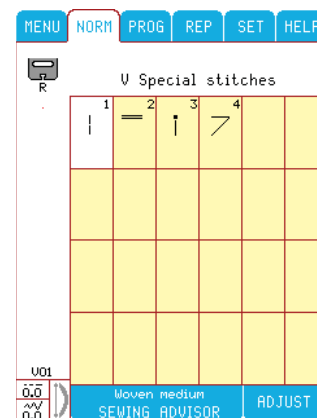
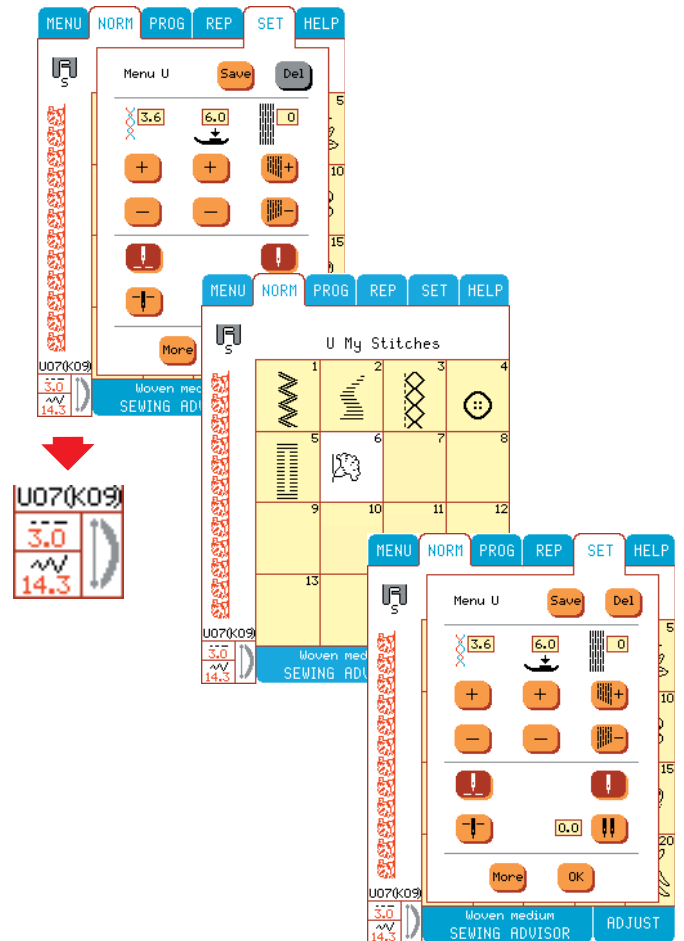

Starting to sew

- Touch Sewing Advisor on the Color Touch Screen. Enter the type and weight of fabric you are sewing. Select the desired sewing technique from the Sewing Advisor or select a stitch from one of the menus.
- Place top and bobbin thread under the presser foot and to the back. For best results when beginning at the edge of the fabric, place a finger on the threads to hold them in place as you begin.
- Place fabric in position under the presser foot.
- Step on the foot control and begin sewing. The presser foot is lowered automatically.
- If you need to adjust fabric, touch Pivot .

Note: Use  to start and stop the machine without using the foot control.

Thread tension

The Sewing Advisor will automatically set the thread tension for the fabric and sewing technique selected. To adjust the tension for unusual fabric or thread, see page 29.

To understand the correct thread tension, sew a few sample zigzag stitches at different settings.

1. Begin with a tension that is too loose, i.e. set at the lowest number. The lower thread will lie straight and the upper thread will be drawn down on the underside.
2. If you set the tension at the highest number, the opposite will occur, and the seam may pucker.
3. The correct thread tension is provided when the threads interlock in the middle of both layers of material or, in the case of decorative stitches, on the underside.

Make a few tests on a scrap piece of the fabric you are going to sew and check the tension.

Finish the sewing

- Lift your foot from the foot control.
- Touch . Designer I cuts the top and bobbin threads. The presser foot and the needle are raised to the up position automatically.

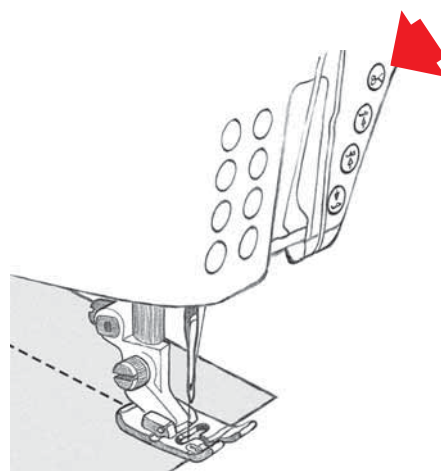
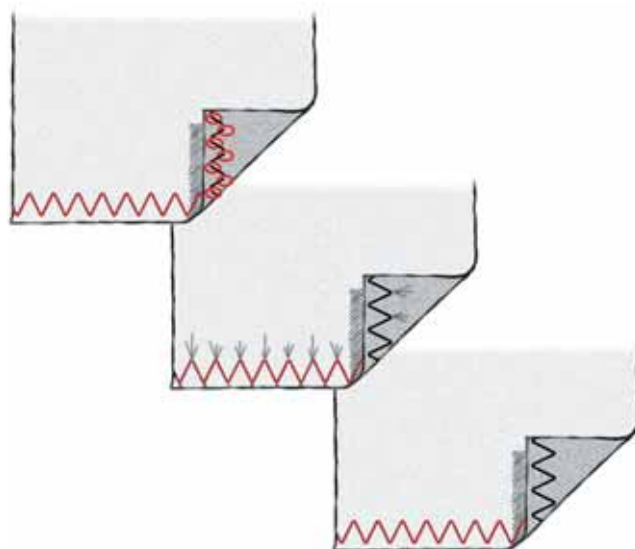
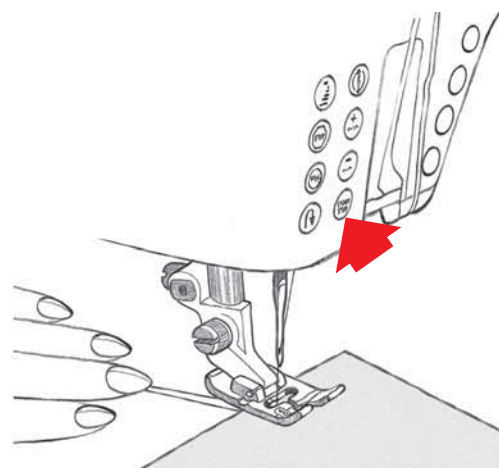

Adjust Menu

Touch **ADJUST** to override automatic settings and make manual adjustments in stitch length, stitch width and elongation. You can also mirror image stitches side to side and end to end.

The stitch length, stitch width and elongation can be changed by touching **+** or **-**.

You are able to use elongation when you are sewing satin stitches.

When a setting has been changed, it is indicated by a bold red frame around the numbers in the ADJUST menu, and with red numbers in the lower left corner of the Stitch Menu.

Minimum and maximum settings are indicated with an audible “beep” signal.

Touch buttons for mirror image, **↔** **↔**, are highlighted in brown when selected.

Settings that are not available are colored grey and can not be selected.

You are able to sew while you are in **ADJUST**.

Close **ADJUST** if you wish to select another stitch.

Touch **OK** to close **ADJUST**.

Note: The SET, HELP and ADJUST menus can be selected at any time and will close automatically.

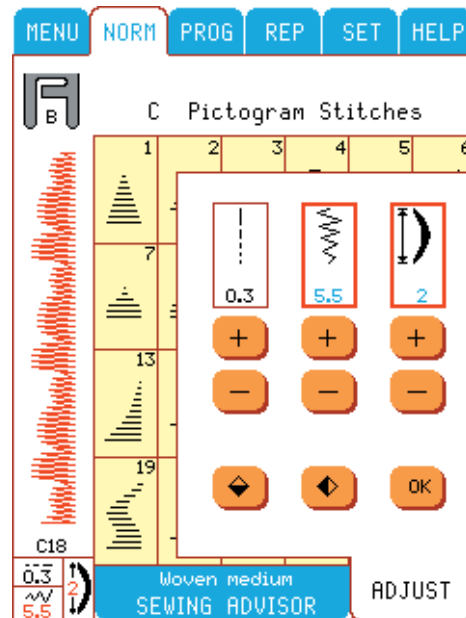

Set Menu

Touch **SET** to override automatic setting and make manual adjustments. There are four different set menus. Touch **More** if you want to jump between them. To close Set menu touch **OK**.

When you have made changes in standard settings for thread tension, presser foot pressure, and balance, the frame around the setting will be highlighted in red. The changed settings will affect all stitches and the settings remains until the Designer I is turned off.

Menu U

Touch **Save** to save a favorite stitch on the "My Stitches" menu. Any personal settings from **ADJUST** or **SET** (including tension, presser foot pressure, balance) will be saved together with the stitch.

To delete a stitch from Menu U, touch **Del**. (For more information see page 26).

Thread tension



Adjust top thread tension by touching **+** or **-**. The numbers in the window above indicates the tension setting. The higher the number the more tension on the thread.

Presser foot pressure or Pivot position

Adjust presser foot pressure by touching **+** or **-**. The number in the window above indicates the pressure setting. The higher the number the more pressure the foot puts on the fabric.

When settings changed on stitches in the V Menu or when embroidering, the height of the pivot position is set instead of the presser foot pressure.



Balance or

Adjust stitch balance by touching  or . The number in the window above indicates the balance setting.

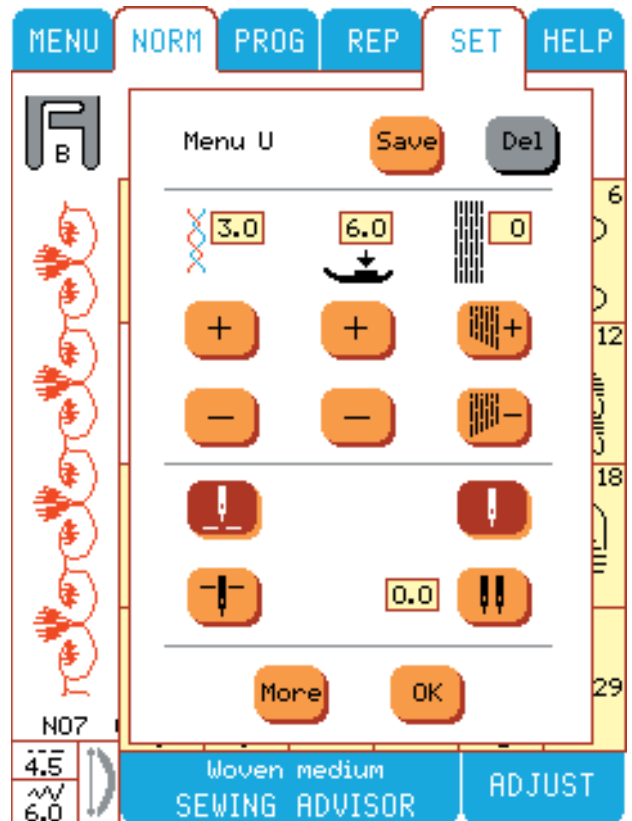

When a buttonhole is selected, the balance buttons will adjust the density of the right column of the buttonhole. See page 52, Buttonhole Balance.





Needle stop position

Needle stop up or down is set by touching  or . The function button (page 12) on the machine is another option to set needle stop up or down.

Twin needle safety

When you are going to use a twin needle, enter the size (the distance between the needles). Touch   step by step until correct value is displayed in the window. For standard single needle, touch .

Touch  to move to next  menu.



Screen Contrast

Touch  or  to reduce or increase contrast.

Screen Saver

The screen saver will save the screen by switching off the light if you have not touched the machine for approximately 9 minutes. Touch  if you wish to cancel the screen saver.





Sensor Foot

Touch  to cancel the automatic lowering and pivot position of presser foot, when stepping on foot control. You can also touch the  function button.

Selective Thread Cutter



If you prefer to activate the selective thread cutter manually with the function button, touch .

Help Pop-up menu

When  is selected a Help pop-up will appear with recommendations for your sewing.  only appears if a sewing circumstance has changed. Touch  if you want to bring up help menu when you need it by touching .

Language English

If you want to change language of text on the Color Touch Screen, then touch  until your language choice is indicated.

Touch  to move to next  menu.

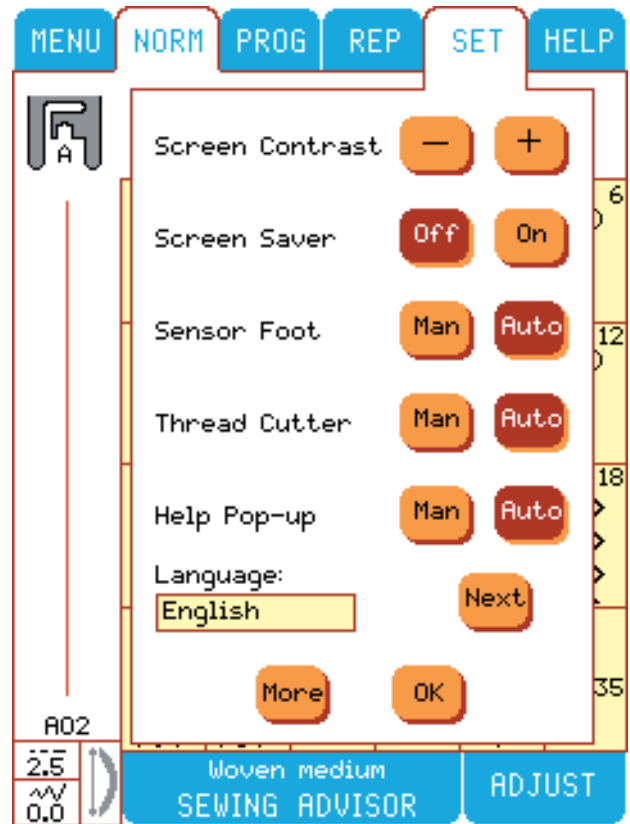

Calibration of the Color Touch Screen

If you touch a function tab or stitch picture on the Color Touch Screen but it does not respond or the function next to it is activated instead, the screen has to be calibrated. The Color Touch Screen is calibrated at the Husqvarna Viking factory, but the settings may be affected when the machine is shipped and transported. You only need to calibrate the Color Touch Screen if there is a precision problem when touching the function tabs or stitch pictures.

To calibrate the Color Touch Screen, touch **SET**, then touch **More** twice. Select “Color Touch Screen adjust” in the third menu and the calibration screen appears.

1. Touch in the center of cross 1 (the upper left corner of the screen). This is best done with a pointed but not sharp object (for instance the blunt plug end of the Sensor Buttonhole foot). When the cross changes from black to green the first point is set.
2. Touch in the center of cross 2 (lower right corner of the screen) to set the second point. Touch Save to store the new setting.

The calibration is now completed.

You can always use **Back** to leave the Calibration screen without saving any changes.

Note: When calibrating the screen, be sure to touch the cross areas only, as recommended. If other areas are touched, the screen can be miscalibrated. A miscalibrated screen may require an adjustment by an authorized technician.

Touch **OK** to close the **SET** menu.

Fix

Touch **Man** if you want to decide when to use “FIX”. **Auto** automatically activates Fix at stitch selection and after thread cut.

Sensor Q-foot

Touch **On** to set the Sensor System to operate the optional Sensor Q-foot.

Grid

The 20x20mm grid function is very useful when you are going to customize several designs together (see Customizing designs). Align your designs by using the grids. Touch **On** to activate the grid function.

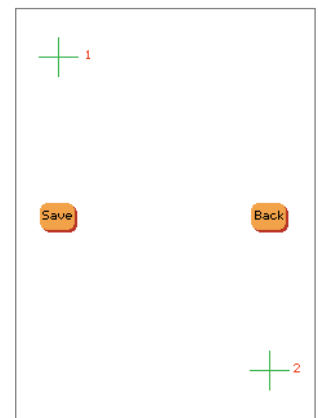
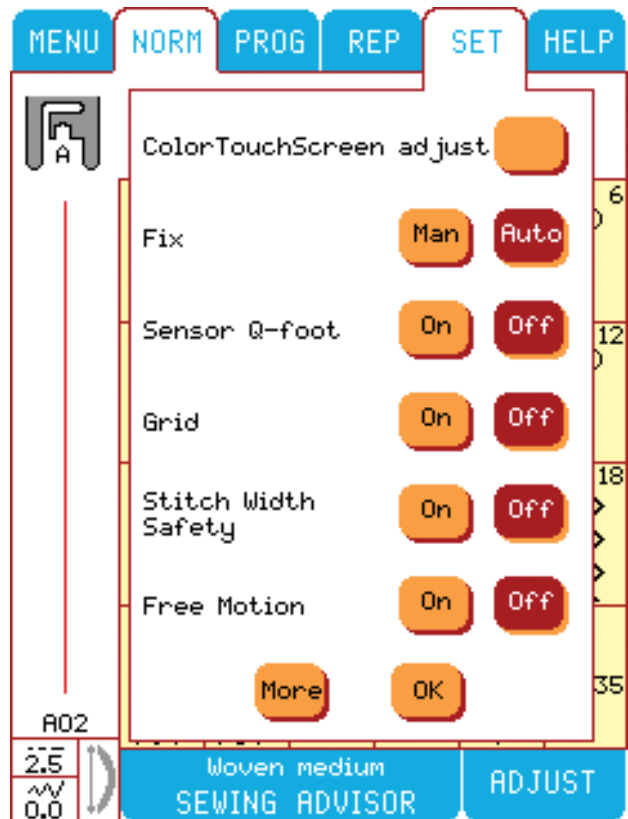

Stitch Width Safety

Touch  if you want to lock the needle side movements when using a straight stitch plate, a straight stitch foot or a 1/4" piecing foot P.

Free motion

Touch  to turn all the stitches into free motion stitches.

Note: When using the free motion function, the feed teeth should be lowered.

Alarm repeat

Touch  to select a repeated alarm. Your Designer I will then repeat the signal for alarm pop ups while the machine is sewing.

Screen lock

To activate the screen lock, press . When the screen lock is activated, the stitch selection buttons are not active. To unlock the screen lock, touch the key image in the upper right corner of the color touch screen.

Running time

In the set menu there is a stopwatch that will measure the machines running time. To reset the stopwatch, touch .

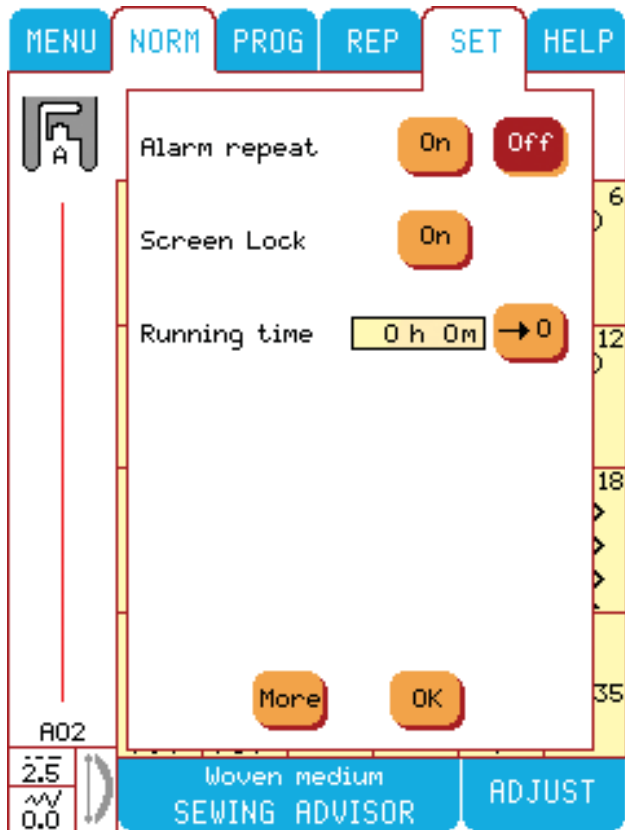

Pop-up menus

Top Thread Break



Your Designer I stops automatically if the top thread runs out or breaks. Rethread the top thread, touch .

Empty Bobbin



Your Designer I stops automatically when the bobbin thread is almost empty. Replace the empty bobbin with a full one, touch .

Note: It is possible to continue sewing until all thread on the bobbin has run out.



Twin needle

When the twin needle safety button  is set in the  menu, the width of the stitches is limited. If you select a stitch that is too wide the twin needle pop-up appears. The stitch width of the selected stitch is adjusted automatically to fit the twin needle setting.

The twin needle pop-up also appears if the twin needle safety button is set when the machine is turned on.

Touch the -tab and touch the single needle button  to cancel the twin needle safety.

Sensor foot Q

Sensor Q-foot (optional) is set to  in the  menu. Change to  to cancel.

Stitch Width Safety



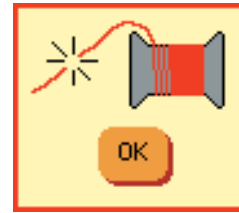









If you have been using a straight stitch plate (optional) or the P-foot and have set the stitch width safety, the Designer I alerts you when turning on the machine or when selecting a stitch that has stitch width more than 0.0.



HELP menu

In **HELP** you are able to get information about type of needle, presser foot, stabilizer etc. In **SET** menu you can choose between **Man** or **Auto** on the **HELP** menu. Set it to **Auto** when you want it to open automatically. To exit **HELP** touch **OK**

Examples on symbols in the **HELP** menu:

- Normal needle  80 Normal
- Stretch needle  90 Stretch
- Wing needle  100 Wing
- Stabilizer 
- Top thread, size 40  40
- Bobbin thread, size 70  70
- Presser foot R  R
- Attach Self-adhesive glide plate 
- Close the buttonhole 
- Clearance Plate 
- Feed teeth up  down 
- Color Menu icon 

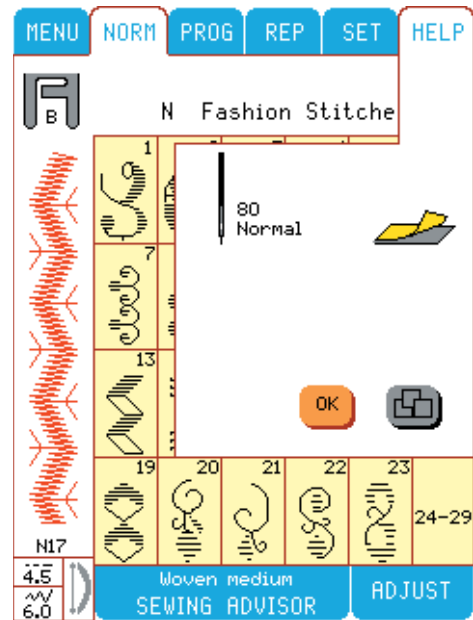

Programming

Select your fabric type in the Sewing Advisor before programming.

Program stitches, letters, and numbers into memory. Your Designer I has 15 permanent memories. This means you can program a stitch combination into memory and when you turn off the machine it is retained in the memory. Each of the 15 permanent memories holds up to 62 stitches which means you can program and save up to 930 stitches and letters at one time.

Touch **PROG**. It will change from the blue color to white because it is now active.

Presentation of PROG menu

Moving the cursor > <

Use arrows to move sideways step by step.

Deleting stitches or program **Clr**

If there is a stitch or letter combination already in memory displayed across the top of the screen in the programming area, touch **Clr** to clear the memory. You are able to reload deleted program if you touch **Clr** again before you enter new stitches.

Memory ^ v **M1**

Use the up and down arrows to select memory. The yellow box displays the memory numbers from M1-M15 (memories 1 to 15). A cursor appears in the program area ready to accept a stitch or letter.

How to program stitches and letters

We are going to program the sequence shown below, combining letters and decorative stitches:



Touch **MENU** to go back to the Main Menu.

Touch Menu G, Children stitches are displayed.

Touch stitch number 1, locomotive.

It appears at the top of the screen in the programming area in a blue color which indicates it is entered as the first stitch in the program.

The cursor moves automatically to the next position ready to accept the next stitch.

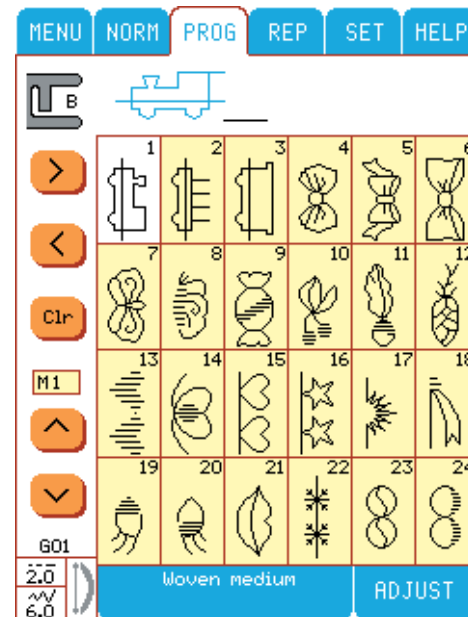
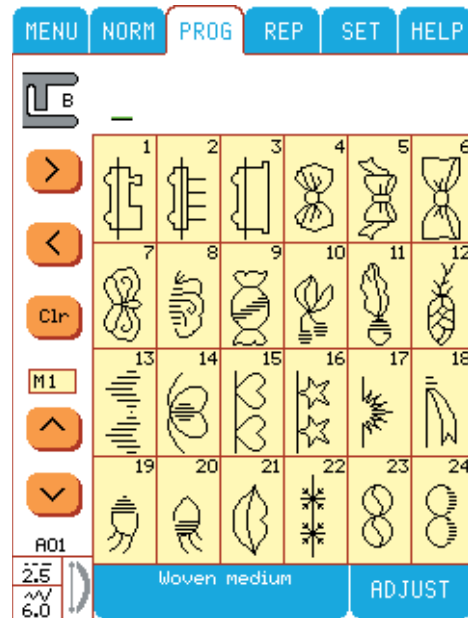
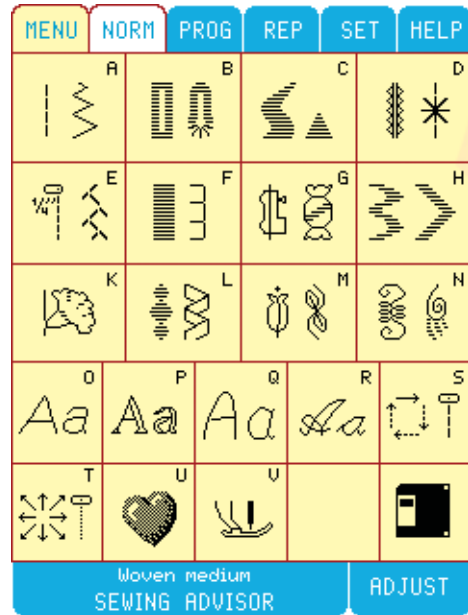

To program "J" in upper case letters.

Touch **MENU**, touch Menu O.

Touch "J" and "J" appears on the screen.

To program "ohn" in lower case, touch **a..** in the lower right corner of the alphabet screen. The lower case submenu will appear.

Touch o, the letter appears and the cursor moves to the next position. Continue to enter the letters: h, n.

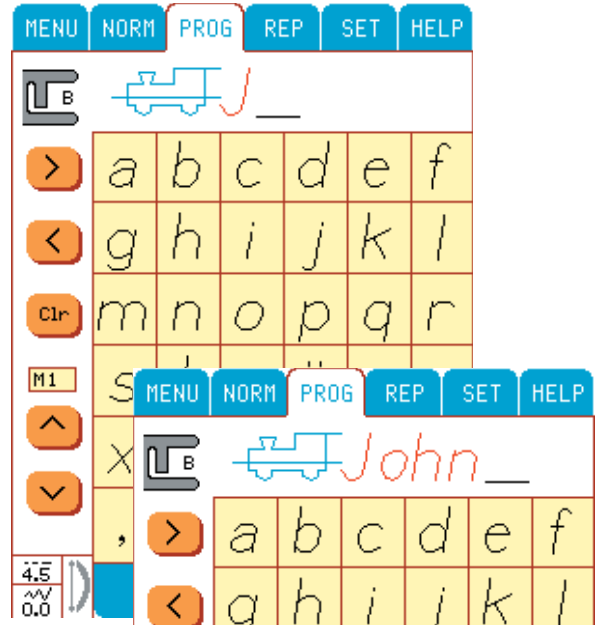
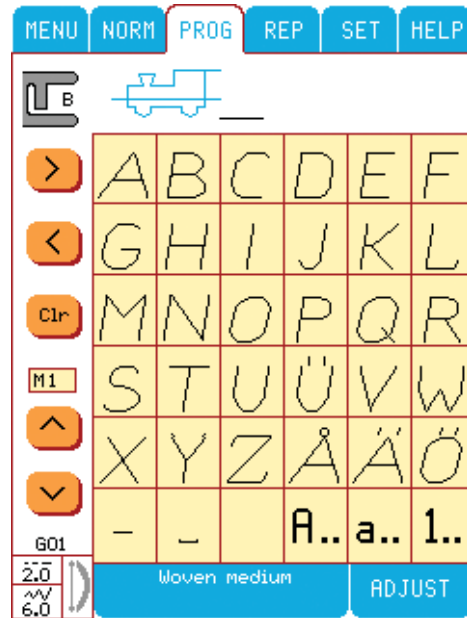



To enter a new locomotive. Touch **MENU**.

Touch Menu G.

Touch stitch number 1.

To mirror image the locomotive, touch **ADJUST**.

Touch end to end mirror image button . The locomotive changes and the mirror image button turns brown. Touch **OK** to close **ADJUST**.

Touch  function button on the machine to sew only one sequence of your program.

Touch  function button if you want to add a tie off in your programmed sequence. It is also possible to add several fixes one after another.

Touch  function button to add a cut in your sequence to make your Designer I cut the thread when it has finished sewing.

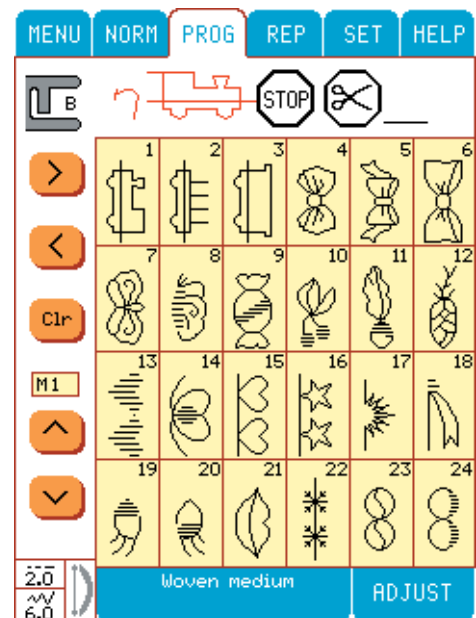
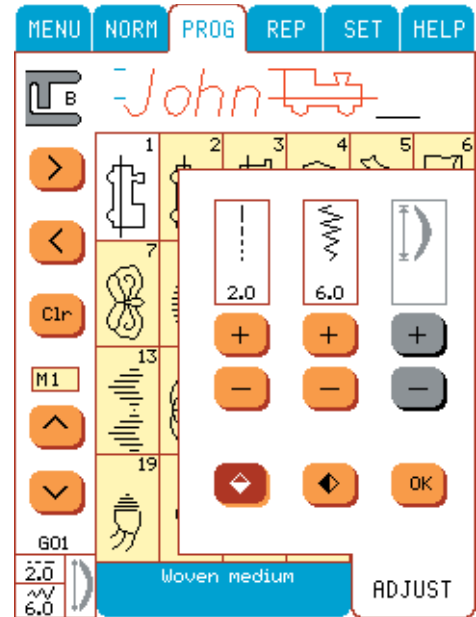
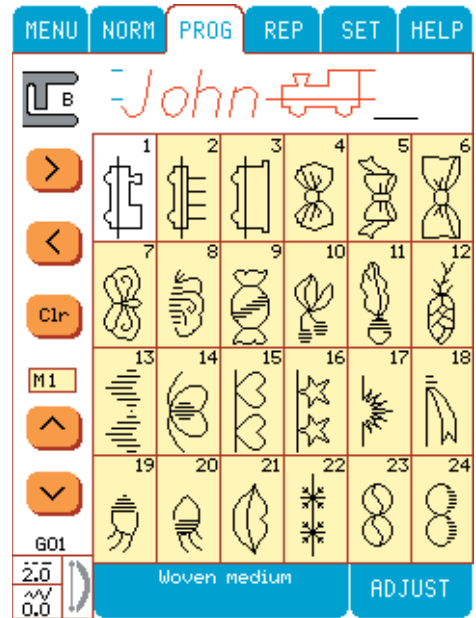

Sew

To sew your program, touch **REP**. It will change color from blue to white. Your stitch program will appear on the screen in the direction it will sew. The presser foot is recommended. The first stitch in the program is shown in blue. The others are red. A stop is indicated by a stop sign symbol.

If you have programmed a stitch sequence that is too long to be seen on the Color Touch Screen, you can step forwards/backwards in the sequence using the **↙** **↘** icons.

Sew your program on a stabilized piece of fabric.

Change a stitch or letter

Any stitch or letter can be changed in the **REP** mode when the cursor is under the stitch or letter. It is active and green in color: Simply touch the correct stitch or letter, to change it.

Add a stitch or letter

To add a stitch or letter in the **REP** mode, move the cursor to the stitch where you wish to add a stitch. Touch **Clr**. Touch the stitch you wish to add. Touch **Clr** to bring up the rest of the program again.

Adjust stitches in program

If you want to adjust stitches in the programmed sequence, you can move the cursor back and forth using the **←** **→** icons. You can use any of the **ADJUST** functions: stitch length and width, mirror image and elongation. A stitch is adjustable when the cursor is positioned underneath it (the stitch is highlighted in green). The last programmed stitch can be adjusted even though the cursor is positioned after the stitch.

The changes will be remembered in the permanent memory.

Adjust entire stitch program

Use **ADJUST** functions in **REP** mode to change stitch length, stitch width and mirror image. If you have programmed satin stitches **only**, you are able to do changes in elongation too.

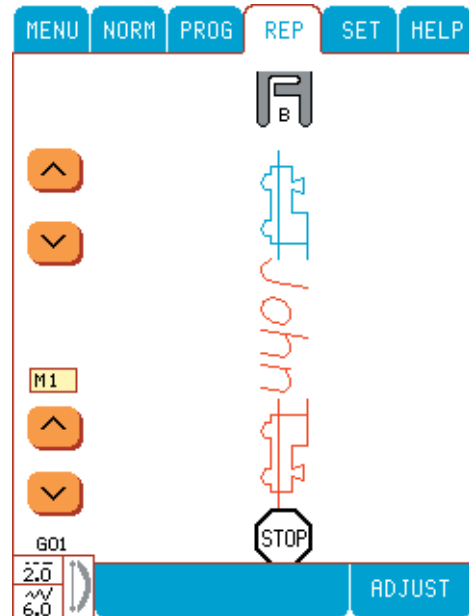

Utility Garment Sewing

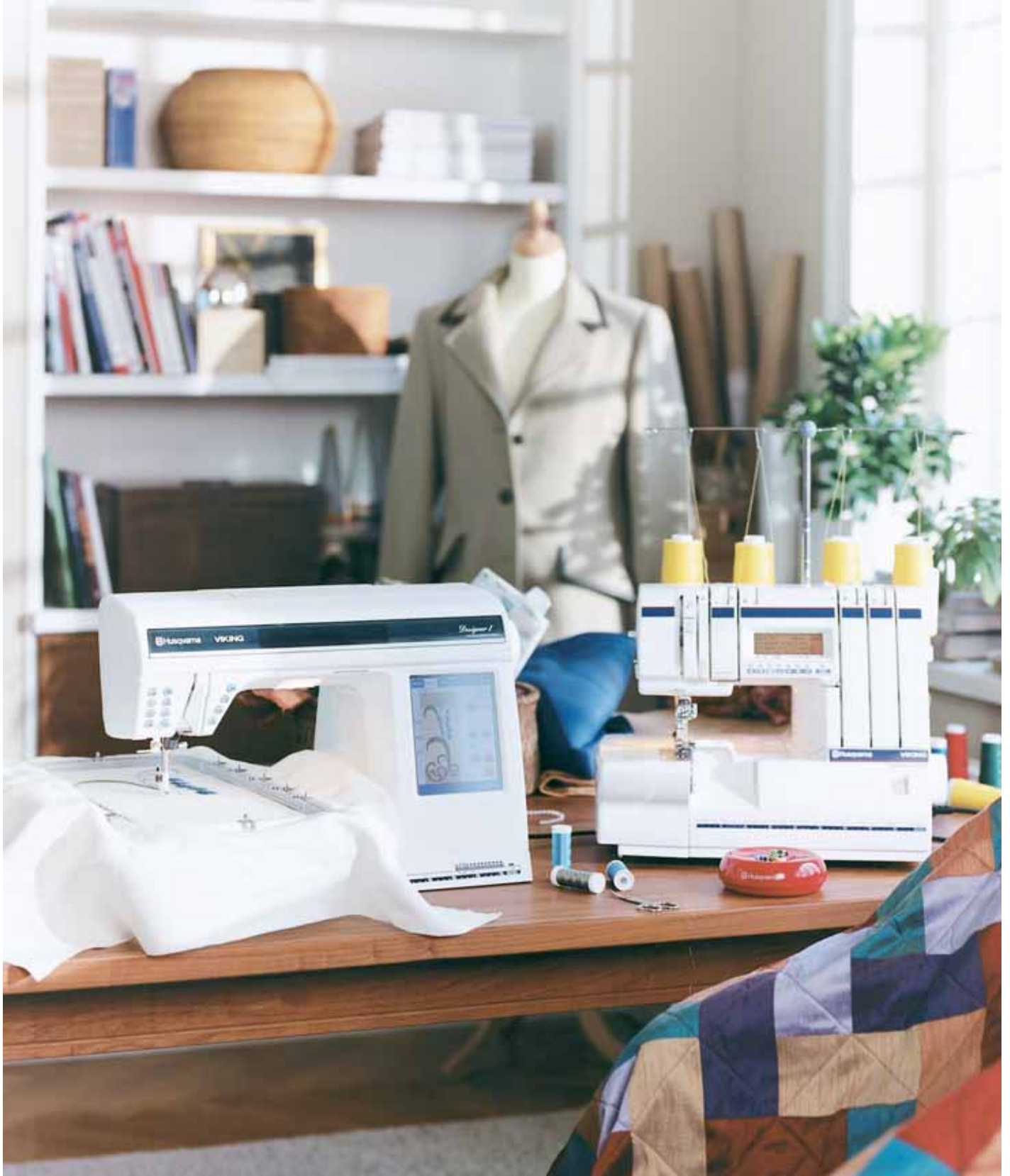

Sewing Advisor

Your Designer I sewing machine features the exclusive Husqvarna Viking Sewing Advisor.

When beginning a sewing project, touch Sewing Advisor. The fabric menu will appear on the Color Touch Screen. Touch your fabric type and the sewing technique menu will appear. Touch the technique you desire to sew. The Sewing Advisor immediately sets the best stitch, stitch length, width, tension, presser foot pressure and sewing speed for your project. What a timesaver!

Your Husqvarna Viking Sewing Advisor is always active when sewing from a stitch menu or before programming or until you have connected the Embroidery Unit, simply enter the fabric weight and type for your project. The Sewing Advisor does the rest, setting your stitch choices for your project.

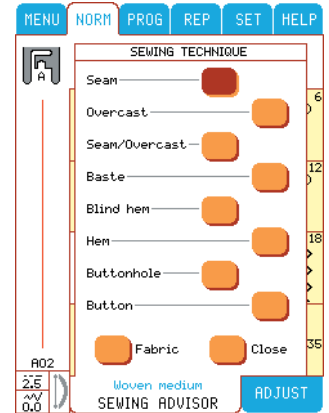
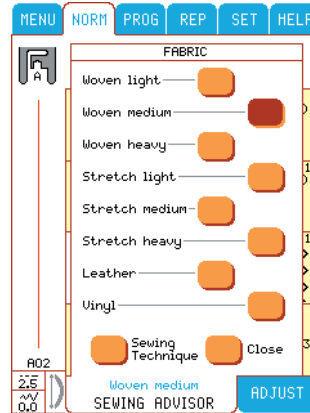

Fabric Selection

Woven or Knit:

The difference is the way the threads are put together. Woven fabrics are made of two thread systems, warp lengthwise and weft crosswise that intersect at right angles. A knit fabric is made of one thread system with interlaced stitches. A knit fabric is elastic. As a general rule, enter Woven for stable fabrics that have no stretch and Stretch for fabrics that are elastic.

Leather

Leather is animal skin with the coat (fur) removed. Leather can be smooth or sueded and has some give.

Vinyl

Vinyl is a synthetic material which often has a woven wrong side. Vinyl can be smooth or patterned and some vinyl has give.

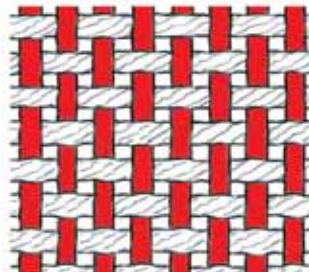

Woven fabric

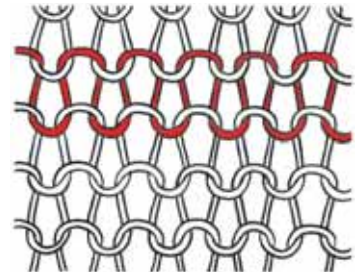

Knit fabric

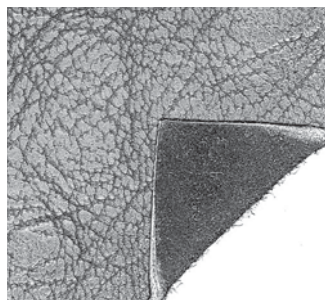

Leather

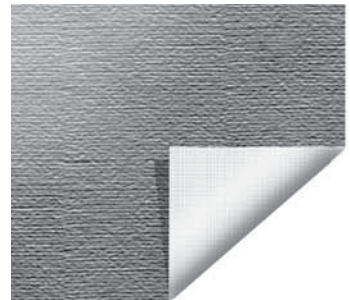

Vinyl

Selecting Fabric on Sewing Advisor

- **Woven light:** for chiffon, organza, batiste, silkies, wool challis, etc.
- **Woven medium:** for calico, quilting fabrics, wool crepe, and broadcloth, etc.
- **Woven heavy:** for denim, wool suiting, coating, canvas, etc.
- **Stretch light:** for charmeuse nylon, single knit jerseys, etc.
- **Stretch medium:** for double knit, plush, swimwear, slinky, etc.
- **Stretch heavy:** for sweater knits, fleece, etc.
- **Leather:** for suede and real leather.
- **Vinyl:** for artificial leather and suede.

Thread

All purpose sewing thread

Made of synthetic, cotton or cotton covered polyester. Used for sewing garments and textiles.

Embroidery thread

Made of various fibers, rayon, cotton, acrylic. This thread creates a smooth glossy appearance for embroidery and other decorative stitching.

Note: When using a metallic thread for embroidering, you may need to use a needle with a larger eye and lower the embroidery speed.

Embroidery bobbin thread

Fine weight synthetic or cotton thread to reduce build-up on the wrong side.

Invisible thread

Single clear synthetic thread. Used for quilting and other decorative sewing.

As you read the following instructions, sew the step by step exercises to learn your Husqvarna Viking Designer I sewing machine to the fullest.

The Husqvarna Viking Sewing Advisor will save you hours of sewing time! It always knows the best stitch and settings for your fabric type, fabric weight and sewing technique. The following exercises will teach you how to use it.



Seam

A seam sews two pieces of fabric together with a seam allowance that will usually be pressed open. In most cases edges of the seam allowance are finished with an overcast stitch before sewing the seam.

Fabric: Woven medium, cut in two.



Touch: Sewing Advisor on the Color Touch Screen.

Enter: Woven medium on the Fabric screen. Seam on the Technique screen. (The Sewing Advisor selects a straight stitch.)

Snap on: Presser foot A as recommended.

Use: Size 80 needle as recommended.



Sew:

- Place fabrics right sides together. Put the fabric in position under the presser foot. Line up edge with the 5/8" (15 mm) seam guide.
- If you need to adjust fabric, touch Pivot .
- Step on foot control. The Sensor Foot lowers automatically. Stitch a seam halfway down the fabric.
- Touch Needle stop down .
- Stop sewing 5/8" (15 mm) from the end. The Sensor Foot raises to the pivot position with the needle in the fabric. Pivot fabric. Step on the foot control, the Sensor Foot lowers automatically. Sew along the edge following the instructions below.

Reverse

- Touch  to lock stitch.

STOP

- Touch  to finish a stitch and automatically sew a few stitches in place to tie off and stop. Touch  again to cancel it.

FIX

- Touch  to lock the stitches with tiny straight stitches that sew back and forth slightly.

Thread cutter

- After having finished the seam, touch . The top thread is taken to the back of the fabric. The thread cutter cuts top and bobbin threads. The presser foot raises to remove fabric.

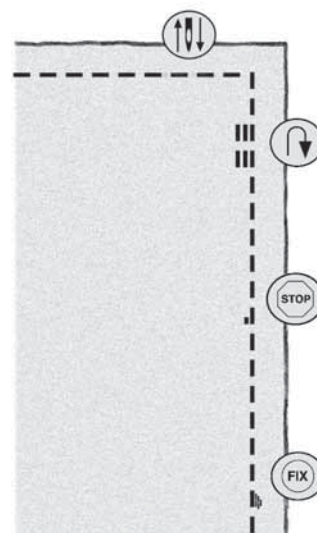
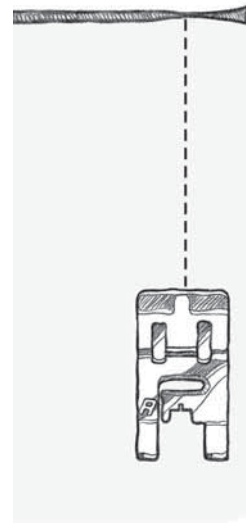
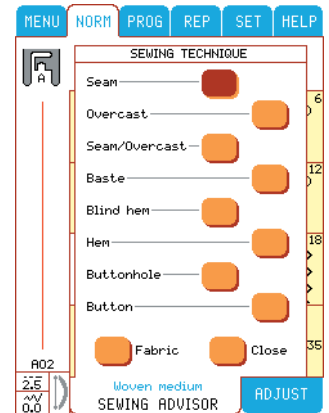
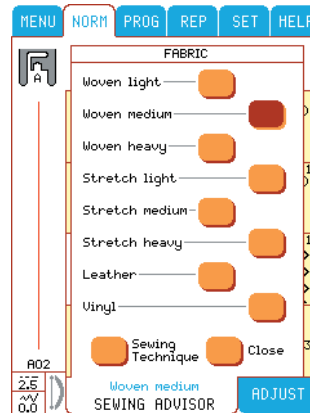

Seam

Seams in stretch fabric must stretch with the fabric. The Lightning Stitch (Stretch Stitch) makes a stretchy seam that is suitable for sewing together pieces of light stretch fabric.

The Lightning Stitch is ideal for topstitching in light stretch fabrics. The Sewing Advisor will select the best stitch, stitch length and width, tension, presser foot pressure and sewing speed according to the fabric type and weight.

Fabric: Stretch light, cut in two.

Touch: Sewing Advisor on the Color Touch Screen, Stretch light on the fabric screen, Seam on the technique screen. (The Sewing Advisor selects a lightning stitch.)

Snap on: Presser foot A as recommended.

Use: Size 75 stretch needle as recommended. Place fabric pieces right sides together. Put the fabric in position under the presser foot. If you need to adjust fabric, touch Pivot .

Sew:

- Step on foot control. The Sensor Foot lowers automatically.
- Stitch a seam along the 3/8" (10 mm) seam guide.
- After having finished the seam, touch .

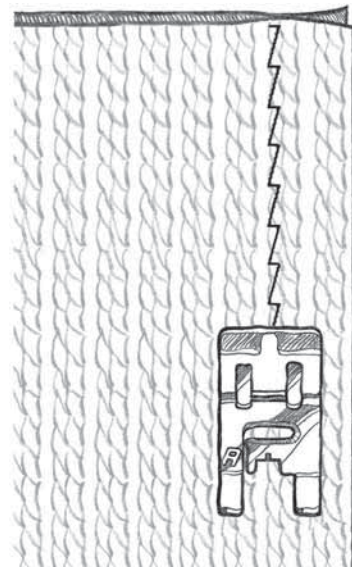
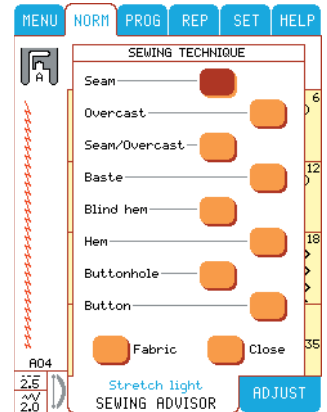
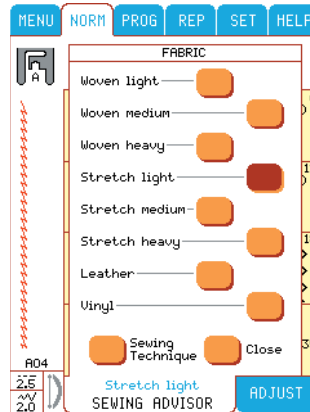

Overcast

Overcast fabric edges to prevent fraying and to help them lay flat. It is easiest to overcast before the garment is sewn together. The J presser foot is recommended for light and medium weight fabric to prevent puckering along the edge. The B presser foot for heavy weight fabric. Your Sewing Advisor will select the best length and width for the fabric weight.

Fabric: Woven medium

Touch: Woven medium on your Sewing Advisor, Overcast on the technique screen. (The Sewing Advisor selects a 3-step zigzag stitch.)

Snap on: Presser foot J as recommended.

Use: Size 80 needle as recommended.

Place the edge of a single thickness of fabric under presser foot J with the pin on the foot along the edge of the fabric. The 3 step zigzag stitch sews over the pin to keep the edge of the fabric flat.

If you need to adjust fabric, touch Pivot .

Sew:

- Step on foot control. The Sensor Foot lowers automatically.
- Sew to overcast the edge of the fabric.
- Touch .

Note: It is not necessary to overcast leather or vinyl, but the Sewing Advisor gives you the possibility. Touch Leather or Vinyl on your Sewing Advisor, Overcast on the technique screen. (The Sewing Advisor selects a zigzag stitch).

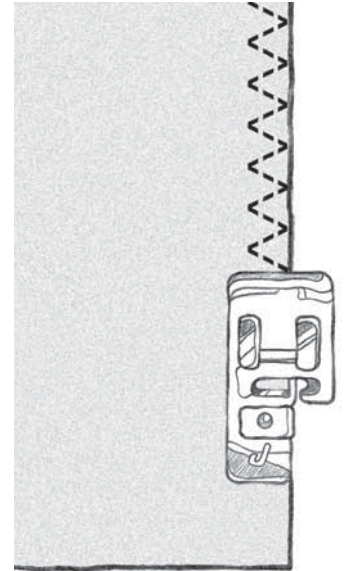
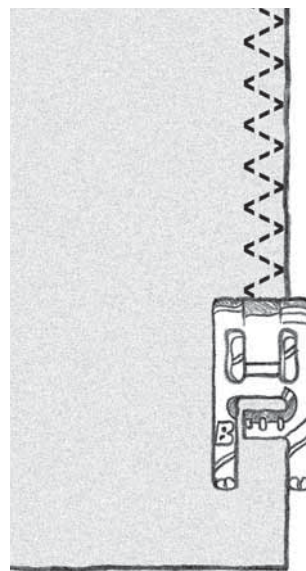
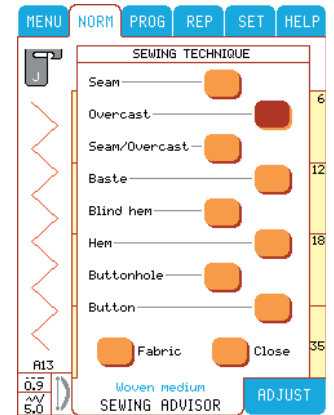
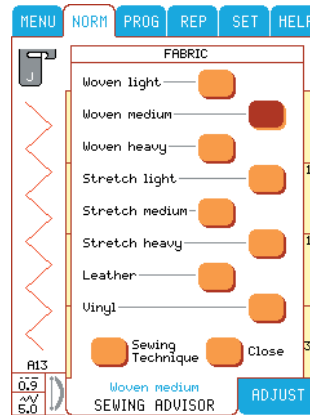

Seam and Overcast

The Seam/Overcast stitch sews the seam and overcasts the edge all at one time. This saves time. There are a number of different Seam/Overcast stitches on your Designer I. Your Sewing Advisor will select the best one for your fabric and make all adjustments automatically.

Fabric: Stretch light, cut in two

Touch: Stretch light on the Sewing Advisor fabric screen. Seam/Overcast on the technique screen (A).

Snap on: Presser foot J as recommended.

Use: Size 75 stretch needle as recommended. Place fabric pieces right sides together. Put the fabric in position under the presser foot with the pin on the foot along the edge of the fabric. If you need to adjust fabric, touch Pivot .

Sew:

- Step on foot control. The Sensor Foot lowers automatically.
- Seam/Overcast along one edge
- Touch .

Repeat the Seam/Overcast technique on Stretch heavy fabric (B) and on Woven heavy fabric (C). Your Sewing Advisor will select the best stitch, length, width, tension, presser foot pressure and sewing speed for each fabric type. Follow other recommendations given on the Color Touch Screen.

Seam/Overcast for ribbing

The Seam/Overcast technique is perfect for stitching ribbed neckbands and cuffs. Cut a mock neckline in a Stretch medium fabric, touch Stretch medium and Seam/Overcast in the Sewing Advisor and sew a piece of ribbing to the mock neckline with a 1/4" (6mm) seam allowance, stretch ribbing as you sew.

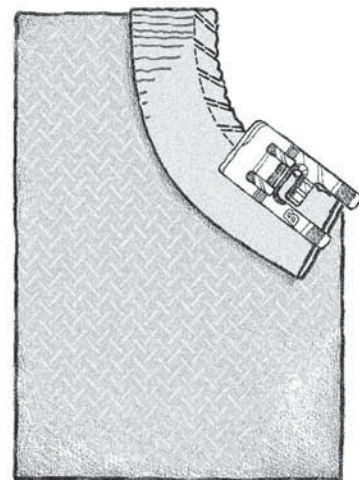
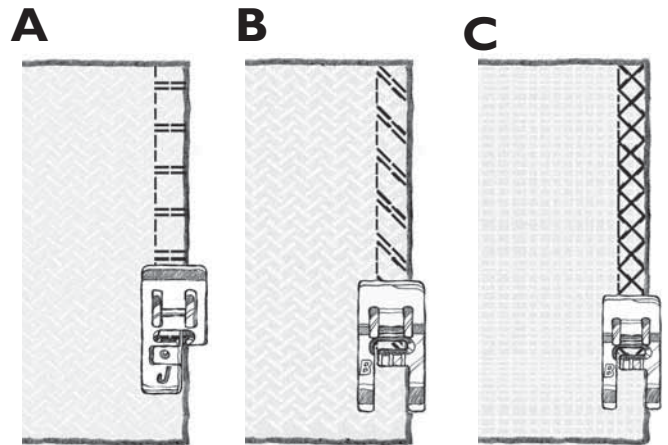
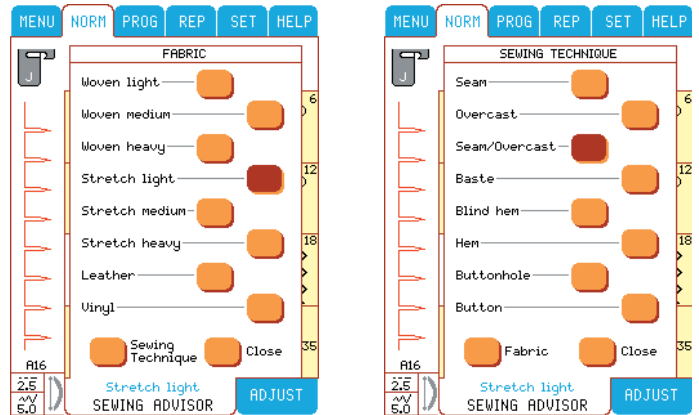

Baste

Basting is temporary stitching for fitting garments, gathering and marking. Your Sewing Advisor automatically sets a long stitch length and reduces the tension so the threads are easy to remove or to pull for gathering.

Fabric: Woven medium, cut in two.

Touch: Woven medium on the Sewing Advisor fabric screen and Baste on the technique screen.

Snap on: Presser foot A as recommended.

Use: Size 80 needle as recommended.

Place the fabrics right sides together. Put the fabric in position under the presser foot.

Seam allowance: 5/8" (15 mm). If you need to adjust fabric, touch Pivot .

Sew:

- Step on foot control. The Sensor Foot lowers automatically.
- Stitch along seam line.
- Touch .
- Pull bobbin thread to remove stitching.

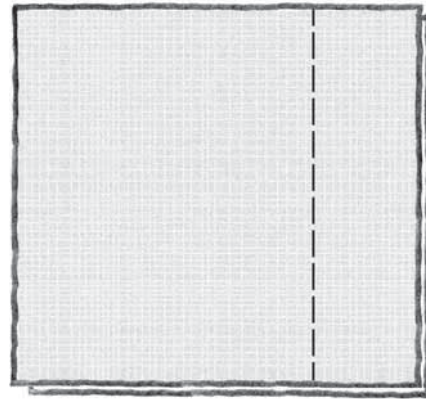
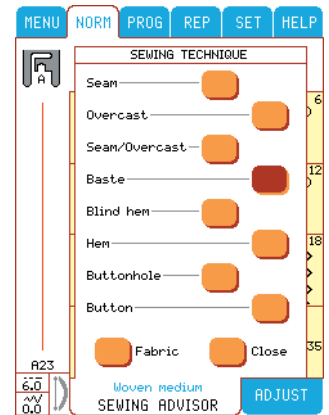
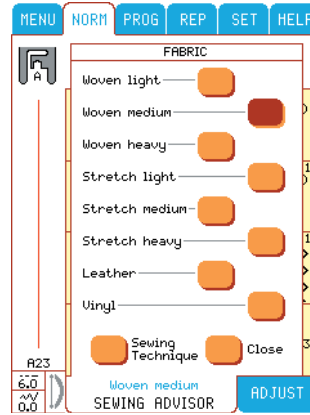

Blind Hem

The blind hem creates an invisible hem on garments. There are two types of blind hem, one is recommended for medium to heavy woven fabrics, the other for stretch. The blind hem is not suggested for light weight fabric, but your Sewing Advisor will select the best stitch possible.

Fabric: Stretch medium

Touch: Stretch medium on fabric screen and Blind Hem on technique screen in the Sewing Advisor.

Snap on: Presser foot D as recommended.

Use: Size 90 stretch needle as recommended.



Fold a 2" (50 mm) hem along one fabric edge place pins in place perpendicular to the hem with the hem to first entry of the pin about 1/4" (6mm) from the hem edge.

Hold the fabric wrong side up with the hem to the right.

Fold the hem under to the right side, leaving about 1/4" (6mm) of the hem extending to the right. You will sew on this extension.

Sew:

- Place the fabric under presser foot D with the folded edge against the right toe of the foot.
- Touch Pivot  and adjust fabric if necessary. Be sure to remove the pins before you sew over them. Do not try to sew over pins. Step on the foot control. The Sensor foot lowers automatically.
- As the large zigzag swings to the left, it should barely catch the fold. Generally the Sewing Advisor will choose the correct width. Adjust the stitch width if necessary.

If too much fabric is caught,  narrow the width. If the zigzag is not catching the fold,  widen the width.

- Touch .

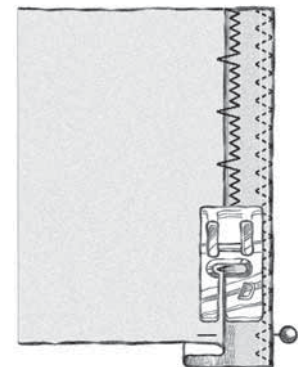
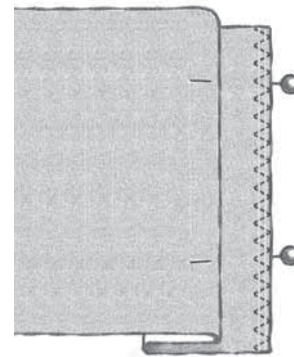
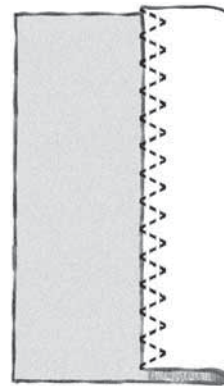
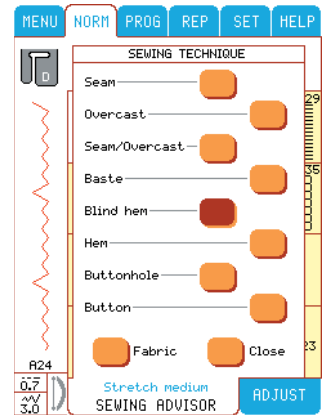
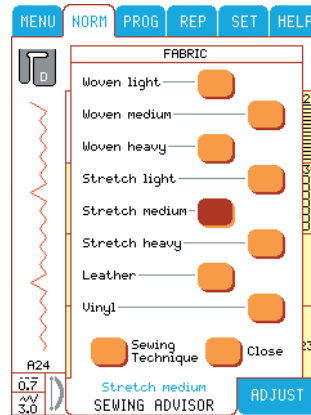

Hem

The Hem technique on your Sewing Advisor will select the visible or topstitch hem that is best for your fabric weight and type. For woven fabric, leather and vinyl, a straight stitch is selected. For stretch fabrics, elastic stitches are selected.



Fabric: Woven medium.

Touch: Woven medium on the Sewing Advisor fabric screen and Hem on the technique screen.

Snap on: Presser foot A as recommended.

Use: Size 80 needle as recommended.

Sew:

- Fold and press a 3/8" (10 mm) hem fold and press another 3/4" (20mm) hem. Put the fabric in position under the presser foot.
- Touch Pivot  and adjust fabric if necessary. Step on the foot control. The Sensor Foot lowers automatically.
- Sew along the hem edge.
- Touch .

Repeat this technique on a Stretch medium fabric. The Sewing Advisor selects a flatlock stitch. Follow other recommendations given on the Color Touch Screen.

Fold a hem to the wrong side and stitch with flatlock stitch on the right side. Trim away excess fabric.

Use this technique for belt loops too.

Tip: When sewing over seams in extra heavy fabric or a blue jeans hem, the foot can tip as the machine climbs over the seam. The needle can hit the tipped foot and break. In this case, use the clearance plate to balance the height of the hem as you sew.

Place it behind the foot as you approach the hem and in front of the foot as you sew over the hem thickness. Remove the clearance plate before sewing in to it.

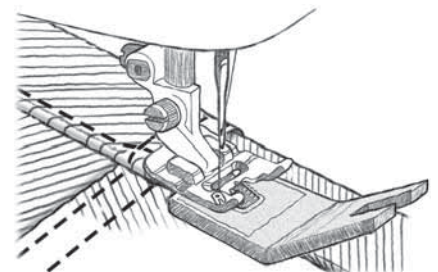
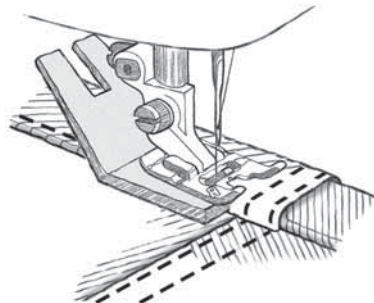
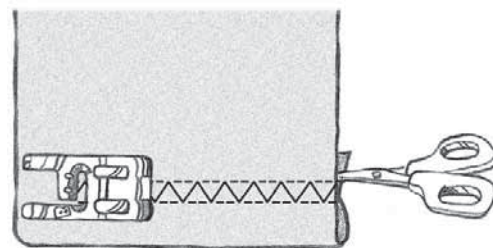
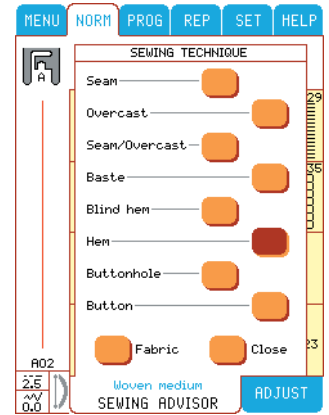
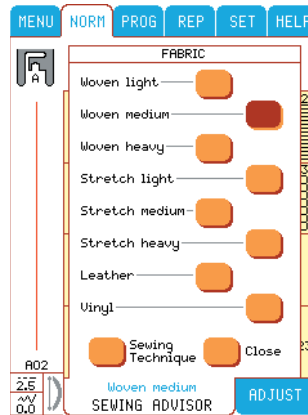

Buttonhole

The Sewing Advisor will select the best buttonhole and stitch settings for your fabric. Fabric should be interfaced and/or stabilized where buttonholes are to be sewn.

Mark the buttonhole placement on your fabric with your Pictogram pen™.

You can also select your buttonhole from the Buttonhole Menu B.

Fabric: Woven medium and stabilizer

Touch: Woven medium on Sewing Advisor fabric screen. Buttonhole on technique screen.

Snap on: Sensor Buttonhole Foot as indicated on the Color Touch Screen by the red wheel next to the foot. Plug the cord into the socket in the left front underside corner of the machine. Line up the white range on the side of the wheel with the white marking line on the foot.

Use: Size 80 needle as recommended.

Enter the buttonhole size with the **+** or **-** button. Average buttonhole sizes are: 5/8" = 16mm, 3/4" = 20mm, 1" = 25mm. Maximum size: 2" = 50mm.

Many button packages list the size of the button. Otherwise use the Buttonhole Ruler which is positioned on the baseplate on your Designer I. The buttonhole size needed will vary with the thickness and style of your button. Always stitch a sample buttonhole on scraps first.

Sew:

- Fold fabric in two and place stabilizer underneath.
- Place under Sensor Buttonhole Foot. The measurement wheel can be raised to a stop, which makes it easier to place the fabric under the presser foot.
- If you need to adjust fabric, touch Pivot .

Use the markings on the left toe of the Sensor Buttonhole Foot to position the garment edge. The middle mark gives a 5/8" (15 mm) distance to fabric edge.

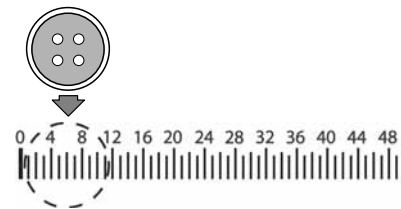
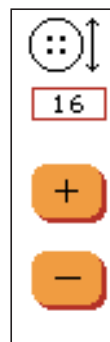
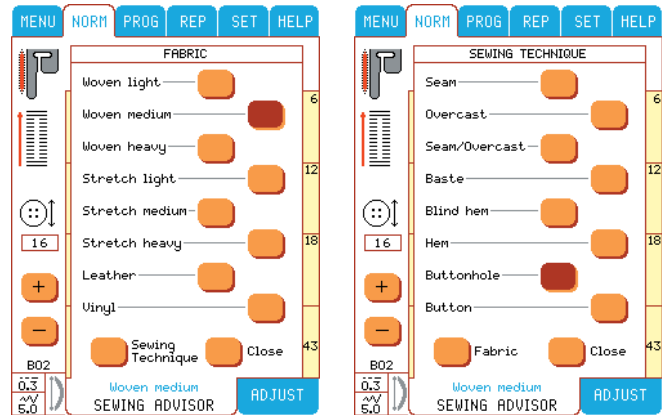

Buttonhole Ruler

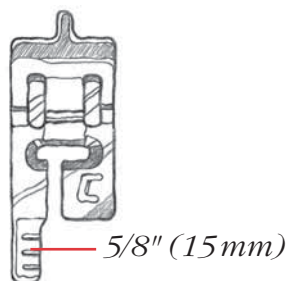

- Step on the foot control, the Sensor Buttonhole Foot lowers automatically. A straight stitch is sewn away from you indicating the left button-hole column, then the satin column is sewn toward you. This is repeated for the right column. The bartacks are automatic (Illustration 1). Keep the foot control depressed until the Thread Cutter cuts the threads and the Sensor Button-hole Foot is raised. When sewing buttonholes without satin stitches or when using presser foot C, the sewing steps are different (there is no straight stitch step). See Illustration 2.

Note: If you are sewing buttonholes on a very narrow area, snap on the standard foot C and follow the step by step buttonhole instructions on page 52.

Button

Sew buttons, snaps, hook and eyes quickly with your Designer I.

Fabric: Woven medium

Touch: Woven medium on the Sewing Advisor fabric screen. Button on the technique screen.

Use: Size 80 needle and the clearance plate as recommended. Snap off presser foot. Lower the feed teeth as recommended by the Pop-up.

Sew:

- Place the thin end of the clearance plate under button when sewing on light fabrics. Hold in place with transparent tape. Use the thick end for heavier fabrics.
 - Place under ankle with the holes in the button lined up with the swing of the needle. Touch Pivot (⊕). Check the swing by turning the hand wheel by hand to be sure the needle will not hit the button.
- Bring the needle down into the hole of the button.
- Zigzag button in place with 6 to 8 stitches.
 - Touch (⊖) to tie off. Touch (⊕) to repeat next button.
 - Raise feed teeth.

Note: The width of the zigzag is set for most buttons. If you sew a tiny button or a very large coat button, touch ADJUST and (+) or (-) the stitch width until the swing of the needle sews in the holes of the button or snap.

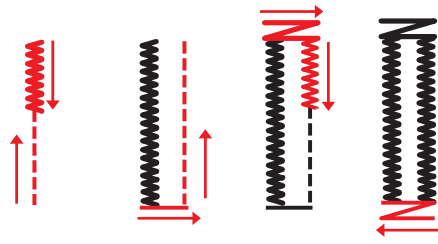

1. Sewing direction for satin stitch buttonholes sewn with the Sensor Buttonhole Foot

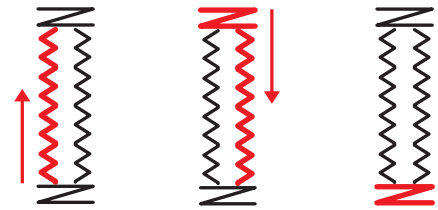

2. Sewing direction for buttonholes without satin stitches or satin stitch buttonholes sewn with presser foot C

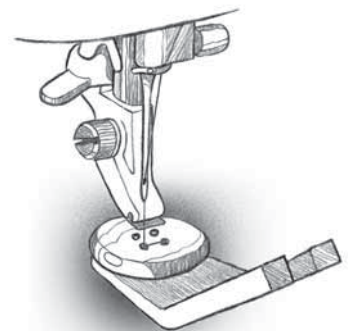
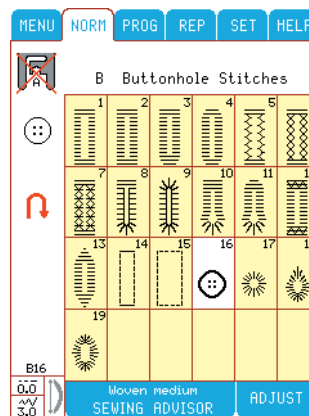
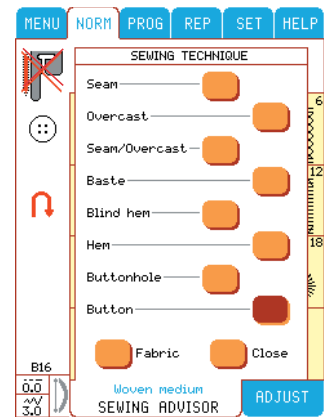
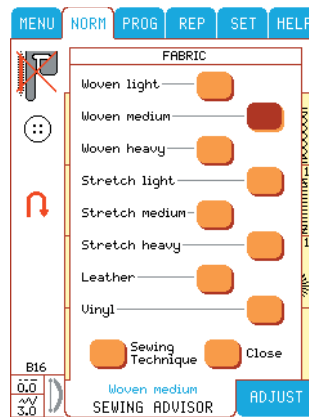

Menu B

Buttonhole

On your Designer I, select from 15 different buttonhole styles. There is one for every type of fabric and garment. Because the Sensor Buttonhole Foot measures as it sews, every buttonhole will be the same size. The buttonhole styles on your Designer I are listed below:

B1 Bartack Buttonhole for medium and heavy fabrics with extra cutting space.

B2 Bartack Buttonhole for most fabric weights.

B3 Round End Buttonhole for light weight fabrics.

B4 Round End Buttonhole for blouses and children's garments.

B5 Heavy Reinforced Buttonhole for utility and heavy fabrics.

B6 Medium Reinforced Buttonhole for medium wool and Tyrolean jackets.

B7 Medium Reinforced Decorative Buttonhole for medium wool.

B8, B9 Heirloom Buttonhole for "hand look" on fine and delicate fabrics.

B10 Keyhole Buttonhole with square end for tailored jackets, coats, etc.

B11 Keyhole Buttonhole with tapered end for tailored garments.

B12 Heavy Duty buttonhole with reinforced bartacks.

B13 Decorative Fashion Buttonhole for most fabric weights.

B14 Straight Stitch Buttonhole for leather and suede.

B15 Straight Stitch Buttonhole with extra cutting space for bound buttonholes.

B16 For sewing buttons

B17 Round eyelet for belts, laces, etc.

B18 Teardrop eyelet for laces, embellishments.

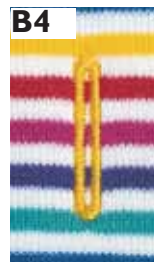
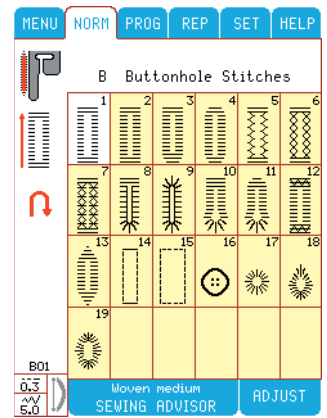
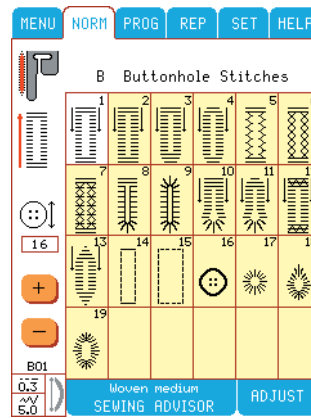

B19 Oval eyelet for laces, embellishments.



Corded Buttonhole (Stretch fabrics)

- Loop a piece of heavy thread or perle cotton over the finger at the back of the Sensor Buttonhole Foot or the C presser foot
- Stitch a buttonhole. Do not hold back the cord. The satin buttonhole columns will stitch over the cord.
- Stop sewing before the last end of the buttonhole is sewn and lift the cord off the finger and pull out the slack.
- Cross the cord in front of the needle and stitch the end of the buttonhole over the cord.
- Thread cord ends into a large needle, pull to the wrong side and knot ends before cutting excess.



Step by step buttonhole

- Select buttonhole. and snap on Presser Foot C
- Begin sewing buttonhole, the machine will sew the left column in reverse. The buttonhole foot has guide lines to determine the buttonhole length. Use the markings on the left toe of the Buttonhole Foot to position the garment edge. When the buttonhole is the desired length, touch . The machine will bar tack the end and stitch the right side.
- Touch  to bar tack and tie off. Keep the foot control depressed until the machine ties off and stops sewing. The Thread Cutter cuts the threads automatically when the buttonhole is completed.

Buttonhole balance

To balance the stitch density of the right buttonhole column to the left, when a buttonhole is selected, touch . The balance icon is now a buttonhole.

Note: Only the right side stitch column will be adjusted. Balance it to match the left stitch column.

 will make the stitches in the right column closer together (more dense).  will make the stitches further apart (less dense).

The setting will be retained until the Designer I is turned off.

To change the stitch density of both columns, see Buttonhole Density.

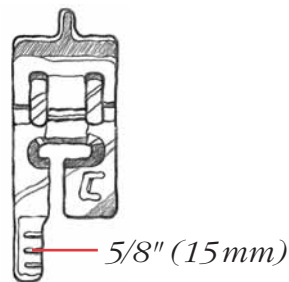
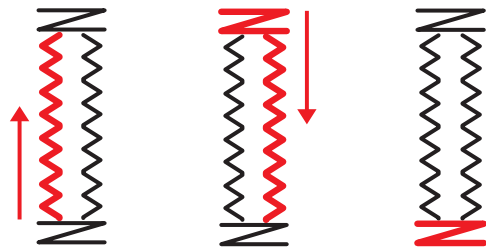
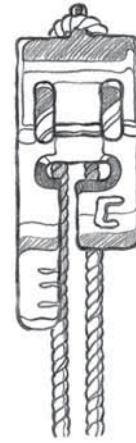

Buttonhole Density

To adjust the density of the buttonhole, touch **ADJUST**. Increase stitch length **+** to make stitch columns less dense. Decrease stitch length **-** to make stitch columns more dense. Both columns will be adjusted.

Cutting Buttonholes

Cut buttonhole open with the seam ripper.

Tip: Place a straight pin across the end you are cutting toward to avoid cutting too far!

Bound buttonhole

For all types of fabrics.

Fabric: 1 piece Chino and Broadcloth. Cut a patch of broadcloth 2"x 3" (50mm x 80mm) for the buttonhole.

Touch: Woven medium on Sewing Advisor. Buttonhole Menu B, Buttonhole B15.

Snap on: Presser foot A as recommended.

Use: Size 80 needle as recommended.

Sew:

Place Broadcloth piece and Chino fabric right sides together.

1. Stitch Buttonhole B11.
2. Cut the buttonhole down the center to 1/4" (6mm) from each end. Cut to the corners at each end to form a triangle as illustrated.
3. Press the end triangles away from the buttonhole.
4. Pull the broadcloth through the buttonhole opening to the wrong side. Fold the broadcloth so the edges of the buttonhole are formed and meet at the center of the buttonhole opening, forming a pleat at each end on the wrong side.
5. From the right side fold back the end of the buttonhole to expose a triangle.
6. Touch straight stitch A2. Touch **ADJUST**, stitch length 1.5 and stitch across the base of the triangle catching the pleat of the rectangle to secure it.
7. Topstitch the buttonhole from the right side "in the ditch".

The wrong side of a bound buttonhole is finished when the garment facing or lining is slit and hand stitched to the wrong side of the opening.

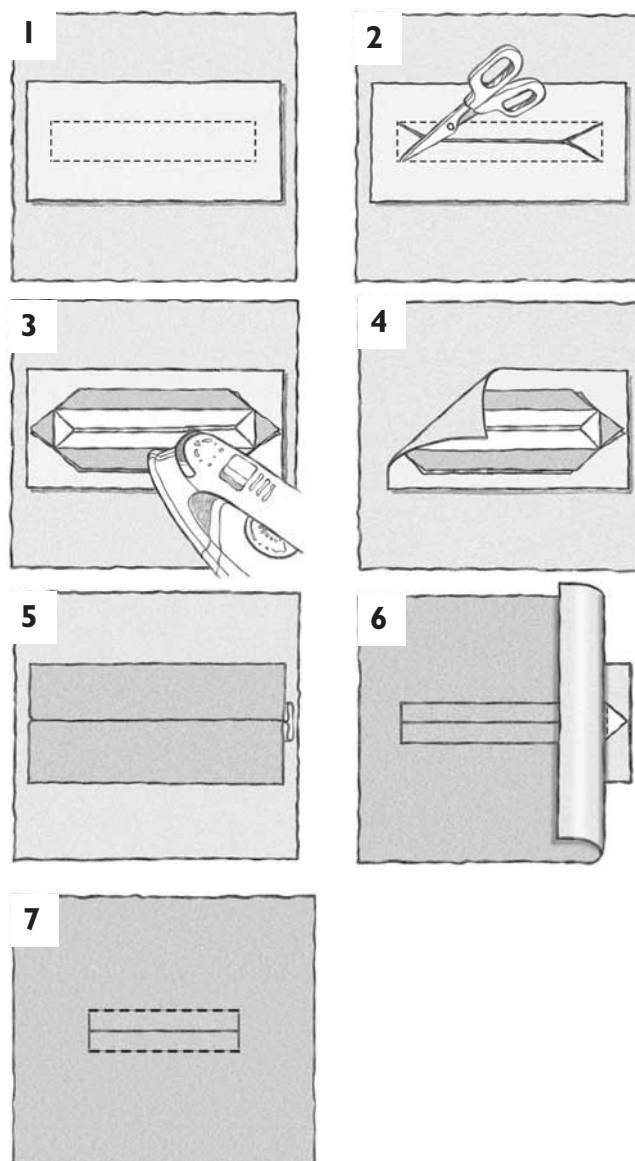

Menu A

Utility Stitches

Menu A includes the stitches selected by the Sewing Advisor and a row of additional stitches which are described below. Touch the picture of the stitch to select it.

You can, if needed, make adjustments in stitch length and width in the ADJUST Menu and adjustments in thread tension and presser foot pressure in the SET Menu.

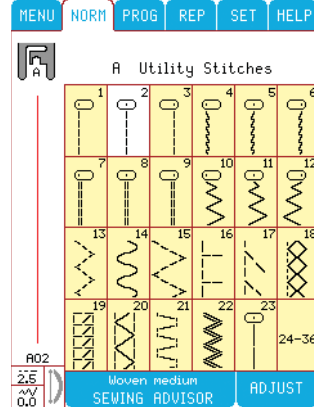

Straight Stitch

Touch: Woven medium in the Sewing Advisor, and Menu A – Utility Stitches on the Main Menu.

Select: Straight Stitch, A2.

Your Designer I will automatically make the standard settings. The Color Touch Screen will show you all information you need to get the best result.

Lightning Stitch (Stretch Stitch)

Touch: Stretch light in the Sewing Advisor and Menu A – Utility Stitches on the Main Menu. **Se-**

lect: Stretch Stitch A5. Your Designer I will automatically make the standard settings. The Color Touch Screen will show you all information you need to get the best result.

Gathering

A basting stitch is also used for gathering.

- Touch **ADJUST** to select stitch length of 3.5 to 6.0 for gathering. Use shorter stitch length for lighter weight fabrics.
- Place a single thickness of fabric under presser foot and stitch.
- Stitch a second row next to the first.
- Pull both bobbin threads to gather fabric. Be careful not to pull them out.

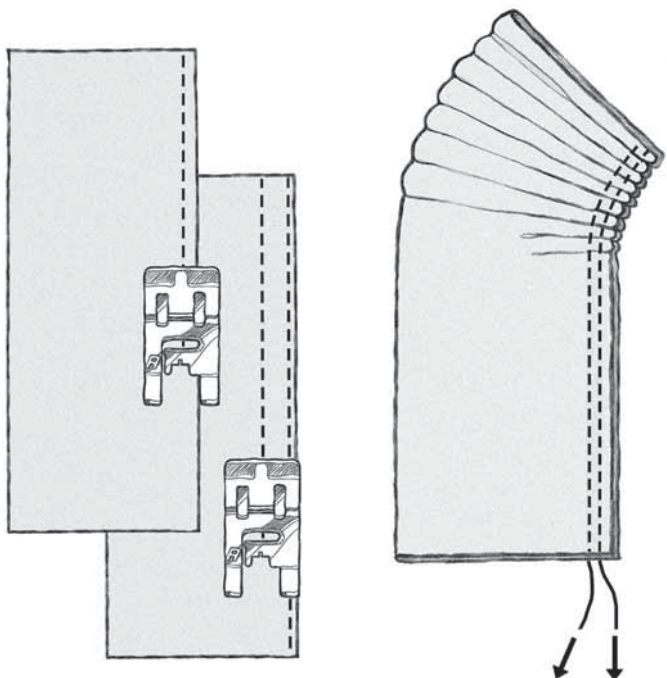
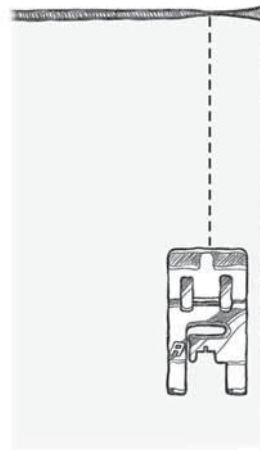

Twenty-five Needle positions



Your Designer I has twenty-five different needle positions for the most accurate seaming and topstitching ever. When sewing straight stitch or reinforced straight stitch, the needle positions can be adjusted in steps. To edge stitch, you should take advantage of the different needle positions.

Fabric: Woven medium

Touch: Woven medium on the Sewing Advisor, and Stitch A2 on the Utility Menu A.

Use: Presser foot A and size 80 needle as recommended.

Sew:

- Fold fabric in two and put it in position under the presser foot.
- If you need to adjust fabric, touch Pivot . Step on foot control. The Sensor Foot lowers automatically. Stitch with center needle position.
- Touch . Touch stitch width  to move needle 12 steps to 6 left needle position = Stitch A1.

Touch  to move needle 12 steps to 6 right needle position = Stitch A3.

Touch stitch width  to move needle back to center position.

1. To sew about 1/4" (6mm) from the edge, use presser foot A and set the needle to 6 right position. To get the maximum feeding when edge stitching close to the edge, place the edge of the fabric so that it follows the outside right edge of the presser foot and sew.
2. To get the maximum feeding when edge stitching close to the edge, place the fabric and sew with left needle position so that the edge follows the inside right edge of the presser foot D, or the first mark of the left edge of the presser foot A.

Use presser foot A when sewing light fabrics and presser foot D for other fabrics.

Tip: Snap on the optional Edge Stitching Foot or Edge Joining Foot for topstitching with different needle positions.

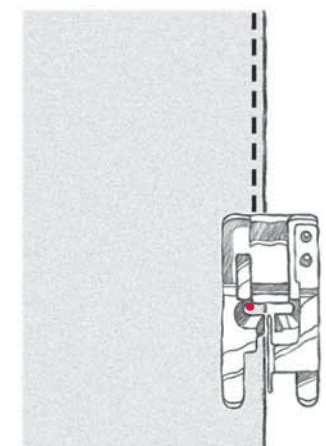
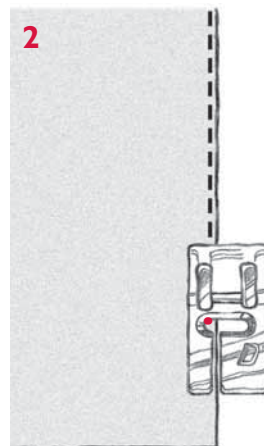
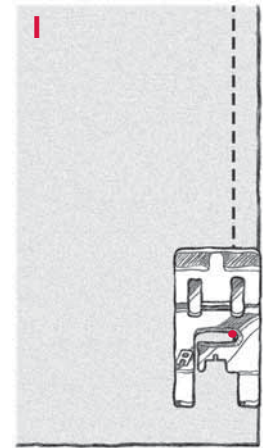
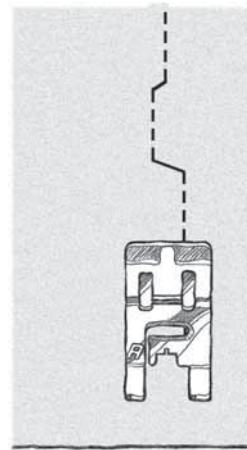
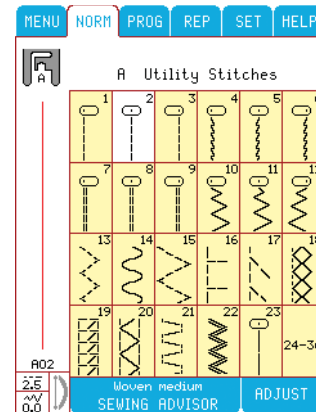

Center zipper

Fabric: Woven medium

Touch: Woven medium on the Sewing Advisor

Use: Size 80 needle.

Touch: Seam on the Sewing Advisor and sew the two fabrics together along the 5/8" (15mm) seam line up to the notch at the zipper placement.

Touch: Baste on the Sewing Advisor and baste the zipper area of the seam together. Press the seam open. Place the zipper right side to the pressed open seam allowance. Close the Sewing Advisor.

Touch: Menu V. To bar tack baste zipper in place, touch Zigzag stitch V2. Lower the feed teeth by turning the dial to **—**. Move the fabric to stitch a series of bar tacks over the zipper to hold it in place. Turn the feed teeth dial to sewing position **▲▲▲**.

Touch: Menu A, A1 for left needle position straight stitch.

Snap on: Zipper foot E. Snap it on so the needle is on the left side of the foot. There are two bars on the foot so you can snap on the foot to the right or left of the needle. Place fabric under the foot right side up with the zipper foot to on the right side of the zipper.

If you need to adjust fabric, touch Pivot .

Sew:

- Step on the foot control. The Sensor Foot lowers automatically.
- Begin stitching across the bottom, turn and stitch the right side of the zipper to the top.
- To avoid fabric shifting, sew the left side of the zipper in the same direction, touch A3 for right needle position straight stitch. Snap on zipper foot E so the needle is on the right side of the foot.
- Begin stitching across the bottom, turn and stitch the left side of the zipper sewing from the bottom to the top.
- Remove bartacks and basting stitch.

Note: To adjust the position of the stitching line, adjust the needle position. Touch **ADJUST**, Touch stitch width  to move the needle towards the center position.

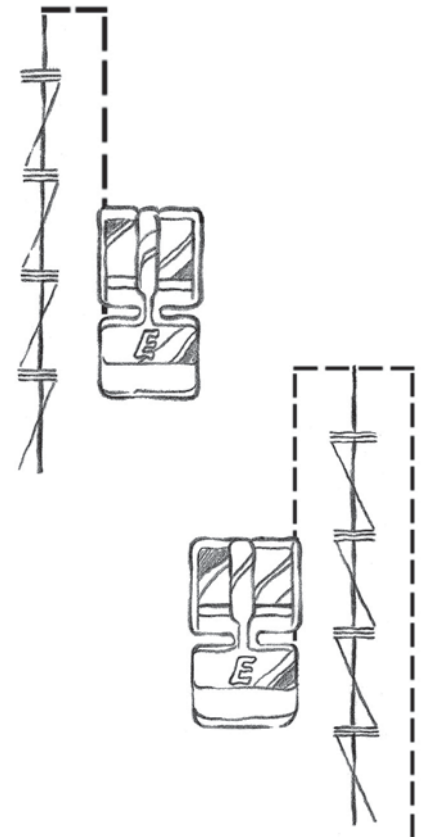
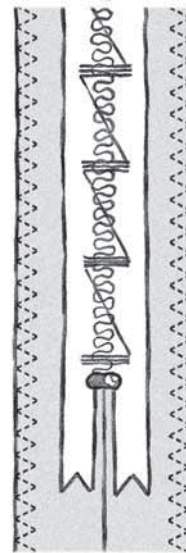
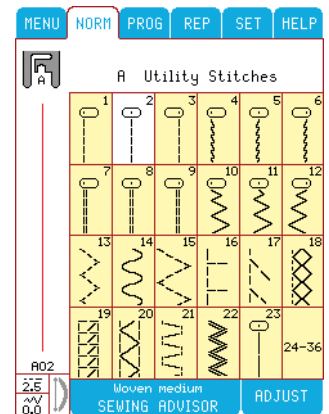
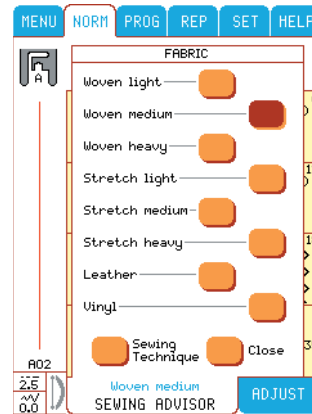

Reinforced Straight Stitch

The Reinforced Straight Stitch is stronger than ordinary straight stitch, due to the fact that it is a triple and elastic stitch. The Reinforced Straight Stitch can be used for for all heavy fabrics, for crotch seams that are subject to considerable strain and for topstitching on heavy fabrics.

Repair garment seams in stress areas with this stitch.

Fabric: Woven heavy



Touch: Woven heavy on the fabric screen on the Sewing Advisor and Stitch A8 on the Utility Stitch Menu.

Snap on: Presser foot B as recommended.

Use: Size 80 needle as recommended. Put the fabric in position under the presser foot.

If you need to adjust fabric, touch Pivot .

Sew:

- Step on foot control. The Sensor Foot lowers automatically.
- Stitch 5/8" (15mm) from the bias fold edge.
- Touch A7. Touch  and increase stitch length to 4.5. You may use presser foot D and sew a row of topstitching along the edge of the fold.
- Touch .

Note: Increase the stitch length on the Reinforced Straight Stitch for impressive topstitching.

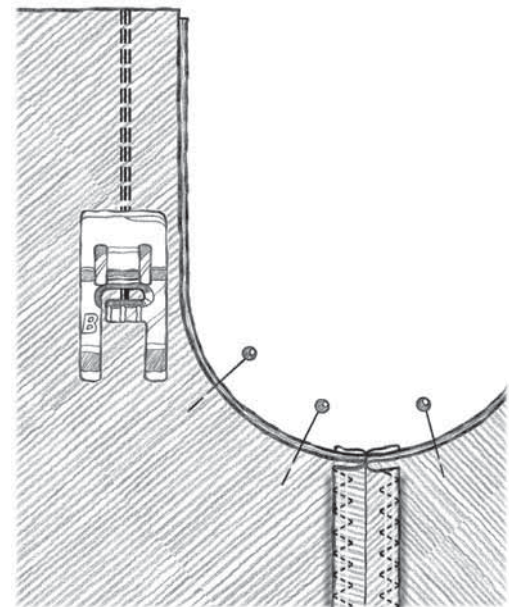
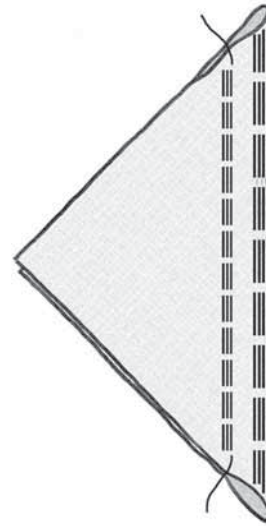
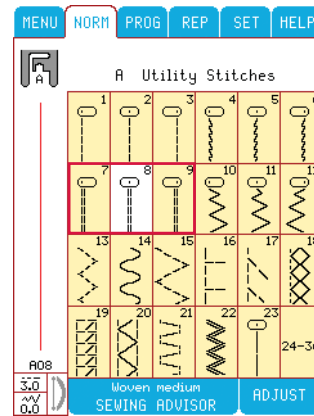

Multiple ZigZag Stitches

The multiple zigzag stitches on the Utility Menu A look like a zigzag stitch with straight stitches in the “zig” and the “zag” of the stitch. Stitch A13 – three-step zigzag – is up to 1/4" (6 mm) wide and suitable for light and medium fabrics. Stitch A15 is a 7/16" (9 mm) wide multiple zigzag, used for loosely woven and heavy fabrics. Use these stitches for overcasting, butting two edges together to join them, mending tears and other special finishing.

Stitch A14 is a serpentine stitch used for mending and darning stretch fabrics.

Touch: Woven-Medium in the Sewing Advisor and Menu A – Utility Stitches on the Main Menu.

Select: Three-step zigzag stitch A13. Your Designer I will automatically make the standard settings. The Color Touch Screen will show you all information you need to get the best result.

Snap on: Presser foot J or A as recommended.

Use: Size 80 needle as recommended.

Put the fabric in position under the presser foot.

If you need to adjust fabric, touch Pivot .

Sew:

- Step on foot control. The Sensor Foot lowers automatically.
- Sew to overcast the edge of fabric.
- Touch .

Stitch A15 is used for loosely woven and heavy fabrics.

Stitch A14 – the serpentine stitch – used to sew an overlapped seam and for mending and darning stretch fabrics.

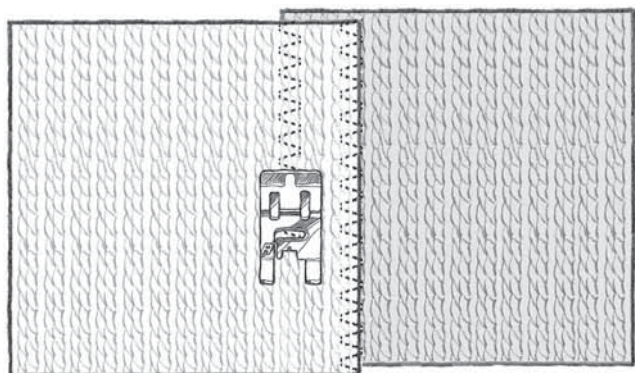
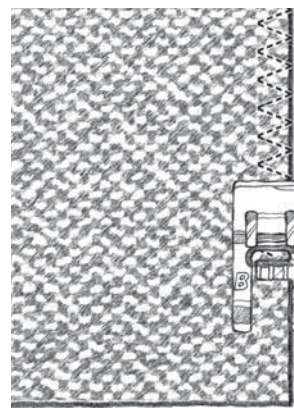
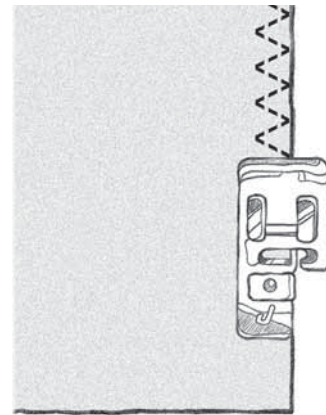
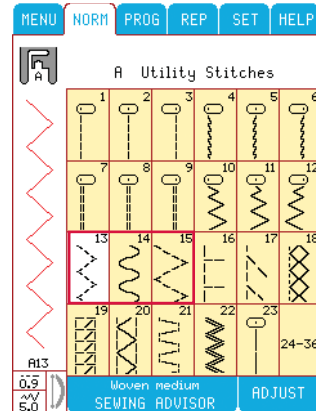

Darning and Mending

Stitches A33-35

Darning a small hole or a tear before it becomes larger can save a garment. Choose the finest thread in the closest color match possible.





Fabric: Woven heavy

Touch: Woven heavy on the Sewing Advisor. Poke a small hole to darn. Touch Menu A, Utility Stitches, Touch Darning Stitch A33.

Snap on: Presser foot A as recommended.

Use: Size 80 needle as recommended.

Sew:

- Place fabric in position under the presser foot.
- Touch Pivot  and adjust fabric if necessary. Step on the foot control, The Sensor foot lowers automatically.
- Begin sewing above the hole and sew down over it.
- Once over the hole, touch . Continue sewing. The machine will sew back and forth across the hole 12 times to darn the hole closed.
- Touch . The stitch will now repeat in succession and the machine will stop automatically when the stitch is completed.
- Touch .

Patching and tears

Stitch 34 will efficiently mend a tear.

- Touch Stitch 34, which is a mending stitch. Stitch over the tear to mend it. Begin at the top of the tear and sew to the edge of the fabric.

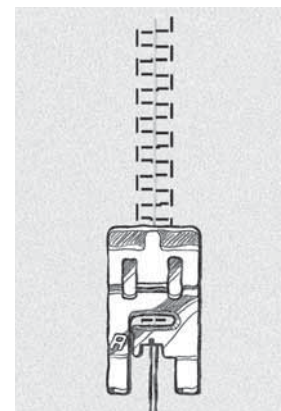
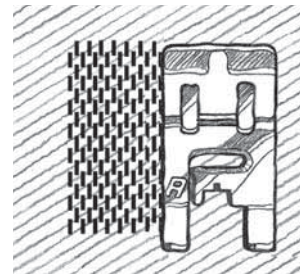
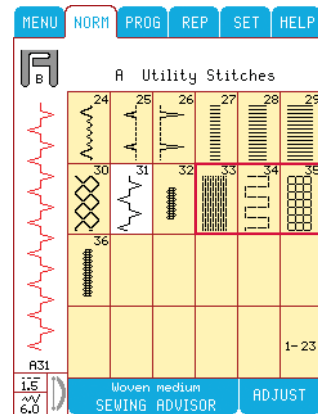

Bartacks

Secure elastic ends, drapery pleats, belt loops, and pocket corners with the same look as ready-to-wear.



Fabric: Woven heavy

Touch: Woven heavy, Menu A, Utility Stitches, Touch Stitch A32 / A36.





Snap on: Presser Foot B as recommended.

Use: Size 80 needle as recommended

Sew, A32:

- Place fabric in position under presser foot
- Touch Pivot  and adjust fabric if necessary. Step on the foot control, the Sensor Foot lowers automatically, and stitch.
- Touch . The machine will stop automatically when the stitch is completed. The machine will automatically tie-off and cut the threads.

Sew, A36:

- Place fabric in position under presser foot
- Touch Pivot  and adjust fabric if necessary. Step on the foot control, the Sensor Foot lowers automatically, and stitch. The machine will sew a straight stitch until you touch . Your Designer I will then sew in reverse until you touch  again. Your Designer I will then sew a zig zag, covering the straight stitches until you touch .
- The machine will automatically tie-off and cut the threads.

Belt Loops

Touch: Woven heavy, Menu A, Utility Stitches, Touch Stitch A13 Three-step zigzag.

Snap on: Presser Foot B as recommended.

Use: Size 80 needle as recommended. Lower the feed teeth .

Sew:

- Fold in about 3/8" (10mm) on the short ends.
- Place the belt loop on the garment and under the presser foot.
- Touch Pivot  and adjust fabric if necessary.
- Sew a bartack from the outer edge to the center of the loop, move the fabric and sew a new bartack.

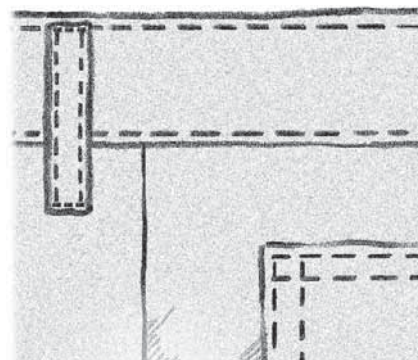
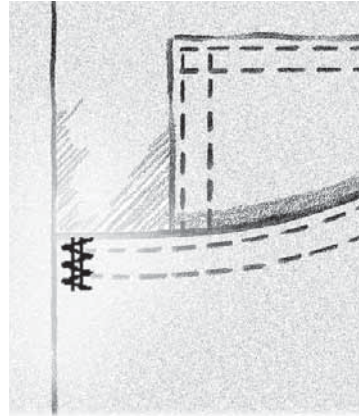

Stitch table – Menu A

1-3 Straight stitch

For all kinds of sewing in woven fabrics, 25 different needle positions.

4-6 Stretch stitch

For seams in tricot and stretch fabrics.

7-9 Reinforced straight stitch

For seams which are subject to considerable strain. Use to reinforce and topstitch sportswear and working clothes. 25 needle positions.

10-12 Zigzag

For lace edging and sewing on bands.

13 Three-step zigzag

For overcasting, mending, sewing on patches and elastics.

14 Serpentine stitch

For mending and darning and elastic applications.

15 Four-step zigzag, 9 mm

For overcasting, mending, sewing on patches and elastics in loosely woven fabrics.

16 Overcast stitch

Seam and overcast in one step along the edge or trim later. For light stretch and non-stretch fabrics.

17 Overlock

Seam and overcast in one step along the edge or trim later. For medium and medium/heavy stretch fabrics.

18 Double overlock

Seam and overcast in one step along the edge or trim later. For heavy stretch fabrics.

19 Overlock stitch

Seam and overcast in one step along the edge or trim later. For medium stretch fabrics.

20 Flatlock

Decorative hems and overlapped seams, belts and bands. For medium/heavy stretch fabrics.

21 Elastic/Casing stitch

For overlapped seams in tricot. To sew casing over narrow elastic.

22 Reinforced zigzag

For joining fabric edge to edge or overlapping in leather.

23 Baste stitch

For joining two pieces of fabric with long a stitch length and reduced thread tension.

24 Elastic blind hem

Invisible hems in stretch medium and heavy fabrics.

25 Woven blind hem

Invisible hems in woven fabrics.

26 Shell rolled hem

For edgings. Sew over the edge. For light stretch fabric. Sew woven fabric on bias.

27-29 Satin stitch

For appliqués, rounded edge, sewing on laces and bands.

30 Elastic stitch

Sew over two rows of elastic thread for shirring.

31 Bridging stitch

For joining two pieces of fabric with finished edges and for elastic shirring.

32, 36 Bartack

Reinforce pockets, shirts openings, belt loops as well as at lower end of a zipper.

33-35 Darning stitches

Darn and mend work clothes, jeans, tablecloths and linen towels.

Menu S

4-Way Stitches

The four way mending stitch allows you to stitch several sturdy stitches in four different directions. You have a choice of 15 different 4-way stitches. You can select the one that is perfect for the weight and type of fabric. This is especially helpful when patching pant legs on the free arm. The 4-Way stitches are programmed at a fixed length and width.







Fabric: Woven heavy, two pieces, one a patch

Touch: Woven heavy on your Sewing Advisor, Menu S - 4-way stitches, Stitch S8.

Snap on: Presser foot S as recommended.

Use: Size 80 needle as recommended.

Sew:

- Place the patch on the larger fabric in position under the presser foot.
- The machine begins to sew across the top of the patch from the top left corner. A stitch will appear on the Color Touch Screen to indicate sewing direction.
- Touch Pivot  and adjust fabric if necessary. Step on the foot control. The Sensor Foot lowers automatically.
- Sew across the top and touch the 4-way symbol  or  to change sewing direction. The direction of the stitch on the screen will change.
- Sew down the side of the patch. Continue sewing around the patch, touching  or  to change sewing direction.
- Touch .

Note: Depending on which stitch you are using, the corners may be irregular if changing sewing direction without completing the stitch first. To sew beautiful corners with 4-way stitches, press  before changing sewing direction. This will complete the current stitch before changing direction. Another alternative is to change the sewing direction without stopping the sewing machine.

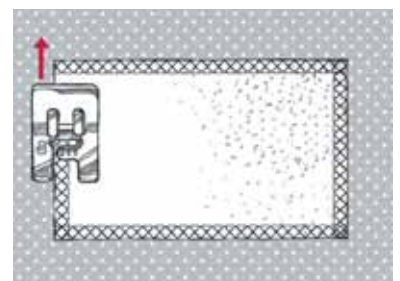
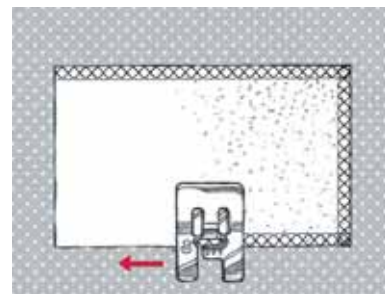
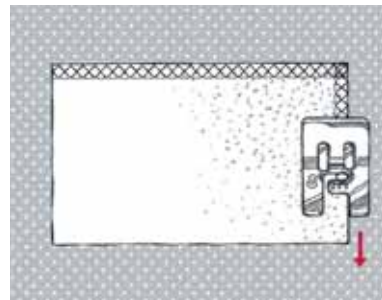
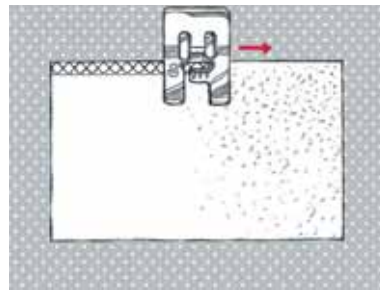
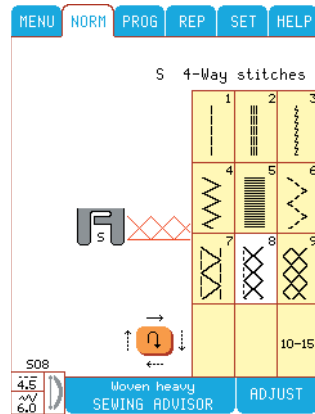

Embroidery



Embroidery

Creative Embroidery from Husqvarna Viking

Down through the ages, people all over the world have enjoyed stitching embroidery designs to personalize and embellish clothing, table linens and special heirlooms. Early embroideries were stitched by hand. Today your Husqvarna Viking Designer I embroiders your design effortlessly.

Embroidery unit

1. Embroidery unit socket
2. Embroidery arm
3. Embroidery hoop attachment
4. Embroidery unit release button

Embroidery Unit Carrying Case

The carrying case contains embroidery unit, 2 embroidery hoops; standard and large, embroidery Presser foot R, embroidery booklet, 2 embroidery templates; standard and large, a template pencil, Sampler 100 embroidery disks: 1 disk of designs and 3 font disks, a pair of scissors, two thread nets, 1 felt holder and a test kit. Store your embroidery accessories in the carrying case to prevent misplacing them.

Connecting the Embroidery unit

1. Slide off the accessory tray.
2. There is a covered socket at the back of the machine. Turn the cover to the right to open it. The embroidery unit plugs into this socket.
3. Slide the embroidery unit on the free arm of the machine until it plugs firmly into the socket. Switch on the machine.
4. A Pop-up menu tells you to clear the area and remove the hoop for calibration. Touch . The machine will calibrate and the embroidery arm will move to the ready position. Calibration will set your embroidery functions each time you slide on the embroidery unit.
5. The feed teeth are lowered automatically when the embroidery unit is connected and are raised when it is removed.

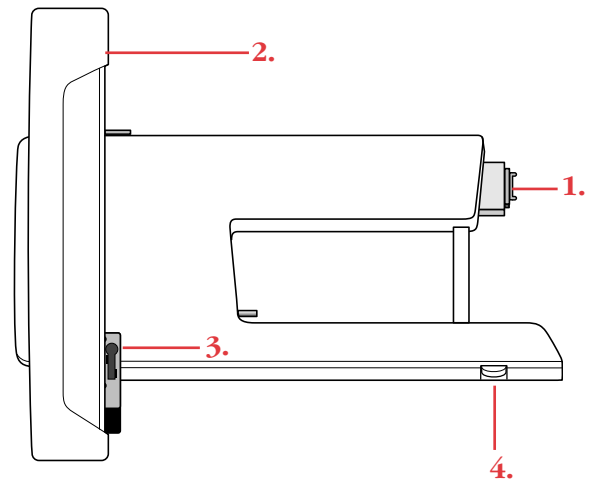

Presser foot R

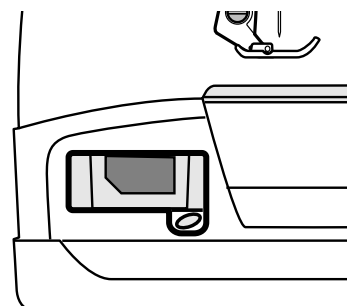
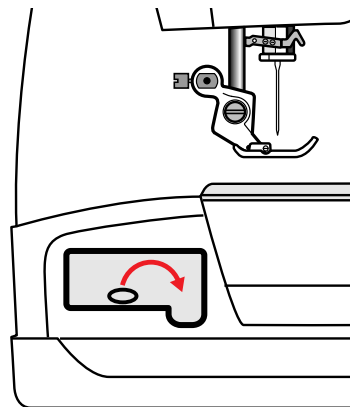
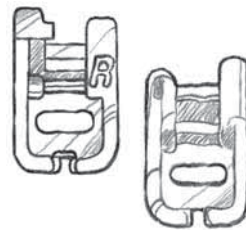

Built-in Disk Drive

Insert: Slide the embroidery disk into the built-in disk drive on the side of the machine.

Eject: Push the button on the side of the machine to eject the disk.

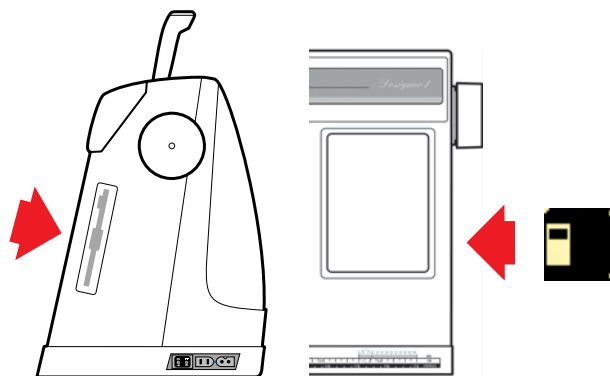

Removing the Embroidery unit

1. To put the embroidery arm in the rest position to store it in the embroidery case, touch  (the needle up/down function button). The embroidery arm will move to the rest position. Switch off the machine.
2. To release the unit, raise the large button at the right front of the unit and slide the unit to the left.
3. Close the cover on the socket.

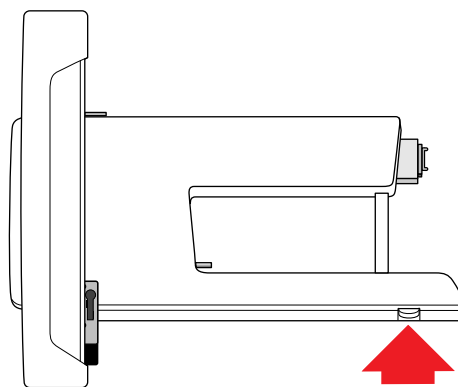

Threading the machine

See page 8.

Embroidery booklet

Page through the Embroidery Booklet for Sampler 100 designs and fonts. All embroidery designs are pictured actual size. The center point and placement markings on all sides are marked for easy placement in the hoop.

The menu number (in black), design number (in red), and stitch count (number of stitches in the design) are next to each design.

The thread spools show the suggested thread colors for each color number and give the thread color number for 40 weight Rayon embroidery thread.

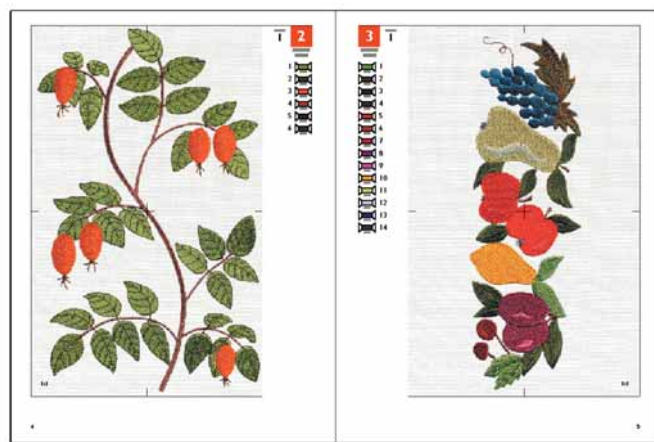

Hoop the fabric

1. Select Large Hoop 150x240 mm (6x9,6"), Standard Hoop 100x100 mm (4x4") or Mega Hoop 360x150 mm (14,4x6") depending on the size of your design. Always use the size that is shown on the embroidery screen menu.
2. Loosen the screw on the larger outer hoop. Place the hoop on a firm flat surface with the screw on the lower right. There is a small arrow in the center of the lower edge of the hoop which will line up with a small arrow on the inner hoop.
3. Place the stabilizer and the fabric on top of the outer hoop and place the inner hoop on top of the fabric with the small arrow at the bottom edge.
4. Push firmly on the inner hoop to push it into the outer hoop. Hint: Be sure to loosen the hoop screw enough for the fabric and stabilizer thickness, so you can push the inner hoop in place. Push in on the sides of the large hoop.
5. Tighten the hoop screw. The fabric should be very taut in the hoop for the best results.

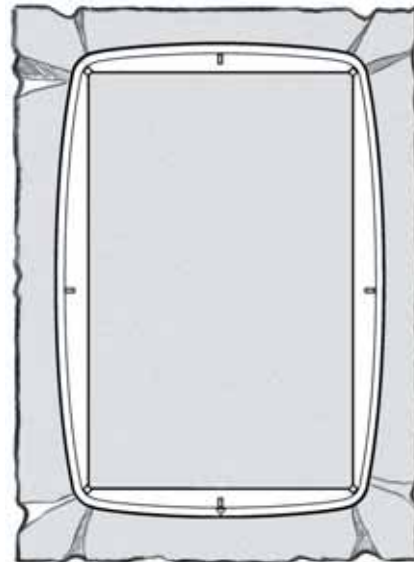
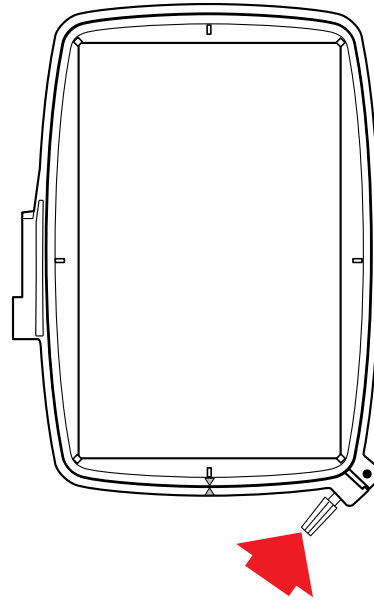

Embroidery Template

Because the embroidery designs are pictured actual size in the Embroidery Booklet it is easy to place the embroidery on your garment or project. Use the embroidery template size that corresponds with hoop size.

1. Place the template over the picture of the selected design in the Embroidery Booklet.
2. Use the template pencil to trace the outline of the design onto the template.
3. Place the template on the project to be embroidered and mark the center point, side, and top and bottom markings through the holes in the template. Use the Pictogram Pen.
4. Open the screw on the outer hoop. Place it on a firm surface. Put the stabilizer and the project to be embroidered on top of the outer hoop and set the inner hoop on top matching the side, top and bottom markings on the hoops with the Pictogram Pen markings on the project. Take the time to be sure the marks are all aligned.
5. Push the inner hoop into the outer hoop and tighten the screw.

Slide the hoop onto the machine.

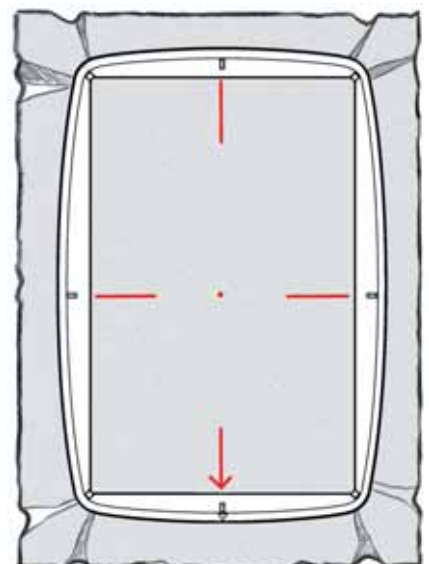
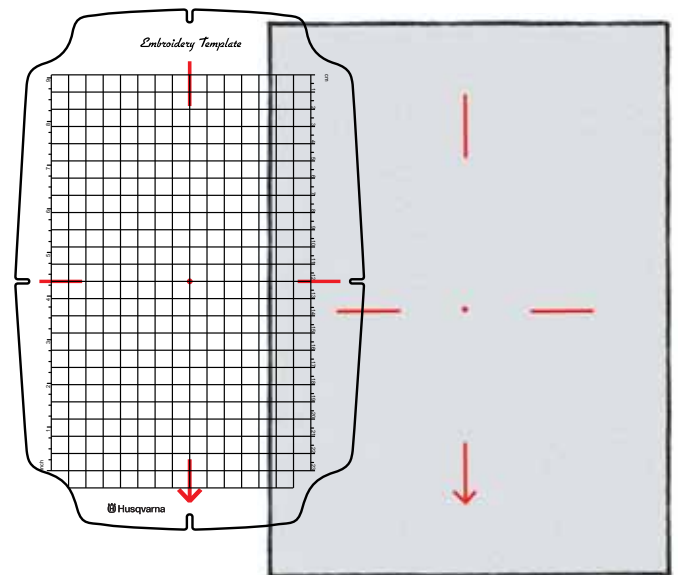
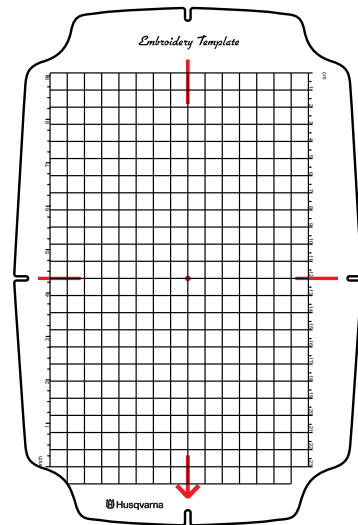

The marked center point should match the starting point of the needle. If minor adjustment is needed, touch the positioning buttons on the embroidery screen submenu.

Note: Read more about Stabilizer and Hoops in the Accessory User's Guide.





Getting Started

- Slide on the Embroidery Unit.
- Turn on Designer I.
- Calibrate the unit by pressing **OK** on the pop-up menu.
- Slide Sampler Disk 100--disk 1(4) (embroidery designs) into the Built-in Disk Drive on the right side of the machine.
- Touch . An hourglass appears on the screen as the design menus are brought up on the screen.
- Touch . An hourglass appears as the designs are brought up on the screen.
- Touch design . An hourglass appears as the design comes up on the screen.

Select a different embroidery at any time.

Touch **MENU** to return to the design choices.

Touch **HELP**. A Pop-up appears with recommendations about needle size and type, stabilizer, 40 weight embroidery top thread, 70 weight bobbin thread, presser foot R and an icon to bring up a color menu.

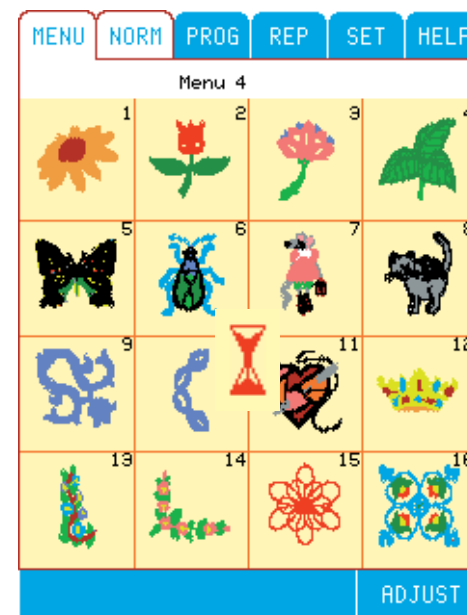
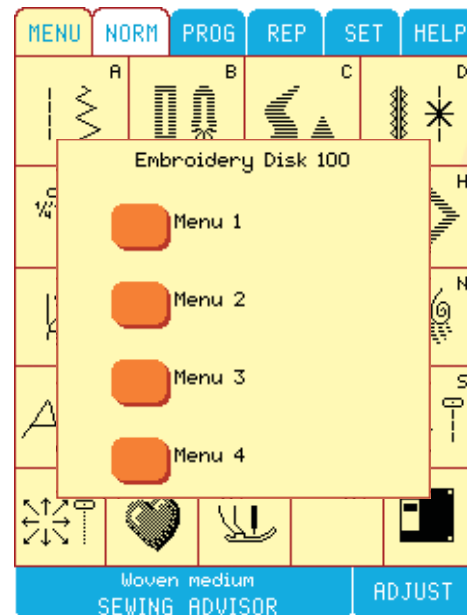
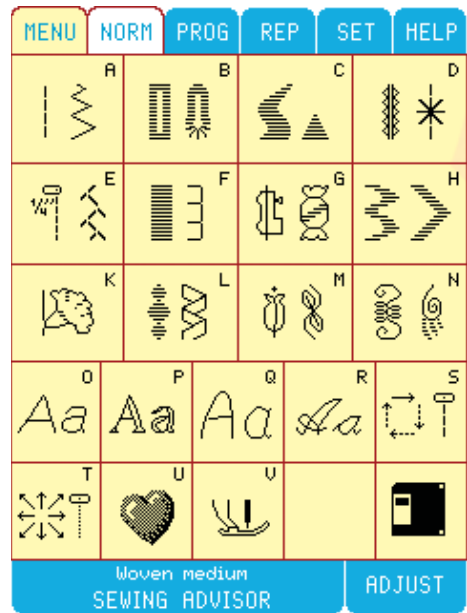
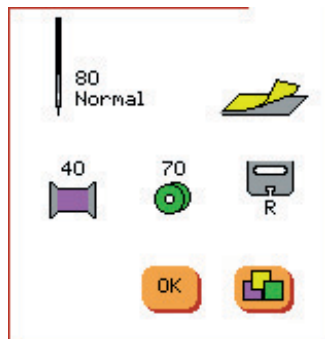

Embroidery Screen Menus

The embroidery screen menus give information and options for the design you have selected.

Embroidery name/number D100 4 04
D100 is the disk, 4 is the menu number, 04 is the design number.

Total number of stitches

--- 5889

Embroidery size ↔ 67mm † 70mm

Hoop-size  100x100

Use the standard hoop as recommended.

You can select a different hoop size from the orange buttons. The grey buttons are not available because the design would be too large for the hoop. Select the size of the hoop before sliding the hoop onto the embroidery arm. Be sure to use the selected hoop size as displayed on the screen. A sensor in the embroidery arm checks the size of the hoop so you will never make a mistake. The 40x40 “Mini Hoop” and 170x100 “MidSize Hoop” are optional accessories.

Stitch count 

The stitch count will return to 1 with each color change and count the stitches for that color.

To Step forward or backward stitch by stitch.
Touch  to step backward a few stitches if top thread has run out or broken.

Touch  to step forward stitch by stitch.

Note: If the  or  button is kept depressed, the speed accelerates.

Thread color recommendation 

To Step forward or backward color by color.
Touch  or .

Touch  to bring up the embroidery screen submenu. The embroidery screen submenu also displays the embroidery name/number, stitch count, embroidery size, and hoop size.

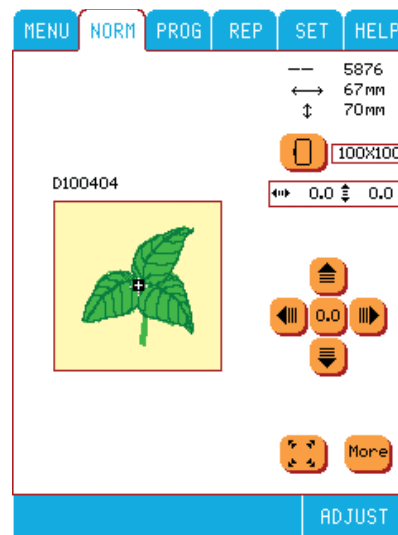
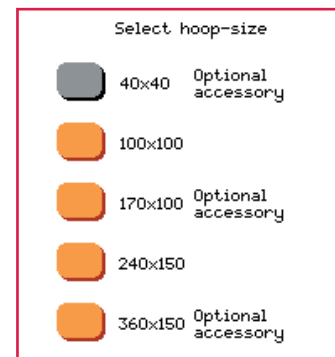
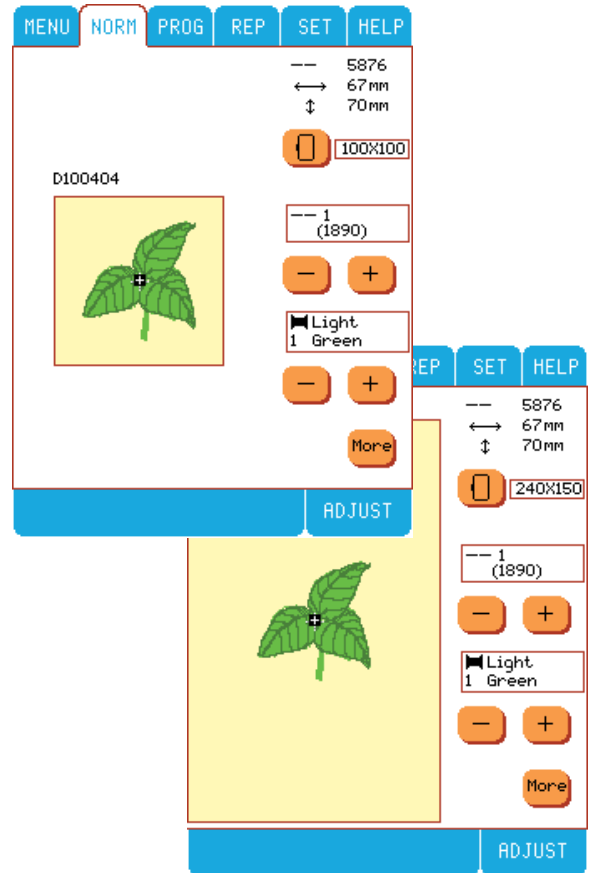



Slide the hoop onto the embroidery arm until it clicks into place. Press the purple button on the embroidery clip to release the hoop and slide it toward you.

Use the move design buttons to move the design to a different place in the hoop area. This is especially helpful when the fabric is hooped and the marked center starting position is not in the center of the hoop. Touch the arrows to move the hoop until the needle lines up with the marked starting point. An audible beep will advise you of the limits. If you want to get back to the center, touch .

Starting position  0.0  0.0

The numbers indicates starting position of the design, in mm, from origin. When changed plus (+) indicates right and up, minus (-) down and left.

Tip: If you need to turn off your Designer I while stitching large embroidery, make notes of starting position, stitch number and color number. Then you can continue from where you left off.

Use the check size button  to check the size and the outline area of the design on your fabric. When the check size button has been activated, it becomes dark brown with a white arrow indicating the current position .

When you select an embroidery the hoop is positioned so the needle will begin at the center of the hoop. However, if you select a design to make a sequence of embroidery, the needle will begin where the last embroidery was finished.

Touch  to go back .

SET in Embroidery

If necessary, for example when embroidering on unusual fabrics, set the thread tension in the  menu.

When embroidering on very thick fabrics or batting, you can raise the height of the presser foot. This is to allow the foot to glide over thicker fabric.

Manual adjustments of the thread tension and of the presser foot height are made in the  menu.

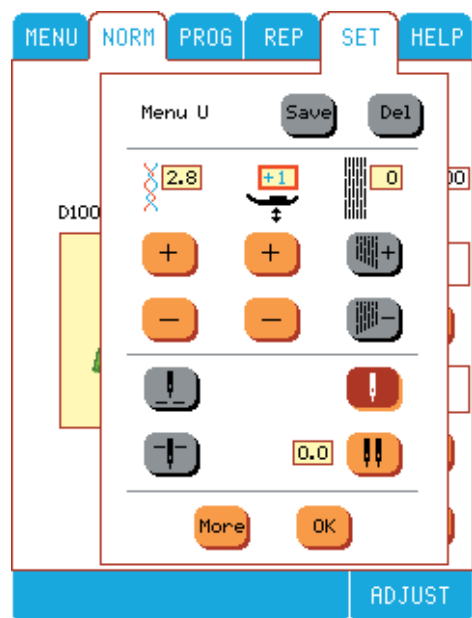
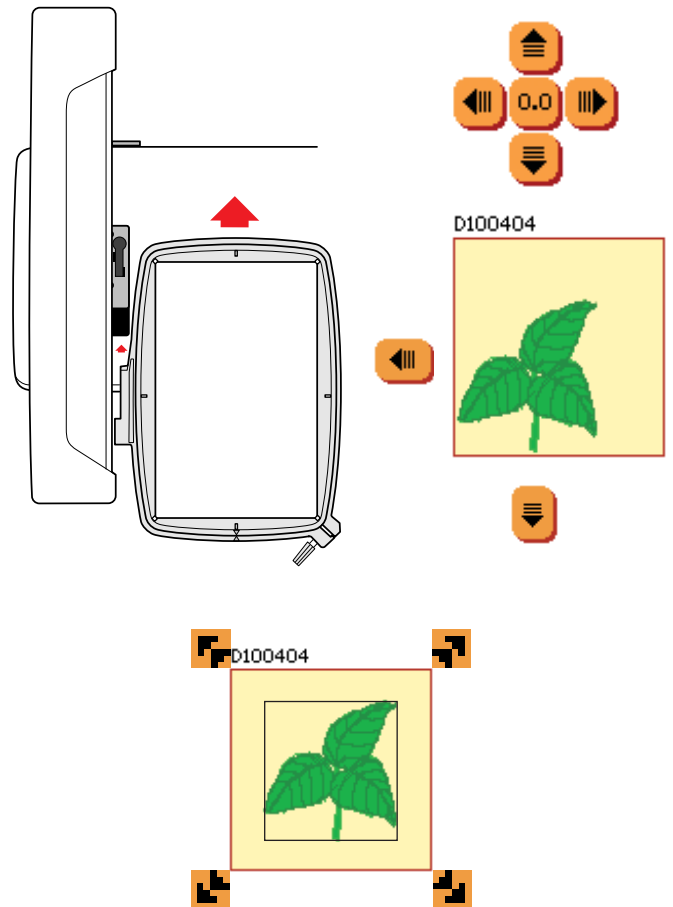



Adjust in Embroidery

There are many options to adjust your design. Always adjust first, before using any of the buttons on the embroidery screen menus (step through stitches, check parameters of design, move design in hoop, etc.) and before beginning to sew.

To activate Adjust menu touch .

Rotate embroidery

Touch  to rotate the embroidery in 90 degree steps. See it on the color touch screen. When an embroidery has been rotated, the button will be indicated in brown .

Mirror image side to side

Touch  and the leaf will flip side to side. The mirror image button will be indicated in brown.

Touch  to return to normal image

Size

Scale embroidery size up or down (up to 20%). An audible beep will advise you of the limits.





Height  70 mm

Use  .

Width  67 mm



Use  .

You can increase the width and height independently to create long and thin or short and wide designs. When enlarging or reducing the size of the embroidery, experiment with different weights of embroidery thread.

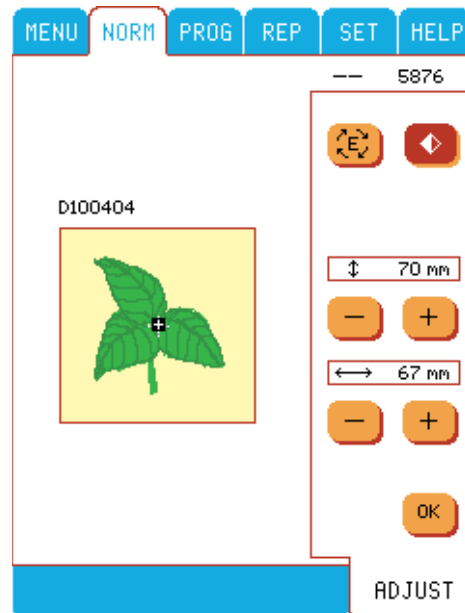
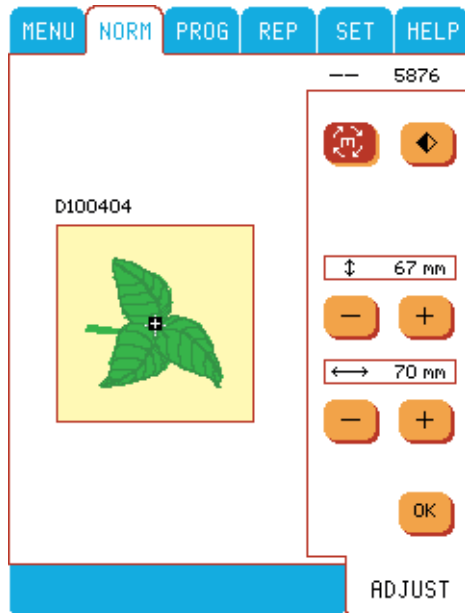
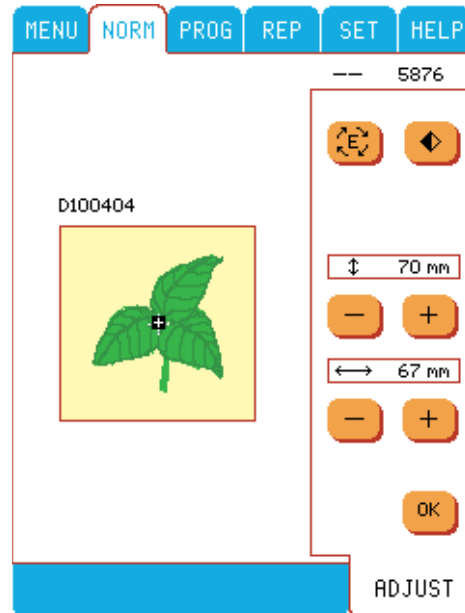
Exit  by touching  or by accessing the  or  menu.



View embroidery colors

The view color icon appears on the HELP menu . It is grey when not active. When it is colored and active, touch the icon to view the colors in an embroidery. You can scroll through the colors using  .

The menu shows color number, stitch count and color name. The current color is highlighted with a red frame. If the embroidery disk has color chart numbers included those will be shown instead of color names.



The color menu will stay open when the Designer I is sewing. Close the color menu by touching .

Embroidery features

FIX

Touch FIX in embroidery to baste an outline around the embroidery area. This is helpful when embroidering on fabrics that should not be hooped tightly. The FIX function can also be used to baste fabric to the stabilizer. This basting also indicates placement of embroidery.

When the FIX function is active, you cannot step forward or backward color by color, instead FIX is shown in the thread color recommendation field.

If the top thread has run out or broken, you can step backward a few stitches by touching . Touch  to step forwards stitch by stitch in the basting stitch.

Cursor

When embroidering, a cursor  indicates the needle position in the embroidery. The cursor follows the needle through the embroidery when sewing or when stepping through stitches or colors.

One Color Embroidery

Touch  (the light goes out) to cancel the color stops if you want to sew a design in one color only.

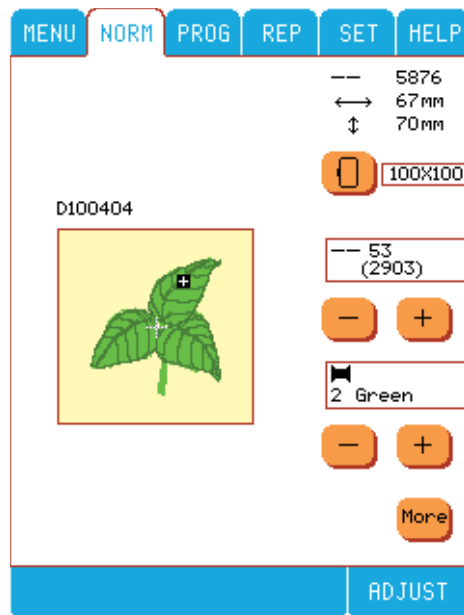
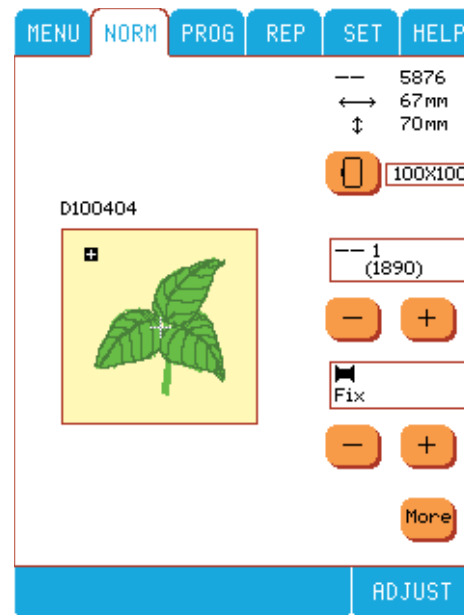
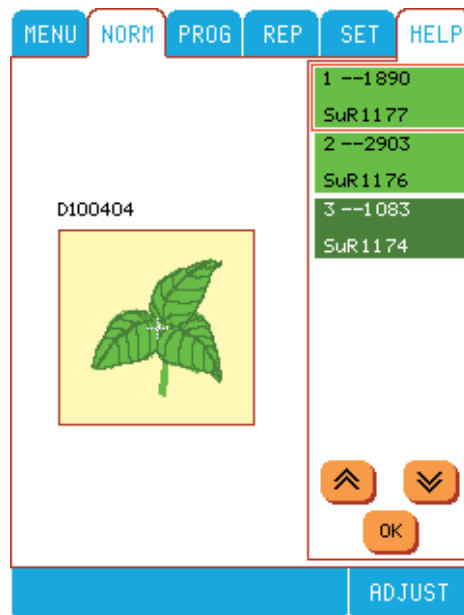

Pop-up menus in Embroidery

Embroidery Start Up Calibration



As the embroidery unit is connected to the machine, a Pop-up menu prompts you to slide off the hoop, and clear the machine area for positioning of the embroidery arm. Touch OK to calibrate the embroidery unit and to position the arm. This menu also reminds you to use the R foot.

Top Thread Break

Your Designer I stops automatically if the top thread runs out or breaks. Rethread the top thread, touch OK. Touch  to continue.

Empty Bobbin

Your Designer I stops when the bobbin is almost empty. Replace the empty bobbin with a full one, touch OK (bobbin winding, see page 10).

Note: When changing the bobbin, touch  and the hoop will move away for easy access to the bobbin case. Once the bobbin is replaced, touch  again to move the hoop back to where embroidery stopped. Touch  to resume the embroidery.

Color Change

Your Designer I stops automatically and the top thread only is cut at the color change. Remove the spool and rethread the top with the recommended color shown in the color menu of the color touch screen or in the Embroidery Booklet. Touch OK and  to resume embroidering.

Cut Embroidery Top Thread Tail

Your Designer I stops automatically a few stitches after you begin embroidering. Cut the starting thread tail, touch OK and  to resume embroidering.

Wrong hoop for embroidery

When the size of the hoop on the machine does not match the size displayed on the screen, your Designer I will not sew. Change the hoop to the size displayed on the screen.

Stop requested in design



Designer I stops when you are supposed to do a cut work, applique etc. See explanation for each design in the Embroidery Booklet.

Embroidery finished

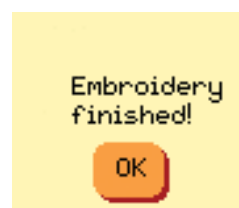
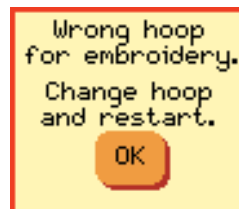
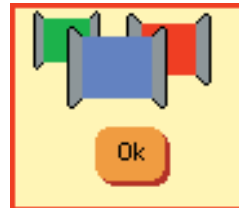
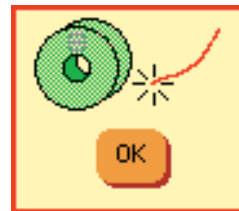
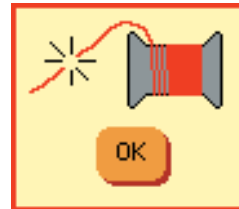
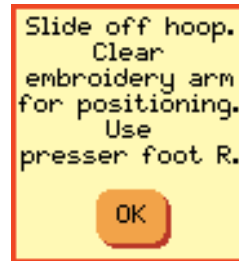
When your embroidery is complete a pop-up menu will appear. Touch OK to get back to your embroidery.





Start embroidering

1. Touch  to begin embroidering. The presser foot is lowered automatically.
2. After a few stitches a Pop-up menu will prompt you to cut the starting thread tail. Cut the thread tail. Touch  to resume embroidering.
3. Your Designer I will stop embroidering and a Pop-up menu will prompt you when the top thread color should be changed.
4. When your embroidery is complete, your Designer I will stop sewing, the top and bobbin thread are cut automatically, and the presser foot is raised to the extra lift position to make it easy to slide off the hoop.



To move the hoop forward for easy cutting

When changing from one thread to another, it is best to cut the long "jump" stitches that are created when the hoop is moving. This will make the thread cutting easier when the embroidery is finished.

1. Press . The hoop moves towards you.
2. Cut the threads.
3. Press  again and the hoop moves back to its ready position.
4. Press  to resume the embroidery.



Customizing Designs

Designer I has Built-In customizing. You are able to combine a number of designs and/or lettering programs on the Color Touch Screen to create customized embroidery.

Customize “Teatime and flowers”. Slide on the embroidery unit, see page 64. Turn on Designer I, and Main menu appears.



How to program “Teatime”

Slide in the Palace Script Disk.

Touch .

Touch .

Touch .

There are three sizes to choose between. Select size .

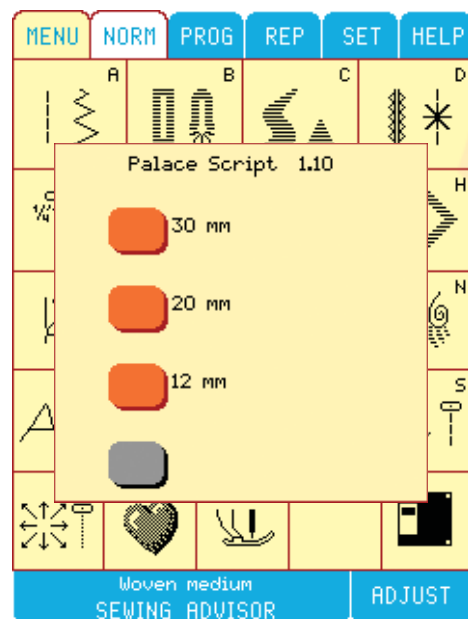

Touch . The capital letter T appears on the top of the Color Touch Screen in the programming area. The cursor line moves to the right ready for the next letter to be entered.

Note: If you have to correct spelling, use . This button erases your programmed letters backwards step by step.

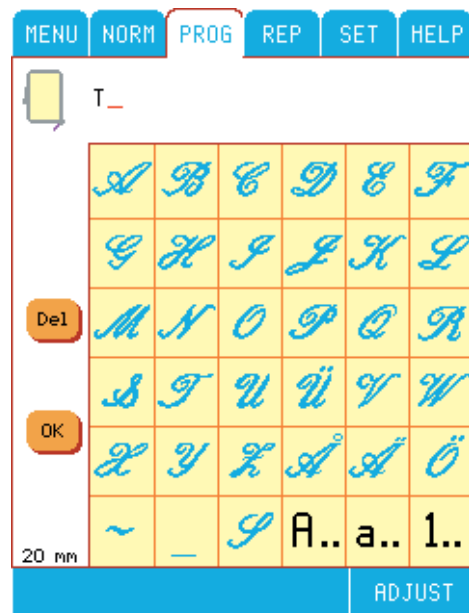

Touch **a..**. Now you have opened the lower-case menu. You are able to jump between upper case, lower case and numbers by touching

A.. a.. 1...

Touch **e**, **a**, **t**, **i**, **m**, **e**.

Touch **OK** and the letters have been programmed.

The combination you created is now visible on the Color Touch Screen.

Slide out the Palace Script disk.

Now you should rotate “Teatime” to fit in with the following “flower designs”.

Touch **ADJUST**.

Touch **↻** once.

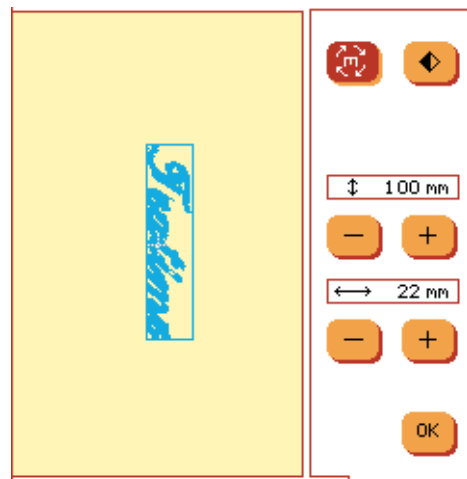
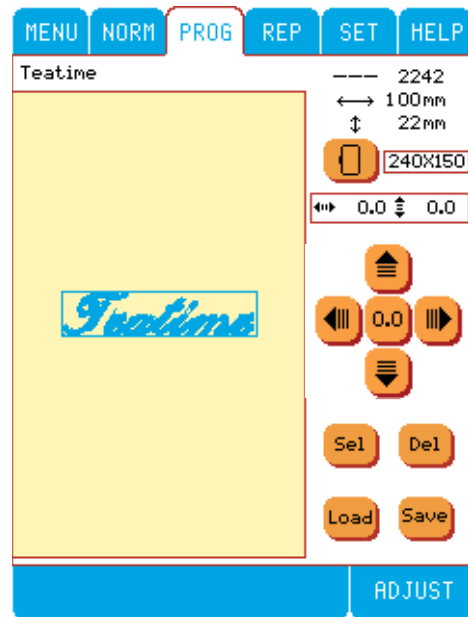
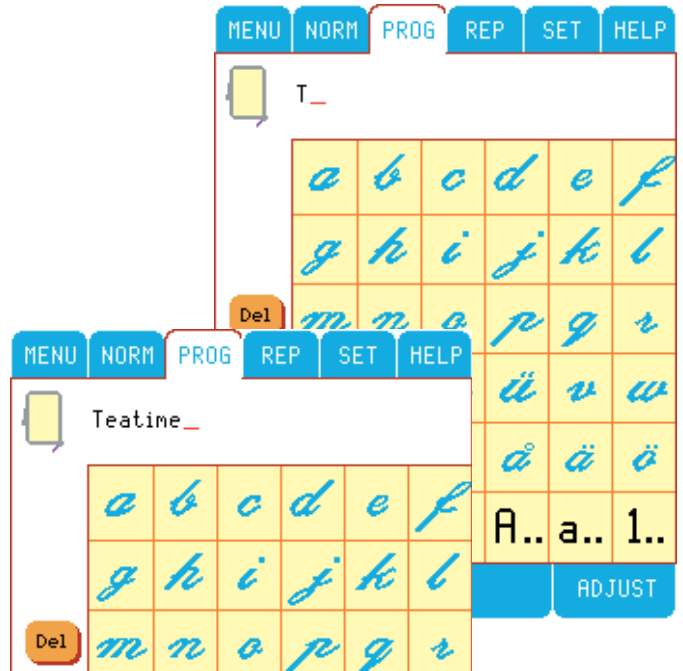

Combine the word with designs

Slide in the Designer Sampler Disk 100.

Touch **MENU**.

There are four menus to choose between. Touch



Select your design. Touch



The flower design is now visible on the screen. A box around the design indicates it is selected and can be worked with.

If you want to use 20x20mm grid, go to SET sub menu 3 and touch Grid ON.

Note: Touch **Sel** to select a part of the customized design. When a part is selected, it is indicated by a box around it. The selected part can be moved or adjusted, but you can also delete it by touching **Del**.

If you want to bring up a design, or a customized design from a disk memory, see page 81.



Touch **ADJUST**.

Touch .

Touch  three times.

Touch **OK**.



Use  to move the design to your selected position on the Color Touch Screen.

Touch **MENU** to select your second design.

Touch . A new flower design is now visible on the screen. The box around the design indicates it is selected and can be worked with.

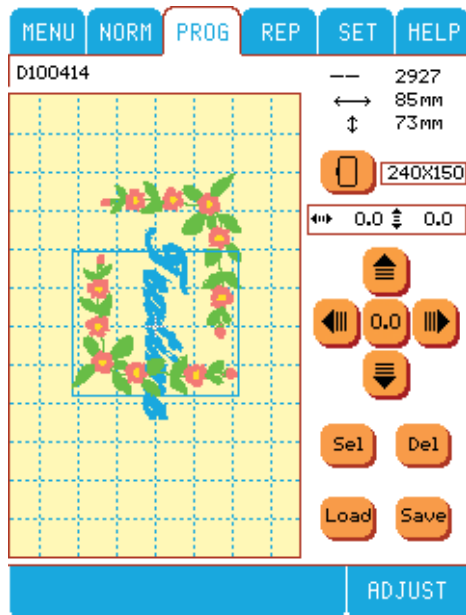
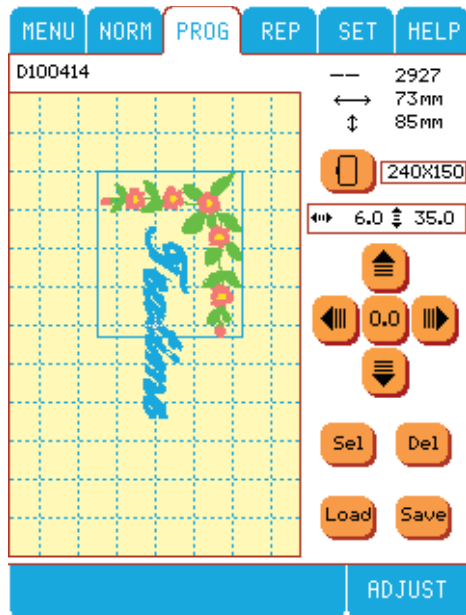
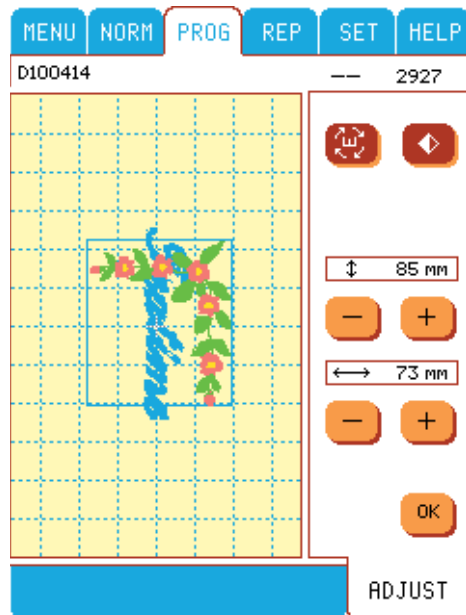

Touch **ADJUST**.

Touch .

Touch  once.

Touch .



Use  to move the design to your selected position on the Color Touch Screen.

Save your customized design

Touch **REP**. A Pop-up menu appears. Changes not saved! Save now? Enter No or Yes.

If you select No you are still able to sew your design.

If you wish to save your design for future sewing, slide in a PC-formatted disk and select Yes.

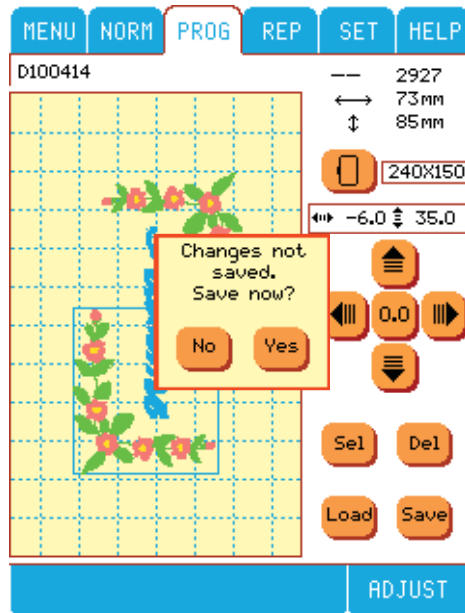
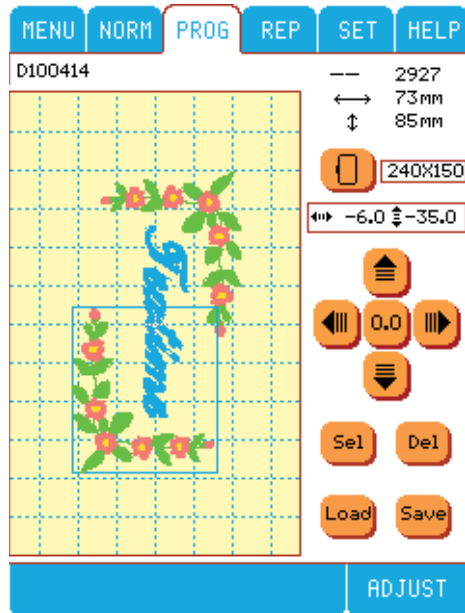
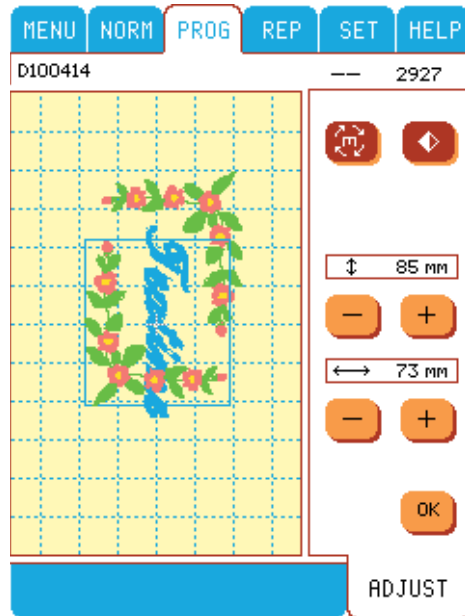

A new Pop-up menu appears.

The disk memory is indicated with .

Empty memories are indicated with green color, in this case memory D1 is empty, .

Step memory numbers with  .

If you wish to save design, touch , if not touch .

Full memories are indicated with red color, in this case memory D7 is full, .

Loading your saved designs from floppy disc

Turn on your Designer I or select Menu to return to Main menu.

Select .

Note:  can only be selected when the Main menu is displayed on the Color Touch Screen.

Select . A pop-up menu appears. “Load combination” with two boxes to select from.

M allows you to select programmed built-in stitches, and lettering, from one of the 15 memories that have been programmed from the stitch menus in the machine, by stepping through the memories.

D allows you to select from the memories on the disk. These are embroideries and lettering from disks that you have programmed in Built-In Color Customizing and saved to a floppy disk. There are 15 memories to select from.

Step through the memories with  .

Empty memories are indicated with , and full memories with .

Select the memory required, touch .

The saved combination will appear on the Color Touch Screen. A box appears around the first design in the combination, indicating it can be worked with.  will select other designs in the combination allowing for further adjustments.

Select  to stitch out the saved combination.

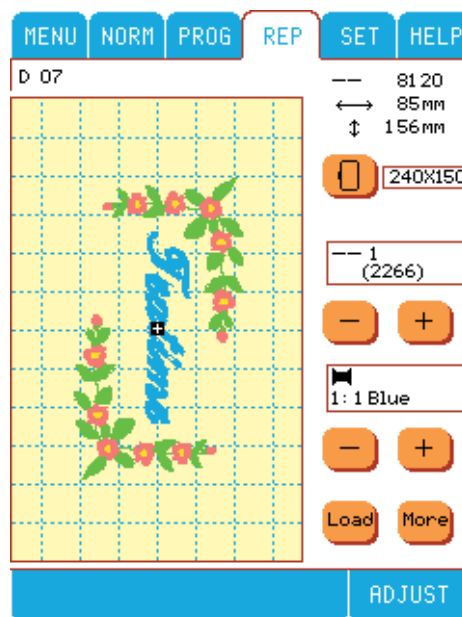
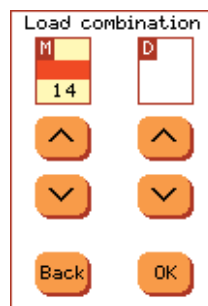
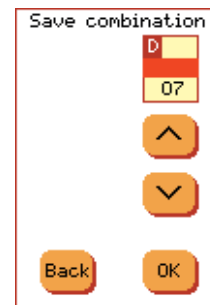
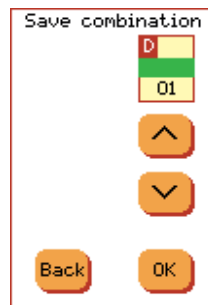

Built-in stitches in the hoop

Sew built in stitches (except stitches from B, S, U and V menus and stitches where the reverse button is used) within the hoop. Also combinations from memories M1-M15 can be sewn.

Use **NORM**, **PROG**, and **REP** for built in stitches in embroidery mode. The stitch number or memory number for the built in stitches are shown above the stitch area.

The Designer I will stop automatically when the sewn stitches reach the edge of the hoop, and you will also see a pop-up menu.

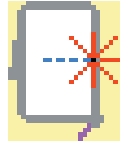

If a stitch is parallel to an edge but too close, the touch screen will display only the stitches that can be sewn out.

How to sew built-in stitches

To sew, select a stitch or a stitch program. To access the memories, touch **Load** in **REP**, and select desired memory.



Use the positioning arrows to position the starting point. The starting point **+** and sewing direction will be displayed on the Color Touch Screen.

To change stitch direction, stop sewing, touch **ADJUST**, touch the rotation icon . The built-in stitches can be rotated in 45° steps. Touch **OK** to see the stitch direction displayed.

This feature makes it easy to stitch, for example, a beautiful frame of stitches around an embroidery.

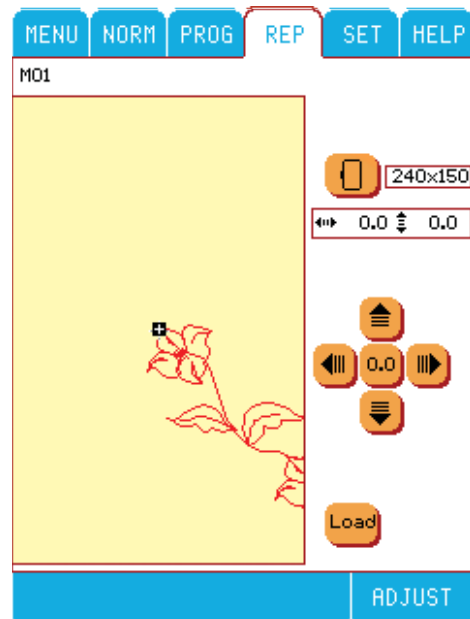
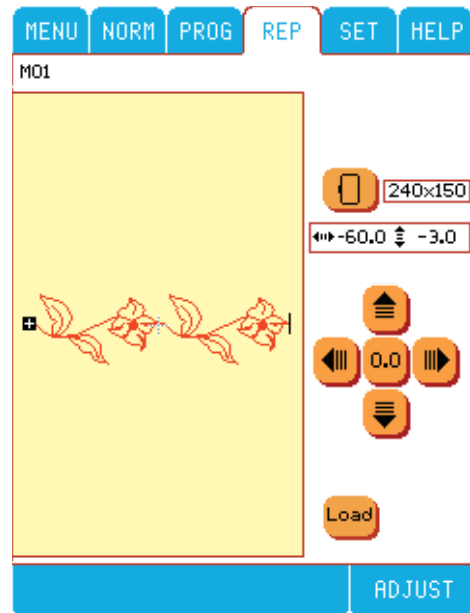
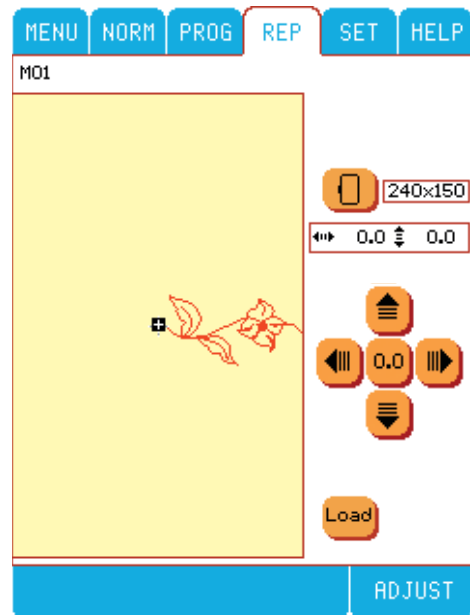

Decorative / Crafting

Your Husqvarna Viking Designer I is unsurpassed for creative options.

Stitch your way through the next pages to learn the basics for a few of the favorite creative techniques.

Appliqué

One of the most exciting and time saving features on your Designer I is the automatic satin stitch programs on Menu F, Applique Stitches. The pre-programmed satin stitch: 2mm stitch width F3, 4mm stitch width F4, 6mm stitch width F5. The top tension is reduced automatically for satin stitch.

Fabric: Quilting fabric, Husqvarna Viking Tear-A-Way stabilizer, Cotton scrap for applique.

Thread: Embroidery thread on top and embroidery weight bobbin thread.

Touch: Woven medium on the Sewing Advisor.

Touch: Menu F, Applique Stitches, Stitch F4.



Snap on: Presser foot B as recommended.

Sew:

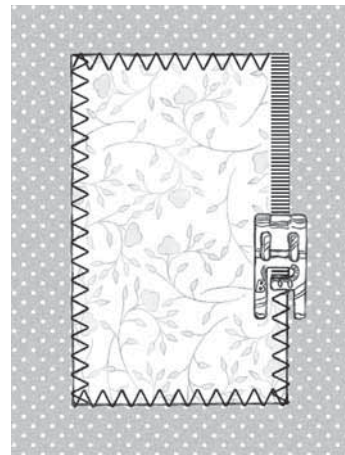
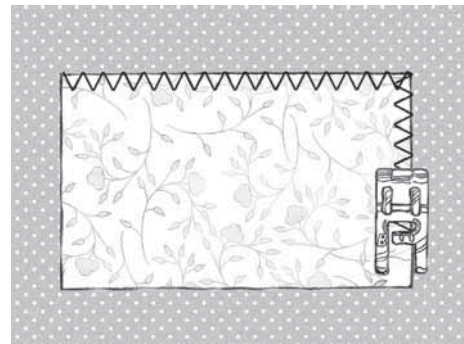
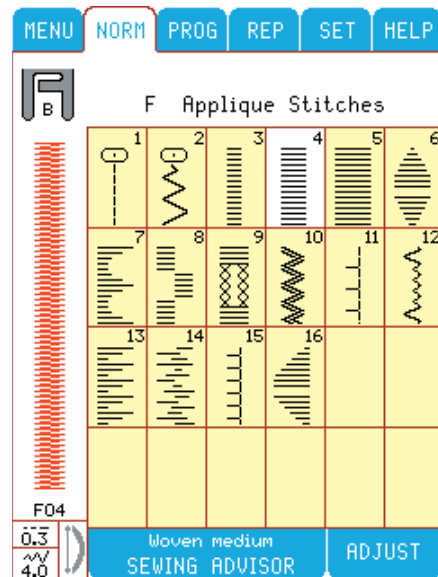
- Cut a small square for the applique from the cotton scrap.
- To baste applique square to the quilt fabric, touch A11 to zigzag stitch or use fusible web.
- Place Tear-A-Way stabilizer under the quilt fabric.
- Place the fabric under the presser foot.
- Satin stitch around the square with the outside swing of the needle sewing off the edge of the applique.



- To turn outside corners, touch needle stop down or tap the needle down with the foot control to pivot with the needle on the outside of the applique. The Sensor Foot Lift pivot position makes it easy!
- Touch  to secure the stitches.

Note: To adjust the satin stitch length or width, touch . Use the  and  buttons to fine tune the stitch length or width.

Tip: Snap on the transparent presser foot B with red lines for greater visibility.

Optional: The optional open toe applique foot is completely open in front for greater visibility and features a red guideline for satin stitching.



Taper Satin Stitch

The taper stitch on Menu F, Applique Stitches, stitch F6 automatically tapers the satin stitch for corners and points and can be used for satin stitch lettering. On the same piece of stabilized fabric, stitch a diamond of tapered satin stitch.









Touch: Menu F, Applique Stitches, Touch Stitch F6.

Snap on: Presser foot B as recommended

Sew:

The stitch will automatically taper from a point to the 1/4" (6mm) satin stitch width.

Note: The red line on the left side of the stitch indicates what part of the sewing sequence Designer I is sewing at the moment.

- Stitch about 1/2" (13 mm). Touch . The satin stitch will taper to a point and tie off automatically.
- For a narrower satin stitch, adjust the stitch width .
- To begin with a flat end satin stitch, touch stitch F6, touch reverse before beginning to sew. To make the tapered points longer, Touch , Elongation  .
- When you have the result you wish, touch . The stitch will now repeat in succession and the machine will stop automatically when the stitch is completed.
- Touch .
- Touch  to repeat.

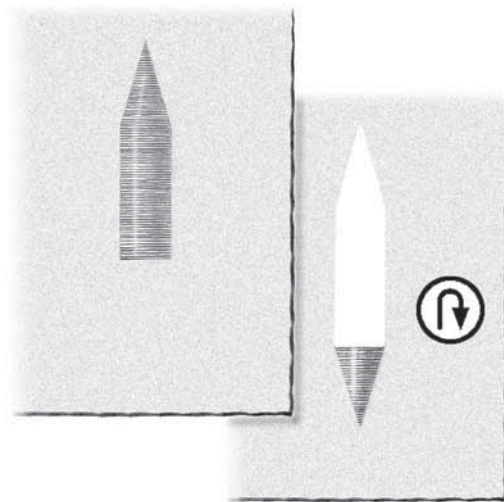
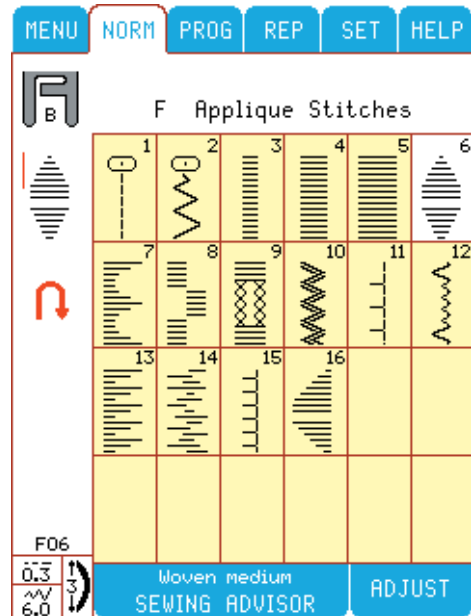

“Handlook” Heirloom Appliqué

Imitate the look of appliqué stitched by hand with the heirloom appliqué stitch. This stitch is also used for finishing bindings and trims with a hand stitched look and resembles the hand sewn buttonhole stitch.

Fabric: Broadcloth or chino, Husqvarna Viking Tear-A-Way, Cotton scrap for appliqué.

Touch: Woven medium on the Sewing Advisor. Touch Menu F, Appliqué Stitches, Stitch F11.

Snap on: Presser foot A as recommended.

- Thread the bobbin with embroidery weight bobbin thread. It is your choice for the top. For invisible appliqué, thread with invisible thread. For a decorative “hand look”, thread with embroidery thread and for a Folk Art appliqué effect, thread with black thread.
- Fuse or stick fusible web to wrong side of cotton scrap.
- Cut an appliqué shape from the scrap.
- Fuse the appliqué to the broadcloth and place Tear-A-Way underneath.
- Place under the presser foot and stitch around the outside of the appliqué with the straight stitch at the edge “in the ditch” of the appliqué and the side stitch sewing into the appliqué.
- Touch  to tie off at the end.

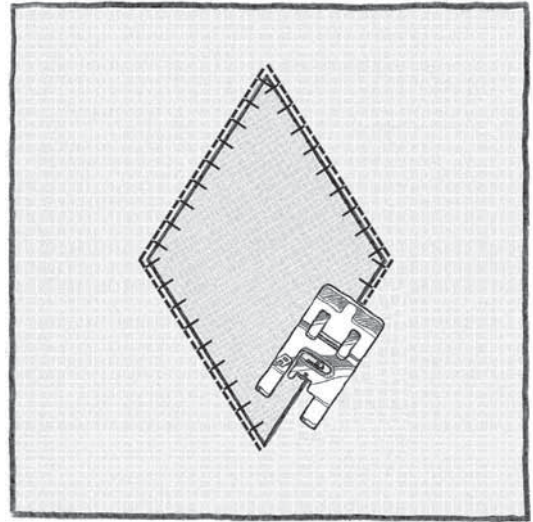

Appliqué Embroidery



Your Husqvarna Viking Designer I features a variety of embroidery options for appliqué. Page through the Husqvarna Embroidery Collection. Husqvarna Viking Embroidery Disk 27 designed exclusively for Husqvarna Viking by appliqué expert Mary Mulari of the USA, stitches appliqué embroideries.

- Set your machine for embroidery, see page 64.
- Place Husqvarna Viking Tear-A-Way stabilizer under the fabric, and hoop.
- Slide in Designer Embroidery Sampler Disk 100, Touch Menu 3 Stitch 3 Applique Bunny.

Embroider:

- Slide the hoop on the embroidery unit. Embroider the feet and shoes. Position appliqué fabric on top for the bunny dress outline.

Tip: Hold appliqué fabric in place with temporary spray adhesive. (Optional)

- Touch . A straight stitch outline around the appliqué section of the design is stitched automatically.
- When the machine stops, slide the hoop off but do not take the fabric out of the hoop. Trim away the appliqué fabric from outside the straight stitch outline.
- Slide the hoop onto the embroidery unit and touch . The Designer I will satin stitch around the appliqué automatically.
- Finish stitching appliqué bunny design.

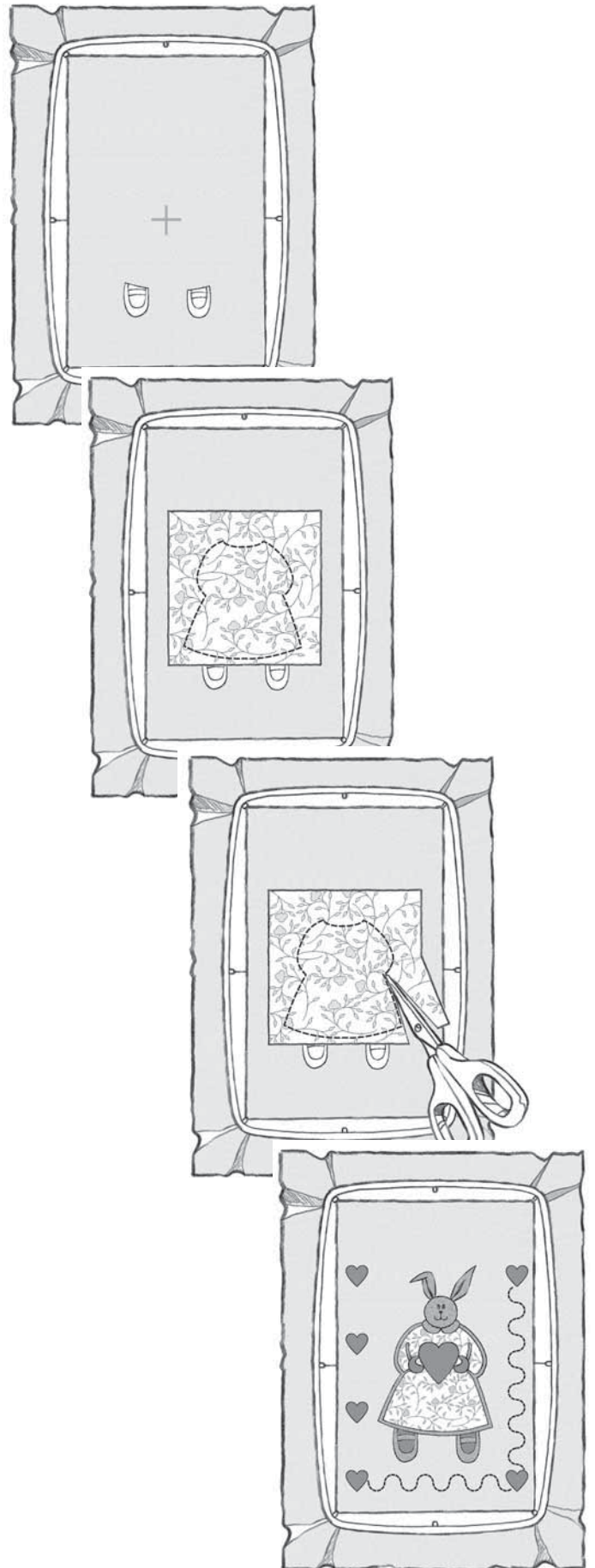

Decorative Stitches

Your creativity is unlimited with the Husqvarna Viking Designer I. It has a myriad of stitches for creative sewing and embellishment and programming possibilities. Touch the picture of the stitch on the Color Touch Screen and sew. The stitch is displayed in the direction it will be sewn.

Fabric: Broadcloth or chino, Husqvarna Viking Tear-A-Way stabilizer.

Touch: Woven medium on the Sewing Advisor, Decorative Stitches Menu L, Stitch L7.

Thread with: 30 weight embroidery thread on top and embroidery weight bobbin thread.

Snap on: Transparent presser foot B.

Sew:

- Place stabilizer under fabric.
- Sew several heart stitches.

FIX

- Touch  at the middle of a heart, the machine stops sewing and locks the stitches with several tiny straight stitches.

Stitch Re-start

Touch stitch re-start to begin at the first stitch of the decorative stitch. If you have altered a stitch width, length, elongation, it will be remembered.

- Touch stitch re-start .
- Stitching begins at the start of the heart.



STOP

The STOP button is used to conclude a stitch, i.e. the machine fastens the thread and stops automatically when the sewing of the stitch has been completed. STOP is cancelled when you press the button again or by selecting a new stitch.

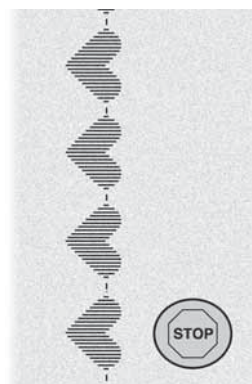
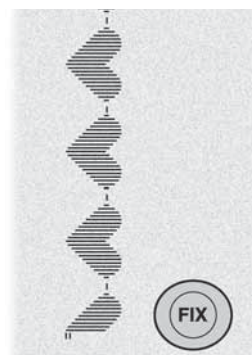
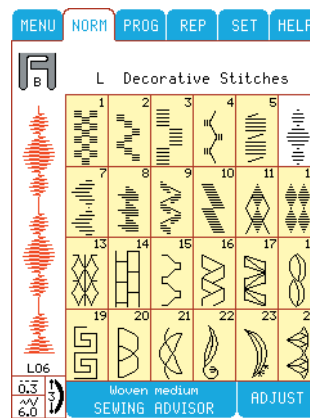
- As you begin stitching the next heart, touch  to tie off in place at the end of the heart.







Single Stitch

- Touch  before beginning to sew or while sewing a decorative stitch to sew only one stitch pattern.
- Sew a heart. The machine stops and ties off in place automatically.
- Touch  again to cancel it.

Elongation

You can alter the size of any decorative stitches with length and width settings. To alter the size of a satin stitch decorative stitch without changing the density of the satin stitch, use elongation

 or .

- Touch stitch L7, Touch , Touch Elongation  to make the hearts larger. See the altered stitch on the Color Touch Screen.
- Sew a row of stitches.

Mirror Image

Mirror image changes the direction of the decorative stitch pattern. See the stitch on the Color Touch Screen as it will sew.

Side to Side Mirror Image

Flip the stitch patterns from left to right. This often eliminates the need to feed the bulk of the fabric into the arm of the machine.

- Touch L7.
- Stitch two pattern repeats. Touch mirror image side to side . Watch the stitch change on the Color Touch Screen. The stitch will face the opposite direction.
- Stitch a few more stitch patterns.

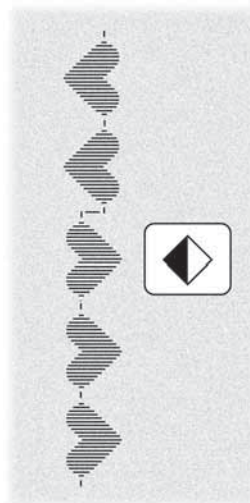
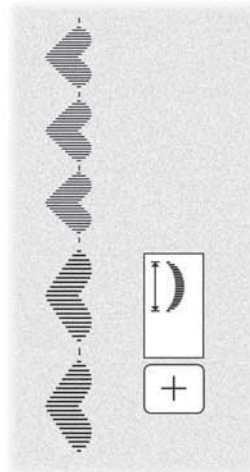

End to End Mirror Image

Flip the stitch patterns from front to back. This doubles the creative possibilities.

- Touch L22.
- Stitch a few patterns. Touch mirror image end to end . Watch the stitch change on the Color Touch Screen.
- Stitch a few more patterns.

Note: Program stitches with side to side and/or end to end mirror image or mirror image entire stitch programs for unlimited creative stitch possibilities.

In **PROG** you can mirror image each one of the stitches. In **REP** mode you can mirror image your entire program.

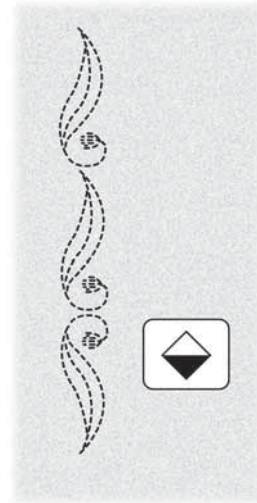

Cross Stitches

Program the cross stitch patterns to create borders, monograms and motifs.

Fabric: Woven medium Husqvarna Viking Tear-A-Way stabilizer

Touch: Woven medium on the Sewing Advisor

Snap on: Transparent presser foot B

Thread: Top thread with embroidery thread and bobbin with embroidery weight bobbin thread.

Program:

- Touch Menu D, Heirloom Stitches.
- Touch **PROG**, Touch stitch D13 (2 times), D13, **ADJUST**, side to side mirror image **◀**, **OK**, **REP**.
- Preview your cross stitch program on the Color Touch Screen.
- Place Tear-A-Way stabilizer under the fabric.
- Sew a row of cross stitch program.
- Touch **ADJUST**, touch side to side mirror image **◀**.
- Begin sewing at exactly the same place as the first row and match a second row of cross stitch program next to the first.

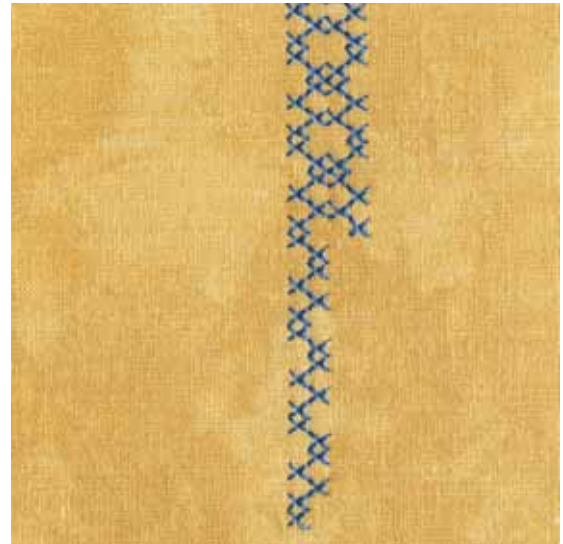

Lettering

Your Designer I sewing machine features built-in letters and numbers, Menu O, Block alphabet, Menu P, Outline block, menu Q, Brush line and Menu R, Script alphabet.

Together with Designer I you also received 3 disks containing Palace Script, Clarendon and Kalligraphia. If you look at the pictures you can see the different designs. The picture with A letters shows actual size. Programming from disk, see page 76.

Use the lettering for monograms, gift items, to label and date quilts and other endless possibilities.

Program built-in letters







Fabric: Broadcloth or chino, Husqvarna Viking Tear-A-Way stabilizer.

Touch: Woven medium on the Sewing Advisor

Snap on: presser foot B as recommended.

Thread top with embroidery weight thread, embroidery weight bobbin thread

Program:

- Program the phrase “for old bags” to put on your bag keeper project.
- Program a  whenever you want the lettering to stop sewing. We sewed our phrase on three lines.
- Touch , use a clear memory.
- Touch Menu O, Block Alphabet on the Color Touch Screen.
- Touch F, O, R, , O, L, D, , B, A, G, S, , . In the program mode the lettering appears at the top of the Menu in the direction you read it.
- Touch . Your program appears on the Color Touch Screen in the direction it will sew.

Sew:

- Stabilize fabric and stitch: FOR
OLD
BAGS

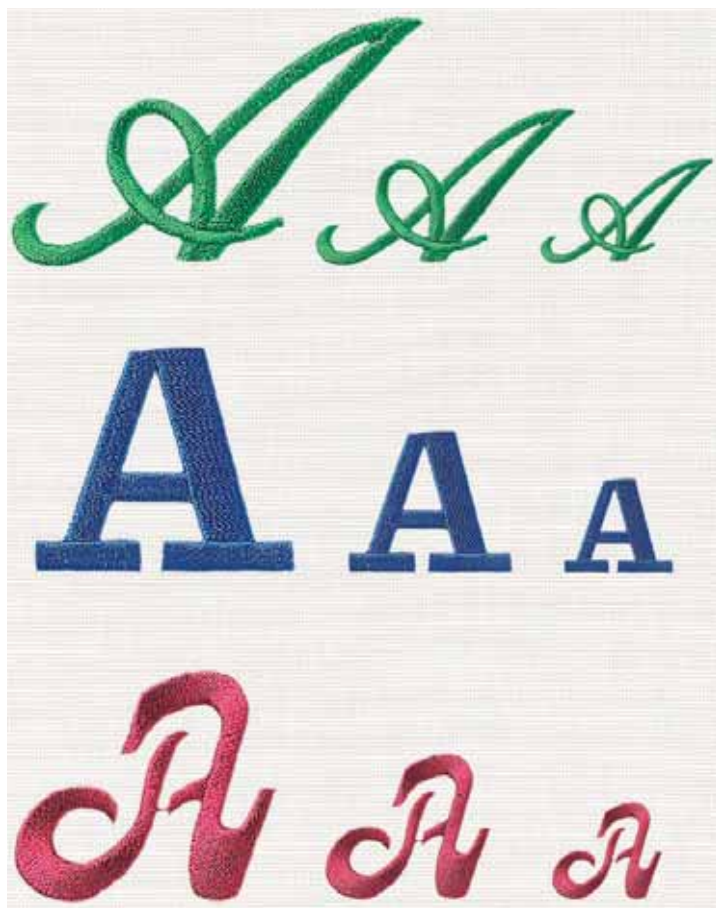
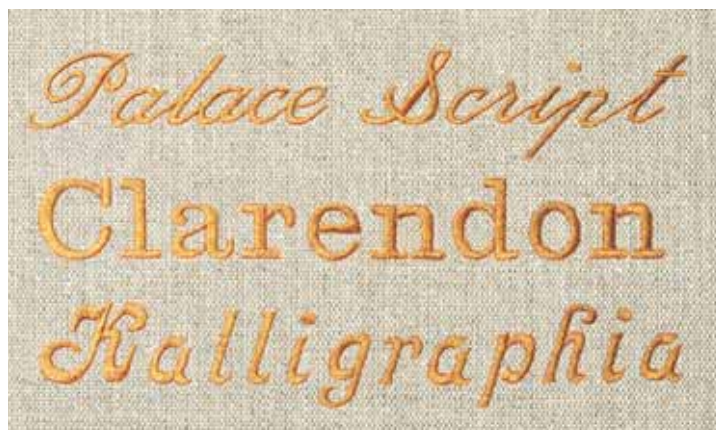

Outline block Monogram

Program your first and last initial in Block lettering.

- Touch **PROG**, use a clear memory
- Touch Menu P, Outline block Alphabet
- Touch your initials.
- Touch .
- Touch **REP** and sew.

Brush line Monogram

Program your first and last initial in Brush line lettering.

- Touch **PROG**, use a clear memory
- Touch Menu Q, Brush line Alphabet
- Touch your initials.
- Touch .
- Touch **REP** and sew.

Script Monogram



Program your first and last initial in Script lettering.

- Touch **PROG**, use a clear memory
- Touch Menu R, Script Alphabet
- Touch your initials.
- Touch .
- Touch **REP** and sew.

Upper and lower case lettering and numbers

Program your first name with upper and lower case letters and the date.

Program:

- Touch **PROG**, use a clear memory.
- Select the outline block lettering style.
- Touch the first letter of your name. Touch the lower case button .
- Touch the rest of your first name in lower case.
- Touch the numbers button .
- Touch the date.

Stitch on your sample fabric.

Note: Program smaller letter sizes with the stitch length and stitch width adjustments.



Quilting



Quilting

No one really knows when quilting began. Many European immigrants brought the technique to America where patchwork quilting flourished.

The English aristocracy pieced scraps of elegant fabrics with beautiful hand embroidery for Crazy Quilting. Quilts were functional and commemorative.

Today we quilt with our Husqvarna Viking to create beautiful quilts and quilted garments in a fraction of the time.

Quilting and piecing quilts

Your Husqvarna Viking Designer I will sew beautiful and functional quilting techniques quickly and easily.

Piecing

Stitch blocks together quickly and easily with the pre-programmed scant 1/4" (6mm) quilter's piecing stitch.

Fabric: Woven medium cut in two

Touch: Menu E, Quilt Stitches, Stitch E1.

Snap on: Presser foot A as recommended

Sew:

- Stitch the two fabric pieces with the edges along the edge of the A foot. Quilters call this piecing the quilt block.

Tip: Snap on the optional Edge Stitching accessory foot with the flange on the right side. The edge of the fabric is guided by the flange.

Decorative stitch tie Quilting

Tie a quilt with a single decorative stitch.

Touch: Menu E, Quilting Stitches, stitch E15 and touch .

- Stitch several diamond stitches about 1" (25 mm) apart to "tie" the quilt sample.

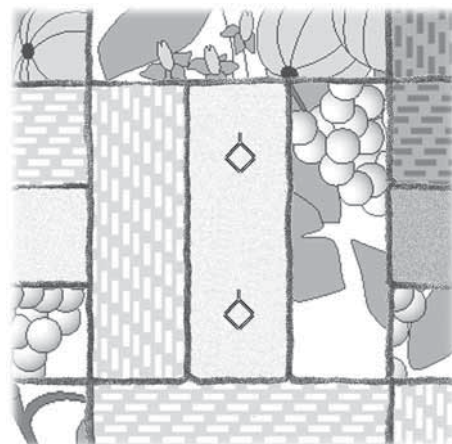
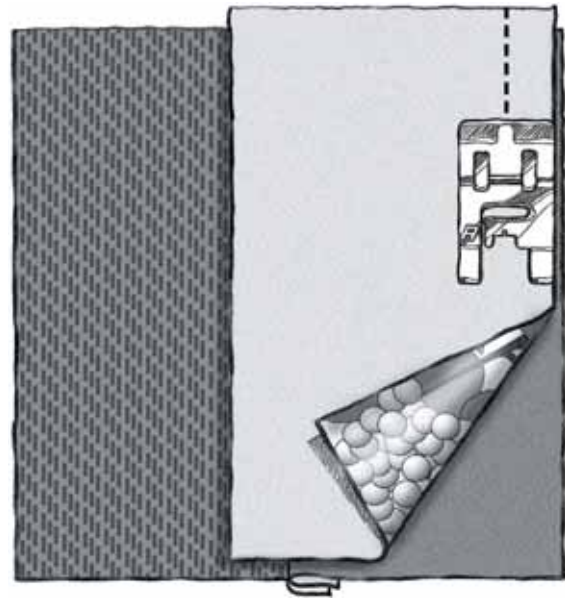
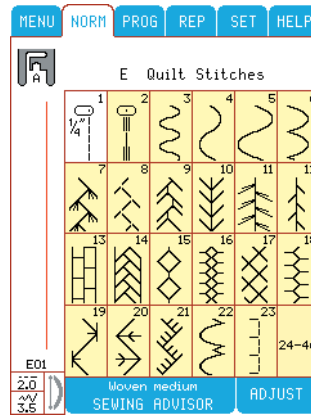

Crazy Quilting

Traditionally crazy quilting was stitched by hand. Today your Husqvarna Viking Designer I sewing machine sews the same stitches in a fraction of the time.

Touch: Menu E, Quilting Stitches, Stitch E21.

Snap on: Presser foot B or the transparent foot.

Sew:

- Stitch randomly on sample fabric.
- Touch E15, E17, and/or E20 or the stitches of your choice and sew additional styles of crazy quilt stitches on the sample fabric.

Designer I Sensor Foot Pressure makes quilting easy.



Hand-look Quilting

Simulate the look of the hand quilting stitch with invisible thread and a special computer stitch.

Touch: Menu E, Quilting Stitches, Stitch E2.

Snap on: Presser foot P as recommended.

- Thread the needle with clear invisible thread and the bobbin with a color of thread that coordinates with your fabric.

Sew:

- Stitch along one of the marked rows on your sample fabric. The inner edge of the presser foot P is 1/8" (3mm), the outer edges is 1/4" (6mm).

Note: When sewing the hand-look quilting stitch E2, the result depends on what fabric, batting and thread you are using. The thread tension is set for sewing a quilt using cotton fabric, cotton batting and 40 weight thread in the bobbin and invisible thread on top. When sewing a quilt using other fabrics/battings/threads, be sure to try the stitch on a sample first. Set the thread tension in **SET** menu as needed for your project.

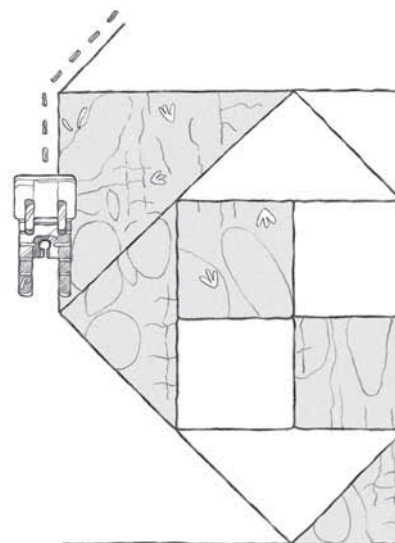

Stipple Quilting

Sew stippling fast and easy with the programmed stipple stitch.

Touch: Menu E, Quilt Stitches, stitch E24.

Snap on: Presser foot S as recommended.

- Thread the needle with clear invisible thread and bobbin with a thread color that matches the quilt back.

Sew:

- Stipple quilt on the sample fabric.

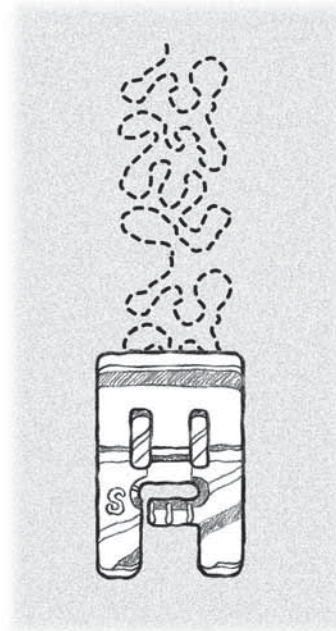

Channel Quilting

Fabric: Two 12" (30cm) squares of cotton woven medium fabric and one of batting to sew the following machine quilting techniques.

Touch: Woven heavy on the Sewing Advisor and choose Stitch E4

Snap on: Presser foot B as recommended.

- Thread top and bobbin with embroidery thread for decorative quilting techniques
- Mark three straight lines 1" (25 mm) apart along one fabric edge.
- Place the batting between the quilting fabrics.
- Channel Quilt along marked lines. Sensor Foot Pressure makes quilting several layers easy.

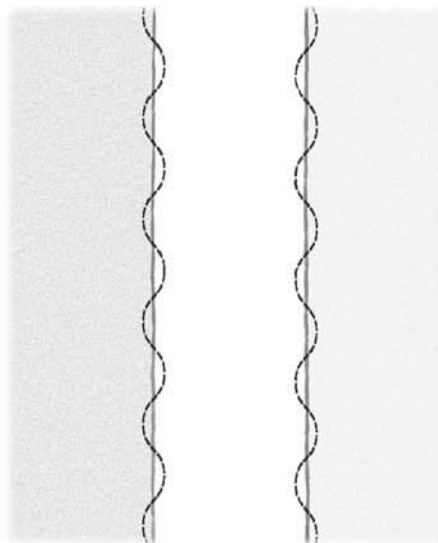

Edge/Quilting Guide

The Edge/Quilting guide is used for wide seam allowances, topstitching, or channel quilting. Slide the guide into the clip on the ankle. Adjust from side to side to the correct position.

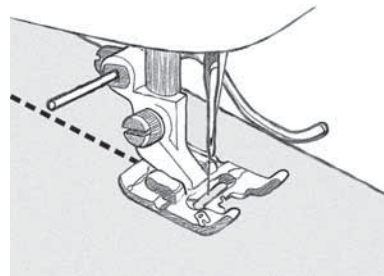

Quilt Embroidery

Your Husqvarna Viking Designer I features a variety of beautiful embroidery options for quilting. Page through the Husqvarna Viking Embroidery Collection to choose one for your next quilt. Husqvarna Embroidery Designer Disk 101 by Kerstin Widell stitches extra large quilting embroideries.

- Slide on the embroidery unit and set your machine for embroidery – see page 69.
- Place batting behind fabric to be quilted and hoop all layers.
- Slide in Designer Embroidery Sampler Disk 100, Embroidery Menu 2, Design 3.

Quilt:

- Slide the hoop on the embroidery unit. Touch Start. The quilting is stitched automatically. Stitch a second quilt embroidery if you desire.
- Use the edge guide to sew the squares.



Heirloom



Heirloom Sewing

Before the invention of the sewing machine, beautiful hand sewing techniques created “one of a kind” heirloom garments. Today, stitch these same techniques in a fraction of the time on your Husqvarna Viking Designer I.

As a general rule, heirloom sewing is stitched on natural fiber quality fabrics, trims and laces made from linen, silk and cotton. Pre-wash fabric and trims. Press with starch.

Entredeux

This technique, named for the French word *entredeux*, which means “in between” is stitched where lace or fabric are joined together or as a row of embellishment.

Fabric: Woven light, Husqvarna Viking Tear-A-Way stabilizer.

Touch: Woven light on the Sewing Advisor, Menu D, Heirloom Stitches, Stitch D7. Stabilize fabric as needed.

Snap on: Presser foot A as recommended.

Use: Wing needle as recommended.

- Thread top and bobbin with fine weight sewing thread in a color to match the linen.

Sew:

- Stitch a row of *entredeux*.

Lace insertion

- Place insertion lace on fabric.
- Touch Menu A, Utility Stitches, Straight Stitch A2. Stitch lace to fabric along both edges.
- Sew *entredeux* stitch on both edges of lace.
- Trim fabric from behind lace.

Tip: A sharp blunt tipped pocket scissors makes it easy to trim fabric without cutting lace. Use the same technique to stitch edging lace. Place edging lace 5/8" (15mm) from edge. *Entredeux* stitch along straight edge. Trim excess fabric.

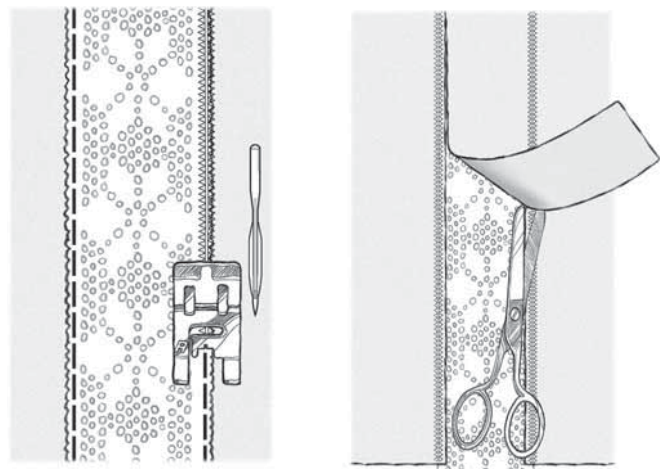
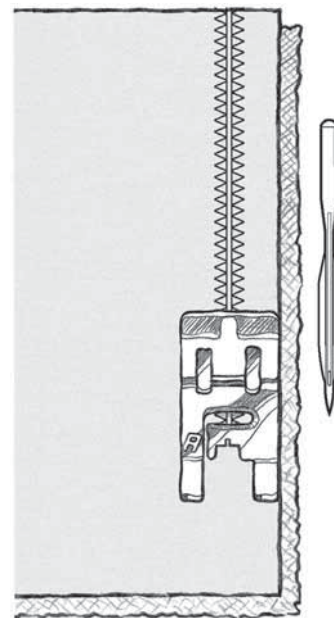
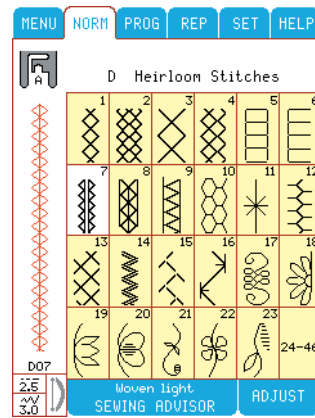

Bridging Stitch

Select the bridging stitch to sew two pieces of fabric or trim with edges butted together. Use this technique to join strips of lace and/or ribbon and to stitch them to a finished fabric edge. The bridging stitch is preferred for this type of joining for a flat, neat result.

Fabric: Short piece of insertion lace and linen fabric with one edge turned under or finished.

Touch: Menu A, Utility Stitches, Stitch A31

Snap on: Presser foot A.

- Place the pieces to be joined in the center of the A presser foot so they are perfectly aligned as you sew.
- Place lace and fabric edge to edge.

Sew:

The right zigzag stitch of the bridging stitch will catch the lace on the right and the left zigzag, the fabric on the left. The straight stitch sews between the two pieces of fabric, ribbon or lace.

Optional: You may use the Edge Joining presser foot.

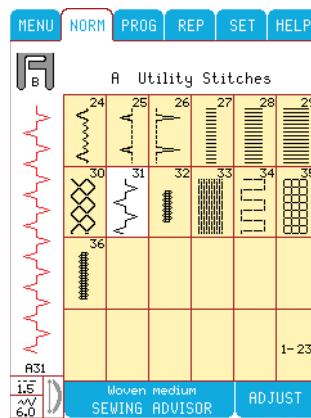

Hemstitching / Wing needle

Your Designer I features many decorative hemstitches. Hemstitches sew a lacey effect on natural fiber loosely woven fabrics for elegant tailored heirloom garments and table linens.

Fabric: Woven light, Husqvarna Viking Tear-A-Way stabilizer.

Touch: Woven light on the Sewing Advisor, Menu D, Heirloom Stitches, Stitch D4. Stabilize fabric as needed.

Snap on: Presser foot B as recommended.

Use: Wing needle as recommended.

- Thread top and bobbin with fine weight sewing thread in a color to match the fabric.

Sew:

- Sew a row of hemstitching.
- Touch stitches D5, D10, and sew additional rows. Experiment with other stitches on Menu D.

Tip: For a Pin stitch, touch D6, width 2, length 2.

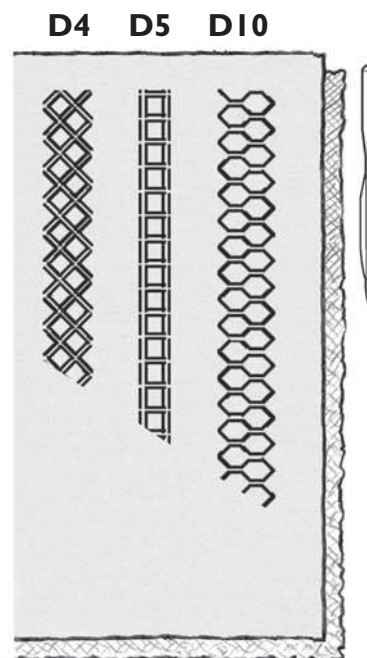

Scallop Stitching

Finish edges and create scallop details with one of the beautiful scallop stitches. Omnimotion (side motion) scallops sew beautiful wide edges for table linens, collars, cuffs, and more.

Fabric: Woven light, Husqvarna Viking Tear-A-Way stabilizer.

Touch: Woven light on the Sewing Advisor, Menu H, Scallop Stitches, Stitch H7.

Snap on: Presser foot S as recommended.

Use: Size 80 needle as recommended.

- Thread top and bobbin with Embroidery thread in a color to match the fabric.
- Place stabilizer under fabric as recommended.

Sew:

- Place fabric under presser foot with fabric edge at the edge of the bobbin cover.
- Stitch scallops. Let the machine feed freely. The feed system will move the fabric forward and from side to side at the precise speed to create the scallops.
- Put fray stopping liquid (optional) outside the scallop edge, just up to the scallop stitching and let it dry.
- Trim the fabric away outside the scallops.

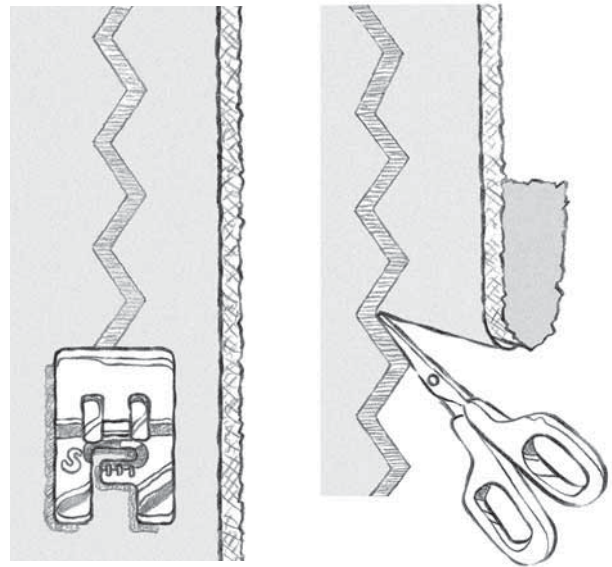
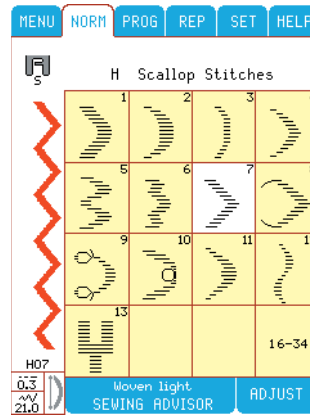

Smocking

The smocking stitches are sewn over fabric that has been pleated or gathered. The finished result imitates hand smocking.



Fabric: Woven light cotton batiste that has been pleated in a pleating machine designed for hand smocking. Fusible or Stick-On stabilizer.

Touch: Menu D, Heirloom Stitches, stitch D32.

Snap on: Transparent presser foot.

- Press or stick stabilizer to the wrong side of the pleated fabric.

Sew:

- Stitch the smocking stitch across the pleated fabric, using one of the pleating threads as a guideline to keep stitching row straight.
- Touch pattern re-start  and side to side mirror image  and begin sewing at exactly the same starting point. Stitch next to the first row of stitching matching the points of this “wave” smocking stitch.
- Touch stitch D30 for the cable stitch, and stitch and additional row of smocking.

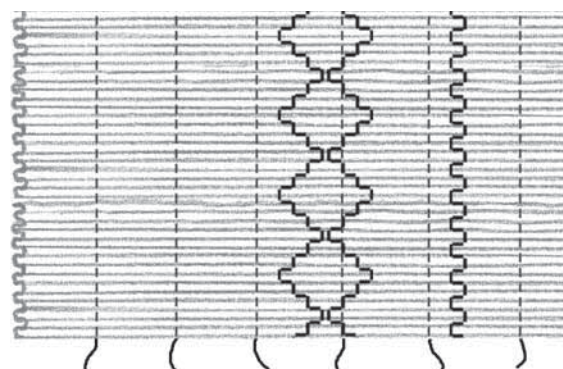
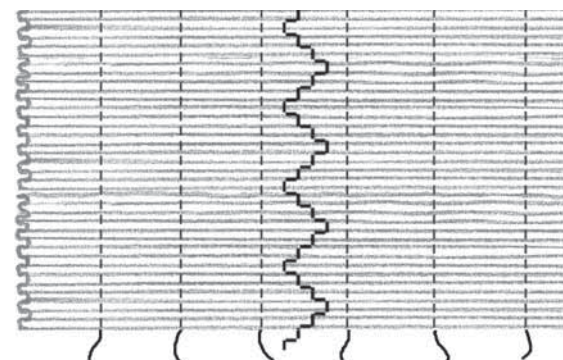
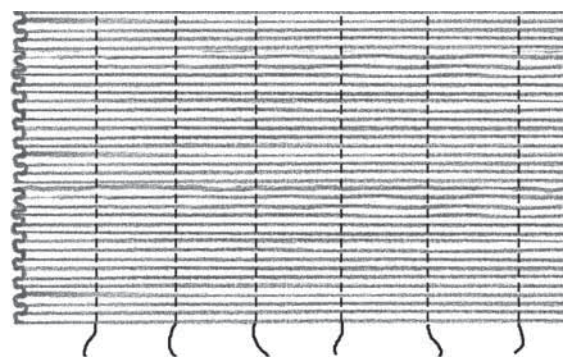



Cutwork Embroidery

Your Husqvarna Viking Designer I features a variety of beautiful embroidery options for cutwork. Page through the Husqvarna Viking Embroidery Collection to choose one for your next heirloom garment. Husqvarna Viking Embroidery Disk 26 designed exclusively for Husqvarna by cutwork expert Michelle Pullen of Australia, stitches beautiful cutwork embroideries.

- Set your machine for embroidery, see page 64.
- Place Husqvarna Viking Dissolve A-Way stabilizer underneath fabric and hoop all layers.
- Slide in Designer Embroidery Sampler Disk 100, Menu 4, Design 3 cutwork flower.

Embroider:

- Slide the hoop on the embroidery unit. Touch . The green satin stem will sew. Change color for the cutwork flower. Touch . A straight stitch outline around the cutwork design is stitched automatically.
- When the machine stops, slide the hoop off but do not take the fabric out of the hoop. Trim away the fabric from inside the cutwork straight stitch outline.
- Slide the hoop onto the embroidery unit and touch . The Designer I will finish sewing the cutwork design automatically.

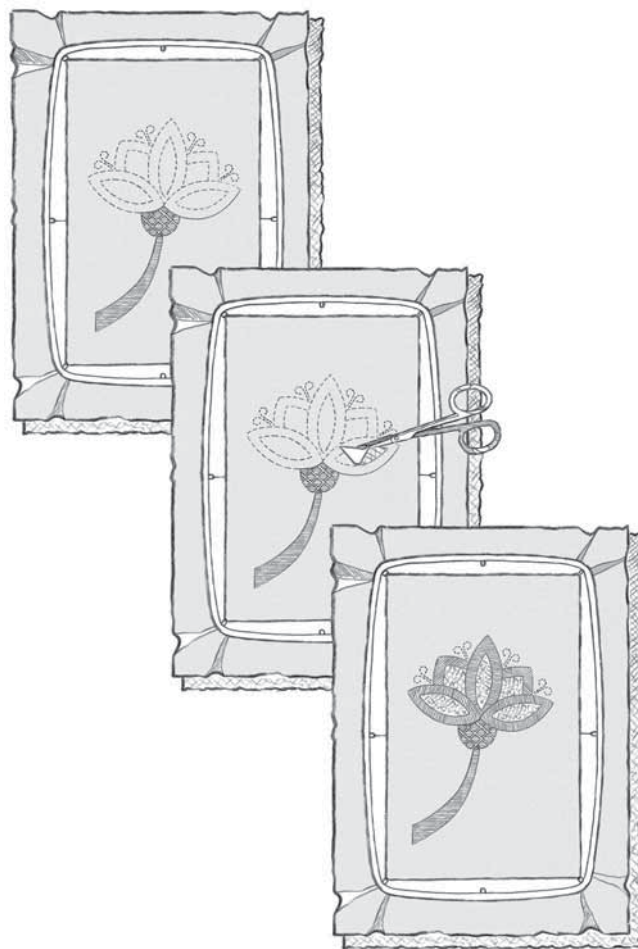

Pictogram

Pictogram embroidery allows you to program satin elements to create original stitch embroidery patterns.

Fabric: Woven medium, Husqvarna Viking Tear-A-Way stabilizer.

Thread: Top with embroidery thread. Embroidery weight bobbin thread.

Touch: Woven medium on the Sewing Advisor, Menu C, Pictogram stitches, stitch C22.



Snap on: Presser foot B as recommended.

Pictogram Flower



1. Green Stem

- Touch **ADJUST**, width 1.5.
- Sew a vertical row of satin stitch about 2" (50 mm) long for the stem.
- Touch .



2. Program Green Leaf

- Touch **PROG**, use a clear memory
- Touch stitch C2, **ADJUST**, elongation **+** to 4, **OK**, C22, **ADJUST**, elongation **-** to 2, **OK**, C2, **ADJUST**, end to end mirror image , elongation **+** to 4, **OK**, , **REP**.

3. Program Yellow Centers

- Touch **PROG**, use a clear memory.
- Touch C5, **ADJUST**, width 4.0, elongation **-** to 1, **OK**, C5, **ADJUST**, width 4.0, end to end mirror image , elongation **-** to 1, **OK**, , **REP**.

4. Program Red Petals

- Touch **PROG**, use a clear memory
- Touch stitch C4, **ADJUST**, elongation **-** to 2, **OK**, C2, end to end mirror image , **OK**, , **REP**.

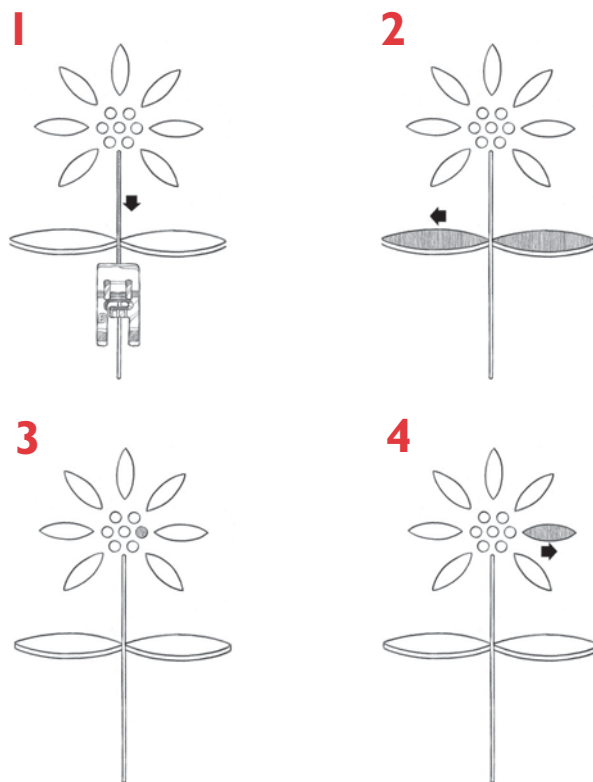

Care of your Designer I



Care of your Designer I

Designer I is equipped with two lights, one is placed to the left of the needle (A) and the other up to the right (B). Use light bulb designed as indicated on the front of the machine.

 Turn off the main switch.

Changing the light bulb (A)

1. Place the rubber sheath found in the accessory box with its deep hole, marked OUT, around the bulb.
2. Do not turn the bulb, just pull it down to remove the bulb.
3. When inserting, place the rubber sheath with its shallow hole, marked IN, around the new bulb, insert the bulb by pushing it up. Make sure the bulb is correctly inserted.

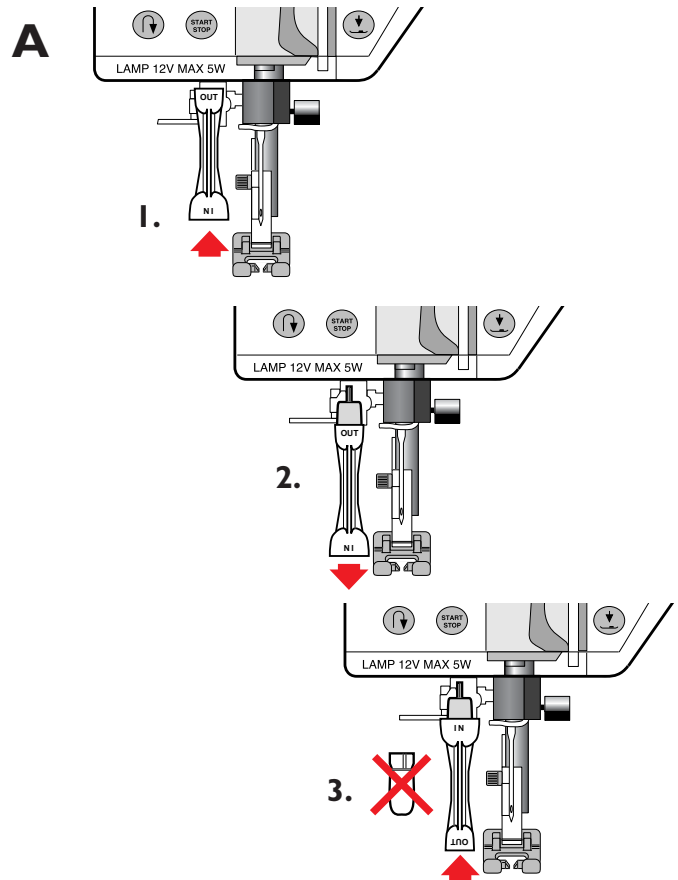

Changing the light bulb (B)

1. Remove the plastic guard by pulling slightly downward.
2. Place the rubber sheath found in the accessory box with its deep hole, marked OUT, around the bulb.
3. Do not turn the bulb, just pull it out to remove the bulb.
4. When inserting, place the rubber sheath with its shallow hole, marked IN, around the new bulb, insert the bulb by pushing it up.
5. Replace the plastic guard by inserting the rear edge and press it into the holder.

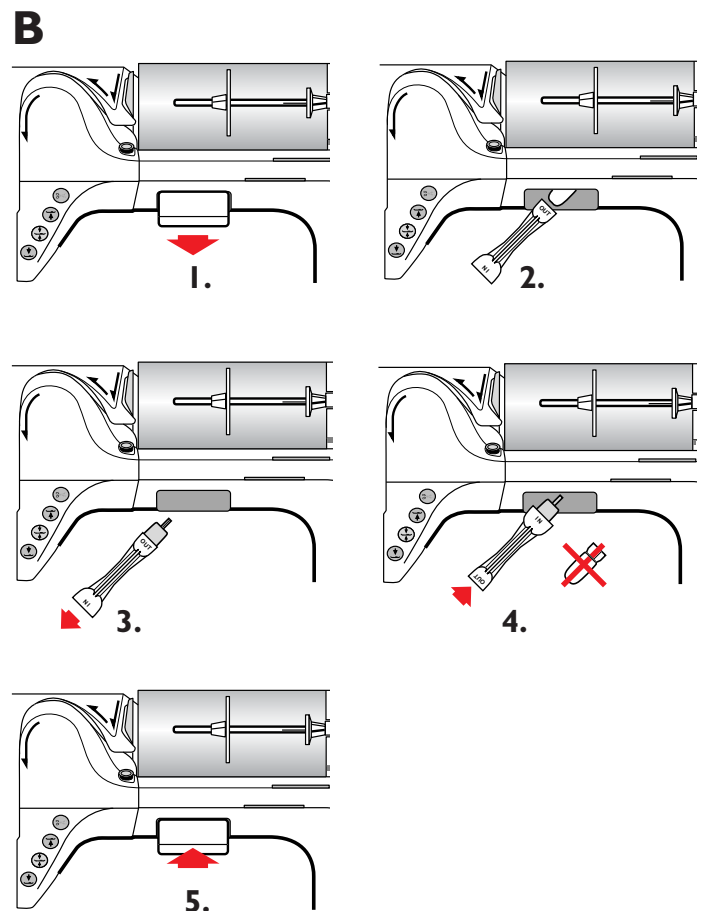

Care of the machine

To keep your sewing machine operating well, clean it often. No lubrication (oiling) is needed.

 Turn off the main switch.

Cleaning

Wipe the exterior surfaces of your Designer I with a soft cloth to remove any dust or lint built up.

Wipe the Color Touch Screen with a soft damp cloth.

Removing the stitch plate

Remove the presser foot and slide off the bobbin cover. Lower the feed teeth. Place the stitch plate opener on the brush, which you will find with the accessories, and then in the recess at the rear of the stitch plate and turn. Clean the feed teeth with the brush.

Cleaning under the bobbin area

When necessary, the bottom of the bobbin area must be cleaned.

Remove the bobbin case holder (1) covering the front part of the bobbin case (2). Remove the bobbin case by lifting it up. Clean with the brush.

Replace the bobbin case and the bobbin case holder.

Replacing the stitch plate

With feed teeth down, place the stitch plate about 5 mm in front of the rear edge and push it back. Slide on the bobbin cover. Raise the feed teeth.

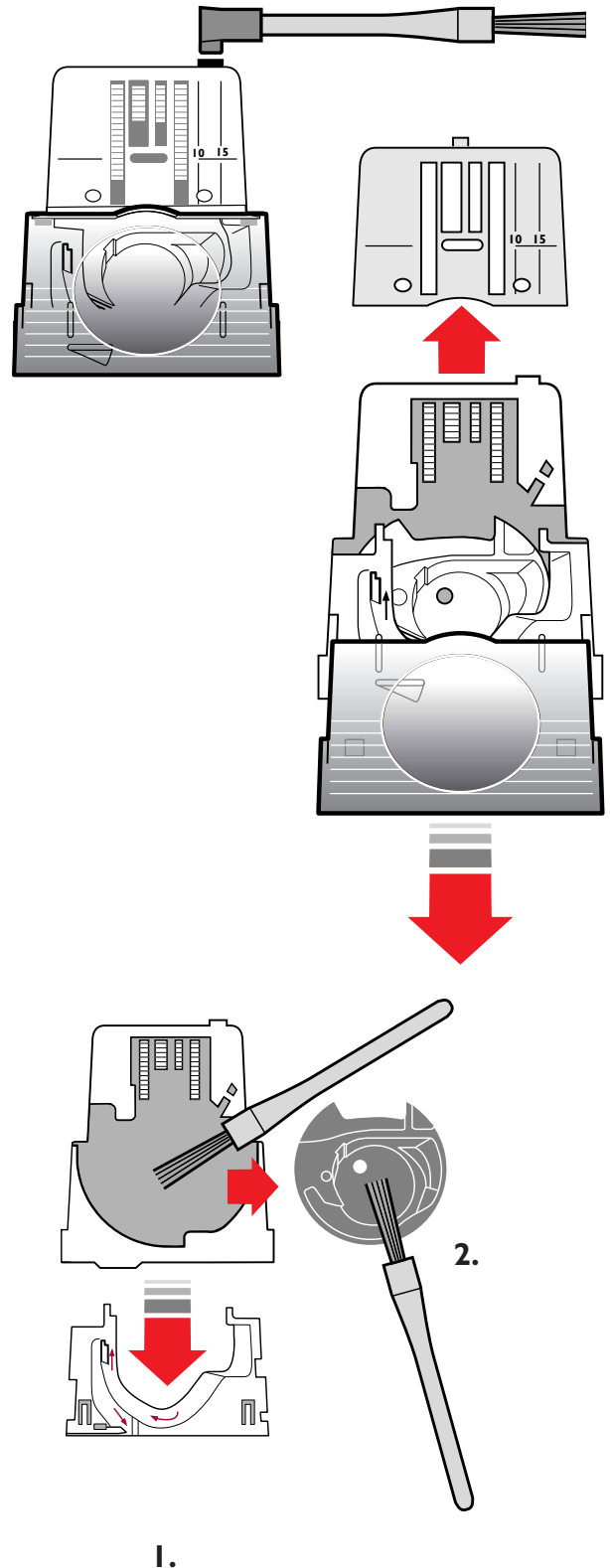

Trouble Shooting (fault-finding):

Any time you experience a problem when sewing:

- Enter correct type and weight of fabric into Sewing Advisor.
- Insert new needle-size and type as HELP recommends.
- Re-thread the top and bobbin.
- Use different thread spool on top (vertical or horizontal).
- Use thread nets and quality thread. We recommend the same sewing thread on top and bobbin for general sewing and 40 weight embroidery thread on top and bobbin thread for embroidery.

Fabric puckers?

- Enter correct type and weight of fabric into Sewing Advisor.
- Check needle, it could be damaged.
- Insert new needle size and type as HELP recommends.
- Re-thread top and bobbin.
- Change thread type to match fibre and sewing technique.
- Use quality thread.
- Shorten stitch length.
- Use stabilizer.

Skipped stitches?

- Check needle, it could be damaged.
- Change needle to recommended size and type.
- Be sure needle is inserted correctly and all the way into clamp.
- Rethread top and bobbin.
- Use recommended presser foot.
- Turn machine off and on to reset.
- Consult your dealer for service.

Needle breaks?

- Use care not to pull fabric when sewing.
- Insert new needle as HELP recommends.
- Insert needle correctly as page 16 explains.

Poor tension?

- Enter fabric weight and type in Sewing Advisor.
- Re-thread top and bobbin – use quality thread.
- New needle-size and type as HELP recommended.
- Turn machine off and on again to recalibrate tension.
- Follow HELP recommendations for stabilizer.

Fabric does not move?

- Feed teeth up.
- Increase stitch length.

Upper thread breaks?

- Does thread feed smoothly/not catching?
- Use thread nets and quality thread.
- New needle-size and type as HELP recommends.
- Re-thread top and bobbin – check for correct threading.
- Try different thread spool pin on top (horizontal or vertical).
- Turn the machine off and on to reset automatic tension.
- If stitch plate hole is damaged, replace stitch plate.
- Are the correct thread holder used in front of the thread?

Bobbin thread breaks?

- Wind a new bobbin.
- Replace bobbin in machine, check correct threading, page 11.
- If stitch plate hole is damaged – replace stitch plate.

Bobbin alarm does not work?

- Clean lint from bobbin area.
- Use only authentic Husqvarna green style bobbins.

Bobbin winds irregularly?

- Check threading for bobbin winding.

Thread cutter does not cut?

- Remove stitch plate and clean lint from bobbin area.
- In embroidery - go to SET Menu, thread cutter on auto.

Wrong stitch, irregular or narrow stitches?

- Cancel twin needle safety.
- Turn machine off and on to reset.
- Change needle, re-thread top and bobbin.
- Use stabilizer.

Presser foot will not go down?

- Turn the machine off and on.
- Put bobbin winder spindle up into sewing position.
- Sensor Foot lift on auto in SET Menu.

Color Touch Screen is dark (or light?)

- Change screen contrast in SET Menu.

Color Touch Screen is off?

- Touch screen.
- Cancel screen saver in SET Menu.
- Turn machine off and on to reset.

Buttons on Color Touch Screen are not activated when touched?

- Calibrate the Color Touch Screen. See instructions on page 31.

Machine sews slowly?

- Check speed
- Remove stitch plate and brush lint from bobbin and teeth area.
- Have machine serviced at your dealer.

How to update Designer I

All information in this Husqvarna Viking Designer I User's Guide is current at the time of printing.

We constantly receives feedback from Designer I owners and dealers and uses this information to

Machine will not sew?

- Put bobbin winder spindle up into sewing position.
- Slide off embroidery unit.
- Check plugs are all the way into machine.
- Check wall plug and power to wall plug.

Embroidery puckers?

- Use correct stabilizer – see Accessory User's Guide.
- Hoop fabric tightly – see page 66.

Built-In Customizing will not program?

- Slide on embroidery unit.
- Insert embroidery disk.
- Consult User's Guide for instructions.

Machine will not embroider?

- Push embroidery unit firmly into machine socket.
- Insert embroidery disk.
- Slide on hoop.

Have your Designer I serviced regularly by your Husqvarna Viking dealer.

If you have followed this trouble shooting information and still are having sewing problems, take it to your dealer. If there is a specific problem, it is a great help to test sew with your thread on a scrap of your sewing fabric. A sewing sample will often give much better information than words.

Non-original Parts and Accessories

The Designer I warranty does not cover any defect or damage caused by use of non-original accessories or parts.

produce updates and upgrades.

Be sure to consult the web site at www.husqvarnaviking.com and/or your local Husqvarna Viking dealer often for updates and upgrades to your Designer I and User's Guide.

Index

Accessory Tray	7	screen menus	70-71
Appliqué	84, 87-88	sewing	69-75
Bartacks	60	template	67
Baste – Sewing Advisor	45	unit, connecting	64
Belt loops	60	Entredeux	102
Blind hem – Sewing Advisor	47	Fabric selection	40-41
Bobbin		Fault-finding	112-113
placing in the machine	11	Favorite Stitches	26
winding	10-11	Feed teeth, lowering	15
winding – vertical spool pin	11	Finish the sewing	27
Bound Buttonhole	53	FIX	12, 37, 73, 89
Bridging Stitch	103	Foot control	6
Built-In Customizing	76	Free Hand Embroidery/Quilting/ Sewing	26
Built-in stitches in the hoop	82	Free Motion Embroidery/Quilting/ Sewing	26
Buttonhole		Function buttons	12
balance	52	Function buttons, embroidery	70-71
Bound	53	Gathering	54
corded	52	Getting started	69
cutting	53	Handlook “Heirloom” Appliqué	87
density	53	Hem – Sewing Advisor	48
Menu B	51-53	Hemstitching	103
Rule	49	Heirloom	101-107
Sensor Foot	49	Lace insertion	102
Sewing Advisor	49	Leather	40
step by step	52	Lettering	93-94
Button, sewing on – Sewing Advisor	51	Lightning Stitch	54
Calibration of Color Touch Screen	31	Load saved design, stitches	81
Care of your Designer I	109-113	Lowering the feed teeth	15
Changing light bulbs	110	Main Menu	18
Changing needle	16	Mending Stitches, 4-way	62
Changing presser foot	13	Menu	
Cleaning	111	A – Utility Stitches	20, 54-61
Color Touch Screen	17-38	B – Buttonhole Stitches	20, 51-53
Connecting		C – Pictogram Stitches	22, 107
the embroidery unit	64	D – Heirloom Stitches	22, 101-107
the foot control	6	E – Quilt Stitches	22, 95-99
the machine	6	F – Appliqué Stitches	23, 84-88
Corded buttonhole	52	G – Children Stitches	23
Cross Stitches	92	H – Scallop Stitches	23, 104
Customizing, Built-In	76	K – Omnigram Stitches	23
Cutting buttonhole	53	L – Decorative Stitches	24, 89-91
Cutwork embroidery	106	M – Crafting Stitches	24
Darning	59	N – Fashion Stitches	24
Decorative / Crafting	83-94	O – Block alphabet	25, 93-94
Decorative Stitches	89-91	P – Outline block alphabet	25
Disk Drive, built in	65	Q – Brush line alphabet	25
Embroidery	63-82	R – Script alphabet	25
booklet	65	S – 4-way Stitches	25, 66
carrying case	64	T – 8-way Stitches	25
Free Motion	26	U – My Stitches	26
hoop	66	V – Special Stitches	26
pop-up menus	74		

Multiple Zigzag Stitches	58	Sensor Q-foot	31, 33
My Stitches	26	Sewing Advisor	19, 40-50
Needles	16	Sewing	
Needle, changing	16	Bartacks	60
Needle positions	55	Embroideries	69-75
Needle stop up/down	12	Buttons	51
Needle Threader	9	speed	12
One Color Embroidery	73	surface	7
Overcast – Sewing Advisor	44	zipper	56
Overview	4-5	Smocking	105
Packing away after sewing	6	Special Stitches, V-Menu	26
Pictogram	107	SPEED	12
Placing the accessories	7	Spool holders	8
Placing the bobbin	11	Spool pin	8
Presser feet	14-15	Start / Stop	12
Presser foot, changing	13	Starting position	71
Presser foot lift	13	Starting to sew	27
Presser foot pressure	13	Step by step buttonhole	52
Programming		Stipple Quilting	98
Embroidery	76-81	Stitch plate	111
Decorative Stitches	92	Stitch Re-start	12
Stitches and letters	35-38, 93-94	Stitch tabel – Menu A	61
Pictogram	107	STOP	12, 37, 73, 89
Quilting	95-99	Straight Stitch	54
Channel	98	Stretch Stitch	54
Crazy Quilting	97	Surface extension	7
Decorative Stitch tie	96	Table of contents	3
Edge Quilting Guide	99	Taper Satin Stitches	86
Embroidery	99	Thread	41
Free Motion	97	Cutter	12, 37
Handlook	97	Net	65
Stipple	98	Tension	27, 29
Reinforced Straight Stitch	57	Trimming in Hoop	75
Removing Embroidery unit	65	warning	9
Removing the stitch plate	111	Threading	9-11
Reverse	12	for twin needle	10
Safety instructions	2	upper thread	9
Saving Customized Design	80	Trimming Thread in Hoop	75
Scallop stitching	104	Trouble shooting	112-113
Seam – Sewing Advisor	42-43	Twenty-five needle positions	55
Seam and Overcast – Sewing Advisor	45	Twin needle threading	10
Selecting fabric on Sewing Advisor	40-41	Unpacking the machine	6
Selecting sewing technique on		Updates	113
Sewing Advisor	19	Utility Stitches	54-61
Sensor foot	12-13	Vinyl	40
down	12	Wing needle	16, 103
lift	13	Woven or Knit	40
lift up	12	Zigzag Stitches	58
lift pivot	12, 13	Zipper	56
pressure	13		

We reserve the right to change the machine equipment and the assortment of accessories without prior notice, or make modifications to the performance or design.

Such modifications, however, will always be to the benefit of the user and the product.



Please note that on disposal, this product must be safely recycled in accordance with relevant National legislation relating to electrical/electronic products. If in doubt please contact your retailer for guidance.



 **Husqvarna**

VIKING

VSM Group AB • SE-561 84 Huskvarna, Sweden
www.husqvarnaviking.com

Free Manuals Download Website

<http://myh66.com>

<http://usermanuals.us>

<http://www.somanuals.com>

<http://www.4manuals.cc>

<http://www.manual-lib.com>

<http://www.404manual.com>

<http://www.luxmanual.com>

<http://aubethermostatmanual.com>

Golf course search by state

<http://golfingnear.com>

Email search by domain

<http://emailbydomain.com>

Auto manuals search

<http://auto.somanuals.com>

TV manuals search

<http://tv.somanuals.com>