

USER MANUAL



CONTENTS

1. SAFETY INFORMATION.....	2
2. SAFETY INSTRUCTIONS.....	4
3. PRODUCT DESCRIPTION.....	6
4. CONTROL PANEL.....	7
5. PROGRAMMES.....	7
6. SETTINGS.....	9
7. OPTIONS.....	12
8. BEFORE FIRST USE.....	13
9. DAILY USE.....	13
10. HINTS AND TIPS.....	16
11. CARE AND CLEANING.....	17
12. TROUBLESHOOTING.....	19
13. TECHNICAL INFORMATION.....	22
14. INSTALLATION.....	23
15. WARRANTY	24

FOR PERFECT RESULTS

Thank you for choosing this AEG product. We have created it to give you impeccable performance for many years, with innovative technologies that help make life simpler features you might not find on ordinary appliances. Please spend a few minutes reading to get the very best from it.

Visit our website for:



Get usage advice, brochures, trouble shooter, service information:
www.aeg.com/webselfservice



Register your product for better service:
www.registeraeg.com

CUSTOMER CARE AND SERVICE

Always use original spare parts.

When contacting our Authorised Service Centre, ensure that you have the following data available: Model, PNC, Serial Number.

The information can be found on the rating plate.

 Warning / Caution-Safety information

 General information and tips

 Environmental information

Subject to change without notice.

1. SAFETY INFORMATION

Before the installation and use of the appliance, carefully read the supplied instructions. The manufacturer is not responsible for any injuries or

damages that are the result of incorrect installation or usage. Always keep the instructions in a safe and accessible location for future reference.

1.1 Children and vulnerable people safety

- This appliance can be used by children aged from 8 years and above and persons with reduced physical, sensory or mental capabilities or lack of experience and knowledge if they have been given supervision or instruction concerning the use of the appliance in a safe way and understand the hazards involved.
- Do not let children play with the appliance.
- Keep detergents away from children.
- Keep children and pets away from the appliance when the door is open.
- Children shall not carry out cleaning and user maintenance of the appliance without supervision.

1.2 General Safety

- This appliance is intended to be used in household and similar applications such as:
 - farm houses; staff kitchen areas in shops, offices and other working environments;
 - by clients in hotels, motels, bed & breakfast and other residential type environments.
- Do not change the specification of this appliance.
- The operating water pressure (minimum and maximum) must be between 0.5 (50) / 8 (800) bar (kPa)
- Obey the maximum number of 14 place settings.
- If the supply cord is damaged, it must be replaced by the manufacturer, its Authorised Service Centre or a similarly qualified persons in order to avoid a hazard.
- Put knives and cutlery with sharp points in the cutlery basket with the points down or in a horizontal position.
- Do not keep the appliance door open without supervision to prevent to fall on it.

- Before any maintenance operation, deactivate the appliance and disconnect the mains plug from the socket.
- Do not use high pressure water sprays and/or steam to clean the appliance.
- The appliance is to be connected to the water mains using the new supplied hose-sets. Old hose sets must not be reused.
- The ventilation openings in the base (if applicable) must not be obstructed by a carpet.
- Some dishwasher detergents are strongly alkaline. They can be extremely dangerous if swallowed. Avoid contact with the skin and eyes and keep children away from the dishwasher when the door is open.
- Check that the detergent receptacle is empty after completion of the wash cycle.

2. SAFETY INSTRUCTIONS

2.1 Installation



WARNING!

Only a qualified person must install this appliance.

- Remove all the packaging.
- Do not install or use a damaged appliance.
- Do not install or use the appliance where the temperature is less than 0 °C.
- Follow the installation instruction supplied with the appliance.
- Always take care when moving the appliance as it is heavy. Always use safety gloves and enclosed footwear.
- Make sure that the appliance is installed below and adjacent to safe structures.
- Make sure that the parameters on the rating plate are compatible with the electrical ratings of the mains power supply.
- Always use a correctly installed shockproof socket.
- Do not use multi-plug adapters and extension cables.
- Make sure not to cause damage to the mains plug and to the mains cable. Should the mains cable need to be replaced, this must be carried out by our Authorised Service Centre.
- Connect the mains plug to the mains socket only at the end of the installation. Make sure that there is access to the mains plug after the installation.
- Do not pull the mains cable to disconnect the appliance. Always pull the mains plug.

2.2 Electrical connection



WARNING!

Risk of fire and electrical shock.

- The appliance must be earthed.

2.3 Water connection

- Do not cause damage to the water hoses.
- Before connection to new pipes, pipes not used for a long time, where repair work has been carried out or

new devices fitted (water meters, etc.), let the water flow until it is clean and clear.

- Ensure that there are no visible water leaks during and after the first use of the appliance.
- The water inlet hose has a safety valve and a sheath with an inner mains cable.

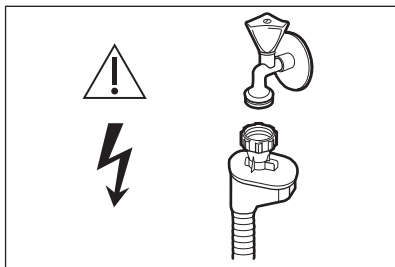

 **WARNING!**
Dangerous voltage.

- If the water inlet hose is damaged, immediately close the water tap and disconnect the mains plug from the mains socket. Contact the Authorised Service Centre to replace the water inlet hose.

2.4 Use

- Do not sit or stand on the open door.
- Dishwasher detergents are dangerous. Obey the safety instructions on the detergent packaging.
- Do not drink and play with the water in the appliance.
- Do not remove the dishes from the appliance until the programme is complete. Some detergent may remain on the dishes.
- The appliance can release hot steam if you open the door while a programme operates.

- Do not put flammable products or items that are wet with flammable products in, near or on the appliance.

2.5 Internal light

 **WARNING!**
Risk of injury.

- This appliance has an internal lamp that comes on when you open the door and goes off when the door is closed.
- The lamp in this appliance is not suitable for household room illumination.
- To replace the lamp, contact the Service.

2.6 Service

- Contact the Authorised Service Centre to repair the appliance. We recommend only the use of original spare parts.
- When you contact the Authorised Service Centre, ensure that you have the following information that is available on the rating plate.
Model :
PNC :
Serial Number :

2.7 Disposal

 **WARNING!**
Risk of injury or suffocation.

- Disconnect the appliance from the mains supply.
- Cut off the mains cable and discard it.
- Remove the door catch to prevent children and pets to get closed in the appliance.

3. PRODUCT DESCRIPTION

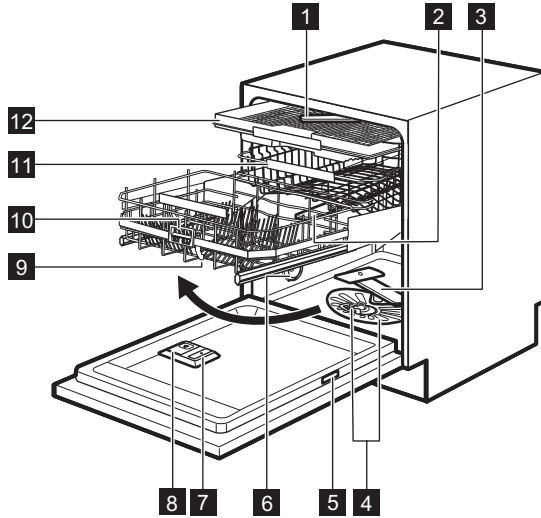

- | | |
|------------------------------|------------------------------|
| 1 Top spray arm | 8 Detergent dispenser |
| 2 Upper spray arm | 9 Comfort Lift basket |
| 3 Lower spray arm | 10 Release handle |
| 4 Filters | 11 Upper basket |
| 5 Rating plate | 12 Cutlery drawer |
| 6 Air vent | |
| 7 Rinse aid dispenser | |

3.1 TimeBeam

The TimeBeam is a display that is shown on the floor below the appliance door.

- When the programme starts, the programme duration comes on.
- When the programme is completed, **0:00** and **CLEAN** come on.
- When the delay start starts, the countdown duration and **DELAY** come on.
- When the appliance has a malfunction, an alarm code appears.

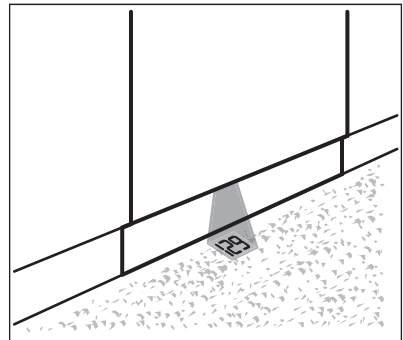

- i** When AirDry is activated during the drying phase, the projection on the floor may not be completely visible. To check the remaining time of the running programme, look at the control panel display.

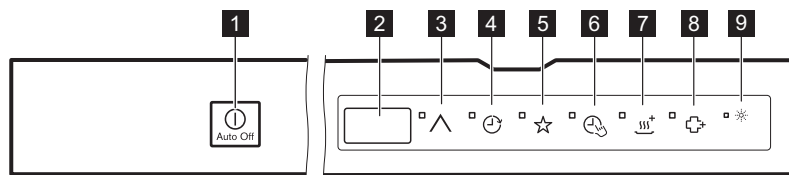

4. CONTROL PANEL



- 1** On/off button
- 2** Display
- 3** Program touchpad
- 4** Delay touchpad
- 5** MyFavourite touchpad
- 6** TimeSaver touchpad
- 7** XtraDry touchpad
- 8** ExtraHygiene touchpad
- 9** Indicators

5. PROGRAMMES

Programme	Degree of soil Type of load	Programme phases	Options
P1 ECO 1)	<ul style="list-style-type: none"> • Normal soil • Crockery and cutlery 	<ul style="list-style-type: none"> • Prewash • Wash 50 °C • Rinse • Dry 	<ul style="list-style-type: none"> • ExtraHygiene • TimeSaver • XtraDry
P2 AUTO SENSE 2)	<ul style="list-style-type: none"> • All • Crockery, cutlery, pots and pans 	<ul style="list-style-type: none"> • Prewash • Wash from 45 °C to 70 °C • Rinse • Dry 	<ul style="list-style-type: none"> • ExtraHygiene • XtraDry
P5 PRO ZONE 3)	<ul style="list-style-type: none"> • Mixed soil • Crockery, cutlery, pots and pans 	<ul style="list-style-type: none"> • Prewash • Wash 50 °C and 65 °C • Rinse • Dry 	<ul style="list-style-type: none"> • TimeSaver • XtraDry

Programme	Degree of soil Type of load	Programme phases	Options
P3 	<ul style="list-style-type: none"> • Heavy soil • Crockery, cutlery, pots and pans 	<ul style="list-style-type: none"> • Prewash • Wash 70 °C • Rinse • Dry 	<ul style="list-style-type: none"> • ExtraHygiene • XtraDry • TimeSaver
P6 	<ul style="list-style-type: none"> • Normal or light soil • Delicate crockery and glassware 	<ul style="list-style-type: none"> • Wash 45 °C • Rinse • Dry 	<ul style="list-style-type: none"> • XtraDry
P4 30 MIN 4)	<ul style="list-style-type: none"> • Fresh soil • Crockery and cutlery 	<ul style="list-style-type: none"> • Wash 60 °C • Rinse 	<ul style="list-style-type: none"> • ExtraHygiene • XtraDry
P8  5)	<ul style="list-style-type: none"> • All 	<ul style="list-style-type: none"> • Prewash 	
P7 SILENT 6)	<ul style="list-style-type: none"> • Normal soil • Crockery and cutlery 	<ul style="list-style-type: none"> • Prewash • Wash 50 °C • Rinse • Dry 	<ul style="list-style-type: none"> • XtraDry

1) With this programme, you have the most efficient use of water and energy consumption for crockery and cutlery with normal soil. This is the standard programme for test institutes.

2) The appliance senses the degree of soil and the quantity of items in the baskets. It automatically adjusts the temperature and the quantity of water, the energy consumption and the programme duration.

3) With this programme, you can wash a load with mixed soil. Very heavy soil in the lower basket, and normal soil in the upper basket. The pressure and the temperature of the water in the lower basket are higher than in the upper basket.



4) With this programme, you can wash a half-load dishwasher with fresh soil. It gives good washing results in a short time.

5) With this programme, you can quickly rinse dishes to prevent remains of food to bond on dishes and odours to form in the appliance. Do not use detergent with this programme.

6) This is the most silent programme. The pump works at a very low speed to decrease the level of noise. Because of the low speed, the programme duration is long.

5.1 Consumption values

Programme 1)	Water (l)	Energy (kWh)	Duration (min)
P1 ECO	12.5	0.78	138
P2 AUTO SENSE	7.0 - 14.0	0,9 - 1.6	90 - 160

Programme 1)	Water (l)	Energy (kWh)	Duration (min)
P5 PRO ZONE	14 - 16	1.2 - 1.5	160 - 180
P3 	12.5 - 14.5	1.4 - 1.7	170 - 190
P6 	12 - 14	0.7 - 0.9	82 - 92
P4 30 MIN	10.5	0.7	38
P8 	4	0.01	14
P7 SILENT	9.0 - 10.0	1.1 - 1.3	230 - 250

1) The pressure and the temperature of the water, the variations of the mains supply, the options and the quantity of dishes can change the values.

5.2 Information for test institutes

For all the necessary information for test performance, send an email to:

info.test@dishwasher-production.com

Write down the product number (PNC) that is on the rating plate.

6. SETTINGS

6.1 Programme selection mode and user mode

When the appliance is in programme selection mode it is possible to set a programme and to enter the user mode.

Settings available in the user mode:



- The activation or deactivation of the rinse aid empty notification.
- The level of rinse aid according to the required dosage.
- Selection of the colour of the TimeBeam.
- The activation or the deactivation of the option AirDry.

As the appliance stores the saved settings, there is no need to configure it before every cycle.

How to set the programme selection mode







The appliance is in programme selection mode when the display shows the programme number **P1**.

After activation, the appliance is in programme selection mode by default. If not, set the programme selection mode the following way:

Press and hold simultaneously  and  until the appliance is in programme selection mode.

How to enter user mode

Make sure the appliance is in programme selection mode.

To enter user mode, press and hold simultaneously  and  until the indicators , , ,  and  flash and the display is blank.

6.2 The rinse aid empty notification

The rinse aid helps to dry the dishes without streaks and stains.







The rinse aid is automatically released during the hot rinse phase.

When rinse aid chamber is empty, the rinse aid indicator is turned on notifying to refill rinse aid. If the drying results are satisfactory while using multi-tablets only, it is possible to deactivate the notification for refilling rinse aid. However, for best drying performance, always use rinse aid.

If standard detergent or multi-tablets without rinse aid are used, activate the notification to keep the rinse aid refill indicator active.

How to deactivate the rinse aid empty notification

Make sure the appliance is in user mode.

1. Press .
 - The indicators , ,  and  go off.
 - The indicator  still flashes.
 - The display shows the current setting: $! d$ = the rinse aid empty notification is activated (factory setting).
2. Press  to change the setting.
 $0 d$ = the rinse aid empty notification is deactivated.
3. Press the on/off button to confirm the setting.

6.3 The rinse aid dispenser

The rinse aid helps to dry the dishes without streaks and stains.







The rinse aid is automatically released during the hot rinse phase.

It is possible to set the released quantity of rinse aid between level 1 (minimum quantity) and level 6 (maximum quantity). Level 0 deactivates the rinse aid dispenser and no rinse aid is released.

Factory setting: level 4.

How to set the rinse aid level

Make sure the appliance is in user mode.

1. Press .
 - The indicators , ,  and  go off.
 - The indicator  still flashes.
 - The display shows the current setting: e.g. $4A$ = level 4.
 - The levels of rinse aid are from 0A to 6A where level 0A means rinse aid is not used.
2. Press  repeatedly to change the setting.
3. Press the on/off button to confirm the setting.







6.4 Acoustic signals

Acoustic signals sound when a malfunction of the appliance occurs. It is not possible to deactivate these acoustic signals.

There is also an acoustic signal that sounds when the programme is completed. By default this acoustic signal is deactivated but it is possible to activate it.

How to activate the acoustic signal for the end of programme

Make sure the appliance is in user mode.

1. Press .
 - The indicators , ,  and  go off.
 - The indicator  still flashes.
 - The display shows the current setting: $0b$ = Acoustic signal off.
2. Press  to change the setting.
 $1b$ = Acoustic signal on.









3. Press the on/off button to confirm the setting.

6.5 How to set the colour of the TimeBeam

The appliance must be in programme selection mode.

It is possible to change the colour of the TimeBeam to match the colour of the kitchen floor. There are several colours available. The TimeBeam can also be deactivated.

Make sure the appliance is in user mode.

1. Press .
 - The indicators , ,  and  go off.
 - The indicator  still flashes.
 - The display shows a number and letter C. Each number refers to a different colour.
 -  = TimeBeam deactivated.
2. Press  repeatedly to change the colour.
3. Press the on/off button to confirm the setting.

6.6 AirDry

AirDry improves the drying results with less energy consumption.

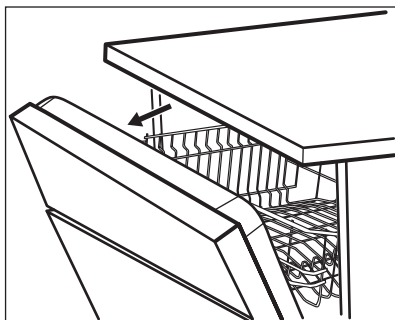

While the drying phase operates, a device opens the appliance door. The door is then kept ajar.



CAUTION!

Do not try to close the appliance door within 2 minutes after automatic open. This can cause damage to the appliance.



CAUTION!









In case of presence of children, the AirDry system can be deactivated if you want to keep the door closed in the end of the cycle.

AirDry is automatically activated with all programmes excluding .

To improve the drying performance refer to the XtraDry option or activate AirDry.

How to deactivate AirDry

Make sure the appliance is in user mode.

1. Press .
 - The indicators , ,  and  are off.
 - The indicator  still flashes.
 - The display shows the current setting:  = AirDry activated.
2. Press  to change the setting:  = AirDry deactivated.
3. Press on/off to confirm the setting.

6.7 MyFavourite

This option allows to set and save the most frequently used programme.

It is possible to save only 1 programme. A new setting cancels the previous one.

How to save the MyFavourite programme

1. Set the chosen programme. It is also possible to set applicable options together with the programme.
2. Press and hold  until the related indicator is on.

How to set the MyFavourite programme

Press ☆.

- The MyFavourite indicator is on.
- The display shows the number and the duration of the programme.

- If options are saved together with the programme, the indicators related to the options are on.

7. OPTIONS



Desired options must be activated every time before you start a programme. It is not possible to activate or deactivate options while a programme is running.



Not all options are compatible with each other. If you select non compatible options, the appliance automatically deactivates one or more of them. Only the indicators of the still active options are on.

7.1 XtraDry

Activate this option when you want to boost the drying performance. With use of this option, the duration of some programmes, water consumption and the last rinse temperature can be affected.

The XtraDry option is a permanent option for all programmes other than **ECO** and need not to be selected at every cycle.

Every time **ECO** is activated, XtraDry option is off and needs to be chosen manually. In other programmes, the setting of XtraDry is permanent and it is automatically used in next cycles. This configuration can be changed at any time.

Activating XtraDry option deactivates TimeSaver.

How to activate XtraDry

Press . The related indicator comes on.

If the option is not applicable to the programme, the related indicator does not appear or it flashes quickly for a few seconds and then goes off. The display shows the updated programme duration.

7.2 TimeSaver

The TimeSaver allows to reduce the duration of a selected programme by approximately 50%.

The washing results are the same as with the normal programme duration. The drying results can decrease.

This option increases the pressure and the temperature of the water. The washing and the drying phases are shorter.

By default, TimeSaver is off, but it is possible to activate it manually. This option cannot be combined with XtraDry.

How to activate TimeSaver

Press , the related indicator comes on. If the option is not applicable to the programme, the related indicator does not come on or it flashes quickly for a few seconds and then goes off. The display shows the updated programme duration.

7.3 ExtraHygiene

This option provides better hygiene results by keeping the temperature at 70

°C for at least 10 minutes during the last rinsing phase.

How to activate ExtraHygiene

Press , the related indicator comes on

If the option is not applicable to the programme, the related indicator does not come on or it flashes quickly for a few seconds and then goes out. The display shows the updated programme duration.

8. BEFORE FIRST USE

1. Fill the rinse aid dispenser.
2. Open the water tap.
3. Start a program to remove any processing residuals that can still be inside the appliance. Do not use detergent and do not load the baskets.

8.1 How to fill the rinse aid dispenser

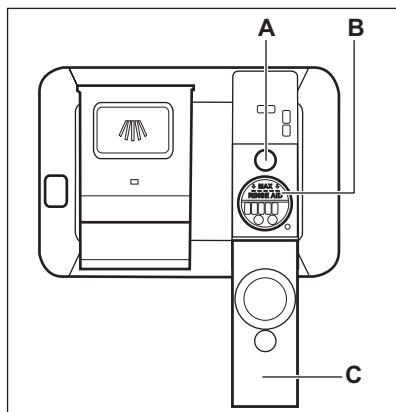

CAUTION!

Only use rinse aid specifically designed for dishwashers.

1. Open the lid (C).
2. Fill the dispenser (B) until the rinse aid reaches the marking "MAX".
3. Remove the spilled rinse aid with an absorbent cloth to prevent too much foam.
4. Close the lid. Make sure that the lid locks into position.



Fill the rinse aid dispenser when the indicator (A) becomes clear.



If you use multi-tablets and the drying performance is satisfactory, the rinse aid refill indication can be disabled.

We recommend to always use rinse aid for better drying performance, also in combination with multi-tablets containing rinsing agent.

9. DAILY USE

1. Open the water tap.
2. Press the on/off button to activate the appliance.
Make sure that the appliance is in programme selection mode.
 - If the rinse aid empty message is shown fill the rinse aid dispenser.
3. Load the baskets.
4. Add the detergent.

5. Set and start the correct programme for the type of load and the degree of soil.

9.1 Comfort Lift



CAUTION!

Do not sit on the rack. Do not put excessive pressure on the locked basket.



CAUTION!

Do not exceed the max load capacity of 18 kg.



CAUTION!

Use only a detergent specifically designed for dishwashers.



To ensure correct unlocking, lift the release handle completely and the basket slightly until the basket is disengaged on both sides.

The Comfort Lift mechanism allows to lift the lower rack up (to the second rack level) and put it down to load and unload dishes easily.

To move the lower basket from the lower position:

1. To lift the basket pull the rack out of the dishwasher by the rack handle. The release handle should not be used.

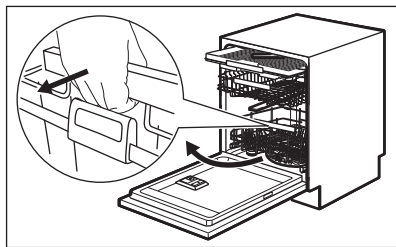

The basket is automatically locked on the upper level. Load or unload the basket carefully (refer to basket loading leaflet).

2. To lower the basket connect the release handle with the basket frame as shown below. Lift the release handle and the rack up.

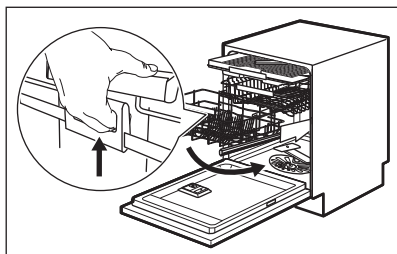

Once the release handle is lifted, push the rack down. The mechanism returns to its basic position on the lower level.

There are two ways of lowering the basket depending on the loading:

- If there is a full load of plates slightly push the basket down.
- If the basket is empty or half-loaded press the basket down.

9.2 Using the detergent

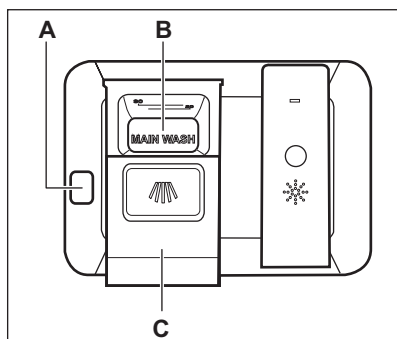

CAUTION!

Only use detergent specifically designed for dishwashers.

1. Press the release button (A) to open the lid (C).
2. Put the detergent, in powder or tablets, in the compartment (B).
3. If the programme has a prewash phase, put a small quantity of detergent on the inner part of the appliance door.
4. Close the lid. Make sure that the lid locks into position.

9.3 Setting and starting a programme



The Auto Off function

This function decreases energy consumption by deactivating automatically the appliance when it is not operating.

The function comes into operation:

- 5 minutes after the completion of the programme.
- After 5 minutes if the programme has not started.

Starting a programme

1. Keep the appliance door ajar.
2. Press the on/off button to activate the appliance. Make sure that the appliance is in programme selection mode.
3. Press repeatedly  until the display shows the number of the programme you want to start. The display will show the programme number for approximately 3 seconds and then show the programme duration.
 - If you want to select the MyFavourite programme, press .
 - The indicators of the options related to the MyFavourite programme come on.
4. Set the applicable options.
5. Close the appliance door to start the programme.

Starting a programme with delay start

1. Set a programme.
2. Press  again and again until the display shows the delay time you want to set (from 1 to 24 hours).

The delay indicator comes on.

3. Close the appliance door to start the countdown.

While a countdown is running it is possible to increase the delay time but not to change the selection of the programme and options.

When the countdown is completed, the programme starts.

Opening the door while the appliance operates

If you open the door while a programme is running, the appliance stops. It may affect the energy consumption and the programme duration. When you close the door, the appliance continues from the point of interruption.



If the door is opened for more than 30 seconds during the drying phase, the running programme will end. This will not happen if the door is opened by AirDry.





CAUTION!



Do not try to close the appliance door within 2 minutes after AirDry automatically opens it, as this may cause damage to the appliance. If, afterwards, the door is closed for another 3 minutes, the running programme ends.

Cancelling the delay start while the countdown operates

When you cancel the delay start you have to set the programme and options again.

Press and hold simultaneously  and  until the appliance is in programme selection mode.

Cancelling the programme

Press and hold simultaneously  and  until the appliance is in programme selection mode.

Make sure that there is detergent in the detergent dispenser before you start a new programme.

End of programme

When the programme is completed and you open the door, the appliance is automatically deactivated.

Close the water tap.

10. HINTS AND TIPS

10.1 General

The following hints will ensure optimal cleaning and drying results in daily use and also help to protect the environment.

- Remove larger residues of food from the dishes into the waste bin.
- Do not pre-rinse dishes by hand. When needed, use the prewash programme (if available) or select a programme with a prewash phase.
- Always use the whole space of the baskets.
- When loading the appliance, make sure that the dishes can be completely reached and washed by the water released from the spray arm nozzles. Make sure that items do not touch or cover each other.
- You can use dishwasher detergent and rinse aid separately or you can use the multi-tablets. Follow the instructions written on the packaging.
- Select the programme according to the type of load and degree of soil. With the ECO programme you have the most efficient use of water and energy consumption for crockery and cutlery with normal soil.

10.2 Using rinse aid and detergent

- Only use rinse aid and detergent for dishwasher. Other products can cause damage to the appliance.
- Detergent tablets do not fully dissolve with short programs. To prevent detergent residues on the tableware, we recommend that you use the tablets with long programs.
- Do not use more than the correct quantity of detergent. Refer to the instructions on the detergent packaging.

10.3 Loading the baskets

- Only use the appliance to wash items that are dishwasher-safe.
- Do not put in the appliance items made of wood, horn, aluminium, pewter and copper.
- Do not put in the appliance items that can absorb water (sponges, household cloths).
- Remove remaining food from the items.
- Make soft the remaining burned food on the items.
- Put hollow items (cups, glasses and pans) with the opening down.
- Make sure that cutlery and dishes do not bond together. Mix spoons with other cutlery.
- Make sure that glasses do not touch other glasses.
- Put small items in the cutlery basket.
- Put light items in the upper basket. Make sure that the items do not move.
- Make sure that the spray arm can move freely before you start a programme.

10.4 Before starting a programme

Make sure that:

- The filters are clean and correctly installed.
- The spray arms are not clogged.
- There is dishwasher rinse aid (unless you use multi-tablets).
- The position of the items in the baskets is correct.
- The programme is applicable for the type of load and for the degree of soil.
- The correct quantity of detergent is used.

10.5 Unloading the baskets

1. For improved drying results with the most efficient use of energy select the AirDry option, otherwise open the door by approximately 10cm at the end of the program.
2. Allow the tableware to cool for 30 - 40 minutes.
3. Hot items can be easily damaged, allow them to cool down before removing from appliance.

4. First remove items from the lower basket then the upper basket.



At the end of the program water can still remain on the sides and on the door of the appliance.

11. CARE AND CLEANING



WARNING!

Before maintenance, deactivate the appliance and disconnect the mains plug from the main socket.



Dirty filters and clogged spray arms decrease the washing results. Make a check regularly and, if necessary, clean them.

11.1 Cleaning the filters

The filter system is made of 3 parts.

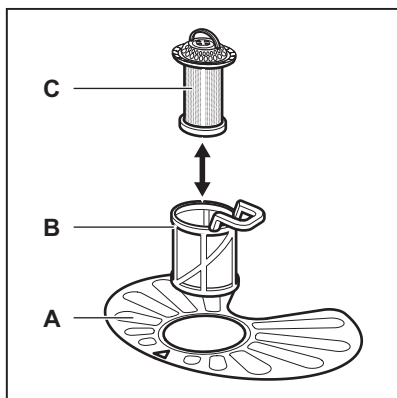

1. Turn the filter (B) counterclockwise and remove it.

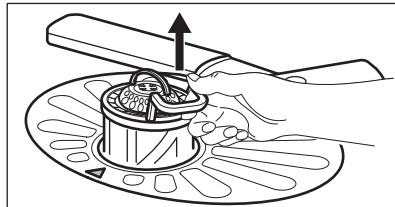
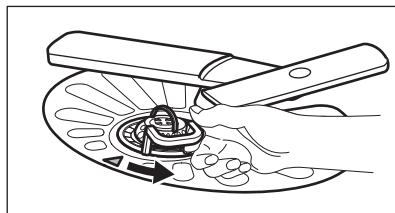

2. Remove the filter (C) out of filter (B).
3. Remove the flat filter (A).

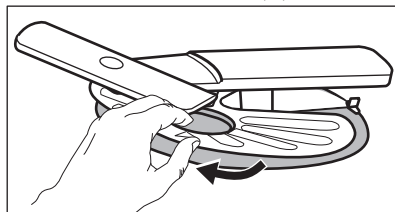

4. Wash the filters.

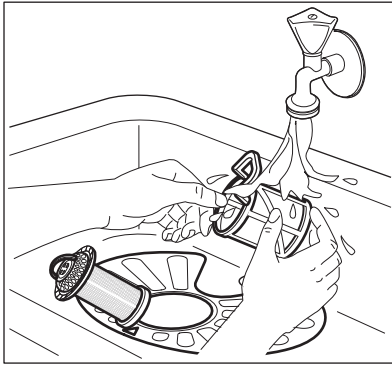

5. Make sure that there are no residues of food or soil in or around the edge of the sump.
6. Put back in place the flat filter (A). Make sure that it is correctly positioned under the 2 guides.

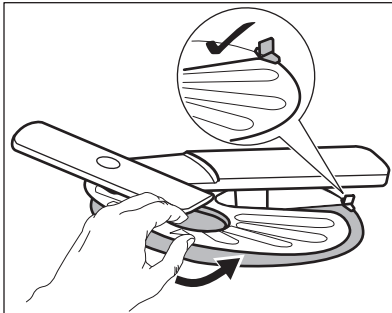

7. Reassemble the filters (B) and (C).
8. Put back the filter (B) in the flat filter (A). Turn it clockwise until it locks.

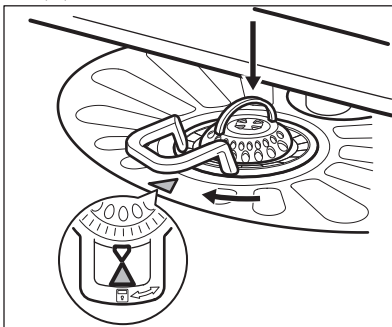

CAUTION!

An incorrect position of the filters can cause bad washing results and damage to the appliance.

11.2 Cleaning the upper spray arm

We recommend to clean regularly the upper spray arm to avoid soil to clog the holes.

Clogged holes can cause unsatisfactory washing results.

1. Pull out the upper basket.
2. To disengage the spray arm from the basket, press the spray arm upwards in the direction indicated by the lower arrow and simultaneously turn it clockwise.

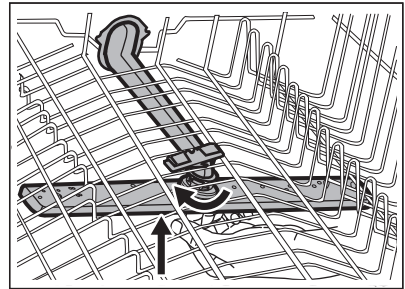

3. Wash the spray arm under running water. Use a thin pointed tool, e.g. toothpick, to remove particles of soil from the holes.

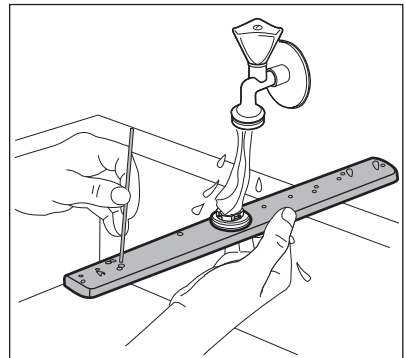

4. To engage again the spray arm to the basket, press the spray arm upwards in the direction indicated by the lower arrow and simultaneously turn it counterclockwise until it locks into place.

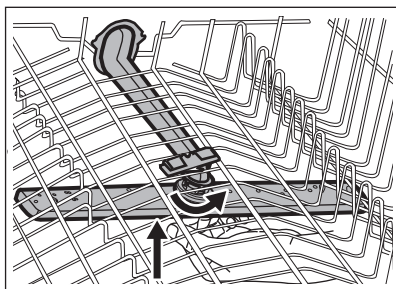

11.3 External cleaning

- Clean the appliance with a moist soft cloth.
- Only use neutral detergents.
- Do not use abrasive products, abrasive cleaning pads or solvents.

11.4 Internal cleaning

- Carefully clean the appliance, including the rubber gasket of the door, with a soft damp cloth.

- Do not use abrasive products, abrasive cleaning pads, sharp tools, strong chemicals, scourer or solvents.
- If you use short duration programmes regularly, these can leave deposits of grease and limescale inside the appliance. To prevent this, we recommend running long duration programmes at least twice a month.
- To maintain the performance of your appliance at its best, we recommend using a specific cleaning product for dishwashers (at least once a month). Follow carefully the instructions on the packaging of the product.

12. TROUBLESHOOTING

If the appliance does not start or it stops during operation. Before you contact an Authorised Service Centre, check if you can solve the problem by yourself with the help of the information in the table.



WARNING!

Repairs not properly done may result in serious risk to the safety of the user. Any repairs must be performed by qualified personnel.

With some problems, the display shows an alarm code.

The majority of problems that can occur can be solved without the need to contact an Authorised Service Centre.

Problem and alarm code	Possible solution
You cannot activate the appliance.	<ul style="list-style-type: none"> • Make sure that the mains plug is connected to the mains socket. • Make sure that there is no damaged fuse in the fuse box.
The programme does not start.	<ul style="list-style-type: none"> • Make sure that the appliance door is closed. • If the delay start is set, cancel the setting or wait for the end of the countdown.

Problem and alarm code	Possible solution
<p>The appliance does not fill with water.</p> <p>The display shows <i>10</i> or <i>11</i>.</p>	<ul style="list-style-type: none"> • Make sure that the water tap is open. • Make sure that the pressure of the water supply is not too low. For this information, contact your local water authority. • Make sure that the water tap is not clogged. • Make sure that the filter in the inlet hose is not clogged. • Make sure that the inlet hose has no kinks or bends.
<p>The appliance does not drain the water.</p> <p>The display shows <i>20</i>.</p>	<ul style="list-style-type: none"> • Make sure that the sink spigot is not clogged. • Make sure that the drain hose has no kinks or bends.
<p>The anti-flood device is on.</p> <p>The display shows <i>30</i>.</p>	<ul style="list-style-type: none"> • Close the water tap and contact an Authorised Service Centre.
<p>The appliance stops and starts more times during operation.</p>	<ul style="list-style-type: none"> • It is normal. It provides optimal cleaning results and energy savings.
<p>The program lasts too long.</p>	<ul style="list-style-type: none"> • Select the TimeSaver option to shorten the program time (if applicable). • If the delayed start option is set, cancel the delay setting or wait for the end of the countdown.
<p>The remaining time in the display increases and skips nearly to the end of program time.</p>	<ul style="list-style-type: none"> • This is not a defect. The appliance is working correctly.
<p>The options of the program have to be set again every time.</p>	<ul style="list-style-type: none"> • To save your favourite configuration use option MyFavourite.
<p>Small leak from the appliance door.</p>	<ul style="list-style-type: none"> • The appliance is not levelled. Loosen or tighten the adjustable feet (if applicable). • The appliance door is not centred on the tub. Adjust the rear foot (if applicable).
<p>The appliance door is difficult to close.</p>	<ul style="list-style-type: none"> • The appliance is not levelled. Loosen or tighten the adjustable feet (if applicable). • Parts of the tableware are protruding from the baskets.
<p>Rattling/knocking sounds from inside the appliance.</p>	<ul style="list-style-type: none"> • The tableware is not properly arranged in the baskets. Refer to basket loading leaflet. • Make sure that the spray arms can rotate freely.
<p>The appliance trips the circuit-breaker.</p>	<ul style="list-style-type: none"> • The amperage is insufficient to supply simultaneously all the appliances in use. Check the socket amperage and the capacity of the meter or turn off one of the appliances in use. • Internal electrical fault of the appliance. Contact an Authorised Service Centre.



Refer to "**Before first use**", "**Daily use**", or "**Hints and tips**" for other possible causes.

the problem occurs again, contact an Authorised Service Centre.

For alarm codes not described in the table, contact an Authorised Service Centre.

Once you have checked the appliance, deactivate and activate the appliance. If

12.1 The washing and drying results are not satisfactory

Problem	Possible cause and solution
Poor washing results.	<ul style="list-style-type: none"> Refer to "Daily use", "Hints and tips" and basket loading leaflet. Use more intensive washing programmes. Clean spray arm jets and filter. Refer to "Care and Cleaning".
Poor drying results.	<ul style="list-style-type: none"> Tableware has been left for too long inside a closed appliance. There is no rinse aid or the dosage of rinse aid is not enough. Set the rinse aid dispenser to a higher level. Plastic items may need to be towel dried. For the best drying performance activate the option XtraDry and set AirDry. We recommend to always use rinse aid, even in combination with multi-tablets.
There are whitish streaks or bluish layers on glasses and dishes.	<ul style="list-style-type: none"> The release quantity of rinse aid is too much. Adjust the rinse aid level to a lower level. The quantity of detergent is too much.
There are stains and dry water drops on glasses and dishes.	<ul style="list-style-type: none"> The released quantity of rinse aid is not sufficient. Adjust the rinse aid level to a higher level. The quality of the rinse aid can be the cause.
The dishes are wet.	<ul style="list-style-type: none"> For the best drying performance activate the option XtraDry and set AirDry . The programme does not have a drying phase or has a drying phase with low temperature. The rinse aid dispenser is empty. The quality of the rinse aid can be the cause. The quality of the multi-tablets can be the cause. Try a different brand or activate the rinse aid dispenser and use rinse aid and multi-tablets together.
The interior of the appliance is wet.	<ul style="list-style-type: none"> This is not a defect of the appliance. it is caused by the humidity in the air that condenses on the walls.
Unusual foam during washing.	<ul style="list-style-type: none"> Use the detergent for dishwashers only. There is a leak in the rinse aid dispenser. Contact an Authorised Service Centre.

Problem	Possible cause and solution
Traces of rust on cutlery.	<ul style="list-style-type: none"> • Silver and stainless steel cutlery were placed together. Avoid to put silver and stainless steel items close together.
There are residues of detergent in the dispenser at the end of the programme.	<ul style="list-style-type: none"> • The detergent tablet got stuck in the dispenser and therefore was not completely washed away by water. • Water cannot wash away the detergent from the dispenser. Make sure that the spray arm is not blocked or clogged. • Make sure that items in the baskets do not impede the lid of the detergent dispenser from opening.
Odours inside the appliance.	<ul style="list-style-type: none"> • Refer to "Internal cleaning".
Limescale deposits on the tub and on the inside of the door.	<ul style="list-style-type: none"> • Clean the appliance with appliance cleaners which are particularly suitable for this purpose. • Try different detergent. • Contact the detergent manufacturer.
Dull, discoloured or chipped tableware.	<ul style="list-style-type: none"> • Make sure that only dishwasher-safe items are washed in the appliance. • Load and unload the basket carefully. Refer to basket loading leaflet. • Place delicate items in the upper basket.



Refer to "**Before first use**", "**Daily use**" or "**Hints and tips**" for other possible causes.

13. TECHNICAL INFORMATION

Dimensions	Width / height / depth (mm)	596/ 818 - 878 / 570
Electrical connection ¹⁾	Voltage (V)	200 - 240
	Frequency (Hz)	50 / 60
	Wattage (W)	1550-2200
Water supply pressure	bar (minimum and maximum)	0.5 - 8
	kPa (minimum and maximum)	50 - 800
Water supply	Cold water or hot water ²⁾	max 60 °C
Capacity	Place settings	14

¹⁾ Refer to the rating plate for other values.

²⁾ If the hot water comes from alternative source of energy, (e.g. solar panels, aeolian energy), use the hot water supply to decrease energy consumption.

14. INSTALLATION

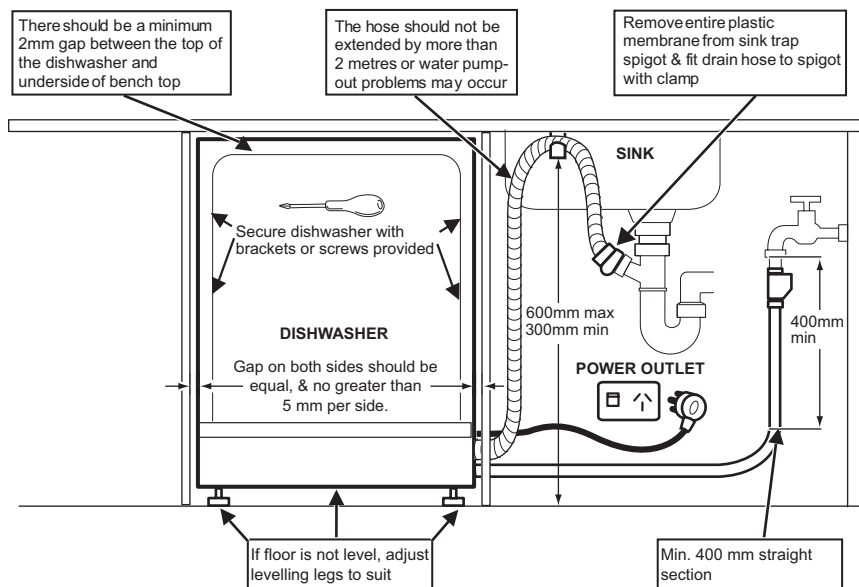

Install the appliance under a kitchen counter.

Put the appliance adjacent to a water tap and a water drain.

For the venting of the appliance only water hoses and mains cable openings are necessary.

14.1 Adjusting the level of the appliance

A correct adjustment of the level of the appliance allows the door to close and seal correctly.

If the door does not close correctly, loosen or tighten the adjustable feet to level the appliance.

14.2 Water inlet hose

Connect the inlet hose to a water tap with an external BSP thread spout of 3/4".

For best washing performance it is recommended to connect the appliance to a cold water supply.

Energy savings can be made by connecting the appliance to a Solar water system and using economy options, however the water temperature must not exceed 60° C.

Inlet water supply

- Water pressure: 800 kPa max - 50 kPa min.
- Water flow rate 10 L / minute min.
- If water pressure is in excess of 800 kPa, a pressure reducing valve should be used. Check for leaks.
- If water temperature is in excess of 60° C, a tempering valve should be used. Check for leaks.



CAUTION!

Always use new hoses when you connect the appliance to the water mains. Old hoses must not be used. The water inlet hose must be examined at an interval of twelve months for deterioration and replaced if necessary.

The water pressure must be in the limits indicated in the chapter "TECHNICAL INFORMATION". Make sure that the local water authority gives you the average mains pressure in your area.

In order to pass the safety valve through the kitchen cabinets, an opening of at least 45 mm x 90 mm is needed.

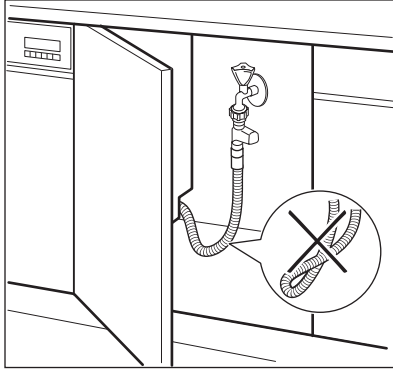

14.3 Water drain hose

The highest point of the drain hose must be no more than 600 mm from the floor and must have a continuous fall to the plumbing connection.

The drain hose can be lengthened using additional lengths and connectors. These must be purchased from Electrolux Spare

Parts. The extension length must not exceed 2 metres.

The drain hose must be free of obstructions.

Remove the sink plug when the appliance drains the water to prevent that the water goes back into the appliance.

The appliance has a security feature to prevent dirty water going back into the appliance. If the spigot of the sink has a non-return valve, this valve can cause the appliance to drain incorrectly. remove the non-return valve.

If you connect the water drain hose to a trap spigot under the sink, remove the plastic membrane. If you do not remove the membrane, remaining food can cause a blockage in the drain hose spigot.

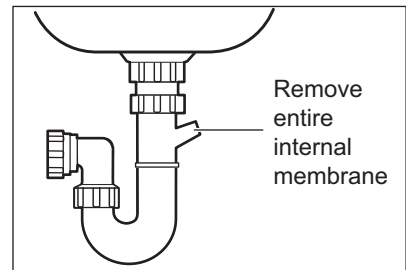

15. WARRANTY

FOR SALES IN AUSTRALIA AND NEW ZEALAND

ALL AEG BRANDED APPLIANCES

This document sets out the terms and conditions of the product warranties for AEG Appliances. It is an important document. Please keep it with your proof of purchase documents in a safe place for future reference should you require service for your Appliance.

1. In this warranty
 - a) 'acceptable quality' as referred to in clause 10 of this warranty has the same meaning referred to in the ACL;

- b) 'ACL' means Schedule 2 to the Competition and Consumer Act 2010;
- c) 'Appliance' means any AEG product purchased by you and accompanied by this document;
- d) 'ASC' means AEG authorised service centres;
- e) AEG is the brand controlled by Electrolux Home Products Pty Ltd of 163 O'Riordan Street, Mascot NSW 2020, ABN 51 004 762 341 in respect of Appliances purchased in Australia and Electrolux (NZ) Limited (collectively 'Electrolux') of 3-5 Niall Burgess Road, Mount Wellington, in respect of

- Appliances purchased in New Zealand;
- f) 'major failure' as referred to in clause 10 of this warranty has the same meaning referred to in the ACL and includes a situation when an Appliance cannot be repaired or it is uneconomic for Electrolux, at its discretion, to repair an Appliance during the Warranty Period;
 - g) 'Warranty Period' means the Appliance is warranted against manufacturing defects in Australia and New Zealand for 60 months, following the date of original purchase of the Appliance;
 - h) 'you' means the purchaser of the Appliance not having purchased the Appliance for re-sale, and 'your' has a corresponding meaning.
2. This warranty only applies to Appliances purchased and used in Australia or New Zealand in normal domestic applications and is in addition to (and does not exclude, restrict, or modify in any way) any non-excludable statutory warranties in Australia or New Zealand.
 3. During the Warranty Period Electrolux or its ASC will, at no extra charge if your Appliance is readily accessible for service, without special equipment and subject to these terms and conditions, repair or replace any parts which it considers to be defective. Electrolux or its ASC may use remanufactured parts to repair your Appliance. You agree that any replaced Appliances or parts become the property of Electrolux. This warranty does not apply to light globes, batteries, filters or similar perishable parts.
 4. Parts and Appliances not supplied by Electrolux are not covered by this warranty.
 5. To the extent permitted by law, you will bear the cost of transportation, travel and delivery of the Appliance to and from Electrolux or its ASC. If you reside outside of the service area, you will bear the cost of:
 - a) travel of an authorised representative;
 - b) transportation and delivery of the Appliance to and from Electrolux or its ASC.

In all instances, unless the Appliance is transported by Electrolux or an AEG authorised representative, the Appliance is transported at the owner's cost and risk while in transit to and from Electrolux or its ASC.
 6. Proof of purchase is required before you can make a claim under this warranty.
 7. You may not make a claim under this warranty unless the defect claimed is due to faulty or defective parts or workmanship. Electrolux is not liable in the following situations (which are not exhaustive):
 - a) the Appliance is damaged by:
 - accident
 - misuse or abuse, including failure to properly maintain or service
 - normal wear and tear
 - power surges, electrical storm damage or incorrect power supply
 - incomplete or improper installation
 - incorrect, improper or inappropriate operation
 - insect or vermin infestation
 - failure to comply with any additional instructions supplied with the Appliance;
 - b) the Appliance is modified without authority from Electrolux in writing;
 - c) the Appliance's serial number or warranty seal has been removed or defaced;
 - d) the Appliance was serviced or repaired by anyone other than Electrolux, an authorised repairer or ASC.
 8. This warranty, the contract to which it relates and the relationship between you and Electrolux are governed by the law applicable where the Appliance was purchased. Where the Appliance was purchased in New Zealand for commercial purposes the Consumer Guarantee Act does not apply.

9. To the extent permitted by law and subject to your non-excludable statutory rights and warranties, AEG excludes all warranties and liabilities (other than as contained in this document) including liability for any loss or damage whether direct or indirect arising from your purchase, use or non use of the Appliance.
10. For AEG Appliances and services in Australia, the Appliances come with a guarantee that cannot be excluded under the ACL. You are entitled to a replacement or refund for a major failure and for compensation for any other reasonably foreseeable loss or damage. You are also entitled to have the Appliance repaired or replaced if the Appliance fails to be of acceptable quality and the failure does not amount to a major failure. The benefits to you given by this warranty are in addition to your other rights and remedies under a law in relation to the Appliances or services to which the warranty relates.
11. At all times during the Warranty Period, Electrolux shall, at its discretion, determine whether repair, replacement or refund will apply if an Appliance has a valid warranty claim applicable to it.
12. For Appliances and services provided in New Zealand, the Appliances come with a guarantee pursuant to the provisions of the Consumer Guarantees Act, the Sale of Goods Act and the Fair Trading Act.
13. To enquire about claiming under this warranty, please follow these steps:
- carefully check the operating instructions, user manual and the terms of this warranty;
 - have the model and serial number of the Appliance available;
 - have the proof of purchase (e.g. an invoice) available;
 - telephone the numbers shown below.
14. You accept that if you make a warranty claim, Electrolux and its ASC may exchange information in relation to you to enable Electrolux to meet its obligations under this warranty.

Important Notice

Before calling for service, please ensure that the steps listed in clause 13 above have been followed.

AEG SERVICE AUSTRALIA

www.aeg.com/au

FOR SERVICE

or to find the address of your nearest state service centre in Australia

PLEASE CALL 1300 363 664

OR EMAIL customercare@aegaustralia.com.au

For the cost of a local call (Australia only)

FOR SPARE PARTS

or to find the address of your nearest state spare parts centre in Australia

PLEASE CALL 13 13 50

OR EMAIL customercare@aegaustralia.com.au

For the cost of a local call (Australia only)

AEG SERVICE NEW ZEALAND

www.aeg.co.nz

FOR SERVICE

or to find the address of your nearest authorised service centre in New Zealand

FREE CALL 0800 10 66 10

OR EMAIL customer care@electrolux.co.nz

(New Zealand only)

FOR SPARE PARTS

or to find the address of your nearest state spare parts centre in New Zealand

FREE CALL 0800 10 66 20

OR EMAIL customer care@electrolux.co.nz

(New Zealand only)

16. ENVIRONMENTAL CONCERNS

Recycle materials with the symbol .
Put the packaging in relevant containers to recycle it. Help protect the environment and human health by recycling waste of electrical and electronic appliances. Do not dispose of

appliances marked with the symbol  with the household waste. Return the product to your local recycling facility or contact your municipal office.

This document sets out the terms and conditions of the product warranties for AEG Appliances. It is an important document. Please keep it with your proof of purchase documents in a safe place for future reference should there be a manufacturing defect in your Appliance. This warranty is in addition to other rights you may have under the Australian Consumer Law.

1. In this warranty:

- (a) 'ACL' or 'Australian Consumer Law' means Schedule 2 to the Competition and Consumer Act 2010;
- (b) 'Appliance' means any Electrolux product purchased by you and accompanied by this document;
- (c) 'ASC' means Electrolux's authorised serviced centres;
- (d) 'AEG' is the brand controlled by Electrolux Home Products Pty Ltd of 163 O'Riordan Street, Mascot NSW 2020, ABN 51 004 762 341 in respect of Appliances purchased in Australia and Electrolux (NZ) Limited (collectively "Electrolux") of 3-5 Niall Burgess Road, Mount Wellington, in respect of Appliances purchased in New Zealand;
- (e) 'Warranty Period' means the period specified in clause 3 of this warranty;
- (f) 'you' means the purchaser of the Appliance not having purchased the Appliance for re-sale, and 'your' has a corresponding meaning.

2. Application: This warranty only applies to new Appliances, purchased and used in Australia or New Zealand and is in addition to (and does not exclude, restrict, or modify in any way) other rights and remedies under a law to which the Appliances or services relate, including any non-excludable statutory guarantees in Australia and New Zealand.

3. Warranty Period: Subject to these terms and conditions, this warranty continues for in Australia for a period of 60 months and in New Zealand for a period of 60 months, following the date of original purchase of the Appliance.

4. Repair or replace warranty: During the Warranty Period, Electrolux or its ASC will, at no extra charge if your Appliance is readily accessible for service, without special equipment and subject to these terms and conditions, repair or replace any parts which it considers to be defective. Electrolux may, in its absolute discretion, choose whether the remedy offered for a valid warranty claim is repair or replacement. Electrolux or its ASC may use refurbished parts to repair your Appliance. You agree that any replaced Appliances or parts become the property of Electrolux.

5. Travel and transportation costs: Subject to clause 7, Electrolux will bear the reasonable cost of transportation, travel and delivery of the Appliance to and from Electrolux or its ASC. Travel and transportation will be arranged by Electrolux as part of any valid warranty claim.

6. Proof of purchase is required before you can make a claim under this warranty.

7. Exclusions: You may not make a claim under this warranty unless the defect claimed is due to faulty or defective parts or workmanship. This warranty does not cover:

- (a) light globes, batteries, filters or similar perishable parts;
- (b) parts and Appliances not supplied by Electrolux;

- (c) cosmetic damage which does not affect the operation of the Appliance;
- (d) damage to the Appliance caused by:
 - (i) negligence or accident;
 - (ii) misuse or abuse, including failure to properly maintain or service;
 - (iii) improper, negligent or faulty servicing or repair works done by anyone other than an Electrolux authorised repairer or ASC;
 - (iv) normal wear and tear;
 - (v) power surges, electrical storm damage or incorrect power supply;
 - (vi) incomplete or improper installation;
 - (vii) incorrect, improper or inappropriate operation;
 - (viii) insect or vermin infestation;
 - (ix) failure to comply with any additional instructions supplied with the Appliance;

In addition, Electrolux is not liable under this warranty if:

- (a) the Appliance has been, or Electrolux reasonably believes that the Appliance has been, used for purposes other than those for which the Appliance was intended, including where the Appliance has been used for any non-domestic purpose;
- (b) the Appliance is modified without authority from Electrolux in writing;
- (c) the Appliance's serial number or warranty seal has been removed or defaced.

8. How to claim under this warranty: To enquire about claiming under this warranty, please follow these steps:

- (a) carefully check the operating instructions, user manual and the terms of this warranty;
- (b) have the model and serial number of the Appliance available;
- (c) have the proof of purchase (e.g. an invoice) available;
- (d) telephone the numbers shown below.

9. Australia: For Appliances and services provided by Electrolux in Australia: Electrolux goods come with guarantees that cannot be excluded under the Australian Consumer Law. You are entitled to a replacement or refund for a major failure and for compensation for any other reasonably foreseeable loss or damage. You are also entitled to have the Appliance repaired or replaced if the Appliance fails to be of acceptable quality and the failure does not amount to a major failure. 'Acceptable quality' and 'major failure' have the same meaning as referred to in the ACL.

10. New Zealand: For Appliances and services provided by Electrolux in New Zealand, the Appliances come with a guarantee by Electrolux pursuant to the provisions of the Consumer Guarantees Act, the Sale of Goods Act and the Fair Trading Act. Where the Appliance was purchased in New Zealand for commercial purposes the Consumer Guarantee Act does not apply.

11. Confidentiality: You accept that if you make a warranty claim, Electrolux and its agents including ASC may exchange information in relation to you to enable Electrolux to meet its obligations under this warranty.

Important Notice

Before calling for service, please ensure that the steps listed in clause 8 above have been followed.

<p>FOR SERVICE or to find the address of your nearest authorised service centre in Australia PLEASE CALL 1300 363 664 OR EMAIL customercare@aegaustralia.com.au For the cost of a local call (Australia only)</p>	<p>SERVICE AUSTRALIA  aeg.com/au</p>	<p>FOR SPARE PARTS or to find the address of your nearest spare parts centre in Australia PLEASE 13 13 50 OR EMAIL customercare@aegaustralia.com.au For the cost of a local call (Australia only)</p>
<p>FOR SERVICE or to find the address of your nearest authorised service centre in New Zealand PLEASE CALL 0800 234 234 OR EMAIL customercare@electrolux.co.nz (New Zealand only)</p>	<p>SERVICE NEW ZEALAND  aegnewzealand.co.nz</p>	<p>FOR SPARE PARTS or to find the address of your nearest spare parts centre in New Zealand PLEASE 0800 10 66 20 OR EMAIL customercare@electrolux.co.nz (New Zealand only)</p>



Free Manuals Download Website

<http://myh66.com>

<http://usermanuals.us>

<http://www.somanuals.com>

<http://www.4manuals.cc>

<http://www.manual-lib.com>

<http://www.404manual.com>

<http://www.luxmanual.com>

<http://aubethermostatmanual.com>

Golf course search by state

<http://golfingnear.com>

Email search by domain

<http://emailbydomain.com>

Auto manuals search

<http://auto.somanuals.com>

TV manuals search

<http://tv.somanuals.com>