

acer

User Guide



Connected
by AT&T



ICONIA TAB

A501

© 2011. All Rights Reserved.

Acer ICONIA TAB User Guide

Model: A501

First issue: 09/2011

Acer ICONIA TAB

Model number: _____

Serial number: _____

Date of purchase: _____

Place of purchase: _____

Table of contents

Getting to know your tablet

Features and functions	5
Product registration	5

Setting up

Unpacking your tablet	6
Getting to know your tablet	6
Using the SIM card slot	8

Using your tablet

Charging your tablet	9
Turning on for the first time	10
Locking your tablet	11
Using the touchscreen	11
The Home screen	12
The onscreen keyboard	18
Editing text	20

Connecting devices to your tablet

Connecting to AC power	22
Inserting a microSD card (optional)	22
Connecting to a PC as a USB storage device	22
Connecting a USB device to your tablet	23
Connecting a Bluetooth device	23
Connecting to a television with HDMI	24
Connecting to the dock (optional)	24

Using the AT&T Mobile Broadband Network

How to Connect to the AT&T Mobile Broadband Network	25
Adjusting connection settings	25

Going online

Managing Wi-Fi connections	27
Browsing the Internet	27
Setting up Gmail (Google mail)	28
Composing an email	28
Setting up the Email application	29
Online applications	29

Acer content folders	
Using the content folders	33
Playing music and video	
Multimedia playback	35
Media server	39
Dolby Mobile	39
Managing contacts	
Using the camera	
Camera icons and indicators	43
Taking a photo	44
Shooting a video	45
Reading an eBook or pdf	
LumiRead	47
Advanced settings	
Sound	52
Screen	52
Putting your tablet in Airplane mode	53
Activating or deactivating connections	53
Adjusting Bluetooth settings	53
Connecting to a PC	54
Synchronization	54
Setting the date and time	55
Setting alarms	55
Changing language and text options	55
Managing applications	55
Updating your tablet's operating system	56
Resetting your tablet	56
FAQ and troubleshooting	
Installing a SIM card	58
Troubleshooting	59
Other sources of help	60
Legal notices	60
Specifications	
End user license agreement	

Getting to know your tablet

Features and functions

Your new tablet offers leading, easy-to-access multimedia and entertainment features. You can:

- Connect to the Internet.
- Access your email while on the move.
- Keep in touch with your friends via your Contacts and social networking applications.
- Listen to rich, full-impact audio via Dolby Mobile.

Product registration

When using your product for the first time, it is recommended that you immediately register it. This will give you access to useful benefits, such as:

- Faster service from our trained representatives.
- Membership in the Acer community: receive promotions and participate in customer surveys.
- The latest news from Acer.

Hurry and register, as other advantages await you!

How to register

To register your Acer product, please visit www.acer.com. Click **Registration** and follow the simple instructions.

You can also register directly from your tablet by tapping the **Acer Registration** icon.

After we receive your product registration, you will be sent a confirmation email with important data that you should keep in a safe place.

Setting up

Unpacking your tablet

Your new tablet comes packed in a protective box. Carefully unpack the box and remove the contents. If any of the following items is missing or damaged, contact your dealer immediately:

- Acer ICONIA TAB
- Quick Start Guide
- AT&T Getting Connected Guide
- USB cable
- AC adapter
- Warranty card
- Cleaning cloth

Getting to know your tablet

Front view

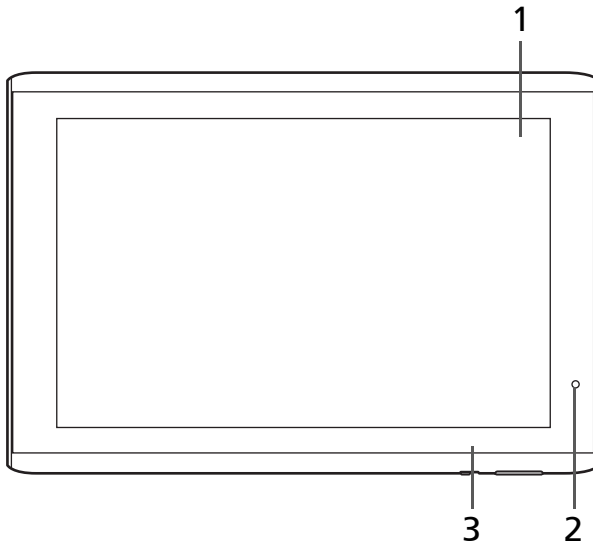

No.	Item	Description
1	Touchscreen	10.1-inch, 1280 x 800 pixel capacitive touchscreen.
2	Front-facing camera	A 2-megapixel camera for video chatting and self-portrait images.
3	Light sensor	Detects ambient light and automatically adjusts the screen brightness.

Back view

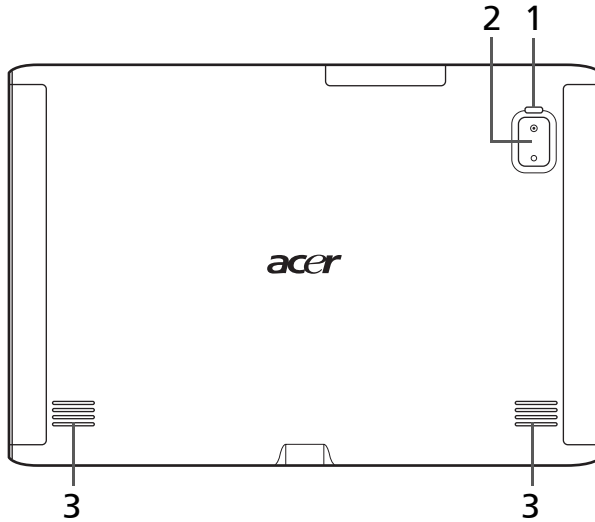

No.	Item	Description
1	LED flash	Lights to illuminate images.
2	5 MP camera	A 5-megapixel camera for taking high-resolution images.
3	Speakers	Emits stereo audio

Left and right views

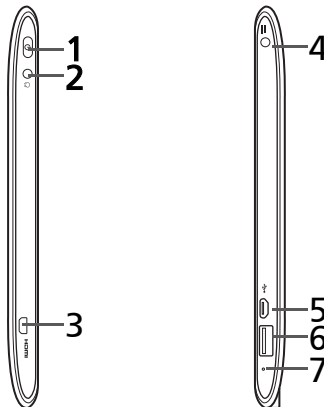

No.	Item	Description
1	Power button	Long press to turn the tablet on, press briefly to turn the screen on/off or enter sleep mode; press and hold to turn the tablet off.
2	3.5 mm headphone jack	Connects to stereo headphones.

No.	Item	Description
3	Micro HDMI (Type D) port	Connects to an HDMI cable with a Type D connector.
4	DC-in jack	Connects to the DC power supply.
5	Micro USB port (Slave)	Connects to a computer with a USB cable.
6	USB port (Host)	Connects USB devices to your tablet.
7	Reset button	Insert a small thin object (such as a paperclip) to reset power to the tablet.

Top and bottom views

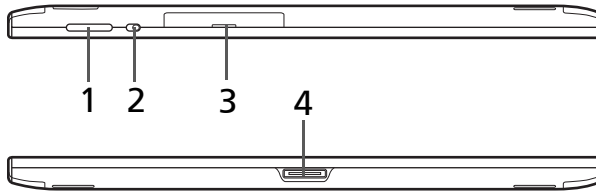

No.	Item	Description
1	Volume control key	Increases and decreases the tablet volume.
2	Screen rotation lock switch	Use this switch to lock the screen rotation or allow the screen to match the tablet's orientation.
3	Card slot cover	Insert a microSD card into the slot under this cover. See "Inserting a microSD card (optional)" on page 22.
4	Docking port	Connects your tablet to the dock accessory.

Using the SIM card slot

To take full advantage of your tablet's Internet capabilities, you should install a SIM card with data subscription *before* turning on your tablet.

See "Installing a SIM card" on page 58.

Using your tablet

Charging your tablet

For first-time use, you need to charge your tablet for four hours. After that you can recharge the battery as needed.

Connect the DC-in jack to your tablet and plug the AC adapter into any AC outlet.

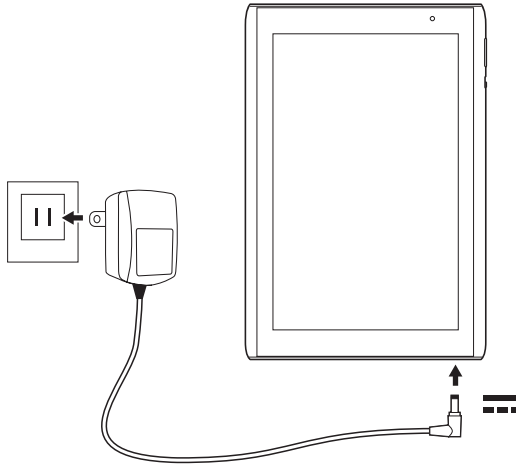

.....
Note: It is normal for the tablet surface to become warm during charging or long periods of use.
.....

Turning on for the first time

To turn on your tablet, press and hold the power button for two seconds. You will then be asked some questions before you can use your tablet.

To start, tap to select your language, then tap **Start**. Follow the rest of the instructions as they are displayed.

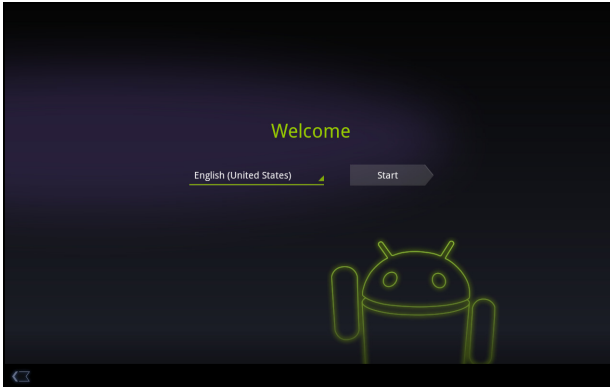

Sign in to or create a Google account

If you have Internet access, your tablet allows you to synchronize information with a Google account.

During the start-up process, you may create or sign in to an account, which will be used to synchronize your contact list, email, calendar and other information. If you do not yet have Internet access, or do not want to use this feature, then tap **Skip**.



.....
Important: You must sign in to a Google Account to use Gmail, Google Talk, Google Calendar, and other Google Apps; to download applications from Android Market; to back up your settings to Google servers; and to take advantage of other Google services on your tablet.

If you want to restore existing settings from another device with Android 2.0 (or later) installed, you must sign in to your Google account during setup. If you wait until after setup is complete, your settings will not be restored.
.....



.....
Note: If you have multiple Google accounts, such as separate accounts for personal and business contacts, you can access and synchronize them from the Accounts settings section. See "Multiple Google accounts" on page 55.
.....

Locking your tablet

If you will not use your tablet for a while, briefly press the power button to lock access. This saves power and ensures your tablet does not unintentionally use any services. Your tablet will lock automatically if it is not used after a while. To change the delay, tap **Apps > Settings > Screen > Timeout**.

Waking your tablet

If the screen is off and the tablet does not react to any taps on the screen, then it has been locked and is in sleep mode.

To wake your tablet, press the power button. Your tablet will display the Lock screen. Drag the lock symbol to the edge of the circle to unlock the tablet.

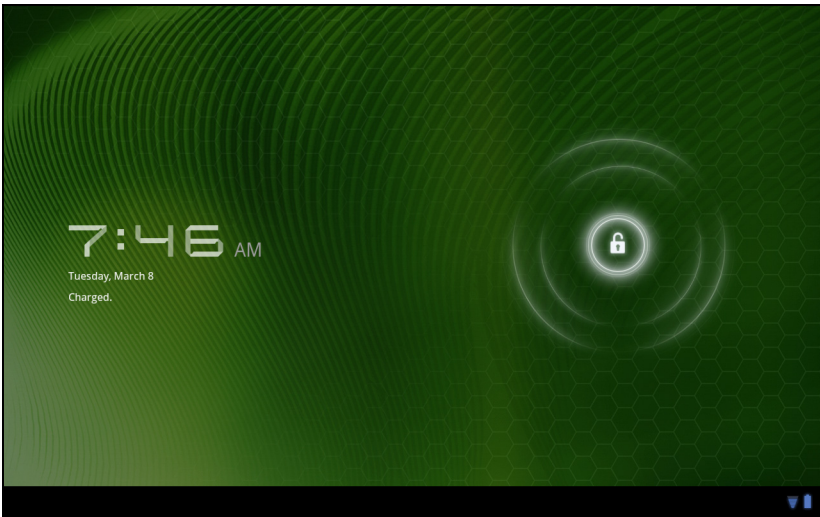

For additional security, you may set a code or number that must be entered to access the tablet, such as an unlock pattern (a set of dots that must be tapped in the correct order). Open the Home screen and tap **Apps > Settings > Location & security > Configure lock screen**.



.....
Note: If you forget an unlock pattern or PIN, please refer to “**Unlock pattern**” on page 60.
.....

Using the touchscreen

Your tablet uses a touchscreen for selecting items and entering information. Use your finger to tap the screen.

Tap: Touch the screen once to open items and select options.

Drag: Hold your finger on the screen and drag across the screen to select text and images.

Tap and hold: Tap and hold an item to see a list of actions available for that item. On the pop-up menu that appears, tap the action you want to perform.

Scroll: To scroll up or down the screen, simply drag your finger up or down the screen in the direction that you want to scroll.

The Home screen

When you start your tablet, or wake it from power saving, it will display the Home screen. This screen gives you quick access to information and simple controls with widgets or shortcuts. These display information such as the time and favorite bookmarks, or provide additional controls and direct access to applications. Some have been pre-installed on your tablet, while others may be downloaded from the Android Market.

The Home screen already features some useful controls and information.



Search

To search for applications, files or for information on the Internet, tap the **Google / Search** icon in the top-left corner.



Simply enter the text you want to find. Tap the arrow or Enter key to search the Internet, or tap one of the suggestions, applications or files shown in the list.



Note: In order to search or browse the Internet, you must be connected to a cellular data (if available) or wireless network. See "Going online" on page 27.

Voice search

If voice search is available, tap the microphone and speak your search request. See "Voice Search" on page 28.



Navigation

To navigate through menus and options, three (or more) icons are shown in the bottom-left corner.



Back

Tap this icon to go to the previous page, or to go up one level in a menu. This icon may be replaced with the *hide* icon in certain cases (such as if the keyboard or list of recent applications is shown).



Home

Tap this icon to go directly to the Home screen.

Recent

Tap this icon to see recently opened applications. Tap an application to open it, or tap anywhere on the screen to return to the Home screen.

Settings

This icon is displayed in some applications. Tap this icon to open a list of options.



The extended Home screen

The Home screen extends to either side of the initial Home screen, giving you more room to add widgets or organize shortcuts. To view the extended Home screen, swipe your finger to the left or right.

A total of five pages are available, two to the left and two to the right. To change or add widgets on any of the screens see **"Personalizing the Home screen"** on page 16.



The application menu

The application menu displays applications installed on your tablet.

Two categories are available: **All** and **My apps**. **All** displays all applications that are installed on your tablet; **My apps** displays applications that you have installed from the Android Market.



Note: All images are for reference only. The applications installed on your tablet can be different from the applications shown in illustrations.

Applications are displayed in alphabetical order. If more applications are available, an outline of the second page will be shown on the side of the screen. Swipe the outline towards the center of the screen to switch pages.

Tap and hold an icon to add a shortcut to one of your Home screens. While a shortcut is selected, thumbnails of the Home screens are shown below the list of applications, simply drag the shortcut to a screen.

Status and notification area

Status and notification icons are shown in the bottom-right corner of the screen.

This area contains a variety of icons to inform you of your tablet's status. The icons on the right side of the clock indicate connectivity and battery status. The left side of the clock displays the event notification icons.

Tap the status icons to view more status information and a summary of events.

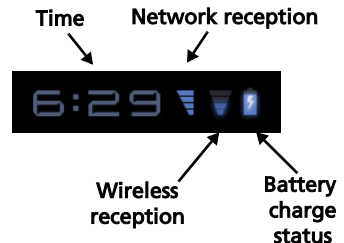

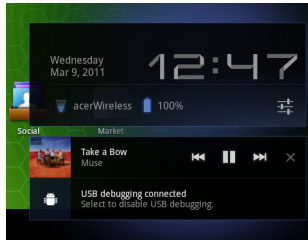

Tap the status area again to view more controls. While viewing a notification, tap the summary to see more information, if available. Some event summaries include controls, such as media controls if music is playing.

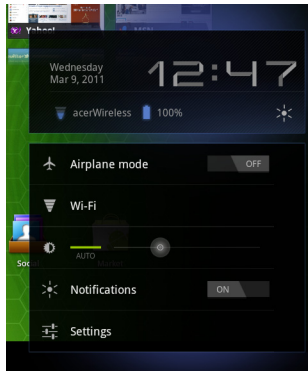

Status and notification icons





















Connection and battery status icons











Note: Network connection icons are blue if you have an active Google account.

Icon	Description	Icon	Description
	Connected to a wireless network (waves indicate connection strength)		Battery is very low
	An open wireless network is available		Battery is low
	Bluetooth is on		Battery is partially drained
	Connected to a Bluetooth device		Battery is full
	Airplane mode (wireless connectivity disconnected)		Battery is charging

Notification icons

Icon	Description	Icon	Description
	Alarm is set		Speaker is silenced
	New Gmail message		Tablet microphone is off
	New Google Talk message		GPS is on
	Upcoming event		Receiving location data from GPS
	Song is playing		More status notifications
	SD card or USB storage is full		Syncing data
	Tablet is connected to PC via USB		Sync is on
	Application update available		Problem with sign-in or sync
	System update available		Uploading data
	Virtual private network (VPN) status		Downloading data

Cellular data status icons

Icon	Description	Icon	Description
	Cellular signal strength		SIM card is invalid or not installed
	Connected to EDGE network		New/unread SMS/MMS
	Connected to HSDPA network		Problem with sending SMS/MMS
	Roaming		Carrier data use threshold exceeded
	No signal		

Personalizing the Home screen

You may personalize your Home screen by adding or removing application shortcuts or widgets, and by changing the wallpaper.

Adding or removing shortcuts or widgets

To add shortcuts or widgets open the **Add to Home** screen: tap the plus sign next to **Apps** in the top-right corner of the Home screen. Alternatively, tap and

hold anywhere on the Home screen.

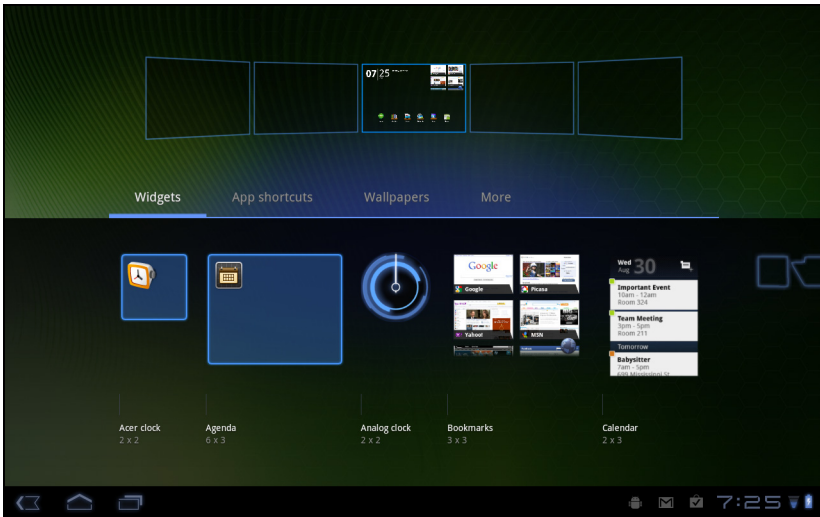

Tap **Widgets** to see small applications that you can add to a Home screen. Widgets are small applications that display constantly-updated information or quick shortcuts to applications or special functions.

Tap **Applications** to open a list of shortcuts to applications and settings you can drag to a Home screen.

Tap **Wallpapers** to change the current wallpaper. You can choose from a set of pre-formatted wallpapers, images stored in the Gallery, or Live wallpapers featuring animated or interactive backgrounds.

Tap **More** to add icons, shortcuts, 'groups' of contacts or links to specific settings.

To move any item on the Home screen, tap and hold the item until it is selected. You may drag the item to any free area on the screen. To move the item to a different Home screen, drag it to the side of the screen, the Home screen will switch to the screen in that direction. Release the item when it is positioned correctly.

To remove an item from the Home screen, tap and hold the item until the trash icon appears in the top-right corner of the screen. Simply drag the item to the trash icon.

Adding shortcuts from the Application menu

You can add shortcuts to the Home screen directly from the Application menu. Open the Application menu then tap and hold an icon until an image of the Home screens appears. Drag the icon to a Home screen to create a shortcut.

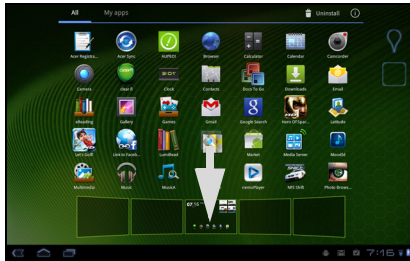

The onscreen keyboard

When you tap a text box to enter text, an onscreen keyboard will appear. Simply tap on keys to enter text.

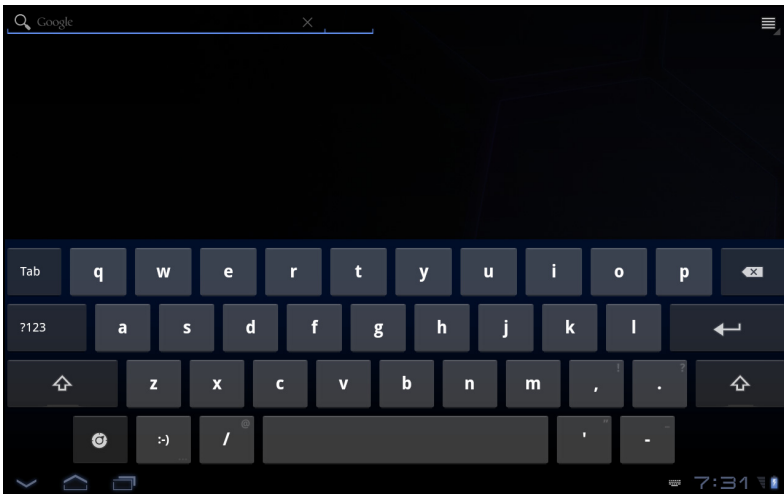

Tap the **?123** button to see numbers and special characters, and then tap the **More** key to see more options. Tap and hold a key to select alternative characters (if available), such as letters with accents.

The layout of the keyboard varies slightly, depending on the application and information that is required.

Changing Android keyboard settings

To use a different keyboard language or change settings, tap the **Input options** key, then select either **Input languages** or **Android keyboard settings**. These settings include Auto-correction, keyboard sounds and vibration.



Predictive text or auto correction

The Android keyboard can provide predictive text input. As you tap the letters of a word, a selection of words are displayed that continue the sequence of letters tapped, or are a close match allowing for errors. The word list changes after every key press. If the word you need is displayed, you can tap on it to insert it into your text.

To turn predictive text on or off with the Android keyboard, tap the **Input options** key, and then **Android keyboard settings**. Tap **Auto correction** or **Show correction suggestions** and select one of the options.

Changing the keyboard

To use a different keyboard type, tap the **Keyboard status** icon; this will open a menu listing the text input methods available on your tablet. Tap your preferred input method.



Typically three options are available: two types of **Android Keyboard** (keyboard and voice) and **XT9 Text Input**.

XT9 Text Input

The XT9 keyboard provides an alternative to the standard Android keyboard.



Tap the **?123** button to see numbers and special characters, and then tap the **ALT** key to see more options. Tap and hold a key to select alternative characters (if available), such as letters with accents.

Additional keys vary depending on the type of text you enter, e.g. a key to add a smiley is available when typing a text message. Like other keys, tap and hold to see if additional options are available.

Text assistance

The standard XT9 keyboard has various features that assist you to enter correct text. To use these features, tap the **Keyboard status** icon; this will open a menu listing the text input methods available on your tablet. Tap the settings icon next to the **XT9 Text Input** entry.

Function	Description
Languages and settings	<p>Set the languages that will be available.</p> <p>If you have selected more than one language, tap the globe in the text prediction bar to cycle through the languages. Tap and hold the globe to see a list of selected languages.</p> 
Preferences	Change your text input preferences.

Editing text

You can select and edit text in certain applications, such as text you have entered in a text field. Selected text can be cut or copied and later pasted within the same application, or to a different application.



Note: Certain applications may not support text selection, or only support it in certain areas. Other applications may offer specialized commands to select text.

Selecting text

To select text that you want to cut, copy, delete or replace:

1. Tap the text you want to select. If you can select this text, a cursor is inserted below the text.



Note: The cursor indicates where text you type or paste will be inserted.

2. Tap and hold the text or word you want to select. The selected text is highlighted, with a tab at each end of the selection.

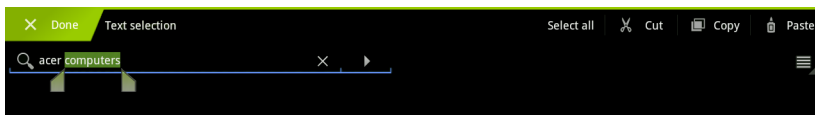

3. Drag either tab to expand or reduce the amount of selected text, or tap **Select all**.
4. To cut or copy the text, tap the **Cut** or **Copy** button.

Inserting text

To type new text or add text that you have copied:

1. Tap the text you want to select. If you can select this text, a cursor is inserted below the text.



Note: The cursor indicates where text you type or paste will be inserted.

2. If the cursor is not in the desired position, simply drag it to the correct position.
If you previously copied (see below) text, a *Paste* button appears briefly above the cursor. Tap the button to paste the text.



3. Modify the text: Type, paste or delete text.
4. Tap Enter on the keyboard, or tap the **Close Keyboard** button.

Connecting devices to your tablet

Connecting to AC power

See "Charging your tablet" on page 9.

Inserting a microSD card (optional)

You may install a microSD card to expand your device's storage space.



.....
Note: Your tablet only supports microSD cards that use the FAT or FAT32 file system.
.....

1. Open the card slot cover.
2. Insert the microSD card as shown. Ensure that the microSD card is inserted all the way into the card slot.
3. Replace the card slot cover.

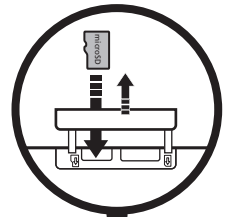

Check card capacity in the **External SD card** section of **Apps > Settings > Storage**.

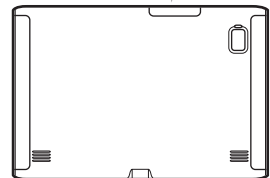

Transferring files between a microSD card and your PC

Remove the card from the tablet and use a card reader or USB adapter to access the card as an external storage device.



.....
Note: Check your tablet is not using the microSD card before removing it from the tablet. Take care when removing the card, the slot is spring-loaded.
.....

Connecting to a PC as a USB storage device

Download and install the latest USB driver on your computer before connecting your tablet to the computer. Visit www.acer.com for the latest drivers: Select **Support, Download, Tablet**. Select your tablet model, and then the **Driver** tab, select **USB** and accept the download.

This allows you to transfer your personal data to or from your PC, using your PC's file explorer.

Plug the micro USB connector to your tablet, and plug the other end of the USB cable into a USB port on your PC.

After a short delay, your tablet's internal memory will be visible as an external drive in your PC's file explorer.

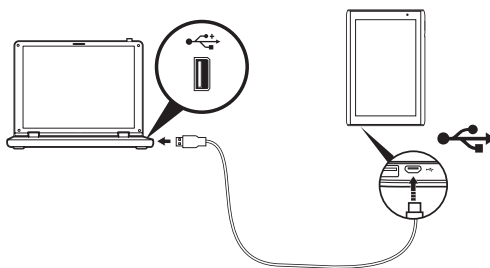

Connecting a USB device to your tablet

USB devices are supported, such as a keyboard or USB storage device, through the Host USB port.

As most USB keyboards are designed for desktop computers and operating systems, some keys may not function.

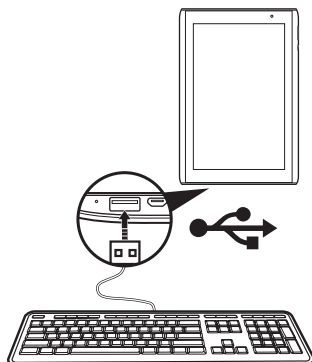

Accessing files on a USB storage device



Note: Your tablet only supports USB storage devices that use the FAT or FAT32 file system.

You can access media files (photos, music and video) on USB storage devices with your tablet's multimedia apps.



Caution: Before removing USB storage, make sure your device is not using data on the USB storage device.



Note: Please check for updates to the tablet's software that may add support for additional USB devices. See "Updating your tablet's operating system" on page 56.

Connecting a Bluetooth device

Only A2DP stereo headsets (without microphone) are supported. Please check for updates to the tablet's software which may add support for additional Bluetooth devices.

For Bluetooth settings, tap **Apps > Settings > Wireless & networks > Bluetooth settings**.

Tap **Find nearby devices** to scan for available devices.



Note: Please check for updates to the tablet's software that may add support for additional Bluetooth devices. See "Updating your tablet's operating system" on page 56.

Connecting to a television with HDMI

Connect an *HDMI micro* (Type D) cable to your tablet then plug the other end of the cable into a TV or monitor with an HDMI port.

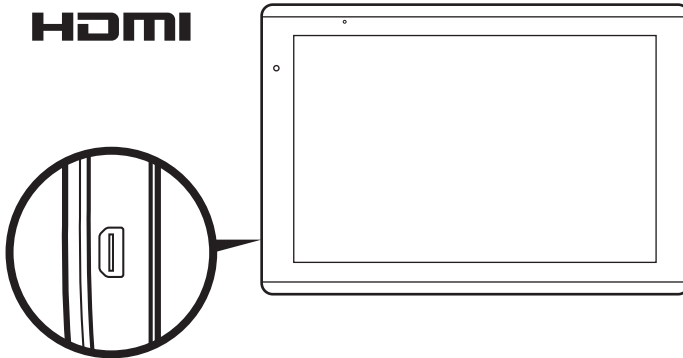

Connecting to the dock (optional)

The optional dock holds your tablet and allows you to easily charge the battery with a single connection.

The dock provides extra ports that replace your tablet's built-in ports while it is docked. Please check the dock's specifications for the exact features provided.

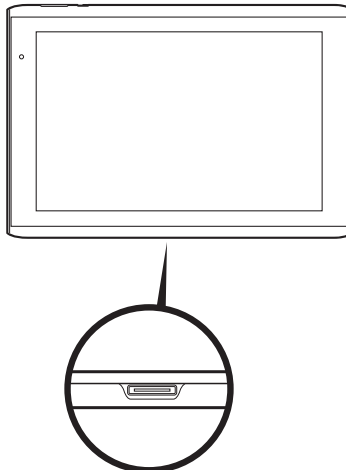

Using the AT&T Mobile Broadband Network

How to Connect to the AT&T Mobile Broadband Network

If your AT&T Mobile Broadband service was activated when you bought your tablet, you'll enjoy network connectivity as soon as you turn your tablet on.

If your AT&T service was not activated at the time of purchase, follow the instructions below to connect.



.....
Tip: Your tablet includes unlimited Wi-Fi usage on the AT&T Wi-Fi Hotspot network. Free Wi-Fi hotspot requires an active, unexpired DataConnect Plan for Tablets. Access includes AT&T Wi-Fi Basic. Wi-Fi enabled device required. Other restrictions apply. See www.attwifi.com for details and locations.
.....

1. To select and activate your DataConnect Pass Plan for Tablets, tap **Activate** in the AT&T widget on your home screen.

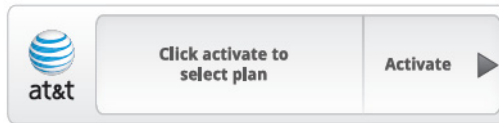

2. Once connected to the secure website, select your preferred DataConnect Pass Plan for Tablets and activate your service. You will need a debit or credit card to activate service.
3. You will receive a text message or email confirming your service has started. The time/data plan you purchased starts counting down immediately after activation.

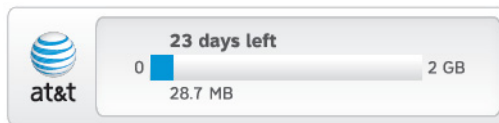

Adjusting connection settings

Open the Application menu and tap **Apps > Settings > Wireless & networks** to manage your connection settings.



.....
Note: If you need to turn the data network on or off see "Putting your tablet in Airplane mode" on page 53 and "Activating or deactivating connections" on page 53.
.....

Mobile Internet settings

Tap **Apps > Settings > Wireless & networks > Mobile networks** to adjust your network settings. You can turn data connection on or off when roaming, specify a network operator and define access point names.

Disable data when roaming

You can prevent your tablet from transmitting data over other carriers' mobile networks when you are traveling and leave an area that is covered by your carrier's networks. This is useful for controlling expenses if your mobile data contract doesn't include data roaming.

1. Tap **Apps > Settings > Wireless & networks > Mobile networks**.
2. Tap **Data roaming** to disable it (remove the green tick).

Going online

Managing Wi-Fi connections

If you did not connect to a Wi-Fi network when you first started your tablet, or want to connect to a new network, tap **Apps > Settings > Wireless & networks > Wi-Fi settings** to manage your connection settings. Alternatively, tap the Wi-Fi status icon in the bottom-right corner of the screen.

If Wi-Fi is not on, tap **Turn on Wi-Fi**, and wait for your tablet to detect nearby networks. Tap the name of your network and enter a security password, if needed.

Browsing the Internet

In order to browse the Internet with your tablet, you must be connected to a network with a connection to the Internet.

Using the browser

To start browsing, tap a bookmark from the bookmark widget on the Home screen, or open the Application menu and select **Browser**. To enter a website address, tap the address box at the top of the page. Enter the address using the keyboard and tap **Enter** or the Go arrow.

To view your browsing history, bookmarks or frequently visited sites, open the browser then tap the bookmark icon in the top-right corner.

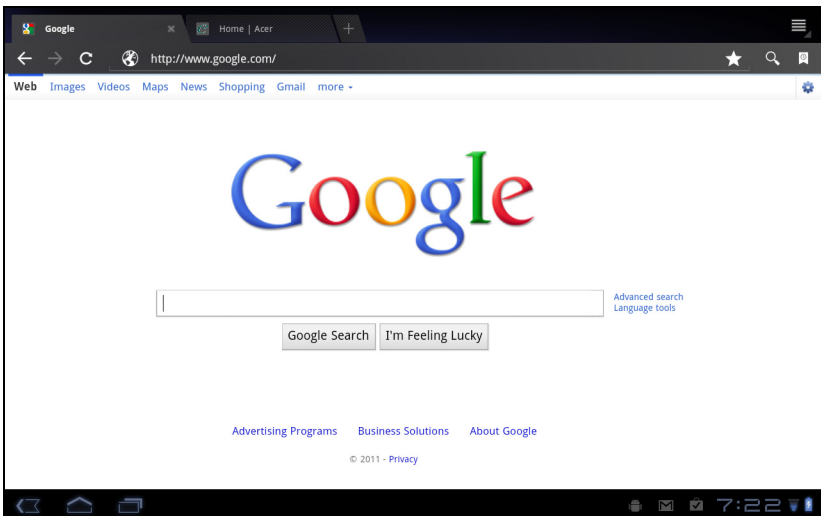

You may open multiple tabs. When a page is open, press the small tab with a plus sign. Simply tap one of the tabs across the top of the screen to switch pages.



Pinch to zoom in or out of pages. Tap and hold an item on a page to open a contextual menu.

Voice Search

With voice actions, you can send emails, find directions to locations, search the Internet and even send a note to yourself using your voice. Tap the microphone on the Home screen or open **Voice Search** from the applications tab. When the **Speak now** prompt is displayed, state your command or query.

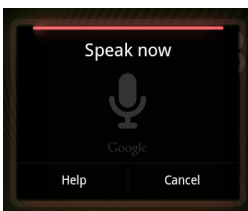

!
Note: Voice Search is available only in selected regions.
.....

Setting up Gmail (Google mail)

1. Make sure your tablet is connected to the Internet.
2. From the Applications menu tap **Gmail**.

If you did not enter a Gmail account address and password when you first started your tablet, follow the instructions.

!
Note: You need to activate a Google account before you can use Gmail.
.....

Composing an email

1. Make sure your tablet is connected to the Internet.
2. Open the application menu and tap **Gmail**.
3. Press the **Menu** button and then tap **Compose**.
4. Enter the recipient's email address, the subject and message.
5. When you are finished composing your message, tap **Send**.

Setting up the Email application

The Email application enables you to access email from most popular email providers. Most accounts can be set up in two steps. Open the application menu and then tap **Email** to start setting up your email access.

If necessary, enter your email address and tap **Manual setup** to enter the parameters manually. Tap **Next** to finish the setup process.

The combined inbox feature of your tablet allows you to view emails from multiple accounts in a single inbox.

Online applications

Your tablet provides a variety of preinstalled applications. Many of these require some form of Internet access.

These applications may include:

- **Acer Sync:** Sync your data between your tablet, your computer and the Google servers.
- **SocialJogger:** View updates to your social networks in one location.
- **Maps:** Get easy-to-follow directions using Google Maps.
- **Talk*:** Chat with your friends, with text, sound and video.
- **Navigation*:** Turn-by-turn navigation with live traffic, multiple visible layers and text-to-speech take you where you want to go.
- **Latitude:** View where your friends are on Google Maps.
- **Places:** View places of interest and local businesses on Google Maps.
- **YouTube*:** View the most viewed and most discussed video clips on YouTube.
- **LumiRead:** Download books from featured bookstores, and setup convenient links to your favorite ebook sites.
- **MusicA:** Let your tablet listen to music and access the MusicA database to find the track name and artist.



* **Note:** Applications installed may vary according to your region.



SocialJogger

SocialJogger combines your social network updates in one location, allowing you to quickly follow what your friends are doing across several platforms.

From the application menu, tap SocialJogger to launch the program.

Select **Sign in** to enter your account information. When you are finished press **Start**.

Slide the disc, located on the right, up and down to cycle through the status updates.

Tap on a status to view more details and make a comment.

Tap the left and right arrows, located on the top, to cycle between the categories: My Page, Photos, Link and any added pages.

Tap the **Menu** button to access account settings, refresh the page, auto play, and add or remove custom pages.

Adobe Flash Player

Adobe Flash Player is not installed on your tablet. If you want to use Flash content on in your browser, you can visit the Android Market (see below) to easily download and install Adobe Flash Player.

Android Market



.....
Note: The Android Market may not be available in all countries and regions.
.....



.....
Note: You must activate a Google account before using the Android Market.
.....

Tap **Market** from the home screen or application menu to open the *Android Market*. Here you can obtain a variety of add-on programs and applications to enhance the functionality of your tablet.

You may also browse for books that you may read with LumiRead or another reader application.

The first time you access the Android Market, you must read and accept the Terms of Service.

You can browse the market by category or tap the search icon to search for a specific application.

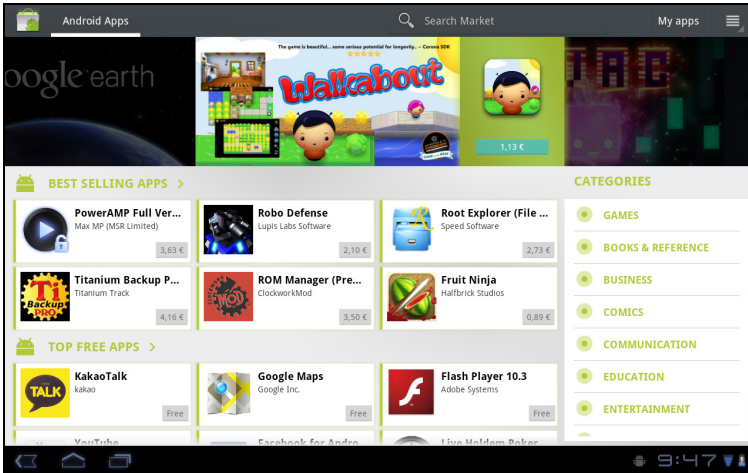

Once you have selected an application, tap the **DOWNLOAD** button to download and install the application. You will be told which services (contact information, wireless access, GPS, etc.) the application requires access in order to function correctly. If none of these services seem unusual, tap **OK** to proceed with the installation.

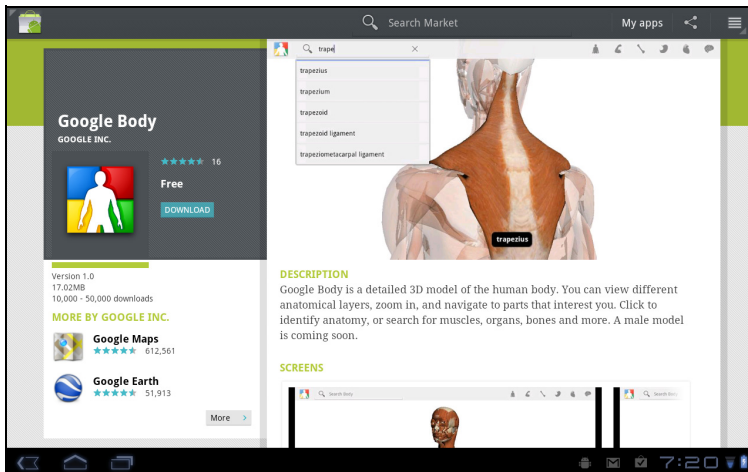

You may keep track of the download progress from the status area.



Important: Some applications may require payment before you can download them. You will need to have a Google Checkout account in order to pay for these applications.

Using downloaded applications

Once you've downloaded and installed an application, you may find it in the **My apps** or **All** sections of the Application menu.

Certain applications also provide widgets, or only provide a widget (with no application icon). Widgets can be found in the Widget section when personalizing your Home screen. See "Personalizing the Home screen" on page 16.

Uninstalling downloaded applications

Once you've downloaded and installed an application, you may uninstall the application by pressing and holding the application icon and dragging it to the trash can located on the top-right corner of the screen.

Alternatively, you can go to **Settings** from the application menu and select **Applications > Manage applications**. Tap the application you wish to uninstall, tap **Uninstall** and confirm the uninstall.

Google Talk



Note: Google Talk may not be available in all countries and regions.



Note: You need to activate a Google account before you can use Google Talk.

Tap **Talk** from application menu to open Google Talk. Here you can see a list of your contacts connected to Google Talk services. Tap on a contact to open a chat session. After you have connected, you can open a video chat session.

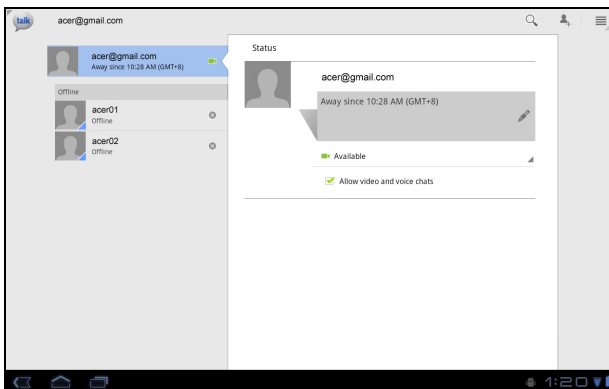

Use the front-facing camera so the person you call can see you while you can see them on the screen; hold your tablet in portrait mode to improve the camera position.

Acer content folders

Your tablet includes content folders that allow you to easily organize and access your favorite applications.

Choose one of the four categories on the Home screen or application menu: **eReading, Games, Multimedia** or **Social**.

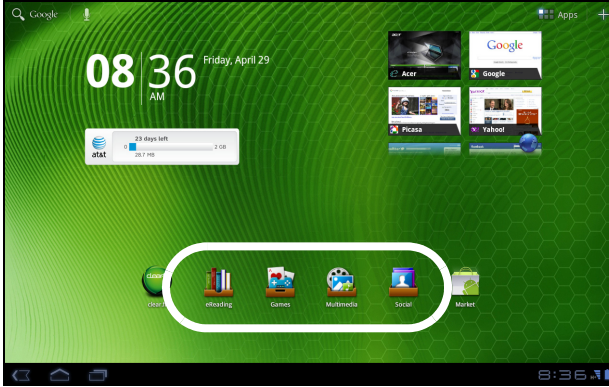

Tap the shortcut to open a screen containing applications from that category.

Using the content folders

Each category already contains shortcuts to essential applications. Simply tap a shortcut to open the application. The shelves along the bottom of the screen may contain links to portals that allow you to download related applications from trustworthy publishers.

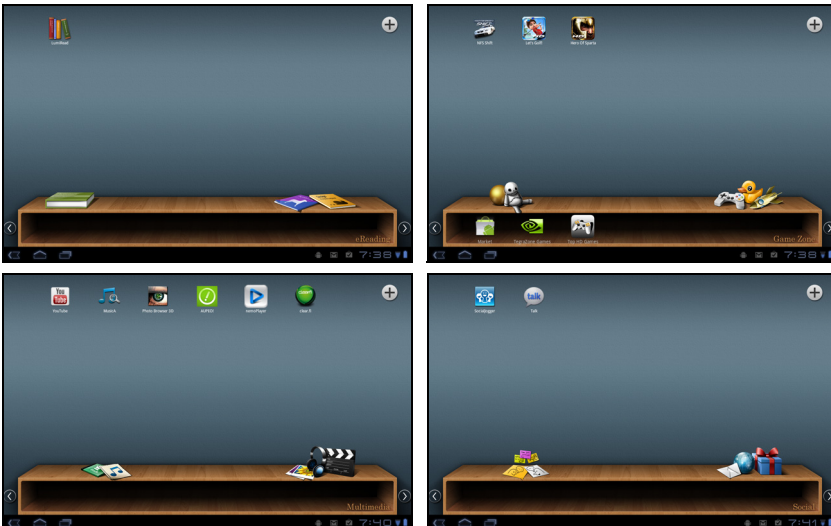

Selecting a content folder

The folder shortcuts on the home screen or Application menu give you direct access to any of the four categories. If you have opened a category, you can easily change category by swiping the screen to the left or right.

Adding

You can add applications to any content folder. Tap the **Plus** sign in the top right corner and select one or more applications from the list. Tap **OK** to add shortcuts for the selected applications.



You may view up to twenty shortcuts on a single screen. If you add more than twenty shortcuts, swipe the screen up to see additional shortcuts.

Moving or removing

Tap and hold an item to select it. Drag it to a new position to change the order, or to the trash can in the top right corner to remove the shortcut from the screen.

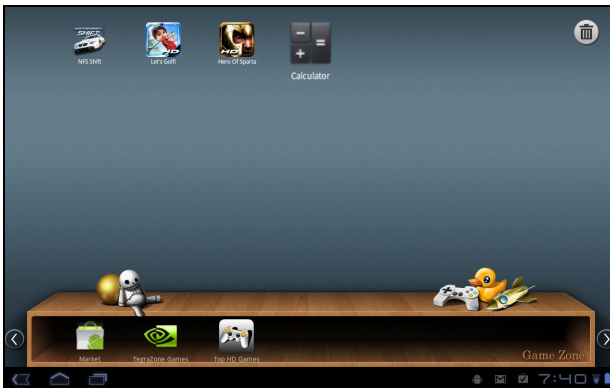

Note: Certain preloaded applications may not be removed.

Playing music and video

Multimedia playback

Your tablet comes supplied with a variety of programs that you can use to enjoy multimedia content.

Music

Use **Music** to listen to music and other audio files that you download or copy from your computer.



Tap **Apps > Music** to open the application.

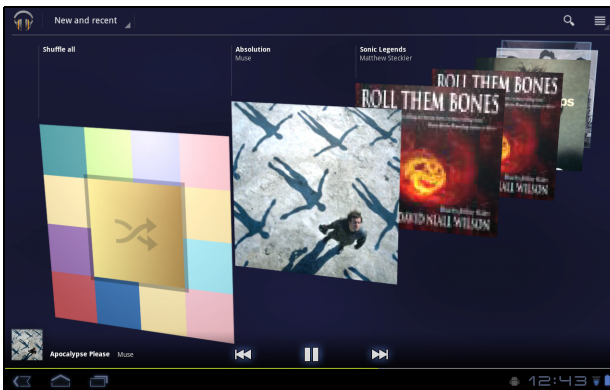

Tap the **Shuffle All** cover to play a random selection, or swipe through the albums and tap to view a list of tracks. Tap the play symbol or a track to start playback. Tap the Music icon to return to the previous view.

To change how your music is displayed, tap the arrow next to **New and recent**.

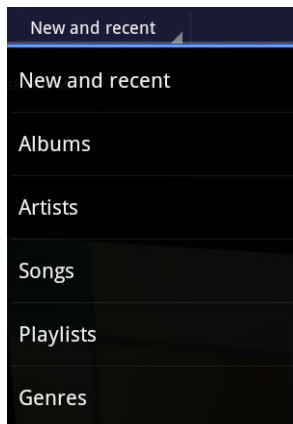

Depending on your selection, your music library is displayed as a grid of album covers or a list of tracks.



Note: You can return to the Home page while playing music; a Music icon is displayed with the notification icons. Tap this icon to control playback.



Acer clear.fi

With Acer clear.fi, you can browse and stream remote multimedia content from, or to, other devices with Acer clear.fi installed.



Note: All devices must be connected to the same network.



Note: When using an external USB storage device to access media files, the device may not be recognized for a few minutes.

Tap **clear.fi**.



Acer clear.fi will automatically detect devices that are connected to the network and are also running *Acer clear.fi*. These devices are displayed at the bottom of the screen, with your tablet as the default device. Tap any of the connected devices and then tap **Photo**, **Video**, or **Music** to browse media files on that connected device.

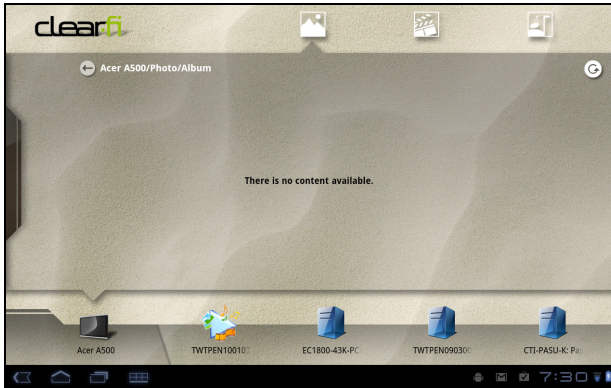

Drag the bar on left side for more viewing options.

clear.fi photos

Tap the photo album to view the thumbnails. Tap and hold an album or photo thumbnail to view the menu panel.

You can view photos found on any of the connected devices and save them.

Tap and hold a photo thumbnail, then tap and hold any of the connected devices showing an arrow. Select **Play** or **Save**.

To upload a photo to Facebook, or Flickr via Acer Photo Uploader, or to paired devices using Bluetooth, tap and hold a photo thumbnail, then tap **Share**.

clear.fi videos

Tap a folder under Collection to view the thumbnails. Tap and hold a folder or video thumbnail to view the menu panel.

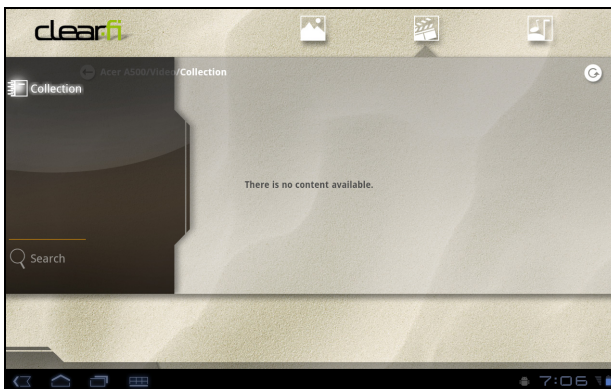

You can play videos found on any of the connected devices and save them. Tap and hold a video thumbnail, then tap and hold any of the connected devices showing an arrow. Select **Play** or **Save**.



Note: The Acer clear.fi video player only plays MP4 files. Please check for updates to the tablet's software which may add support for other types of video. See "Updating your tablet's operating system" on page 56.

To send video files, for example, to paired devices using Bluetooth or to YouTube, tap and hold a photo thumbnail, then tap **Share**.

clear.fi music

Tap a folder to list the audio files. Tap and hold a folder or audio file to view the menu panel.

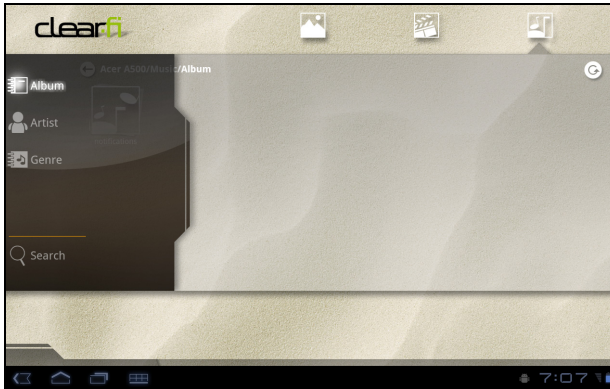

You can listen to any audio file found on any of the connected devices and save them. Tap and hold an audio thumbnail, then tap and hold any of the connected device showing an arrow. Select **Play** or **Save**.

To send audio files as an email attachment using Google Mail, or to paired devices using Bluetooth, tap and hold a photo thumbnail, then tap **Share**.

nemoPlayer

Open **nemoPlayer** from the Application menu to play media you have stored on your tablet.

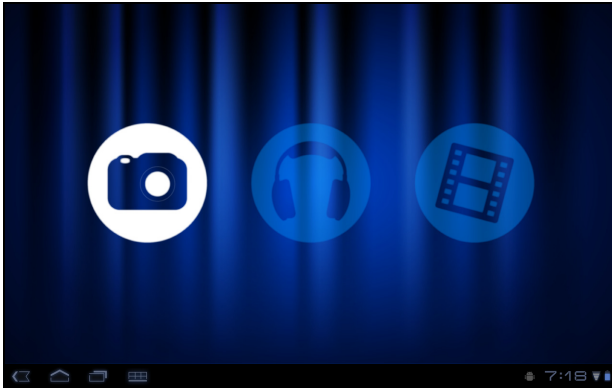

nemoPlayer enables you to listen to music, view video clips and pictures in all the formats supported by your tablet. See “Multimedia” on page 62.

Media server

Your tablet can act as a digital media server using UPnP technology. This means that you can use it to send media content to other UPnP-enabled home entertainment devices that are connected to a home wireless network.

To set up the media server, open the application menu and tap **Media server**.

You will need to enable **Share contents** before you can start using the service.

You may select to share **Video**, **Photo** or **Music**. Tap a category to control which files are shared.

Dolby Mobile

To access Dolby Mobile settings go to the application menu and tap **Settings > Dolby Mobile**. Here you can switch Dolby Mobile on or off, set Treble, Natural Bass, Music EQ and Video EQ.

Managing contacts

Your tablet features an address book that allows you to save contacts to the internal memory or your Google account.

Tap **Contacts** from the application menu to view your contacts.

If you don't have any contacts stored on your tablet, you can sync with your Google account contacts, import contacts from a contact data file (vCard or csv) or add a new contact.

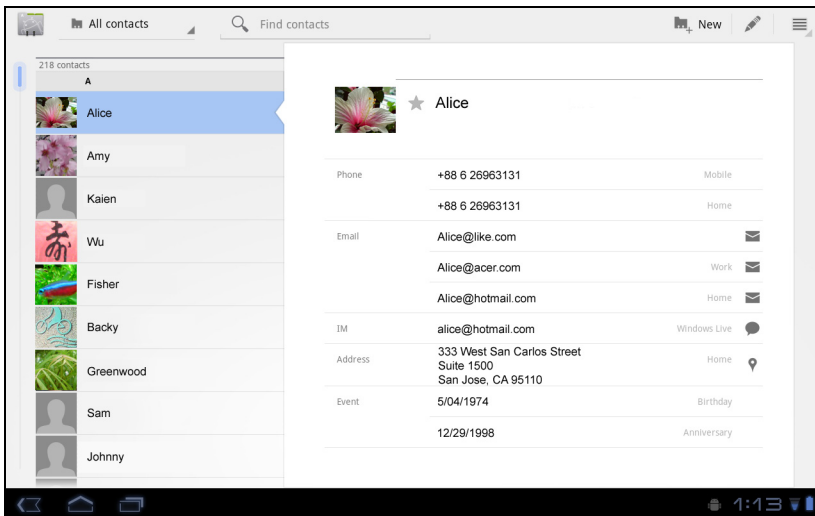

If you have activated a Google account that includes contacts, your contacts will be synchronized automatically. See "Synchronization" on page 54.

Importing contacts

Tap the *Menu* button and select Import/Export. Tap the option that describes where your contacts are stored. When the contacts are found, confirm to import the contacts in a new group.



Adding a new contact

Tap **New** to add a new contact. You will be asked which account you want to use to store the contact. If you select the name of your tablet it will be stored in the tablet's internal memory, and not synchronized with other accounts.

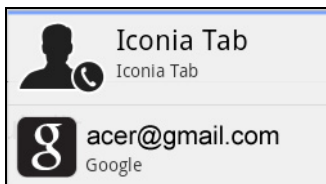
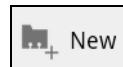

You may now edit the new contact entry.

Editing a contact

If you have opened a new or existing contact you can enter information about the contact:

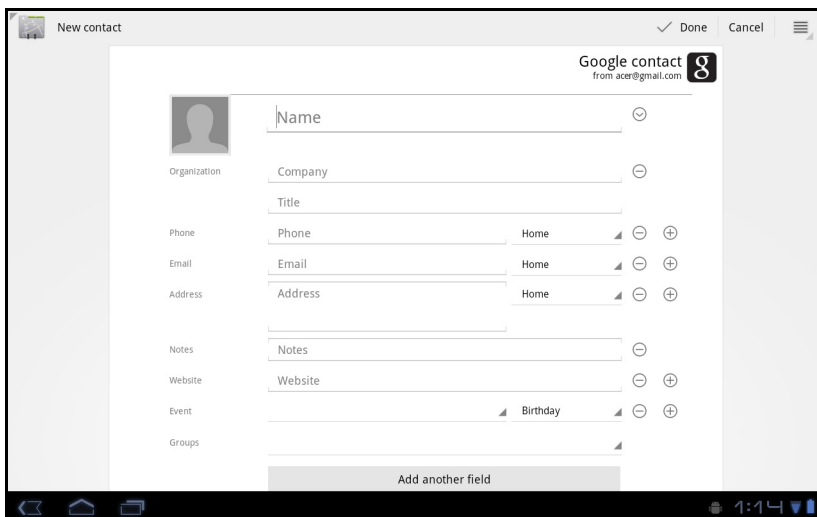

Simply tap on a box and type the appropriate information. Click on the arrow next to the name entry to see options, such as adding a name prefix or phonetic name.

To enter multiple entries, such as separate entries for mobile and home phone numbers, tap the plus sign to create a second entry. Tap the minus sign to remove an entry.

Tap **Add another field** for more categories.

To assign an image to your contact, tap the silhouette and select an image from your tablet's picture gallery (select **Gallery** if requested). You may also take and crop a new photo.

Tap **Done** to finish and save the contact.



Tip: Set each phone number to match the type of network as this can determine some functions, i.e. certain applications only recognise 'Mobile' numbers as they require a function only available on a mobile network.

Opening a contact

To see the information stored for a contact, tap on the contact's name in the list on the left.

Tap on an entry (such as an email address) to open the application linked to that type of entry. For example, tap an email address to open the **Gmail** application.

To add or change information, tap the pencil icon.

Tap **Done** to save changes, or **Cancel** to discard them.



Starred contacts

You may quickly access your favorite contacts by adding a *star*. First open the contact, then tap the star next to the contact's name. Tap **All contacts** and select **Starred** to see only your favorite contacts.

Editing a contact on your computer

If you have synchronized your Google account and contacts, you can use your computer to access and edit your contact list. Open the Internet browser on your computer and go to **contacts.google.com**. Sign in to your account then select and edit contacts from the list; the next time your tablet synchronizes with your computer, these changes will also be made to your tablet's contact list.



Warning: Back up your contacts before making any changes. Tap the *Menu* button and select Import/Export. You may then Export your contact list to your tablet's internal memory, or other options depending on installed applications.



Using the camera

Your tablet features two cameras: a 5-megapixel digital camera and flash mounted on the rear and a 2-megapixel digital camera mounted on the front. This section will take you through all the steps in taking photos and videos with your tablet.



.....
Note: It is recommended that you insert a microSD card into the microSD slot before using the camera.

Please note you can only save photos and videos to internal memory or a microSD card, not an external USB storage device.
.....



.....
Tip: The recommended use for the front-facing camera is for video chat. Use the camera so the person you call can see you while you can see them on the screen.

Normally, the video chat software you are using will provide controls for switching between the front and rear facing cameras.
.....

To activate the camera, open the application menu and tap **Camera**.



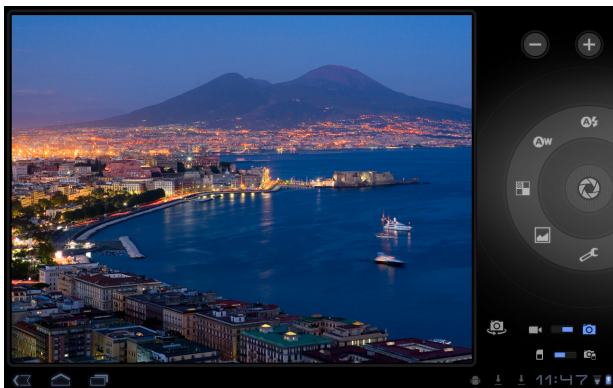









Camera icons and indicators



.....
Note: Not all controls are available when using the front-facing camera.
.....

In the camera window, the controls on the right allow you to zoom, change settings, switch between internal and SD card memory, switch between the front and rear camera, or select camera or camcorder.

After you have taken a photo, a thumbnail in the bottom-left allows you to view the gallery of pictures or videos.

Icon	Description
	Zoom out You may only zoom out after you have zoomed in.
	Zoom in Crop and enlarge the center of the screen. When using zoom, the image on the screen does not represent the quality of the final image.
	Take photo After taking a photo, tap the thumbnail in the bottom-left corner to view the photo in the Gallery.
	Flash mode Choose when to use the flash: Auto, On or Off
	White balance Change the color balance to match the lighting: Auto, Incandescent, Daylight or Fluorescent.
	Color effect Choose an effect to change the colors in your photos: None, Mono, Sepia, Negative, Solarize or Posterize.
	Scene mode Choose a mode to match the type of scene to capture: Auto, Action, Portrait, Landscape, Night, Night portrait, Theatre, Beach, Snow, Sunset, Steady photo, Fireworks.
	Camera settings Activate or change special settings: Store location, Focus mode, Exposure, Picture size, Picture quality, Restore defaults.
	Switch camera Switch between the rear and front cameras.
	Camcorder mode Switches to the camcorder (video recorder).
	Camera mode Switches to the camera.
	Internal memory Saves photos to the tablet's internal memory (this is the default).
	Memory card Saves photos to the memory card in the microSD card slot (only available if a microSD card has been inserted).

Taking a photo

1. Ensure the options described above are set to your preferences.
2. Frame your subject and steady your tablet.

3. Zoom in or out as needed.

Note: When using zoom, the image on the screen does not represent the quality of the final image.

4. Tap the camera icon to take the photo.

After taking a photo, tap the thumbnail in the bottom-left corner to view the photo in the Gallery.

Shooting a video

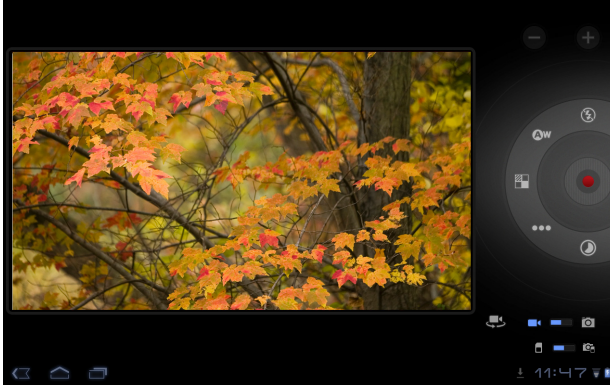





.....
Note: Not all controls are available when using the front-facing camera.
.....

Tap the camcorder icon to switch to camcorder mode.



Most camcorder settings are the same as the camera settings; if a setting is not described below, then check the camera description.

Icon	Description
	Start / stop recording
	Flash mode Turns the flash on or off.
	Video quality Choose the quality (resolution) of the video: High, Low, YouTube. Note: YouTube uses the High quality setting, but is limited to 15 minutes.
	Time lapse interval Shoot a slow motion 'time lapse' video, set the interval between single frames in this menu.

1. Ensure the options described above are set to your preferences.
2. Frame your subject and steady your tablet and zoom in or out as needed.
3. Tap the record icon to begin recording.
4. Tap the record icon down fully to stop recording.



.....
Note: Zoom is only available in certain resolutions.
.....

Supported formats

Type	Formats
Image	JPEG
Video	H.264BP
Audio	AAC-LC

Viewing photos and videos

After you have taken your photo or video, it is automatically saved; normally to internal memory.

After taking a photo or video, you can view it in the Gallery by tapping the thumbnail in the bottom-left corner of the screen. Alternatively, open the application menu and tap **Gallery**, then **Camera**. Select the photo or video you want to view (videos are marked with a small play symbol).

From the Gallery you can share the file directly using various services. Tap **Menu** and then **Share**.



.....
Note: Share options vary depending on the file type.
.....

Reading an eBook or pdf

LumiRead

The LumiRead application allows you to purchase, store and read books on your tablet. Tap the **LumiRead** shortcut in the Application menu, or the eReading content folder, to open the LumiRead application.

The bookshelves

All the books available on your tablet are shown on the bookshelves.



If you have many books swipe the screen up or down to display more titles.





Note: To add books to the bookshelves, see **"Adding books to your tablet"** on page 49.



Tool bar

The tool bar is at the top of the screen.



This area displays icons that allow you to look for new books or change how books are displayed.

Icon	Item	Description
	Shopping cart	Opens the Bookstore page, where you can choose where to purchase books.
	Search	Searches the Internet or your books for text.
	Sort by	Changes how books are organized on the bookshelves.

Icon	Item	Description
	Display	Changes how the books are shown.
	Settings	Opens settings to manage folders, register an Adobe ID, change the theme or edit tags.

Recently read

The first shelf (at the top) displays books you have recently read. This list will change to reflect your activity.

Favorites / tags

As you add books to your tablet, you may find it difficult to find the book you need. You may either search for a specific title or author, add books to your **Favorites**, or choose only to display books with a certain tag, to reduce the number of books displayed at one time.

Normally **All** books are displayed, but you can select a tag (All, Favorites, PDF or a tag you have created). While a tag is selected, only books with that tag will be displayed.

Tap **(+)** create new tags, or tap the **Settings** icon and select **Tags** to create, rename or delete tags.

Adding a tag

To add a tag, tap and hold a book, then drag it to one of the tags shown at the top of the screen. Drag the book to the **(+)** to create a new tag.

Removing a tag

To remove a tag from a book, tap the name of the tag at the top of the screen, so that only books with that tag are displayed. Tap and hold the book, then drag it to the remove tag icon.

Dictionary

The Dictionary allows you to check the definitions of words. Open the dictionary and type the word you want to check, then tap **Search Dictionary**.

Note: Internet access is required to search the dictionary as definitions are retrieved from the Google dictionary service.

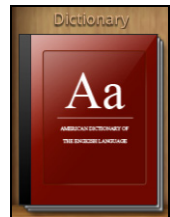

Reading eBooks on your tablet

Your tablet is able to display ePub and pdf books. Most eBook sites provide files in these formats.



.....
Warning: Certain vendors may use copyright protection systems that cannot be opened by your tablet. Please check which DRM (Digital Rights

Management) system is used.
LumiRead supports books protected with Adobe ID.

In order to read certain books, you must activate your tablet with an Adobe ID.
See “Your Adobe ID” on page 51.

Opening a book

All books stored on your tablet may be seen on the shelves on the main screen.
If you have many books, swipe the bookshelves up to see them.

Simply tap a book to open it. Rotate your tablet to the best angle to read the book.

Reading a book

Simply swipe across a page to change the page. More options, such as searching the book, changing text size or marking sections for future reference (*Bookmarks* or *Highlights*) are available: either tap the page or the settings icon.

Highlighting text and adding a note

Quickly tap twice on a word to highlight it, then tap a second word to highlight a section of text between the selected words. Tap the **Highlight** icon and add a note if desired; tap **Save** to highlight the selected section.



Note: You can also tap twice on a word to search for it in the dictionary, or on the Internet.

Jumping to Contents, Bookmarks or Highlights

You may jump directly selected sections in a book; tap the page or the settings icon, and select **Contents**. Select **Contents**, **Bookmarks** or **Highlights**, then tap on an entry to jump directly to that item in the book.

Taking a snapshot

You can take a ‘snapshot’ of a page and save it as an image for future reference. Tap the settings icon at the bottom of the screen and select **Snapshot**. An image of the page will be saved to the **LumiBooks/clipbook** folder in your tablet’s internal memory.



Adding books to your tablet

You may either add books that you already own, or download new books directly to your tablet.

Books you download (see “Shopping” on page 50) will be automatically added to the bookshelves.

To add books to your tablet’s internal memory or to a microSD card, copy the books to the LumiBooks folder, see “**Transferring files between a microSD card**”

and your PC" on page 22 or "Connecting to a PC as a USB storage device" on page 22.



Note: Connect your tablet to a computer and add books to the *LumiBooks* folder on your tablet's internal memory or microSD card to see them on the LumiRead bookshelves.

Instead of using the LumiBooks folder, you may add your own book folders, and have any contents displayed on the Lumiread bookshelves.

Tap the settings icon and select **Manage my book** folders. You will see a list of folders that are displayed in on the bookshelves.



Note: Folders that begin /mnt/sdcard/ are on your tablet's internal memory. Folders that begin /mnt/external_sd/ are on the microSD card.

Tap **Add Book Folder**, look for the folder in the list and tap the circle on the right to select it; tap on a folder name to see sub-folders. When you have selected all the folders you want to add, tap **Add**. After a short delay books in the selected folders will be added to the bookshelves.

To remove a folder, tap and hold the folder name in the Manage my book folders list, and select **Remove Book Folder**, then **Yes**.

Shopping

Tap the shopping cart and select your region to see a featured bookstore. On the right, additional bookstores are listed. Tap the plus sign add links to your favorite sites.

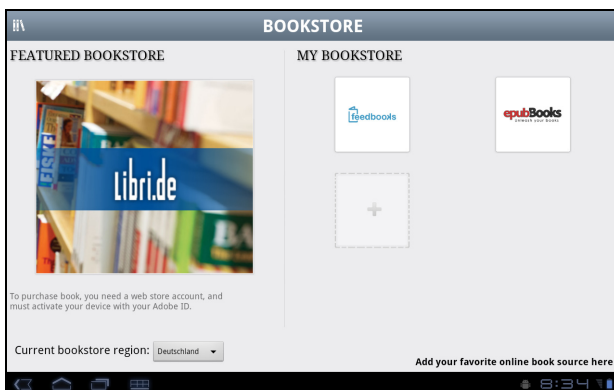

Note: You must create a customer account before purchasing items from the featured bookstore.

Your Adobe ID

Some books available for purchase are protected with Adobe DRM (Digital Rights Management). Before you can read them, you must enter an Adobe ID to activate your tablet. Only one activation is required, as it covers all purchases. If you already have an Adobe ID, you may use this to activate your tablet.

To create an Adobe ID:

1. Open **LumiRead**.
2. Tap the **Settings** button.
3. Tap **Register Adobe ID**.
4. Tap **Create an Adobe Account**.
5. Enter the information requested to create login information for your account.



.....
Note: The email address you enter will be your Adobe ID. Make sure you remember your password.
.....

6. Select **Continue**.

Your Adobe ID is now registered.

Entering your Adobe ID

To register your tablet, follow these steps:

1. Open **LumiRead**.
2. Tap the **Settings** button
3. Select **Device activation**.

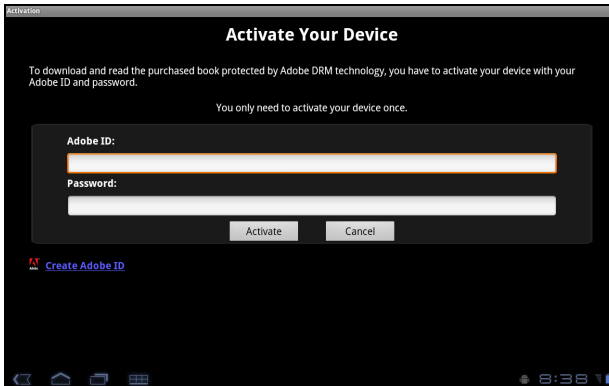

4. Enter the email address and password used to create your Adobe ID.
5. Finally tap **Activate**.

You may now read books protected with Adobe DRM.

Advanced settings

Access Settings from the Application menu. Tap **Apps**, then **Settings**.

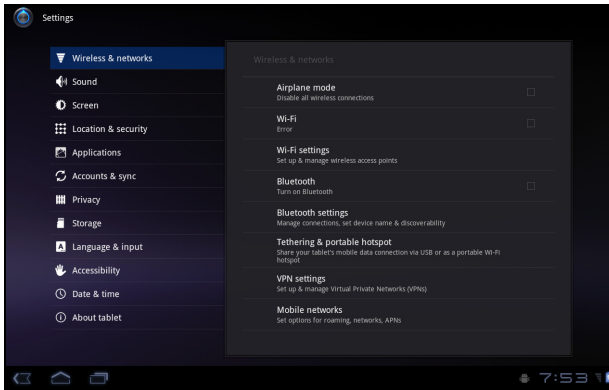

Sound

Adjust the volume of your tablet using the volume buttons on the side of the tablet. Alternatively, you can adjust your tablet sound settings by tapping **Apps > Settings > Sound**.

Item	Description
Vibrate	Sets vibration options.
Volume	Sets volume for Media, Alarm, and Notifications.
Notification ringtone	Sets a ringtone for Notifications.
Audible selection	Plays a sound whenever a screen selection is made.
Screen lock sounds	Plays a sound when locking and unlocking the screen.
Haptic feedback	Vibrates when pressing soft keys and on certain UI interactions.

Screen

You can adjust your tablet screen settings by tapping **Apps > Settings > Screen**.

Item	Description
Brightness	Adjusts screen brightness.
Animation	Enables window animations.
Timeout	Sets a delay before the screen will be turned off.

Putting your tablet in Airplane mode

You can enter Airplane mode (also known as flight mode) to turn off network and Bluetooth functions and use your tablet during a flight. Check with your airline to make sure this is permitted onboard.

Switch your tablet off during takeoff and landing as it may interfere with aircraft electronic systems.



Note: When Airplane mode is active, the  icon is displayed in the status area.

Turn Airplane mode on or off by tapping **Settings > Wireless & Networks > Airplane mode**.

Activating or deactivating connections

Open the Application menu and tap **Apps > Settings > Wireless & networks** to manage your connection settings. Each connection will have a green check when turned on.

Alternatively, you can tap on the right side of the status bar to manage connection settings.

Adjusting connection settings

This section will show you how to adjust detailed settings for your data, Wi-Fi and Bluetooth connections.

Item	Description
Airplane mode	Disables all wireless connections so you can safely use this device onboard an aircraft.
Wi-Fi	Turns the Wi-Fi function on or off.
Wi-Fi settings	Sets up and manages your wireless access points.
Bluetooth	Turns the Bluetooth function on or off.
Bluetooth settings	Manages your Bluetooth connections, sets a device name and discoverability.
VPN settings	Sets up and manages Virtual Private Networks.
Mobile networks	Sets your options for connecting to mobile networks.

Adjusting Bluetooth settings

You can use Bluetooth to exchange information between your tablet and other mobile devices.

Bluetooth connections

For all Bluetooth settings, tap **Apps > Settings > Wireless & networks > Bluetooth settings**. Here you can switch Bluetooth on or off, set a device name and discoverability. Tap **Find nearby devices** to scan for available devices.

To connect to a device, tap the device in the list of available devices. You may be asked to enter a PIN on both devices to establish the connection.



.....
Note: Only A2DP stereo headsets (without microphone) are supported.
Please check for updates to the tablet's software which may add support for additional Bluetooth devices.
.....

Connecting to a PC

If you wish to transfer information between your tablet and your computer, you can connect your tablet to a PC using the supplied USB cable. Plug the USB sync cable into the micro USB port on your tablet. Plug the USB client connector into an available USB port on your computer.



.....
Note: You may need to install drivers on your computer before your tablet can be used with your computer.
.....

You will now be able to see your tablet's internal memory as a drive in your computer's file explorer.

Synchronization

You can configure synchronization options for many applications on your tablet. You can also configure what types of data you synchronize for each account.

Some applications, such as Contacts, Gmail, and Calendar, can sync data from multiple accounts. Others sync data only from the first Google Account you sign in to on your tablet, or from an account associated specifically with that application.

For some applications, such as Contacts or Calendar, all changes that you make on your tablet are made to the synchronised copy on the Internet. Other applications only copy information from account on the Internet; the information on your tablet cannot be changed directly, you must change the information stored in the Internet account.

Tap **Apps > Settings > Accounts & sync** to access the synchronization settings.

To manage synchronization of individual accounts, tap an account name.

Some applications, such as Gmail and Calendar, have their own synchronization settings. Open the application and tap the *Menu* button (four bars) and then tap **Accounts**.



Auto-sync

To have your tablet auto-sync, make sure **Background data** and **Auto-sync** are enabled.

- If *Background data* is enabled, applications can transmit and receive data when you are not using them.

- If *Auto-sync* is enabled, all changes are automatically transferred between your tablet and Internet accounts.

Acer Sync

Acer Sync allows you to easily synchronize your contacts, calendar, photos and videos between your tablet, PC and corresponding Google services. You must install the Acer Sync program on your computer; download and install Acer Sync and Acer PIM for the PC from the www.acer.com website.

Multiple Google accounts

If you have multiple Google accounts, such as separate accounts for personal and business contacts, you can access and synchronize them from the Accounts settings section. Tap **Apps > Settings > Accounts & sync**. Tap **Add account** in the top-right corner and select **Google**.

Setting the date and time

To set the date and time, tap **Apps > Settings > Date & time**.



.....
Tip: If you travel frequently or live in an area that uses daylight saving time, and have mobile network access, activate **Automatic date & time** from this menu. Your tablet will set the date and time based on information it receives from the network.
.....

Setting alarms

There are two predefined alarms on your tablet by default. To add or edit alarm settings, tap **Clock** in the application menu and tap **Set alarm**.

Tap **Add alarm** to create a new alarm, or tap the check box next to a preset alarm to turn it on or off.

Tap a preset alarm to edit it. You can:

- Turn the alarm on or off.
- Set the alarm time.
- Set which days to repeat the alarm.
- Set a ringtone.
- Enable or disable vibrate.
- Give it a label (i.e., a name).

Changing language and text options

Set your location and language input preferences by opening the application menu and going to **Apps > Settings > Language & input**.

Managing applications

You can allow programs from **Unknown sources** to be installed and **Manage applications**.

Closing an application

To close an active application, go to **Settings > Applications > Manage applications**. Tap the **Running** tab, then tap the program you wish to close. Select **Force stop** to close the program.

Uninstalling an application

You can remove programs installed on your tablet to free up extra storage memory. Tap and hold a program icon from the application menu and drag it into the **Uninstall** area in the top-right corner.



.....
Note: You cannot uninstall applications that were pre-loaded on your tablet.
.....

Alternatively, you can go to **Apps > Settings** and select **Applications > Manage applications**. Tap the application you wish to uninstall, tap **Uninstall** and confirm the uninstall.



.....
Warning! You should only remove programs if you are familiar with the Android operating system.
.....

Updating your tablet's operating system

Your tablet can download and install system updates, adding support for new devices or expanding software options.

To check for updates, tap **Apps > Settings > About tablet > System update > Check now**.



.....
Note: Downloading new firmware can take up to 40 minutes, depending on your network speed.
.....

Resetting your tablet

You may have to perform a reset if your tablet fails to respond when buttons are pressed or the screen is tapped.

To reset your tablet use a small thin object (such as a paperclip) to press the recessed reset button.

Clean boot

A clean boot will restore your tablet to the factory settings.



.....
Warning! This will erase all your personal information, any contacts stored on your tablet and any programs you installed.
.....

Open **Settings** from the application menu, then tap **Privacy > Factory data reset**; click **Reset tablet** and then **Erase everything** to format your tablet.

If your tablet still does not respond, refer to “FAQ and troubleshooting” on page 58.

FAQ and troubleshooting

Installing a SIM card

Certain tablets include a SIM slot for Internet access. To take full advantage of your tablet's Internet capabilities, you should install a SIM card with data subscription *before* turning on your tablet.

1. Turn off the tablet by pressing and holding the power button.
2. Insert the SIM card as shown.

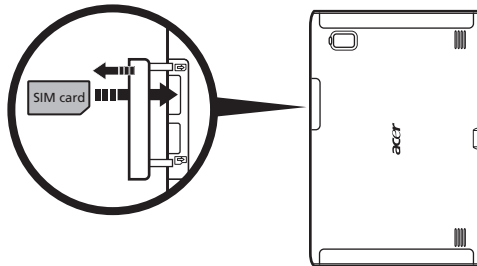

3. Replace the card slot cover.



.....
Note: Ensure that the SIM card is inserted all the way into the card slot.
.....



.....
Caution: Turn off your tablet before installing or removing a SIM card. You may damage the card or your tablet if power is still on.
.....

SIM card lock

Your tablet may come with a SIM card lock, i.e., you will only be able to use the SIM card provided by your network operator.

To cancel the SIM lock, contact your network provider.



.....
Note: If you need to turn the 3G network on or off see "Putting your tablet in Airplane mode" on page 54 and "Activating or deactivating connections" on page 54.
.....

Troubleshooting

This section lists frequently asked questions that may arise during the use of your tablet, and gives easy answers and solutions to these questions.

Aspect	Question	Answer
SIM card lock	Why can't I use a different SIM card?	Your tablet may come with a SIM card lock, i.e., you will only be able to use the SIM card provided by your network operator. To cancel the SIM lock, contact your network provider.
Audio	Why is there no sound coming from the device?	If the headset is plugged into the device, the speaker is automatically shut off. Disconnect the headset. Check that the device volume setting is not muted. Check that the volume control is not at its lowest setting.
Multimedia files	Why can't I view my picture files?	You may be trying to view an image that is not supported. Refer to "Multimedia" on page 62 for more information.
	Why can't I view my video files?	You may be trying to view a video that is not supported. Refer to "Multimedia" on page 62 for more information.
	Why can't I play my music files?	You may be trying to play a file that is not supported. Refer to "Multimedia" on page 62 for more information.
System information and performance	How do I check the OS version of my device?	Tap Apps > Settings > About tablet to check the OS version (Kernel/build number) and other hardware and software information.
Power	I couldn't turn on the device.	The battery power may be depleted. Recharge the device. Refer to "Charging your tablet" on page 9 for more information.
Storage	How do I check memory status?	To check storage status, go to Settings > Storage .

Aspect	Question	Answer
Unlock pattern	I forgot my unlock pattern.	<p>After a certain number of wrong entries, you will be presented with an option to reset your pattern. Tap Forgot pattern? and enter your Google account username and password.</p> <p>ⓘ Note: You must have an active Google account on the tablet. </p> <p>Alternatively, you can clean boot the tablet and erase all data. See “Clean boot” on page 56.</p>
Heat	The tablet heats up when charging or operating for a long period.	<p>It is normal for the device to heat up when charging. When charging is complete, it will return to its normal temperature.</p> <p>It is also normal for the tablet to heat up during long periods of use, such as watching a video or playing a game.</p> <p>All Acer tablets are factory-tested before release.</p>

Other sources of help

For information on:	Refer to:
Up-to-date information regarding your tablet	www.acer.com
Service enquiries	support.acer.com
AT&T support	www.att.com/esupport
AT&T 4G access	www.att.com/network
AT&T Wi-Fi Basic	www.attwifi.com

Legal notices

AT&T Mobile Broadband Network

The AT&T 4G broadband network (HSPA+ with enhanced backhaul) is available in limited areas. Availability is increasing with ongoing backhaul deployment.

ⓘ
Note: 4G speeds delivered by HSPA+ with enhanced backhaul. Not available everywhere. Deployment ongoing. Compatible data plan required. Learn more at att.com/network.
.....

Trademarks

Music recognition technology and related data are provided by Gracenote®. Gracenote®, Gracenote logo and logotype, and the "Powered by Gracenote" logo are either a registered trademark or a trademark of Gracenote, Inc. in the United States and/or other countries.

 XT9 and the XT9 logo are registered trademarks of Nuance Communications, Inc. or its subsidiaries in the United States of America and/or other countries.

AT&T and the AT&T logo are trademarks of AT&T Intellectual Property and/or AT&T affiliated companies. All other marks contained herein are the property of their respective owners.

Specifications

Performance

- NVIDIA® Tegra™ 2 mobile processor
 - Dual-Core ARM® Cortex™-A9
- System memory:
 - 1 GB of RAM
 - 16, 32 or 64 GB of flash memory
- Android™ operating system

Display

- 10.1" WXGA TFT-LCD capacitive multi-touch screen
- 1280 x 800 resolution
- 262K color support

Multimedia

- HDMI Micro (Type D) output
- CD-quality stereo output
- Stereo speakers
- Dual microphone with noise and echo cancellation
- Dolby Mobile

Formats supported:

Type	Formats
Audio recording	AAC-LC, AMR-WB
Audio playback	AAC-LC, AAC, AAC+ (not raw AAC), AMR-NB, AMR-WB, MP3, OGG Vorbis, WAV
Video recording	H.264 BP, MPEG-4 SP, H.263
Video playback	H.264 BP, H.264 MP, H.264 HP, MPEG-4 SP, H.263

USB ports

- USB port (host)
- Micro USB port (slave)

Power

- DC power-in (12 V, 1.5 A)

Connectivity

- Bluetooth 2.1+EDR & A2DP support
- Wi-Fi 802.11b/g/n WLAN (802.11n -> 2.4 GHz only)
- GPS
- aGPS
- GSM 850 / 900 / 1800 / 1900

- UMTS 850 / 900* / 1900 / 2100*
- HSDPA 7.2 Mbps / HSUPA 5.76 Mbps / EDGE / GPRS
- Optional HSDPA 21 Mbps

* not available on AT&T networks

Camera

- Front camera
 - 2-megapixel
 - Fixed focus
- Rear camera
 - 5-megapixel
 - Flash
 - Auto focus

Expansion

- microSD memory card slot (up to 32 GB)

Battery

- Rechargeable high density Li-polymer batteries: 3260 mAh x 2 (24.1 Wh)



.....
Note: Length of battery operation will depend on power consumption which is based on system resource use. For example, constantly using the backlight or using power-demanding applications will shorten battery life between charges.

Dimensions

Height	260 mm
Width	177 mm
Thickness	13.3 mm
Weight (Wi-Fi only model)	765 g
Weight (4G model)	777 g

Environment

Temperature

Operating: 0 °C to 45 °C

Non-operating: -20 °C to 60 °C

Humidity (non-condensing)

Operating: 20% to 80%

Non-operating: 20% to 80%

End user license agreement

IMPORTANT - READ CAREFULLY: THIS END USER LICENSE AGREEMENT ("AGREEMENT") IS A LEGAL AGREEMENT BETWEEN YOU (EITHER AN INDIVIDUAL OR A SINGLE ENTITY), AND ACER INC. INCLUDING ITS SUBSIDIARIES ("ACER") FOR THE SOFTWARE (WHETHER PROVIDED BY ACER OR BY ACER'S LICENSORS OR SUPPLIERS) THAT ACCOMPANIES THIS AGREEMENT, INCLUDING ANY ASSOCIATED MEDIA, PRINTED MATERIALS AND RELATED USER ELECTRONIC DOCUMENTATION WHICH MAY BE BRANDED "ACER", "GATEWAY", "PACKARD BELL", OR "EMACHINES" ("SOFTWARE"). AGREEMENTS RELATING TO ANY OTHER PRODUCT OR TOPIC ARE NEITHER INTENDED NOR SHOULD THEY BE IMPLIED. BY INSTALLING THE ACCOMPANYING SOFTWARE OR ANY PORTION THEREOF, YOU AGREE TO BE BOUND BY THE TERMS AND CONDITIONS OF THIS AGREEMENT. IF YOU DO NOT AGREE TO ALL OF THE TERMS AND CONDITIONS OF THIS AGREEMENT, DO NOT CONTINUE THE INSTALLATION PROCESS AND IMMEDIATELY DELETE ALL INSTALLED FILES, IF ANY, OF THE ACCOMPANYING SOFTWARE FROM YOUR DEVICE.

IF YOU DO NOT HAVE A VALIDLY-LICENSED COPY OF THE APPLICABLE SOFTWARE, YOU ARE NOT AUTHORIZED TO INSTALL, COPY OR OTHERWISE USE THE SOFTWARE, AND HAVE NO RIGHTS UNDER THIS AGREEMENT.

The Software is protected by U.S. and international copyright laws and conventions as well as other intellectual property laws and treaties. The Software is licensed, not sold.

GRANT OF LICENSE

Acer grants to you the following non-exclusive and non-transferable rights with respect to the Software. Under this Agreement, you may:

1. Install and use the Software only on a single designated device. A separate license is required for each device on which the Software will be used;
2. Make one copy of the Software solely for backup or archival purposes;
3. Make one hard copy of any electronic documents included in the Software, provided that you receive the documents electronically.

RESTRICTIONS

You may NOT:

1. Use or copy the Software except as provided in this Agreement;
2. Rent or lease the Software to any third party;
3. Modify, adapt, or translate the Software in whole or in part;
4. Reverse engineer, decompile, or disassemble the Software or create derivative works based upon the Software;
5. Merge the Software with any other program or modify the Software, except for your personal use; and
6. Sublicense or otherwise make the Software available to third parties, except that you may, after prior written notification to Acer, transfer the Software as a whole to a third party so long as you do not retain any copies of the Software and such third party accepts the terms of this Agreement.
7. Transfer your rights under this Agreement to any third parties.
8. Export the Software in contravention of applicable export laws and regulations, or (i) sell, export, re-export, transfer, divert, disclose technical data, or dispose of, any Software to any prohibited person, entity, or destination including, without limitation, Cuba, Iran, North Korea, Sudan and Syria; or (ii) use any Software for any use prohibited by the laws or regulations of the United States.

SUPPORT SERVICES

Acer is not obligated to provide technical or other support for the Software.

ACER LIVE UPDATE

Certain software contains elements that enable the use of the Acer Live Update service, which allows for updates for such software to be automatically downloaded and installed on your device. By installing the software, you hereby agree and consent that Acer (or its licensors) may automatically check the version of such software that you are using on your device and may provide upgrades to such software that may be automatically downloaded on to your device.

OWNERSHIP AND COPYRIGHT

Title, ownership rights and intellectual property rights in and to the Software and all copies thereof shall remain with Acer or Acer's licensors or suppliers (as applicable). You do not have or shall not gain any proprietary interest in the Software (including any modifications or copies made by or for you) or any related intellectual property rights. Title and related rights in the content accessed through the Software is the property of the applicable content owner and may be protected by applicable law. This license gives you no rights to such contents. You hereby agree

1. Not to remove any copyright or other proprietary notices from the Software;
2. To reproduce all such notices on any authorized copies you make; and
3. To use best efforts to prevent any unauthorized copying of the Software.

TRADEMARKS

This Agreement does not grant to you any rights in connection with any trademarks or service marks of Acer or of Acer's licensors or suppliers.

DISCLAIMER OF WARRANTIES

TO THE MAXIMUM EXTENT PERMITTED BY APPLICABLE LAW, ACER, ITS SUPPLIERS, AND ITS LICENSORS, PROVIDE THE SOFTWARE "AS IS" AND WITH ALL FAULTS, AND HEREBY DISCLAIM ALL OTHER WARRANTIES AND CONDITIONS, EITHER EXPRESS, IMPLIED OR STATUTORY, INCLUDING, BUT NOT LIMITED TO, ANY IMPLIED WARRANTIES, DUTIES OR CONDITIONS OF MERCHANTABILITY, OF FITNESS FOR A PARTICULAR PURPOSE, OF ACCURACY OR COMPLETENESS OF RESPONSES, OF RESULTS, OF WORKMANLIKE EFFORT, OF LACK OF VIRUSES, AND OF LACK OF NEGLIGENCE, ALL WITH REGARD TO THE SOFTWARE AND THE PROVISION OF OR FAILURE TO PROVIDE SUPPORT SERVICES. ALSO, THERE IS NO

WARRANTY OR CONDITION OF TITLE, QUIET ENJOYMENT, QUIET POSSESSION, CORRESPONDENCE TO DESCRIPTION OR NON-INFRINGEMENT WITH REGARD TO THE SOFTWARE.

EXCLUSION OF INCIDENTAL, CONSEQUENTIAL AND CERTAIN OTHER DAMAGES

TO THE MAXIMUM EXTENT PERMITTED BY APPLICABLE LAW, IN NO EVENT SHALL ACER, ACER'S SUPPLIERS, OR ACER'S LICENSORS, BE LIABLE FOR ANY SPECIAL, INCIDENTAL, INDIRECT, PUNITIVE, OR CONSEQUENTIAL DAMAGES WHATSOEVER (INCLUDING, BUT NOT LIMITED TO, DAMAGES FOR LOSS OF PROFITS OR CONFIDENTIAL OR OTHER INFORMATION, FOR BUSINESS INTERRUPTION, FOR PERSONAL INJURY, FOR LOSS OF PRIVACY, FOR FAILURE TO MEET ANY DUTY INCLUDING OF GOOD FAITH OR OF REASONABLE CARE, FOR NEGLIGENCE, AND FOR ANY OTHER PECUNIARY OR OTHER LOSS WHATSOEVER) ARISING OUT OF OR IN ANY WAY RELATED TO THE USE OF OR INABILITY TO USE THE SOFTWARE, THE PROVISION OF OR FAILURE TO PROVIDE SUPPORT SERVICES, OR OTHERWISE UNDER OR IN CONNECTION WITH ANY PROVISION OF THIS AGREEMENT, EVEN IN THE EVENT OF THE FAULT, TORT (INCLUDING NEGLIGENCE), STRICT LIABILITY, BREACH OF CONTRACT OR BREACH OF WARRANTY OF ACER OR ITS SUPPLIERS OR LICENSORS, AND EVEN IF ACER AND ITS SUPPLIERS AND LICENSORS HAVE BEEN ADVISED OF THE POSSIBILITY OF SUCH DAMAGES.

LIMITATION OF LIABILITY AND REMEDIES

NOTWITHSTANDING ANY DAMAGES THAT YOU MIGHT INCUR FOR ANY REASON WHATSOEVER (INCLUDING, WITHOUT LIMITATION, ALL DAMAGES REFERENCED ABOVE AND ALL DIRECT OR GENERAL DAMAGES), THE ENTIRE LIABILITY OF ACER, ITS SUPPLIERS, AND ITS LICENSORS, UNDER ANY PROVISION OF THIS AGREEMENT, AND YOUR EXCLUSIVE REMEDY FOR ALL OF THE FOREGOING, SHALL BE LIMITED TO THE AGGREGATE AMOUNT PAID BY YOU FOR THE SOFTWARE. THE FOREGOING LIMITATIONS, EXCLUSIONS AND DISCLAIMERS (INCLUDING DISCLAIMER OF WARRANTIES AND EXCLUSION OF INCIDENTAL, CONSEQUENTIAL AND CERTAIN OTHER DAMAGES ABOVE) SHALL APPLY TO THE MAXIMUM EXTENT PERMITTED BY APPLICABLE LAW, EVEN IF ANY REMEDY FAILS ITS ESSENTIAL PURPOSE; PROVIDED, HOWEVER, THAT BECAUSE SOME JURISDICTIONS DO NOT ALLOW THE EXCLUSION OR LIMITATION OR LIABILITY FOR CONSEQUENTIAL OR INCIDENTAL DAMAGES, THE ABOVE LIMITATION MAY NOT APPLY TO YOU.

TERMINATION

Without prejudice to any other rights, Acer may immediately terminate this Agreement without notice if you fail to comply with any terms and conditions of this Agreement.

In such event, you must:

1. Cease all use of the Software;
2. Destroy or return to Acer the original and all copies of the Software; and
3. Delete the Software from all devices on which it was resident.

All disclaimers of warranties and limitation of liability set forth in this Agreement shall survive termination of this Agreement.

GENERAL

This Agreement represents the complete agreement between you and Acer relating to this license for the Software and supersedes all prior agreements, communications, proposals and representations between the parties and prevails over any conflicting or additional terms of any quote, order, acknowledgement or similar communication. This Agreement may only be modified by a written document signed by both parties. If any provision of this Agreement is held by a court of competent jurisdiction to be contrary to law that provision will be enforced to the maximum extent permissible and the remaining provisions of this Agreement will remain in full force and effect.

ADDITIONAL PROVISIONS APPLICABLE TO THIRD PARTY SOFTWARE AND SERVICES

Software provided hereunder by Acer's licensors or suppliers ("Third Party Software") is made available to you for your personal, non-commercial use only. You may not use the Third Party Software in any manner that could damage, disable, overburden, or impair the services provided by Acer's licensors or suppliers hereunder ("Third Party Services"). Furthermore, you may not use the Third Party Software in any manner that could interfere with any other party's use and enjoyment of the Third Party Services, or the services and products of Acer's licensors' or suppliers' third party licensors. Your use of the Third Party Software and Third Party Services is also subject to additional terms and conditions and policies which can be accessed through our global website.

Privacy policy

During registration you will be asked to submit some information to Acer. Please refer to Acer's privacy policy at www.acer.com/worldwide/support/swa.htm or your local Acer website.

Free Manuals Download Website

<http://myh66.com>

<http://usermanuals.us>

<http://www.somanuals.com>

<http://www.4manuals.cc>

<http://www.manual-lib.com>

<http://www.404manual.com>

<http://www.luxmanual.com>

<http://aubethermostatmanual.com>

Golf course search by state

<http://golfingnear.com>

Email search by domain

<http://emailbydomain.com>

Auto manuals search

<http://auto.somanuals.com>

TV manuals search

<http://tv.somanuals.com>